

# Owner's Manual & Safety Instructions

**Save This Manual** Keep this manual for the safety warnings and precautions, assembly, operating, inspection, maintenance and cleaning procedures. Write the product's serial number in the back of the manual near the assembly diagram (or month and year of purchase if product has no number). Keep this manual and the receipt in a safe and dry place for future reference.

**CHICAGO  ELECTRIC**  
POWER TOOLS

**ITEM 68853**

## 18 VOLT CORDLESS **IMPACT DRIVER**



Visit our website at: <http://www.harborfreight.com>  
Email our technical support at: [tech@harborfreight.com](mailto:tech@harborfreight.com)

REV 12a

When unpacking, make sure that the product is intact and undamaged. If any parts are missing or broken, please call 1-800-444-3353 as soon as possible.

Copyright© 2011 by Harbor Freight Tools®. All rights reserved.  
No portion of this manual or any artwork contained herein may be reproduced in any shape or form without the express written consent of Harbor Freight Tools. Diagrams within this manual may not be drawn proportionally. Due to continuing improvements, actual product may differ slightly from the product described herein. Tools required for assembly and service may not be included.

### **WARNING**





**Read this material before using this product.  
Failure to do so can result in serious injury.  
SAVE THIS MANUAL.**

# Table of Contents

Safety .....	2	Maintenance .....	10
Specifications .....	7	Parts List and Diagram .....	11
Setup .....	7	Warranty .....	12
Operation.....	8		

# CHICAGO ELECTRIC<sup>®</sup> POWER TOOLS

## WARNING SYMBOLS AND DEFINITIONS

	This is the safety alert symbol. It is used to alert you to potential personal injury hazards. Obey all safety messages that follow this symbol to avoid possible injury or death.
	Indicates a hazardous situation which, if not avoided, will result in death or serious injury.
	Indicates a hazardous situation which, if not avoided, could result in death or serious injury.
	Indicates a hazardous situation which, if not avoided, could result in minor or moderate injury.
	Addresses practices not related to personal injury.

## IMPORTANT SAFETY INFORMATION

### GENERAL POWER TOOL SAFETY WARNINGS

#### WARNING

**Read all safety warnings and instructions.**

*Failure to follow the warnings and instructions may result in electric shock, fire and/or serious injury.*

**Save all warnings and instructions for future reference.**

*The term "power tool" in the warnings refers to your battery-operated (cordless) power tool.*

### Work area safety

- 1. Keep work area clean and well lit.**  
*Cluttered or dark areas invite accidents.*
- 2. Do not operate power tools in explosive atmospheres, such as in the presence of flammable liquids, gases or dust.** *Power tools create sparks which may ignite the dust or fumes.*
- 3. Keep children and bystanders away while operating a power tool.**  
*Distractions can cause you to lose control.*

### Electrical safety

**Do not expose power tools to rain or wet conditions.**

*Water entering a power tool will increase the risk of electric shock.*

## Personal safety

---

- 1. Stay alert, watch what you are doing and use common sense when operating a power tool. Do not use a power tool while you are tired or under the influence of drugs, alcohol or medication.** *A moment of inattention while operating power tools may result in serious personal injury.*
- 2. Use personal protective equipment. Always wear eye protection.** *Safety equipment such as dust mask, non-skid safety shoes, hard hat, or hearing protection used for appropriate conditions will reduce personal injuries.*
- 3. Prevent unintentional starting. Ensure the switch is in the off-position before connecting the battery pack, picking up or carrying the tool.** *Carrying power tools with your finger on the switch or energizing power tools that have the switch on invites accidents.*
- 4. Remove any adjusting key or wrench before turning the power tool on.** *A wrench or a key left attached to a rotating part of the power tool may result in personal injury.*
- 5. Do not overreach. Keep proper footing and balance at all times.** *This enables better control of the power tool in unexpected situations.*
- 6. Dress properly. Do not wear loose clothing or jewelry. Keep your hair, clothing and gloves away from moving parts.** *Loose clothes, jewelry or long hair can be caught in moving parts.*
- 7. Only use safety equipment that has been approved by an appropriate standards agency.** *Unapproved safety equipment may not provide adequate protection. Eye protection must be ANSI-approved and breathing protection must be NIOSH-approved for the specific hazards in the work area.*

## Power tool use and care

---

- 1. Do not force the power tool. Use the correct power tool for your application.** *The correct power tool will do the job better and safer at the rate for which it was designed.*
- 2. Do not use the power tool if the switch does not turn it on and off.** *Any power tool that cannot be controlled with the switch is dangerous and must be repaired.*
- 3. Disconnect the battery pack from the power tool before making any adjustments, changing accessories, or storing power tools.** *Such preventive safety measures reduce the risk of starting the power tool accidentally.*
- 4. Store idle power tools out of the reach of children and do not allow persons unfamiliar with the power tool or these instructions to operate the power tool.** *Power tools are dangerous in the hands of untrained users.*
- 5. Maintain power tools. Check for misalignment or binding of moving parts, breakage of parts and any other condition that may affect the power tool's operation. If damaged, have the power tool repaired before use.** *Many accidents are caused by poorly maintained power tools.*
- 6. Keep cutting tools sharp and clean.** *Properly maintained cutting tools with sharp cutting edges are less likely to bind and are easier to control.*
- 7. Use the power tool, accessories and tool bits etc. in accordance with these instructions, taking into account the working conditions and the work to be performed.** *Use of the power tool for operations different from those intended could result in a hazardous situation.*



## Battery tool use and care

1. **Recharge only with the charger specified by the manufacturer.** *A charger that is suitable for one type of battery pack may create a risk of fire when used with another battery pack.*
2. **Use power tools only with specifically designated battery packs.** *Use of any other battery packs may create a risk of injury and fire.*
3. **When battery pack is not in use, keep it away from other metal objects, like paper clips, coins, keys, nails, screws or other small metal objects, that can make a connection from one terminal to another.** *Shorting the battery terminals together may cause burns or a fire.*
4. **Under abusive conditions, liquid may be ejected from the battery; avoid contact. If contact accidentally occurs, flush with water. If liquid contacts eyes, additionally seek medical help.** *Liquid ejected from the battery may cause irritation or burns.*

## Service

**Have your power tool serviced by a qualified repair person using only identical replacement parts.**  
*This will ensure that the safety of the power tool is maintained.*

## Impact Driver Safety Warnings

1. **Hold power tools by insulated gripping surfaces when performing an operation where the cutting tool may contact hidden wiring.** *Contact with a "live" wire will make exposed metal parts of the tool "live" and shock the operator.*
2. The amount of actual torque may vary depending on the cleanness and condition of the threads and other factors. If tightening critical components, check the actual torque applied to the fastener with a mechanical torque wrench (not supplied).
3. Maintain labels and nameplates on the tool. These carry important safety information. If unreadable or missing, contact Harbor Freight Tools for a replacement.
4. Avoid unintentional starting. Prepare to begin work before turning on the tool.
5. Do not lay the tool down until it has come to a complete stop. Moving parts can grab the surface and pull the tool out of your control.
6. When using a handheld power tool, maintain a firm grip on the tool with both hands to resist starting torque.
7. Do not leave the tool unattended when the Battery Pack is connected. Turn off the tool, and remove the Battery Pack before leaving.
8.  The battery Charger gets hot during use. The Charger's heat can build up to unsafe levels and create a fire hazard if it does not receive adequate ventilation, due to an electrical fault, or if it is used in a hot environment. Do not place the Charger on a flammable surface. Do not obstruct any vents on the Charger. **Especially avoid placing the Charger on carpets and rugs; they are not only flammable, but they also obstruct vents under the Charger.** Place the Charger on a stable, solid, nonflammable surface (such as a stable metal workbench or concrete floor) at least 1 foot away from all flammable objects, such as drapes or walls. Keep a fire extinguisher and a smoke detector in the area. Frequently monitor the Charger and Battery Pack while charging.

9. This product is not a toy.  
Keep it out of reach of children.
10. People with pacemakers should consult their physician(s) before use. Electromagnetic fields in close proximity to heart pacemaker could cause pacemaker interference or pacemaker failure. In addition, people with pacemakers should:
  - Avoid operating alone.
  - Do not use with power switch locked on.
  - Properly maintain and inspect to avoid electrical shock.
11. **WARNING:** Some dust created by power sanding, sawing, grinding, drilling, and other construction activities, contains chemicals known [to the State of California] to cause cancer, birth defects or other reproductive harm. Some examples of these chemicals are:
  - Lead from lead-based paints
  - Crystalline silica from bricks and cement or other masonry products
  - Arsenic and chromium from

chemically treated lumber  
Your risk from these exposures varies, depending on how often you do this type of work. To reduce your exposure to these chemicals: work in a well ventilated area, and work with approved safety equipment, such as those dust masks that are specially designed to filter out microscopic particles.  
(California Health & Safety Code § 25249.5, *et seq.*)

12. **WARNING:** Handling the cord on this product's Charger will expose you to lead, a chemical known to the State of California to cause cancer, and birth defects or other reproductive harm. Wash hands after handling.  
(California Health & Safety Code § 25249.5, *et seq.*)
13. The warnings, precautions, and instructions discussed in this instruction manual cannot cover all possible conditions and situations that may occur. It must be understood by the operator that common sense and caution are factors which cannot be built into this product, but must be supplied by the operator.

## Vibration Safety

This tool vibrates during use. Repeated or long-term exposure to vibration may cause temporary or permanent physical injury, particularly to the hands, arms and shoulders. To reduce the risk of vibration-related injury:

1. Anyone using vibrating tools regularly or for an extended period should first be examined by a doctor and then have regular medical check-ups to ensure medical problems are not being caused or worsened from use. Pregnant women or people who have impaired blood circulation to the hand, past hand injuries, nervous system disorders, diabetes, or Raynaud's Disease should not use this tool. If you feel any symptoms related to vibration (such as tingling, numbness, and white or blue fingers), seek medical advice as soon as possible.
2. Do not smoke during use. Nicotine reduces the blood supply to the hands and fingers, increasing the risk of vibration-related injury.
3. Wear suitable gloves to reduce the vibration effects on the user.
4. Use tools with the lowest vibration when there is a choice.
5. Include vibration-free periods each day of work.
6. Grip tool as lightly as possible (while still keeping safe control of it). Let the tool do the work.
7. To reduce vibration, maintain the tool as explained in this manual. If any abnormal vibration occurs, stop use immediately.



**SAVE THESE INSTRUCTIONS.**

## Grounding

### ⚠️ WARNING



**TO PREVENT ELECTRIC SHOCK AND DEATH**

**FROM INCORRECT GROUNDING WIRE CONNECTION:**

Check with a qualified electrician if you are in doubt as to whether the outlet is properly grounded. Do not modify the power cord plug provided with the Charger. Do not use the Charger if the power cord or plug is damaged. If damaged, have it repaired by a service facility before use. If the plug will not fit the outlet, have a proper outlet installed by a qualified electrician.

## Double Insulated Tools: Tools with Two Prong Plugs

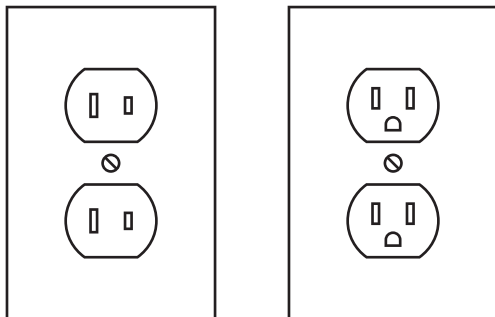







Outlets for 2-Prong Plug





1. Tools marked "Double Insulated" do not require grounding. They have a special double insulation system which satisfies OSHA requirements and complies with the applicable standards of Underwriters Laboratories, Inc., the Canadian Standard Association, and the National Electrical Code.
2. Double insulated tools may be used in either of the 120 volt outlets shown in the preceding illustration. (See Outlets for 2-Prong Plug.)

## Extension Cords

**Note:** Extension cords must not be used with this item's Charger.

## Symbology

	Double Insulated
	Canadian Standards Association
	Underwriters Laboratories, Inc.
	Volts Alternating Current
	Amperes
$n_0$ xxxx/min.	No Load Revolutions per Minute (RPM)
	WARNING marking concerning Risk of Eye Injury. Wear ANSI-approved safety goggles with side shields.

	Read the manual before set-up and/or use.
	WARNING marking concerning Risk of Hearing Loss. Wear hearing protection.
	WARNING marking concerning Risk of Fire. Do not cover Charger ventilation ducts. Charge on fireproof surface only.
	WARNING marking concerning Risk of Electric Shock. Properly connect Charger's power cord to appropriate outlet.
	WARNING marking concerning Risk of Explosion. Do not puncture, short, or open battery packs and do not charge damaged battery packs.

**CHICAGO  ELECTRIC®**  
**POWER TOOLS**

## Specifications

Charger	120V~, 60Hz Input 7.2-24VDC Output 1 Hour Charge Time ( <b>SKU 68859</b> , included)
Battery Type	18V, 1500mAh, NiCd ( <b>SKU 68860</b> , included)
Impacts	0-3000 BPM (Blows Per Minute)
Max. Torque	700 in-lb

## Setup - Before Use:



Read the **ENTIRE IMPORTANT SAFETY INFORMATION** section at the beginning of this manual including all text under subheadings therein before set up or use of this product.

**Note:** For additional information regarding the parts listed in the following pages, refer to *Parts List and Diagram* on page 11.

## Functions



## Charger Indicator LED's

**Green LED:** Continuously lit indicates charger is powered.

**Red LED:** Flashing indicates that the battery is charging. Continuously lit (not flashing) indicates that the battery has finished charging and should be removed from the charger.

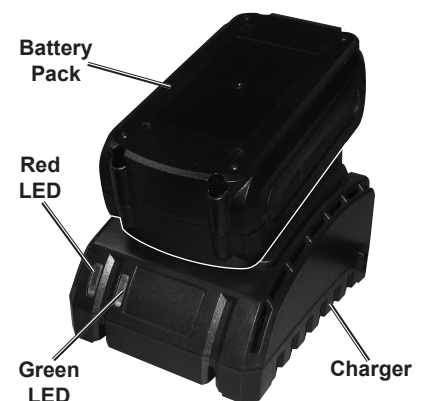

## Operating Instructions



Read the **ENTIRE IMPORTANT SAFETY INFORMATION** section at the beginning of this manual including all text under subheadings therein before set up or use of this product.

## Tool Set Up

### **⚠ WARNING**

**TO PREVENT SERIOUS INJURY FROM ACCIDENTAL OPERATION:**

**Release the Trigger and remove the Battery Pack before adjusting tool or installing accessories.**

**WARNING!** Do not install the Battery Pack until **AFTER** you complete the following steps to set up the tool for use.

**WARNING!** Only use 1/4" Hex Shank bits designed for impact use. Verify bit fits the screw/hex bolt precisely before use.

1. An additional bit may be stored in the Driver's Bit Groove during use.
2. To lock the trigger mechanism as a safety measure, slide the Direction Switch so that it is in the center position. This will prevent the driver turning on accidentally.

3. Pull Collar (11-1) forward, insert bit into Anvil and then release Collar. Pull on bit to ensure it is secure.
4. Insert the fully charged Battery Pack into the base of the Impact Driver, making sure that it clicks into place securely. Be sure the Battery Pack is securely seated into the Handle so it does not fall off during use.

**NOTICE:** Do not change direction of rotation while Anvil is rotating. Wait until Anvil has come to a complete stop before changing direction.

## Charging

1. Place the Battery Pack on a dry fireproof surface in a room where the temperature is from 50–104° F.

**Note:** If recharging a newly spent Battery Pack, allow it to cool completely before charging.

2. Examine the Battery Pack. It must be undamaged, and a NiCd type Battery Pack. **Do not charge a cracked, open, or leaking Battery Pack, or charge a non-recommended type of Battery Pack.**
3. The Battery Pack's terminals are designed to fit this Charger specifically. If the Battery Pack does to not fit the Charger properly, do not try to insert it. **Do not force a Battery Pack into the Charger.**
4. Plug the Power Supply into a grounded, 120V~, 60Hz receptacle.
5. Connect the Power Supply to the Charger. The **green** power LED will light, showing that power is supplied to the Charger.

6. Slide the Battery Pack into the charger until the button on the Battery Pack clicks into place. The Red LED will flash to show the Battery is charging and the Green LED will continue to stay lit.

**Note:** The Battery Pack's capacity will increase somewhat during the first few charging cycles. A fully discharged Battery Pack will take about 1 hour to fully charge. Recharging the Battery Pack for more than 1 hour can damage the battery cells.

7. While charging, the Battery Pack, Charger, and Power Supply may become warm to the touch. This is normal, and does not indicate a problem.
8. The red LED will light continuously when the Battery Pack is charged. Unplug the Charger and disconnect it from the Battery Pack when finished.
9. Allow the Battery Pack to cool completely before using it.
10. Press the Battery Button to release Battery Pack from the Charger.



## Work Piece and Work Area Set Up

---

1. Designate a work area that is clean and well-lit. The work area must not allow access by children or pets to prevent distraction and injury.
2. Secure loose work pieces using a vise or clamps (not included) to prevent movement while working.
3. There must not be objects, such as utility lines, nearby that will present a hazard while working.

## General Operating Instructions

---

1. Slide the Direction Switch (which should initially be centered in the “lock” position) to the right for forward drilling/fastening, or to the left for reversing the operation. Use the “reverse” setting only to remove screws or to release jammed drill bit.
2. The LED Work Light can be activated before the Driver runs by pressing the Trigger lightly. Then press the Trigger harder to activate the Impact Driver.
3. The Impact Driver has variable speed. To increase speed, apply more pressure to Trigger. To decrease speed, lessen pressure on Trigger.
4. When finished using the Impact Driver, release the Trigger and center the Direction Switch to lock the trigger mechanism as a safety measure.
5. Remove the Battery Pack.
6. Clean then store the Impact Driver indoors and out of children’s reach.

**CHICAGO  ELECTRIC®**  
**POWER TOOLS**

## Maintenance and Servicing



Procedures not specifically explained in this manual must be performed only by a qualified technician.

### **WARNING**

**TO PREVENT SERIOUS INJURY FROM ACCIDENTAL OPERATION:** Turn the Power Switch of the tool off and remove its Battery Pack before performing any inspection, maintenance, or cleaning procedures.

**TO PREVENT SERIOUS INJURY FROM TOOL FAILURE:** Do not use damaged equipment. If abnormal noise or vibration occurs, have the problem corrected before further use.

## Cleaning, Maintenance, and Lubrication

- BEFORE EACH USE**, inspect the general condition of the tool. Check for:
  - leaking, swollen, or cracked battery pack,
  - loose hardware,
  - misalignment or binding of moving parts,
  - cracked or broken parts, and
  - any other condition that may affect its safe operation.
- AFTER USE**, wipe external surfaces of the tool with clean cloth.
- NiCd BATTERY MUST BE RECYCLED OR DISPOSED OF PROPERLY. Do not short, incinerate or open Battery Pack.**
- Disconnect battery pack and store battery pack, charger, and tool in dry, indoor area out of reach of children and away from metal objects (i.e., paperclips, coins) to prevent shorting.

## Troubleshooting

Problem	Possible Causes	Likely Solutions
Tool will not start.	<ol style="list-style-type: none"><li>Battery Pack not properly connected.</li><li>Battery Pack not properly charged.</li><li>Battery Pack burnt-out.</li><li>Internal damage or wear.</li></ol>	<ol style="list-style-type: none"><li>Remove Battery Pack, make sure there are no obstructions, reinsert the Battery Pack according to its shape (it should only fit one way), and press firmly until the Battery Pack locks in place.</li><li>Make sure Charger is connected and operating properly. Give enough time for Battery Pack to recharge properly.</li><li>Dispose of old Battery Pack properly or recycle. Replace Battery Pack.</li><li>Have technician service tool.</li></ol>
Tool operates slowly.	<ol style="list-style-type: none"><li>Forcing tool to work too fast.</li><li>Battery Pack power low.</li><li>Battery Pack burnt-out.</li></ol>	<ol style="list-style-type: none"><li>Allow tool to work at its own rate.</li><li>Recharge Battery Pack.</li><li>Dispose of old Battery Pack properly or recycle. Replace Battery Pack.</li></ol>
Performance decreases over time.	<ol style="list-style-type: none"><li>Accessory dull or damaged.</li><li>Battery Pack wearing out.</li></ol>	<ol style="list-style-type: none"><li>Keep cutting accessories sharp. Replace as needed.</li><li>Battery Pack capacity will gradually decrease through use. If symptoms are severe, recycle old Battery Pack (or dispose of properly) and replace it.</li></ol>
Excessive noise or rattling.	Internal damage or wear. (Carbon brushes or bearings, for example.)	Have technician service tool.
Overheating.	<ol style="list-style-type: none"><li>Forcing tool to work too fast.</li><li>Accessory dull or damaged.</li><li>Blocked motor housing vents.</li></ol>	<ol style="list-style-type: none"><li>Allow tool to work at its own rate.</li><li>Keep cutting accessories sharp. Replace as needed.</li><li>Wear ANSI-approved safety goggles and NIOSH-approved dust mask/respirator while blowing dust out of motor using compressed air.</li></ol>



**Follow all safety precautions whenever diagnosing or servicing the tool. Disconnect Battery Pack and Charger power supply before service.**

## Parts List and Diagram

### PLEASE READ THE FOLLOWING CAREFULLY

THE MANUFACTURER AND/OR DISTRIBUTOR HAS PROVIDED THE PARTS LIST AND ASSEMBLY DIAGRAM IN THIS MANUAL AS A REFERENCE TOOL ONLY. NEITHER THE MANUFACTURER OR DISTRIBUTOR MAKES ANY REPRESENTATION OR WARRANTY OF ANY KIND TO THE BUYER THAT HE OR SHE IS QUALIFIED TO MAKE ANY REPAIRS TO THE PRODUCT, OR THAT HE OR SHE IS QUALIFIED TO REPLACE ANY PARTS OF THE PRODUCT. IN FACT, THE MANUFACTURER AND/OR DISTRIBUTOR EXPRESSLY STATES THAT ALL REPAIRS AND PARTS REPLACEMENTS SHOULD BE UNDERTAKEN BY CERTIFIED AND LICENSED TECHNICIANS, AND NOT BY THE BUYER. THE BUYER ASSUMES ALL RISK AND LIABILITY ARISING OUT OF HIS OR HER REPAIRS TO THE ORIGINAL PRODUCT OR REPLACEMENT PARTS THERETO, OR ARISING OUT OF HIS OR HER INSTALLATION OF REPLACEMENT PARTS THERETO.

Part	Description	Qty.
1	Rotor	1
2	Anvil	1
3	Housing	1
4	Trigger	1
5	Push Rod	1
6	Screw	13
7	Light Frame (7-1, 7-2, 7-3)	1
7-1	Light	1
7-2	Circuit Board	1
7-3	Resistor	1
8	Sleeve Housing	1
9	Sleeve Grip	1

Part	Description	Qty.
10	Shaft Sleeve	1
11	Quick Lock (11-1 thru 11-5)	1
11-1	Collar	1
11-2	Steel Ball	1
11-3	Spring	1
11-4	Washer	1
11-5	Clamp Spring	1
12	Washer	1
13	Gasket	1
14	Top Pin	1
15	Spring	1
16	Battery Pack	1

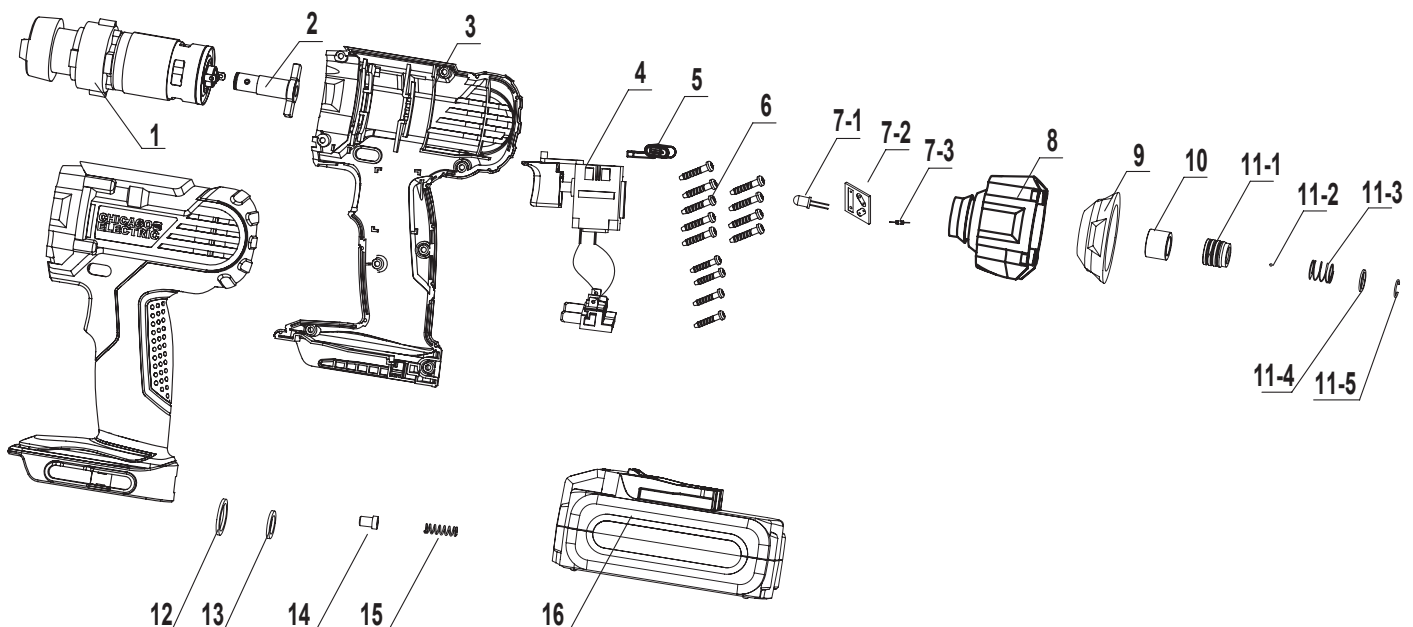

Record Product's Serial Number Here: \_\_\_\_\_

**Note:** If product has no serial number, record month and year of purchase instead.

**Note:** Some parts are listed and shown for illustration purposes only, and are not available individually as replacement parts.

## Limited 90 Day Warranty

Harbor Freight Tools Co. makes every effort to assure that its products meet high quality and durability standards, and warrants to the original purchaser that this product is free from defects in materials and workmanship for the period of 90 days from the date of purchase. This warranty does not apply to damage due directly or indirectly, to misuse, abuse, negligence or accidents, repairs or alterations outside our facilities, criminal activity, improper installation, normal wear and tear, or to lack of maintenance. We shall in no event be liable for death, injuries to persons or property, or for incidental, contingent, special or consequential damages arising from the use of our product. Some states do not allow the exclusion or limitation of incidental or consequential damages, so the above limitation of exclusion may not apply to you. THIS WARRANTY IS EXPRESSLY IN LIEU OF ALL OTHER WARRANTIES, EXPRESS OR IMPLIED, INCLUDING THE WARRANTIES OF MERCHANTABILITY AND FITNESS.

To take advantage of this warranty, the product or part must be returned to us with transportation charges prepaid. Proof of purchase date and an explanation of the complaint must accompany the merchandise. If our inspection verifies the defect, we will either repair or replace the product at our election or we may elect to refund the purchase price if we cannot readily and quickly provide you with a replacement. We will return repaired products at our expense, but if we determine there is no defect, or that the defect resulted from causes not within the scope of our warranty, then you must bear the cost of returning the product.

This warranty gives you specific legal rights and you may also have other rights which vary from state to state.

**CHICAGO  ELECTRIC®**  
**POWER TOOLS**

3491 Mission Oaks Blvd. • PO Box 6009 • Camarillo, CA 93011 • (800) 444-3353



## Free Manuals Download Website

<http://myh66.com>

<http://usermanuals.us>

<http://www.somanuals.com>

<http://www.4manuals.cc>

<http://www.manual-lib.com>

<http://www.404manual.com>

<http://www.luxmanual.com>

<http://aubethermostatmanual.com>

Golf course search by state

<http://golfingnear.com>

Email search by domain

<http://emailbydomain.com>

Auto manuals search

<http://auto.somanuals.com>

TV manuals search

<http://tv.somanuals.com>