

CHICAGO **welding**
ELECTRIC **systems**

Auto Body Stud Welding Kit

Model 94739

ASSEMBLY AND OPERATING INSTRUCTIONS



Diagrams within this manual may not be drawn proportionally.
Due to continuing improvements, actual product may differ slightly from the product described herein.

Distributed exclusively by Harbor Freight Tools®.

3491 Mission Oaks Blvd., Camarillo, CA 93011

Visit our website at: <http://www.harborfreight.com>



**Read this material before using this product.
Failure to do so can result in serious injury.
SAVE THIS MANUAL.**

Copyright© 2006 by Harbor Freight Tools®. All rights reserved. No portion of this manual or any artwork contained herein may be reproduced in any shape or form without the express written consent of Harbor Freight Tools.

For technical questions or replacement parts, please call 1-800-444-3353.

Specifications

Power Requirement	230VAC, Single Phase, 60 Hz, 60 Amps	Max Power (Instant)	10KVA
Secondary No Load Voltage	8.8V - 9.5V	Max. Working Current (Instant)	1300 A
Timed Work Mode	Timed Range: 0 - 1.2 sec.	Required Electrical Plug	3-Prong, 230 VAC, Polarized, Twist Lock, 60 Amps for maximum output (not included)
Included Accessories	(6) Electrode Tips, Slide-pull Hammer, (2) Hook Tips, (3) Carbon Rods	Duty Cycle	15% Spot Welding at Max. Output Power 40% Carbon Warming at Min. Output Power
Dimensions	17"L x 11"W x 11"H	Net Weight	63 Lbs.

Save This Manual

You will need the manual for the safety warnings and precautions, assembly instructions, operating and maintenance procedures, parts list and diagram. Keep your invoice with this manual. Write the invoice number on the inside of the front cover. Keep the manual and invoice in a safe and dry place for future reference.

General Safety Warnings and Precautions

WARNING: When using tool, basic safety precautions should always be followed to reduce the risk of personal injury and damage to equipment.

Read all instructions before using this tool!

Work Area Safety

1. **Keep your work area clean and well lit.** Cluttered benches and dark areas invite accidents.
2.  **Do not operate power tools in explosive atmospheres, such as in the presence of flammable liquids, gases, or dust.** Power tools create sparks which may ignite the dust or fumes.
3. **Keep bystanders, children, and visitors away while operating a power tool.** Distractions can cause you to lose control. Protect others in the work area from debris such as chips and sparks. Provide barriers or shields as needed.

Electrical Safety

4. **Grounded tools must be plugged into an outlet properly installed and grounded in accordance with all codes and ordinances. Never remove the grounding prong or modify the plug in any way. Do not use any adapter plugs. Check with a qualified electrician if you are in doubt whether the outlet is properly grounded.** If the tool should electrically malfunction or break down, grounding provides a low resistance path to carry electricity away from the user.
5. **Avoid body contact with grounded surfaces such as pipes, radiators, ranges, and refrigerators.** There is an increased risk of electric shock if your body is grounded.
6. **Do not expose power tools to rain or wet conditions.** Water entering a power tool will increase the risk of electric shock.
7. **Do not abuse the Power Cord. Never use the Power Cord to carry the tool or pull the Plug from an outlet. Keep the Power Cord away from heat, oil, sharp edges, or moving parts. Replace damaged Power Cords immediately.** Damaged Power Cords increase the risk of electric shock.

8. **When operating a power tool outside, use an outdoor extension cord marked “W-A” or “W”.** These extension cords are rated for outdoor use, and reduce the risk of electric shock.

Personal Safety

9. **Stay alert. Watch what you are doing, and use common sense when operating a power tool. Do not use a power tool while tired or under the influence of drugs, alcohol, or medication.** A moment of inattention while operating power tools may result in serious personal injury.
10. **Dress properly. Do not wear loose clothing or jewelry. Contain long hair. Keep your hair, clothing, and gloves away from moving parts.** Loose clothes, jewelry, or long hair can be caught in moving parts.
11. **Avoid accidental starting. Be sure the Power Switch is off before plugging in.** Carrying power tools with your finger on the Power Switch, or plugging in power tools with the Power Switch on, invites accidents.
12. **Remove adjusting keys or wrenches before turning the power tool on.** A wrench or a key that is left attached to an operational part of the power tool may result in personal injury.
13. **Do not overreach. Keep proper footing and balance at all times.** Proper footing and balance enables better control of the power tool in unexpected situations.

WARNING: This product, when used for welding, plasma cutting, soldering, or similar applications, produces chemicals known to the State of California to cause cancer and birth defects (or other reproductive harm). (California Health & Safety Code § 25249.5, et seq.)

Tool Use and Care

14. **Use clamps (not included) or other practical ways to secure and support the work piece to a stable platform.** Holding the work by hand or against your body is unstable and may lead to loss of control.
15. **Do not force the tool. Use the correct tool for your application.** The correct tool will do the job better and safer at the rate for which it is designed.
16. **Do not use the power tool if the Power Switch does not turn it on or off.** Any tool that cannot be controlled with the Power Switch is dangerous and must be replaced.
17. **Disconnect the Power Cord Plug from the power source before making any adjustments, changing accessories, or storing the tool.** Such preventive safety measures reduce the risk of starting the tool accidentally.
18. **Store idle tools out of reach of children and other untrained persons.** Tools are dangerous in the hands of untrained users.
19. **Maintain tools with care. Keep the welder clean.** Properly maintained tools function better and are easier to control. Do not use a damaged tool. Tag damaged tools “Do not use” until repaired.
20. **Check for misalignment or binding of moving parts, breakage of parts, and any other condition that may affect the tool’s operation. If damaged, have the tool serviced before using.** Many accidents are caused by poorly maintained tools.

Service

1. **Tool service must be performed only by qualified repair personnel.** Service or maintenance performed by unqualified personnel could result in a risk of injury.
2. **When servicing a tool, use only identical replacement parts.** Follow instructions in the “Inspection, Maintenance, And Cleaning” section of this manual. Use of unauthorized parts or failure to follow maintenance instructions may create a risk of electric shock or injury.
3. **Use only accessories that are recommended by the manufacturer for your model.** Accessories that may be suitable for one tool may become hazardous when used on another tool.

Specific Safety Rules

1. **Ground this product.** This Welder requires the attachment and use of a UL listed, 230 volt, grounded, 3-prong, electrical Power Cord Plug (not included). Only a qualified electrician should install the Power Cord Plug. Never remove the grounding prong or modify the Power Cord Plug in any way. Do not use adapter plugs with this product. To comply with the National Electric Code, and to provide additional protection from the risk of electrical shock, this product should only be connected to a 230 volt, 3-hole outlet that is properly grounded and protected by a Ground Fault Circuit Interrupter (GFCI).
2. **Industrial applications must follow OSHA guidelines.**
3. **Have a designated safe place to set down the welding gun** which is not flammable, will protect the gun from being bumped or dropped and will not conduct electricity.
4. **Never leave the welder unattended when it is plugged into an electrical outlet.** Turn off the welder, and unplug it from its electrical outlet before leaving.
5. **WARNING!** People with pacemakers should consult their physician(s) before using this product. Electromagnetic fields in close proximity to a heart pacemaker could cause interference to or failure of the pacemaker.

6. **Maintain a safe working environment.** Keep the work area well lit. Make sure there is adequate surrounding workspace. Always keep the work area free of obstructions, grease, oil, trash, and other debris. Do not use a power tool in areas near flammable chemicals, dusts, and vapors. Do not use this product in a damp or wet location.

7. **Prevent eye injury and burns.** Wearing and using ANSI-approved personal safety clothing and safety devices reduce the risk for injury.



- Wear ANSI approved safety impact eye goggles with a welding helmet with protective lens.
- Leather leggings, fire resistant shoes or boots should be worn when using this product. Do not wear pants with cuffs, shirts with open pockets, or any clothing that can catch and hold molten metal or sparks.

- Keep clothing free of grease, oil, solvents, or any flammable substances. Wear dry, insulating gloves and protective clothing.

- Wear an approved head covering to protect the head and neck. Use aprons, cape, sleeves, shoulder covers, and bibs designed and approved for welding and cutting procedures.

- When welding/cutting overhead or in confined spaces, wear flame resistant ear plugs or ear muffs to keep sparks out of ears.

8. **Prevent accidental fires.** Remove any combustible material from the work area.

-  When possible, move the work to a location well away from combustible materials. If relocation is not possible, protect the combustibles with a cover made of fire resistant material.

- Remove or make safe all combustible materials for a radius of 35 feet (10 meters) around the work area. Use a fire resistant material to cover or block all open doorways, windows, cracks, and other openings.

- Enclose the work area with portable fire resistant screens. Protect combustible walls, ceilings, floors, etc., from sparks and heat with fire resistant covers.

- If working on a metal wall, ceiling, etc., prevent ignition of combustibles on the other side by moving the combustibles to a safe location. If relocation of combustibles is not possible, designate someone to serve as a fire watch, equipped with a fire extinguisher, during the cutting process and for at least one half hour after the cutting is completed.

- Do not weld or cut on materials having a combustible coating or combustible internal structure, as in walls or ceilings, without an approved method for eliminating the hazard.

- Do not dispose of hot slag in containers holding combustible materials. Keep a fire extinguisher nearby and know how to use it.

- After spot welding, make a thorough examination for evidence of fire. Be aware that easily visible smoke or flame may not be present for some time after the fire has started. Do not weld or cut in atmospheres containing dangerously reactive or flammable gases, vapors, liquids, and dust. Provide adequate ventilation in work areas to prevent accumulation of flammable gases, vapors, and dust. Do not apply heat to a container that has held an unknown substance or a combustible material whose contents, when heated, can produce flammable or explosive vapors. Clean and purge containers before applying heat. Vent closed containers, including castings, before preheating, welding, or cutting.

9. **Avoid overexposure to fumes and gases.** Always keep your head out of the fumes. Do not breathe the fumes. Use enough ventilation or exhaust, or both, to keep fumes and gases from your breathing zone and general area.

Inhalation Hazard

Welding Produces TOXIC FUMES and GASSES.



Exposure to welding gasses can increase the risk of developing certain cancers, such as cancer of the larynx and lung cancer. Also, some diseases that may be linked to exposure to welding gasses or fumes are:

- Early onset of Parkinson's Disease
- Damage to the reproductive organs
- Inflammation of the small intestine or stomach
- Respiratory diseases such as emphysema, bronchitis or pneumonia
- Heart Disease
- Ulcers
- Kidney damage



Safety precautions, such as using natural or forced air ventilation and wearing an ANSI approved respirator, are **ESSENTIAL** to reduce the risk of developing the above illnesses.

- Where ventilation is questionable, have a qualified technician take an air sampling to determine the need for corrective measures. Use mechanical ventilation to improve air quality. If engineering controls are not feasible, use an approved respirator.
 - Work in a confined area only if it is well ventilated, or while wearing an air supplied respirator.
 - Follow OSHA guidelines for Permissible Exposure Limits (PEL's) for various fumes and gases.
 - Follow the American Conference of Governmental Industrial Hygienists recommendations for Threshold Limit Values (TLV's) for fumes and gases.
 - Have a recognized specialist in Industrial Hygiene or Environmental Services check the operation and air quality and make recommendations for the specific welding or cutting situation.
10. **Read and understand all instructions and safety precautions as outlined in** the manufacturer's manual for the material you will weld or cut.
 11. **Do not touch live electrical parts.** Wear dry, insulating gloves. Do not touch electrode or conductor tong with bare hand. Do not wear wet or damaged gloves.
 12. **Protect yourself from electric shock.** Do not use outdoors. Insulate yourself from the workpiece and ground. Use nonflammable, dry insulating material if possible, or use dry rubber mats, dry wood or plywood, or other dry insulating material big enough to cover your full area of contact with the work or ground.
 13. **Use caution when pulling out a dent.** A weld or panel may unexpectedly give way, possibly causing personal injury if caution is not exercised. Always pull in such a way that you will not lose balance, strike yourself, or otherwise injure yourself if the weld breaks. When using a Slide Hammer, make sure your body will not be in the way of the impacting weight.
 14. **WARNING!** The warnings and cautions discussed in this manual cannot cover all possible conditions and situations that may occur. It must be understood by the operator that common sense and caution are factors which cannot be built into this product, but must be supplied by the operator.

GROUNDING

NOTE: This tool requires the installation of a 3-prong 230 VAC, polarized twistlock power cord plug (not included). The plug must be installed by a qualified electrician. See Figure A below.

⚠ WARNING! Improperly connecting the grounding wire can result in the risk of electric shock. Check with a qualified electrician if you are in doubt as to whether the outlet is properly grounded. Do not modify the power cord plug provided with the tool. Never remove the grounding prong from the plug. Do not use the tool if the power cord or plug is damaged. If damaged, have it repaired by a service facility before use. If the plug will not fit the outlet, have a proper outlet installed by a qualified electrician.

GROUNDED TOOLS: TOOLS WITH THREE PRONG PLUGS

1. Tools marked with “Grounding Required” have a three wire cord and three prong grounding plug. The plug must be connected to a properly grounded outlet. If the tool should electrically malfunction or break down, grounding provides a low resistance path to carry electricity away from the user, reducing the risk of electric shock. **(See Figure A.)**
2. The grounding prong in the plug is connected through the green wire inside the cord to the grounding system in the tool. The green wire in the cord must be the only wire connected to the tool's grounding system and must never be attached to an electrically “live” terminal. **(See Figure A.)**
3. Your tool must be plugged into an appropriate outlet, properly installed **by a certified electrician** and grounded in accordance with all codes and ordinances. The plug and outlet should look like those in the following illustration. **(See Figure A.)**

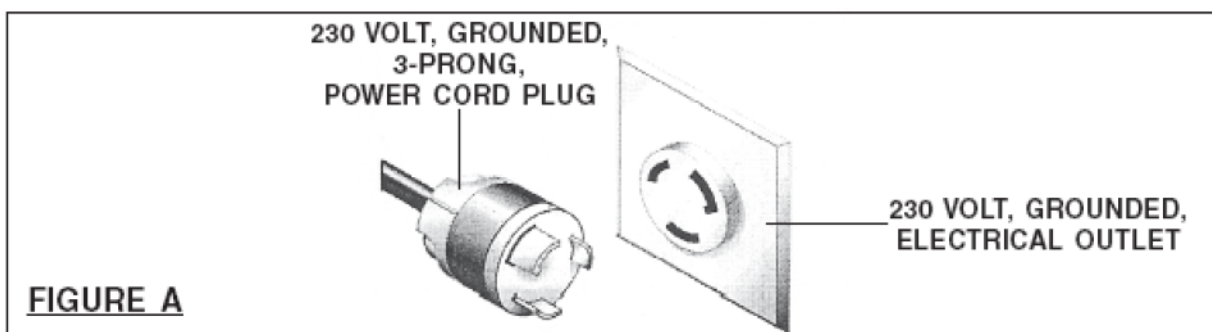

EXTENSION CORDS



1. **Grounded, 230 VAC** tools require a three wire extension cord.
2. As the distance from the supply outlet increases, you must use a heavier gauge extension cord. Using extension cords with inadequately sized wire causes a serious drop in voltage, resulting in loss of power and possible tool damage. **(See Figure B, below.)**
3. The smaller the gauge number of the wire, the greater the capacity of the cord. For example, a 10 gauge cord can carry a higher current than a 12 gauge cord. **(See Figure B.)**
4. When using more than one extension cord to make up the total length, make sure each cord contains at least the minimum wire size required. **(See Figure B.)**
5. If you are using an extension cord outdoors, make sure it is marked with the suffix "W-A" ("W" in Canada) to indicate it is acceptable for outdoor use.
6. Make sure your extension cord is properly wired and in good electrical condition. Always replace a damaged extension cord or have it repaired by a qualified electrician before using it.
7. Protect your extension cords from sharp objects, excessive heat, and damp or wet areas.

Recommended Minimum Wire Gauge For Extension Cords* (230 Volt)					
NAMEPLATE AMPERES (At Full Load)	EXTENSION CORD LENGTH				
	25 Feet	50 Feet	75 Feet	100 Feet	150 Feet
0 – 2.0	18	18	18	18	16
2.1 – 3.4	18	18	18	16	14
3.5 – 5.0	18	18	16	14	12
5.1 – 7.0	18	16	14	12	12
7.1 – 12.0	18	14	12	10	-
12.1 – 16.0	14	12	10	-	-
16.1 – 20.0	12	10	-	-	-

* Based on limiting the line voltage drop to five volts at 150% of the rated amperes.

FIGURE B

SYMBOLOLOGY

	Double Insulated
	Canadian Standards Association
	Underwriters Laboratories, Inc.
V ~	Volts Alternating Current
A	Amperes
no load xxxx per min.	No Load Revolutions per Minute

Unpacking

When unpacking, check to make sure that the product is intact and undamaged.



Included Components and Accessories:

Welding Unit
Electrode with Magnet / Shrinking Electrode
Puller Assembly
(2) Pot Hooks
(50) Washers
(3) Carbon Electrodes
(2) Spare Fuses

If any parts are missing or broken, please call Harbor Freight Tools at the number on the cover of this manual.

Assembly

1. **A 230 V plug (not included) must be installed on the Power Cord before use by a qualified technician.**

Caution: Be sure the plug and Power supply are appropriate for this tool. Circuit must be at least 60 Amps.

Control Panel

1. **Function Selector (1):**
 - a) *Continuous Operation* is used for Carbon warming and tempering of work material.
 - b) *Timed Operation* is used for washer or needle welding.
 - c) *OFF* to turn off power supply to welder.
2. **Timer Control (2):** Sets the duration of the pulse during timed welding operation. Settings range from 0 to 1.2 seconds.
3. **Power light (3):** indicates that power is supplied to the welder.
4. **Thermostat light (4):** comes on if overheat cutoff function is active.
5. **Working light (5):** indicates that welding operation is in process.

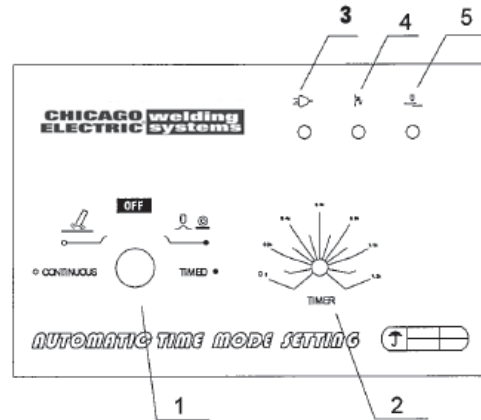

Installing the Welding Tip

Various tips are supplied for different welding operations. Select and install the appropriate tip before beginning work. **WARNING: The welder must be OFF and UNPLUGGED when installing tips.**

1. Insert the butt end of the tip into the Welding Gun. Be sure the welding tip is firmly seated in the gun.
2. Rotate the collar of the gun clockwise to tighten the tip.

Welding Tip Selection:

1. *Electrode with magnet for washer:* Washer can be held in magnetic tip, to be spot welded to dented area. Washer will later be pulled to pull out dent.
2. *Washer electrode reversed for shrinking:* Magnetic washer electrode may be reversed in the gun and used for shrinking. A convex dented area can be heated, then cooled with a wet rag to shrink the metal and reduce the swelling.
3. *Carbon Electrode:* May be used for cutting, filling cracks or heating for tempering or shrinking.
4. *Spot Weld Needle tips:* Used for spot welding.

Duty Cycle

This welder is rated for 15% duty cycle during welding at maximum power and 40% during warming at minimum power. Do not exceed duty cycle limits, as that may overheat the machine causing damage or premature wear. If the welder overheats, the Thermostat Light will come on, the welder will automatically shut off, and must remain off at least 30 minutes until cool.

NOTE: Duty Cycle is the percentage of 10 minutes the welder can be in operation without overheating. 15% duty cycle means that the welder can be energized approximately 1-½ minutes out of each 10 minute period. 40% duty cycle means the welder can be energized approx. 4 minutes out of each 10 minute period.

NOTE: Welding is a complex operation requiring training, skill and practice. We strongly recommend professional training before attempting any welding operation. This manual is intended only as basic information and cannot cover all aspects of the welding process.

Preparing to use the welder

1. Always clean both sides of the work material at and near the work place to remove paint, rust, dirt, grease and other contaminating material. Contaminants will interfere with the welding process, and may cause noxious gasses to be produced as they are heated during the welding operation.
2. Always connect the Ground Clamp to another cleaned location as close as possible to the work area (no more than 12" away).

NOTE: Always wear and use ANSI-approved personal safety clothing and safety devices to reduce the risk for injury.

Spot Welding Washers using the Magnetic Washer Tip

1. Thoroughly clean the area to be worked on using an angle grinder, powered wire brush or similar tool.
2. Attach the Ground Clamp near the area to be repaired.
3. Turn the Function Selector to the TIMED setting. Set the Timer Control to between 0.1 and 1.2 seconds. **NOTE:** The time must be adjusted for the thickness and relative density of the work material. In general, larger thicker washers will require longer welding time.
4. Insert a flat washer into the Magnetic Washer Tip.
5. Using the gun, press the washer against the dented area. Squeeze the trigger. The washer will be welded to the work material. Release the Trigger.
6. You may use washers of different sizes and thicknesses for different dents. Larger washers will have more pulling power. Be sure to use washers that are NOT galvanized or electroplated, and are free of rust, grease, dirt or other contaminants.
7. If necessary, you can spot weld the washer, then heat the surrounding area before pulling the washer. Heating the surrounding area will anneal, soften the metal making dent removal easier.

WARNING: Galvanized and electroplated metals generally have a zinc based plating to resist rust. When heated, zinc gives off a harmful, potentially poisonous gas. Do not weld with electroplated or galvanized materials.

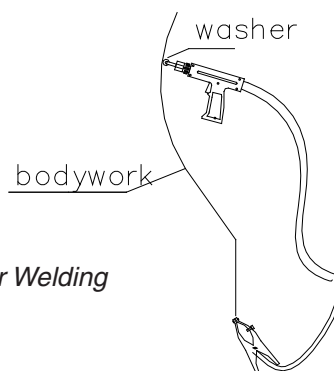

Schematic of Washer Welding

REV 08b

Using the Extractor Hook

1. Thread the Extractor Hook (Pot Hook) onto the slide puller assembly. Fit the extractor hook onto the washer.
2. Hold the Hand grip with one hand, and pull the Striker back sharply against the handle. This action will pull out the dent. Repeat as necessary. You may need to weld on additional washers at various spots to pull out the dent completely.
3. To remove the washers, grip the washer with a pliers (not included), and bend back and forth until the washer breaks off.
4. Using a grinder (not included), remove the weld spot from each repair location before finishing the dent repair.

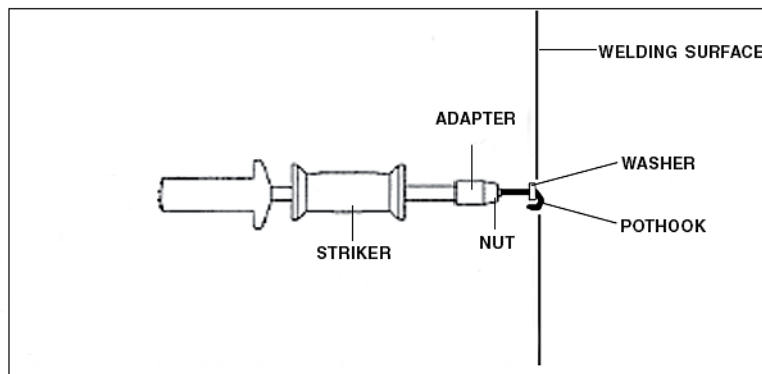

About Spot Welding

Spot welding is used to join two items of metal together. A high energy electrical force is applied at a small location for a short time. This electrical force causes the two items of metal to melt and fuse together at that spot.

If the electrical force is not large enough, if the duration is too short, or the metal is too thick or is dirty, the weld may not properly fuse.

If the electrical force is too high, if the duration is too long, or the metal is too thin, the metal may burn through; "blowing out" and causing a hole in the work material.

In auto body repair work, washers or pins may be welded to a spot on the vehicle body to allow a dent to be pulled out. The washer or pin is then removed, and the spot ground smooth for finishing. In cases where there is a hole or severely damaged body panel, a new sheet may be spot welded over the damaged area to provide a new surface for finishing.

Proper welding is a skill that takes some time and practice to acquire. Experienced welders will usually make one or more practice welds on scrap material, to adjust these variables, before making welds on the work material.

Using the Shrinking Electrode

1. Insert the Magnetic / Shrinking Electrode in the Gun with the rounded Shrinking end protruding.
2. Set the Ground Clamp as close as possible to the damaged area.
3. Set the Function Selector to CONTINUOUS.
4. Place the Electrode on the damaged area and squeeze the trigger. The electrode will heat up, as will the work material. Use the electrode to press the heated material down into shape, reducing or “shrinking” convex dents.

CAUTION: Be aware of your working time and do not exceed the welder’s Duty Cycle.

Using the Carbon Electrodes

The Carbon Electrodes can be used for warming or tempering, spot welding sheets together, crack filling or cutting sheet metal.

CAUTION: Be aware of your working time and do not exceed the welder’s Duty Cycle.

For Warming:

1. Insert the carbon electrode into the gun and tighten into place.
2. Connect the Ground near the work area.
3. Set the Function Selector to the “CONTINUOUS” setting.
4. Contact the metal with the electrode, holding the trigger down, and moving the electrode continuously over the surface.
5. When the surface has been heated, release the trigger and remove the electrode from the metal.
6. Warming the metal will anneal it, causing it to become softer. Sudden cooling of annealed metal, such as by applying water will temper the metal, causing it to become harder.
7. Depending on your reason for heating the area, you may hammer the annealed area to shape it, or apply a wet rag to the surface to temper the metal. Repeat the heating and working process as needed.

Spot Welding:

1. Using the Carbon Electrode, set the Function switch to “CONTINUOUS”.
2. Clamp the new sheet of metal to the car body.
3. Attach the ground nearby the work location.
4. Contact the electrode to the car body NOT the patch material, and squeeze the trigger. Hold the trigger in the ON position while the metal heats up. When you observe the metal beginning to fuse, either remove the electrode from the metal, making a spot weld, or move the electrode to make a line weld.

Crack Filling:

1. Using the Carbon Electrode, set the Function switch to “CONTINUOUS”.
2. Insert a clean piece of steel wire into the crack which has been cleaned and prepared for welding.
3. Attach the ground nearby the work location.
4. Contact the electrode to the metal and squeeze the trigger. Hold the trigger in the ON position while the metal heats up. When you observe the wire beginning to fuse, move the electrode along the crack to fuse the wire with the metal, filling the crack.

REV 06I

Cutting with the Carbon Electrodes:

1. Using the Carbon Electrode, set the Function switch to “CONTINUOUS”.
2. Attach the ground nearby the work location.
3. Contact electrode to metal and squeeze the trigger. Hold trigger in ON position while the metal heats up. Eventually the metal will begin to melt. Move the Carbon Electrode along a path to cut the metal.









WARNING: Plan ahead for the molten metal to fall onto a non-flammable surface, such as a concrete floor. Protect yourself, others and property from potential fire and burn injury caused by falling and splattering molten metal.

Maintenance and Troubleshooting

1. Anyone using this welder must have adequate training in the use of electric welders and related operations. This tool can be easily damaged by unskilled use.
2. Keep untrained or unauthorized persons away from the welder at all times.
3. After power is turned on, do not allow electrode tip to come closer than 6” from Grounding Clamp. When not welding, turn power off and do not lay the gun and Grounding Clamp on the same metal surface, as they may short out.
4. Always handle the Gun gently to avoid damage to its casing, handle or trigger. Always keep the electrodes, gun, cables and welder case clean and dry.
6. Store the welder in a clean dry place. Do not allow it to become wet or contaminated with grease, oils, etc. Do not allow the welder or its components to be exposed to long periods of direct sunlight.
7. In case of maintenance or repair, use only a qualified repair technician.

Problem	Possible Cause	Possible Solution
Will not function. Power Light is not on.	Power is OFF.	Connect to power supply.
	Main Switch is not turned ON.	Turn on switch.
	Fuse is broken.	Replace fuse.
Power light and Thermostat light are on, but welder doesn't function.	Automatic overheat interrupt protection.	Allow welder to cool for at least 30 minutes.
Working light is on but tool will not weld.	Bad Ground.	Check to be sure there is a positive ground.
	Metal is not clean.	Clean the work material removing paint, rust , dirt and grease.
Welding functions are OK, but timer doesn't operate.	Function selector is set on CONTINUOUS.	Move function selector to TIMED.
Excess splatter or sparkles when welding.	Traces of paint or rust have not been removed completely.	Stop work and clean the work material thoroughly.
Welds are made, but they are not strong.	Power voltage isn't up to required level.	Check to be sure power supply is at least 230 VAC.
	Wiring or extension cords do not meet standard.	Be sure the wiring meets standards specified on pages 7-9 of this manual.
	Grounding clamp is too far away from electrode.	Reset the Grounding Clamp in a better position.
	Work material is not clean. or has rust or paint on it.	Clean work material.
	Selected work time is too short.	Try a longer weld time.
	Washers or work material is too thick, or not a suitable alloy.	Try different sizes and types of work materials.

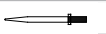
Welder Accessories

Ref	Description	Picture	Quantity
1A	Electrode w/magnet for washer		1 pc
	Reversible shrinking electrode		
2A	Washer		1 pack
3A	Carbon electrode		3 pcs
4A	Fuse		2 pcs
5A	Striker		1 set
6A	Pothook		2 pcs
7A	Pothook adapter		1 pc
8A	Spot Weld Needle		3 pc
9A	Extractor		1 pc

Main Wire Connection

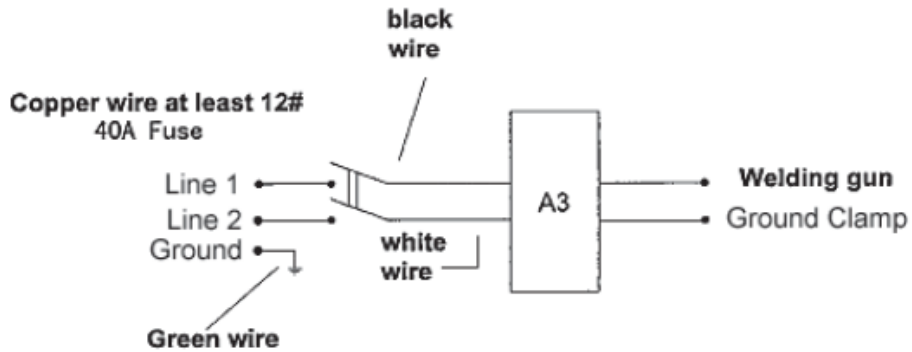

Circuit Diagram

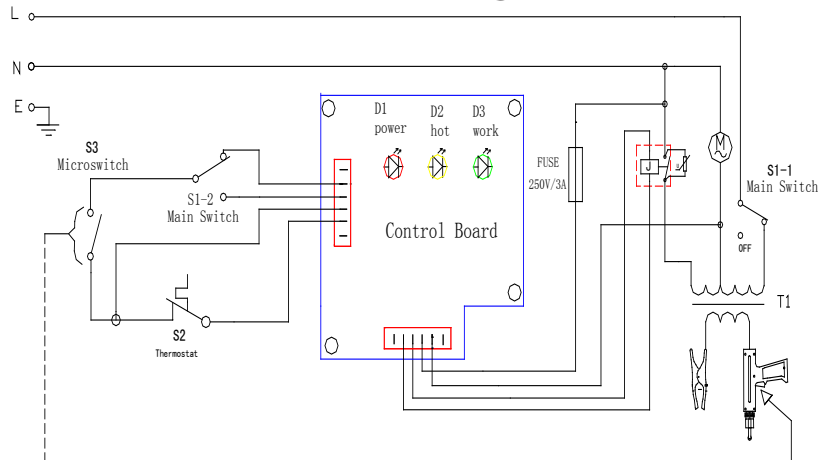

REV 06I, 08b

SKU 94739

For technical questions, please call 1-800-444-3353

Page 16

Parts List

Part	Description
1	Transformer
2	Cooling Fan
3	Relay
4	Shift Switch
5	Front Panel
6	Auxillary Transformer
7	Fuse Holder
8	Main Cable
9	Cable Bushing
10	Fan Cover
11	Thermostat
12	Control Board
13	Work Cable
14	Spot Welding Cable
15	Framework

Part	Description
16	Grounding Clamp
17	Welding Gun
18	Cable Bushing
19	Cable Bushing
20	Timer Knob
21	Function Selector
22	Top Cover
23	Handle
24	Power Light
25	Thermostat Light
26	Working Light
27	Trigger
28	Electrode Holder Mandrel
29	Control Cable

Assembly Photo

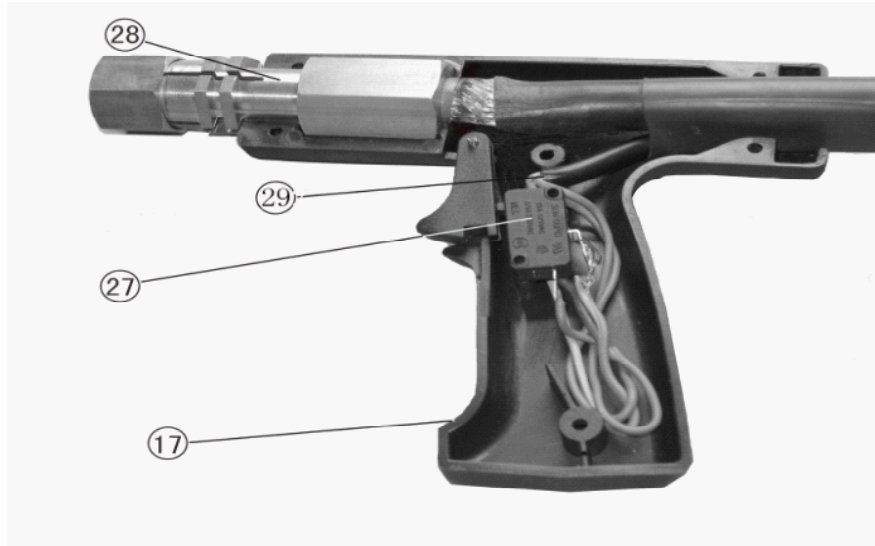

Assembly Photo

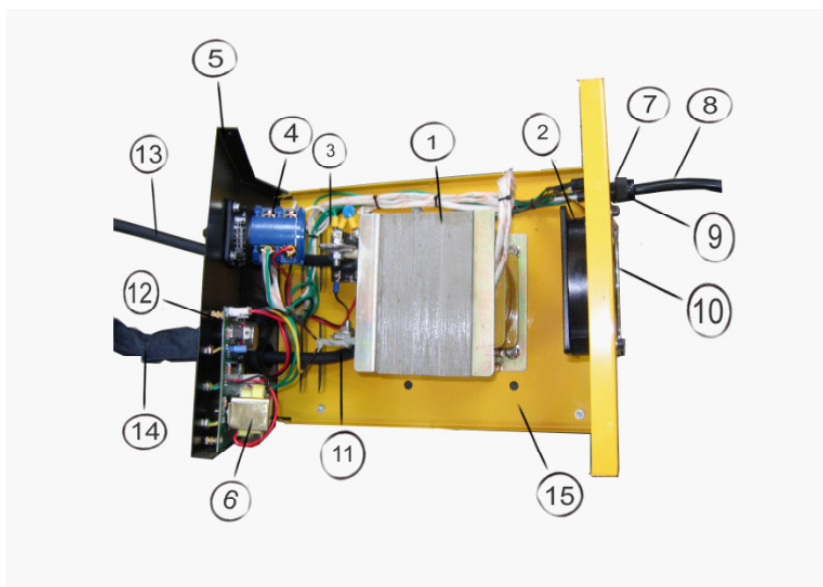

NOTE: Some parts are listed and shown for illustration purposes only and are not available individually as replacement parts.

PLEASE READ THE FOLLOWING CAREFULLY

THE MANUFACTURER AND/OR DISTRIBUTOR HAS PROVIDED THE PARTS DIAGRAM IN THIS MANUAL AS A REFERENCE TOOL ONLY. NEITHER THE MANUFACTURER NOR DISTRIBUTOR MAKES ANY REPRESENTATION OR WARRANTY OF ANY KIND TO THE BUYER THAT HE OR SHE IS QUALIFIED TO MAKE ANY REPAIRS TO THE PRODUCT OR THAT HE OR SHE IS QUALIFIED TO REPLACE ANY PARTS OF THE PRODUCT. IN FACT, THE MANUFACTURER AND/OR DISTRIBUTOR EXPRESSLY STATES THAT ALL REPAIRS AND PARTS REPLACEMENTS SHOULD BE UNDERTAKEN BY CERTIFIED AND LICENSED TECHNICIANS AND NOT BY THE BUYER. THE BUYER ASSUMES ALL RISK AND LIABILITY ARISING OUT OF HIS OR HER REPAIRS TO THE ORIGINAL PRODUCT OR REPLACEMENT PARTS THERETO, OR ARISING OUT OF HIS OR HER INSTALLATION OF REPLACEMENT PARTS THERETO.

REV 06I, 08b

SKU 94739

For technical questions, please call 1-800-444-3353

Page 19

LIMITED 1 YEAR / 90 DAY WARRANTY

Harbor Freight Tools Co. makes every effort to assure that its products meet high quality and durability standards, and warrants to the original purchaser that for a period of ninety days from date of purchase that the torch, liner, wire feed mechanism (if applicable), welding clamps, electrode holders, cables and accessories packed with the welder are free of defects in materials and workmanship. This Limited 90 Day/1 Year Warranty shall not apply to consumable parts such as tips, welding wire, and gas nozzles. Harbor Freight Tools also warrants to the original purchaser, for a period of one year from date of purchase, that the transformer and rectifier are free from defects in materials and workmanship (90 days if used by a professional contractor or if used as rental equipment). This warranty does not apply to damage due directly or indirectly to misuse, abuse, negligence or accidents, repairs or alterations outside our facilities, normal wear and tear, or to lack of maintenance. We shall in no event be liable for death, injuries to persons or property, or for incidental, contingent, special or consequential damages arising from the use of our product. Some states do not allow the exclusion or limitation of incidental or consequential damages, so the above limitation of exclusion may not apply to you. THIS WARRANTY IS EXPRESSLY IN LIEU OF ALL OTHER WARRANTIES, EXPRESS OR IMPLIED, INCLUDING THE WARRANTIES OF MERCHANTABILITY AND FITNESS.

To take advantage of this warranty, the product or part must be returned to us with transportation charges prepaid. Proof of purchase date and an explanation of the complaint must accompany the merchandise. If our inspection verifies the defect, we will either repair or replace the product at our election or we may elect to refund the purchase price if we cannot readily and quickly provide you with a replacement. We will return repaired products at our expense, but if we determine there is no defect, or that the defect resulted from causes not within the scope of our warranty, then you must bear the cost of returning the product.

This warranty gives you specific legal rights and you may also have other rights which vary from state to state.

3491 Mission Oaks Blvd. • PO Box 6009 • Camarillo, CA 93011 • (800) 444-3353

Free Manuals Download Website

<http://myh66.com>

<http://usermanuals.us>

<http://www.somanuals.com>

<http://www.4manuals.cc>

<http://www.manual-lib.com>

<http://www.404manual.com>

<http://www.luxmanual.com>

<http://aubethermostatmanual.com>

Golf course search by state

<http://golfingnear.com>

Email search by domain

<http://emailbydomain.com>

Auto manuals search

<http://auto.somanuals.com>

TV manuals search

<http://tv.somanuals.com>