

Bosch Remote Control



for: GWH-635-ES/635-ESO/250SX/250SXO/

2400E/2400EO/2400ES/2700ES/715ES/C800ES



Contents

1	FCC Declaration of conformity	3	5	Remote control installation for: GWH C 950 ES/GWH C800 ES/ GWH 715 ES/ GWH 2700 ES/ GWH2400ES	10
2	Remote control data	4	5.1	Remote control transceiver PCB installation	10
3	Remote control Kit	4	5.2	Remote control activation11	10
3.1	Parts supplied	4	<hr/>		
4	Remote control installation for: GWH-635-ES/GWH-635- ESO/250SX/250SXO/2400E/ 2400EO	5	6	Remote control	13
4.1	Remote control transceiver PCB installation	5	6.1	Description of the LCD	13
4.2	Remote control activation	8	6.2	Hot water temperature adjustment by remote control	13
4.2.1	AF board	8	6.3	"Program" button on the remote control	13
4.2.2	SU board	9	6.4	"Priority" function	15
			6.5	Error messages	16
			<hr/>		
			7	Troubleshooting	16
			7.1	Replacing batteries	16
			7.2	Cleaning	16
			7.3	Troubleshooting	16
			<hr/>		
			8	Notes	19



Safety instructions

- ▶ Read the following instructions very carefully to ensure correct operation.
- ▶ Follow safety instructions.



Caution: Any changes or modifications not expressly approved by the party responsible for compliance could void the user's authority to operate the equipment.



Caution: the remote control is water resistant and can also be used in the shower . Nevertheless, it is not waterproof and must not be immersed in water, for instance in the bathtub .

1 FCC Declaration of conformity

This device meets the requirements of FCC Directives.



Caution: The remote control can be used only in the following countries: United States of America and Canada.

This device complies with Part 15 of the FCC rules. Operation is subject to the following two conditions: (1) This device may not cause harmful interference, and (2) this device must accept any interference received, including interference that may cause undesired operation.

2 Remote control data

Remote control for temperature adjustment of Bosch water heaters.

Technical Data:

Battery power supply	Alkaline AA LR 6 2 x 1.5V
Frequency	915 MHz
Type of protection	IP X6
User range	98 ft (30 m)

Further Information:

Remote control	Up to 6 remote controls can be programmed for one single appliance.
-----------------------	---

3 Remote control Kit

3.1 Parts supplied

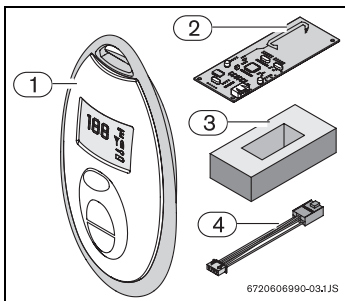

Fig. 1 Parts

- 1 Remote control
- 2 Remote control transceiver PCB
- 3 Support block (used only for GWH-635-ES/GWH-635-ESO/250SX/250SXO)
- 4 PCB connection cable

4 Remote control installation for: GWH-635-ES/GWH-635-ESO/250SX/250SXO/2400E/2400EO

4.1 Remote control transceiver PCB installation



Warning: For safety reasons, disconnect the power supply to the water heater before performing installation.

Pre-installation preparation

- ▶ Disconnect power supply to heater.
- ▶ Remove plastic decals on front panel.
- ▶ Loosen two Philips head screws located behind plastic decals.

- ▶ Lift front cover upward and remove.

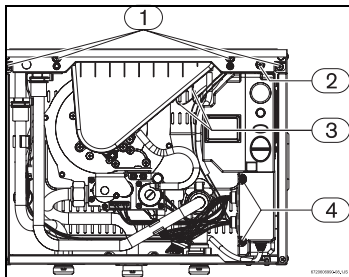
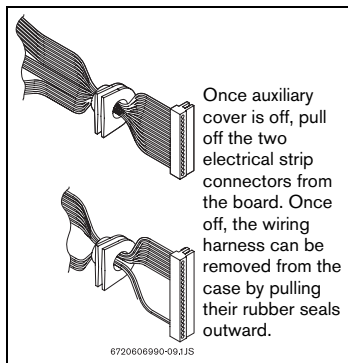

Fig. 2

- ▶ Remove the 5 screws on the front retaining bar (see Fig. 2, pos. 1 and 2) being careful not to damage the foam sealant material on it.
- ▶ Remove control unit auxiliary cover (Fig. 2, pos. 4).
- ▶ Remove the two electrical strip connectors inside the auxiliary cover (Fig. see diagram below) and then loosen the 110V power supply cord retaining nut located underneath the heater. Once loosened, the power cord can be pulled up through the heater to provide sufficient slack.

Remote control installation



- ▶ At the ignition electrodes, pull off the 2 yellow igniter wires that come from the top of the control unit (Fig. 2, pos. 3). Then pull the complete control unit forward and out of the heater, pull up the power supply cord further if more slack is needed.
- ▶ While holding the unit in one hand or resting it on a flat surface, remove the front cover of the control unit by removing the 4 screws.

Remote control transceiver PCB installation

- ▶ Open control unit top cover (Fig. 3, pos. 1).
- ▶ Remove the protective paper (Fig. 3, pos. 2) from one face of the support

and attach it to the main PCB as shown in Fig. 4.

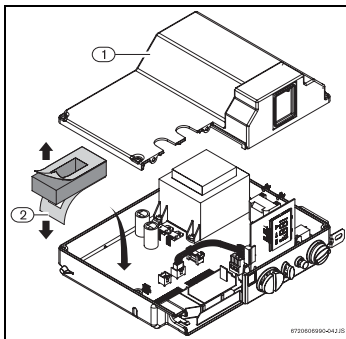

Fig. 3

- ▶ Remove the other protective paper and attach the remote control PCB as shown in Fig. 5.

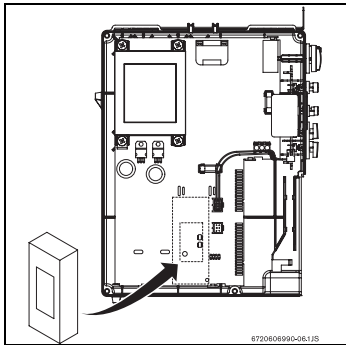

Fig. 4 Support correct position

- ▶ Use the supplied cable to connect between the main PCB and the remote control PCB as shown in Fig. 5.

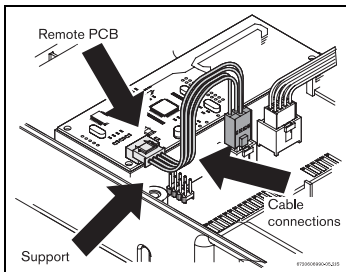

Fig. 5

- ▶ Replace the control unit cover with the 4 Philips head screws (Fig. 3, pos. 1).
- ▶ Slide control unit back into heater.
- ▶ Plug 2 yellow electrode wires from the top of the control unit back onto the ignition electrodes. Ensure all connections are secure and tight (Fig. 2, pos. 3).



Wire polarity does not matter on the electrode wires.

- ▶ Pull end of power cord to take up excess slack and tighten retaining nut on the bottom of the heater.
- ▶ Reinstall the two electrical strip connectors onto the PCB. The larger connector connects to the lower connection on the PCB. Reseat the rubber seals for both connectors.
- ▶ Replace the control unit auxiliary cover. (Fig. 2, pos. 4).
- ▶ Replace front retaining bar using 5 Phillips head screws. (Fig. 2, pos 1).

4.2 Remote control activation



Before the remote control will work, it must be activated using the procedure described below with the operator standing in front of the appliance.



The remote control activation instructions vary based on the version of control board installed in your heater.

To determine the control board version in the water heater:





- ▶ Turn power switch on the water heater to the off position (O).
- ▶ When turning power switch to the on position, note the first two letters that appear on the display (should be AF or SU).
- ▶ If the letters are AF, follow section 4.2.1.
For SU, follow section 4.2.2.

4.2.1 AF board

- ▶ Connect power to heater.
- ▶ Move the power switch on the appliance to the off position (O).

- ▶ On heater control panel press and hold Program key  or  while turning on the power switch (I). Release program key when LCD displays "188".



LCD shows "P2". If not, repeat previous step.



- ▶ Select "P3" using buttons  and  on heater.
- ▶ Press and hold Program key  or  again for 1 sec.

LCD shows one number and one rotating digit. If not, repeat previous step.

The number represents the remote control which is to be registered, the first remote control will be registered with number "0", the second with number "1" and so on.

The rotating digit shows that the electronics is expecting a registration. If the LCD fails to show a number and rotating digit after repeated attempts, double check the wire connections made in section 4.1.

- ▶ Hold remote control in front of the control panel on the heater and simultaneously press remote control buttons  and  until the temperature indication is shown on the remote control LCD.

- ▶ Switch power switch on the appliance to the "OFF" (0) position and then back "ON" (I).
- ▶ Press buttons  or  in order to reach desired temperature.

New remote control is programmed.

4.2.2 SU board

- ▶ Connect power to heater.
- ▶ Move the main switch on the appliance to the "OFF" (0) position.
- ▶ Press and hold  key while at the same time turning the main switch to "ON" position (I).



LCD shows one number and one rotating digit. If not repeat previous step.



The number represents the remote control which is to be registered, the first remote control will be registered with number "0", the second with number "1" and so on.

The rotating digit shows that the electronics is expecting a registration.

If the LCD fails to show a number and rotating digit after repeated attempts, double check the wire connections made in section 4.1.

- ▶ Hold remote control in front of the control panel on the heater and

simultaneously press remote control buttons  and  until the temperature indication is shown on the remote control LCD.

- ▶ Switch ON/OFF switch to "OFF" position (0) and then back on (I).
- ▶ Press buttons  or  in order to reach requested temperature.

New remote control is programmed.

5 Remote control installation for: GWH C 950 ES/GWH C800 ES/GWH 715 ES/GWH 2700 ES/GWH2400ES

5.1 Remote control transceiver PCB installation



Warning: For safety reasons, disconnect the power supply to the water heater before performing installation.

- ▶ Remove the 6 screws from the back cover of the control unit, to access the electronic board (PCB) (Fig. 7, pos.2).

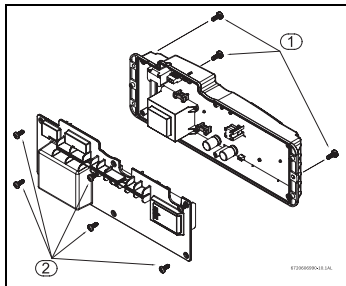

Fig. 7

Pre-installation preparation

- ▶ Loosen the two Philips head screws located on bottom rear of cover.
- ▶ Lift front cover upward and remove.
- ▶ Remove the three screws from the control unit (Fig. 7, pos.1).

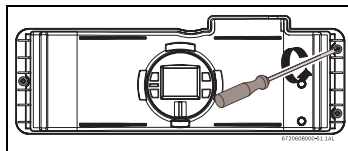

Fig. 6

Remote control transceiver PCB installation

- ▶ Place the remote control PCB in the back cover of the control unit as shown in Fig. 8.

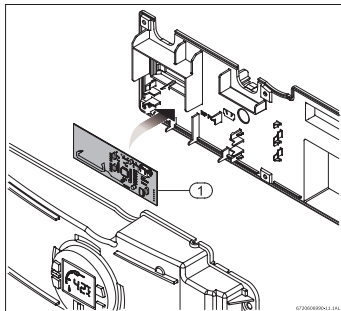

Fig. 8

- ▶ Connect the supplied cable between the main PCB and the

remote control PCB as shown in Fig. 9.

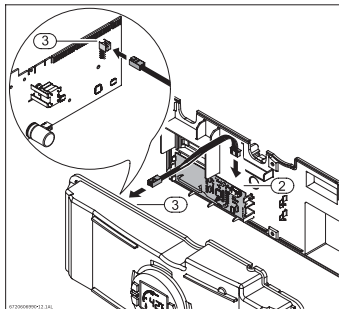

Fig. 9

- ▶ Reassemble all parts in the reverse order.



5.2 Remote control activation



Before the remote control will work, it must be activated using the procedure described below with the operator standing in front of the appliance.

- ▶ Connect power to heater.
- ▶ Press ON / OFF button on the appliance to OFF.

Remote control installation

- ▶ On heater control panel, press and hold Program key  while pressing the ON/OFF button to ON. Release program key when LCD displays "188".
- ▶ Press ON / OFF button on the appliance to OFF position and then back ON.
- ▶ Press buttons  or  to reach desired temperature.

LCD shows "P2". If not, repeat previous step.



1. Press the  button on the heater to select "P3".

- ▶ Press and hold Program key  again for 1 sec.

LCD shows one number and one rotating digit. If not, repeat previous step.

The number represents the remote control which is to be registered, the first remote control will be registered with number "0", the second with number "1" and so on.

The rotating digit shows that the electronics is expecting a registration. If the LCD fails to show a number and rotating digit after repeated attempts, double check the wire connections made in section 5.1.

- ▶ Hold remote control in front of the control panel on the heater and simultaneously press remote control buttons  and  until the temperature indication is shown on the remote control LCD.

New remote control is programmed.

6 Remote control

6.1 Description of the LCD

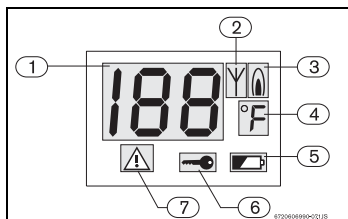



Fig. 10 Multifunctional LCD

- 1 Displays temperature, error codes and functions
- 2 "Remote control in operation" indication (signal arriving at remote control)
- 3 Device in operation (with burner on)
- 4 Temperature measurement unit (possible in °C and °F)
- 5 Remote control battery level indication (weak signal coming from the remote control)
- 6 Priority function (temperature cannot be modified by other user when water is running)
- 7 "Error code" symbol

6.2 Hot water temperature adjustment by remote control

- ▶ Press the buttons  or  on the remote control (Fig. 11, pos. 2) until the required temperature

appears on the remote control display (Fig. 11, pos. 1).

- ▶ When the required temperature is displayed, turn on the hot water tap.
- ▶ The required temperature will flash on the remote control display.
- ▶ The flashing will stop when the required temperature is reached (tolerance from selected set point +/- 5°F (+/- 2°C).

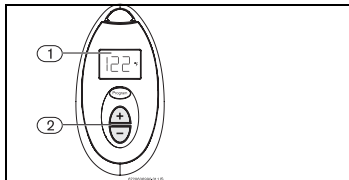



Fig. 11 Temperature adjustment

6.3 "Program" button on the remote control

Memorizing the water temperature with the remote control "Program" button

- ▶ Press the buttons  or  on the remote control (Fig. 12, pos. 2), until the required temperature appears on the remote control display (Fig. 12, pos. 1).
- ▶ You will now be able to memorize this temperature by pressing the "Program" button on the remote

Remote control

control (Fig. 12, pos. 3) for 3 seconds.



Note: Previously saved temperature may show on the display when first pushing the program button. Once "PR" shows on the display, the desired setting will be saved.

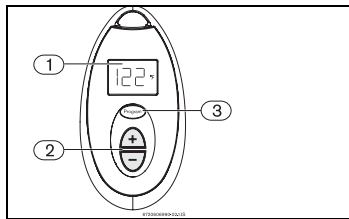

Fig. 12 Memorizing water temperature

- ▶ Only one temperature per remote control can be memorized using the "Program" button on the remote control.
- ▶ At this point the remote control will display the memorized temperature . When the hot water tap is turned on, the water heater will supply hot water at the temperature memorized on the remote control.



Up to six addition remote controls can be used to memorize a temperature for each remote control.

Using the "Program" button (operation with memorized temperature)

To operate the equipment with a previously memorized temperature:

- ▶ Press the "Program" button on the remote control.

The remote control display and heater display will now show the previously memorized temperature. When the hot water tap is turned on, the water heater will supply hot water after a few seconds, at the memorized temperature.

6.4 "Priority" function



Temperature cannot be memorized or changed using the heater's control panel buttons or a second remote control when hot water is in use (e.g. during a shower). The "Priority" function will automatically activate to stop another user from modifying the temperature when hot water is in use.

The remote control does not have a default temperature setting and therefore has no default "Priority" function. The "priority" will be attributed automatically by the first user who selects or memorizes (on the remote control or on the heater's control panel) a temperature for subsequent use (e.g. a shower).

Then, when the hot water is used (e.g. for a shower), the heater's display and additional remote control displays will show the symbol " ".

The temperature may only be modified using the same buttons that set it (depending on whether the control panel or the remote control was used).

The priority device will not have the symbol " ".

To clear a device that is locked out with the " " symbol (with no hot water running) simply:

- ▶ press and hold both the " " and " " buttons on that device for 5 seconds.

The "Priority" function ends:

- 5 minutes after the last use of the hot water (return to basic set up).
- 2 minutes after selecting/memorizing the temperature if no hot water is used immediately afterwards.

Acquiring "priority"

Any user can acquire "priority" for subsequent use of hot water, as follows:

- ▶ Move the heater's main switch to the ON position (I).
- ▶ Press and hold " " or " " to select the desired temperature.
- ▶ Press and hold the "Program" button until the symbol "Pr" appears on the remote control display.
- ▶ Use the hot water within two minutes of acquiring "priority".



"Priority" cannot be acquired while the hot water tap is open.



Verify that the rubber seal is correctly fitted between both plastic housing parts.

6.5 Error messages

This device has an error message system. Any errors that the heater generates will be indicated by an error code that will appear on the display (Fig. 10, pos. 1) and by a symbol indicating a "safety block" (Fig. 10, pos. 7). The remote control will be operative only after pressing the reset button on the heater and clearing the error.

To identify the type of error or if the error will not clear, consult the heater installation manual.

- ▶ Close the battery housing using the two screws.



Warning: dead batteries must be replaced.

Consequently, the manufacturer is not liable for any faults or damage caused by dead batteries.

Dispose of the dead batteries properly.

7 Troubleshooting

7.1 Replacing batteries

When batteries are weak, the low battery symbol (Fig. 10, pos. 5) will appear on the display.

- ▶ Remove the two screws on the back of the remote control.
- ▶ Open the battery housing and remove the batteries, then replace with new AA 1.5V batteries, ensuring they are inserted correctly.

7.2 Cleaning

Use a damp cloth to clean parts of the remote control. Do not use abrasive or solvent-based detergents.

7.3 Troubleshooting

1. No display on remote control

- ▶ Check for weak or dead batteries (see section 7.1).

Remote control in sleep mode.



If not used for a few minutes, the remote's display will go blank to save the batteries.

- ▶ Simply press any button on the remote to bring up the display.

2. Remote control will not activate / no number with rotating digit

- ▶ Ensure that you are standing directly in front of the water heater when attempting to activate.
- ▶ Ensure that no other device in the area, such as a cordless phone, is operating on a frequency similar to the remote (915 MHz) and causing interference.
- ▶ Double check all wire connections made under section 4.1 or section 5.1 of the remote control manual. Pay close attention to the wire connecting the remote's PCB to the heater's main PCB.

3. Remote display shows "- -" only

- ▶ Verify the water heater's ON/OFF switch is turned to the ON (I) position. If the water heater's display is still blank, verify the heater is plugged into a live 120VAC/ 60Hz properly grounded outlet.

- ▶ Verify there is proper voltage to the water heater (120VAC/60Hz).
- ▶ Verify the remote is within the maximum distance from the water heater of 98 feet.
- ▶ Ensure that no other device in the area, such as a cordless phone, is operating on a frequency similar to the remote (915 MHz) and causing interference



Large amounts of metal or concrete in the structure may have a blocking effect on the remote's signal. This may alter the maximum distance allowable from the water heater.

- ▶ Move within direct line of sight of the water heater to see if signal will reconnect.

4. Error code and “” symbol will not clear from remote

- ▶ Error codes cannot be reset by using the remote. All errors must be cleared by using the reset button  on the water heater's control panel

- If an error code is generated immediately after the installation of the remote control transceiver PCB, ensure that the two large electrical connectors (Fig.) on the main PCB are properly seated.
- Error code may not be resettable. Consult water heater's installation manual or www.boschpro.com for further troubleshooting on error codes.



5. Remote will not memorize desired temperature setting

- ▶ Verify that the remote control "program" button is depressed until the remote display reads "Pr".



Memorization of a selected temperature only saves to the device on which it was originally programmed. To retrieve a memorized temperature setting, you must use the device with which it was programmed.

6. Priority " " symbol will not clear

- ▶ Verify no hot water is being used when trying to clear "priority" function.
- ▶ With no hot water running, press and hold the " " or " " buttons for 5 seconds on the locked out device (remote or water heater) until the "  " symbol (Fig. 10, Pos. 6) disappears.
- ▶ Do not use any hot water for at least 5 minutes. The priority function should automatically clear after this time period.

8 Notes

BBT NORTH AMERICA
Bosch Group

Bosch Water Heating
340 Mad River Park
Waitsfield, Vermont 05673

800 642-3111
802 426-6924

Free Manuals Download Website

<http://myh66.com>

<http://usermanuals.us>

<http://www.somanuals.com>

<http://www.4manuals.cc>

<http://www.manual-lib.com>

<http://www.404manual.com>

<http://www.luxmanual.com>

<http://aubethermostatmanual.com>

Golf course search by state

<http://golfingnear.com>

Email search by domain

<http://emailbydomain.com>

Auto manuals search

<http://auto.somanuals.com>

TV manuals search

<http://tv.somanuals.com>