



brother®

ELECTRONIC LABELING SYSTEM

P-TOUCH XL

USER'S GUIDE

YOUR P-TOUCH XL

Thank you for purchasing the P-TOUCH XL!

Your new P-TOUCH XL will help you design and print labels for any application. Extremely versatile, it can create characters of many sizes and styles. In addition, by using the variety of tape cartridges available, you can print labels with different widths and exciting colors.

You no longer have to worry about rushing tasks that require professional-type printing. In the office, the factory, the lab, and the home; the quality and performance of the P-TOUCH XL make it a very versatile machine.

Finally, as we expect you will want to refer to this manual occasionally, we suggest that you keep it in a handy place.

FCC NOTICE

This equipment has been tested and found to comply with the limits for a Class B digital device, pursuant to Part 15 of the FCC Rules. These limits are designed to provide reasonable protection against harmful interference in a residential installation. This equipment generates, uses, and can radiate radio frequency energy and, if not installed and used in accordance with the instructions, may cause harmful interference to radio communications. However, there is no guarantee that interference will not occur in a particular installation. If this equipment does cause harmful interference to radio or television reception, which can be determined by turning the equipment off and on, the user is encouraged to try to correct the interference by one or more of the following measures:

- Reorient or relocate the receiving antenna
- Increase the separation between the equipment and receiver.
- Connect the equipment into an outlet on a circuit different from that to which the receiver is connected.
- Consult the dealer or an experienced radio/television technician for help.

NOTICE

This digital apparatus does not exceed Class B limits for radio noise for digital devices as set out in the radio interference regulations of the Canadian Department of Communications.

(For Canada Only)

CONTENTS

ABOUT THIS MANUAL	1
BEFORE YOU START	3
MACHINE DIAGRAM	4
GENERAL PRECAUTIONS	6
TAPE CASSETTES	7
TO CLEAN THE PRINT HEAD AND ROLLERS	8
THE AC ADAPTOR	9
(OPTIONAL Ni-Cd BATTERY)	
LEARNING THE ROPES	11
INTRODUCTION (LEARNING THE ROPES)	12
DOOR SIGN EXAMPLE	13
EQUIPMENT LABEL EXAMPLE	18
ADDRESS LABEL EXAMPLE	25
STORAGE SHELF LABEL EXAMPLE	28
FOR YOUR INFORMATION	37
INTRODUCTION	38
FINDING YOUR WAY	39
POWER SWITCH	40
THE CURSOR	41
SHIFT, ALT, & CAPS	42
THE CODE KEY	43
SYMBOLS	44
COMPOSITE CHARACTERS	45
RETURN	46
NEW BLOCK	48
NUMBERING	49
TAGGING	51
CANCEL	52
CURSOR MOVEMENT	53
INSERT VS. OVERWRITE	54
BACKSPACE	56
LINE OUT	57
CLEAR	58
BASIC FORMATTING PRINCIPLES	59
MODE INDICATORS	60
FONT	61
SIZE	62
STYLE	64
UNDERLINE	66
FRAMING	67
LENGTH	68
HORIZONTAL ALIGNMENT	69

CONTENTS(continued)

VERTICAL ALIGNMENT	70
VERTICAL PRINTING	71
TAPE WIDTH PRINTING	72
MIRROR PRINTING	73
GLOBAL FORMATS	74
LOCAL FORMATS	76
STORE	78
RECALL	79
M.DELETE	81
PRINTING & TAPE FEED	82
BARCODING	84
HOW TO REMOVE LABEL BACKING	86
MESSAGE LIST	87
TROUBLESHOOTING	93
MACHINE SPECIFICATIONS	94
FEATURES	95
ACCESSORIES	96

ABOUT THIS MANUAL

Although the P-TOUCH XL is easy to use, we suggest that you read this manual carefully before starting. The manual consists of three main sections:

BEFORE YOU START

Provides basic information concerning the machine itself, tape cartridges, and power supplies.

LEARNING THE ROPES

This tutorial section leads you through easy-to-follow practice sessions designed to make you familiar with the machine's operations.

FOR YOUR INFORMATION

A handy reference section with detailed explanations of all of the P-TOUCH XL's features.

You should read the brief "Before you Start" section before using your P-TOUCH XL. If this is your first time using this machine, or if you would like to brush up on some usage techniques, we suggest you work through the exercises in "Learning the Ropes." When you have detailed questions about specific features, the "For Your Information" section will provide the answers.

Good luck! We hope you enjoy using your P-TOUCH XL.



**BEFORE YOU
START**

FEATURES

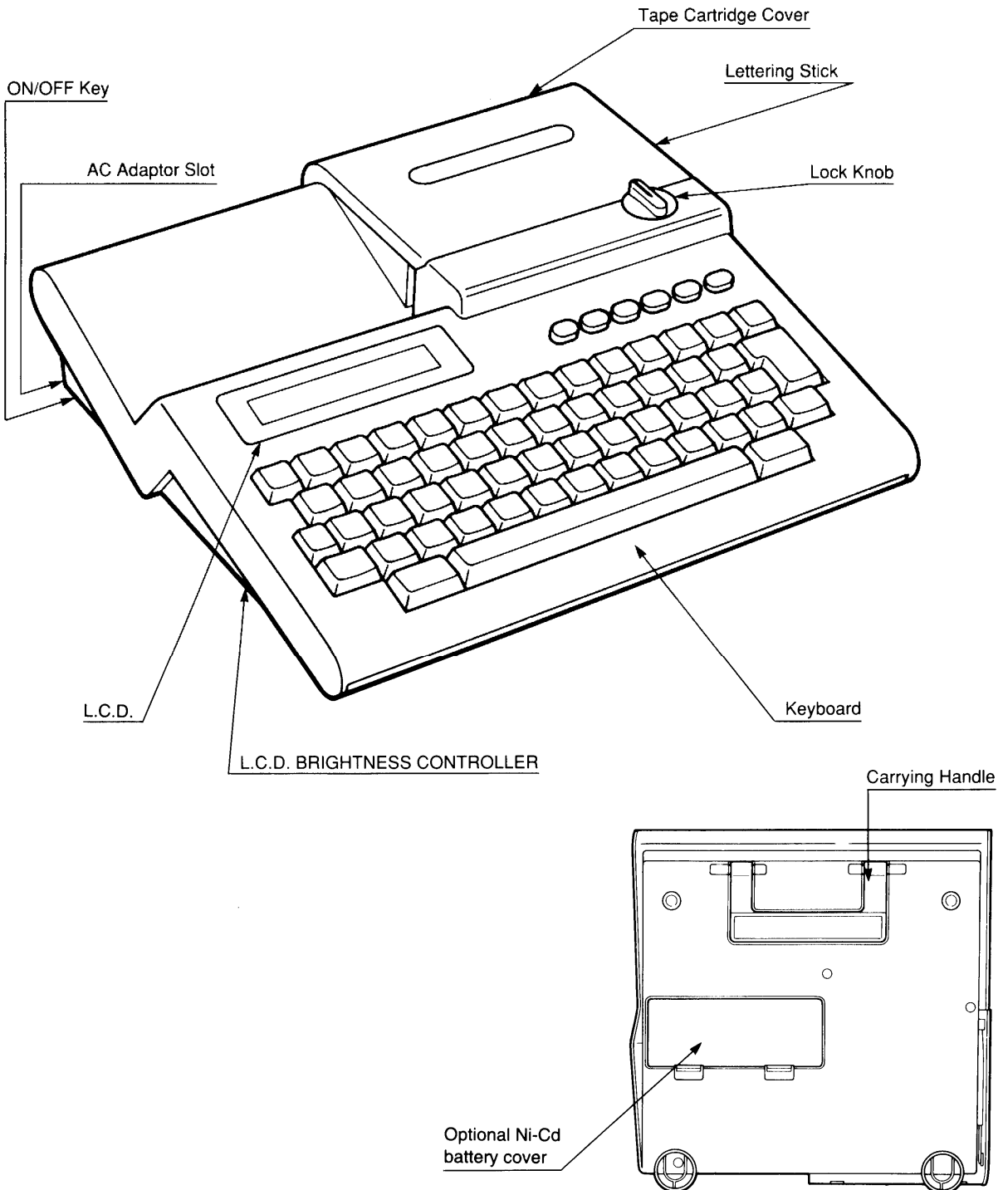

GENERAL PRECAUTIONS

- **Do not pull on the tape. This may damage the tape cassettes.**
- Use the AC Adaptor designed exclusively for the P-TOUCH XL.
- **Do not clean the machine with alcohol or other organic solvents. Use only a soft, dry cloth.**
- **Do not put any foreign objects onto or into the machine.**
- **To avoid injuries, do not touch the cutter's edge.**
- Avoid using the machine in extremely dusty places. Keep it out of both direct sunlight and rain.
- Disconnect the AC adaptor if you do not intend to use your machine for a long time.
- **Do not leave any rubber or vinyl on the machine for an extended period of time. Doing so may cause staining.**

TAPE CASSETTES

A single tape cassette is supplied with this unit. However, tapes for the P-TOUCH XL are available in a wide range of background colors, type colors, and tape sizes. We encourage you to use this variety of labels for color-coding and other style-intensive uses.

With this in mind, we have designed the P-TOUCH XL to allow quick and easy insertion and changing of tape cassettes.

TO INSERT A TAPE CASSETTE:

- (1) Turn the cassette cover lock knob to release the tape and its cover. Lift the cover so you can easily reach the tape cassette.
- (2) If there is a tape cassette already in the compartment, pull it straight up to remove it.
- (3) Remove the stopper from a new tape cassette. If the tape inside the cassette is loose, use your finger to wind it in the direction of the arrow on the plastic tape cassette until it is taut.
- (4) Insert the tape cassette firmly into the compartment.
- (5) Turn the cassette cover lock knob to secure the cover and the tape.
- (6) Shut the compartment cover.
- (7) Press the Tape Cutter Key once to remove any slack from the tape.

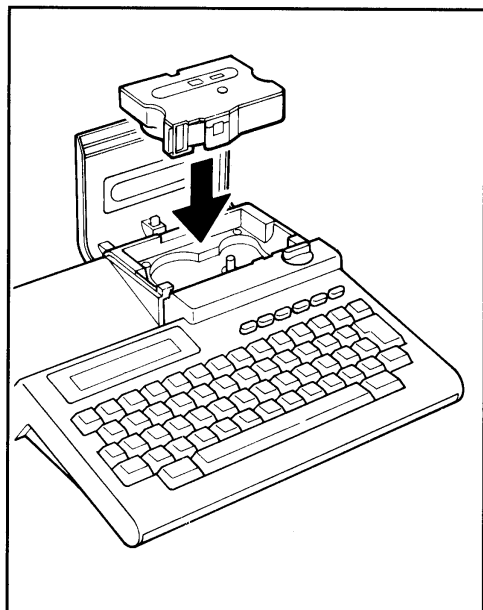
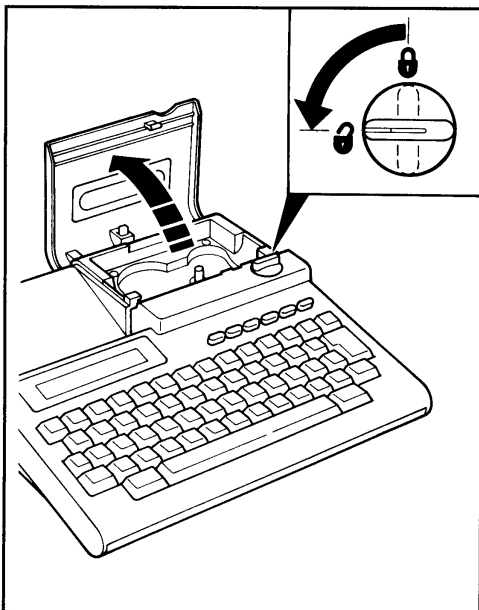

TO CLEAN THE PRINT HEAD AND ROLLERS

Occasionally, specks of dust or dirt may attach themselves to this machine's print head or rollers. This is particularly likely when using the unit outdoors, or in very dusty environment. When this occurs, the print element obscured by the dust cannot print, causing an unprinted (blank) line to stretch across the label. Vertical lines indicate dirty rollers; horizontal lines indicate dirty print head. Therefore, like a tape recorder, this machine's head may need to be cleaned from time to time.

HOW TO CLEAN THE PRINT HEAD AND ROLLERS

- (1) Turn off the machine.
- (2) Open the cassette compartment cover and remove the tape cassette. The print head and rollers are located in the cassette compartment.
- (3) Print head: Wipe the print head gently with a dry cotton swab in the up-down direction.
Rollers: Wipe each roller vertically with a dry cotton swab while rotating the roller with your finger.
- (4) Again try a practice print. If dust still remains, dip the cotton swab in isopropyl (rubbing) alcohol and repeat step (3).
- (5) If none of the above works, contact your service representative.

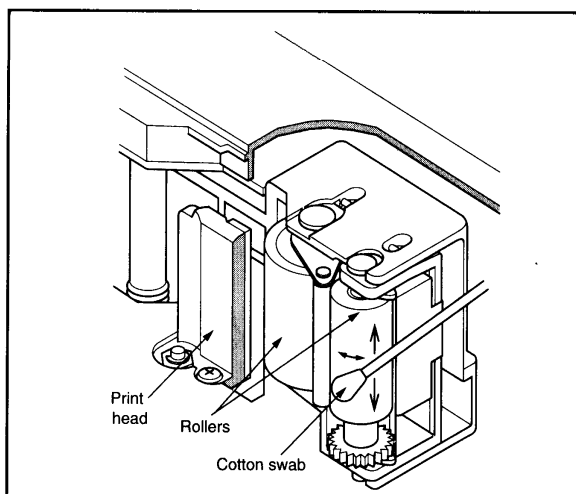
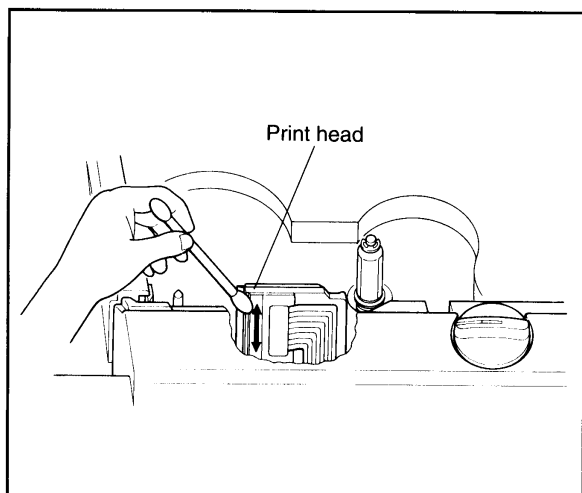

THE AC ADAPTOR (OPTIONAL Ni-Cd BATTERY)

The P-TOUCH XL is a light, portable machine. The AC adaptor included with the unit allows you to use the machine anywhere a standard electrical outlet is available.

TO ATTACH THE AC ADAPTOR:

- (1) Insert the adaptor's small connector into the attachment slot on the left side of the machine.
- (2) Plug the large connector into the nearest standard electrical outlet.

Note: For those planning to use the P-TOUCH XL outdoors, or in places without convenient outlet access, optional Nickel-Cadmium batteries are available. (Please see the Accessories section for purchasing information.)

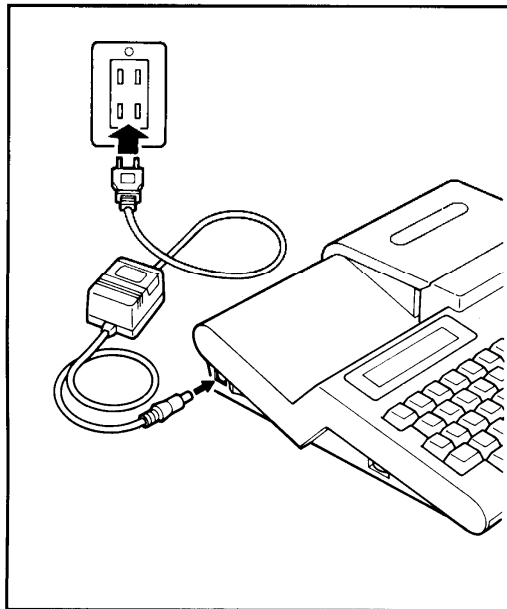

THE AC ADAPTOR (OPTIONAL Ni-Cd BATTERY) (continued)

TO INSTALL AN OPTIONAL RECHARGEABLE BATTERY:

- (1) Make sure that the power is turned off.
- (2) Open the battery compartment cover on the bottom of the machine.
- (3) Connect the optional rechargeable battery's connector as shown and insert the battery in the compartment.
- (4) Close the cover.

Note: Do not repeatedly connect and disconnect the battery unnecessarily. It may damage the connectors.

TO CHARGE THE RECHARGEABLE BATTERY:

A new battery must be charged before you can use the machine without the AC adaptor.

- (1) After installing a rechargeable battery according to above steps, connect the AC adaptor.
- (2) Turn on the machine. If the power switch is kept on and you do not use the machine, the battery will become fully charged in about six hours.

Note: A new, fully charged battery will be able to supply enough power to print approximately one whole tape cassette.

As the battery becomes old, the power time it can supply after being fully charged will decrease. When its performance becomes poor, it may be necessary to replace the battery.

A charged battery will automatically power the machine whenever you turn the power on without the AC adaptor's being connected.

ATTENTION: The optional Ni-Cd battery is recyclable. At the end of its useful life, under various state and local laws, it may be illegal to dispose of this battery into the municipal waste stream. Check with your local solid waste officials for details in your area for recycling options or proper disposal.

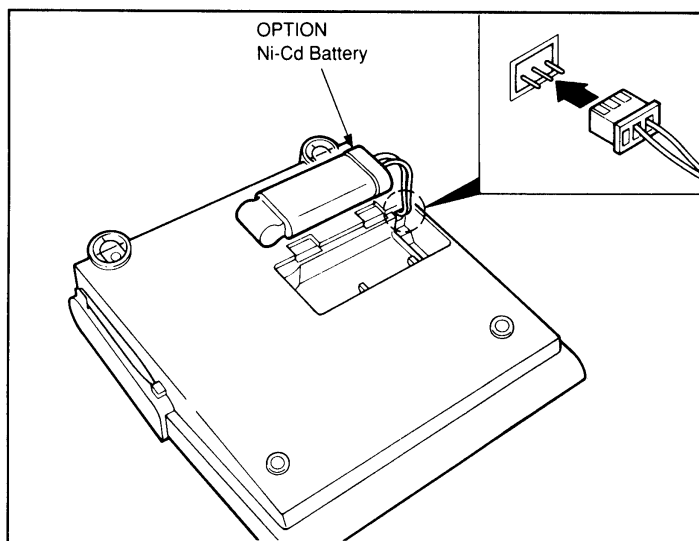



LEARNING THE ROPES

INTRODUCTION (Learning the Ropes)

In "Learning the Ropes" you will find a series of label-making examples. These examples will help you start making labels immediately, before reading the detailed "For Your Information" section. The featured label designs become increasingly more complex, requiring you to use the more advanced features of the P-TOUCH XL. The first exercise consists of creating a simple, one-line door sign. The second, an equipment instruction label, takes advantage of several additional machine capabilities. The third is a four-line address label. Finally, the storage shelf label shows you how to use the unit's more expert features.

If you are a first time user, we suggest that you work through these exercises, following all of the instructions on your machine. Since they do not require much time, they can be done all at once, or in four separate working sessions.

The "Learning the Ropes" practice sessions consist of the following portions:

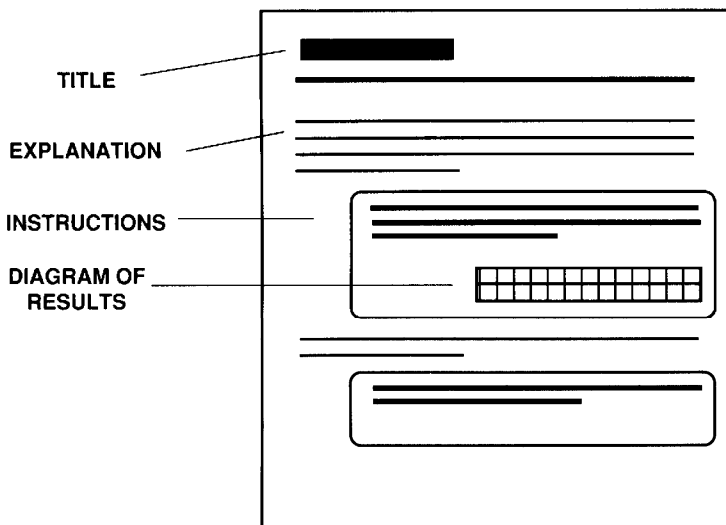

To best use this training section, simply follow the flow of the practice sessions. Read the background explanations, then follow the instructions on your P-TOUCH XL, checking that your results match the diagrams provided here in the manual. If you would like more detailed information about a particular point, simply check in the "For Your Information" section. And remember, if you ever get lost, or want to reinforce a point you have learned, you can easily start over or repeat any of the practices in "Learning the Ropes."

And now, let's see how easy it is to make beautiful labels with the P-TOUCH XL!

DOOR SIGN EXAMPLE

First, you must turn on the machine's power. The power button is located on the left-hand side of the machine.

Sample To turn on the P-TOUCH XL:

- Press the Power On button located on the machine's left-hand side

F	M	T	◀	A	▶	A	:	A	U	T	:	N	O	R	M	A	L	:	:	
1	:	_																		

The top line of the display shows current format settings. Format "A" has been pre-programmed into the P-TOUCH XL, and represents the most popular style settings for labels. You can create your own formats for labels, and can even define "local" formats, special style settings for portions of text within a single label. Detailed explanations of global and local formats, their creation and editing, can be found in the Formatting section of "For Your Information."

The bottom line of the display will hold the first line of text you input. The "1:" on the left indicates that this is the first line of the message. Though the machine's LCD display is 22 characters wide, you can create messages with many more characters. The 22-character display is like a window which moves across your message, allowing you to view different parts.

The mark resembling an underline is called a "cursor." The cursor is like a pointer which shows your current position, and lets you select points and portions of your text.

Now we wish to enter the word "Meeting." To do so, we must first input a capital "M".

Sample To input a capital M:

- Hold down **SHIFT** and press **M**.

F	M	T	◀	A	▶	A	:	A	U	T	:	N	O	R	M	A	L	:	:	
1	:	M	_																	

- Release **SHIFT** and type "eeting".

F	M	T	◀	A	▶	A	:	A	U	T	:	N	O	R	M	A	L	:	:	
1	:	M	e	e	t	i	n	g	_											

DOOR SIGN EXAMPLE (continued)

Like on a typewriter, the SPACE key lets you add a blank space into the message.

Note: The SPACE key and ► key have different functions. The ► key moves the cursor forward through inputted text without adding blank spaces.

Sample To complete the message "Meeting Room 1":

- Press **SPACE** once to add a blank space.

F	M	T	◀	A	▶	A	:	A	U	T	:	N	O	R	M	A	L	:	:	
1	:	M	e	e	t	i	n	g												

Next, enter the word "Room":

- Hold down **SHIFT** and press **R**.
- Release **SHIFT** and type "oom".
- Press **SPACE** once to add another blank space.
- Press **1**.

F	M	T	◀	A	▶	A	:	A	U	T	:	N	O	R	M	A	L	:	:	
1	:	M	e	e	t	i	n	g		R	o	o	m							

Once you have created a message, the P-TOUCH XL allows you to edit it easily, correcting mistakes, or simply adjusting the text or style. Detailed explanations of text editing methods can be found in the Editing section of "For Your Information."

Now, let's practice editing by changing the word "Meeting" to "Conference". The first step is deleting the word "Meeting". The BACKSPACE key allows you to remove characters from your message. The character immediately to the left of the cursor is deleted, and all characters following the deletion move one space to the left.

Sample To delete the word "Meeting" from the message:

- Press  until the cursor is positioned to the right of the "g" in "Meeting".



F	M	T	◀	A	▶	A	:	A	U	T	:	N	O	R	M	A	L	:	:	
1	:	M	e	e	t	i	n	g	_	R	o	o	m	1						

- Press  until the whole word has been deleted.

F	M	T	◀	A	▶	A	:	A	U	T	:	N	O	R	M	A	L	:	:	
1	:	_	R	o	o	m	1													

Now we must insert the word "Conference" into the message. Two different character entry modes exist: Insert and Overwrite. In Overwrite Mode, characters typed replace the originally inputted characters. In Insert Mode, characters are added to the message at the cursor location. (See the Editing section of "For Your Information" for details on character entry modes.)

Sample To insert the word "Conference" into the message, changing it to "Conference Room 1":

- Check the triangular "INS" indicator on the top of the display. This display tells you whether Insert Mode is on or not. If the indicator is lit, fine. If it is not, press  + . (The indicator should now be lit.)

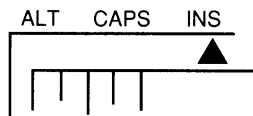

- Enter the word "Conference".

F	M	T	◀	A	▶	A	:	A	U	T	:	N	O	R	M	A	L	:	:	
1	:	C	o	n	f	e	r	e	n	c	e	_	R	o	o	m	1			

DOOR SIGN EXAMPLE (continued)

Next we will practice overwriting, changing the lower-case letters in our message to upper-case characters more appropriate for a door sign. Since we will enter many upper-case letters, we will use Caps Mode, which allows us to enter a string of capital letters without pressing the SHIFT key.

Sample To overwrite lower-case letters with capitals:

- Press **◀** until the cursor is positioned under the "o" in "Conference".
- Press **CODE** + **INSERT** to turn Insert Mode off (the indicator will go out).
- Check the triangular "CAPS" indicator on the top of the display. This display tells you whether Caps Mode is on or not. If the indicator is lit, fine. If it is not, press **CODE** + **CAPS**. (The CAPS indicator should now be lit.)

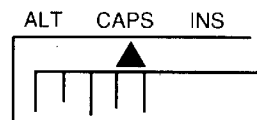

- Type "ONFERENCE". Even without pressing the SHIFT key, all letters will be entered as capitals.
- Now repeat do the same for the letters "oom" of "Room".

F	M	T	◀	A	▶	A	:	A	U	T	:	N	O	R	M	A	L	:	:	
1	:	C	O	N	F	E	R	E	N	C	E	R	O	O	M	_	1			

Finally, suppose we wish to add a No Smoking symbol to our door sign. The No Smoking mark is just one of many available on the P-TOUCH XL. A detailed explanation of symbol entry can be found in the Inputting section of "For Your Information."

Sample To add a No Smoking symbol to the end of the message:

- Press **▶** until the cursor is positioned to the right of the "1". Add a space.

F	M	T	◀	A	▶	A	:	A	U	T	:	N	O	R	M	A	L	:	:	
1	:	C	O	N	F	E	R	E	N	C	E	R	O	O	M	1	_			

DOOR SIGN EXAMPLE (continued)

- Press **CODE** + **SYMBOL** . The first group of symbols will be displayed.

S	Y	M	B	O	L	:	↑	↓	→	←	↖	↗	↘	↙	↕	↔	↕	{	}	<<	>>	•	
1	:	C	O	N	F	E	R	E	N	C	E	R	O	O	M	1	_						

- Press ▲ and ▼ to scroll through the available symbol groups until the group with the No Smoking mark is displayed.

S	Y	M	B	O	L	:	↑	↓	↻	♿	♿	♿	♿	♿	♿	♿	♿	♿	♿	♿	♿	♿	
1	:	C	O	N	F	E	R	E	N	C	E	R	O	O	M	1	_						

- Press ▶ until the No Smoking mark is selected (is blinking).

S	Y	M	B	O	L	:	↑	↓	↻	♿	♿	♿	♿	♿	♿	♿	♿	♿	♿	♿	♿	♿	
1	:	C	O	N	F	E	R	E	N	C	E	R	O	O	M	1	_						

- Press Return. The No Smoking mark will be added to your message.

F	M	T	◀	A	▶	A	:	A	U	T	:	N	O	R	M	A	L	:	:				
1	:	C	O	N	F	E	R	E	N	C	E	R	O	O	M	1		⊘					

Since our message is finished, we can now print it. Though several printing settings are available, we will use the default settings pre-programmed into the P-TOUCH XL.

Sample To print the label:

- Press **PRINT** . Print setting options will appear on the display. Press Return (↵) to print without changing the settings.

CONFERENCE ROOM 1 

EQUIPMENT LABEL EXAMPLE

In this practice session, we will make a multi-line equipment instruction label.

Sample To prepare for a new label:

- Turn on the power.
- If the previous work session's text data is still displayed, press **CODE**
+ **CLEAR**
- A confirmation message is displayed. Press **RETURN**

F	M	T	◀	A	▶	A	:	A	U	T	:	N	O	R	M	A	L	:	:
1	:																		

For this label-making session, assume you want to make an instruction label for an office photocopier. We will input lines of text with both upper-case and lower-case letters. If you have any questions about basic input, please review the previous example (Door Sign) or see the Inputting section of "For Your Information".

Also, in this exercise we will be making a multi-line message. The **RETURN** key operates like the return on a typewriter, moving the cursor to the next line. When you press **RETURN**, a **↵** mark will be added to the text line.

Sample To enter a four-line message:

- Press **CODE** + **CAPS** to turn CAPS Mode off. (The CAPS indicator should now be off.)
- Type "Place original face down."



Note: The line of text is longer than the LCD display. The first characters ("Plac") will move off the display.

F	M	T	◀	A	▶	A	:	A	U	T	:	N	O	R	M	A	L	:	:				
1	:	e		o	r	i	g	i	n	a	l		f	a	c	e		d	o	w	n	.	_

- Press **RETURN**. The cursor will move to line 2, allowing you to input a second line of text. Note that the numbers on the display's left side are line indicators.

1	:	P	l	a	c	e		o	r	i	g	i	n	a	l		f	a	c	e		d	o
2	:	_																					



EQUIPMENT LABEL EXAMPLE (continued)

- Type "Turn off when finished.". Again, the first characters will move off the display.
- Press .
- To finish the message type "Service Department". Press . Then type the Service Department's telephone number, "822-1394".

3	:	S	e	r	v	i	c	e		D	e	p	a	r	t	m	e	n	t	.			
4	:	8	2	2	-	1	3	9	4														

Any time you wish to view the current format settings, you can press the FORMAT key.

Sample To view the current format settings:

- Press  + .

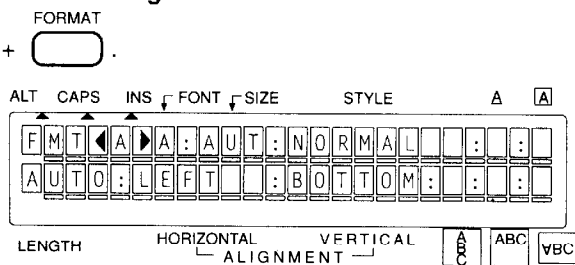

At this time, the settings are fine. Any time you wish to escape from Format Mode to Text Mode without changing any current settings, simply press the CANCEL key. A detailed explanation of the CANCEL key can be found in the Inputting section of "For Your Information."

Sample To return to the text entry screen:

- Press .

3	:	S	e	r	v	i	c	e		D	e	p	a	r	t	m	e	n	t	.			
4	:	8	2	2	-	1	3	9	4														

Now, let's edit the message, changing it from four to three lines, and adjusting some of the text.

EQUIPMENT LABEL EXAMPLE (continued)

Sample To edit the text message:

- Press ▲ once to move the cursor to line 3.

2	:	T	u	r	n	o	f	f		w	h	e	n		f	i	n	i	s	h	e	d	
3	:	S	e	r	v	i	c	e		D	e	p	a	r	t	m	e	n	t				

- Press **CODE** + **L. OUT**

Note: All of the text in line 3, as well as its return mark are deleted. The total number of lines changes from four to three. All lines after the line out are re-numbered, the old line 4 becoming the new line 3.

2	:	T	u	r	n	o	f	f		w	h	e	n		f	i	n	i	s	h	e	d
3	:	8	2	2	-	1	3	9	4													

- Check the LCD display's triangular indicators to make sure that Insert Mode is on. If not, press **CODE** + **INSERT**

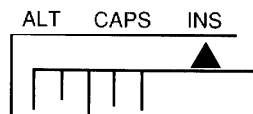

- Type "Repairs:" and add a space.

2	:	T	u	r	n	o	f	f		w	h	e	n		f	i	n	i	s	h	e	d
3	:	R	e	p	a	i	r	s	:		8	2	2	-	1	3	9	4				

The message has now been created and edited. If it were printed now, the standard settings of Format A would be used. The text would be in Font A, auto-sized, left margin flush, normal style, non-framed, and non-underlined. (For more details concerning format settings, please see the Formatting section of "For Your Information.")

EQUIPMENT LABEL EXAMPLE (continued)

For this label, though, let's assume we want a different style of text: Font B, framed, and horizontally centered. We must therefore create a new format.

Sample To change to Font B:

- Press **CODE** + **FORMAT**.

Note: The "A" is flashing. This flashing is like a cursor; it shows which format setting is currently "active." Items can only be changed when they are flashing.

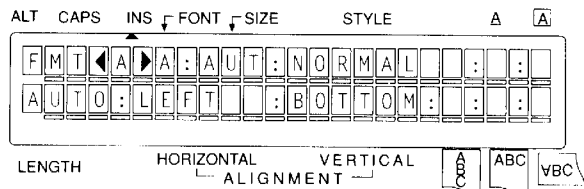

- Press **▶** once. The font item (currently set to Font A) will flash.
- Press **▲** or **▼** until "B" is displayed.

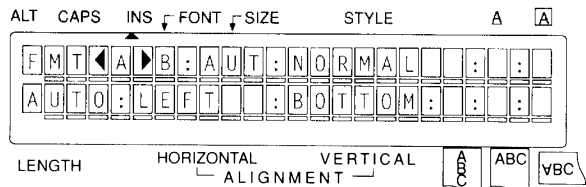

In general, this system is used for editing format settings. The left and right arrow keys let you move from item to item. The up and down arrow keys allow you to change the current settings.

Sample To finish editing the format settings:

- Use the **◀** and **▶** to move, the **▲** and **▼** to select. Change Framing to On (a triangular indicator will appear), and Horizontal Alignment from Left to Center.

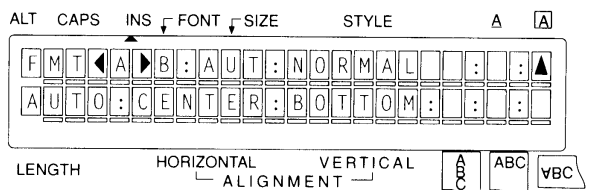

EQUIPMENT LABEL EXAMPLE (continued)

Finally, let's assume that we have three photocopy machines on which we want to attach the same label. Therefore, we need to print three copies of the same text. A detailed explanation of this Repeat Printing function can be found in the Printing section of "For Your Information."

Sample To print three copies of the label:

- Press . The print options menu will be displayed.

	A	U	T	O	-	C	U	T			T	A	P	E	F	E	E	D	→
	0	N									:	F	U	L					

- Press  until the "# of copies" setting (currently 1) is flashing.

←	C	O	P	I	E	S					I	N	C	R	E	A	S	E	S	
	1										:	O	F	F						

- Press  to change the setting to three (copies).

←	C	O	P	I	E	S					I	N	C	R	E	A	S	E	S	
	3										:	O	F	F						

If we now wished to print three copies of the label, we would simply press RETURN. Three labels with Font B characters, framed and horizontally centered would result.

Place original face down.
Turn off when finished.
Repairs: 822-1394

Place original face down.
Turn off when finished.
Repairs: 822-1394

Place original face down.
Turn off when finished.
Repairs: 822-1394

Since this would use a fair amount of tape, though, we can now press CANCEL to escape from Print Mode and return to our text.

ADDRESS LABEL EXAMPLE (continued)

- Press **▶** until the character style setting is flashing.
- Use **▲** and **▼** until italic is displayed.
- * Press **▶** until the Underlining (**A**) field is flashing. Turn underlining On.

L	O	C	A	L	B	:	A	U	T	:	I	T	A	L	I	C	:	▲	:			
E	d	i	t		i	n	f	o	.	P	r	e	s	s		R	E	T	U	R	N	.

- Press RETURN (**↵**). The addressee's name will now have its own special "local" format: italic, underlined characters.

We wish to print one copy of this label to attach to our package.

Sample To print the label:

- Press . The print options menu will be displayed.
- To print one copy with standard settings, change the setting of "# of copies" to one, and press RETURN (**↵**).

<p>Imports, Inc. 29 South Main Street Malden, CT 00722 Attn: <i>Mr. Bill Reynolds</i></p>

STORAGE SHELF LABEL EXAMPLE

In this final practice session, we will make a storage shelf label. Assume, for this session, that you work in a parts warehouse, and must make a shelf label which gives information concerning the parts stocked above. This type of complex label -- with several blocks of text, local formatting, numbering fields, and barcode information -- will allow us to practice several of the P-TOUCH XL's more advanced features. Our final label will appear as follows:

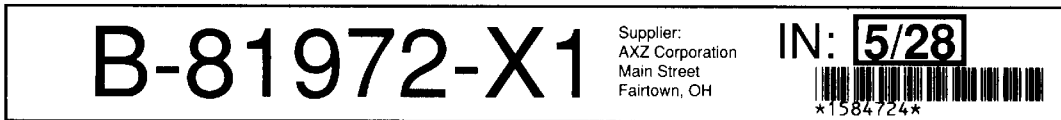

First, we must enter the label's basic text. It should be noted that style changes within a single line (for example, non-framed to framed, or normal type to bold) require local formatting. Changes in the number of lines require block returns. Each time the number of lines changes, a new block of text must be created. The above label can be considered as having three distinct parts.

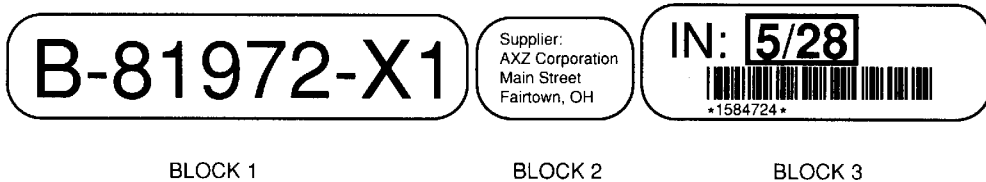

In this practice session we will study these often-used local formatting and multi-block handling features, as well as more specialized features such as barcoding and count-up.

Sample To input the first block of text:

• Press +

F	M	T	◀	B	▶	B	:	A	U	T	:	N	O	R	M	A	L	:	:	▲
1	:																			

STORAGE SHELF LABEL EXAMPLE (continued)

- Type "B-81972-X1".

Note: If you have any questions about basic input or editing, please review the previous examples or see "For Your Information."

F	M	T	◀	B	▶	B	:	A	U	T	:	N	O	R	M	A	L	:	:	▲
1	:	B	-	8	1	9	7	2	-	X	1									

We now want to change from a one-line to a four-line block. In this case, we do not use a regular return; instead, we use the NEW BLOCK key. A detailed explanation of multi-block labels can be found in the Inputting section of "For Your Information."

Sample To input the remaining text:

- Press **CODE** + **NEW BLOCK** .

Note: A block return mark appears at the end of block 1's last (and only) line. The new line is also labelled 1, meaning it is the first line of its block.

1	:	B	-	8	1	9	7	2	-	X	1	⏏								
1	:	_																		

- Type "Supplier:" and press RETURN (↵).

Note: The mark for this line return has no box around it while the block return mark was framed.

1	:	S	u	p	p	l	i	e	r	↵										
2	:	_																		

- Type "AXZ Corporation" and press RETURN (↵).
- Type "Main Street" and press RETURN (↵).

STORAGE SHELF LABEL EXAMPLE (continued)

Sample To enter the bar code data:

- Type our code, "1584724".

B	A	R	C	O	D	E			C	O	D	E	3	9					
▶	*	1	5	8	4	7	2	4	*	◀									

- Press RETURN.

1	:	I	N	:		5	/	2	8	↵									
2	:	◀		_															

To move the cursor quickly from block to block, the ◀BLOCK and BLOCK▶ keys can be used. A detailed explanation of their operation can be found in the Cursor Movement section of "For Your Information."

Our basic message is finished, so we can now consider its format. As we saw in the previous practice exercise, two types of formats exist; global and local. Global formats determine style settings for labels as a whole. Local settings, though, allow you to change the size, style, font, etc. of certain groups of characters within a message. This local formatting is particularly useful for highlighting important portions of text so that they stand out to the reader. A detailed explanation of these two format types can be found in the Formatting section of "For Your Information."

Sample To change to Format A:

- Press **CODE** + **FORMAT**.

ALT CAPS INS ⏴ FONT ⏵ SIZE STYLE A [A]

F	M	T	◀	B	▶	B	:	A	U	T	:	N	O	R	M	A	L	:	:	:	▲
A	U	T	:	C	E	N	T	E	R	:	B	O	T	T	O	M	:	:	:	:	

LENGTH HORIZONTAL VERTICAL ALIGNMENT [ABC] [ABC] [VBC]

- Press ▲ and ▼ until FMT A is displayed.

ALT CAPS INS ⏴ FONT ⏵ SIZE STYLE A [A]

F	M	T	◀	A	▶	A	:	A	U	T	:	N	O	R	M	A	L	:	:	:	
A	U	T	:	L	E	F	T	:			:	B	O	T	T	O	M	:	:	:	

LENGTH HORIZONTAL VERTICAL ALIGNMENT [ABC] [ABC] [VBC]

STORAGE SHELF LABEL EXAMPLE (continued)

- Press RETURN (↵).

1	:	I	N	:	5	/	2	8	↵										
2	:	◀		_															

Format A will now be applied globally to all text in our label. However, we would like to emphasize the date these parts were received; their "IN" date. To do so, we will create a local format, changing the date's characters to bold style, and placing a frame around them.

Sample To emphasize the IN date:

- Press **CODE** + **BLOCK** (↵). The cursor moves to the first character of the current block.

4	:	F	a	i	r	t	o	w	n	,	0	H	□						
1	:	I	N	:	5	/	2	8	↵										

- Press **▶** until the cursor is positioned under the 5, the first character for local formatting.

4	:	F	a	i	r	t	o	w	n	,	0	H	□						
1	:	I	N	:	5	/	2	8	↵										

- Press **CODE** + **LOCAL FORMAT** (↵).

Note: The 5 will flash, signifying that it will be included in the local formatting field.

S	E	L	E	C	T	F	I	E	L	D	.	P	R	E	S	S	↵	.	
1	:	I	N	:	5	/	2	8	↵										

STORAGE SHELF LABEL EXAMPLE (continued)

- Press **▶** until the cursor is under the 8, the last character for local formatting. Press RETURN (**↵**).

L	O	C	A	L	A	:	A	U	T	:	N	O	R	M	A	L	:	:
1	:	I	N	:	5	/	2	8	↵									

- Press **▶** until the character style setting (now set to NORMAL) is flashing.
- Use **▲** and **▼** until BOLD is displayed.

L	O	C	A	L	A	:	A	U	T	:	B	O	L	D	:	:	
1	:	I	N	:	5	/	2	8	↵								

- Press **▶** until the Framing (**A**) field is flashing. Turn framing On.

L	O	C	A	L	A	:	A	U	T	:	B	O	L	D	:	:	▲
1	:	I	N	:	5	/	2	8	↵								

- Press RETURN (**↵**). The characters "5/28" will now have their own special "local" format: bold style and framing.

4	:	F	a	i	r	t	o	w	n	.	O	H	☐					
1	:	I	N	:	F	5	/	2	8	☐	↵							

Next, we will practice using the P-TOUCH XL's numbering function. This feature is particularly useful for serial numbers and other codes which require sequential numbering. In this example, let's assume that "X1" in our parts code represents the first carton of a shipment. Let's also assume that, for quality control purposes, we assign a different parts code for each carton, while the bar code information remains the same. The second carton would be called -X2, the third -X3, etc.

STORAGE SHELF LABEL EXAMPLE (continued)

With the numbering feature, the numbers or letters included in the field will automatically increase after printing. A detailed explanation of this function can be found in the Advanced Features section of "For Your Information."

Sample To make "1" a numbering field:

- Press **CODE** + **HOME**. The cursor will move to the first character of the label.

F	M	T	◀	A	▶	A	:	A	U	T	:	N	O	R	M	A	L	:	:	
1	:	B	-	8	1	9	7	2	-	X	1									

- Press ▶ until the cursor is positioned under the last "1" in the parts code.
- Press **CODE** + **NUMBER**. The character will flash.
This is the only character we wish to automatically increase. Therefore:
- Press RETURN (↵).

F	M	T	◀	A	▶	A	:	A	U	T	:	N	O	R	M	A	L	:	:	
1	:	8	-	8	1	9	7	2	-	X	1	N								

Now we can review some of the memory functions of the P-TOUCH XL.

Sample To store the text file for future use:

- Press **CODE** + **STORE**.
- Type "81972" and press RETURN (↵). The text is saved as "81972" and can be recalled at any time.

STORAGE SHELF LABEL EXAMPLE (continued)

- Press **CODE** + **CLEAR** . The text file disappears from the working area.
- Press **RETURN** .

F	M	T	◀	A	▶	A	:	A	U	T	:	N	O	R	M	A	L	:	:
1	:																		

Sometimes, when a file is no longer used, you will want to delete it from the P-TOUCH XL's memory.

Sample To delete a previous text file from the memory:

- Press **CODE** + **M.DEL** .

C	H	O	O	S	E	F	I	L	E	F	O	R	D	E	L	E	T	I	O	N				
8	1	9	7	2						:	B	-	8	1	9	7	2	-	X	N	I	N	A	X

Assume we no longer need the file "COPIER" and wish to delete it. Therefore:

- Press **▲** and **▼** until COPIER is displayed. Press **RETURN** (**↵**).

O	K	T	O	D	E	L	E	T	E	?													
C	O	P	I	E	R					:	P	L	a	c	e	o	r	i	g	i	n	a	l

- Press **RETURN** (**↵**) again.

Note: If we did not wish to delete this file, we could press **CANCEL** to escape.

F	M	T	◀	A	▶	A	:	A	U	T	:	N	O	R	M	A	L	:	:
1	:	_																	

Now let's print the storage shelf label we just created.

STORAGE SHELF LABEL EXAMPLE (continued)

Sample To recall our file:

- Press +

C	H	O	O	S	E	F	I	L	E	F	O	R	R	E	C	A	L	L		
8	1	9	7	2		:	B	-	8	1	9	7	2	-	X	N	1	N	A	X

- Since the currently displayed choice is our desired file, press RETURN (↵). The storage shelf label file returns to the working area, where we can edit or print it.

F	M	T	◀	A	▶	:	A	U	T	:	N	O	R	M	A	L	:	:		
1	:	B	-	8	1	9	7	2	-	X	N	1	N							

To print the label:

- Press . The print options menu will be displayed.
- To print one copy with standard settings press RETURN (↵).

Note: If you want to print labels "-X1", "-X2", and so on, up to "-X5", press ▶ until the numbering increases setting flashes, press ▲ and ▼ until 5 is displayed, and press RETURN.

Congratulations! This completes the third and final practice session in "Learning the Ropes." We hope that these exercises -- which cover most of the P-TOUCH XL's features -- have been both educational and enjoyable. If you wish, you can now go back and repeat any of these exercises, practice on your own, or begin making actual labels. If you ever have questions about particular operational points, please turn to the "For Your Information" section of this manual.



**FOR YOUR
INFORMATION**

INTRODUCTION

In "For Your Information" you will find detailed explanations of all the P-TOUCH XL's features. Each concept is given its own page, making this reference section easy to use.

Operational examples of most features can also be found in the "Learning the Ropes" practice sessions. If you are a first time P-TOUCH XL user, we suggest that you work through those learning exercises before starting to make labels on your own.

This "For Your Information" section provides systematic, supplementary information. When you have a question about a particular point, locate that topic in the "Finding Your Way" contents list, and turn to the noted page.

FINDING YOUR WAY

This "For Your Information" reference guide is divided into seven operation groups, each of which encompasses several specific topics. The following list shows which points will be covered in this reference guide.

INPUTTING	PAGE		
Power Switch	40	Style	64
The Cursor	41	Underline	66
Shift, Alt, & Caps	42	Framing	67
The Code Key	43	Length	68
Symbols	44	Horizontal Alignment	69
Composite Characters	45	Vertical Alignment	70
Return	46	Vertical Printing	71
New Block	48	Tape Width Printing	72
Numbering	49	Mirror Printing	73
Tagging	51	Global Formats	74
Cancel	52	Local Formats	76
CURSOR MOVEMENT	53	MEMORY	
 		Store	78
EDITING		Recall	79
Insert vs. Overwrite	54	M.Delete	81
Backspace	56	 	
Line Out	57	PRINTING & TAPE FEED	82
Clear	58	 	
 		BARCODING	84
FORMATTING			
Basic Formatting Principles	59		
Format Settings:			
Mode Indicators	60		
Font	61		
Size	62		

POWER SWITCH

BACKGROUND

The P-TOUCH XL's power switch is located on the left-hand side of the machine. When the power is turned on, the previous work session's information is displayed.

The machine's internal memory retains the last message created, and displays it when you turn on the machine. This automatic back-up feature allows you to stop work on a message, turn off the machine, and return to it later without having to re-enter the message.

Note: The P-TOUCH XL protects your work from power loss. Even if the machine is unplugged, and optional batteries are not inserted, all data in the machine's memory will be retained for approximately two weeks. If no power is provided after two weeks, though, all text and formats in the memory will be lost.

If you want to keep all text and formats in the memory for more than two weeks, please plug in the machine and leave the power switch turned on.

Note: The power switch can also be used to "re-set" the P-TOUCH XL.

This re-set function is useful in two situations:

- 1) To clear all text files and formats from the machine's memory.
- 2) To return the machine to usable status if it has hung up.

TO RE-SET THE MACHINE:

Turn the power off.

Holding CODE and the "R" key, turn the power back on.

Since all text files and formats will be cleared from the P-TOUCH XL's memory, this should only be done as a last resort.

BACKGROUND

The P-TOUCH XL has two different types of cursors.

The first, which resembles an underline, marks your current position in the text. Its operation is nearly identical to that of cursors in typewriters or word processors. You can review and edit different parts of your message by moving the cursor backwards and forwards, up and down. Eight keys (◀, ▶, ▲, ▼, ◀BLOCK., BLOCK▶, HOME, and END) let you move the cursor. Their operations are explained in the Cursor Movement section.

While the text cursor is used to mark or select points in text messages, another sort of cursor allows you to choose characters and various settings. When an item flashes (or is highlighted), that item is presently "active". For example, if BOLD is flashing on the format display, bold characters are the current text style. Also, when selecting text fields for numbering or local formatting, characters currently selected will flash.

Both of these cursors -- the text cursor for pointing and the flashing cursor for choosing -- help you create, view, and edit label messages.

EXAMPLES

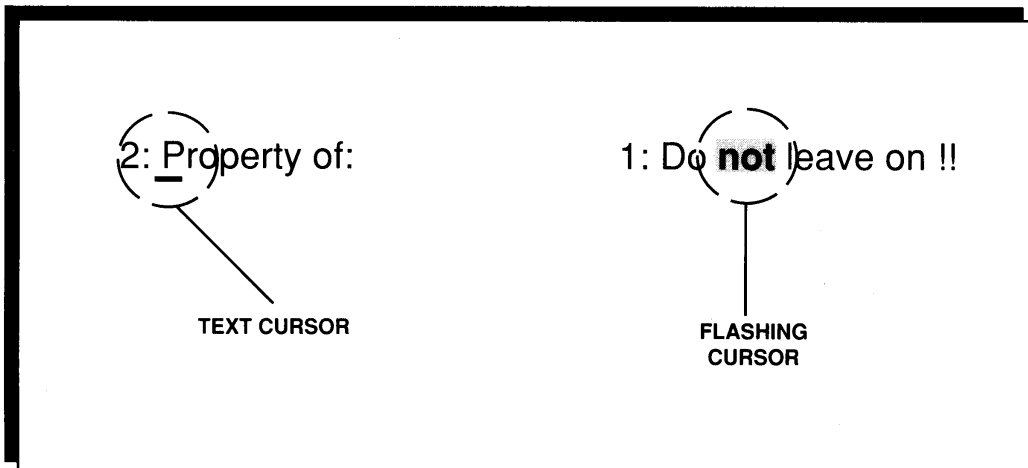

SHIFT, ALT, & CAPS

BACKGROUND

Most characters can be input simply by pressing their keys. However, to enter upper case letters, accented characters, and the most common symbols, three special keys are necessary.

SHIFT KEY: Allows you to type capital letters, and symbols located on the upper part of keys. To type a capital "A", hold down the SHIFT key and press the "A" key.

CAPS KEY: The SHIFT key is very useful for inputting a single capital letter; for example, at the beginning of a name. However, when you wish to enter a series of capital letters, the CAPS key should be used.

TO ENTER CAPS MODE: Hold down CODE and press the CAPS key.

When this mode is on, the CAPS indicator on the LCD display turns on:

Note: When CAPS Mode is on, using the SHIFT key will result in lower-case letters.

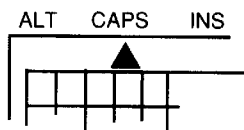

In CAPS Mode, upper-case letters can be typed simply by pressing the character keys (i.e. SHIFT is not necessary). However, when number keys are pressed, numbers -- not the symbols above them -- result. To exit CAPS Mode, press the CODE key and the ALT key again. The indicator will release the ALT key.

ALT KEY: The ALT key allows you to input characters and symbols located on the right side of keys.

TO ENTER A CHARACTER ON A KEY'S RIGHT SIDE:

Hold down the ALT key and press the key which has a character on its right side. When you hold down the ALT key, the ALT indicator on the LCD turns on.

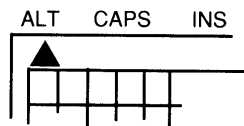

BACKGROUND

While the SHIFT, CAPS, and ALT keys allow you to select various characters and symbols, the CODE key allows you to choose various functions and modes. Functions and modes written in green require the CODE key for selection.

EXAMPLES

TO USE THE MEMORY RECALL FUNCTION:

- Press the CODE key + .

TO ENTER SYMBOL MODE:

- Press the CODE key + .

SYMBOLS

BACKGROUND

The P-TOUCH XL has many special marks and symbols that can be entered into your text message. When entered, they act like normal characters and can be both edited and deleted.

Though several symbols can be found on the P-TOUCH XL's key tops, additional special marks are available in Symbol Mode.

OPERATION

TO ENTER A NON-KEY TOP SYMBOL:

- (1) Press the CODE key & the Symbol key to enter Symbol Mode.
- (2) Press ▲ and ▼ until the symbol you wish to enter appears on the display.
- (3) Press ► and ◀ until that symbol flashes.
- (4) Press RETURN (↵) to enter that symbol into your message.

LIST

S	Y	M	B	O	L	:	↑	↓	→	←	↖	↗	↘	↙	↕	↔	↕	↓	{	}	<	>	•
S	Y	M	B	O	L	:	®	©	™	★	●	○	□	♥	♠	♣	♣	♣	♣	♣	♣	♣	♣
S	Y	M	B	O	L	:	♠	♣	♣	♣	♣	♣	♣	♣	♣	♣	♣	♣	♣	♣	♣	♣	♣
S	Y	M	B	O	L	:	☐	☐	☐	☐	☐	☐	☐	☐	☐	☐	☐	☐	☐	☐	☐	☐	☐
S	Y	M	B	O	L	:	AS	Pts	f	Kr	FM	in	ft	mm	cm	km	gm	oz	lb	cc	ℓ	°F	°C
S	Y	M	B	O	L	:	2	3	4	5	6	7	8	9	α	β	γ	δ	μ	£	æ	€	€
S	Y	M	B	O	L	:	°	°	Å	ä	ij	ø	ø	ø	ø	P	p						

COMPOSITE CHARACTERS

BACKGROUND

In non-English alphabets, composite characters, consisting of a letter and a diacritical mark, are often used. These characters can be entered on the P-TOUCH XL. The diacritical marks available are “, ` , ´, ^, ~.

Several composite characters can be found on the key tops. Characters such as e, a, and n can be entered in the same way as other characters. Before inputting a composite character in the method described below, check whether it is already available as a key-top character.

DIACRITICAL MARK	LETTERS WHICH CAN BE JOINED
“	A E I O U a e i o u y
`	A E I O U a e i o u
´	A E I O U a e i o u
^	A E I O U a e i o u
~	A N O a n o

OPERATION

TO INPUT A COMPOSITE CHARACTER:

- (1) Enter the diacritical mark needed for the composite character.
- (2) Type the letter you wish to join with it. The entered mark and character will flash on the LCD display, and will be joined when printed.

Notes: If the letter cannot be combined with the diacritical mark (see above chart), the letter will take the place of the mark.

If you press a cursor movement key or the PRINT key after inputting the diacritical mark, nothing will happen. To continue inputting your message, you must either enter a character or delete the mark with the Cancel key or the Backspace key.

NEW BLOCK

BACKGROUND

Any time the number of lines in a label changes, a new block must be created. These blocks are different from local formatting, though, which changes the type style within a given line or groups of lines.

Compare these two labels:

AXZ CORP. (052)824-2755

This is simply a single-block, single-line label with local formatting. After all text has been typed, the portion "(052) 824-2755" is assigned a smaller character size.

B-819	Supplier:	IN: 5/28
	AXZ Corporation	OUT: 6/13
	Main Street	
	Fairtown, OH	

This is a multi-block label. The first portion of this label is a single line, the second, four lines, and the third, two. Therefore, when entering such a text message, the New Block key must be used.

After typing the first block of text, press the CODE key and the New Block key. A block return mark (▣) will appear on the LCD display.

Notes: The maximum number of blocks in a single label is ten. If the cursor is located in block 10 and you press CODE and the New Block key, an error message will appear.

In Insert Mode, when the cursor is positioned in the middle of a text block, pressing CODE and New Block causes the current block to be split into two. A block return mark will be added at the cursor location, and subsequent lines will be re-numbered.

OPERATION

TO ENTER THE TEXT FOR THE LABEL

TOMMY	CLASS 2	:
	ROOM 104	

- (1) Type "TOMMY".
- (2) Since the next portion of text is a new, two-line block, press CODE and the New Block key.
- (3) Type "CLASS 2".
- (4) Press RETURN (↵).
- (5) Type "ROOM 104".

BACKGROUND

The P-TOUCH XL's numbering feature allows you to designate a group of numbers and letters as a "numbering" field. When a label is printed, the numbers and letters included in the field automatically increase by one. For example, 124 becomes 125. This type of automatic incrementation is very useful for printing serial number labels, production control labels, or other labels requiring ascending codes.

OPERATION

TO DESIGNATE A PORTION OF TEXT AS A NUMBERING FIELD:

- (1) Position the cursor under the first character (number or letter) you wish to include.
- (2) Press the CODE key and the NUMBER key. The character will flash, indicating it is "active."
- (3) Use **▶** and **◀** to move the cursor to the last character you wish to include. All characters between it and the first character will also flash.
- (4) Press RETURN. The previously flashing characters will be included in the numbering field. Numbering marks (**№**) will appear on the display, surrounding the numbering field.
- (5) Press the Print key. The print settings selection menu will appear.
- (6) Press **▶** until the numbering increases setting flashes.
- (7) Press **▲** and **▼** until your desired setting is displayed. If you want to count up the number from 10 to 15, set the numbering increases to "6". (10, 11, 12, 13, 14, 15 = 6)
- (8) Press RETURN.

NOTES

- In any text message, only one numbering field can be created.
- The maximum number of characters in a numbering field is ten. If you try to choose more than ten characters, or try to insert an additional character into a ten-long field, an error message will appear.
- A numbering field must be located entirely within one line of text. If you try to include a return mark or block return mark in the numbering field, an error message will flash.

NUMBERING (continued)

- If one of the numbering marks is deleted, both disappear, and the numbering field is treated as regular text.
- When the cursor is positioned under the second numbering mark, even if Overwrite Mode is on, any entered characters will be inserted into the numbering field (i.e. the mark is not replaced). When under the first, characters will be entered before the numbering field.
- Only letters and numbers can be automatically incremented. They will change in the following orders:

0	→	1	→	9	→	0	→
A	→	B	→	Z	→	A	→
a	→	b	→	z	→	a	→

- Spaces can be used to adjust the number of digits printed:

$\overline{N}0N$	0 - 1 -	9 - 0 -
$\overline{N} 0N$	0 - 1 -	99 - 0 -
$\overline{N}A0N$	A0 - A1 -	A9 - B0 -

Spaces between numbering characters simply adjust the space between them on printed labels:

$\overline{N} 1 2 3 N$ 1 2 3 → 1 2 4

- Non-alpha-numeric characters within the numbering field are printed, but are not changed or incremented in any way.

CURSOR MOVEMENT

BACKGROUND

After you have created a message, moving the cursor allows you to view or edit the text. While the cursor can actually move left and right within a line, it never leaves the bottom line of the LCD display. When up and down arrow keys are pressed, the cursor remains on the LCD's bottom line while the text scrolls as commanded.

 In general, pressing this key moves the cursor one space to the left. If the cursor is positioned under the first character of a line and this key is pressed, the cursor moves to the end of the previous line.

Pressing CODE and this key makes the cursor move to the first character of the current text block. If they are pressed again, the cursor moves to the first character of the previous block.

 In general, pressing this key moves the cursor one space to the right. If the cursor is positioned at the end of a line and this key is pressed, the cursor moves to the beginning of the next line.

Pressing CODE and this key makes the cursor move to the first character of the next text block.

 Pressing this key moves the cursor to the first character of the previous line.

If a tag exists between the cursor and the first character of the message, pressing CODE and this key moves the cursor to the previous tag. Otherwise, the cursor moves directly to the first character of the entire message.

 Pressing this key moves the cursor to the first character of the next line.

If a tag exists between the cursor and the last character of the message, pressing CODE and this key moves the cursor to the next tag. Otherwise, the cursor moves directly to the last character of the entire message.

INSERT VS. OVERWRITE

BACKGROUND

During text editing, two different character entry modes exist:

- **INSERT MODE**

The P-TOUCH XL normally operates in Insert Mode. This allows you to insert characters into the middle of your message. Characters are inserted at the location of the cursor, and all characters following the insertion move one space to the right.

TO ENTER INSERT MODE:

Hold down CODE and press the INSERT key until the LCD display's "INS" indicator lights.

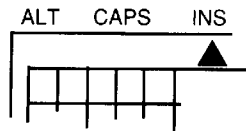

- **OVERWRITE MODE**

The P-TOUCH XL can also operate in Overwrite Mode. This allows you to change characters simply by typing new ones in their place.

TO ENTER OVERWRITE MODE:

Hold down CODE and press the INSERT key until the LCD display's "INS" indicator goes off.

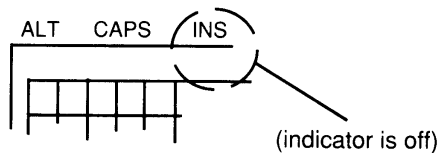

EXAMPLES

INSERT MODE

1:	A	X	Z		C	o	r	p	o	r	a	t	i	o	n	↓				
2:	2	4	7		M	a	i	n		S	t	r	e	e	t					

Type "East" and add a space.

1:	A	X	Z		C	o	r	p	o	r	a	t	i	o	n	↓				
2:	2	4	7		E	a	s	t		M	a	i	n		S	t	r	e	e	t

OVERWRITE MODE

1:	A	X	Z		C	o	r	p	o	r	a	t	i	o	n	↓				
2:	2	4	7		E	a	s	t		M	a	i	n		S	t	r	e	e	t

Type "We".

1:	A	X	Z		C	o	r	p	o	r	a	t	i	o	n	↓				
2:	2	4	7		W	e	s	t		M	a	i	n		S	t	r	e	e	t

BACKGROUND

The Line Out key allows you to remove an unwanted line of text from your message. Any return marks, symbols, tag or numbering marks are also deleted.

OPERATION

TO DELETE A LINE OF TEXT:

- (1) Using the cursor movement keys, position the cursor in the line you want to delete.
- (2) Press CODE and the Line Out key.

EXAMPLES

General operation:

1	:	A	X	Z		C	o	r	p	o	r	a	t	i	o	n	↓						
2	:	2	4	7		M	a	i	n		S	t	r	e	e	t							

Press CODE and the Line Out key.

1	:	A	X	Z		C	o	r	p	o	r	a	t	i	o	n	↓						
2	:	_																					

If the cursor is positioned in a line with a block return mark (␣), the mark remains:

1	:	A	X	Z		C	o	r	p	o	r	a	t	i	o	n	↓						
2	:	2	4	7		M	a	i	n		S	t	r	e	e	t	␣						

Press CODE and the Line Out key.

1	:	A	X	Z		C	o	r	p	o	r	a	t	i	o	n	␣						
2	:	_																					

BASIC FORMATTING PRINCIPLES

BACKGROUND

The text you enter, as well as the return and block return marks, are eventually printed as your label. How they are printed, though, is determined by the formats you assign. Formats determine the size and type of text, as well as its alignment and orientation. Two types of formats exist; global and local.

GLOBAL FORMATS

Before, during, or after text entry, you must choose a global format for your label. This is a general format: it is applied to all characters except those assigned a local format (see below). In most cases, your entire message will consist of characters of similar sizes and styles. These all-encompassing style settings are known as a global format.

Note: Detailed information concerning global format creation and editing can be found in the Global Formats section.

LOCAL FORMATS

Every label is assigned a global format: style settings for the entire message. However, you may sometimes wish to give a word or group of words their own special format, emphasizing them through their style. A local format contains information similar to that in a global format, but is applied only to a specially selected group of characters within a message.

Notes: Detailed information concerning local format creation and editing can be found in the Global Formats section.

On pages 60 to 73 various format settings are explained. In the top left-hand corner of each page is an LCD display diagram showing where the particular setting can be found. In the top right-hand corner you can find whether the format setting can be assigned in global formatting, local formatting, or both.

MODE INDICATORS

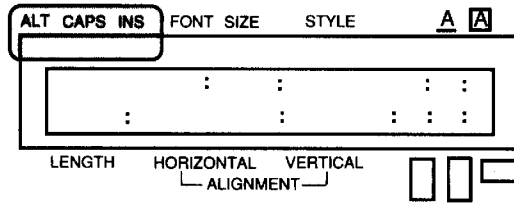

BACKGROUND

Mode indicators (ALT, CAPS, and INS) are different from other LCD display items. These three indicators are not used to assign or edit character style settings; instead, they are used to turn various character input modes on or off.

- ALT (▲)** When character keys are pressed, letters and symbols on the keys' right-hand sides are inputted.
() When character keys are pressed, letters and symbols on the keys' left-hand sides are inputted.
- CAPS (▲)** When letter keys are pressed, upper-case characters are inputted. When number keys are pressed, the numbers -- not the symbols above -- are entered.
() When letter keys are pressed, lower-case characters are inputted.
- INS (▲)** Characters typed are added into the middle of the message at the cursor's location.
() Characters typed replace, or overwrite, the original text.

OPERATION

TO CHANGE THESE MODE INDICATORS FROM OFF TO ON, OR ON TO OFF:

- For CAPS and INS, press CODE and the appropriate key.
- For ALT, HOLD DOWN the ALT key.

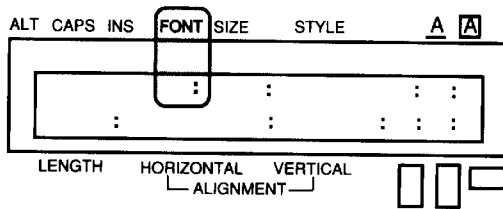

ASSIGNABLE IN:
Local Formatting
Global Formatting

BACKGROUND

Three different typefaces, or fonts, are available on the P-TOUCH XL. They are:

Font A
Font B
Font C

OPERATION

TO SELECT A FONT:

After entering Format or Local Format Mode;

- (1) Press **▶** until the FONT field flashes.
- (2) Press **▲** and **▼** until the font you wish to use is displayed.
- (3) Press RETURN (**↵**).

EXAMPLES



SIZE

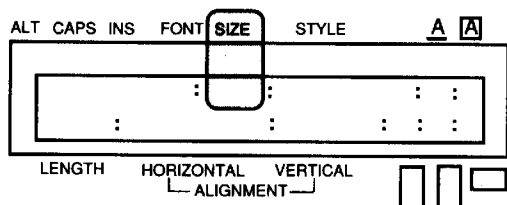

ASSIGNALBE IN:

Local Formatting

Global Formatting

BACKGROUND

Basically, two character size setting methods exist. Usually, you will probably want to use the largest characters possible for the given tape and message. With "Auto" size, the P-TOUCH XL compares your inputted message with the tape size, and automatically uses the largest characters possible. Sometimes, though, you will want to assign a character size regardless of tape width or message length. To do so, six point sizes are available, and each can be printed in narrow, medium, or wide characters. Available sizes are:

10, 13, 19, 26, 38, & 44 points [all can be narrow (N), medium (M), or wide (W)]

+ Auto (AUT)

OPERATION

TO SELECT A SIZE:

After entering Format or Local Format Mode;

- (1) Press **▶** until the SIZE field flashes.
- (2) Press **▲** and **▼** until the size you wish to use is displayed.*
- (3) Press RETURN (**←**).

***Note:** To avoid scrolling through size choices, AUT can be selected easily by pressing the space bar.

EXAMPLES

	Wide	Medium	Narrow
44 pt	ABC	ABC	ABC
38 pt	ABC	ABC	ABC
26 pt	ABC	ABC	ABC
19 pt	ABC	ABC	ABC
13 pt	ABC	ABC	ABC
10 pt	ABC	ABC	ABC

STYLE

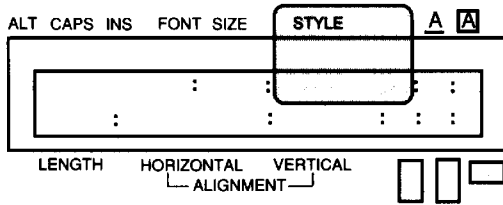

ASSIGNABLE IN:
Local Formatting
Global Formatting

BACKGROUND

A total of ten character styles are available: six single styles and four combinations. They are:

NORMAL	ITA+OUT (Italic & Outline)
OUTLINE	ITA+BOLD (Italic & Bold)
BOLD	ITA+SHD1 (Italic & Shadow 1)
SHADOW 1	ITA+SHD2 (Italic & Shadow 2)
SHADOW 2	
ITALIC	

Note: When you use the small point characters, some style settings (e.g. Italic + Shadow2) may result in hard-to read print.

OPERATION

TO SELECT A STYLE:

After entering Format or Local Format Mode;

- (1) Press **▶** until the STYLE field flashes.
- (2) Press **▲** and **▼** until the style you wish to use is displayed.
- (3) Press RETURN (**↵**).

EXAMPLES

	NORMAL	OUTLINE	BOLD	SHADOW1	SHADOW2
A FONT	ABCDE	ABCDE	ABCDE	ABCDE	ABCDE
B FONT	ABCDE	ABCDE	ABCDE	ABCDE	ABCDE
C FONT	<i>Abcde</i>	<i>Abcde</i>	<i>Abcde</i>	<i>Abcde</i>	<i>Abcde</i>
	ITALIC	ITA + OUT (Italic + Outline)		ITA + BOLD (Italic & Bold)	
A FONT	<i>ABCDE</i>	<i>ABCDE</i>		<i>ABCDE</i>	
B FONT	<i>ABCDE</i>	<i>ABCDE</i>		<i>ABCDE</i>	
C FONT	<i>Abcde</i>	<i>Abcde</i>		<i>Abcde</i>	
	ITA + SHD1 (Italic & Shadow1)			ITA + SHD2 (Italic + Shadow2)	
A FONT	<i>ABCDE</i>			<i>ABCDE</i>	
B FONT	<i>ABCDE</i>			<i>ABCDE</i>	
C FONT	<i>Abcde</i>			<i>Abcde</i>	

UNDERLINE

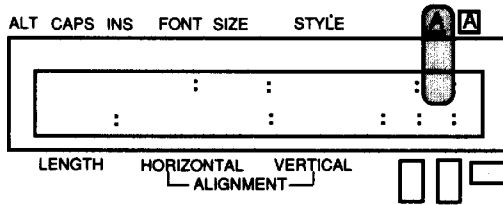

ASSIGNABLE IN:

Local Formatting

Global Formatting

BACKGROUND

Characters in your message can be printed with or without underlines. This is true on both a global level (all characters in a message) and a local level (selected groups of characters). When underline is on (▲), characters will be underlined.

OPERATION

TO CHANGE THE UNDERLINE MODE INDICATOR FROM OFF TO ON, OR ON TO OFF:

After entering Format or Local Format Mode;

- (1) Press **▶** until the UNDERLINE (▲) field flashes.
- (2) Press **▲** and **▼** until your desired setting is displayed. (The **▲** symbol indicates that the underline function is on)
- (3) Press RETURN (**↵**).

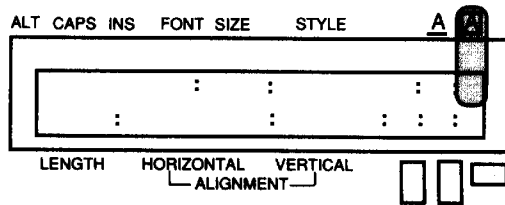

ASSIGNABLE IN:
Local Formatting
Global Formatting

BACKGROUND

Characters in your message can be boxed, or framed: a rectangle is drawn around the selected characters. This is true on both a global level (all characters in a message) and a local level (selected groups of characters). When framing is on (▲), characters will be framed.

OPERATION

TO CHANGE THE FRAMING MODE INDICATOR FROM OFF TO ON, OR ON TO OFF:

After entering Format or Local Format Mode;

- (1) Press **▶** until the FRAMING (**A**) field flashes.
- (2) Press **▲** and **▼** until your desired setting is displayed. (The **▲** symbol indicates that the framing function is on.)
- (3) Press RETURN (**↵**).

LENGTH

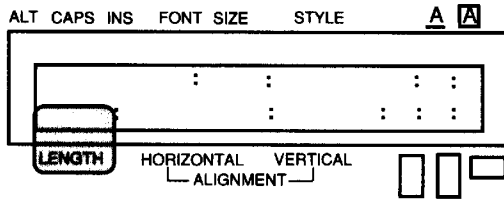

ASSIGNABLE IN:
Local Formatting X
Global Formatting O

BACKGROUND

Basically, two label length setting methods exist. With "Auto" length, the P-TOUCH XL compares your inputted message with the tape size, and automatically adjusts the label length to fit your message. Sometimes, though, you will want to assign a label length regardless of message size. The label length can be set from 2.0 to 12.0 inches. The scrolling sizes are:

AUTO 2.0 2.1 12.0 AUTO

OPERATION

TO SELECT A TAPE LENGTH:

After entering Format Mode;

- (1) Press **▶** until the LENGTH field flashes.
- (2) Press **▲** and **▼** until the length you wish to use is displayed.
- (3) Press RETURN (**↵**).

Notes: To avoid scrolling through length choices, AUTO can be selected easily by pressing the space bar.

The length setting can only be done globally. It is not available in local formatting.

HORIZONTAL ALIGNMENT

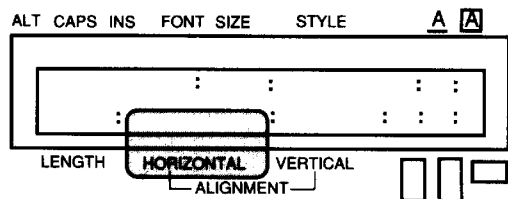

ASSIGNABLE IN:
Local Formatting X
Global Formatting O

BACKGROUND

Characters in the blocks of your message can be horizontally aligned in four ways:

LEFT
CENTER
RIGHT
JSTFY (Justify)

OPERATION

TO SELECT A HORIZONTAL ALIGNMENT:

After entering Format Mode:

- (1) Press **▶** until the HORIZONTAL ALIGNMENT field flashes.
- (2) Press **▲** and **▼** until the horizontal alignment setting you wish to use is displayed.
- (3) Press RETURN (**↵**).

Notes: The horizontal alignment setting can only be done globally. It is not available in local formatting.

When pre-determined length, multi-block messages are assigned the JSTFY setting, the spaces between blocks are adjusted to spread the message to fill the tape.

EXAMPLES

LEFT	CENTER	RIGHT	JSTFY
ABC	ABC	ABC	A B C
DEFGHIJ	DEFGHIJ	DEFGHIJ	DEFGHIJ
KLNOP	KLNOP	KLNOP	K L N O P
G	G	G	G

VERTICAL ALIGNMENT

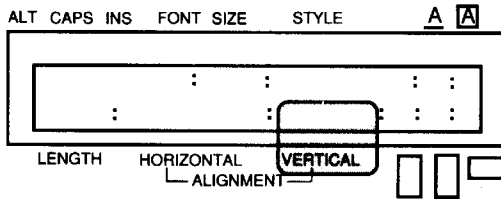

ASSIGNABLE IN:
Local Formatting X
Global Formatting O

BACKGROUND

Characters lines in the blocks of your message can be vertically aligned in three ways:

TOP
CENTER
BOTTOM

OPERATION

TO SELECT A VERTICAL ALIGNMENT:

After entering Format Mode;

- (1) Press **▶** until the VERTICAL ALIGNMENT field flashes.
- (2) Press **▲** and **▼** until the vertical alignment setting you wish to use is displayed.
- (3) Press RETURN (**↵**).

Note: The vertical alignment setting can only be done globally. It is not available in local formatting.

EXAMPLES

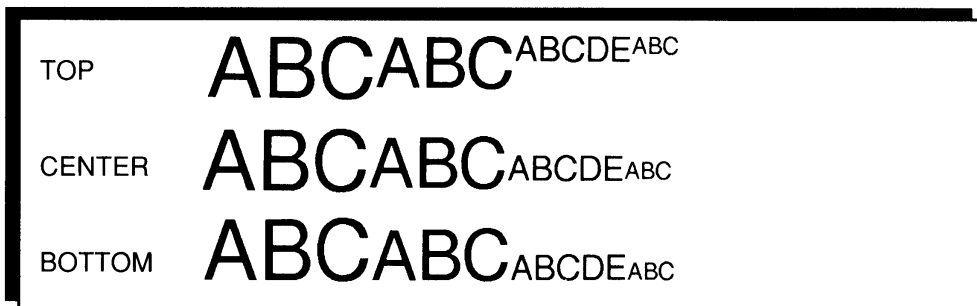

VERTICAL PRINTING

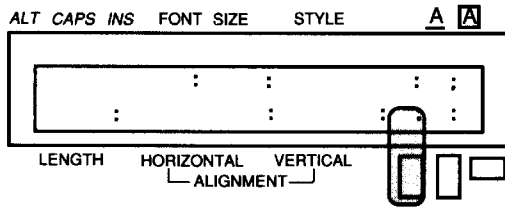

ASSIGNABLE IN:
Local Formatting X
Global Formatting O

BACKGROUND

Characters in your message can be printed in a vertical orientation. When vertical printing (A A) is on, messages will be printed vertically.

OPERATION

TO CHANGE THE VERTICAL PRINTING INDICATOR FROM OFF TO ON, OR ON TO OFF:

After entering Format Mode;

- (1) Press **▶** until the vertical printing field flashes.
- (2) Press **▲** and **▼** until your desired setting is displayed. (The **▲** symbol indicates that the vertical printing function is on.)
- (3) Press RETURN (**↵**).

Note: Limitations in Vertical Mode.

- 3 lines max. (on 1" tape)
- 1 line at max. (on 3/4", 1/2", 3/8", 1/4" tape)
- Font C, Italic styles and special some characters can not be print in vertical style (on 1/4" tape)

EXAMPLES

LABEL	TEXT
	1:ABC
	1:ABC1 ↵
	2:ABC2 ↵
	3:ABC3

Note: Vertical printing can also be used in conjunction with other printing orientations.

TAPE WIDTH PRINTING

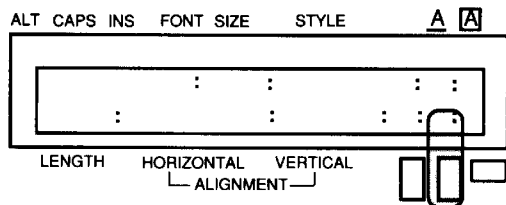

ASSIGNABLE IN:
Local Formatting
Global Formatting

BACKGROUND

Characters in your message can be printed along the width, rather than the length of your tape. When tape width printing () is on, messages will be printed along the tape's width. Of course, space along the width of a tape is quite limited, so only short messages with small characters can be printed.

OPERATION

TO CHANGE THE TAPE WIDTH PRINTING INDICATOR FROM OFF TO ON, OR ON TO OFF:

After entering Format Mode;

- (1) Press **▶** until the tape width printing field flashes.
- (2) Press **▲** and **▼** until your desired setting is displayed. (The **▲** symbol indicates that the tape width printing function is on.)
- (3) Press RETURN (**↵**).

EXAMPLES

LABEL	TEXT
ABCD1	1:ABC1 ↵
ABCD2	2:ABC2 ↵
ABCD3	3:ABC3 ↵
ABCD4	4:ABC4

Note: Tape width printing can also be used in conjunction with other printing orientations.

MIRROR PRINTING

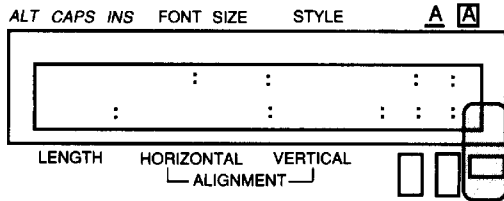

ASSIGNABLE IN:
Local Formatting X
Global Formatting O

BACKGROUND

Your message can be printed in Mirror orientation. When such labels (printed on clear tape) are affixed to glass such as showroom windows, they can be correctly read from the opposite side. When mirror printing () is on, messages will be printed in mirror orientation.

OPERATION

TO CHANGE THE MIRROR PRINTING INDICATOR FROM OFF TO ON, OR ON TO OFF:

After entering Format Mode;

- (1) Press **▶** until the mirror printing field flashes.
- (2) Press **▲** and **▼** until your desired setting is displayed. (The **▲** symbol indicates that the mirror printing function is on.)
- (3) Press RETURN (**↵**).

EXAMPLES

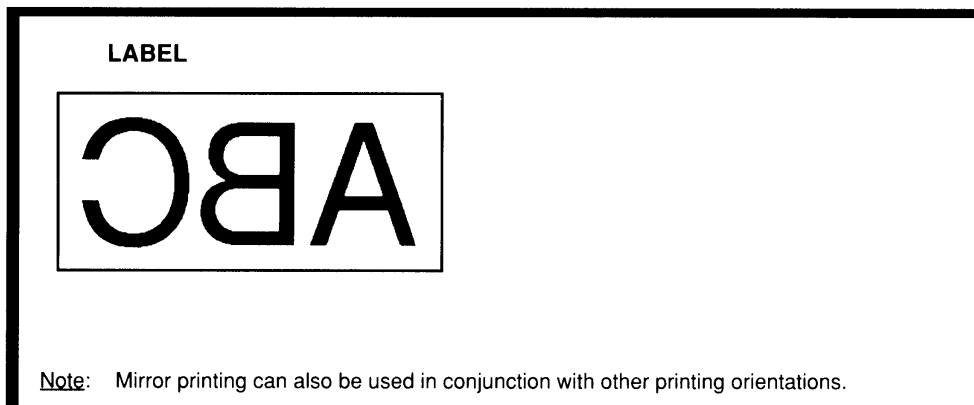

GLOBAL FORMATS

BACKGROUND

Every text message must be given a global format which determines the size, style, and alignment of its characters. All of the LCD display settings -- font, size, style, underline, framing, length, horizontal alignment, vertical alignment, vertical printing, tape width printing and mirror printing -- can be addressed in global formatting. Furthermore, formats can be assigned before, during or after text entry. Therefore, the same text file can be printed in different styles, simply by changing its format. Three different operations exist concerning global formatting: choosing, creating and editing.

CHOOSING is the simplest function. If the format you wish to apply to a text file has already been created, you need only choose it.

CREATING a new format is also very easy.

TO CREATE A NEW FORMAT:

- (1) Press CODE and the Format key. The format screen will appear.
To edit settings:
- (2) Press ► and ◀ until the first setting you wish to change flashes.
- (3) Press ▲ and ▼ until your desired setting is displayed.
- (4) Repeat steps (2) and (3) until all settings are as you wish.
- (5) Press RETURN (←↵).
- (6) Input a new one-letter code for your format. (If a format by that name already exists, a prompt message will appear on the display.) This new format is applied to your text file, and the LCD display returns to Text Entry Mode.

TO CHOOSE A FORMAT:

- (1) Press CODE and the Format key. The format screen will appear.
- (2) If you know the desired format's one-letter code (A to Z), simply input that letter and its format is displayed. If you do not know the desired format's code, scroll through the available formats by pressing ▲ and ▼.
- (3) When your desired format is displayed, press RETURN (←↵). That format is applied to your text file, and the LCD display returns to Text Entry Mode.

EDITING an existing format is very similar. However, if a format is changed, all text files currently assigned to that format will be affected. If printed, they will be in the new, edited format, not the original one. Therefore, if you do not wish to affect your current files, it is better to create a new format than to edit an old one.

TO EDIT A FORMAT:

- (1) Press CODE and the Format key. The format screen will appear.
- (2) If you know the desired format's one-letter code (A to Z), simply input that letter and its format is displayed. If you do not know the desired format's code, scroll through the available formats by pressing ▲ and ▼.
- (3) When your desired format is displayed, press ► and ◀ until the first setting you wish to change flashes.
- (4) Press ▲ and ▼ until your desired setting is displayed.
- (5) Repeat steps (3) and (4) until all settings are as you wish.
- (6) Press RETURN (↵). A prompt message will appear on the display. If it is o.k. to change the format, press RETURN (↵) again.

EXAMPLES

F	M	T	◀	A	▶	A	:	A	U	T	:	N	O	R	M	A	L	:	:	:
A	U	T	O	:	L	E	F	T	:	B	O	T	T	O	M	:	:	:	:	:

AXZ Corporation Main Street Fairtown, OH
--

F	M	T	◀	B	▶	B	:	I	O	M	:	I	T	A	+	B	O	L	D	:	:	▲
4	.	0	:	C	E	N	T	E	R	:	B	O	T	T	O	M	:	:	:	:	:	

AXZ Corporation Main Street Fairtown, OH

LOCAL FORMATS

BACKGROUND

Though every text message must be given a global format, local formats are purely optional. Global formats are general settings which are applied to all characters in the label. Local formats, on the other hand, are special settings, applied only to selected groups of characters, which over-ride the global format information. Local formats are a good way of emphasizing one word or group of words within your message. Only the top line of LCD display settings -- font, size, style, underlining, and framing - - can be addressed in local formatting. Local formats can be assigned during or after text entry. Three different operations exist concerning local formatting: creating, editing and cancelling.

Note: Numbering ranges and bar codes cannot include a local formatting field.

CREATING a local format consists of two steps; choosing the characters to include and setting the format.

TO CREATE A LOCAL FORMAT:

- (1) Position the cursor under the first character you wish to assign a local format.
- (2) Press CODE and the Local Format key. The character will flash.
- (3) Move the cursor until all characters to which you wish to assign the local format are flashing.
- (4) Press RETURN (←↵). The local format screen will appear.
- (5) Press ▶ and ◀ until the first setting you wish to change flashes.
- (6) Press ▲ and ▼ until your desired setting is displayed.
- (7) Repeat steps (5) and (6) until all settings are as you wish.
- (8) Press RETURN (←↵). This local format is applied to the chosen characters, and the LCD display returns to Text Entry Mode.

EDITING of local formats is much like that of global formats.

TO EDIT A LOCAL FORMAT:

- (1) Position the cursor within the local format field.
- (2) Press CODE and the Local Format key. The local format screen will appear.
- (3) Press ▶ and ◀ until the first setting you wish to change flashes.
- (4) Press ▲ and ▼ until your desired setting is displayed.
- (5) Repeat steps (3) and (4) until all settings are as you wish.
- (6) Press RETURN (←↵). The new local format is applied to the chosen characters, and the LCD display returns to Text Entry Mode.

CANCELLING

TO CANCEL A LOCAL FORMAT:

- (1) Position the cursor to the right of either of the two local format marks in the text.
- (2) Press the Backspace key.
- (3) A prompt message will appear on the display. If it is O. K, press RETURN (↵).
- (4) The local format is cancelled, and its marks disappear from your text file.

EXAMPLES

(Global Format)

F	M	T	◀	A	▶	A	:	A	U	T	:	N	O	R	M	A	L	:	:	:
A	U	T	O	:	C	E	N	T	E	R	:	C	E	N	T	E	R	:	:	:

(Local Format)

L	O	C	A	L	:	I	O	M	:	I	T	A	+	B	O	L	D	:	:	▲
3	:	F	a	i	r	t	o	w	n	.	O	H	E	:	:	:	:	:	:	:

(Text File)

1	:	A	X	Z		C	o	r	p	o	r	a	t	i	o	n	↵			
2	:	F	M	a	i	n		S	t	r	e	e	t	↵						

AXZ Corporation

Main Street
Fairtown, OH

(Resulting Label)

STORE

BACKGROUND

The phrase memory Store function can be used to save your most frequently used text messages. Unless you delete that memory file using the Delete function, it will always be accessible; even if you clear the working area by pressing CODE and the Clear key.

When stored, each file is given a name to make recalling easier. The file name can include up to eight characters; spaces cannot be entered. If the P-TOUCH XL's generous phrase memory becomes full, future storage attempts will cause the message "Memory Full" to be displayed. In this case, you must delete an unused text file before storing the current one.

OPERATION

TO STORE A TEXT FILE FOR FUTURE USE:

- (1) Press CODE and the Store key.
- (2) Enter a name up to eight characters (symbols can be entered, but blank spaces cannot).
- (3) Press RETURN (←). The file is saved, and can be recalled at any time for future use.

BACKGROUND

Recall lets you bring copies of stored text files into the working area, where you can edit, re-format, or print. Recalling a file does not remove it from the phrase memory. A copy is used. Therefore, you can recall the same file any number of times without losing it. The only way to be rid of a saved file is to remove it using the Delete function.

When recalling, if some text currently exists in the working area, you must choose whether to replace the working area text with the stored file, or to join them.

OPERATION

TO RECALL A FILE FROM THE PHRASE MEMORY:

- (1) Press CODE and the Recall key. The most recently stored file is displayed (its name and first characters).
- (2) Press ▲ and ▼ until the file you want to recall is displayed.
- (3) Press RETURN (←↵).

Note: If no text was in the working area, the file is now recalled. If some text was in the working area, you will now be asked whether to join the two texts.

To replace the working area text with the recalled file:

- (4) Press ▲ and ▼ until "OFF" is displayed in the "Join Text" selection area.
- (5) Press RETURN (←↵). The stored text file is recalled, and takes the place of the message previously in the working area.

Note: If you choose to join the two texts, the recalled file will be inserted before the cursor. New Block marks will be added before and after the recalled text.

BACKGROUND

Sometimes, previously stored labels are no longer needed. In this case, you can erase the text files from the P-TOUCH XL's phrase memory by using the Delete function.

OPERATION

TO DELETE A FILE FROM THE PHRASE MEMORY:

- (1) Press CODE and the M.DEL key.
- (2) Press ▲ and ▼ until the file you want to delete is displayed.
- (3) Press RETURN. The message "OK TO DELETE?" will be displayed.
- (4) To finish deletion, press RETURN again.
To escape without deleting, press the Cancel key.

PRINTING & TAPE FEED

BACKGROUND

The Print key lets you print the text you have created, in the format you have selected, onto a tape. In Print Mode, five different parameters can be set, allowing you to custom print exactly as you wish.

<u>PARAMETER</u>	<u>POSSIBLE SETTINGS</u>
Auto Tape Cut _____	ON, OFF
Tape Feed _____	FULL (1"), MEDIUM (1/2"), NARROW (1/3"), NONE (1/6")
Copies _____	1 to 99
Numbering Increases —	OFF, 1 to 99
Corner Rounding _____	ON, OFF

AUTO TAPE CUT Determines whether the tape is automatically cut after each copy of the label is printed. A 25-mm lead tape will be produced before the actual label. It can be thrown away.

TAPE FEED The P-TOUCH XL automatically leaves equal margins on the left and right sides of labels. You can choose whether to leave "full" margins (1"), "medium" margins (1/2"), "narrow" margins (1/3"), or "none" (though 1/6" will still be left).

When messages include bar codes, full tape feed is recommended. Reducing tape feed may decrease bar code readability.

COPIES Determines the number of copies of the current label to be printed. When the text includes a numbering field, this setting determines the number of copies to print before increasing the field's contents.

NUMBERING INCREASES For each printing session, if the text includes a numbering field, this setting determines the number of times you wish to increment, or add to, the field (see Examples).

CORNER ROUNDING If you have created a frame around the text message, you can choose here whether to make the frame's corners rounded (corner rounding ON), or square (corner rounding OFF).

OPERATION

TO PRINT A LABEL:

- (1) Press the Print key. The print settings selection menu will appear.
- (2) If default settings are o.k. (see Examples), press RETURN (←).
To edit the print settings:
- (3) Press ▶ and ◀ until the first setting you wish to change flashes.
- (4) Press ▲ and ▼ until your desired setting is displayed.
Note: To avoid scrolling through all Numbering Counting Increase choices, OFF can be selected easily by pressing the space bar.
- (5) Repeat steps (3) and (4) until all settings are as you wish.
- (6) Press RETURN (←). The labels are printed according to the print parameters you have set.

EXAMPLES

(Text Message)

F	M	T	◀	A	▶	A	:	A	U	T	:	N	O	R	M	A	L	:	:	:
1	:	A	B	C	'	N	I	N												

Default Print Settings

Auto-Cut:	ON
Tape Feed:	FULL
Corner Rounding:	OFF
Copies:	1
Numbering	
Increases:	OFF

ABC1

1" 1"

Custom Print Settings

Auto-Cut:	OFF
Tape Feed:	NONE
Corner Rounding :	OFF
Copies:	2
Numbering	
Increases:	3

ABC1	ABC1	ABC2	ABC2	ABC3	ABC3
------	------	------	------	------	------

1" 1/3" 1/3" 1/6" 1/3" 1/3" 1/3"

BARCODING

BACKGROUND

The Barcoding function is one of the P-TOUCH XL's most advanced features. Your P-TOUCH XL is able to print bar codes as part of labels.

Note: This section will explain how to enter bar coding into your text message. However, while it will explain the P-TOUCH XL's bar code feature, it is not intended as a comprehensive introduction to the concept of bar codes. For such information, please consult one of the many reference books available.

As this machine is not designed for special bar-code label making, some bar-code readers may not be able to read the labels.

Please use the black character on white tape for the barcode labels.

In Barcode Mode, six different parameters can be set, allowing you to create custom bar codes as you wish.

<u>PARAMETER</u>	<u>POSSIBLE SETTINGS</u>
Protocols _____	CODE 39, I-2/5, EAN13, EAN8, UPC-A, UPC-E, CODABAR
Numbers Printed Below	
Bar Code _____	ON, OFF
# of Characters in Code _____	FREE, 4 to 22
Bar Code Width _____	S, M, L
Ratio _____	3:1, 2.5:1, 2:1
Check Digit _____	OFF, ON

We recommend printing bar codes in M or L widths, using full tape feed. When the tape feed is reduced or S(small) width bar codes are used, their readability may decline.

OPERATION

TO ENTER A BAR CODE INTO YOUR MESSAGE:

- (1) Press the Barcode key. The most recently entered bar code's settings and data will be displayed.
- (2) If these settings are O.K., enter your barcode information.
To edit the barcode settings:
- (3) Press Format.
- (4) Press **▶** and **◀** until the first setting you wish to change flashes.
- (5) Press **▲** and **▼** until your desired setting is displayed.
- (6) Repeat steps (4) and (5) until all settings are as you wish.
- (7) Press RETURN (**↵**).
- (8) Enter bar code information.
- (9) When done, press RETURN (**↵**).

EXAMPLES

F	M	T	◀	A	▶	1	:	1	O	N	:	N	O	R	M	A	L		:	:
1	:	S	E	R	I	A	L	#	_											

Press the Barcode key.

B	A	R		C	O	D	E		C	O	D	E	3	9						
▶	*	*	◀																	

Press the Format key.

P	R	O	T	O			W	I	D	T	H		U	N	D	E	R	#	S	→
C	O	D	E	3	9	:	S					:	O	N						

Press ▶ until the Size setting flashes.

P	R	O	T	O			W	I	D	T	H		U	N	D	E	R	#	S	→
C	O	D	E	3	9	:	S					:	O	N						

Press ▲ and ▼ until Large ("L") flashes.

P	R	O	T	O			W	I	D	T	H		U	N	D	E	R	#	S	→
C	O	D	E	3	9	:	L					:	O	N						

Press RETURN.

B	A	R		C	O	D	E		C	O	D	E	3	9						
▶	*	*	◀																	

Enter barcoding information ("123").

B	A	R		C	O	D	E		C	O	D	E	3	9						
▶	*	1	2	3	*	◀														

Press RETURN.

F	M	T	◀	A	▶	A	:	1	O	N	:	N	O	R	M	A	L		:	:
S	E	R	I	A	L	#	◀		_											

HOW TO REMOVE LABEL BACKING

The attached stick enables the label backing of the tape to be removed easily.

- (1) Hold the tape in the left hand with printed surface upside, and the stick in the right hand.
- (2) Pass the tape halfway through the long narrow hole of the stick.
- (3) After turning the stick inward halfway, pull the stick to the right.

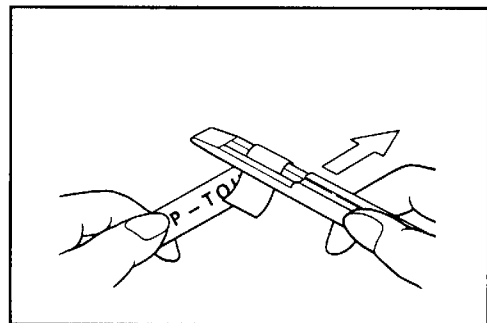
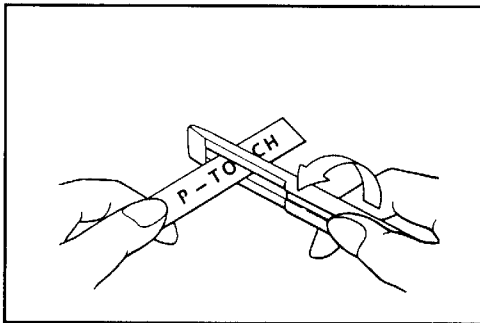

INSTANT LETTERING TAPE (RUB-ON CHARACTERS)

Instant lettering tapes act as rub-on character transfers. After creating a message, simply position the characters over a sheet of paper. By rubbing the instant lettering tape's non-printed side with the attached stick, you can transfer the tape's contents directly onto the paper.

Caution: Hold tape very firmly and do not move while rubbing the tape.

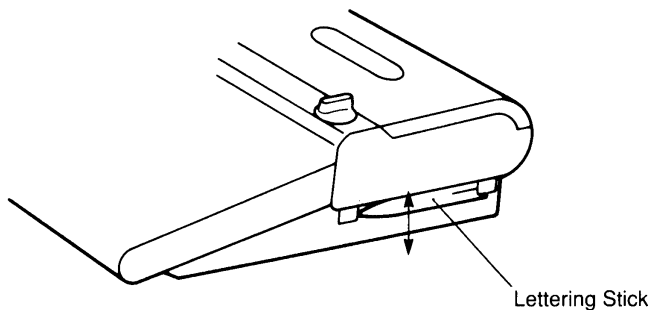

MESSAGE LIST

MESSAGE	MEANING	TO DO
1-FIELD LIMIT!	<ul style="list-style-type: none"> Only one numbering field may be created per label. If one already exists and you try to create another, this message will appear. 	<ul style="list-style-type: none"> Either delete the already existing numbering field or give up creating a new one.
5-LINE LIMIT!	<ul style="list-style-type: none"> Each block of text in a label can contain no more than five lines. If five lines already exist and you press RETURN, this message will appear. 	<ul style="list-style-type: none"> Do not press RETURN. Limit the number of lines in the current block to five.
10-BLOCK LIMIT!	<ul style="list-style-type: none"> Each label can contain no more than ten blocks. If ten blocks already exist and you press the New Block key, this message will appear. 	<ul style="list-style-type: none"> Do not press the New Block key. Limit the number of blocks in the text file to ten.
10-NUMBER/LETTER LIMIT!	<ul style="list-style-type: none"> Each numbering field can contain no more than 10 letters or numbers. If ten already exist and you try to insert another character, a dead key, a blank space, a tag, or a symbol, this message will appear. Also, when using cursors to choose the numbering field, if you try to highlight more than ten characters, this message will appear. 	<ul style="list-style-type: none"> Do not enter the character. Limit the number of characters in the numbering field to ten. Do not attempt to choose more than ten characters.
BAD F F FIELD CONTENTS!	<ul style="list-style-type: none"> A local format field must include text. If the cursor is located at a barcode or numbering mark and you press Local Format then try to press RETURN having selected no text, this message will appear. 	<ul style="list-style-type: none"> Select some text or press CANCEL.
CANNOT ENTER AT !	<ul style="list-style-type: none"> When the cursor is located at a bar code mark, characters, dead keys, symbols, and spaces cannot be entered. If you try to enter one of those, this message will appear. 	<ul style="list-style-type: none"> Move the cursor or give up entering the character.
CANNOT RECALL HERE!	<ul style="list-style-type: none"> When the cursor is located in a numbering field or barcode field, you cannot recall and join a different text file at that spot. If you attempt to, this message will appear. 	<ul style="list-style-type: none"> Move the cursor or delete the field before recalling.
CASSETTE NOT INSTALLED!	<ul style="list-style-type: none"> If you attempt to print a label, or cut or feed tape when no cassette is inserted, this message will occur. 	<ul style="list-style-type: none"> Insert tape cassette and re-try.

MESSAGE LIST (continued)

MESSAGE	MEANING	TO DO
CUTTER ERROR!	<ul style="list-style-type: none"> When the power is turned on, when the tape is cut, or during printing, if the cutter does not function properly, this message will appear. 	<ul style="list-style-type: none"> Remove anything caught in the cutter mechanism. If it still does not function properly, contact your service representative.
EXISTS. OK TO OVERWRITE?	<ul style="list-style-type: none"> When assigning a name to a text file, if a file by that name already exists, this message will occur. 	<ul style="list-style-type: none"> If you no longer need the old file of the same name, press RETURN. If you wish to keep it, press CANCEL and enter a new name for this file.
FINISH INPUTTING CODE!	<ul style="list-style-type: none"> Sometimes in bar code mode you set the number of digits required for a code. Then, when inputting the actual bar code data, if you do not enter that number of digits, this message will occur. 	<ul style="list-style-type: none"> Finish inputting the proper number of digits, or change the number of digits set in bar code parameters.
FORMAT X DOES NOT EXIST!	<ul style="list-style-type: none"> To choose a global format you can either scroll through existing choices or input a letter code. If a format with the code letter you input does not exist, this message will occur. 	<ul style="list-style-type: none"> Enter a different letter code, or scroll through choices using ▲ and ▼.
MEMORY FULL!	<ul style="list-style-type: none"> The P-TOUCH XL can store 3300 characters at maximum in its text memory. When you store a file, if that storing will exceed the available memory space, this message will occur. 	<ul style="list-style-type: none"> Do not store the text file, or delete an unnecessary, old file to make room for this one.
NO ↵ IN BARCODE FIELD!	<ul style="list-style-type: none"> Barcode fields must be located on a single line. If the cursor is located in the barcode field and you press RETURN, this message will occur. 	<ul style="list-style-type: none"> Move the cursor or give up entering a return mark.
NO ↵ IN NUMBERING FIELD!	<ul style="list-style-type: none"> Numbering fields must be located on a single line. If the cursor is located in the numbering field and you press RETURN, this message will occur. 	<ul style="list-style-type: none"> Move the cursor or give up entering a return mark.
NO ⏎ IN BARCODE FIELD!	<ul style="list-style-type: none"> Barcode fields must be located in a single block. If the cursor is located in the barcode field and you press the Block Return key, this message will occur. 	<ul style="list-style-type: none"> Move the cursor or give up entering a Block Return mark.
NO ⏎ IN NUMBERING FIELD!	<ul style="list-style-type: none"> Numbering fields must be located in a single block. If the cursor is located in the numbering field and you press the Block Return key, this message will occur. 	<ul style="list-style-type: none"> Move the cursor or give up entering a Block Return mark.
NO ↵ OR ⏎ IN NUMB. FIELD!	<ul style="list-style-type: none"> Numbering fields must be located in a single line of a single block. When you use cursors to choose a numbering field and you try to include a Return mark or Block Return mark, this message will occur. 	<ul style="list-style-type: none"> Do not attempt to include a Return or Block Return mark in your numbering field.

MESSAGE LIST (continued)

MESSAGE	MEANING	TO DO
NO ⌘ IN BARCODE FIELD?	<ul style="list-style-type: none"> Barcode fields cannot contain a tag. If the cursor is located in the barcode field and you press the Tag key, this message will occur. 	<ul style="list-style-type: none"> Move the cursor or give up entering a tag.
NO ⌘ IN NUMB. FIELD!	<ul style="list-style-type: none"> LOCAL FORMAT fields cannot contain only portions of numbering fields. This message will occur when: The cursor is located at a local format mark and you press the Number key. Or the cursor is located in a numbering field and you press the Local Format key. You are using ▶ and ◀ to choose LOCAL FORMAT field contents and you try to include only part of a numbering field. (The entire field and both its marks must be included.) 	<ul style="list-style-type: none"> Do not attempt to mix numbering fields and local format fields. Move the cursor or give up trying to enter these marks. Include the entire field.
NO ◀ N NUMB. FIELD!	<ul style="list-style-type: none"> Numbering fields cannot contain barcode fields, and vice versa. This message will occur when: The cursor is located at a bar code mark and you press the Number key. The cursor is located in the numbering field and you press the Barcode key. You are using ▶ and ◀ to choose numbering field contents and you try to include a barcode mark. 	<ul style="list-style-type: none"> Do not attempt to mix numbering fields and barcode fields. Move the cursor or give up trying to enter the Numbering mark. Move the cursor or give up trying to enter the Bar code mark. Give up trying to include the barcode marks in the numbering field.
NO LOCAL FORMAT OVERLAP!	<ul style="list-style-type: none"> Though several local format fields can be created in a single label, they cannot overlap. In other words, the same character cannot be included in more than one local format field. When you use cursors to choose a local format field and you try to include a previously inputted local format mark, this message will appear. 	<ul style="list-style-type: none"> Do not attempt to include already existing local format marks in a new local format field.
NO TEXT FILES IN MEMORY!	<ul style="list-style-type: none"> If you try to recall or delete a text file from the memory when none are currently stored, this message will appear. 	<ul style="list-style-type: none"> Give up trying to recall or delete.
OK TO CLEAR?	<ul style="list-style-type: none"> When you press CODE and the Clear key, this confirmation message will appear. 	<ul style="list-style-type: none"> If it is o.k. to clear all text from the working area press RETURN. If not, press CANCEL.

MESSAGE LIST (continued)

MESSAGE	MEANING	TO DO
OK TO CLEAR BAR CODE?	<ul style="list-style-type: none"> When you try to delete a barcode mark, this confirmation message will appear. 	<ul style="list-style-type: none"> If it is o.k. to delete the barcode information press RETURN. If not, press CANCEL.
OK TO CLEAR LOC. FORMAT?	<ul style="list-style-type: none"> When you try to delete a local format mark, this confirmation message will appear. 	<ul style="list-style-type: none"> If it is o.k. to delete the local format information press RETURN. If not, press CANCEL.
OK TO CLEAR NUMB. FIELD?	<ul style="list-style-type: none"> When you try to delete a numbering field mark, this confirmation message will appear. 	<ul style="list-style-type: none"> If it is o.k. to delete the numbering field information press RETURN. If not, press CANCEL.
OK TO DELETE?	<ul style="list-style-type: none"> When you try to delete a text file from the machine's memory, this confirmation message will appear. 	<ul style="list-style-type: none"> If it is o.k. to delete the text file press RETURN. If not, press CANCEL.
OK TO OVERWRITE?	<ul style="list-style-type: none"> When you try to assign newly set traits an already existing global format letter code, this confirmation message will appear. 	<ul style="list-style-type: none"> If you press RETURN, the new global format traits will be applied not only to the current text file, but also to all text files associated with the global format having that letter code. In other words, if you change the settings of global format A and press RETURN, all text files with format A will use the new settings. If you do not wish to overwrite this format, press CANCEL and assign a different letter code.
PRINT VOLUME TOO LARGE!	<ul style="list-style-type: none"> There is a limit to how much text data can be printed in one label. If the text you try to print exceeds this limit, this message will appear. 	<ul style="list-style-type: none"> Reduce the total amount of text or reduce the character size, and re-try printing.
RAM DOWN!	<ul style="list-style-type: none"> If there is a problem with the machine's random access memory, this message will appear. 	<ul style="list-style-type: none"> Contact your service representative.
ROM DOWN!	<ul style="list-style-type: none"> If there is a problem with the machine's read only memory, this message will appear. 	<ul style="list-style-type: none"> Contact your service representative.
SYSTEM ERROR!	<ul style="list-style-type: none"> If there is a problem with the machine's software, this message will appear. 	<ul style="list-style-type: none"> Contact your service representative.
TEXT TOO HIGH FOR TAPE!	<ul style="list-style-type: none"> Sometimes too many text lines exist for the currently inserted tape, or the characters inputted are too large. In these cases, if you try to print, this message will appear. 	<ul style="list-style-type: none"> Reduce the number of lines, decrease the character size, or install a wider tape.

MESSAGE LIST (continued)

MESSAGE	MEANING	TO DO
TOO LONG FOR SET LENGTH!	<ul style="list-style-type: none"> • In global formatting you may sometimes set a length for the entire label. If the text you have entered will be too long for the set label length, this message will appear when you try to print. • This same problem may occur when using vertical printing. • When you use tape width printing, if the total number of text lines makes the message longer than the set label length, this message will occur. • These same problems may occur when using Auto size mode. If even the smallest characters will be too long for the set label length, this message will occur. 	<ul style="list-style-type: none"> • Decrease the character size, or increase the set label length. • Reduce the total amount of text, or increase the set label length. • Reduce the number of text lines, or increase the set length. • Reduce the total amount of text, or increase the set label length.
TOO LONG FOR TAPE WIDTH!	<ul style="list-style-type: none"> • When you use tape width printing, if the length of lines of text exceeds the installed tape's width, this message will appear. 	<ul style="list-style-type: none"> • Reduce the total amount of text, reduce the character size, or install a wider tape cassette.
WEAK BATTERIES!	<ul style="list-style-type: none"> • When you use optional Ni-Cd batteries, this message will appear when the batteries are becoming weak. • Bar codes cannot be printed in tape width printing mode. Attempting to do so will cause this message to appear. • Either print in normal orientation or remove the bar code from your message. 	<ul style="list-style-type: none"> • Re-charge the batteries or switch to using the AC adaptor.
WILL EXCEED 5-LINE LIMIT!	<ul style="list-style-type: none"> • When you try to delete a block return mark, if that deletion will result in a block of six lines or more, this message will appear. 	<ul style="list-style-type: none"> • Do not attempt to delete the mark. Adjust total lines in blocks so that a new block will have no more than five lines.
WORKING AREA EMPTY!	<ul style="list-style-type: none"> • If you try to print, but no text has been inputted in the working area, this message will appear. • If you try to store a text file, but no text has been inputted in the working area, this message will appear. 	<ul style="list-style-type: none"> • Enter text before printing. • Enter text before storing.

MESSAGE LIST (continued)

MESSAGE	MEANING	TO DO
WORKING AREA FULL!	<ul style="list-style-type: none">• There is a limit as to how much text can be entered in the working area. When you try to enter a character, dead key, return, new block space, or tag, and if that entry will exceed the limited working area buffer, this message will appear.• After entering numbering mode, symbol mode, locat format mode, or bar code mode, if pressing RETURN will exceed the limited working area buffer, this message will appear.• When recalling a file with the joining function on, if pressing RETURN will exceed the limited working area buffer, this message will appear.	<ul style="list-style-type: none">• You cannot enter any more text in this label. Reduce the overall length so that more text can be entered.• Press CANCEL. Reduce the overall label text volume before re-trying these operations.• Press CANCEL and reduce the overall label text volume before recalling. Or, recall without joining the working area text and the file.

TROUBLESHOOTING

PROBLEM	WHAT TO DO
1. The display stays blank after you have turned on the machine.	<ul style="list-style-type: none">• Check that the AC Adaptor is attached properly.• If using optional Ni-Cd battery, check that it is attached properly.
2. The machine does not print, or the printed characters are blurred.	<ul style="list-style-type: none">• Check that the tape cassette has been inserted properly.• If the tape cassette is empty, replace it with a new one.• Make sure that the tape cassette cover has been closed.
3. The printed characters are not formed properly.	<ul style="list-style-type: none">• If using optional Ni-Cd battery, it may be weak. Try using the AC Adaptor.
4. Silver tape appears.	<ul style="list-style-type: none">• You have reached the end of the tape. Replace it with a new tape.
5. Lines appear on the printout	<ul style="list-style-type: none">• Clean the print head and/or the rollers.

For technical and operational assistance call Customer Service at 1-901-373-6256 from 9:00 to 4:30 CST (Central Standard Time).

For service of your Brother P-Touch machine call 1-901-373-8500.

MACHINE SPECIFICATIONS

HARDWARE

Input Device:	KEYBOARD - 62 keys
LCD:	7 x 5 dots / 2 lines x 24 columns
Print Tape:	Pressure-sensitive, adhesive-based. 15 m long. 5 widths available: 1/4" (6 mm) 3/8" (9 mm) 1/2" (12 mm) 3/4" (18 mm) 1" (24 mm)
Power Supply:	AC Adaptor or optional Ni-Cd batteries
Print Head:	128 dot / 180 dpi
Dimensions:	11.8 x 11.9 x 3.1 inch
Weight:	4.4 lbs
Optional Equipment:	Ni-Cd batteries

SOFTWARE

Character Size:	6 selectable sizes (10 points to 44 points) + Auto All are available in Narrow, Medium, and Wide
Character Fonts:	3 built-in typefaces
Buffer Size:	Single line - 3.3 feet or 511 characters Multi line - 12 inches for each block Multi block
Memory Size:	Approximately 3300 characters.
Number of Characters:	268 characters
Print Styles:	Normal, Outline, Shadow1, Shadow2, Bold, Italic, Italic & Bold, Italic & Shadow1, Italic & Shadow2, Italic & Outline

The following features and functions are all included in your P-TOUCH XL:

- Multi-line Printing (up to 5 lines)
- Multi-block Printing (up to 10 blocks)
- Text Framing
- Text Underlining
- Vertical Printing
- Tape Width Printing
- Mirror Printing
- Adjustable Tape Feed
- Label Length Setting
- Repeat Printing
- Numbering Function
- Bar Code Generation

ACCESSORIES

Obtain optional tape cassettes and Ni-Cd batteries from your authorized Brother dealer. Brother cannot be held responsible for trouble caused by the use of unauthorized supplies.

- **Tapes (U.S Only)**

24mm (1")

Stock No.	Description	QTY/Package
TX-1511	Black Characters on Clear Adhesive	1
TX-1521	Red Characters on Clear Adhesive	1
TX-1531	Blue Characters on Clear Adhesive	1
TX-1551	White Characters on Clear Adhesive	1
TX-2511	Black Characters on White Adhesive	1
TX-2521	Red Characters on White Adhesive	1
TX-2531	Blue Characters on White Adhesive	1
TX-3541	Gold Characters on Black Adhesive	1
TX-3551	White Characters on Black Adhesive	1
TX-4511	Black Characters on Red Adhesive	1
TX-5511	Black Characters on Blue Adhesive	1
TX-6511	Black Characters on Yellow Adhesive	1
TX-7511	Black Characters on Green Adhesive	1
TX-A511	Black Characters on Grey Adhesive	1
TX-B511	Black Characters on Orange Fluorescent Adhesive	1

18mm (3/4")

Stock No.	Description	QTY/Package
TX-1411	Black Characters on Clear Adhesive	1
TX-2411	Black Characters on White Adhesive	1
TX-3451	White Characters on Black Adhesive	1

12mm (1/2")

Stock No.	Description	QTY/Package
TX-1311	Black Characters on Clear Adhesive	1
TX-1321	Red Characters on Clear Adhesive	1
TX-1331	Blue Characters on Clear Adhesive	1
TX-1551	White Characters on Clear Adhesive	1
TX-2311	Black Characters on White Adhesive	1
TX-2321	Red Characters on White Adhesive	1
TX-2331	Blue Characters on White Adhesive	1
TX-3341	Gold Characters on Black Adhesive	1
TX-3351	White Characters on Black Adhesive	1
TX-4311	Black Characters on Red Adhesive	1
TX-5311	Black Characters on Blue Adhesive	1
TX-6311	Black Characters on Yellow Adhesive	1
TX-7311	Black Characters on Green Adhesive	1
TX-A311	Black Characters on Grey Adhesive	1
TX-B311	Black Characters on Orange Fluorescent Adhesive	1

Brother P-Touch Telephone Contact Guide

- **For technical and operational assistance** call Customer Service at 1-901-373-6256 from 9:00 to 4:30 CST (Central Standard Time).
- **For service of your Brother P-Touch** call 1-901-373-8500.
- **To order brochures on other Brother products** call 1-800-284-4357.
- **To order ribbons and accessories:**
 - 1) Contact your local Brother authorized dealer to see whether they carry the ribbon or accessory that you require.
 - 2) To use Visa or Master Card call Toll FREE 1-800-284-4357, or fax your order to Brother at 1-901-373-6213 anytime.
 - 3) For questions on which ribbons or accessories fit your machine call 1-800-284-4357 from 9:00 to 4:30 EST (Eastern Standard Time).
 - 4) To order by mail or pay by check, please fill out the accessory order form and mail along with payment to:

Customer Service
Brother International Corporation
P.O. Box 341332
Bartlett, TN 38133-1332

brother®

(US)
UB5704001©
Printed in Japan

Free Manuals Download Website

<http://myh66.com>

<http://usermanuals.us>

<http://www.somanuals.com>

<http://www.4manuals.cc>

<http://www.manual-lib.com>

<http://www.404manual.com>

<http://www.luxmanual.com>

<http://aubethermostatmanual.com>

Golf course search by state

<http://golfingnear.com>

Email search by domain

<http://emailbydomain.com>

Auto manuals search

<http://auto.somanuals.com>

TV manuals search

<http://tv.somanuals.com>