

2H23-50R/2H33-37R SmartSwitch 2100 User's Guide

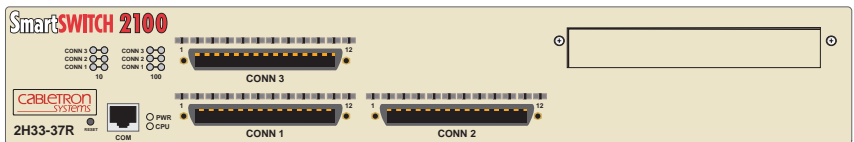

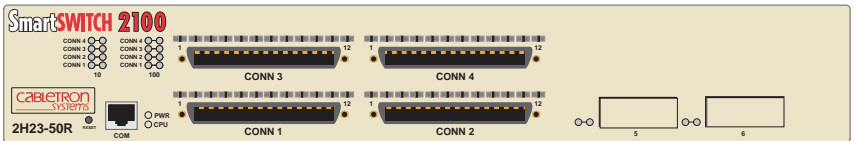

Only qualified personnel should perform installation procedures.

NOTICE

Cabletron Systems reserves the right to make changes in specifications and other information contained in this document without prior notice. The reader should in all cases consult Cabletron Systems to determine whether any such changes have been made.

The hardware, firmware, or software described in this manual is subject to change without notice.

IN NO EVENT SHALL CABLETRON SYSTEMS BE LIABLE FOR ANY INCIDENTAL, INDIRECT, SPECIAL, OR CONSEQUENTIAL DAMAGES WHATSOEVER (INCLUDING BUT NOT LIMITED TO LOST PROFITS) ARISING OUT OF OR RELATED TO THIS MANUAL OR THE INFORMATION CONTAINED IN IT, EVEN IF CABLETRON SYSTEMS HAS BEEN ADVISED OF, KNOWN, OR SHOULD HAVE KNOWN, THE POSSIBILITY OF SUCH DAMAGES.

© 1998 by Cabletron Systems, Inc., P.O. Box 5005, Rochester, NH 03866-5005

All Rights Reserved

Printed in the United States of America

Order Number: 9032286-04 September 1998

Cabletron Systems, SPECTRUM, LANVIEW, QuickSET, and SecureFast are registered trademarks and **SmartSwitch** is a trademark of Cabletron Systems, Inc.

All other product names mentioned in this manual may be trademarks or registered trademarks of their respective companies.

FCC NOTICE

This device complies with Part 15 of the FCC rules. Operation is subject to the following two conditions: (1) this device may not cause harmful interference, and (2) this device must accept any interference received, including interference that may cause undesired operation.

NOTE: This equipment has been tested and found to comply with the limits for a Class A digital device, pursuant to Part 15 of the FCC rules. These limits are designed to provide reasonable protection against harmful interference when the equipment is operated in a commercial environment. This equipment uses, generates, and can radiate radio frequency energy and if not installed in accordance with the operator's manual, may cause harmful interference to radio communications. Operation of this equipment in a residential area is likely to cause interference in which case the user will be required to correct the interference at his own expense.

WARNING: Changes or modifications made to this device which are not expressly approved by the party responsible for compliance could void the user's authority to operate the equipment.

Printed on



Recycled Paper

INDUSTRY CANADA NOTICE

This digital apparatus does not exceed the Class A limits for radio noise emissions from digital apparatus set out in the Radio Interference Regulations of the Canadian Department of Communications.

Le présent appareil numérique n'émet pas de bruits radioélectriques dépassant les limites applicables aux appareils numériques de la class A prescrites dans le Règlement sur le brouillage radioélectrique édicté par le ministère des Communications du Canada.

VCCI NOTICE

This is a Class A product based on the standard of the Voluntary Control Council for Interference by Information Technology Equipment (VCCI). If this equipment is used in a domestic environment, radio disturbance may arise. When such trouble occurs, the user may be required to take corrective actions.

この装置は、情報処理装置等電波障害自主規制協議会（VCCI）の基準に基づくクラスA情報技術装置です。この装置を家庭環境で使用すると電波妨害を引き起こすことがあります。この場合には使用者が適切な対策を講ずるよう要求されることがあります。

CABLETRON SYSTEMS, INC. PROGRAM LICENSE AGREEMENT

IMPORTANT: Before utilizing this product, carefully read this License Agreement.

This document is an agreement between you, the end user, and Cabletron Systems, Inc. ("Cabletron") that sets forth your rights and obligations with respect to the Cabletron software program (the "Program") contained in this package. The Program may be contained in firmware, chips or other media. BY UTILIZING THE ENCLOSED PRODUCT, YOU ARE AGREEING TO BECOME BOUND BY THE TERMS OF THIS AGREEMENT, WHICH INCLUDES THE LICENSE AND THE LIMITATION OF WARRANTY AND DISCLAIMER OF LIABILITY. IF YOU DO NOT AGREE TO THE TERMS OF THIS AGREEMENT, PROMPTLY RETURN THE UNUSED PRODUCT TO THE PLACE OF PURCHASE FOR A FULL REFUND.

CABLETRON SOFTWARE PROGRAM LICENSE

1. **LICENSE.** You have the right to use only the one (1) copy of the Program provided in this package subject to the terms and conditions of this License Agreement.

You may not copy, reproduce or transmit any part of the Program except as permitted by the Copyright Act of the United States or as authorized in writing by Cabletron.
2. **OTHER RESTRICTIONS.** You may not reverse engineer, decompile, or disassemble the Program.
3. **APPLICABLE LAW.** This License Agreement shall be interpreted and governed under the laws and in the state and federal courts of New Hampshire. You accept the personal jurisdiction and venue of the New Hampshire courts.

EXCLUSION OF WARRANTY AND DISCLAIMER OF LIABILITY

1. **EXCLUSION OF WARRANTY.** Except as may be specifically provided by Cabletron in writing, Cabletron makes no warranty, expressed or implied, concerning the Program (including its documentation and media).

CABLETRON DISCLAIMS ALL WARRANTIES, OTHER THAN THOSE SUPPLIED TO YOU BY CABLETRON IN WRITING, EITHER EXPRESSED OR IMPLIED, INCLUDING BUT NOT LIMITED TO IMPLIED WARRANTIES OF MERCHANTABILITY AND FITNESS FOR A PARTICULAR PURPOSE, WITH RESPECT TO THE PROGRAM, THE ACCOMPANYING WRITTEN MATERIALS, AND ANY ACCOMPANYING HARDWARE.

2. **NO LIABILITY FOR CONSEQUENTIAL DAMAGES.** IN NO EVENT SHALL CABLETRON OR ITS SUPPLIERS BE LIABLE FOR ANY DAMAGES WHATSOEVER (INCLUDING, WITHOUT LIMITATION, DAMAGES FOR LOSS OF BUSINESS, PROFITS, BUSINESS INTERRUPTION, LOSS OF BUSINESS INFORMATION, SPECIAL, INCIDENTAL, CONSEQUENTIAL, OR RELIANCE DAMAGES, OR OTHER LOSS) ARISING OUT OF THE USE OR INABILITY TO USE THIS CABLETRON PRODUCT, EVEN IF CABLETRON HAS BEEN ADVISED OF THE POSSIBILITY OF SUCH DAMAGES. BECAUSE SOME STATES DO NOT ALLOW THE EXCLUSION OR LIMITATION OF LIABILITY FOR CONSEQUENTIAL OR INCIDENTAL DAMAGES, OR ON THE DURATION OR LIMITATION OF IMPLIED WARRANTIES, IN SOME INSTANCES THE ABOVE LIMITATIONS AND EXCLUSIONS MAY NOT APPLY TO YOU.

UNITED STATES GOVERNMENT RESTRICTED RIGHTS

The enclosed product (a) was developed solely at private expense; (b) contains “restricted computer software” submitted with restricted rights in accordance with Section 52227-19 (a) through (d) of the Commercial Computer Software - Restricted Rights Clause and its successors, and (c) in all respects is proprietary data belonging to Cabletron and/or its suppliers.

For Department of Defense units, the product is licensed with “Restricted Rights” as defined in the DoD Supplement to the Federal Acquisition Regulations, Section 52.227-7013 (c) (1) (ii) and its successors, and use, duplication, disclosure by the Government is subject to restrictions as set forth in subparagraph (c) (1) (ii) of the Rights in Technical Data and Computer Software clause at 252.227-7013. Cabletron Systems, Inc., 35 Industrial Way, Rochester, New Hampshire 03867-0505.

SAFETY INFORMATION

CLASS 1 LASER TRANSCEIVERS

THE FE-100F3 FAST ETHERNET INTERFACE MODULE, FPIM-05 AND FPIM-07 FDDI PORT INTERFACE MODULES, AND APIM-29 ATM PORT INTERFACE MODULE USE CLASS 1 LASER TRANSCEIVERS. READ THE FOLLOWING SAFETY INFORMATION BEFORE INSTALLING OR OPERATING THESE MODULES.

The Class 1 laser transceivers use an optical feedback loop to maintain Class 1 operation limits. This control loop eliminates the need for maintenance checks or adjustments. The output is factory set, and does not allow any user adjustment. Class 1 Laser transceivers comply with the following safety standards:

- 21 CFR 1040.10 and 1040.11 U.S. Department of Health and Human Services (FDA).
- IEC Publication 825 (International Electrotechnical Commission).
- CENELEC EN 60825 (European Committee for Electrotechnical Standardization).

When operating within their performance limitations, laser transceiver output meets the Class 1 accessible emission limit of all three standards. Class 1 levels of laser radiation are not considered hazardous.

SAFETY INFORMATION

CLASS 1 LASER TRANSCEIVERS

LASER RADIATION AND CONNECTORS

When the connector is in place, all laser radiation remains within the fiber. The maximum amount of radiant power exiting the fiber (under normal conditions) is -12.6 dBm or 55×10^{-6} watts.

Removing the optical connector from the transceiver allows laser radiation to emit directly from the optical port. The maximum radiance from the optical port (under worst case conditions) is 0.8 W cm^{-2} or $8 \times 10^3 \text{ W m}^2 \text{ sr}^{-1}$.

Do not use optical instruments to view the laser output. The use of optical instruments to view laser output increases eye hazard. When viewing the output optical port, power must be removed from the network adapter.

DECLARATION OF CONFORMITY

Application of Council Directive(s): **89/336/EEC
73/23/EEC**

Manufacturer's Name: **Cabletron Systems, Inc.**

Manufacturer's Address: **35 Industrial Way
PO Box 5005
Rochester, NH 03867**

European Representative Name: **Mr. J. Solari**

European Representative Address: **Cabletron Systems Limited
Nexus House, Newbury Business Park
London Road, Newbury
Berkshire RG13 2PZ, England**

Conformance to Directive(s)/Product Standards: **EC Directive 89/336/EEC
EC Directive 73/23/EEC
EN 55022
EN 50082-1
EN 60950**

Equipment Type/Environment: **Networking Equipment, for use in a
Commercial or Light Industrial
Environment.**

We the undersigned, hereby declare, under our sole responsibility, that the equipment packaged with this notice conforms to the above directives.

Manufacturer

Mr. Ronald Fotino

Full Name

Principal Compliance Engineer

Title

Rochester, NH, USA

Location

Legal Representative in Europe

Mr. J. Solari

Full Name

Managing Director - E.M.E.A.

Title

Newbury, Berkshire, England

Location

CONTENTS

CHAPTER 1 INTRODUCTION

| | | |
|--------|--------------------------------------|------|
| 1.1 | Using This Guide | 1-1 |
| 1.2 | Structure of This Guide..... | 1-1 |
| 1.3 | Overview..... | 1-2 |
| 1.3.1 | Connectivity | 1-4 |
| 1.3.2 | Full Duplex Switched Ethernet..... | 1-4 |
| 1.3.3 | Auto-Negotiation | 1-4 |
| 1.3.4 | SmartTrunking | 1-5 |
| 1.3.5 | Runtime IP Address Discovery | 1-5 |
| 1.3.6 | Management..... | 1-6 |
| 1.3.7 | Switching Options | 1-6 |
| 1.3.8 | Standards Compatibility..... | 1-7 |
| 1.3.9 | Year 2000 Compliant | 1-7 |
| 1.3.10 | LANVIEW Diagnostic LEDs | 1-7 |
| 1.4 | Optional Features | 1-7 |
| 1.4.1 | Fast Ethernet Interface Modules..... | 1-8 |
| 1.4.2 | High Speed Interface Modules | 1-8 |
| 1.5 | Document Conventions | 1-9 |
| 1.6 | Getting Help..... | 1-10 |
| 1.7 | Related Manuals..... | 1-11 |

CHAPTER 2 NETWORK REQUIREMENTS

| | | |
|-----|--------------------------------------|-----|
| 2.1 | SmartTrunk..... | 2-1 |
| 2.2 | 10BASE-T Network | 2-1 |
| 2.3 | 100BASE-TX Network | 2-2 |
| 2.4 | 100BASE-FX Fiber Optic Network | 2-2 |

CHAPTER 3 INSTALLATION

| | | |
|-------|--------------------------------------|-----|
| 3.1 | Required Tools | 3-1 |
| 3.2 | Unpacking the Device..... | 3-2 |
| 3.3 | Installing Options | 3-2 |
| 3.4 | Installing the Device | 3-3 |
| 3.4.1 | Tabletop or Shelf Installation | 3-3 |
| 3.4.2 | Rackmount Installation | 3-4 |
| 3.4.3 | Connecting Power to the Device | 3-7 |

Contents

| | | |
|-------|---|------|
| 3.5 | Connecting to the Network..... | 3-8 |
| 3.5.1 | Connecting Cables to CONN 1 Through 4..... | 3-9 |
| 3.5.2 | Connecting a UTP Segment to the FE-100TX..... | 3-10 |
| 3.5.3 | Connecting a Fiber Optic Segment to the FE-100FX and FE-100F3..... | 3-13 |
| 3.6 | Completing the Installation..... | 3-15 |

CHAPTER 4 TROUBLESHOOTING

| | | |
|-----|--------------------------------|-----|
| 4.1 | Using LANVIEW..... | 4-1 |
| 4.2 | FE-100TX LED..... | 4-5 |
| 4.3 | Troubleshooting Checklist..... | 4-7 |
| 4.4 | Using the RESET Button..... | 4-8 |

CHAPTER 5 LOCAL MANAGEMENT

| | | |
|----------|---|------|
| 5.1 | Overview..... | 5-1 |
| 5.2 | Local Management Keyboard Conventions..... | 5-2 |
| 5.3 | Management Terminal Setup..... | 5-3 |
| 5.3.1 | Console Cable Connection..... | 5-4 |
| 5.3.2 | Management Terminal Setup Parameters..... | 5-5 |
| 5.3.3 | Telnet Connections..... | 5-6 |
| 5.3.4 | Monitoring an Uninterruptible Power Supply..... | 5-7 |
| 5.4 | Accessing Local Management..... | 5-8 |
| 5.4.1 | Navigating Local Management Screens..... | 5-9 |
| 5.4.2 | Selecting Local Management Menu Screen Items..... | 5-11 |
| 5.4.3 | Exiting Local Management Screens..... | 5-11 |
| 5.5 | Device Menu Screen..... | 5-13 |
| 5.6 | Device Configuration Menu Screen..... | 5-15 |
| 5.7 | General Configuration Screen..... | 5-17 |
| 5.7.1 | Setting the IP Address..... | 5-21 |
| 5.7.2 | Setting the Subnet Mask..... | 5-22 |
| 5.7.3 | Setting the Default Gateway..... | 5-23 |
| 5.7.4 | Setting the TFTP Gateway IP Address..... | 5-23 |
| 5.7.5 | Setting the Device Date..... | 5-24 |
| 5.7.6 | Setting the Device Time..... | 5-25 |
| 5.7.7 | Entering a New Screen Refresh Time..... | 5-25 |
| 5.7.8 | Setting the Screen Lockout Time..... | 5-26 |
| 5.7.9 | Setting the Operational Mode..... | 5-26 |
| 5.7.10 | Configuring the COM Port..... | 5-28 |
| 5.7.10.1 | Changing the COM Port Application..... | 5-30 |
| 5.7.11 | Clearing NVRAM..... | 5-30 |
| 5.7.12 | Enabling/Disabling IP Fragmentation..... | 5-32 |
| 5.8 | SNMP Community Names Screen..... | 5-33 |
| 5.8.1 | Establishing Community Names..... | 5-35 |

| | | |
|----------|--|------|
| 5.9 | SNMP Traps Screen..... | 5-36 |
| 5.9.1 | Configuring the Trap Table | 5-37 |
| 5.10 | Switch Configuration Screen | 5-38 |
| 5.10.1 | Setting the STA..... | 5-42 |
| 5.10.2 | Setting the Age Time Field | 5-42 |
| 5.10.3 | Setting (Enabling or Disabling) the Port Status | 5-42 |
| 5.11 | Device Specific Configuration Menu Screen | 5-43 |
| 5.12 | System Resources Screen | 5-45 |
| 5.12.1 | Setting the Reset Peak Switch Utilization | 5-46 |
| 5.13 | High Speed Interface Configuration Screen (2H23-50R Only) .. | 5-47 |
| 5.13.1 | Configuring an FE-100FX or FE-100F3 | 5-50 |
| 5.13.1.1 | Setting the FE-100FX or FE-100F3 Operational Mode | 5-50 |
| 5.13.2 | Configuring an FE-100TX | 5-51 |
| 5.13.2.1 | Setting the FE-100TX Operational Mode | 5-51 |
| 5.13.2.2 | Setting the FE-100TX Advertised Ability | 5-51 |
| 5.14 | Flash Download Screen | 5-52 |
| 5.14.1 | Image File Download Using BootP | 5-55 |
| 5.14.2 | Image File Download Using TFTP | 5-55 |
| 5.14.3 | Image File Download Using Runtime | 5-56 |
| 5.15 | Port Redirect Function Screen | 5-57 |
| 5.15.1 | Displaying the Source and Destination Entries..... | 5-59 |
| 5.15.2 | Changing Source and Destination Ports..... | 5-60 |
| 5.16 | Broadcast Suppression Screen | 5-61 |
| 5.16.1 | Setting the Threshold..... | 5-63 |
| 5.16.2 | Setting the Reset Peak | 5-63 |
| 5.17 | The VLAN Main Menu (802.1Q) Screen..... | 5-64 |
| 5.18 | Repeater Configuration Menu Screen | 5-65 |
| 5.19 | Repeater Port Configuration Screen | 5-66 |
| 5.19.1 | Setting the Port Operating Mode | 5-69 |
| 5.19.2 | Enabling /Disabling Ports..... | 5-70 |
| 5.19.3 | Setting All Ports | 5-70 |
| 5.19.4 | Enabling/Disabling Network Ports | 5-71 |
| 5.20 | Device Level Security Configuration..... | 5-71 |
| 5.20.1 | Setting the Module Level Security | 5-74 |
| 5.21 | Port Level Security Configuration Screen..... | 5-75 |
| 5.21.1 | Setting the Port Level Security | 5-78 |
| 5.22 | Device Statistics Menu Screen..... | 5-79 |
| 5.23 | Switch Statistics Screen | 5-81 |
| 5.24 | Interface Statistics Screen..... | 5-83 |
| 5.24.1 | Displaying Interface Statistics | 5-86 |
| 5.24.2 | Using the Clear Counters Command..... | 5-87 |

Contents

| | | |
|--------|---|-------|
| 5.25 | RMON Statistics Screen | 5-87 |
| 5.25.1 | Displaying RMON Statistics | 5-91 |
| 5.25.2 | Using the Clear Counters Command | 5-91 |
| 5.26 | Repeater Statistics Screen | 5-92 |
| 5.26.1 | Displaying Network Statistics | 5-95 |
| 5.26.2 | Displaying Network Port Statistics..... | 5-95 |
| 5.26.3 | Using the Clear Counters Command | 5-96 |
| 5.27 | Network Tools | 5-96 |
| 5.27.1 | Built-in Commands | 5-98 |
| 5.27.2 | Special Commands | 5-107 |

APPENDIX A SPECIFICATIONS

| | | |
|-----|-----------------------------------|-----|
| A.1 | Device Specifications..... | A-1 |
| A.2 | Physical Properties | A-1 |
| A.3 | Electrical Specifications | A-2 |
| A.4 | Environmental Requirements..... | A-2 |
| A.5 | Input/Output Ports..... | A-2 |
| A.6 | COM Port Pinout Assignments | A-3 |
| A.7 | Regulatory Compliance..... | A-3 |

APPENDIX B FE-100TX, FE-100FX, AND FE-100F3 SPECIFICATIONS

| | | |
|-----|----------------|-----|
| B.1 | FE-100TX..... | B-1 |
| B.2 | FE-100FX..... | B-2 |
| B.3 | FE-100F3 | B-3 |

APPENDIX C OPTIONAL INSTALLATIONS AND MODE SWITCH BANK SETTINGS

| | | |
|-------|---|-----|
| C.1 | Required Tools..... | C-1 |
| C.2 | Removing the Chassis Cover | C-2 |
| C.2.1 | Setting the Mode Switches | C-4 |
| C.3 | Installing Optional Fast Ethernet Interface Modules | C-7 |

INDEX

CHAPTER 1

INTRODUCTION

Welcome to the **2H23-50R/2H33-37R SmartSwitch 2100 User's Guide**. This guide provides the necessary documentation to install and operate the 2H23-50R and 2H33-37R SmartSwitch 2100 standalone devices and provides information concerning network requirements, installation, troubleshooting, and the use of Local Management.

1.1 USING THIS GUIDE

Read through this guide completely to understand the 2H23-50R and 2H33-37R capabilities and Local Management functions. A general working knowledge of Ethernet and IEEE 802.3 type data communications networks and their physical layer components is helpful when using this device.



Unless it is noted differently, the information in this guide applies to both the 2H23-50R and 2H33-37R SmartSwitch 2100 devices. The 2H23-50R and 2H33-37R are also referred to as the “device”.

1.2 STRUCTURE OF THIS GUIDE

This guide is organized as follows:

Chapter 1, Introduction, outlines the contents of this manual and briefly describes the 2H23-50R and 2H33-37R features. Directions about how to obtain additional help and a list of related manuals are also included.

Chapter 2, Network Requirements, explains the network requirements to consider before installing the 2H23-50R or the 2H33-37R.

Chapter 3, Installation, provides instructions on how to install the 2H23-50R and 2H33-37R and connect networks to those devices.

Chapter 4, Troubleshooting, describes the function of the LANVIEW LEDs, which can help to quickly diagnose network/operational problems.

Chapter 5, Local Management, describes how to access and use Local Management to configure and manage the 2H23-50R and 2H33-37R.

Appendix A, **Specifications**, contains information on functionality and operating specifications, connector pinouts, environmental requirements, and physical properties.

Appendix B, **FE-100TX, FE-100FX, and FE-100F3 Specifications**, contains information about FE-100TX pinouts and information concerning cable types used with the FE-100FX and FE-100F3.

Appendix C, **Optional Installations and Mode Switch Bank Settings**, describes how to install optional Fast Ethernet Interface Modules and how to set the Mode Switch.

1.3 OVERVIEW

The following provides an overview of the 2H23-50R and 2H33-37R (Figure 1-1) devices:

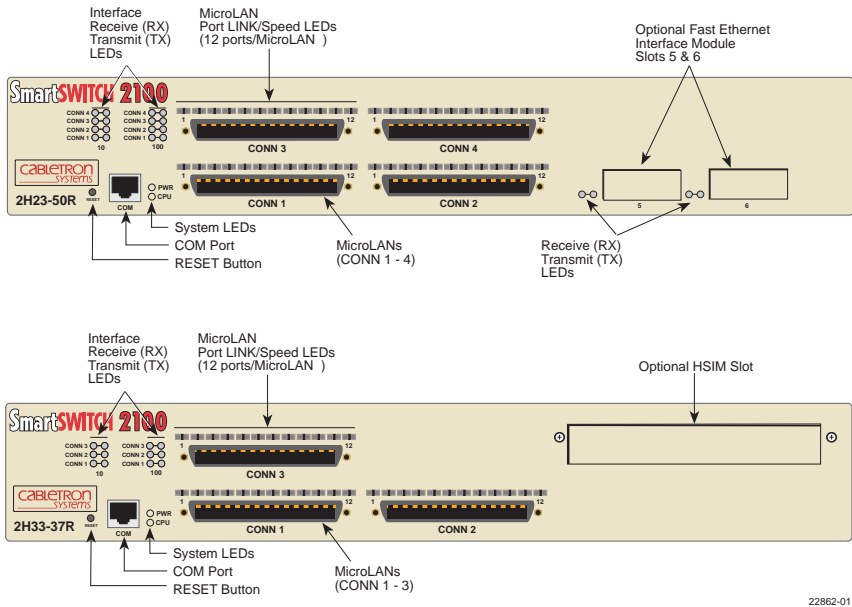

Figure 1-1 2H23-50R and 2H33-37R

The 2H23-50R is a high speed network repeater/switch device that provides four Ethernet networks and four Fast Ethernet networks (RJ21 MicroLANs, CONN 1 through CONN 4) and two slots (5 and 6) for optional Fast Ethernet Interface Modules. The RJ21 connectors each consist of 12 repeater ports that are able to reside on the Ethernet (10 Mbps) or the Fast Ethernet (100 Mbps) network. Each Ethernet and Fast Ethernet network supports 802.1D switching (bridging), Cabletron Systems SecureFast Switching Virtual Network technology and IEEE 802.1Q Port Based Virtual Local Area Networks (VLANs). Slots 5 and 6 support Fast Ethernet Interface Modules to provide uplinks to 100BASE-TX or 100BASE-FX Fast Ethernet Networks.

The 2H33-37R is a high speed network repeater/switch device that provides three Ethernet networks and three Fast Ethernet networks (RJ21 MicroLANs, CONN 1 through CONN 3) and one slot for an optional High Speed Interface Module (HSIM). The RJ21 connectors each consist of 12 repeater ports that are able to reside on the Ethernet (10 Mbps) or the Fast Ethernet (100 Mbps) network. Each Ethernet and Fast Ethernet network supports 802.1D switching (bridging), Cabletron Systems SecureFast Switching Virtual Network technology and IEEE 802.1Q Port Based Virtual Local Area Networks (VLANs). The 2H33-37R can be equipped with an optional HSIM to provide additional connectivity to other high speed networking technologies such as Asynchronous Transfer Mode (ATM), Fiber Distributed Data Interface (FDDI), and Wide Area Network (WAN).

The device may be used as a tabletop unit or can be installed in a standard 19-inch rack using the supplied rack mounting hardware.

The 2H23-50R and 2H33-37R have two power supplies with automatic voltage sensing that allows operation using 100–125 or 200–240 Vac, 50/60 Hz. The power supplies load share 50% (+/-5%) of the power required by the device. If one power supply fails, the remaining power supply assumes the entire load of the device without interruption to network traffic. Each power supply module supports its own ac input connection, which allows the user to connect each power supply to a different ac power circuit.

1.3.1 Connectivity

The 2H23-50R or 2H33-37R connect to Ethernet/Fast Ethernet networks or workstations through RJ21 ports on the front panel. Each port supports a 25-pair cable at lengths up to 100 meters (each pair must be Category 5 compliant with an impedance of 85 to 111 ohms). The ports are IEEE 802.3 10BASE-T and IEEE 802.3u 100BASE-T compliant.

The 2H23-50R has two front panel slots (5 and 6) for optional Fast Ethernet Interface Modules to support an uplink to Fast Ethernet backbones or a high speed connection to a local server.

The 2H33-37R has a slot for an optional HSIM to provide additional connectivity to high speed networking technologies such as ATM, FDDI, and WANs.

Cables available for 100BASE-TX operation include:

- 180° angle connector (straight-through RJ2-to-RJ21)
- 180° RJ21-to-RJ45 connector
- 120° angle connector with the same options

1.3.2 Full Duplex Switched Ethernet

The optional Fast Ethernet Interface Modules for the 2H23-50R can be configured to operate in Full Duplex Switched Ethernet mode, which provides 200 Mbps of bandwidth.

1.3.3 Auto-Negotiation

The repeater ports and Fast Ethernet Interface Modules can auto-negotiate the type of connection required to provide a link to another device.

During Auto-Negotiation, two devices automatically exchange information “telling” each other what their operating capabilities are. The Auto-Negotiation feature targets the maximum capabilities that can be reached between the two devices. For example, an FE-100TX Fast Ethernet Interface Module in a 2H23-50R can adjust to 100 Mbps when the device on the other end of the connection can also adjust to 100 Mbps. If the device on the other end of the connection can only operate at 10 Mbps, then the FE-100TX simply adjusts to 10 Mbps operation.

When Auto-Negotiation is supported at both ends of a link, the two devices dynamically adjust to full or half duplex operation based on the maximum capability that can be reached between the two devices. If the device connected to the FE-100TX cannot auto-negotiate, the FE-100TX Fast Ethernet Interface Module operates according to the capabilities of the other device.

1.3.4 SmartTrunking

SmartTrunk, also referred to as SmartTrunking, is Cabletron Systems' terminology for load balancing or load sharing. SmartTrunk technology provides an easy-to-implement mechanism to group, or aggregate, multiple physical links together to scale the backbone bandwidth beyond the limitations of a single link. All links are user-configurable so administrators can scale the backbone bandwidth by adding SmartTrunk links. The SmartTrunk benefits are as follows:

- All purchased bandwidth is used.
- Distributed, resilient links increase reliability and performance.
- Multiple technologies are supported within a single trunk for maximum flexibility.

For more information about SmartTrunk, refer to the Cabletron Systems *SmartTrunk User's Guide*.

1.3.5 Runtime IP Address Discovery

This feature enables the 2H23-50R or 2H33-37R (device) to automatically accept an IP address from a Boot Strap Protocol (BootP) or Reverse Address Resolution Protocol (RARP) server on the network into NVRAM without requiring a user to enter an IP address through Local Management.

When the device is connected to the network and powered up, Runtime IP Address Discovery (RAD) checks the device for an IP address. If one has not yet been assigned (2H23-50R IP address set to 0.0.0.0), RAD checks to see if any of the device's interfaces have a link. If so, RAD sends out RARP and BootP requests to obtain an IP address from a server on the network.

The RAD requests start out at an interval of 1 second. The interval then doubles after every transmission until an interval of 300 seconds is reached. At this point, the interval remains at 300 seconds. The RAD requests continue until an IP address is received from a server, or an IP address is entered using Local Management.

1.3.6 Management

Management of the 2H23-50R or 2H33-37R is accomplished using SNMP compliant management tools for in-band Local Management. Out-of-band Local Management is provided through the RJ45 COM port on the front panel using a VT100 terminal or a VT100 terminal emulator. In-band remote management is possible through any SNMP compliant Network Management Software.

Local Management provides the ability to manage the 2H23-50R and 2H33-37R and any of the optional Fast Ethernet Interface Modules installed in slots 5 and 6 of the 2H23-50R, or an optional High Speed Interface Module (HSIM) in a 2H33-37R.

The associated HSIM user's guide provides detailed information about the HSIM Local Management.

1.3.7 Switching Options

The 2H23-50R and 2H33-37R provide 802.1D switching, 802.1Q switching or SecureFast Switching Virtual Network Services between all of the front panel interfaces including Fast Ethernet Interface Modules installed in a 2H23-50R or an HSIM installed in a 2H33-37R.

IEEE 802.1Q switching and SecureFast switching allow for future migration to Virtual Network technologies without requiring the replacement of existing equipment.

1.3.8 Standards Compatibility

The 2H23-50R provides IEEE 802.1D Spanning Tree Algorithm (STA) support to enhance the overall reliability of the network and protect against “loop” conditions. The 2H23-50R also supports 100BASE-TX and 100BASE-FX Fast Ethernet standards and a wide variety of industry standard MIBs including RFC 1213 (MIB II), RFC 1757 (RMON), RFC 1317 (RS232 MIB), RFC 1493 (Bridge MIB) and RFC 1354 (FIB MIB). A full suite of Cabletron Systems Enterprise MIBs provide a wide array of statistical information to enhance troubleshooting.

1.3.9 Year 2000 Compliant

The 2H23-50R and 2H33-37R each have an internal clock that can maintain the current time and date beyond the year 1999.

1.3.10 LANVIEW Diagnostic LEDs

LANVIEW diagnostic LEDs serve as an important troubleshooting aid by providing an easy way to observe the status of individual ports and overall network operations.

1.4 OPTIONAL FEATURES

Options for the 2H23-50R and 2H33-37R include the following:

- Fast Ethernet Interface Modules supported on 2H23-50R only
- High Speed Interface Modules supported on 2H33-37R only

1.4.1 Fast Ethernet Interface Modules

Cabletron Systems provides Fast Ethernet Interface Modules to support uplinks to 100 Mbps Fast Ethernet backbones or high speed connections to local servers. The Fast Ethernet Interface Modules available for the 2H23-50R are listed in [Table 1-1](#).

Table 1-1 Fast Ethernet Interface Modules

| P/N | Description | Application |
|----------|---------------------|---|
| FE-100TX | Uses RJ45 connector | Supports Category 5 Unshielded Twisted Pair (UTP) cabling, which has an impedance of 85 to 111 ohms, and type 1A Shielded Twisted Pair (STP) cabling. |
| FE-100FX | Uses SC connector | Supports multimode fiber optic cabling. |
| FE-100F3 | Uses SC connector | Supports single mode fiber optic cabling. |

1.4.2 High Speed Interface Modules

High Speed Interface Modules (HSIMs) are available from Cabletron Systems for additional connectivity to various networking technologies. The HSIMs available for the 2H33-37R are listed in the Release Notes shipped with the device.

1.5 DOCUMENT CONVENTIONS

The following conventions are used throughout this document:

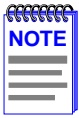

Note symbol. Calls the reader's attention to any item of information that may be of special importance.



Tip symbol. Conveys helpful hints concerning procedures or actions.



Caution symbol. Contains information essential to avoid damage to the equipment.



Electrical Hazard Warning symbol. Warns against an action that could result in personal injury or death due to an electrical hazard.



Warning symbol. Warns against an action that could result in personal injury or death.

1.6 GETTING HELP

For additional support related to this device or document, contact the Cabletron Systems Global Call Center:

| | |
|--|---|
| World Wide Web | http://www.cabletron.com/ |
| Phone | (603) 332-9400 |
| Internet mail | support@cabletron.com |
| FTP | ftp://ftp.cabletron.com/ |
| Login | <i>anonymous</i> |
| Password | <i>your email address</i> |
| To send comments or suggestions concerning this document, contact the Cabletron Systems Technical Writing Department via the following email address: TechWriting@cabletron.com <i>Make sure to include the document Part Number in the email message.</i> | |

Before calling the Cabletron Systems Global Call Center, have the following information ready:

- Your Cabletron Systems service contract number
- A description of the failure
- A description of any action(s) already taken to resolve the problem (e.g., changing mode switches, rebooting the unit, etc.)
- The serial and revision numbers of all involved Cabletron Systems products in the network
- A description of your network environment (layout, cable type, etc.)
- Network load and frame size at the time of trouble (if known)
- The device history (i.e., have you returned the device before, is this a recurring problem, etc.)
- Any previous Return Material Authorization (RMA) numbers

1.7 RELATED MANUALS

The following manuals may help to set up, control, and manage the 2H23-50R and 2H33-37R:

Cabletron Systems *HSIM-A6DP User's Guide*

Cabletron Systems *HSIM-F6 User's Guide*

Cabletron Systems *HSIM-FE6 User's Guide*

Cabletron Systems *HSIM-W87 User's Guide*

Cabletron Systems *HSIM-G01/G09 User's Guide*

Cabletron Systems *Ethernet Technology Guide*

Cabletron Systems *Cabling Guide*

Cabletron Systems *Port Based VLAN User's Guide*

Cabletron Systems *SmartTrunk User's Guide*

These manuals can be obtained from the World Wide Web in Adobe Acrobat Portable Document Format (PDF) at the following site:

<http://www.cabletron.com/>



All documentation for the Cabletron Systems SecureFast VLAN Manager software is contained on the VLAN Manager CD-ROM.

Documents for the Cabletron Systems HSIM-W6 and HSIM-W84 devices are contained on the QuickSET CD-ROM and are also available on the World Wide Web at:
<http://www.cabletron.com/>

CHAPTER 2

NETWORK REQUIREMENTS

This chapter contains networking guidelines. Before installing and using the 2H23-50R or an optional Fast Ethernet Interface Module, review the requirements and specifications outlined in this chapter concerning the following:

- SmartTrunk (Section 2.1)
- 10BASE-T Twisted Pair Network (Section 2.2)
- 100BASE-TX Twisted Pair Network (Section 2.3)
- 100BASE-FX Fiber Optic Network (Section 2.4)

The network installation must meet the guidelines to ensure satisfactory performance of this equipment. Failure to follow the guidelines may produce poor network performance.



The Cabletron Systems *Cabling Guide* and *SmartTrunk User's Guide*, referred to in the following sections, is located on the Cabletron Systems World Wide Web site: <http://www.cabletron.com/>

2.1 SmartTrunk

To connect the 2H23-50R or 2H33-37R into a network so that it can take advantage of the SmartTrunk feature, there are certain rules concerning port connections and configurations that must be followed for proper operation. Refer to the Cabletron Systems *SmartTrunk User's Guide* for additional information.

2.2 10BASE-T NETWORK

When connecting a 10BASE-T segment to any ports of CONN 1 through CONN 4 (2H23-50R) or CONN 1 through CONN 3 (2H33-37R), ensure that the network meets the IEEE 802.3 Ethernet network requirements for 10BASE-T. Refer to the Cabletron Systems *Cabling Guide* for details.

2.3 100BASE-TX NETWORK

When connecting a 100BASE-T segment to any ports of CONN 1 through CONN 4 (2H23-50R), CONN 1 through CONN 3 (2H33-37R), or an FE-100TX installed in slot 5 or 6 of the 2H23-50R, the device at the other end of the twisted pair segment must meet IEEE 802.3u 100BASE-TX Fast Ethernet network requirements for the devices to operate at 100 Mbps. Refer to the Cabletron Systems *Cabling Guide* for details.

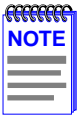

The 2H23-50R with an FE-100TX installed is capable of operating at either 10 or 100 Mbps. The FE-100TX can automatically sense the speed of the other device and adjust its speed accordingly.

If operating at 100 Mbps, each pair in a cable must be Category 5 compliant with an impedance of 85 to 111 ohms.

2.4 100BASE-FX FIBER OPTIC NETWORK

Slots 5 and 6 of the 2H23-50R can also support the Cabletron Systems FE-100FX and FE-100F3 fiber optic interface modules. The device at the other end of the fiber optic segment must meet the 100BASE-FX Fast Ethernet network requirements to operate at 100 Mbps. Refer to the Cabletron Systems *Cabling Guide* for details.

Multimode Fiber Optic Cable Length

The maximum multimode fiber optic cable length of a 100BASE-FX segment is covered in the Cabletron Systems *Cabling Guide*.

Single Mode Fiber Cable Lengths

The maximum single mode fiber optic length of a 100BASE-FX segment may be no more than 5 km between Data Terminal Equipment (DTE to DTE) in half duplex mode or 20 km (DTE to DTE) in full duplex mode.

CHAPTER 3

INSTALLATION



Only qualified personnel should install the 2H23-50R or 2H33-37R.

This chapter provides the instructions required to install the 2H23-50R or 2H33-37R. Follow the order of the sections listed below to ensure a proper installation.

- Required Tools ([Section 3.1](#))
- Unpacking the Device ([Section 3.2](#))
- Installing Options ([Section 3.3](#))
- Installing the Device (on a shelf or tabletop, or into a standard rack) ([Section 3.4](#))
- Connecting to the Network ([Section 3.5](#))
- Completing the Installation ([Section 3.6](#))

3.1 REQUIRED TOOLS

A Phillips screwdriver is required to install the 2H23-50R and 2H33-37R.

3.2 UNPACKING THE DEVICE

To unpack the device and verify the contents of the shipment, proceed as follows:

1. Open the carton and remove the packing material.
2. Verify the contents of the carton as listed in [Table 3-1](#).

Table 3-1 Contents of Carton

| Item | Quantity |
|------------------------|----------|
| 2H23-50R or 2H33-37R | 1 |
| Antistatic Wrist Strap | 1 |
| Console Cable Kit | 1 |
| Rackmount Kit | 1 |
| Strain-Relief Bracket | 1 |
| Release Notes | 1 |
| Power Cord | 2 |
| Manual Accessory Kit | 1 |

3. Remove the black and yellow tape seal on the non-conductive bag to remove the device.
4. Perform a visual inspection of the device for any signs of physical damage. If there are any items missing or damaged, contact the Cabletron Systems Global Call Center as described in [Section 1.6](#).

3.3 INSTALLING OPTIONS



Install any optional equipment before proceeding to [Section 3.4](#).

If the 2H23-50R is to be installed with an optional Fast Ethernet Interface Module, refer to [Appendix C](#) for installation instructions. If the 2H33-37R is to be installed with an optional HSIM, refer to the installation instructions in the associated HSIM user's guide.

3.4 INSTALLING THE DEVICE

The 2H23-50R and 2H33-37R may be installed on a tabletop, shelf, or in a 19-inch rack. [Section 3.4.1](#) describes a tabletop or shelf installation, and [Section 3.4.2](#) describes the rackmount installation.



To prevent possible personal injury and/or damage to the unit, do **NOT** connect power to the device until instructed to do so.

3.4.1 Tabletop or Shelf Installation

The following two subsections provide guidelines for installation on a tabletop or shelf.

Guidelines for Tabletop and Shelf Installations

Tabletop and shelf installations must be within reach of the network cabling and meet the requirements listed below:

- Locate the 2H23-50R or 2H33-37R within seven feet of an appropriately grounded power receptacle that meets the power supply requirements listed in [Appendix A](#).
- In a shelf installation, ensure that the shelf can support 13.6 kg (30 lb) of static weight for each device.
- Maintain a temperature between 5°C (41°F) and 40°C (104°F) at the installation site with fluctuations of less than 10°C (18°F) per hour.
- Maintain a 2-inch clearance from the left, right, and rear sides of the device to provide adequate ventilation.

Installation

For a tabletop or shelf installation, locate the device within seven feet of its power source and with an unrestricted free surface area as shown in [Figure 3-1](#). Proceed to [Section 3.4.3](#) for power connection instructions.



To ensure proper ventilation and prevent overheating, leave a minimum clearance space of 5.1 cm (2.0 in) at the left, right, and rear of the device.

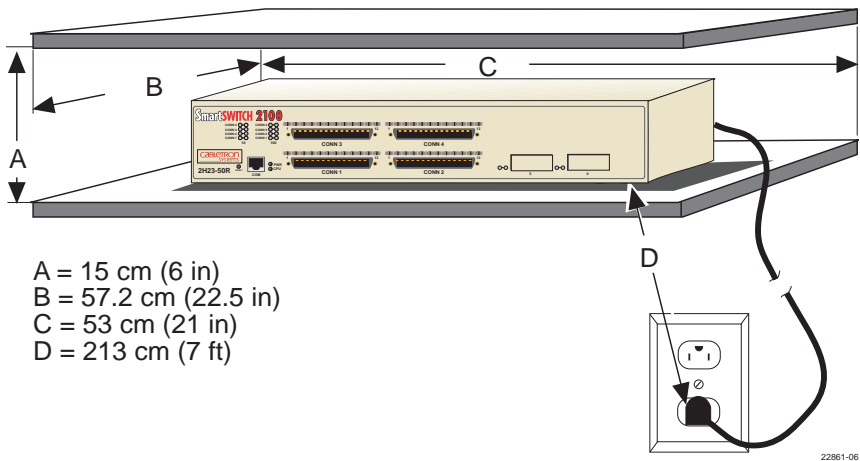

Figure 3-1 Tabletop or Shelf Installation

3.4.2 Rackmount Installation

To install the device in a 19-inch rack, note that the device is shipped with a rackmount kit containing the rackmount brackets, mounting screws, and a strain-relief bracket for cable management.

Guidelines for the Rackmount Installation

The installation site must be within reach of the network cabling and meet the requirements listed below:

- Ensure that an appropriate grounded power receptacle is located within seven feet of the location.
- Maintain a temperature of between 5°C (41°F) and 40°C (104°F) at the installation site with fluctuations of less than 10°C (18°F) per hour.



To ensure proper ventilation and prevent overheating, leave a minimum clearance space of 5.1 cm (2.0 in) at the left, right, and rear of the device.



Before installing the device into a rack, ensure that the rack supports the device(s) without compromising the stability of the rack. Otherwise, personal injury and/or equipment damage may result.

Installation

Rack mounting the 2H23-50R or 2H33-37R involves the following:

- Attaching the strain-relief bracket
- Rack mounting the device (attaching the mounting brackets and fastening the device to the rack)

Attaching the Strain-Relief Bracket

Attach the strain-relief bracket to the front of the device as follows:

1. Locate the strain-relief bracket and four 8-32 x 3/8-inch pan-head screws in the rackmount kit.



Do not attempt to attach the strain-relief bracket with screws other than the 8-32 x 3/8-inch screws included with the 2H23-50R. Use of longer screws will damage the unit.

2. Attach the strain-relief bracket to the bottom of the device using the four 8-32 x 3/8-inch pan-head screws (Figure 3-2).

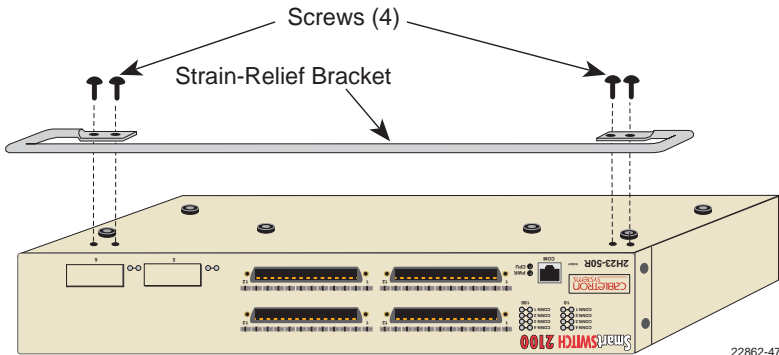

Figure 3-2 Attaching the Strain-Relief Bracket

Rack Mounting the Device

Proceed as follows to install the 2H23-50R or 2H33-37R into a 19-inch rack:

1. Remove and discard the four cover screws (two from each side) located along the front edges of each side of the device.
2. Locate the four 6-32 x 3/8-inch flathead cover replacement screws in the rackmount kit. Use these screws to attach the rackmount brackets to the device as shown in [Figure 3-3](#).

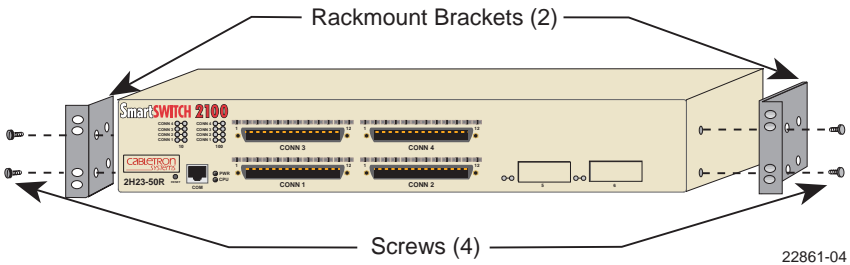

Figure 3-3 Installing the Rackmount Brackets

3. With the mounting brackets installed, position the device between the vertical frame members of the 19-inch rack and fasten it securely with user supplied mounting screws as shown in [Figure 3-4](#).

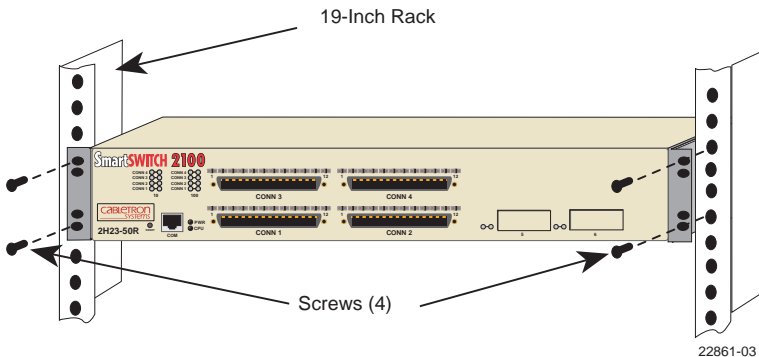
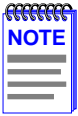

Figure 3-4 Installing the Device in a Rack

3.4.3 Connecting Power to the Device



The 2H23-50R and 2H33-37R have two power supplies. The power supplies have automatic voltage sensing that allows connection to power sources ranging from 100–125 Vac, 2.0 A or 200–240 Vac, 1.0 A, 50/60 Hz.

To connect the device to the power sources, proceed as follows:

1. Plug each power cord into a grounded wall outlet, see [Figure 3-5](#). To take advantage of the load sharing and redundancy capabilities, each power cord must be plugged into a dedicated ac outlet. The POWER LED turns on (green) and the CPU LED turns on (green) briefly.

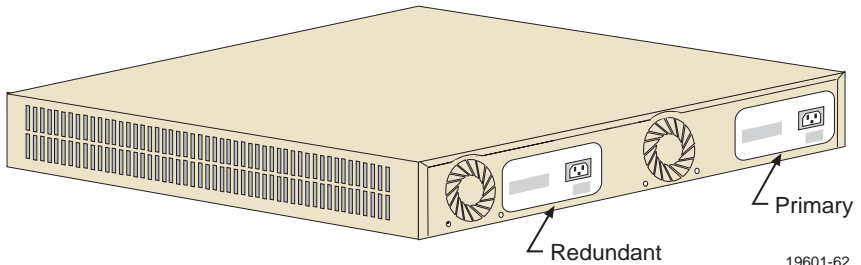
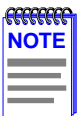

Figure 3-5 Rear View, 2H23-50R or 2H33-37R



It takes approximately one minute for the device to boot up.

2. Observe the LANVIEW LEDs. After a successful boot, the CPU LED turns on (green). If the PWR LED is not green after one minute and turns amber, there is no power redundancy. Check the power cord connections and the power source. If there are no problems with the power cord connections or power source and the CPU LED is still not green, contact the Cabletron Systems Global Call Center. Refer to [Section 1.6](#) for details.

3.5 CONNECTING TO THE NETWORK

This section provides the procedures for connecting twisted pair and fiber optic segments from the network or other devices to the 2H23-50R or 2H33-37R.

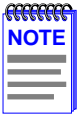

If the device is being installed in a network using SmartTrunking, there are rules concerning the cable connections and port configurations that must be followed for SmartTrunking to operate properly. Before connecting the cables, refer to the Cabletron Systems *SmartTrunk User's Guide* for the configuration information.

CONN 1 through CONN 4 (2H23-50R) or CONN 1 through CONN 3 (2H33-37R) each have 12 UTP connections via a 50-pin RJ21 connector. If a port is to operate at 100 Mbps, each pair in a cable must be Category 5 compliant with an impedance of 85 to 111 ohms.

Slots 5 and 6 of the 2H23-50R support FE-100TX, FE-100FX, or FE-100F3 Fast Ethernet Interface Modules. The FE-100TX has an RJ45 connector for a UTP cable connection. The FE-100FX and FE-100F3 have SC connectors for fiber optic cable connections.

To make twisted pair connections to CONN 1 through CONN 4 (2H23-50R) or CONN 1 through CONN 3 (2H33-37R), refer to [Section 3.5.1](#).

To make a twisted pair connection to an FE-100TX in slot 5 or 6 of a 2H23-50R, refer to [Section 3.5.2](#).

To make a fiber optic cable connection to an FE-100FX or FE-100F3 in slot 5 or 6 of a 2H23-50R, refer to [Section 3.5.3](#).

Refer to the associated High Speed Interface Module user's guide to make connections to an optional High Speed Interface Module installed in the HSIM slot of a 2H33-37R.

3.5.1 Connecting Cables to CONN 1 Through 4

The device uses RJ21 connectors for the cables connected to CONN 1 through CONN 4 (2H23-50R) or CONN 1 through CONN 3 (2H33-37R). Each of the 12 repeater ports associated with each RJ21 connector have internal crossovers.

To connect an RJ21, proceed as follows:

1. Ensure that the device connected to the other end of the segment is powered on.
2. If using an RJ21 straight connector, plug it into the appropriate RJ21 port as shown in [Figure 3-6](#).

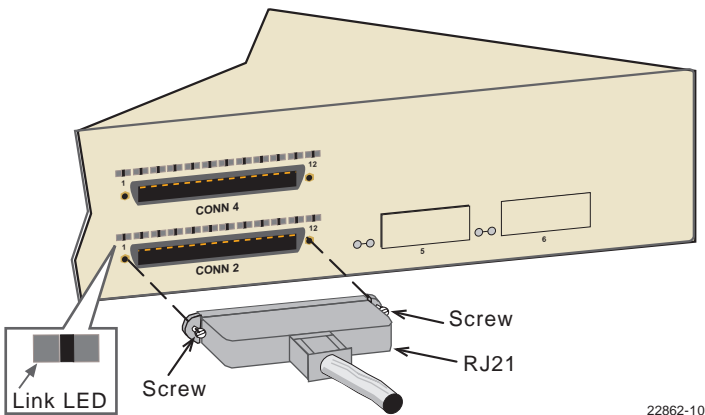

22862-10

Figure 3-6 Straight Cable Connection

3. Tighten the two screws on the RJ21 straight cable connector to secure it to the device.

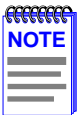

The cable pinouts for a 25-pair cable (RJ21) can be found in the Cabletron Systems *Cabling Guide*. Refer to [Section 1.7](#) for details on how to obtain this document.

4. Verify that a link exists on each twisted pair segment of the RJ21 connector by checking that the port Link LEDs above the connector are on (flashing amber, blinking green, or solid green). If any of the Link LEDs are off, perform the following steps to check the associated twisted pair segments. The problem is resolved when the Link LED comes on.
 - a. Verify that the device at the other end of the twisted pair segment is on and connected to the segment.
 - b. Verify that the RJ21 connector associated with the twisted pair segment has the proper pinouts and check the cable for continuity.
 - c. Check that the twisted pair connection meets the dB loss and cable specifications outlined in [Chapter 2](#).

If a link is not established, contact the Cabletron Systems Global Call Center. Refer to [Section 1.6](#) for details.

5. Repeat steps 1 through 5 above, until all connections have been made.

3.5.2 Connecting a UTP Segment to the FE-100TX



To ensure proper operation, use only Category 5 Unshielded Twisted Pair (UTP) cabling that has an impedance between 85 and 111 ohms.

An FE-100TX installed in slot 5 and/or 6 of a 2H23-50R has an internal crossover switch. When connecting a workstation, use a straight-through cable and set the Fast Ethernet Interface Module crossover switch shown in [Figure 3-7](#) to the crossed over position marked with X. When connecting networking devices, such as another bridge, repeater, or router, use a straight-through cable and set the Fast Ethernet Interface Module crossover switch shown in [Figure 3-7](#) to the straight-through position (not crossed over), marked with =.

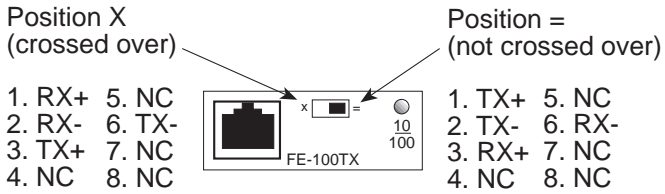

16651_05

Figure 3-7 FE-100TX Crossover Switch

A schematic of a crossover cable is shown in Figure 3-8. If the wires do not cross over, use the switch on the FE-100TX to internally cross over the RJ45 port.

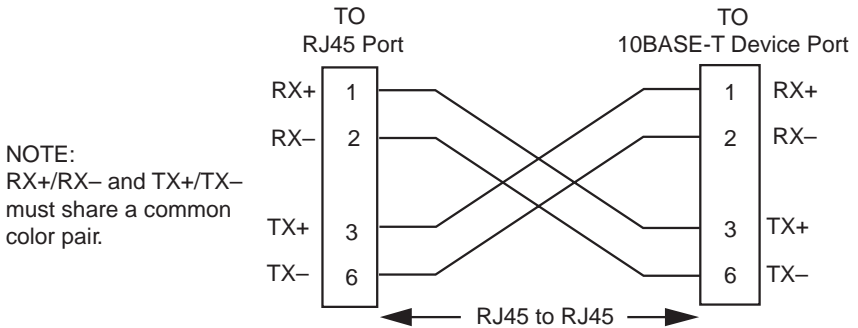

2251-31

Figure 3-8 Cable Pinouts - RJ45 Crossover Cable

Connect an FE-100TX to a twisted pair segment as follows:

1. Ensure that the device connected to the other end of the segment is powered on.

2. Connect the twisted pair segment to the module by inserting the RJ45 connector on the twisted pair segment into the RJ45 port on the module shown in [Figure 3-9](#).

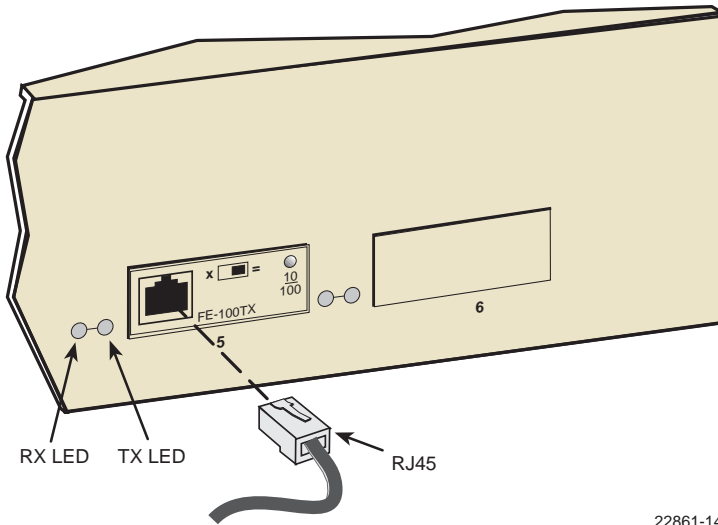

Figure 3-9 FE100-TX Port Connection

22861-14

3. Verify that a link exists by checking that the port RX LED is on (flashing amber, blinking green, or solid green). If the RX LED is off and the TX LED is not blinking amber, perform the following steps until the RX LED is on:
 - a. Verify that the 100BASE-TX device at the other end of the twisted pair segment is powered up.
 - b. Verify that the RJ45 connector on the twisted pair segment has the proper pinouts.
 - c. Check the cable for continuity.
 - d. Make sure that the twisted pair connection meets the cable specifications outlined in [Section 2.2](#).
 - e. Confirm that the crossover switch is in the correct position.

If a link is not established, contact the Cabletron Systems Global Call Center. Refer to [Section 1.6](#) for details.

3.5.3 Connecting a Fiber Optic Segment to the FE-100FX and FE-100F3

The FE-100FX and FE-100F3 have SC style network ports. See [Figure 3-10](#). Cabletron Systems offers optional fiber optic cables that use SC style connectors. The ST connectors are keyed to ensure proper crossover of the transmit and receive fibers.

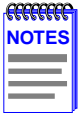

An odd number of crossovers (preferably one) must be maintained between devices so that the transmit port of one device is connected to the receive port of the other device and vice versa.

If the fiber optic cable being used has SC style connectors that do not resemble MIC style connectors, or has SC connectors on one end and a different type on the other, such as ST connectors, ensure that the proper crossing over occurs.

Fiber Optic Network Connection

1. Remove the protective plastic covers from the fiber optic ports on the applicable port on the module and from the ends of the connectors.



The FE-100F3 uses Class 1 lasers. Do not use optical instruments to view the laser output. The use of optical instruments to view laser output increases eye hazard. When viewing the output optical port, power must be removed from the network adapter.



Do not touch the ends of the fiber optic strands, and do not let the ends come in contact with dust, dirt, or other contaminants. Contamination of the ends causes problems in data transmissions. If the ends become contaminated, blow the surfaces clean with a canned duster. A fiber port cleaning swab saturated with optical-grade isopropyl alcohol may also be used to clean the fiber optic ends.

2. Insert the SC connector at one end of the fiber optic cable into the FE-100FX or FE-100F3 installed in the 2H23-50R. See [Figure 3-10](#).

- At the other end of the fiber optic cable, attach the SC connector to the other device.

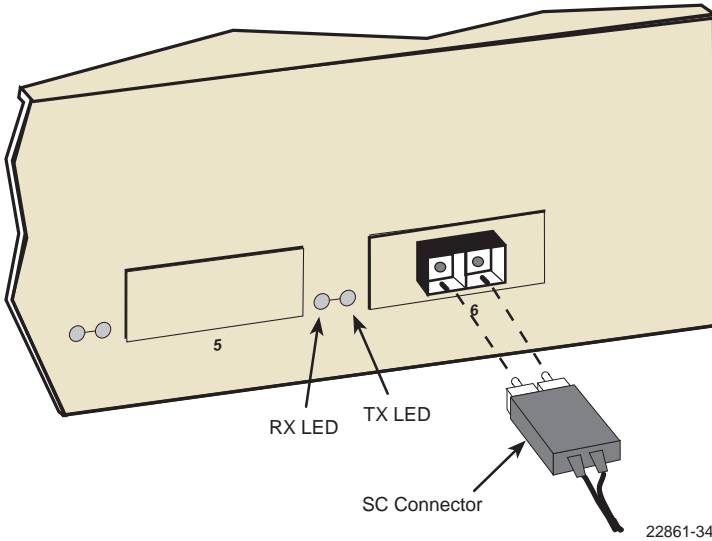

Figure 3-10 Fiber Optic Cable Connection

- Verify that a link exists by checking that the port RX LED is on (flashing amber, blinking green, or solid green). If the RX LED is off and the TX LED is not blinking amber, perform the following steps until the RX LED is on:
 - Check that the power is turned on for the device at the other end of the link.
 - Verify proper crossover of fiber strands between the applicable port on the 2H23-50R and the fiber optic device at the other end of the fiber optic link segment.
 - Verify that the fiber connection meets the dB loss specifications outlined in [Section 2.4](#).

If a link has not been established, contact the Cabletron Systems Global Call Center. Refer to [Section 1.6](#) for details.

3.6 COMPLETING THE INSTALLATION

After installing the 2H23-50R and any optional Fast Ethernet Interface Modules and HSIM as appropriate, and making the connections to the network, proceed as follows:

1. Secure the cables by running the cables along the strain-relief bracket and tying them to the strain-relief bracket using cable ties.
2. The 2H23-50R is now ready to be set up through Local Management. Refer to **Chapter 5, Local Management**, for information on how to access and use Local Management to configure the 2H23-50R.

CHAPTER 4

TROUBLESHOOTING

This chapter provides information concerning the following:

- Using LANVIEW diagnostic and status monitoring system (Section 4.1)
- The FE-100TX LED (Section 4.2)
- Troubleshooting checklist for network and device operational problems (Section 4.3)
- Using the RESET button (Section 4.4)

4.1 USING LANVIEW

The 2H23-50R and 2H33-37R use Cabletron Systems built-in visual diagnostic and status monitoring system called LANVIEW. The LANVIEW LEDs, shown in Figure 4-1 and Figure 4-2, allow quick observation of the network status to aid in diagnosing network problems. Refer to Table 4-1 for a description of the LEDs.

For a functional description of the LANVIEW LED on the optional Fast Ethernet Interface Module (FE-100TX) that can be installed in a 2H23-50R, refer to Section 4.2.

For a functional description of the LANVIEW LED on an optional HSIM installed in a 2H33-37R, refer to the user's guide for that HSIM.

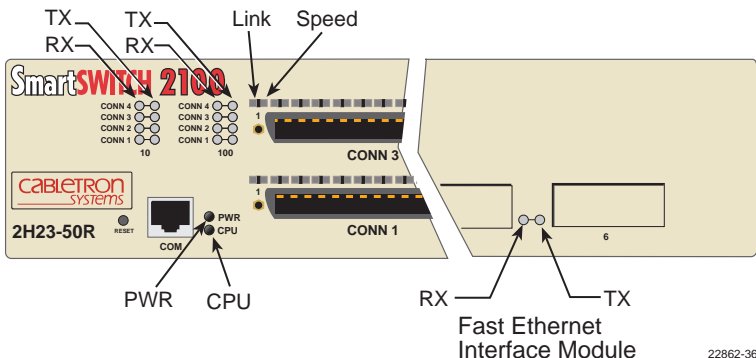

22862-36

Figure 4-1 LANVIEW LEDs (2H23-50R)

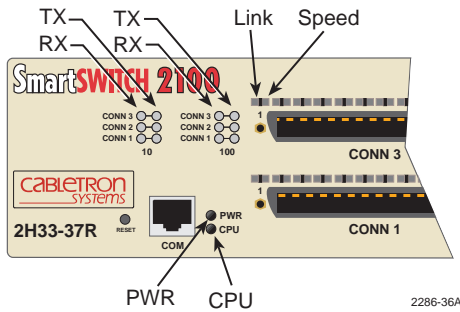
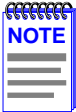

Figure 4-2 LANVIEW LEDs (2H33-37R)



The terms **flashing**, **blinking**, and **solid** used in the following tables indicate the following:

Flashing indicates an LED flashing randomly.

Blinking indicates an LED is flashing at a steady rate (approximately 50% on, 50% off).

Solid indicates a steady LED light. No pulsing.

Table 4-1 LANVIEW LEDs

| LED | Color | State | Recommended Action |
|---|--|--|--|
| PWR | Green | Functional. Power supplies operating normally. | No action. |
| | Amber | Indicates loss of power supply redundancy. | 1.Ensure that the power cords are plugged in correctly and that there is power at the power source. 2.If the LED remains amber, contact the Cabletron Systems Global Call Center. |
| CPU | Off | Power off. | Power up device. |
| | Red | Blinking. Hardware failure has occurred. | Contact the Cabletron Systems Global Call Center. |
| | | Solid. Resetting, normal power up reset. | No action. |
| | Amber | Blinking. Crippled. | Contact the Cabletron Systems Global Call Center. |
| | | Solid. Testing. | No action. |
| | Green | Solid. Functional. | No action. |
| Amber and Green | Booting. Blinks amber and green while booting. | No action. | |
| Interface RX (Receive) of CONN 1–CONN 4 and Ports 5 and 6 or CONN 1–CONN 3 (2H23-50R) | Off | No link. No activity. Port enabled or disabled. | No error. |
| | Green | Solid. Port enabled, link, no activity. | No error. |
| | | Blinking. Port disabled, link. | No error. |
| | Amber | Flashing. Port enabled, link, activity. | No error. |
| Red | Diagnostic failure. | Contact the Cabletron Systems Global Call Center for help. | |

Table 4-1 LANVIEW LEDs (Continued)

| LED | Color | State | Recommended Action |
|---|-------|--|--|
| Interface TX (Transmit) of CONN 1–CONN 4 and Ports 5 and 6 (2H23-50R) or CONN 1 – CONN 3 (2H33-37R) | Off | Port enabled, and no activity. Should flash green every two seconds indicating BPDUs being sent if STA is enabled and there is a valid link. | 1. Ensure that the STA is enabled and that there is a valid link. 2. Contact the Cabletron Systems Global Call Center for help. |
| | Green | Flashing. Indicates activity. Rate indicates data rate. | No action. |
| | Amber | Blinking. Port in standby. Port may be disabled due to Spanning Tree. | 1. Ensure that the port is not disabled. 2. Contact the Cabletron Systems Global Call Center for help. |
| | Red | Flashing. Indicates collision rate. | No action. |
| | | Solid. Diagnostic failure. | Contact the Cabletron Systems Global Call Center for help. |
| LINK Ports of CONN 1–CONN 4 (2H23-50R) or CONN 1 – CONN 3 (2H33-37R) | Off | No link. | No action. |
| | Green | Solid. A link is established with the device connected to the port. | No action. |
| | | Flashing. Link established, but administratively disabled. | No action. |
| | Amber | Flashing. Link established, receive activity. | No action. |

Table 4-1 LANVIEW LEDs (Continued)

| LED | Color | State | Recommended Action |
|--|---|-----------------------------------|--------------------|
| Speed Ports of CONN 1 – CONN 4 (2H23-50R) or CONN 1 – CONN 3 (2H33-37R) | Off and LINK LED is Green or Amber | Port is operating at 10 Mbps. | No action. |
| Speed Ports of CONN 1 – CONN 4 (2H23-50R) or CONN 1 – CONN 3 (2H33-37R) | Green and LINK LED is Green or Amber | Port is operating at 100 Mbps. | No action. |

4.2 FE-100TX LED

The optional FE-100TX has one LED labeled 10/100. The 10/100 LED together with the RX LED allows the user to determine the link status and the operating speed of the Fast Ethernet Interface Module. The 10/100 LED and the Receive (RX) LED are shown in [Figure 4-3](#).

[Table 4-2](#) and [Table 4-3](#) provide a functional description of the 10/100 LED when the RX LED is on or off, respectively.

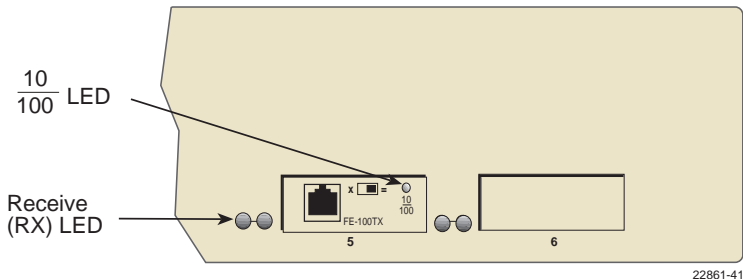

22861-41

Figure 4-3 FE-100TX LED

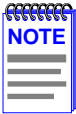

A link exists if the associated port (5 or 6) RX LED is on.

Table 4-2 10/100 LED Indications When RX LED Is On

| LED | Color | Indication |
|--------|-------|------------------------------------|
| 10/100 | Off | FE-100TX is operating at 10 Mbps. |
| | Green | FE-100TX is operating at 100 Mbps. |

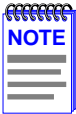

No link exists if the associated port (5 or 6) RX LED is off.

Table 4-3 10/100 LED Indications When RX LED Is Off

| LED | Color | Indication |
|--------|-------|--|
| 10/100 | Off | No link or no cable attached. FE-100TX forced to 10 Mbps operation, or is manually set to “auto-negotiate” mode. |
| | Green | No link or no cable attached. FE-100TX is forced to 100 Mbps operation. |

4.3 TROUBLESHOOTING CHECKLIST

If the 2H23-50R is not working properly, refer to [Table 4-4](#) for a checklist of possible problems, causes, and recommended actions to resolve the problem.

Table 4-4 Troubleshooting Checklist

| Problem | Possible Cause | Recommended Action |
|--|---|--|
| All LEDs are OFF. | Loss of power. | Check for proper connection of the power cable and its access to a live outlet. |
| | Installed improperly. | Check the installation. |
| No Local Management Password screen. | Autobaud is enabled. | Press ENTER (RETURN) (may take up to four times). |
| | Terminal setup is not correct. | Refer to Chapter 5 for proper setup procedures. |
| | Improper console cable used. | Refer to Appendix A for proper console port pinouts. |
| Cannot contact the 2H23-50R from in-band management. | Using incorrect Community Name. | Refer to Chapter 5 for Community Name setup. |
| | The device does not have an IP address assigned. | Refer to Chapter 5 for IP address assignment procedure. |
| | Port is disabled. | Enable port. |
| | No link to device. | Check link to device. |
| Port(s) goes into standby for no apparent reason. | The device detected a loop condition. | <ol style="list-style-type: none"> 1. Review network design and delete unnecessary loops. 2. Call the Cabletron Systems Global Call Center if the problem continues. |
| User parameters (IP address, Device and Module name, etc.) were lost when the 2H23-50R power was cycled or the front panel RESET button was pressed. | Mode switch (7), NVRAM Reset, was changed sometime before either cycling power or pressing the RESET button causing the user-entered parameters to reset to factory default settings. | <ol style="list-style-type: none"> 1. Reenter the lost parameters as necessary. 2. Call the Cabletron Systems Global Call Center if the problem continues. |

4.4 USING THE RESET BUTTON

The RESET button shown in Figure 4-4 resets the 2H23-50R or 2H33-37R processor.



Pressing the RESET button resets the device, and all current switching being performed by the device is halted. A network downtime of up to two minutes will result from this action.

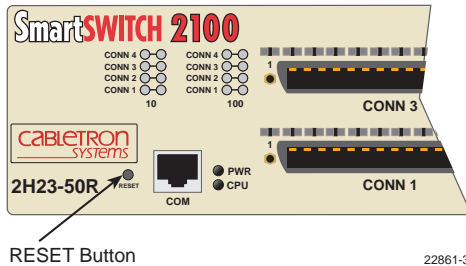

Figure 4-4 RESET Button

To reset the 2H23-50R or 2H33-37R processor, press and release the RESET button. It takes approximately 45 seconds to complete the reset process.

CHAPTER 5

LOCAL MANAGEMENT

This chapter explains how to set up a management terminal to access Local Management. It also explains how to use the Local Management screens and commands.

5.1 OVERVIEW

Local Management consists of a series of screens that allow the management of the 2H23-50R or 2H33-37R. The screens allow the user to do the following tasks:

- Assign IP address and subnet mask.
- Select a default gateway.
- Control access by establishing community names.
- Download a new operation firmware image.
- Designate which Network Management Workstations receive SNMP traps from the device.
- View bridge and port statistics.
- Configure switch operations (802.1D, 802.1Q, or SecureFast Switching).
- Control the number of receive broadcasts that are switched out to the other interfaces.
- Clear NVRAM.

There are three ways to access Local Management:

- Locally using a VT type terminal connected to the COM port of the 2H23-50R or 2H33-37R.
- Remotely using a VT type terminal connected through a modem.
- In-band through a Telnet connection.

5.2 LOCAL MANAGEMENT KEYBOARD CONVENTIONS

All key names appear as capital letters in this manual. Table 5-1 explains the keyboard conventions and the key functions that are used.

Table 5-1 Keyboard Conventions

| Key | Function |
|----------------------------|---|
| ENTER Key RETURN Key | These are selection keys that perform the same Local Management function. For example, "Press ENTER" means that you can press either ENTER or RETURN, unless this manual specifically instructs you otherwise. |
| ESCAPE (ESC) Key | This key allows an escape from a Local Management screen without saving changes. For example, "Press ESC twice" means the ESC key must be pressed quickly two times. |
| SPACE Bar BACKSPACE Key | These keys cycle through selections in some Local Management fields. Use the SPACE bar to cycle forward through selections and use BACKSPACE to cycle backward through selections. |
| Arrow Keys | These are navigation keys. Use the UP-ARROW, DOWN-ARROW, LEFT-ARROW, and RIGHT-ARROW keys to move the screen cursor. For example, "Use the arrow keys" means to press whichever arrow key moves the cursor to the desired field on the Local Management screen. |
| [–] Key | This key decreases values from a Local Management increment field. For example, "Press [–]" means to press the minus sign key. |
| DEL Key | The DEL (Delete) key removes characters from a Local Management field. For example, "Press DEL" means to press the Delete key. |

5.3 MANAGEMENT TERMINAL SETUP

Use one of the following systems to access Local Management:

- An IBM or compatible PC running a VT series emulation software package
- A Digital Equipment Corporation VT100 type terminal
- A VT type terminal running emulation programs for the Digital Equipment Corporation VT100 series
- A remote VT100 type terminal via a modem connection
- In-band via a Telnet connection

5.3.1 Console Cable Connection

Use the Console Cable Kit provided with the 2H23-50R or 2H33-37R to attach the management terminal to the 2H23-50R or 2H33-37R COM port as shown in Figure 5-1.

Connect an IBM PC or compatible device, running the VT terminal emulation, to the 2H23-50R or 2H33-37R as follows:

1. Connect the RJ45 connector at one end of the cable (supplied in the kit) to the COM port on the 2H23-50R or 2H33-37R.
2. Plug the RJ45 connector at the other end of the cable into the RJ45-to-DB9 adapter (supplied in the kit).
3. Connect the RJ45-to-DB9 adapter to the communications port on the PC.

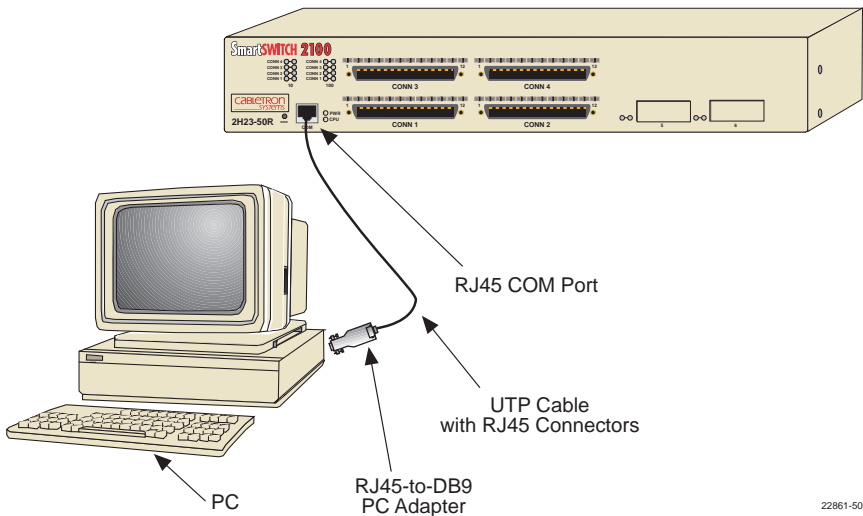

22861-50

Figure 5-1 Management Terminal Connection

5.3.2 Management Terminal Setup Parameters

Table 5-2 lists the setup parameters for the local management terminal.

Table 5-2 VT Terminal Setup

| | |
|----------------------------------|--------------------------|
| Display Setup Menu | |
| Columns -> | 80 Columns |
| Controls -> | Interpret Controls |
| Auto Wrap -> | No Auto Wrap |
| Scroll -> | Jump Scroll |
| Text Cursor -> | Cursor |
| Cursor Style -> | Underline Cursor Style |
| General Setup Menu | |
| Mode -> | VT100, 7 Bit Controls |
| ID number -> | VT100ID |
| Cursor Keys -> | Normal Cursor Keys |
| Power Supply -> | UPSS DEC Supplemental |
| Communications Setup Menu | |
| Transmit -> | 2400, 4800, 9600, 19200 |
| Receive -> | Receive=Transmit |
| XOFF -> | XOFF at 64 |
| Bits -> | 8 bits |
| Parity -> | No Parity |
| Stop Bit -> | 1 Stop Bit |
| Local Echo -> | No Local Echo |
| Port -> | DEC-423, Data Leads Only |
| Transmit -> | Limited Transmit |
| Auto Answerback -> | No Auto Answerback |
| Keyboard Setup Menu | |
| Keys -> | Typewriter Keys |
| Auto Repeat -> | any option |
| Keyclick -> | any option |
| Margin Bell -> | Margin Bell |
| Warning Bell -> | Warning Bell |

5.3.3 Telnet Connections

Once the 2H23-50R or 2H33-37R has a valid IP address, the user can establish a Telnet session with Local Management from any TCP/IP based node on the network. Telnet connections to the 2H23-50R or 2H33-37R require the community name passwords assigned through the SNMP Community Names screen.

For information about setting the IP address, refer to **Section 5.7, General Configuration Screen**.

For information about assigning community names, refer to **Section 5.8, SNMP Community Names Screen**.

Refer to the instructions included with the Telnet application for information about establishing a Telnet session.

5.3.4 Monitoring an Uninterruptible Power Supply

If the 2H23-50R or 2H33-37R is connected to an American Power Conversion (APC) Uninterruptible Power Supply (UPS) device for protection against the loss of power, a connection from the 2H23-50R or 2H33-37R COM port to the UPS can be made to monitor the power status of the UPS. To use the COM port for this purpose, it must be reconfigured to support the UPS connection using the procedure described in [Section 5.7.10, Configuring the COM Port](#). Refer to the UPS documentation for details on how to access the status information.

The Console Cable Kit provided with the 2H23-50R or 2H33-37R is used to attach the UPS to the COM port as shown in [Figure 5-2](#).

To connect the UPS device to the COM port, proceed as follows:

1. Connect the RJ45 connector at one end of the cable to the COM port.
2. Plug the RJ45 connector at the other end of the cable into the RJ45-to-DB9 male (UPS) adapter.
3. Connect the RJ45-to-DB9 male (UPS) adapter to the female DB9 port on the rear of the UPS device (see the particular UPS device's user instructions for more specific information about the monitoring connection).

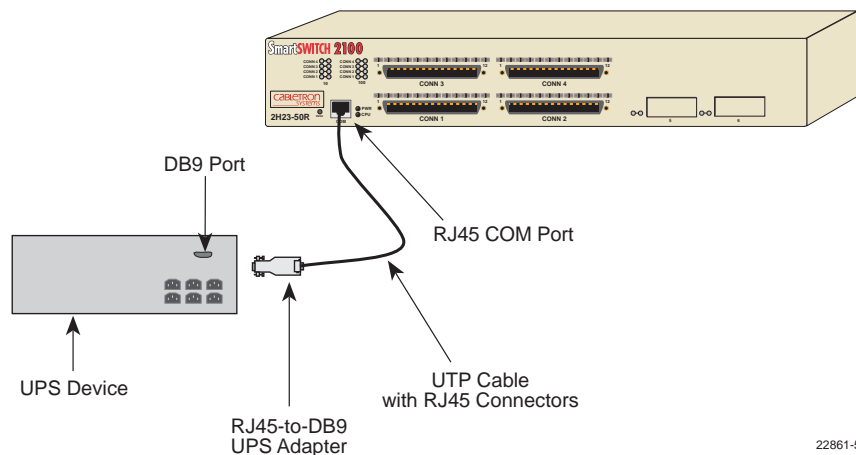

22861-51

Figure 5-2 Uninterruptible Power Supply (UPS) Connection

5.4 ACCESSING LOCAL MANAGEMENT

Access to Local Management is controlled through the Local Management Password screen shown in Figure 5-3. Whenever a connection is made to the 2H23-50R or 2H33-37R the Local Management Password screen displays. Before continuing, the user must enter a password (community name) which is compared to the previously stored passwords. The level of access allowed the user depends on the password. To set or change passwords, refer to Section 5.8. The following steps describe the procedure to access Local Management.

1. Turn on the terminal. Press ENTER (this may take up to four times, because the COM port auto-senses the baud rate of the terminal) until the 2H23-50R or 2H33-37R Local Management Password screen displays. It is the automatic line speed seeking feature of the port that makes it necessary at times to press ENTER several times.

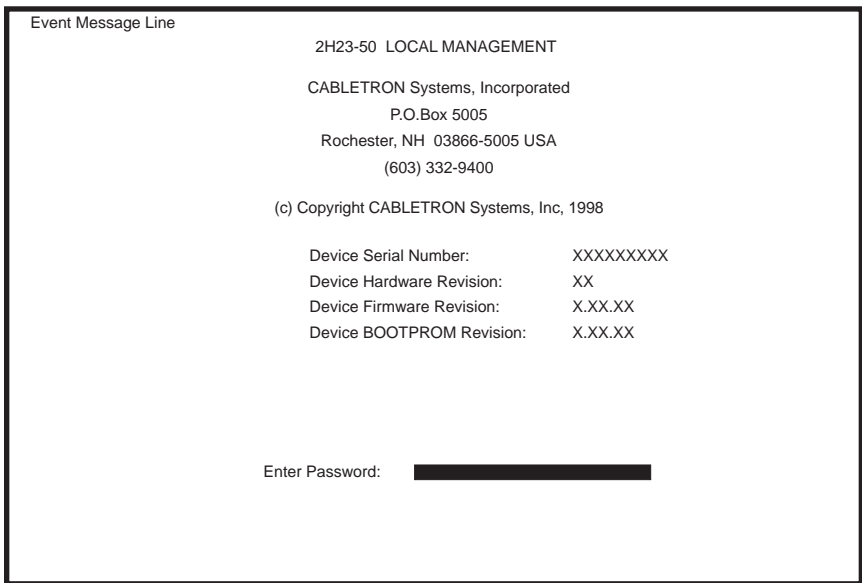

22861-12

Figure 5-3 Local Management Password Screen

2. Enter the Password and press ENTER. The default super-user access password is “public” or press ENTER.

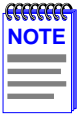

The User's password is one of the community names specified in the SNMP Community Names screen. Access to certain Local Management capabilities depends on the degree of access accorded that community name. Refer to [Section 5.8](#).

If an invalid password is entered, the terminal beeps and the cursor returns to the beginning of the password entry field.

Entering a valid password causes the associated access level to display at the bottom of the screen and the Device Menu screen to displays.

If no activity occurs for several minutes, the Local Management Password screen redisplay and the password must be reentered.

5.4.1 Navigating Local Management Screens

The 2H23-50R or 2H33-37R Local Management application consists of a series of menu screens. Navigate through Local Management by selecting items from the menu screens.

The 2H23-50R and 2H33-37R support three modes of switch operation. The switching modes are as follows:

- 802.1D Switching (traditional switching)
- 802.1Q Switching (port based VLAN switching)
- SecureFast VLAN (Cabletron Systems SecureFast switching)

Depending on the Operational Mode set for the device, the hierarchy of the Local Management screens differs as shown in [Figure 5-4](#), [Figure 5-5](#) and [Figure 5-6](#). Refer to the appropriate figure that relates to the Operational Mode set for the device to see the applicable Local Management screen hierarchy.

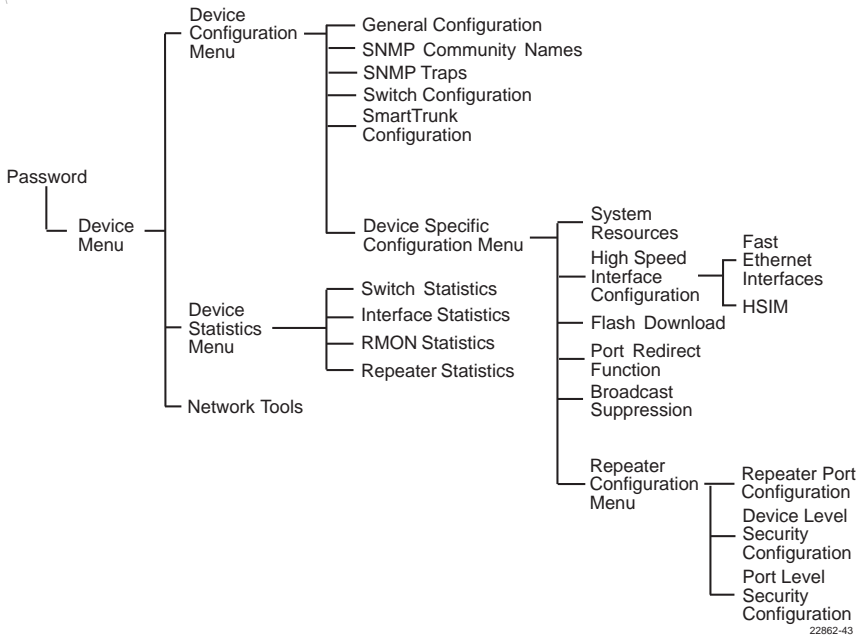

Figure 5-4 802.1D Switching Mode, LM Screen Hierarchy

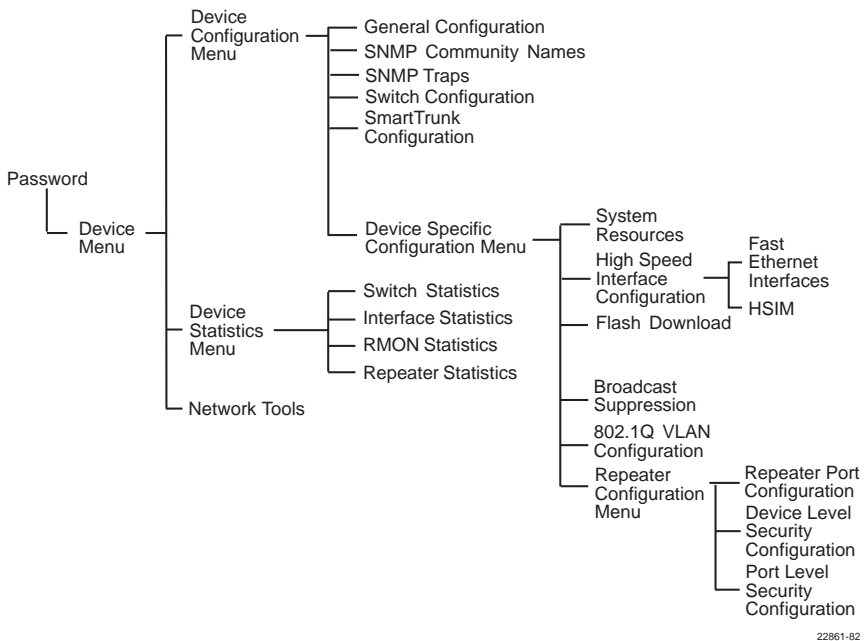

Figure 5-5 802.1Q Switching Mode, LM Screen Hierarchy

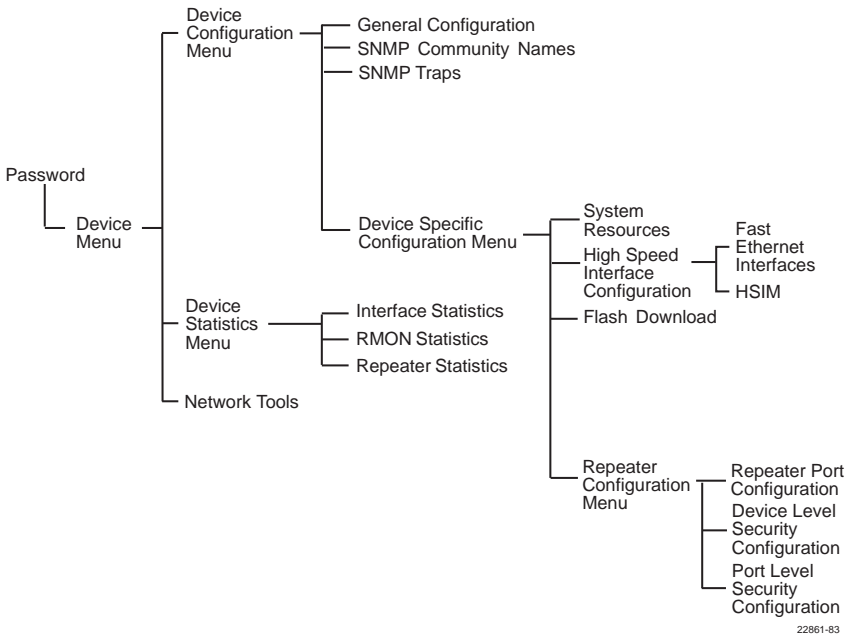

Figure 5-6 SecureFast VLAN Mode, LM Screen Hierarchy

5.4.2 Selecting Local Management Menu Screen Items

Select items on a menu screen by performing the following steps:

1. Use the arrow keys to highlight a menu item.
2. Press ENTER. The selected menu item displays on the screen.

5.4.3 Exiting Local Management Screens

There are two ways to exit the Local Management (LM) screens.

Using the Exit Command

To exit LM using the EXIT screen command, proceed as follows:

1. Use the arrow keys to highlight the **EXIT** command at the bottom of the Local Management screen.
2. Press ENTER. The Local Management Password screen displays and the session ends.

Using the RETURN Command

To exit LM using the RETURN command, proceed as follows:

1. Use the arrow keys to highlight the **RETURN** command at the bottom of the Local Management screen.
2. Press ENTER. The previous screen in the Local Management hierarchy displays.

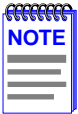

The user can also exit Local Management screens by pressing ESC twice. This exit method does not warn about unsaved changes and all unsaved changes are lost.

3. Exit from Local Management by repeating steps 1 and 2 until the Device Menu screen displays.
4. To end the LM session, use the arrow keys to highlight the **RETURN** command at the bottom of the Device Menu screen.
5. Press ENTER. The Local Management Password screen displays and the session ends.

5.5 DEVICE MENU SCREEN

The Device Menu screen is the access point for all Local Management screens. Figure 5-7 shows the Device Menu screen.

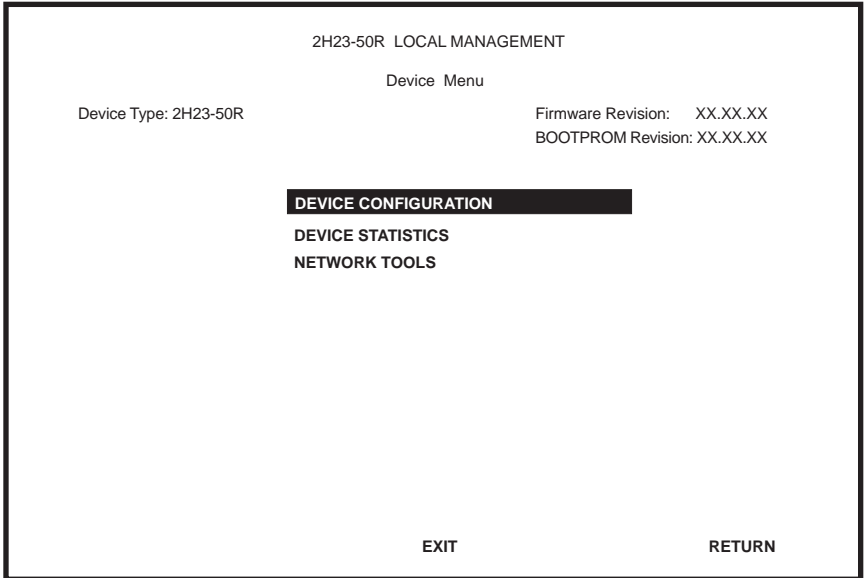

22861_13

Figure 5-7 Device Menu Screen

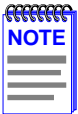

If the terminal is idle for several minutes, the Local Management Password screen redisplay and the session ends.

The following explains each Device Menu screen field as shown in [Figure 5-7](#):

DEVICE CONFIGURATION

Accesses the Device Configuration menu screen, which provides access to the Local Management screens that are used to configure the 2H23-50R or 2H33-37R, and also provides access to the Device Specific Configuration Menu screen. The Device Specific Configuration Menu screen provides access to the screens that allow the user to check the 2H23-50R or 2H33-37R resources and set operating parameters specific to each port.

For details about the Device Configuration Menu screen, refer to [Section 5.6](#). For details about the Device Specific Configuration Menu screen, refer to [Section 5.11](#).

DEVICE STATISTICS

Accesses the Device Statistics Menu screen, which provides access to screens that allow the user to obtain switch, interface, RMON, and repeater statistics information about the 2H23-50R or 2H33-37R. For details, refer to [Section 5.22](#).

NETWORK TOOLS

Accesses the Network Tools function, which resides on the 2H23-50R or 2H33-37R and consists of a series of commands that allow the user to access and manage network devices. [Section 5.27](#) explains how to use the Network Tools utility.

5.6 DEVICE CONFIGURATION MENU SCREEN

The Device Configuration Menu screen, [Figure 5-8](#), provides access to a series of Local Management screens, which allow the user to configure and monitor operating parameters, modify SNMP community names, set SNMP traps, configure switch parameters and configure the ports of the 2H23-50R or 2H33-37R.



The following menu items on the Device Configuration Menu screen do not display if the operational mode of the device is set to SECURE FAST VLAN:

SWITCH CONFIGURATION

SMARTTRUNK CONFIGURATION

[Section 5.7.9](#) provides instructions on setting the operational mode.

To access the Device Configuration Menu screen from the Device Menu screen, use the arrow keys to highlight the **DEVICE CONFIGURATION** menu item and press ENTER. The Device Configuration Menu screen displays.

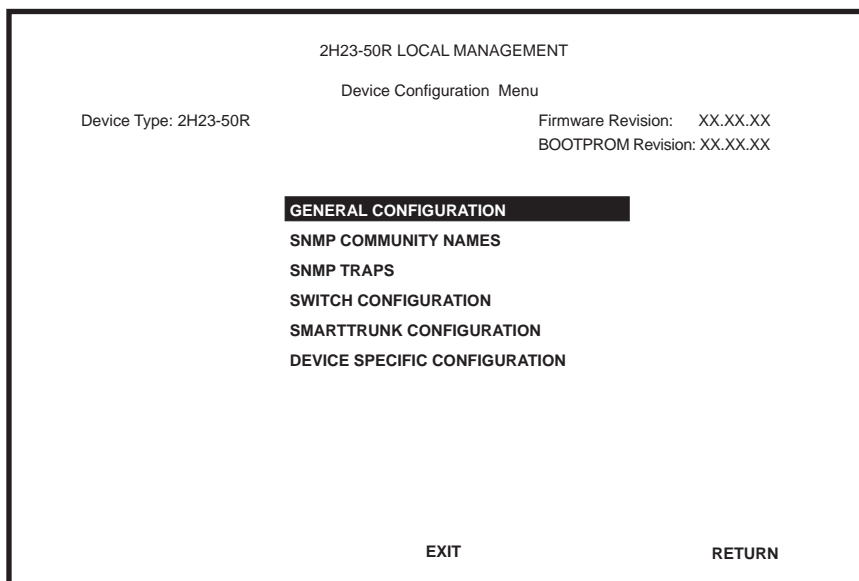

22861_66

Figure 5-8 Device Configuration Menu Screen

The following briefly explains each screen that is accessible from the Device Configuration Menu screen:

GENERAL CONFIGURATION

The General Configuration screen allows the user to monitor and configure operating parameters for the 2H23-50R or 2H33-37R. For details, refer to [Section 5.7](#).

SNMP COMMUNITY NAMES

The SNMP Community Names screen allows the user to enter new, change, or review the community names used as access passwords for device management operation. Access is limited based on the password level of the user. For details, refer to [Section 5.8](#).

SNMP TRAPS

The SNMP Traps screen provides display and configuration access to the table of IP addresses used for trap destinations and associated community names. For details, refer to [Section 5.9](#).

SWITCH CONFIGURATION

The Switch Configuration screen provides the basic setup options for customizing the operation of a switch device in the network. For details, refer to [Section 5.10](#).

SMARTTRUNK CONFIGURATION

The SmartTrunk Configuration screen allows the user to logically group interfaces to aggregate high speed uplinks. For details, refer to *SmartTrunk User's Guide*.

DEVICE SPECIFIC CONFIGURATION

The Device Specific Configuration Menu screen allows the user to select screens to configure ports or check system resources specific to the 2H23-50R or 2H33-37R. For details, refer to [Section 5.11](#).

5.7 GENERAL CONFIGURATION SCREEN

The General Configuration screen, [Figure 5-9](#), allows the user to set the system date and time, IP address and subnet mask, the Default Gateway, the TFTP Gateway IP address, and the operational mode. Also, clear the NVRAM, set the screen refresh time, the screen lockout time, the IP fragmentation, and the COM port configuration.

To access the General Configuration screen from the Device Configuration Menu screen, use the arrow keys to highlight the **GENERAL CONFIGURATION** menu item and press ENTER. The General Configuration screen displays.

| | | | | | |
|--------------------------------------|-------------------|----------------------|--|--------|--|
| Event Message Line | | | 2H23-50R LOCAL MANAGEMENT | | |
| General Configuration | | | | | |
| Device Type: 2H23-50R | | | Firmware Revision: XX.XX.XX BOOTPROM Revision: XX.XX.XX | | |
| MAC Address: | 00-00-ID-00-00-00 | Device Date: | 01/11/1997 | | |
| IP Address: | 0.0.0.0 | Device Time: | 14:23:00 | | |
| Subnet Mask: | 0.0.0.0 | Screen Refresh Time: | 03 sec. | | |
| Default Gateway: | NONE DEFINED | Screen Lockout Time: | 15 min. | | |
| TFTP Gateway IP Addr: | 0.0.0.0 | Device Uptime | XX D XX H XX M | | |
| Operational Mode: [802.1D SWITCHING] | | | | | |
| Com: [ENABLED] | Application: | | [LM] | | |
| Clear NVRAM: [NO] | IP Fragmentation | | [ENABLED] | | |
| SAVE | EXIT | | | RETURN | |

22861-15

Figure 5-9 General Configuration Screen

The following briefly explains each General Configuration screen field:

MAC Address (Read-Only)

Displays the physical address of the 2H23-50R or 2H33-37R device.

IP Address (Modifiable)

Displays and allows the user to set the IP address for the device. To set the IP address, refer to [Section 5.7.1](#). The IP address can also be set through Runtime IP Address Discovery as previously described in [Section 1.3.5](#), **Runtime IP Address Discovery**.

Subnet Mask (Modifiable)

Displays the subnet mask for the device. A subnet mask “masks out” the network bits of the IP address by setting the bits in the mask to 1 when the network treats the corresponding bits in the IP address as part of the network or subnetwork address, or to 0 if the corresponding bit identifies the host. For details about how to change the subnet mask from its default value, refer to [Section 5.7.2](#).

Default Gateway (Modifiable)

Displays the default gateway for the device. This field is not defined until an appropriate value is entered. For details about why and how to set the Default Gateway, refer to [Section 5.7.3](#).

TFTP Gateway IP Addr (Modifiable)

Displays and allows the user to set the TFTP Gateway IP address for the device. To set the TFTP Gateway IP address, refer to [Section 5.7.4](#).

Device Date (Modifiable)

Contains a value that the device recognizes as the current date. To set a new device date, refer to [Section 5.7.5](#).

Device Time (Modifiable)

Contains a value that the device recognizes as the current time. To enter a new time, refer to [Section 5.7.6](#).

Screen Refresh Time (Modifiable)

Contains the rate at which the screens are updated. This setting determines how frequently (in seconds) information is updated on the screen. To enter a new update time, refer to [Section 5.7.7](#).

Screen Lockout Time (Modifiable)

Contains the maximum number of minutes that the Local Management application displays the device's screen while awaiting input or action from a user. For example, if the number 5 is entered in this field, the user has up to five minutes to respond to each of the Local Management screens.

In this example, after five minutes of "idleness" (no input or action), the terminal "beeps" five times, the Local Management application terminates the session, and the display returns to the Local Management Password screen. To enter a new lockout time, refer to [Section 5.7.8](#).

Device Uptime (Read-Only)

Displays the total time that the device has been operating.

Operational Mode (Selectable)

Allows the user to set the 2H23-50R or 2H33-37R so it operates as an 802.1D switch (802.1D SWITCHING), an IEEE 802.1Q switch (802.1Q SWITCHING), or as a Cabletron Systems SecureFast switch (SECURE FAST VLAN).

In all three modes of operation, the 12 connections on each RJ21 port (CONN1 – CONN4 on 2H23-50R or CONN1 – CONN3 on 2H33-37R) may be assigned individually to operate at 10 Mbps or 100 Mbps. The connections that share either 10 Mbps or 100 Mbps operation reside on one network (two networks per RJ21 port).

In the 802.1D SWITCHING mode, each of the networks are automatically bridged to each other and to any Fast Ethernet Interface Module in the 2H23-50R or HSIM port(s) in the 2H33-37R.

In the 802.1Q SWITCHING mode, the switching functionality of the device can be increased by creating and maintaining IEEE 802.1Q port based Virtual LANs (VLANs).

In the SECURE FAST VLAN mode, the device acts as a SecureFast switch. With the Cabletron Systems VLAN Manager software, the device is able to increase its switching functionality by creating and maintaining VLANs.

For details on how to select the Operational Mode, refer to [Section 5.7.9](#).

Com (Toggle)

Allows the user to enable or disable the COM port. The selection toggles between ENABLED and DISABLED. The default is ENABLED. For details about setting up the COM port, refer to [Section 5.7.10](#).

Application (Toggle)

Allows the user to set the application that the COM port supports. The field toggles between LM (Local Management) and UPS (Uninterruptible Power Supply).

The UPS setting allows the COM port to be used to monitor an American Power Conversion (APC) Uninterruptible Power Supply (UPS).

The baud rate setting for LM is automatically sensed. For UPS, the baud rate is automatically set to 2400.

The default setting is LM. For details about how to configure the COM port for various applications, refer to [Section 5.7.10](#).

Clear NVRAM (Toggle)

Allows the user to reset NVRAM to the factory default settings. All user-entered parameters, such as IP address and Community Names, are then replaced with device default configuration settings. For details, refer to [Section 5.7.11](#).

IP Fragmentation (Toggle)

Allows the user to enable or disable IP Fragmentation. The default setting for this field is ENABLED. If the device is to be bridged to an FDDI ring via an HSIM-F6, IP Fragmentation must be enabled. If IP Fragmentation is disabled, all FDDI frames that exceed the maximum Ethernet frame size are discarded. For details on enabling IP Fragmentation, refer to [Section 5.7.12](#).

5.7.2 Setting the Subnet Mask

If the management workstation that is to receive SNMP traps from the 2H23-50R or 2H33-37R is located on a separate subnet, the subnet mask for the 2H23-50R or 2H33-37R may need to be changed from its default.

To change the subnet mask from its default, perform the following steps:

1. Use the arrow keys to highlight the **Subnet Mask** field.
2. Enter the subnet mask into this field using Dotted Decimal Notation (DDN) format.
For example: 255.255.0.0
3. Press ENTER. If the subnet mask is valid, the cursor returns to the beginning of the Subnet Mask field. If the entry is not valid, the screen displays the message “INVALID SUBNET MASK OR FORMAT ENTERED”. Local Management does not alter the current value, but it does refresh the Subnet Mask field with the previous value.
4. Use the arrow keys to highlight the **SAVE** command, then press ENTER. The warning screen shown in Figure 5-11 displays.

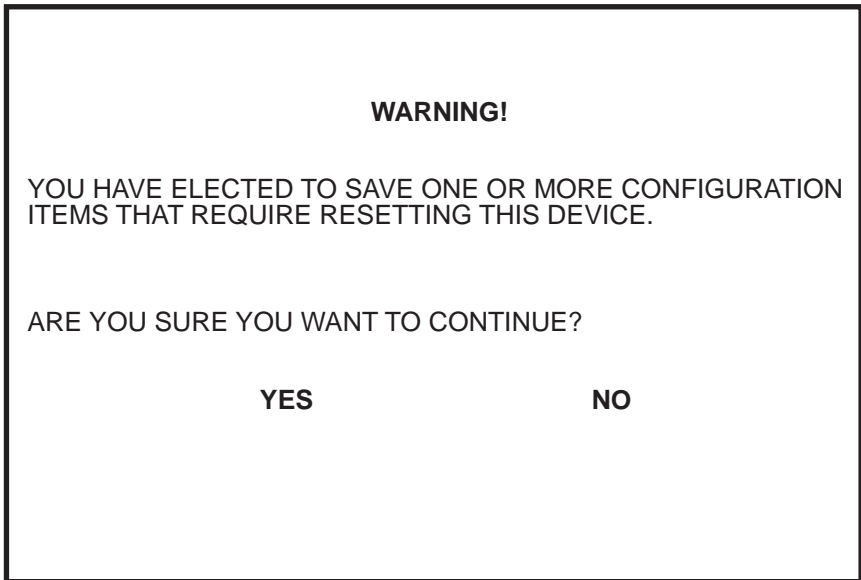

19601-84

Figure 5-11 Configuration Warning Screen

5. Use the arrow keys to highlight the **YES** command, then press ENTER. The changes are saved and the device reboots.

5.7.3 Setting the Default Gateway

If the SNMP management station is located on a different IP subnet than the 2H23-50R or 2H33-37R, a default gateway must be specified. When an SNMP Trap is generated, the 2H23-50R or 2H33-37R sends the Trap to the default gateway.

To set the default gateway, perform the following steps:

1. Use the arrow keys to highlight the **Default Gateway** field.
2. Enter the IP address of the default gateway using the DDN format.
For example: 134.141.79.121
3. Press ENTER. If the default gateway entered is a valid format, the cursor returns to the beginning of the Default Gateway field. If the entry is not valid, the screen displays “INVALID DEFAULT GATEWAY OR FORMAT ENTERED”. Local Management does not alter the current value, but it does refresh the Default Gateway field with the previous value.
4. Use the arrow keys to highlight the **SAVE** command.
5. Press ENTER. The message “SAVED OK” displays at the top of the screen.

5.7.4 Setting the TFTP Gateway IP Address

If the network TFTP server is located on a different IP subnet than the 2H23-50R or 2H33-37R, a Gateway IP address should be specified.

To set the TFTP Gateway IP address, perform the following steps:

1. Use the arrow keys to highlight the **TFTP Gateway IP Addr** field.
2. Enter the IP address of the TFTP gateway using the DDN format.

For example: 134.141.80.122

3. Press ENTER. If the TFTP gateway IP address entered is a valid format, the cursor returns to the beginning of the TFTP Gateway IP Address field. If the entry is not valid, the screen displays “INVALID TFTP GATEWAY IP ADDRESS OR FORMAT ENTERED”. Local Management does not alter the current value, but it does refresh the TFTP Gateway IP Address field with the previous value.
4. Use the arrow keys to highlight the **SAVE** command.
5. Press ENTER. The message “SAVED OK” displays at the top of the screen.

5.7.5 Setting the Device Date

The 2H23-50R or 2H33-37R is year 2000 compliant so that the Device Date field can be set beyond the year 1999.

To set the device date, perform the following steps:

1. Use the arrow keys to highlight the **Device Date** field.
2. Enter the date in this format: MM/DD/YYYY



It is not necessary to add separators between month, day, and year numbers, as long as each entry has the correct number of numeric characters. For example, to set the date to 03/17/1997, type “03171997” in the Device Date field.

3. Press ENTER to set the system calendar to the date in the input field.
4. Use the arrow keys to highlight the **SAVE** command at the bottom of the screen and press ENTER.

If the date entered is a valid format, the message displays “SAVED OK” at the top of the screen. If the entry is not valid, Local Management does not alter the current value, but it does refresh the Device Date field with the previous value.

5.7.6 Setting the Device Time

To set the device time, perform the following steps:

1. Use the arrow keys to highlight the **Device Time** field.
2. Enter the time in this 24-hour format: HH:MM:SS



When entering the time in the system time field, separators between hours, minutes, and seconds are not needed as long as each entry uses two numeric characters. For example, to set the time to 6:45 P.M., type "184500" in the Device Time field.

3. Press ENTER to set the system clock to the time in the input field.
4. Use the arrow keys to highlight the **SAVE** command at the bottom of the screen and press ENTER.

If the time entered is a valid format, the message displays "SAVED OK" at the top of the screen. If the entry is not valid, Local Management does not alter the current value and refreshes the Device Time field with the previous value.

5.7.7 Entering a New Screen Refresh Time

The screen refresh time is set from 3 to 99 seconds with a default of 3 seconds. To set a new screen refresh time, perform the following steps:

1. Use the arrow keys to highlight the **Screen Refresh Time** field.
2. Enter a number from 3 to 99.
3. Press ENTER to set the refresh time to the time entered in the input field.
4. Use the arrow keys to highlight the **SAVE** command at the bottom of the screen and press ENTER.

If the time entered is within the 3 to 99 seconds range, the message "SAVED OK" displays at the top of the screen. If the entry is not valid, Local Management does not alter the current setting, but it does refresh the Screen Refresh Time field with the previous value.

5.7.8 Setting the Screen Lockout Time

The screen lockout time can be set from 1 to 30 minutes with a default of 15 minutes. To set a new lockout time, perform the following steps:

- 1.** Use the arrow keys to highlight the **Screen Lockout Time** field.
- 2.** Enter a number from 1 to 30.
- 3.** Press ENTER to set the lockout time in the input field.
- 4.** Use the arrow keys to highlight the **SAVE** command at the bottom of the screen and press ENTER.

If the time entered is within the 1 to 30 minutes range, the message “SAVED OK” displays at the top of the screen. If the entry is not valid, Local Management does not alter the current setting, but it does refresh the Screen Lockout Time field with the previous value.

5.7.9 Setting the Operational Mode

To set the Operational Mode, proceed as follows:

- 1.** Use the arrow keys to highlight the **Operational Mode** field.
- 2.** Press the SPACE bar to step to the appropriate operation mode, (**802.1D SWITCHING**, **802.1Q SWITCHING**, or **SECURE FAST VLAN**).
- 3.** Use the arrow keys to highlight the **SAVE** command, then press ENTER. The warning screen shown in [Figure 5-12](#) displays.

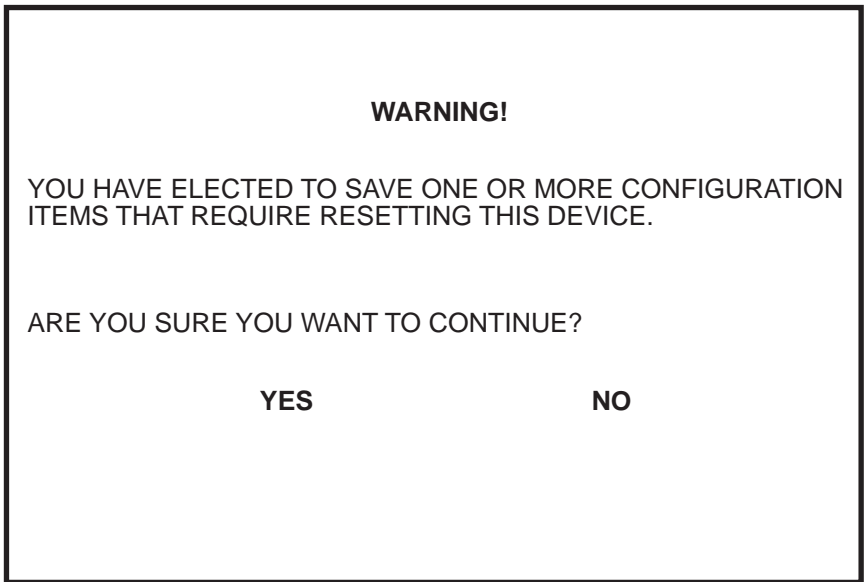

19601-84

Figure 5-12 Configuration Warning Screen

4. Use the arrow keys to highlight the **YES** command, then press ENTER. The changes are saved and the device reboots.

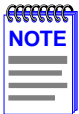

If the 2H23-50R or 2H33-37R is set to **802.1Q SWITCHING**, refer to your *Port Based VLAN User's Guide* to configure the devices for this type of operation.

If the 2H23-50R or 2H33-37R is set to **SECURE FAST VLAN**, refer to your SecureFast documentation set to configure the devices for this type of operation.

5.7.10 Configuring the COM Port

Upon power up, the COM port is configured to the default settings of ENABLED and LM.



Before altering the COM port settings, ensure that the 2H23-50R or 2H33-37R is set with a valid IP address. (Refer to Section 5.7.1, **Setting the IP Address**.) Read this entire COM port configuration section before changing the settings of the COM port.

The COM port supports the following applications:

- Local Management connections
- American Power Conversion (APC) Uninterruptible Power Supply (UPS) connections

To configure the COM port, proceed as follows:

1. Use the arrow keys to highlight the **Com** field.



Do **NOT** disable or alter the settings of the COM port while operating the current Local Management connection through a terminal. Altering the COM port settings disconnects the Local Management terminal from the port, and ends the Local Management session. If the 2H23-50R or 2H33-37R was previously assigned a valid IP address, reenter Local Management by establishing a Telnet connection to the device. If the device does not have a valid IP address and the COM port has been disabled or the settings changed, reset NVRAM using mode switch 7 on the 2H23-50R or 2H33-37R (refer to **Appendix C**) to reestablish COM port communications.

2. Press the SPACE bar to choose either **ENABLED** or **DISABLED**. The COM port must be enabled to use it for Local Management or UPS applications. Select **DISABLED** to disable the COM port for additional device security.
3. Use the arrow keys to highlight **SAVE**. Press ENTER.



If the COM port is reconfigured without a valid IP address set on the device, the message shown in [Figure 5-13](#) displays. Do not continue unless the outcome of the action is fully understood. If the WARNING screen displays, proceed to step 4. Otherwise, proceed to step 5.

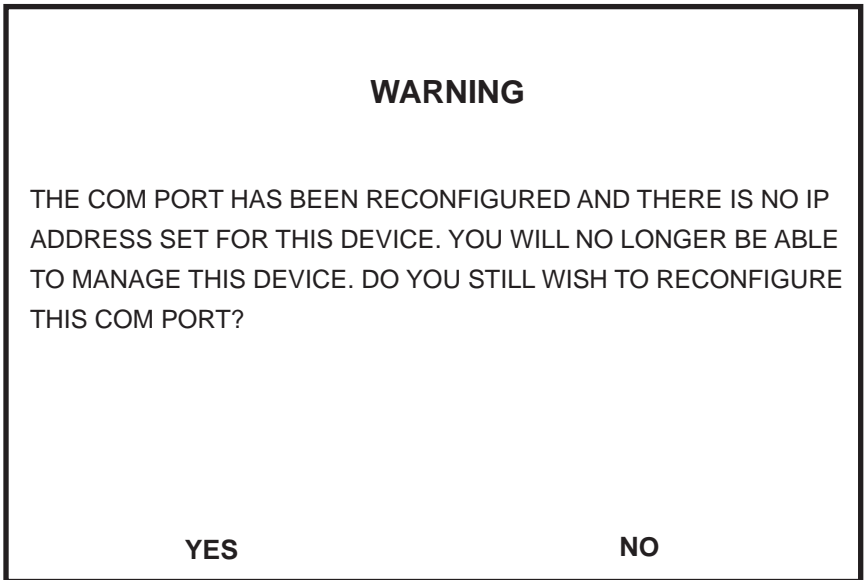

17421-52

Figure 5-13 COM Port Warning Screen

4. Use the arrow keys to highlight **YES**. Press ENTER.
5. If the port was **ENABLED**, proceed to step 6. If the port was **DISABLED**, use the arrow keys to highlight **SAVE** at the bottom of the screen, then press ENTER.

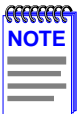

Exiting without saving causes the message "NOT SAVED -- PRESS SAVE TO KEEP CHANGES" to display. Exiting without saving causes all edits to be lost.

6. When the message "SAVED OK" displays, the edits you made are saved.

5.7.10.1 Changing the COM Port Application

After enabling the COM port as described in [Section 5.7.10](#), one of the applications supported by the COM port (LM or UPS) can be selected. The default application is LM.

To change the COM port application:

1. Use the arrow keys to highlight the **Application** field.
2. Use the SPACE bar or BACKSPACE to step through the available settings until the operation you require displays. [Table 5-3](#) lists the available settings and their corresponding applications.

Table 5-3 COM Port Application Settings

| Setting | Application |
|---------|-----------------------------|
| LM | Local Management Session |
| UPS | APC Power Supply SNMP Proxy |

3. Press ENTER to accept the application.
4. Use the arrow keys to highlight the **SAVE** command at the bottom of the screen, then press the ENTER key. The message “SAVED OK” displays, indicating that the edits are saved.



When the COM port is configured to perform the UPS application, all future Local Management connections must be made by establishing a Telnet connection to the device. Ensure that the device has a valid IP address before saving changes to the COM port application. If the device does not have a valid IP address and the changes are saved, refer to [Appendix C](#) for instructions on clearing NVRAM in order to reestablish COM port communications.

5.7.11 Clearing NVRAM



Clearing NVRAM results in the loss of all user-entered parameters. Do not proceed unless the following procedure is completely understood.

Clearing NVRAM allows the user to clear all user-entered parameters, such as the IP address and Community Names from NVRAM.

Clear NVRAM as follows:

1. Use the arrow keys to highlight the **Clear NVRAM** field.
2. Use the SPACE bar to toggle the field to **YES**.
3. Use the arrow keys to highlight **SAVE** at the bottom of the screen.
4. Press ENTER. The warning shown in [Figure 5-14](#) displays.

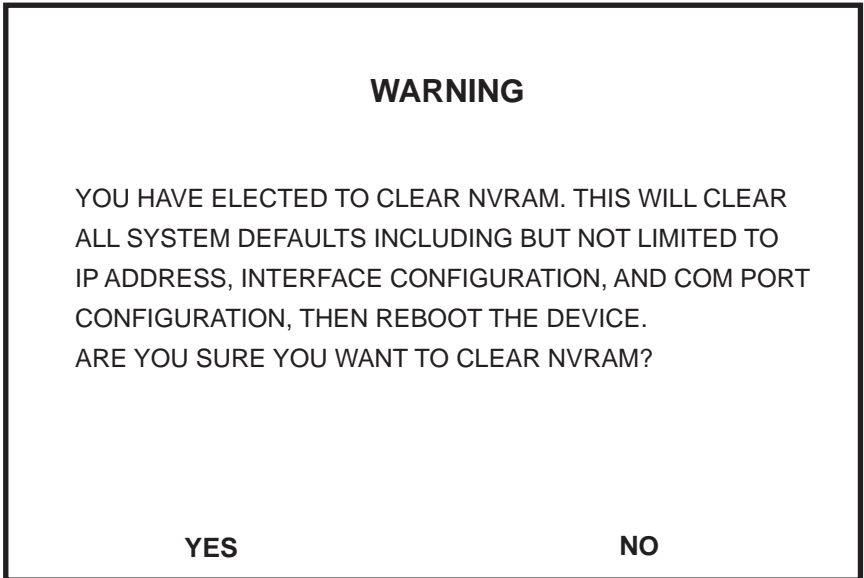

17421-51

Figure 5-14 Clear NVRAM Warning Screen

5. Select **YES** and the message “CLEARING NVRAM. REBOOT IN PROGRESS...” displays.
6. The 2H23-50R or 2H33-37R clears NVRAM and reboots. All user-entered parameters default to factory default settings.

5.7.12 Enabling/Disabling IP Fragmentation

To enable or disable IP Fragmentation, proceed as follows:



If the 2H33-37R is being bridged to an FDDI ring (for example, via an optional HSIM-F6), enable IP Fragmentation. If it is disabled, all FDDI frames that exceed the maximum Ethernet frame size are discarded.

1. Use the arrow keys to highlight the **IP Fragmentation** field.
2. Press the SPACE bar to choose either **ENABLED** or **DISABLED**.
3. Use the arrow keys to highlight the **SAVE** command.
4. Press ENTER. The message “SAVED OK” displays at the top of the screen.

5.8 SNMP COMMUNITY NAMES SCREEN

The SNMP Community Names screen, [Figure 5-15](#), allows the user to set SNMP Management community names. Community names act as passwords to Local/Remote Management and are agents of security access to the 2H23-50R or 2H33-37R. Access to the device is controlled by enacting any of three different levels of security authorization (read-only, read-write, and super-user).

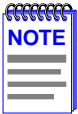

Super-user access gives the user full management privileges, allows existing passwords to be changed, and all modifiable MIB objects for the Cabletron Container MIB and Internet MIB-II to be edited.

To access the SNMP Community Names screen from the Device Configuration Menu screen, use the arrow keys to highlight the **SNMP COMMUNITY NAMES** menu item and press ENTER. The SNMP Community Names screen displays.

| | | | |
|-----------------------|----------------|-----------------------------|--------|
| Event Message Line | | 2H23-50R LOCAL MANAGEMENT | |
| | | SNMP Community Names | |
| Device Type: 2H23-50R | | Firmware Revision: XX.XX.XX | |
| | | BOOTPROM Revision: XX.XX.XX | |
| | Community Name | Access Policy | |
| | public | read-only | |
| | public | read-write | |
| | public | super-user | |
| SAVE | | EXIT | RETURN |

22861-16

Figure 5-15 SNMP Community Names Screen

The following explains each SNMP Community Names screen field:

Community Name (Modifiable)

Displays the user-defined name through which a user accesses the 2H23-50R or 2H33-37R SNMP Management. Any community name assigned here acts as a password to Local/Remote Management.

Access Policy (Read-Only)

Indicates the access accorded each community name. The available access levels are as follows:

- | | |
|------------|--|
| read-only | This community name gives the user read-only access to the 2H23-50R or 2H33-37R MIB objects, and excludes access to security-protected fields of read-write or super-user authorization. |
| read-write | This community name gives the user read-write access to the 2H23-50R or 2H33-37R MIB objects, excluding security protected fields for Super-User access only. |
| super-user | This community name gives the user read-write access to the 2H23-50R or 2H33-37R MIB objects and allows the user to change all modifiable parameters including community names, IP addresses, traps, and SNMP objects. |

5.8.1 Establishing Community Names

The password used to access Local Management at the Password Screen must have super-user access to view and edit the SNMP Community Names screen. Using a password with read-only or read-write access does not allow the user to view or edit the SNMP Community Names screen.



Any community name assigned in the SNMP Community Names screen is a password to its corresponding level of access to Local Management.

The community name assigned super-user access is the only one that gives the user complete access to Local Management.

To establish community names, proceed as follows:

1. Use the arrow keys to highlight the **Community Name** field adjacent to the selected access level.
2. Enter the password in the field (maximum 31 characters).
3. Press ENTER.
4. Repeat steps 1 through 3 to modify the other community names.
5. Use the arrow keys to highlight the **SAVE** command at the bottom of the screen and press ENTER. The message “SAVED OK” displays. The community names are saved to memory and their access modes implemented.



Exiting without saving causes a “NOT SAVED?” message to display. Edits are lost if they are not saved before exiting.

5.9 SNMP TRAPS SCREEN

Since the 2H23-50R or 2H33-37R is an SNMP compliant device, it can send messages to multiple Network Management Stations to alert users of status changes. The SNMP Traps screen is shown in Figure 5-16.

To access the SNMP Traps screen from the Device Configuration Menu screen, use the arrow keys to highlight the **SNMP TRAPS** menu item and press ENTER. The SNMP Traps screen displays.

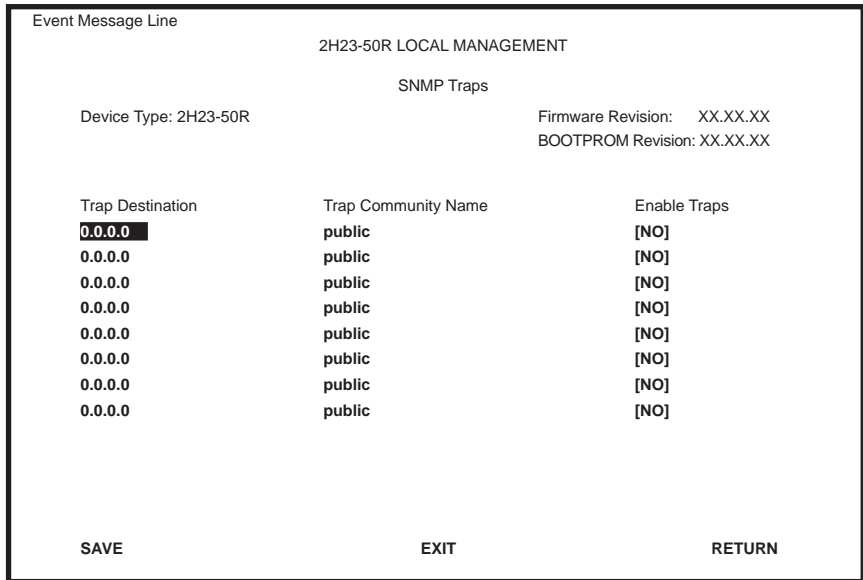

22861-17

Figure 5-16 SNMP Traps Screen

The following explains each field of the SNMP Traps screen.

Trap Destination (Modifiable)

Indicates the IP address of the workstation to receive trap alarms. Up to eight different destinations can be defined.

Trap Community Name (Modifiable)

Displays the Community Name included in the trap message sent to the Network Management Station with the associated IP address.

Enable Traps (Toggle)

Enables transmission of the traps to the network management station with the associated IP address. This field toggles between YES and NO.

5.9.1 Configuring the Trap Table

To configure the Trap table, proceed as follows:

1. Use the arrow keys to highlight the appropriate **Trap Destination** field.
2. Enter the IP address of the workstation that is to receive traps. IP address entries must follow the DDN format.

For example: 134.141.79.121
3. Press ENTER. If an invalid entry is entered, the message “INVALID IP ENTERED” displays.
4. Use the arrow keys to highlight the **Trap Community Name** field. Enter the community name.
5. Press ENTER.
6. Use the arrow keys to highlight the **Enable Traps** field. Press the SPACE bar to choose either **YES** (send alarms from the 2H23-50R or 2H33-37R to the workstation), or **NO** (prevent alarms from being sent).
7. Use the arrow keys to highlight the **SAVE** command and press ENTER. The message “SAVED OK” displays on the screen.



Exiting without saving causes a “NOT SAVED?” message to display. Edits are lost if they are not saved before exiting.

The designated workstations now receive traps from the 2H23-50R or 2H33-37R.

5.10 SWITCH CONFIGURATION SCREEN



The Switch Configuration screen is not available if the operational mode of the device is set to SECURE FAST VLAN. This screen may only be used when the device is configured to operate as an 802.1D or 802.1Q switch.

The Switch Configuration screen, [Figure 5-17](#), provides the basic setup options to make a switch operational in your network.

To access the Switch Configuration screen from the Device Configuration Menu screen, use the arrow keys to highlight the **SWITCH CONFIGURATION** menu item and press ENTER. The Switch Configuration screen displays up to 8 ports. To view or edit the fields for other ports, highlight **NEXT** at the bottom of the screen and press ENTER.

Depending on the optional interfaces installed and if the device is a 2H23-50R or 2H33-37R, there can be 10 or 7 ports, respectively. As shown in [Table 5-4](#), there are two network ports per RJ21 CONN connector.

Table 5-4 CONN/Port Organization

| 2H23-50R | 2H33-37R |
|--|--|
| CONN 1 = Network Port 1, 10 Mbps Network Port 2, 100 Mbps | CONN 1 = Network Port 1, 10 Mbps Network Port 2, 100 Mbps |
| CONN 2 = Network Port 3, 10 Mbps Network Port 4, 100 Mbps | CONN 2 = Network Port 3, 10 Mbps Network Port 4, 100 Mbps |
| CONN 3 = Network Port 5, 10 Mbps Network Port 6, 100 Mbps | CONN 3 = Network Port 5, 10 Mbps Network Port 6, 100 Mbps |
| CONN 4 = Network Port 7, 10 Mbps Network Port 8, 100 Mbps | HSIM = Port 7 |
| Fast Ethernet Slot 5 = Port 9 | |
| Fast Ethernet Slot 6 = Port 10 | |

Event Message Line

2H23-50R LOCAL MANAGEMENT

Switch Configuration

Device Type: 2H23-50R Firmware Revision: XX.XX.XX
BOOTPROM Revision: XX.XX.XX

Switch Address: 00-00-1D-00-00-00 Type of STA: **[DEC]**
 Number of Ports: 11 Age Time (sec): **300**

| Port # | MAC Address | State | Status |
|--------|-------------------|-----------|-------------------|
| 1 | 00-00-1D-00-00-00 | learning | [ENABLED] |
| 2 | 00-00-1D-00-00-01 | listening | [DISABLED] |
| 3 | 00-00-1D-00-00-02 | standby | [ENABLED] |
| 4 | 00-00-1D-00-00-03 | learning | [DISABLED] |
| 5 | 00-00-1D-00-00-04 | listening | [ENABLED] |
| 6 | 00-00-1D-00-00-05 | standby | [DISABLED] |
| 7 | 00-00-1D-00-00-06 | listening | [ENABLED] |
| 8 | 00-00-1D-00-00-07 | listening | [DISABLED] |

SAVE **[9-11]** EXIT RETURN

22862-18

Figure 5-17 Switch Configuration Screen

The following describes each field of the Switch Configuration screen:

Switch Address (Read-Only)

Displays the MAC address of the device.

Number of Ports (Read-Only)

Displays the total number of switched ports on the 2H23-50R or 2H33-37R.



Each of the Ethernet (10 Mbps) and Fast Ethernet (100 Mbps) repeater networks are considered single switched ports.

Depending on the optional interfaces installed and if the device is a 2H23-50R or 2H33-37R, there can be 10 or 7 switched or network ports. [Table 5-5](#) shows the CONN/port organization.

Table 5-5 CONN/Port Organization

| 2H23-50R | 2H33-37R |
|--|--|
| CONN 1 = Network Port 1, 10 Mbps Network Port 2, 100 Mbps | CONN 1 = Network Port 1, 10 Mbps Network Port 2, 100 Mbps |
| CONN 2 = Network Port 3, 10 Mbps Network Port 4, 100 Mbps | CONN 2 = Network Port 3, 10 Mbps Network Port 4, 100 Mbps |
| CONN 3 = Network Port 5, 10 Mbps Network Port 6, 100 Mbps | CONN 3 = Network Port 5, 10 Mbps Network Port 6, 100 Mbps |
| CONN 4 = Network Port 7, 10 Mbps Network Port 8, 100 Mbps | HSIM = Port 7 |
| Fast Ethernet Slot 5 = Port 9 | |
| Fast Ethernet Slot 6 = Port 10 | |

Type of STA (Selectable)

Allows the user to set the method that switches use to decide which switch is the controlling (Root) switch when two or more switches exist in parallel (Spanning Tree Algorithm). Valid selection is IEEE, DEC, and NONE. To set the STA, refer to [Section 5.10.1](#).

Age Time (Modifiable)

Allows the user to set the amount of time (in seconds) that the 2H23-50R or 2H33-37R keeps an address in its switch table before discarding it. An address is automatically discarded when a valid frame is not received from that address within the time specified in the Age Time field. To change the Age Time field from the default value of 300 seconds, refer to [Section 5.10.2](#).

Port # (Read-Only)

Lists each switched port on the device. If the number of ports is greater than eight, then the additional ports are listed on subsequent screens.

MAC Address (Read-Only)

Displays the hardware address assigned to each listed port.

State (Read-Only)

There are five states that can display in this field. These states are described as follows:

Disabled: Management disabled this interface. No traffic is received or forwarded while the interface is disabled.

Listening: The switch is not adding information to the Transparent Database. The switch is monitoring the Bridge Protocol Data Unit (BPDU) traffic while preparing to move from the learning to the forwarding state.

Learning: The switch is learning the addresses on this interface. The switch enters the learning state when the Transparent Database is created (during start-up or after being deleted), or when the Spanning Tree Algorithm detects a network topology change.

Forwarding: The switch is operating and this interface is forwarding traffic.

Standby: This interface will not forward any traffic through the switch because a loop condition has been detected by the STA.

Status (Toggle)

Allows the user to disable or enable a port by setting the status of the listed interface to either ENABLED or DISABLED. To set the port status, refer to [Section 5.10.3](#).

[1-8] or [9-11] (Navigation Key)

When the Switch Configuration screen displays, the current port configuration information is displayed for the first 8 ports. This field allow the user to step to a second screen (if 2H23-50R) to display the information for ports 9 through 11. Depending on the current screen displayed, the user can navigate back and forth by highlighting the [1-8] or [9-11] field and pressing ENTER.

5.10.1 Setting the STA

To set the STA, proceed as follows:

1. Use the arrow keys to highlight the **Type of STA** field.
2. Use the SPACE bar to step to the appropriate setting of **IEEE**, **DEC**, or **NONE**.
3. Use the arrow keys to highlight the **SAVE** command at the bottom of the screen.
4. Press ENTER. The message “SAVED OK” displays.

5.10.2 Setting the Age Time Field

To set the Age Time, proceed as follows:

1. Use the arrow keys to highlight the **Age Time** field.
2. Type in the desired Age Time in increments of 10. The available Age Time range is 10 to 1,000,000 seconds with the default value being 300 seconds.
3. Use the arrow keys to highlight the **SAVE** command at the bottom of the screen.
4. Press ENTER. The message “SAVED OK” displays.

5.10.3 Setting (Enabling or Disabling) the Port Status

To set the status of an interface (port), proceed as follows:

1. Use the arrow keys to highlight the **Status** field of the port.
2. Use the SPACE bar to toggle to either **ENABLED** or **DISABLED**.
3. Use the arrow keys to highlight the **SAVE** command at the bottom of the screen.
4. Press ENTER. The message “SAVED OK” displays.

5.11 DEVICE SPECIFIC CONFIGURATION MENU SCREEN

The Device Specific Configuration Menu screen, [Figure 5-18](#), allows the user to select one of five screens to configure ports or check system resources specific to the 2H23-50R or 2H33-37R.

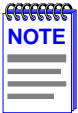

The PORT REDIRECT FUNCTION menu item on the Device Specific Configuration Menu screen does not display if the operational mode of the device is set to 802.1Q SWITCHING.

The PORT REDIRECT FUNCTION and BROADCAST SUPPRESSION menu items do not display if the operational mode is set to SECURE FAST VLAN.

[Section 5.7.9](#) provides instructions on setting the operational mode.

To access the Device Specific Configuration Menu screen from the Device Configuration Menu screen, use the arrow keys to highlight the **DEVICE SPECIFIC CONFIGURATION** menu item and press ENTER. The Device Specific Configuration Menu screen displays.

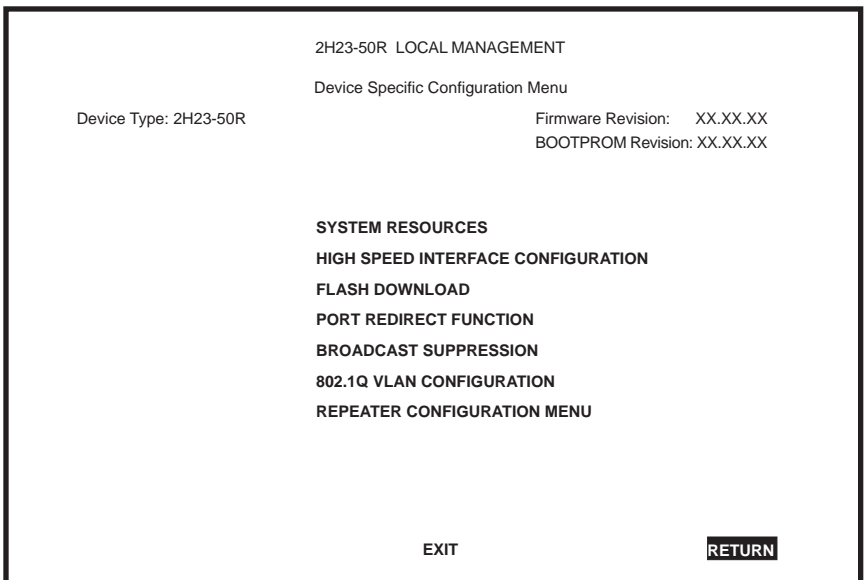

22863-20

Figure 5-18 Device Specific Configuration Menu Screen

The following briefly defines each selectable item of the Device Specific Configuration Menu screen:

SYSTEM RESOURCES

The System Resources screen displays the amount of FLASH memory, DRAM and NVRAM installed, indicates the amount of available memory and provides information on 2H23-50R or 2H33-37R operation. For details, refer to [Section 5.12](#).

HIGH SPEED INTERFACE CONFIGURATION

The High Speed Interface Configuration screen indicates which Fast Ethernet Interface Modules are installed in slots 5 and 6 of the 2H23-50R, their current operating mode, and if the ports are linked. This screen also allows the Auto-Negotiation and Advertised Ability features to be enabled or disabled. For details, refer to [Section 5.13](#).

The High Speed Interface Configuration screen for the 2H33-37R enables management of an installed HSIM. For details, refer to the applicable HSIM user's guide.

FLASH DOWNLOAD

The FLASH Download screen enables the user to force the 2H23-50R or 2H33-37R to download a new image file from a TFTP server to its FLASH memory. For details, refer to [Section 5.14](#).

PORT REDIRECT FUNCTION

The Port Redirect Function screen enables the user to redirect traffic from one or multiple switch ports to a specific destination switch port. For details, refer to [Section 5.15](#).

BROADCAST SUPPRESSION

The Broadcast Suppression screen enables the user to set a desired limit of received broadcast frames that are forwarded per port per second. For details, refer to [Section 5.16](#).

802.1Q VLAN CONFIGURATION

This menu item will only display if the 2H23-50R or 2H33-37R has been configured to operate as an 802.1Q switch as described in [Section 5.7.9](#), **Setting the Operational Mode**. When selected, this menu item opens the VLAN Main Menu screen. For details about the VLAN Local Management screens, refer to the Cabletron Systems *Port Based VLAN User's Guide*.

REPEATER CONFIGURATION MENU

The Repeater Configuration Menu screen enables the user to select the Repeater Port Configuration screen, which provides access to the security screens: Repeater Port Configuration, Device Level Security Configuration, and Port Level Security Configuration. For details refer to [Section 5.18](#).

5.12 SYSTEM RESOURCES SCREEN

The System Resources screen, [Figure 5-19](#), provides information concerning the processor used in the 2H23-50R or 2H33-37R and the amount of FLASH memory, DRAM, and NVRAM that is installed and how much of that memory is available. This screen also allows the user to monitor the current processor (switch) utilization and the peak switch utilization.

To access the System Resources screen from the Device Specific Configuration Menu screen, use the arrow keys to highlight the **SYSTEM RESOURCES** menu item and press ENTER. The System Resources screen displays.

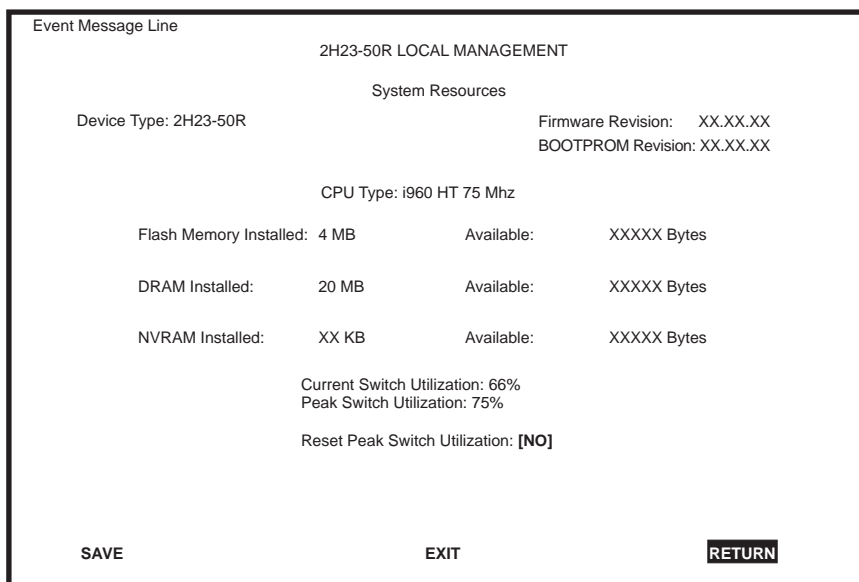

22861-23

Figure 5-19 System Resources Screen

The following briefly defines each field of the System Resources screen.

CPU Type (Read-only)

Indicates the microprocessor used in the 2H23-50R or 2H33-37R.

Flash Memory Installed (Read-only)

Indicates the amount of FLASH memory installed in the 2H23-50R or 2H33-37R and how much is currently available.

DRAM Installed (Read-only)

Indicates the amount of DRAM installed in the 2H23-50R or 2H33-37R and how much of it is currently available.

NVRAM Installed (Read-only)

Indicates the amount of NVRAM installed in the 2H23-50R or 2H33-37R and how much of it is currently available.

Current Switch Utilization (Read-only)

Shows the percentage of the device switching capacity currently being used.

Peak Switch Utilization (Read-only)

Shows the peak percentage of device switching capacity used, since the last reset.

Reset Peak Switch Utilization (Toggle)

Enables the user to reset the Peak Switch Utilization field. The switch may be set to either YES or NO as described in [Section 5.12.1](#). YES resets the Peak Switch Utilization field to the current system traffic.

5.12.1 Setting the Reset Peak Switch Utilization

To set the Reset Peak Switch Utilization field to YES or NO, proceed as follows:

1. Use the arrow keys to highlight the **Reset Peak Switch Utilization** field.
2. Press the SPACE bar to select **YES** or **NO**.
3. Use the arrow keys to highlight the **SAVE** command at the bottom of the screen.
4. Press ENTER. The message “SAVED OK” displays.

5.13 HIGH SPEED INTERFACE CONFIGURATION SCREEN (2H23-50R ONLY)



When the HIGH SPEED CONFIGURATION MENU item is selected for the 2H33-37R, the applicable HSIM Setup screen displays. Refer to the HSIM user's guide to set operating parameters for the HSIM installed in the 2H33-37R.

To access the High Speed Interface Configuration menu screen from the Device Specific Configuration Menu screen, use the arrow keys to highlight the **HIGH SPEED INTERFACE CONFIGURATION** menu item and press ENTER. The High Speed Interface Configuration menu screen, [Figure 5-20](#), displays.



The High Speed Interface Configuration screen, [Figure 5-20](#), applies only to slots 5 and 6 of the 2H23-50R. This screen supports the FE-100TX, FE-100FX, and FE-100F3 Fast Ethernet Interface Modules that operate at 100 Mbps.

The High Speed Interface Configuration screen displays the types of interfaces installed in slots 5 and 6, their current operating mode, and indicates if the ports are linked. This screen also allows the user to enable or disable Auto-Negotiation and set the Advertised Ability.

Current Oper. Mode (Read-only)

This field displays the current operating mode of slots 5 and 6. Depending on whether a 100BASE-FX or 100BASE-TX Fast Ethernet Interface Module is installed, this field displays the following:

- With a 100BASE-FX interface: 100Base-FX, 100Base-FXFD (full duplex), or N/A when the slot is empty.
- With a 100BASE-TX interface: Unknown, 10Base-T, 10Base-TFD (full duplex), 100Base-TX, 100Base-TXFD (full duplex), or N/A when the slot is empty.

Desired Oper. Mode (Selectable)

This field allows the user to select the desired operational mode for an interface in slot 5 or 6. The field toggles between 100Base-FX and 100Base-FXFD (full duplex) when an FE-100FX or FE-100F3 is installed. [Section 5.13.1](#) describes how to configure a port with an FE-100FX or FE-100F3.



In normal operation, the port with an FE-100TX installed automatically establishes a link with the device at the other end of the segment without requiring user setup. However, Local Management provides the user with the option of manually configuring that port.

If an FE-100TX is installed, the field steps to Auto-Negotiation, 10Base-T, 10Base-TFD (full duplex), 100Base-TX, and 100Base-TXFD (full duplex). In normal operation, the port with an FE-100TX installed is capable of auto-negotiating the operational mode and no further user setup is required. [Section 5.13.2](#) describes how to manually configure an FE-100TX.

In Auto-Negotiation, the FE-100TX negotiates to the highest common denominator of the two interfaces. The order of priority of negotiation is 100Base-TXFD, 100Base-TX, 10Base-TFD, and 10Base-T.

Advertised Ability (Selectable)

During auto-negotiation, the FE-100TX informs the device at the other end of the segment about its capabilities. The capabilities of a port (5 or 6) with an FE-100TX installed are 10Base-T, 10Base-TFD (full duplex mode), 100Base-TX and 100Base-TXFD (full duplex mode). In normal operation, with all capabilities enabled, the FE-100TX “advertises” that it has the ability to operate in any mode. The Network Manager may choose to set up the port so that only a portion of the available capabilities are advertised and the others are disabled. For example, only 100Base-TX and 100Base-TXFD might be enabled so that only devices that operate at 100 Mbps can communicate with that port. [Section 5.13.2.2](#) describes how to enable or disable advertised modes.

5.13.1 Configuring an FE-100FX or FE-100F3

When an FE-100FX or FE-100F3 is installed in port 5 or 6, it must be manually set to operate in the same technology as the device at the other end of the connected segment. [Section 5.13.1.1](#) provides instructions for manually configuring the slot with an FE-100FX or FE-100F3 interface.

5.13.1.1 Setting the FE-100FX or FE-100F3 Operational Mode

Use the Desired Oper. Mode field to set the active technology. This field toggles between 100Base-FX and 100Base-FXFD (full duplex). To set the active technology through Local Management, proceed as follows:

1. Use the arrow keys to highlight the **Desired Oper. Mode** field.
2. Use the SPACE bar to select **100Base-FX** or **100Base-FXFD** (full duplex).
3. Press ENTER. The port now operates in the chosen mode.
4. Use the arrow keys to highlight the **SAVE** command. Press ENTER. The message “SAVED OK” displays and Local Management saves the changes to memory.

5.13.2 Configuring an FE-100TX

In normal operation, a slot (5 or 6) with an FE-100TX interface automatically establishes a link with the device at the other end of the segment and no user setup is required. [Section 5.13.2.1](#) and [Section 5.13.2.2](#) provide instructions for manually configuring the port with an FE-100TX installed.

5.13.2.1 Setting the FE-100TX Operational Mode

Use the Desired Oper. Mode field to set the active technology. This field steps between Auto-Negotiation, 10Base-T, 10Base-TFD (full duplex), 100Base-TX, and 100Base-TXFD (full duplex). If Auto-Negotiation is selected, the FE-100TX automatically sets the active technology. To manually set the active technology through Local Management, proceed as follows:

1. Use the arrow keys to highlight the **Desired Oper. Mode** field.
2. Use the SPACE bar to select the desired mode. Press ENTER. If any mode other than Auto-Negotiation is selected, the port only operates in the chosen mode and Auto-Negotiation is disabled.
3. Use the arrow keys to highlight the **SAVE** command. Press ENTER. The message "SAVED OK" displays and Local Management saves the changes to memory. The selected mode is displayed in both the Desired Operational Mode field and the Current Operational Mode field.

5.13.2.2 Setting the FE-100TX Advertised Ability

In normal operation, a port (5 or 6) with an FE-100TX auto-negotiates to the highest speed possible. Under some circumstances, the Network Administrator may want the port to advertise only some of the available modes. The Advertised Ability field provides the capability to set those modes. This field steps to 10Base-T, 10Base-TFD (full duplex), 100Base-TX, and 100Base-TXFD (full duplex). To set the advertised ability, proceed as follows:

1. Use the arrow keys to highlight the **Advertised Ability** field.
2. Use the SPACE bar to select the desired mode.

3. Use the arrow keys to move to the **Enable/Disable** field at the right of the desired mode and use the SPACE bar to select **Enabled** or **Disabled**. Press ENTER.
4. Continue this process until you have completed enabling or disabling the advertised modes.
5. Use the arrow keys to highlight the **SAVE** command. Press ENTER. The message “SAVED OK” displays and Local Management saves the changes to memory.

5.14 FLASH DOWNLOAD SCREEN

The Flash Download screen, shown in [Figure 5-21](#), enables the user to upgrade the device with a different operating image.

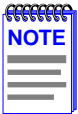

The user may also force the download of an image by changing the position of Switch 6 located inside the device. Refer to [Section C-2, Removing the Chassis Cover](#), for details.

Before downloading an image to the device, copy the image to the network TFTP server.



For information on how to set up a workstation as a TFTP server, refer to the specific workstation documentation.

To access the Flash Download screen from the Device Specific Configuration Menu screen, use the arrow keys to highlight the **FLASH DOWNLOAD** menu item and press ENTER. The Flash Download screen displays.

```

TFTP DOWNLOAD. WILL COMMIT TO FLASH. REBOOT IN PROGRESS...
                2H23-50R LOCAL MANAGEMENT

                        Flash Download

Device Type: 2H23-50R                                Firmware Revision:  XX.XX.XX
                                                    BOOTPROM Revision: XX.XX.XX

Download Method:  [TFTP]
Reboot After Download:  [YES]
TFTP Gateway IP Addr:  134.141.79.123
Last Image Server IP:  134.141.79.121
Last Image File Name:  /ftpboot/2H23.hex
Download Server IP:    134.141.79.121
Download File Name:    /ftpboot/2H23.hex

EXECUTE                                EXIT                                RETURN

```

22861-49

Figure 5-21 Flash Download Screen

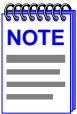

Download Server IP and Download File Name display only when TFTP or RUNTIME are selected in Download Method.

The following briefly defines each field of the Flash Download screen:

Download Method (Selectable)

This field toggles between BOOTP, TFTP, and RUNTIME. If set for BootP, the device sends out a BootP request to determine the IP address of the TFTP server and the file name of the image to be downloaded. If set for TFTP or RUNTIME, the 2H23-50R or 2H33-37R attempts a TFTP download based on the IP address and file name entered in the fields at the bottom of the Flash Download screen. [Section 5.14.1](#) describes how to download using BootP. [Section 5.14.2](#) describes how to download using TFTP. [Section 5.14.3](#) describes how to download using Runtime.

Reboot After Download (Modifiable only when the user chooses RUNTIME)

This field notifies the user that the 2H23-50R or 2H33-37R will reboot after the download is complete. If a Runtime Download is performed, this field toggles between YES and NO. If YES is selected, the device reboots after the download is completed. If NO is selected, the device continues using the existing firmware image and stores the new firmware image in FLASH memory. When the device is reset or during the next power-up, the device boots from FLASH memory using the new image.

TFTP Gateway IP Addr (Selectable)

This field shows the IP address of the TFTP gateway server defined on the General Configuration screen in [Section 5.7.4, Setting the TFTP Gateway IP Address](#).

Last Image Server IP (Read-only)

This field shows the IP address of the server used for the previous FLASH Download.

Last Image File Name (Read-only)

This field shows the complete path and file name of the last image downloaded to FLASH.

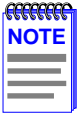

If TFTP or RUNTIME is selected as the download method (see [Figure 5-21](#)), the following two additional fields display.

Download Server IP (Selectable)

The IP address of the TFTP server to be used for the FLASH download is entered in this field.

Download File Name (Selectable)

The complete TFTP Server path and file name of the new image is entered in this field.

5.14.1 Image File Download Using BootP

To set the 2H23-50R or 2H33-37R to download a firmware image to FLASH memory using BootP, proceed as follows:

1. Use the arrow keys to highlight the **Download Method** field.
2. Step to **BOOTP** using the SPACE bar.
3. Use the arrow keys to highlight the **TFTP Gateway IP Addr** field.
4. Set the IP address of the TFTP gateway server (this defaults to the same IP address set in the TFTP Gateway IP Addr field in the General Configuration screen).
5. Use the arrow keys to highlight **EXECUTE** at the bottom of the screen and press ENTER. The message “BOOTP DOWNLOAD. WILL COMMIT TO FLASH. REBOOT IN PROGRESS...” displays in the event message line at the top of the screen and the new image is downloaded into FLASH memory.

5.14.2 Image File Download Using TFTP

To set the 2H23-50R or 2H33-37R to download a firmware image to FLASH memory using TFTP, proceed as follows:

1. Use the arrow keys to highlight the **Download Method** field.
2. Step to **TFTP** using the SPACE bar.
3. Use the arrow keys to highlight the **TFTP Gateway IP Addr** field.
4. Set the IP address of the TFTP gateway server (this defaults to the same IP address as that set in the TFTP Gateway IP Addr field on the General Configuration screen).
5. Use the arrow keys to highlight the **Download Server IP** field.
6. Enter the IP address of the TFTP server using the DDN format.
For example: 134.141.79.121
7. Use the arrow keys to highlight the **Download File Name** field.
8. Enter the complete pathway and file name of the image stored on the download server.

For example: /tftpboot/2H23.hex

9. Use the arrow keys to highlight **EXECUTE** at the bottom of the screen and press ENTER. The message “TFTP DOWNLOAD. WILL COMMIT TO FLASH. REBOOT IN PROGRESS...” displays in the event message line at the top of the screen and the new image is downloaded into FLASH memory.

5.14.3 Image File Download Using Runtime

To download a firmware image to FLASH memory using Runtime, proceed as follows:

1. Use the arrow keys to highlight the **Download Method** field.
2. Step to **RUNTIME** using the SPACE bar.
3. Use the arrow keys to highlight the **Reboot After Download** field.
4. Use the SPACE bar to select either **YES** or **NO**. Select **YES** if you want the device to reboot after the download is completed. Select **NO** if you want the device to store the new image in FLASH memory until the device is reset or during the next power-up.
5. Use the arrow keys to highlight the **TFTP Gateway IP Addr** field.
6. Set the IP address of the TFTP gateway server (this defaults to the same IP address as that set in the TFTP Gateway IP Addr field on the General Configuration screen).
7. Use the arrow keys to highlight the **Download Server IP** field.
8. Enter the IP address of the TFTP server using the DDN format.
For example: 134.141.79.121
9. Use the arrow keys to highlight the **Download File Name** field.
10. Enter the complete pathway and file name of the image stored on the download server.
For example: /tftpboot/2H23.fl5
11. Use the arrow keys to highlight **EXECUTE** at the bottom of the screen and press ENTER. The message “TFTP DOWNLOAD. WILL COMMIT TO FLASH. REBOOT IN PROGRESS...” displays in the event message line at the top of the screen and the new image is downloaded into FLASH memory.

5.15 PORT REDIRECT FUNCTION SCREEN

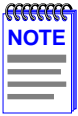

The Port Redirect Function screen can only be used if the operational mode of the device has been set to 802.1D SWITCHING. Refer to [Section 5.7.9, Setting the Operational Mode](#), for instructions on configuring the device to operate in this mode.

The Port Redirect Function screen, [Figure 5-22](#), enables the user to set each Network, Fast Ethernet, or HSIM port as a source or destination port. A port can be set to have one or more destination ports. For example, port 1 can be set as a source port with three destinations, ports 2, 3, and 4. Traffic from port 1 is then automatically redirected to ports 2, 3, and 4. Port 1 can also serve as a destination port for other ports. [Table 5-6](#) shows the port organization.

Table 5-6 CONN/Port Organization

| 2H23-50R | 2H33-37R |
|--|--|
| CONN 1 = Network Port 1, 10 Mbps Network Port 2, 100 Mbps | CONN 1 = Network Port 1, 10 Mbps Network Port 2, 100 Mbps |
| CONN 2 = Network Port 3, 10 Mbps Network Port 4, 100 Mbps | CONN 2 = Network Port 3, 10 Mbps Network Port 4, 100 Mbps |
| CONN 3 = Network Port 5, 10 Mbps Network Port 6, 100 Mbps | CONN 3 = Network Port 5, 10 Mbps Network Port 6, 100 Mbps |
| CONN 4 = Network Port 7, 10 Mbps Network Port 8, 100 Mbps | HSIM = Port 7 |
| Fast Ethernet Slot 5 = Port 9 | |
| Fast Ethernet Slot 6 = Port 10 | |

The port redirect function is extremely useful for troubleshooting purposes, as it allows traffic to be sent to a particular port(s) where, with the use of an analyzer or RMON probe, all current traffic from the source port(s) can be examined.



Although all traffic from the source port (including, if desired, errored frames) is sent to the destination port, normal switching is still performed for all frames on the source port.

Port Redirect operates at a switch interface level and not at a repeater port level. If traffic is redirected to interfaces that include active repeater ports, then the redirected traffic is transmitted out all of the repeater ports connected to the interface.

To access the Port Redirect Function screen from the Device Specific Configuration Menu screen, use the arrow keys to highlight the **PORT REDIRECT FUNCTION** menu item and press ENTER. The Port Redirect Function screen displays.

Event Message Line

2H23-50R LOCAL MANAGEMENT

Port Redirect Function

Device Type: 2H23-50R

Firmware Revision: XX.XX.XX
BOOTPROM Revision: XX.XX.XX

| <u>Source Port:</u> | <u>Destination Port:</u> | <u>Remap Errors:</u> |
|---------------------|--------------------------|----------------------|
| 1 | 2 | ON |
| 1 | 3 | ON |
| 1 | 4 | ON |
| 2 | 1 | OFF |
| 2 | 3 | OFF |
| 3 | 4 | ON |
| 3 | 5 | ON |
| 3 | 6 | ON |

Source Port [1] Destination Port [1] Errors [ON] Status [ADD]

SAVE NEXT PREVIOUS EXIT **RETURN**

22861_22

Figure 5-22 Port Redirect Function Screen

The following definitions briefly explain each field of the Port Redirect Function screen:

Source Port (Read-only)

Shows which ports are currently set as source ports. To display the ports, refer to [Section 5.15.1](#).

Destination Port (Read-only)

Shows which ports are currently set as destination ports.

Remap Errors (Read-only)

Displays whether the corresponding source ports are configured (ON) to send errored frames to the destination ports, or (OFF) to drop all errored frames and only forward traffic without errored frames to the destination ports.

Source Port [n] (Selectable)

Enables a selected port [n] to be changed to a source port.

Destination Port [n] (Selectable)

Enables a selected port [n] to be changed to a destination port.

Errors (Toggle)

Enables the user to configure the source ports to either (ON) send errored frames to selected destination ports, or (OFF) drop errored frames, and send only valid traffic to the destination ports. The default setting of this field is ON. To set the Errors field, refer to [Section 5.15.2](#).

Status (Toggle)

Enables the addition or deletion of source and destination ports selected in the Source Port [n] and Destination Port [n] fields.

5.15.1 Displaying the Source and Destination Entries

There can be more than one Port Redirect Function screen depending on the number of port redirect entries. Each screen displays up to 10 port redirect entries. If there is more than one screen of redirect entries, the NEXT and/or PREVIOUS command displays at the bottom of the screen, allowing the user to navigate to either the next or previous screen.

For example, with three screens of entries, the NEXT command displays at the bottom of the first screen. In the second screen, the NEXT and PREVIOUS commands display. In the last screen, only the PREVIOUS command displays.

To display the next screen, use the arrow keys to highlight **NEXT**. Press ENTER and the next screen of entries displays.

To display the previous screen, use the arrow keys to highlight **PREVIOUS**. Press ENTER to view the entries on the previous screen.

5.15.2 Changing Source and Destination Ports

Add or delete source port and destination port entries as follows:

1. Use the arrow keys to highlight the **Source Port** field.
2. Press the SPACE bar or BACKSPACE one or more times to increment or decrement the port number displayed in the brackets [n] until the appropriate port number displays.
3. Use the arrow keys to highlight the **Destination Port** field.
4. Use the SPACE bar or BACKSPACE to step to the appropriate port number for the destination port.
5. Use the arrow keys to highlight **ADD** or **DEL** (delete) in the Status field.
6. Use the SPACE bar to set Status to either **ADD** or **DEL** (delete) and press ENTER. This adds or deletes the port selections made in steps 2 and 4 and also updates the screen Source Port and Destination Port list.
7. Use the arrow keys to highlight **ON** or **OFF** in the Errors field.
8. Use the SPACE bar to set Errors to either **ON** or **OFF** and press ENTER. **ON** forces the source port to forward errored frames to the destination port(s). **OFF** forces the errored frames to be dropped before forwarding traffic.

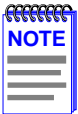

If more than one port is to be redirected, repeat steps 1 through 8 for each additional setting, then go to step 9 to save all the new settings at once.

9. Use the arrow keys to highlight **SAVE** at the bottom of the screen. Press ENTER. The message “SAVED OK” displays. This saves the new settings and updates the Source Port and Destination Port read-only fields.

5.16 BROADCAST SUPPRESSION SCREEN

The Broadcast Suppression screen, [Figure 5-23](#), enables the user to set a desired limit of receive broadcast frames that are switched out to the other Network, Fast Ethernet, or HSI ports.

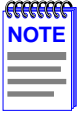

The Broadcast Suppression screen is not available if the operational mode of the device is set to SECURE FAST VLAN. This screen may only be used when the device is configured to operate as an 802.1D or 802.1Q switch.

Broadcast frames received above the threshold setting are dropped.

To access the Broadcast Suppression screen from the Device Specific Configuration Menu screen, use the arrow keys to highlight the **BROADCAST SUPPRESSION** menu item and press ENTER. The Broadcast Suppression screen displays.

| Event Message Line | | | | | |
|---------------------------|-------------|-----------|-----------------------------|-----------|------------|
| 2H23-50R LOCAL MANAGEMENT | | | | | |
| Broadcast Suppression | | | | | |
| Device Type: 2H23-50R | | | Firmware Revision: XX.XX.XX | | |
| | | | BOOTPROM Revision: XX.XX.XX | | |
| PORT # | Total RX | Peak Rate | Time Since Peak | Threshold | Reset Peak |
| 1 | 12345678910 | 150000 | 999:23:59 | 150000 | [NO] |
| 2 | 12345678910 | 150000 | 999:23:59 | 150000 | [NO] |
| 3 | 12345678910 | 150000 | 999:23:59 | 150000 | [NO] |
| 4 | 12345678910 | 150000 | 999:23:59 | 150000 | [NO] |
| 5 | 12345678910 | 150000 | 999:23:59 | 150000 | [NO] |
| 6 | 12345678910 | 150000 | 999:23:59 | 150000 | [NO] |
| 7 | 12345678910 | 150000 | 999:23:59 | 150000 | [NO] |
| 8 | 12345678910 | 150000 | 999:23:59 | 150000 | [NO] |
| 9 | 12345678910 | 150000 | 999:23:59 | 150000 | [NO] |
| 10 | 12345678910 | 150000 | 999:23:59 | 150000 | [NO] |

SAVE
EXIT
RETURN

22861-56

Figure 5-23 Broadcast Suppression Screen

The following explains each field of the Broadcast Suppression screen:

PORT # (Read-only)

Identifies the number of the switched port. Ten ports are displayed in a 2H23-50R and seven ports in a 2H33-37R. [Table 5-6](#) shows the port organization.

Table 5-7 CONN/Port Organization

| 2H23-50R | 2H33-37R |
|--|--|
| CONN 1 = Network Port 1, 10 Mbps Network Port 2, 100 Mbps | CONN 1 = Network Port 1, 10 Mbps Network Port 2, 100 Mbps |
| CONN 2 = Network Port 3, 10 Mbps Network Port 4, 100 Mbps | CONN 2 = Network Port 3, 10 Mbps Network Port 4, 100 Mbps |
| CONN 3 = Network Port 5, 10 Mbps Network Port 6, 100 Mbps | CONN 3 = Network Port 5, 10 Mbps Network Port 6, 100 Mbps |
| CONN 4 = Network Port 7, 10 Mbps Network Port 8, 100 Mbps | HSIM = Port 7 |
| Fast Ethernet Slot 5 = Port 9 | |
| Fast Ethernet Slot 6 = Port 10 | |

Total RX (Read-Only)

Displays the total number of broadcast frames received.

Peak Rate (Read-Only)

Displays the highest number of broadcast frames received in a one second interval.

Time Since Peak (Read-Only)

Displays the time since peak rate was achieved.

Threshold (Modifiable)

Allows the user to set the desired limit of receive broadcast frames that will be forwarded per port per second.

Reset Peak (Toggle)

Enables the user to reset the Peak Rate. Resetting the Peak Rate also resets the Time Since Peak field. The Reset Peak field toggles between YES and NO.

5.16.1 Setting the Threshold

To set the Threshold, proceed as follows:

1. Use the arrow keys to highlight the **Threshold** field for the selected port.
2. Type in the numbers for the desired limit. Only enter values in increments of ten (for example; 10, 20, 30, etc.).
3. Use the arrow keys to highlight the **SAVE** command at the bottom of the screen.
4. Press ENTER. The message “SAVED OK” displays.

5.16.2 Setting the Reset Peak

To set the Reset Peak field to YES or NO, proceed as follows:

1. Use the arrow keys to highlight the **Reset Peak** field for the selected port.
2. Press the SPACE bar to select **YES** or **NO**.
3. Use the arrow keys to highlight the **SAVE** command at the bottom of the screen.
4. Press ENTER. The message “SAVED OK” displays and the Time Since Peak field is also reset.

5.18 REPEATER CONFIGURATION MENU SCREEN

The Repeater Configuration Menu screen, [Figure 5-25](#), is used to access the Repeater Port Configuration, Repeater Level Security Configuration, or Port Level Security Configuration screen. To access the Repeater Configuration Menu screen from the Module Specific Configuration Menu screen, select the **REPEATER CONFIGURATION MENU** item and press ENTER. The Repeater Configuration Menu screen displays.

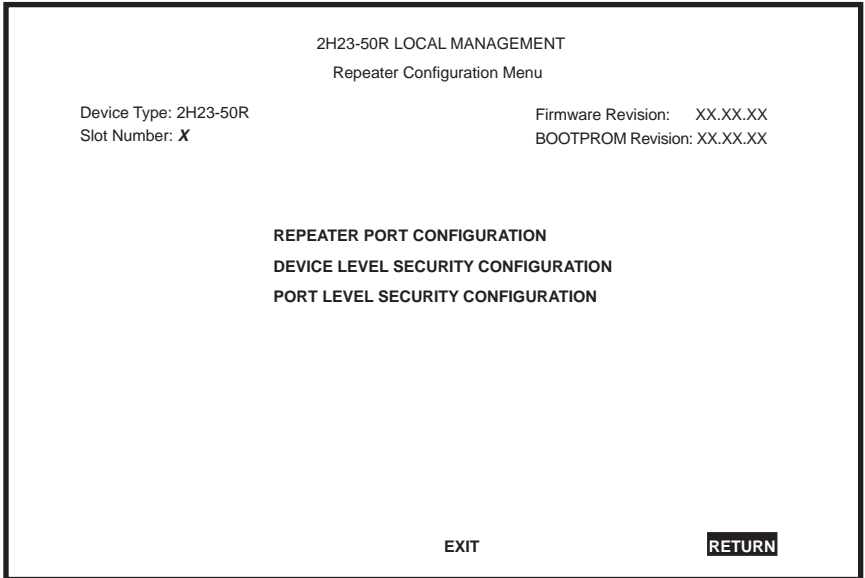

2286_104

Figure 5-25 Repeater Configuration Menu Screen

The following introduces each screen that is accessible from the Repeater Configuration Menu.

REPEATER PORT CONFIGURATION

Used to monitor the link status and current operating mode of each port on the 10-Mbps or 100-Mbps network of a front panel connector, and also turn each port on or off. For details, refer to [Section 5.19](#).

DEVICE LEVEL SECURITY CONFIGURATION

Used to set the state of security for each port of a connector. All ports on a connector can be set to receive all frames (NonSecure state), lock on the source address of the next frame received (LockOnNext), or lock on the address of the last frame received (LockedOnAddr). For details, refer to [Section 5.20](#).

PORT LEVEL SECURITY CONFIGURATION

Used to set the security for all ports of a connector. For details, refer to [Section 5.21](#).

5.19 REPEATER PORT CONFIGURATION SCREEN

The Repeater Port Configuration screen, [Figure 5-26](#), is used to monitor the link status and current operating mode of each port on a 10-Mbps or 100-Mbps network of a front panel connector. The screen is also used to change the operating mode, and turn each port on (enable) or off (disable).

To access the Repeater Port Configuration screen, use the arrow keys to highlight the **REPEATER PORT CONFIGURATION** menu item from the Repeater Configuration Menu screen and press ENTER. The Repeater Port Configuration screen displays.

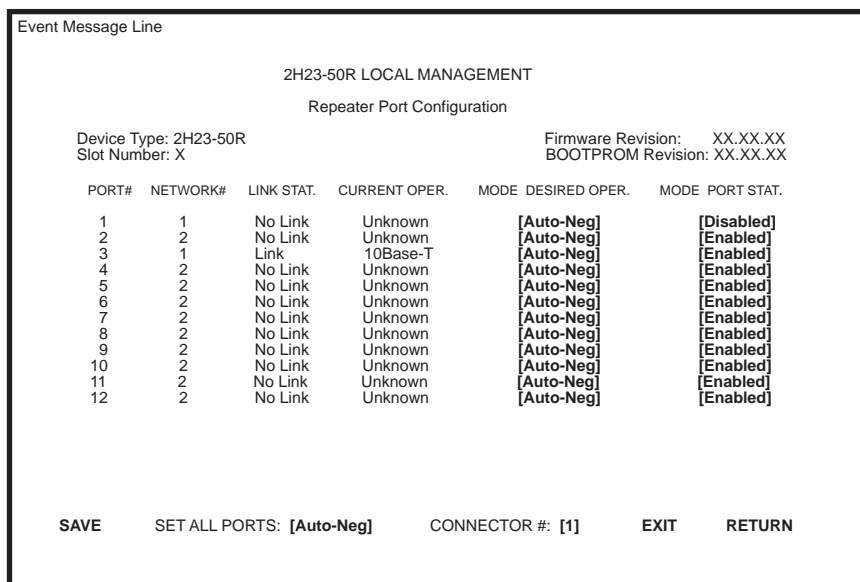

2286_111

Figure 5-26 Repeater Port Configuration Screen

The following are definitions for each field of the Repeater Port Configuration screen:

PORT# (Read-only)

Indicates the repeater port on the connector selected in the CONNECTOR field. Refer to [Table 5-8](#) for the connector (CONN)/repeater port relationship on the device.

Table 5-8 CONN/Repeater Port Relationship

| 2H23-50R or 6H123-50 | 2H33-37R or 6H133-37 |
|---------------------------------|---------------------------------|
| CONN 1 = Repeater ports 1 – 12 | CONN 1 = Repeater ports 1 – 12 |
| CONN 2 = Repeater ports 13 – 24 | CONN 2 = Repeater ports 13 – 24 |
| CONN 3 = Repeater ports 25 – 36 | CONN 3 = Repeater ports 25 – 36 |
| CONN 4 = Repeater ports 37 – 48 | |

NETWORK# (Read-only)

Indicates the network on the connector selected in the CONNECTOR field. [Table 5-9](#) shows the association between the CONN and Network Ports on the device.

Table 5-9 CONN/Port Organization

| 2H23-50R or 6H123-50 | 2H33-37R or 6H133-37 |
|--|--|
| CONN 1 = Network Port 1, 10 Mbps Network Port 2, 100 Mbps | CONN 1 = Network Port 1, 10 Mbps Network Port 2, 100 Mbps |
| CONN 2 = Network Port 3, 10 Mbps Network Port 4, 100 Mbps | CONN 2 = Network Port 3, 10 Mbps Network Port 4, 100 Mbps |
| CONN 3 = Network Port 5, 10 Mbps Network Port 6, 100 Mbps | CONN 3 = Network Port 5, 10 Mbps Network Port 6, 100 Mbps |
| CONN 3 = Network Port 7, 10 Mbps Network Port 8, 100 Mbps | HSIM = Port 7 |

LINK STAT. (Read-only)

Displays the Link status (Link or No Link) of the port.

CURRENT OPER. (Read-only)

Displays the current operating mode of the port.

MODE DESIRED OPER. (Selectable)

This field steps through the following operating mode options: Auto-Neg (Auto Negotiation), 10Base-T, and 100Base-TX.

- When Auto-Neg. is selected, the port Auto-Negotiates with the device to which it is attached to determine its Operating Mode (10 Mbps or 100 Mbps).
- When 10Base-T is selected, the port is forced to operate in standard Ethernet mode (10 Mbps) only.
- When 100Base-TX is selected, the port is forced to operate in Fast Ethernet mode (100 Mbps) only.

To set the port operating mode, refer to [Section 5.19.1](#).

MODE PORT STAT. (Toggle)

Used to enable (turn on) or disable (turn off) the port. To set the port to operating mode, refer to [Section 5.19.2](#).

SET ALL PORTS (Selectable)

Used to select operating mode for all the ports on the connector simultaneously. This field steps through the following selections: Auto-Neg., 10Base T, and 100Base-TX. To set all networks to the same operating mode, refer to [Section 5.19.3](#).

CONNECTOR # (Selectable)

Selects the front panel connector to which the settings will be applied.

5.19.1 Setting the Port Operating Mode

To set the operating mode for one or more network ports, proceed as follows:

1. Use the arrow keys to highlight the **CONNECTOR #** field.
2. Use the SPACE bar to step to the appropriate connector number.
3. Use the arrow keys to highlight the **MODE DESIRED OPER.** field of the network being configured.
4. Use the SPACE bar to step to the appropriate Operating Mode (Auto-Neg, 10Base-T, or 100Base-TX).
5. If setting the operating mode on other ports, repeat steps 3 and 4 for each one and then proceed to step 6.
6. Use the arrow keys to highlight the **SAVE** command.
7. Press ENTER. The message “SAVED OK” displays and all operating mode settings are saved.

5.19.2 Enabling /Disabling Ports

To enable or disable one or more ports, proceed as follows:

1. Use the arrow keys to highlight the **CONNECTOR #** field.
2. Use the SPACE bar to step to the number of the connector containing the network(s) to be enable or disabled.
3. Use the arrow keys to highlight the **MODE PORT STAT.** field of the network being enabled or disabled.
4. Use the SPACE bar to toggle to the appropriate setting (Enabled or Disabled).
5. If setting more than one network, repeat steps 3 and 4 for each one and then proceed to step 6.
6. Use the arrow keys to highlight the **SAVE** command.
7. Press ENTER. The message “SAVED OK” displays and all settings are saved.

5.19.3 Setting All Ports

All the network ports on a connector can be set to the same operating mode simultaneously using the SET ALL PORTS field, as follows:

1. Use the arrow keys to highlight the **CONNECTOR #** field.
2. Use the SPACE bar to step to the appropriate connector number.
3. Use the arrow keys to highlight the **SET ALL PORTS** field.
4. Use the SPACE bar to step to the appropriate Operating Mode (Auto-Neg, 10Base-T, or 100Base-TX).
5. Use the arrow keys to highlight the **SAVE** command.
6. Press ENTER. The message “SAVED OK” displays and all networks of the connector are set to the selected operating mode.

5.19.4 Enabling/Disabling Network Ports

All the network ports on a connector can be set to the same operating mode simultaneously using the SET ALL PORTS field, as follows:

1. Use the arrow keys to highlight the **CONNECTOR #** field.
2. Use the SPACE bar to step to the appropriate connector number.
3. Use the arrow keys to highlight the **SET ALL PORTS** field.
4. Use the SPACE bar to step to the appropriate Operating Mode (Auto-Neg, 10Base-T, or 100Base-TX).
5. Use the arrow keys to highlight the **SAVE** command.
6. Press ENTER. The message “SAVED OK” displays and all networks of the connector are set to the selected operating mode.

5.20 DEVICE LEVEL SECURITY CONFIGURATION

The Device Level Security Configuration screen, [Figure 5-27](#), is used to set the state of security according to connector. All ports on a connector can be set to receive all frames (NonSecure state), lock on the source address of the next frame received (LockOnNext) or the source address of the last frame received (LockedOnAddr). When either of the last two options are set, the switch can be set to enable or disable the reception of frames and send or not send traps.

Table 5-10 CONN/Repeater Port Relationship

| 2H23-50R or 6H123-50 | 2H33-37R or 6H133-37 |
|---------------------------------|---------------------------------|
| CONN 1 = Repeater ports 1 – 12 | CONN 1 = Repeater ports 1 – 12 |
| CONN 2 = Repeater ports 13 – 24 | CONN 2 = Repeater ports 13 – 24 |
| CONN 3 = Repeater ports 25 – 36 | CONN 3 = Repeater ports 25 – 36 |
| CONN 4 = Repeater ports 37 – 48 | |

Security State (Selectable)

Used to select the state of security for frames received by any port on the connector. The states are as follows:

- **PortMismatch** – Indicates that not all ports on the connector are set to the same state.
- **NonSecure** – Allows the ports on the connector to receive all frames. The source address of received frames is not examined and the frames are processed in a non secure state.
- **LockOnNext** – The next frame received by each port is examined to learn its source address. As the source address of a frame is learned on a port, only those frames received with that same source address are processed on that port. Any other address detected is considered as an intruder and the device executes the actions selected in the Action On Intruder field.
- **LockedOnAddr** – The source address of the last frame received (or the source address entered in the Port Level Security Configuration screen, if one is entered) is used for security purposes. Once a secure address is defined on a port, only those frames received with that same source address are processed on that port. Any other frame detected with a different address is considered as an intruder, causing the device to execute the actions selected in the Action On Intruder field.

Action On Intruder (Toggle)

Used to select the actions taken for the selected security state. There are two fields to select the actions. Both toggle to activate or deactivate the action.

- **DisablePort/NoDisable** – **DisablePort** causes the switch to turn off the port that had a security violation. With **NoDisable** set, the port is not turned off.
- **SendTrap/NoTrap** – **SendTrap** causes the switch to send an SNMP trap when a port detects a security violation. With **NoTrap** set, no SNMP trap is sent.

5.20.1 Setting the Device Level Security

To set module security for each connector, proceed as follows:

1. Use the arrow keys to highlight the **SECURITY STATE** field for the connector.
2. Use the **SPACE** bar to step to the appropriate security level.
3. If the security level chosen causes the **DisablePort** and **SendTrap** fields to display under **Action On Intruder**, use the arrow keys to highlight the **DisablePort** field. If the security level chosen does not cause the fields to display under **Action On Intruder**, proceed to step 7.
4. To change the **DisablePort** setting to **NoDisable**, press the **SPACE** bar to toggle the setting.
5. Use the arrow keys to highlight the **SendTrap** field.
6. To change the **SendTrap** setting to **NoTrap**, press the **SPACE** bar to toggle the setting.
7. To change the security on more than one connector, repeat steps 1 through 6 for each connector. Then proceed to step 8 to save all settings at once.
8. Use the arrow keys to highlight the **SAVE** command.
9. Press **ENTER**. The message “**SAVED OK**” displays and all ports of the connector are set to the selected operating mode.

5.21 PORT LEVEL SECURITY CONFIGURATION SCREEN

The Port Level Security Configuration screen, [Figure 5-28](#), functions similarly to the Device Level Security Configuration screen, except that it is used to set the security of each port of a selected connector.

To access the Port Level Security Configuration screen, use the arrow keys to highlight the **PORT LEVEL SECURITY CONFIGURATION** menu item on the Repeater Configuration Menu screen and press ENTER. The Port Level Security Configuration screen displays.

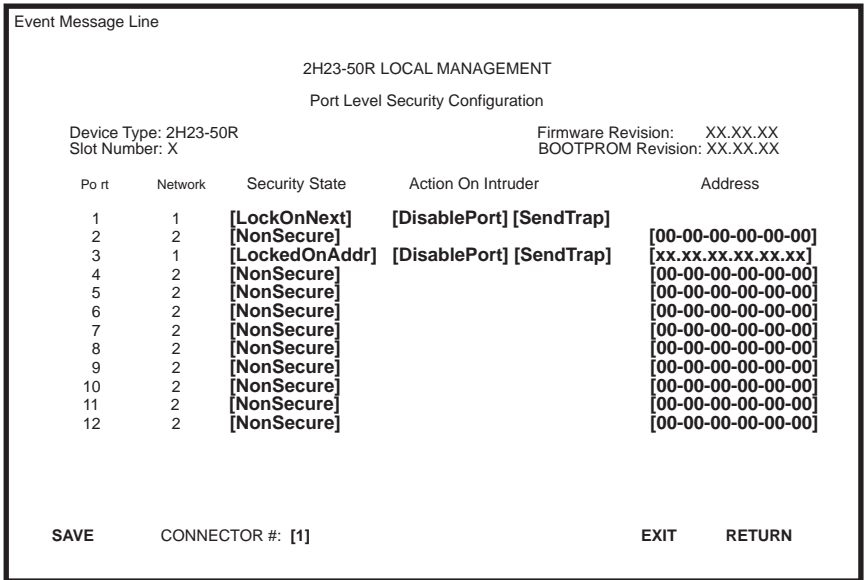

2286_113

Figure 5-28 Port Level Security Configuration Screen

The following section defines the fields on the Port Level Security Configuration screen.

Port (Read-only)

Indicates the repeater port on the connector selected in the CONNECTOR # field. Refer to [Table 5-11](#) for the connector/repeater port relationship on the device.

Table 5-11 CONN/Repeater Port Relationship

| 2H23-50R or 6H123-50 | 2H33-37R or 6H133-37 |
|---------------------------------|---------------------------------|
| CONN 1 = Repeater ports 1 – 12 | CONN 1 = Repeater ports 1 – 12 |
| CONN 2 = Repeater ports 13 – 24 | CONN 2 = Repeater ports 13 – 24 |
| CONN 3 = Repeater ports 25 – 36 | CONN 3 = Repeater ports 25 – 36 |
| CONN 4 = Repeater ports 37 – 48 | |

Network (Read-only)

Indicates the network to which the port is currently attached. [Table 5-12](#) shows the association between the CONN and Network on the device.

Table 5-12 CONN/Network Organization

| 2H23-50R or 6H123-50 | 2H33-37R or 6H133-37 |
|--|--|
| CONN 1 = Network 1, 10 Mbps Network 2, 100 Mbps | CONN 1 = Network 1, 10 Mbps Network 2, 100 Mbps |
| CONN 2 = Network 3, 10 Mbps Network 4, 100 Mbps | CONN 2 = Network 3, 10 Mbps Network 4, 100 Mbps |
| CONN 3 = Network 5, 10 Mbps Network 6, 100 Mbps | CONN 3 = Network 5, 10 Mbps Network 6, 100 Mbps |
| CONN 3 = Network 7, 10 Mbps Network 8, 100 Mbps | HSIM = Port 7 |

Security State (Selectable)

Used to select the state of security for frames received by a specific port on the connector. The states are as follows:

- **PortMismatch** – Indicates that not all ports on the connector are set to the same state.
- **NonSecure** – Allows the ports on the connector to receive all frames. The source address of received frames is not examined and the frames are processed in a non secure state.
- **LockOnNext** – The next frame received by each port is examined to learn its source address. As the source address of a frame is learned on a port, only those frames received with that same source address are processed on that port. Any other address detected is considered as an intruder and the device executes the actions selected in the Action On Intruder field.
- **LockedOnAddr** – The source address of the last frame received (or the source address entered in the Port Level Security Configuration screen, if one is entered) is used for security purposes. Once a secure address is defined on a port, only those frames received with that same source address are processed on that port. Any other frame detected with a different address is considered as an intruder, causing the device to execute the actions selected in the Action On Intruder field.

Action On Intruder (Toggle)

Used to select the actions taken for the selected security state. There are two fields to select the actions. Both toggle to activate or deactivate the action.

- **DisablePort/NoDisable** – DisablePort causes the switch to turn off the port that had a security violation. With NoDisable set, the port is not turned off.
- **SendTrap/NoTrap** – SendTrap causes the switch to send an SNMP trap when a port detects a security violation. With NoTrap set, no SNMP trap is sent.

Address (Modifiable)

Enables the user to enter an address to which the security function is applied. When the port detects any other address in a frame, the switch executes the action selected in the Action On Intruder field. When the security state setting is NonSecure, the field displays the source address of the last frame.

CONNECTOR # (Selectable)

This command field selects the front panel connector to which the port security settings will be applied.

5.21.1 Setting the Port Level Security

To set the security for each repeater port on a connector, proceed as follows:

1. Use the arrow keys to highlight the **CONNECTOR #** field.
2. Use the SPACE bar to step to the appropriate connector number.
3. Use the arrow keys to highlight the **SECURITY STATE** field for a connector.
4. Use the SPACE bar to step to the appropriate security level.
5. If the security level chosen causes the **DisablePort** and **SendTrap** fields to display under Action On Intruder, use the arrow keys to highlight the **DisablePort** field. If the security level chosen does not cause the fields to display under Action On Intruder, proceed to step 9.
6. To change the **DisablePort** setting to **NoDisable**, press the SPACE bar to toggle the setting.
7. Use the arrow keys to highlight the **SendTrap** field.
8. To change the setting to **NoTrap**, press the SPACE bar to toggle the setting.
9. If the security state selected is LockedOnAddr, use the arrow keys to highlight the **Address** field for the port. Otherwise go to step 11.
10. Enter the address to lock on.

11. To change the security on more than one connector, repeat steps 1 through 9 for each connector. Then proceed to step 12 to save all settings at once.
12. Use the arrow keys to highlight the **SAVE** command.
13. Press ENTER. The message “SAVED OK” displays and all ports of the connector are set to the selected operating mode.

5.22 DEVICE STATISTICS MENU SCREEN

The Device Statistics Menu screen, [Figure 5-29](#), provides access to screens that enable the user to obtain switch statistics about frame traffic through each port and view operating statistics about each port.



The following menu item on the Device Statistics Menu screen does not display if the operational mode of the device is set to SECURE FAST VLAN:

SWITCH STATISTICS

[Section 5.7.9](#) provides instructions on setting the operational mode.

To access the Device Statistics Menu from the Device Menu screen, use the arrow keys to highlight the **DEVICE STATISTICS** menu item and press ENTER. The Device Statistics Menu screen displays.

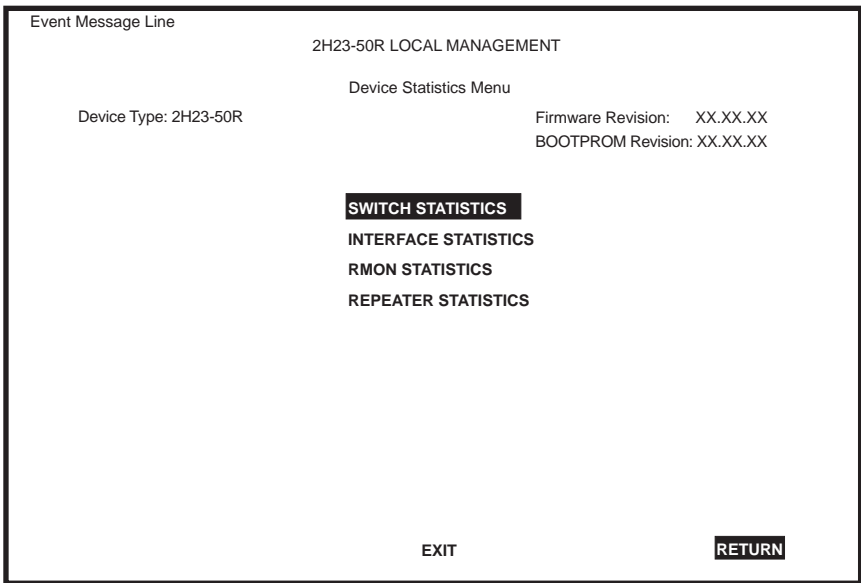

22861-67

Figure 5-29 Device Statistics Menu Screen

The Device Statistics Menu screen displays the following menu items:

SWITCH STATISTICS

The Switch Statistics screen lists the number of frames received, transmitted, filtered, and forwarded by each network port. For details, refer to [Section 5.23](#).

INTERFACE STATISTICS

The Interface Statistics screen provides the MIB-II statistics for each switched network interface, on a interface-by-interface basis. For details, refer to [Section 5.24](#).

RMON STATISTICS

The RMON Statistics screen displays all the statistics gathered by the embedded RMON agent built-in to the 2H23-50R or 2H33-37R. For details, refer to [Section 5.25](#).

REPEATER STATISTICS

The Repeater Statistics screen provides the operating statistics for each Network port (1 through 8 for the 2H23-50R, or 1 through 6 for the 2H33-37R). This screen also displays the statistics for each repeater port. For details, refer to [Section 5.26](#).

5.23 SWITCH STATISTICS SCREEN

The Switch Statistics screen, [Figure 5-30](#), lists the number of frames received, transmitted, filtered, and forwarded by each network port.

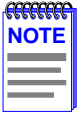

The Switch Statistics screen is not available if the operational mode of the device is set to SECURE FAST VLAN. This screen may only be used when the device is configured to operate as an 802.1D or 802.1Q switch.

To access the Switch Statistics screen from the Device Statistics Menu screen, use the arrow keys to highlight the **SWITCH STATISTICS** menu item and press ENTER. The Switch Statistics screen displays.

| Event Message Line | | | | | |
|---------------------------|-------------|--------------|-----------------------------|---------------|--------|
| 2H23-50R LOCAL MANAGEMENT | | | | | |
| Switch Statistics | | | | | |
| Device Type: 2H23-50R | | | Firmware Revision: XX.XX.XX | | |
| | | | BOOTPROM Revision: XX.XX.XX | | |
| Port # | Frames Rcvd | Frames Txmtd | Frames Fltrd | Frames Frwded | |
| 1 | 100 | 100 | 0 | 100 | |
| 2 | 100 | 100 | 0 | 100 | |
| 3 | 100 | 100 | 0 | 100 | |
| 4 | 100 | 100 | 0 | 100 | |
| 5 | 100 | 100 | 0 | 100 | |
| 6 | 100 | 100 | 0 | 100 | |
| 7 | 100 | 100 | 0 | 100 | |
| CLEAR COUNTERS | | | EXIT | | RETURN |

22861-26

Figure 5-30 Switch Statistics Screen

The Switch Statistics screen displays the following fields:

Port # (Read-Only)

Identifies the port. There can be ten or seven ports depending on whether the device is a 2H23-50R or 2H33-37R, respectively. [Table 5-13](#) shows the port organization.

Table 5-13 CONN/Port Organization

| 2H23-50R | 2H33-37R |
|--|--|
| CONN 1 = Network Port 1, 10 Mbps Network Port 2, 100 Mbps | CONN 1 = Network Port 1, 10 Mbps Network Port 2, 100 Mbps |
| CONN 2 = Network Port 3, 10 Mbps Network Port 4, 100 Mbps | CONN 2 = Network Port 3, 10 Mbps Network Port 4, 100 Mbps |
| CONN 3 = Network Port 5, 10 Mbps Network Port 6, 100 Mbps | CONN 3 = Network Port 5, 10 Mbps Network Port 6, 100 Mbps |
| CONN 4 = Network Port 7, 10 Mbps Network Port 8, 100 Mbps | HSIM = Port 7 |
| Fast Ethernet Slot 5 = Port 9 | |
| Fast Ethernet Slot 6 = Port 10 | |

Frames Rcvd (Read-Only)

Displays the number of frames received by the port since last power-up or reset.

Frames Txmtd (Read-Only)

Displays the number of frames transmitted by the port since last power-up or reset.

Frames Fltrd (Read-Only)

Displays the number of frames filtered by the port since last power-up or reset.

Frames Frwded (Read-Only)

Displays the number of frames forwarded by the port.

CLEAR COUNTERS (Command)

This command clears all the counters of the displayed ports to zero. To clear the counters, use the arrow keys to highlight **CLEAR COUNTERS** at the bottom of the screen, then press ENTER.

5.24 INTERFACE STATISTICS SCREEN

The Interface Statistics screen, [Figure 5-31](#), is used to gather MIB-II statistics for all the 2H23-50R or 2H33-37R interfaces with the exception of an installed HSIM in a 2H33-37R.



Cabletron Systems HSIMs gather their own statistics that may be viewed via the Local Management screens of the applicable HSIM. Refer to your HSIM documentation for information on how to access these screens.

To access the Interface Statistics screen, use the arrow keys to highlight the **INTERFACE STATISTICS** menu item on the Device Statistics Menu screen and press ENTER. The Interface Statistics screen displays.

| | | | |
|-------------------------|---------|--|--------------------|
| Event Message Line | | 2H23-50R LOCAL MANAGEMENT | |
| | | Interface Statistics | |
| Device Typeee: 2H23-50R | | Firmware Revision: XX.XX.XX BOOTPROM Revision: XX.XX.XX | |
| Interface: 1 | | Name: Ethernet Frontpanel | |
| InOctets: | 7500456 | Address: | 00-00-00-00-00-00 |
| InUnicast: | 6789 | Last Change: | xx days 00:00:00 |
| InNonUnicast: | 0 | Admin Status: | Up |
| InDiscards: | 0 | Oper Status: | Down |
| InErrors: | 0 | | |
| InUnknownProtos: | 0 | MTU: | 1514 |
| OutOctets: | 0 | Speed: | 100000000 |
| OutUnicast: | 0 | | |
| OutNonUnicast: | 0 | | |
| OutDiscards: | 0 | Link Status: | No Link |
| OutErrors: | 0 | Duplex Mode: | Standard |
| OutQLen: | 0 | | |
| Interface: [nn] | | CLEAR COUNTERS | EXIT RETURN |

22861_64

Figure 5-31 Interface Statistics Screen

The following definitions explain each field of the Interface Statistics screen:

Interface (Read-Only)

This field displays the Interface number for which statistics are currently being displayed. [Figure 5-31](#) shows the Interface field displaying 1. This represents the 10 Mbps interface of CONN 1. To view other interface statistics, refer to [Section 5.24.1](#).

Name (Read-Only)

The Name field displays the type of interface for which statistics are being displayed.

InOctets (Read-Only)

This field displays the total number of octets (bytes) that have been received on the Interface. This includes all octets including bad frames and framing characters.

InUnicast (Read-Only)

The InUnicast field displays the total number of frames that have been received that were sent to a single address.

InNonUnicast (Read-Only)

This field displays the total number of frames that have been received that were delivered to a broadcast or multicast address.

InDiscards (Read-Only)

The InDiscards field displays the total number of inbound frames that were discarded, even though the frames contained no errors. This field may increment because it was in an initialization phase and not ready to forward frames, the switch needed to free up buffer space, or the switch was being overutilized.

InErrors (Read-Only)

This field displays the total number of inbound frames that have been discarded because they contained errors. This field represents the total number of errored frames, regardless of the cause of the error.

InUnknownProtos (Read-Only)

The InUnknownProtos field displays the total number of frames that were discarded because the frames were in an unknown or unsupported format.

OutOctets (Read-Only)

This field displays the total number of octets (bytes) that have been transmitted from the interface.

OutUnicast (Read-Only)

The OutUnicast field displays the total number of frames transmitted that were sent to a single address.

OutNonUnicast (Read-Only)

This field displays the total number of frames transmitted to a broadcast or multicast address.

OutDiscards (Read-Only)

The OutDiscards field displays the total number of outbound frames that were discarded, even though the frames contained no errors. This field may increment, because the switch needed to free up buffer space, or the switch was being overutilized.

OutErrors (Read-Only)

This field displays the total number of outbound frames discarded because they contained errors. This field represents the total number of errored frames, regardless of the cause of the error.

OutQLen (Read-Only)

The OutQLen field displays the length of the frame queue. The field represents the total number of frames that can be held in queue.

Address (Read-Only)

This field displays the MAC address of the interface that is currently being displayed.

Last Change (Read-Only)

This field displays the last time that the interface was reset.

Admin Status (Read-Only)

This field displays the current status of the interface. If this field displays “Testing”, no frames may be passed on this interface.

Oper Status (Read-Only)

This field displays the current status of the interface. If this field displays “Testing”, no frames may be passed on this interface.

MTU (Read-Only)

The MTU field displays the maximum frame size (in octets) that a frame may contain to be received or transmitted from this interface.

Speed (Read-Only)

The Speed field displays the theoretical maximum of the interface's bandwidth in bits per second.

Link Status (Read-Only)

This field displays the current link status of the interface. This field displays either "Link" or "No Link".

Duplex Mode (Read-Only)

This field indicates whether the interface is operating in normal (standard) or full duplex mode. This field displays either "Standard" or "Full Duplex".

Interface [*nn*] (Command)

This command is used to enter an interface number for viewing statistics. For instructions on how to use this command, refer to [Section 5.24.1](#).

CLEAR COUNTERS (Command)

This command is used to reset all statistic counters to zero. For details on how to use this field, refer to [Section 5.24.2](#).

5.24.1 Displaying Interface Statistics

To display the statistics for any interface, proceed as follows:

1. Use the arrow keys to highlight the **Interface [*nn*]** field at the bottom of the screen.
2. Press the SPACE bar to increment (or press the DEL [delete] key to decrement) the interface number.
3. Press ENTER (neither the Interface # fields nor the statistics change until ENTER is pressed).

5.24.2 Using the Clear Counters Command

To reset all the statistics counters of the selected interface to zero, perform the following steps:

1. Use the arrow keys to highlight the **CLEAR COUNTERS** command field.
2. Press ENTER, the counters for the selected interface are reset to zero.

5.25 RMON STATISTICS SCREEN

RMON statistics for each network port, on an port-by-port basis, are viewed through the RMON Statistics screen shown in [Figure 5-32](#).

Access the RMON Statistics screen by using the arrow keys to highlight the **RMON STATISTICS** field on the Device Statistics Menu screen and pressing ENTER. The RMON Statistics screen displays.

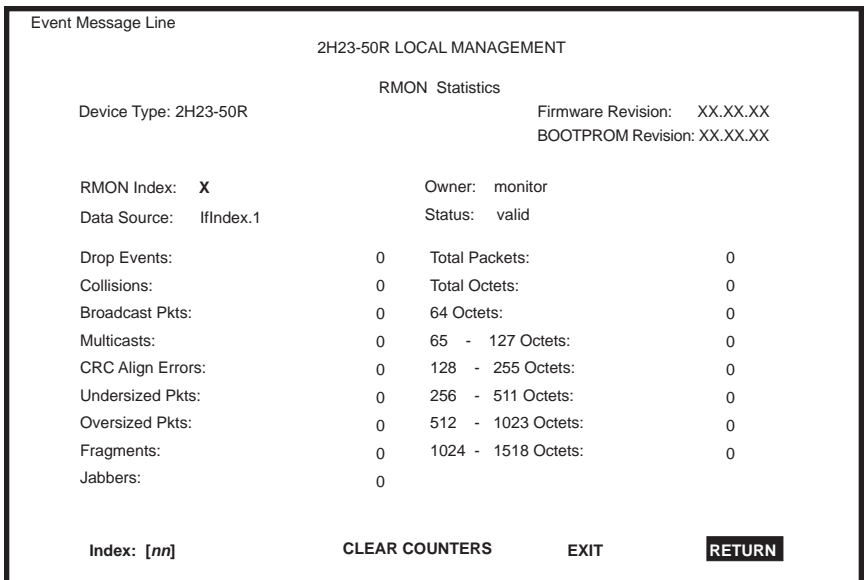

22861_65

Figure 5-32 RMON Statistics Screen

The following briefly defines each field of the RMON Statistics screen:

RMON Index (Read-only)

This field displays the current Ethernet interface for which statistics are being shown. The 2H23-50R or 2H33-37R has an embedded RMON agent that gathers statistics for each of its interfaces.

Data Source (Read-only)

This field displays the source of the statistics data that is currently being displayed on the screen. **Figure 5-32** shows that the data source for this RMON index is Interface 1 (Network Port 1, 10 Mbps of CONN 1) by displaying the name IfIndex.1. If the screen was displaying RMON statistics for Interface 4 (Network Port 4, 100 Mbps of CONN 2), the name displayed would be IfIndex.4. **Table 5-14** shows the association between the CONN and Network Ports for the 2H23-50R and 2H33-37R.

Table 5-14 CONN/Network Interfaces

| 2H23-50R | 2H33-37R |
|--|--|
| CONN 1 = Network Port 1, 10 Mbps Network Port 2, 100 Mbps | CONN 1 = Network Port 1, 10 Mbps Network Port 2, 100 Mbps |
| CONN 2 = Network Port 3, 10 Mbps Network Port 4, 100 Mbps | CONN 2 = Network Port 3, 10 Mbps Network Port 4, 100 Mbps |
| CONN 3 = Network Port 5, 10 Mbps Network Port 6, 100 Mbps | CONN 3 = Network Port 5, 10 Mbps Network Port 6, 100 Mbps |
| CONN 4 = Network Port 7, 10 Mbps Network Port 8, 100 Mbps | |

Owner (Read-only)

This field displays the name of the entity that configured this entry.

Status (Read-only)

The Status field displays the current operating status of the displayed interface. This field displays “valid” or “invalid”.

Drop Events (Read-only)

This field displays the total number of times that the RMON agent was forced to discard frames due to the lack of available switch resources.



The Drop Events field does not display the number of frames dropped, it only displays the number of times that the RMON agent was forced to discard frames. Drop events are a normal occurrence during switch initialization.

Collisions (Read-only)

This field displays the total number of collisions that have occurred on this interface.

Broadcast Pkts (Read-only)

The Broadcast Pkts field displays the total number of good frames that were directed to the broadcast address. The value of this field does not include multicast frames.

Multicasts (Read-only)

The Multicast field displays the total number of good frames received that were directed to a multicast address. The value of this field does not include frames directed to the broadcast address.

CRC Align Errors (Read-only)

This field displays the number of frames with bad Cyclic Redundancy Checks (CRC) received from the network. The CRC is a 4-byte field in the data frame that ensures that the data received is the same as the data that was originally sent.

Undersized Pkts (Read-only)

The Undersized Pkts field displays the number of frames received whose size was less than the minimum Ethernet frame size of 64 bytes, not including preamble, but have a valid CRC.

Oversized Pkts (Read-only)

The Oversized Pkts field displays the number of frames received whose size exceeded 1518 data bytes, not including preamble, but having a valid CRC.

Fragments (Read-only)

This field displays the number of received frames that are not the minimum number of bytes in length or received frames that had a bad CRC, were less than 64 bytes in length (excluding framing bits, but including CRC bytes).

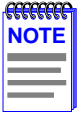

It is normal for the Fragments field to increment. This is because the RMON agent increments the field when runts are detected (which are normal occurrences due to collisions) and when noise hits occur.

Jabbers (Read-only)

This field displays the total number of frames that were greater than 1518 bytes and a bad CRC.

Total Packets (Read-only)

This field displays the total number of frames (including bad frames, broadcast frames, and multicast frames) received on this interface.

Total Octets (Read-only)

This field displays the total number of octets (bytes) of data, including those in bad frames, received on this interface.

64 Octets (Read-only)

Displays the total number of frames, including bad frames, received that were 64 bytes in length (excluding framing bits, but including FCS bytes).

65 – 127 Octets (Read-only)

Displays the total number of frames, including bad frames, received that were between 65 and 127 bytes in length (excluding framing bits, but including FCS bytes).

128 – 255 Octets (Read-only)

Displays the total number of frames, including bad frames, received that were between 128 and 255 bytes in length (excluding framing bits, but including FCS bytes).

256 – 511 Octets (Read-only)

Displays the total number of frames, including bad frames, received that were between 256 and 511 bytes in length (excluding framing bits, but including FCS bytes).

512 – 1023 Octets (Read-only)

Displays the total number of frames, including bad frames, received that were between 512 and 1023 bytes in length (excluding framing bits, but including FCS bytes).

1024 – 1518 Octets (Read-only)

Displays the total number of frames, including bad frames, received that were between 1024 and 1518 bytes in length (excluding framing bits, but including FCS bytes).

Index [nn] (Command)

This command is used to enter an index number for viewing statistics. For instructions on how to use this command, refer to [Section 5.25.1](#).

CLEAR COUNTERS (Command)

This command is used to reset all statistic counters to zero. For details on how to use this command, refer to [Section 5.25.2](#).

5.25.1 Displaying RMON Statistics

To display the statistics for any index, proceed as follows:

1. Use the arrow keys to highlight the **Index [nn]** field at the bottom of the screen.
2. Press the SPACE bar to increment (or press the DEL [delete] key to decrement) the index number.
3. Press ENTER (neither the **RMON Index #** field nor the statistics change until ENTER is pressed).

5.25.2 Using the Clear Counters Command

To reset all the statistics counters of the selected interface to zero, perform the following steps:

1. Use the arrow keys to highlight the **CLEAR COUNTERS** field.
2. Press ENTER, the counters for the selected index are reset to zero.

5.26 REPEATER STATISTICS SCREEN

Operating statistics for each repeater port (1 through 48 for the 2H23-50R, or 1 through 36 for the 2H33-37R) and its corresponding network interface are displayed via the Repeater Statistics screen shown in Figure 5-33.

To access the Repeater Statistics screen, use the arrow keys to highlight the **REPEATER STATISTICS** menu item on the Device Statistics Menu screen and press ENTER. The Repeater Statistics screen displays.

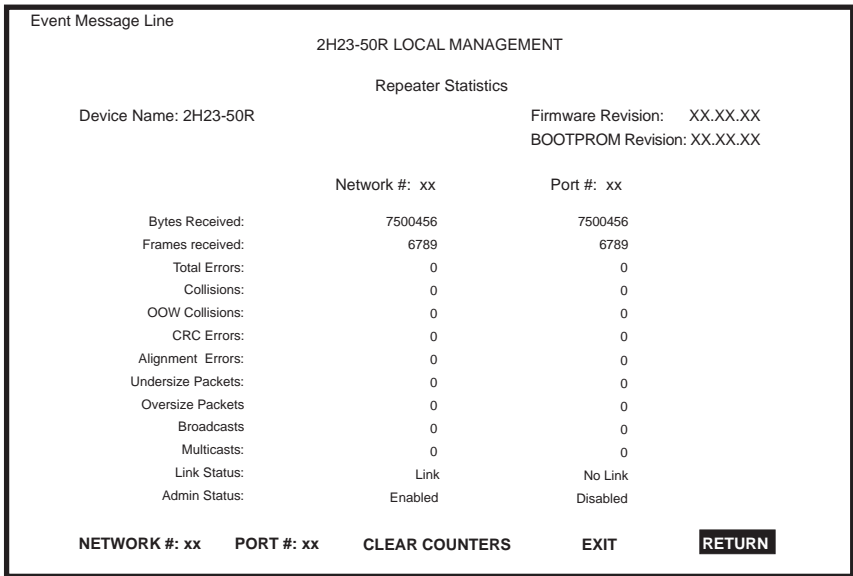

22862-29

Figure 5-33 Repeater Statistics Screen

The following describes each field of the Repeater Statistics screen:

Network # (Read-Only)

Indicates the current network port (1 through 8, for the 2H23-50R or 1 through 6, for the 2H33-37R) for which statistics are displayed. This field is automatically set by selecting a port number in the PORT # command field at the bottom of the screen. For example, if 4 is selected in the PORT # command field, the statistics for Network 4 (CONN 2, 100 Mbps Network Port) displays along with the statistics for the selected port.

Table 5-15 shows the association between the CONN and Network Ports for the 2H23-50R and 2H33-37R.

Table 5-15 CONN/Network Interfaces

| 2H23-50R | 2H33-37R |
|--|--|
| CONN 1 = Network Port 1, 10 Mbps Network Port 2, 100 Mbps | CONN 1 = Network Port 1, 10 Mbps Network Port 2, 100 Mbps |
| CONN 2 = Network Port 3, 10 Mbps Network Port 4, 100 Mbps | CONN 2 = Network Port 3, 10 Mbps Network Port 4, 100 Mbps |
| CONN 3 = Network Port 5, 10 Mbps Network Port 6, 100 Mbps | CONN 3 = Network Port 5, 10 Mbps Network Port 6, 100 Mbps |
| CONN 4 = Network Port 7, 10 Mbps Network Port 8, 100 Mbps | |

Port # (Read-Only)

Indicates the current repeater port for which statistics are displayed. The port number can be changed by using the PORT # command field at the bottom of the screen. Depending on the port number entered, the Network # field will automatically change to indicate the associated Network Port. Table 5-16 shows CONN/repeater port relationship.

Table 5-16 CONN/Repeater Port Relationship

| 2H23-50R | 2H33-37R |
|---------------------------------|---------------------------------|
| CONN 1 = Repeater ports 1 – 12 | CONN 1 = Repeater ports 1 – 12 |
| CONN 2 = Repeater ports 13 – 24 | CONN 2 = Repeater ports 13 – 24 |
| CONN 3 = Repeater ports 25 – 36 | CONN 3 = Repeater ports 25 – 36 |
| CONN 4 = Repeater ports 37 – 48 | |

For details on how to use this field, refer to Section 5.26.2.

Bytes Received (Read-only)

Displays the number of bytes received.

Frames Received (Read-only)

Displays the number of frames received.

Total Errors (Read-only)

Displays the total number of errors.

Collisions (Read-only)

Displays the total number of collisions that were detected.

OOW Collisions (Read-only)

Displays the number of Out Of Window (OOW) collision errors detected. These collisions can be caused by a station on the network violating Carrier Sense and transmitting at will, a cable failure occurring during the transmission of a frame, or a network propagation delay greater than 51.2 μ s.

CRC Errors (Read-only)

Displays the number of frames with bad Cyclic Redundancy Checks (CRC) received from the network. The CRC is a 4-byte field in the data frame that ensures that the data that is received is the same as the data that was originally sent.

Alignment Errors (Read-only)

Displays the number of alignment errors detected. Alignment errors occur when the total number of bits in a frame are not divisible by eight due to missing bits in the bytes contained in the frame.

Undersize Packets (Read-only)

Displays the number of frames received with a valid CRC and whose size was less than the minimum Ethernet frame size of 64 bytes (not including the preamble).

Oversize Packets (Read-only)

Displays the number of frames received with a valid CRC and whose size exceeded 1518 data bytes (not including preamble).

Broadcasts (Read-only)

Displays the number of broadcasts transmitted and received.

Multicasts (Read-only)

Displays the number of multicasts transmitted and received.

Link Status (Read-only)

Indicates if the network or port is linked (**Link**) or not linked (**No Link**).

Admin Status (Read-only)

Indicates if the network or port is enabled (**Enabled**) or disabled (**Disabled**).

NETWORK # (Command)

This command is used to select a particular Network to view its statistics. When the Network is selected the statistics are also displayed for the first port in the Network under Port #. For details, refer to [Section 5.26.1](#)

PORT # (Command)

This command is used to select a particular Port to view its statistics and those of its associated Network. For details, refer to [Section 5.26.2](#).

CLEAR COUNTERS (Command)

This command sets all statistics counters to zero. For details on how to use this command, refer to [Section 5.26.3](#).

5.26.1 Displaying Network Statistics

To display the statistics of any Network, proceed as follows:

1. Use the arrow keys to highlight the **NETWORK #** command field at the bottom of the screen.
2. Press the SPACE bar to increment or press the BACKSPACE key to decrement the port number.
3. Press ENTER (the NETWORK #, the first PORT # of the Network, and the associated statistics do not display until ENTER is pressed).

5.26.2 Displaying Network Port Statistics

To display the statistics for any repeater port, proceed as follows:

1. Use the arrow keys to highlight the **PORT #** command field at the bottom of the screen.
2. Press the SPACE bar to increment or press the BACKSPACE key to decrement the port number.
3. Press ENTER (the PORT #, the NETWORK # of the associated network, and the statistics do not change until ENTER is pressed).

5.26.3 Using the Clear Counters Command

To reset all the statistics counters of the selected port to zero, perform the following steps:

1. Use the arrow keys to highlight the **CLEAR COUNTERS** command field at the bottom of the screen.
2. Press ENTER. The counters for the selected port are reset to zero.

5.27 NETWORK TOOLS

The Network Tools function allows the user to access and manage network devices. Figure 5-34 shows the Network Tools help screen.

To access the Network Tools screen, use the arrow keys to highlight the **NETWORK TOOLS** menu item in the Device Menu screen and press ENTER. The Network Tools screen displays.

```
Welcome to Network Tools

-> help

Commands Available to User

Built in Commands:

arp          bridge      defroute
netstat      ping        reset
show        traceroute

soft_reset  telnet      link_trap

atm_stp_state
SPECIAL:
done, quit, or exit - Exit from the Network Tools.
For help with a specific command, type 'help <command>'.

->
```

090829

Figure 5-34 Network Tools Screen

The Network Tools functions are performed using a series of commands. Entering commands in Network Tools involves typing the command to be executed at the Network Tools prompt, adding any desired or required extensions, and pressing ENTER.

There are two categories of commands in the command set.

- Built-in Commands – Allow the user to access and manage network devices. The commands are **arp**, **bridge**, **defroute**, **netstat**, **ping**, **reset**, **show**, **traceroute**, **soft-reset**, **telnet**, **link_trap**, and **atm_stp_state**.
- Special Commands – Allow the user to exit from Network Tools. The commands are **done**, **exit**, and **quit**.

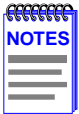

The conventions used in describing the commands in Network Tools are as follows:

Arguments enclosed by [] are required.

Arguments enclosed by < > are optional.

In the following command examples, the information entered by the user is shown in **bold** Helvetica font.

To abort the output or interrupt a process, press the CONTROL key and c key simultaneously, designated as ^C here.

The commands are presented in the following format:

command:

| | |
|---------------------|---|
| Syntax: | Shows the required command format. It indicates where arguments, if any, must be specified. |
| Description: | Briefly describes the command and its uses. |
| Options: | Lists any additional fields in the appropriate format which may be added to the command. |
| Example: | Shows an example of the command. |

5.27.1 Built-in Commands

The built-in commands listed in this section activate functions on the LM managed device or devices being accessed through Network Tools.

arp:

Syntax: arp <options>

Description: The arp command provides access to the ARP (Address Resolution Protocol) cache, enabling you to view cache data, delete entries, or add a static route. Super-user access is required to delete an entry or add a static route.

Each ARP cache entry lists the network *interface* that the device is connected to, the device's *network address* or IP address, the device's *physical address* or MAC address, and the *media type* of connection to the device. Media types display as numbers, which stand for the following states:

- 1 - Other
- 2 - Invalid entry (cannot ping device, timed out, etc.)
- 3 - Dynamic route entry
- 4 - Static route entry (not subject to change)

You can specify the arp command without options, or with one of the following options:

- Options:**
- a Views cache data
 - d Deletes an IP address entry. Requires additional arguments: <Interface Number> <IP address>
 - s Adds a static entry. Requires additional arguments: <Interface Number> <IP address> <MAC address>
 - f Flushes the ARP cache

Example:

```

-> arp -a
# Interface      Network Address  Physical Address  Media Type
# (SonicInt)    122.144.40.111  00.00.0e.12.3c.04 3(dynamic)
# (SonicInt)    122.144.48.109  00.00.0e.f3.3d.14 3(dynamic)
# (SonicInt)    122.144.52.68   00.00.0e.12.3c.04 3(dynamic)
# (SonicInt)    122.144.21.43   00.00.0e.03.1d.3c 3(dynamic)

-> arp -d 1 122.144.52.68

-> arp -s 1 22.44.2.3 00:00:0e:03:1d:3c

-> arp -f

```

05141-67

bridge:**Syntax:**

bridge [ENABLE/DISABLE] [IFNUM/ALL]

Description:

The bridge command allows the bridge interface to be enabled or disabled at the user's request, either one at a time or all at once. Specifying a single interface number will affect the bridging status of that interface, while specifying ALL will affect every interface.

Options:

Not Applicable

Example:

```

-> bridge disable all

-> bridge enable 1

-> bridge disable 1

```

05141-68

defroute:

Syntax: defroute
defroute [interface number] [IP address]
defroute delete [interface number] [IP address]

Description: The defroute command allows the user, in the syntax order shown above, to view, set, or delete the default IP route to a managed device through the specified interface.

Options: Not Applicable

Example:

```
-> defroute 2 147.152.42.32
```

05141-69

netstat:

Syntax: netstat [option]

Description: The netstat command provides a display of general network statistics for the managed device. The netstat command must be used with one of the two display options.

Options:

- i Displays status and capability information for each interface.
- r Displays routing information for each interface.

Example:

```

-> netstat -i
Interface + Description      MTU      Speed    Admin   Oper    MAC Addr
# 1 (ethernet - csmacd)    1514     10000000 up      up      0x00 0x00 0x1d 0x07 0x50 0x0e
# 2 (ethernet - csmacd)    1514     10000000 up      up      0x00 0x00 0x1d 0x07 0x50 0x0f
# 3 (ethernet - csmacd)    1514     10000000 up      up      0x00 0x00 0x1d 0x07 0x50 0x10
# 4 (ethernet - csmacd)    1514     10000000 up      up      0x00 0x00 0x1d 0x07 0x50 0x11

-> netstat -r
Destination                Next-hop                Interface
# Default Route            DirectConnection        1
# 134.141.0.0              DirectConnection        2
# 134.141.0.0              DirectConnection        3

```

05141-70

ping:**Syntax:**

ping [IP address]

Description:

The ping command generates an outbound ping request to check the status (alive/not alive) of a device at a specified IP address.

Options:

Not Applicable

Example:

```

-> ping 122.144.40.10
122.144.40.10 is alive

```

05141-71

reset:

Syntax: reset

Description: This reset command initiates a hardware reset of the device. The reset command initializes the CPU processor, runs the onboard diagnostics, and restarts the software image, which restores the user configuration settings from NVRAM. The user will be queried to confirm the reset command to ensure against unwanted resets.



The Network Tools connection to the device will be terminated upon execution of this command.

Options: Not Applicable

Example:

```
-> reset
```

17421-45

show:

Syntax: show <PROTOCOL> <TABLE>

Description: The show command displays information concerning various components of the device. Protocols currently supported are IP, IPX, DECnet, and AppleTalk. Components of those protocols that are currently supported are ARP caches, route tables, FIB tables, server tables, and interface tables. The number of valid entries in the table will be displayed at the end of the table display.

Options: Not Applicable

Example:

```
-> show Appletalk interfaces
```

| # | Interface | AdminStatus | OperStatus | MTU | Forwarding | Framing |
|-----|-----------|-------------|------------|------|------------|----------|
| # 1 | | enabled | enabled | 1500 | enabled | ethernet |
| # 2 | | disabled | disabled | 1500 | disabled | ethernet |

```
-> show IP ARP
```

| # | Interface | MediaType | PhysicalAddress | NetworkAddress |
|-----|-----------|-------------|-------------------|----------------|
| # 3 | | 3 (dynamic) | 00:00:1d:04:40:5d | 123.456.40.1 |
| # 4 | | 3 (dynamic) | 08:00:20:0e:d8:31 | 123.456.40.30 |

17421-46

traceroute:

Syntax: traceroute [IP address]

Description: The traceroute command generates a TRACEROUTE request to a specified IP address and provides a display of all next-hop routers in the path to the device. If the device is not reached, the command displays all next-hop routers to the point of failure.

Options: Not Applicable

Example:

```
-> traceroute 122.144.11.52
```

```
# next-hop[0] : 122.144.60.45
# next-hop[1] : 122.144.8.113
# next-hop[2] : 122.144.61.45
# 122.144.11.52 is alive : 3 hops away.
```

05141-77

soft_reset

Syntax: soft_reset

Description: This command restarts the software image, which restores the user configuration settings from NVRAM. The user will be queried to confirm the reset command to ensure against unwanted resets.



The Network Tools connection to the device will be terminated upon execution of this command.

Options: Not Applicable

Example:

```
-> soft-reset
```

22511-76

telnet:

Syntax: telnet [IP address] [Port #]

Description: The telnet command allows the user to communicate with another host (that supports Telnet connections) using the Telnet protocol. The user must specify the remote host using its IP address. The [IP address] field is mandatory. If no Port number is specified, telnet will attempt to contact the host at the default port.

Options: Not Applicable

Example:

```
-> telnet 134.141.12.345
Trying 134.141.12.345
Connected to 134.141.12.345
```

```
SunOS UNIX (server1)
```

```
login:
```

2251-77

link_trap:**Syntax:**

`link_trap [enable/disable/status] [PORT/all]`

Description:

The `link_trap` command allows link traps to be enabled or disabled when specifying a single port, or simultaneously when specifying “all” or no ports. When one or all ports are specified to enable, disable, or find their status, their current condition is displayed.

Options:

Not Applicable

Example:

```
-> link_trap status
LINK TRAP STATUS:

  Port 1 is ENABLED      Port 2 is DISABLED
  Port 3 is ENABLED      Port 4 is ENABLED

-> link_trap disable 2
Link traps have been DISABLED on port 2

-> link_trap disable all
Link traps have been DISABLED on all ports (1-24)

-> link_trap status 3
Link traps are ENABLED on port 3
```

2314-78

atm_stp_state:

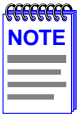

The **atm_stp_state** command is only available if an HSI-M-A6DP is installed in the device (e.g., 6E13X-25). This command allows the user to enable, disable, or check the current status of the Spanning Tree Algorithm on all ATM interfaces.

Syntax: atm_stp_state [STATE]

Description: The atm_stp_state command allows the user to enable, disable, or check the status of the Spanning Tree Algorithm on all ATM interfaces. The user must specify the STATE option as enable, disable, or status. The STATE field is mandatory.

Options: enable, disable, status

Example:

```
-> atm_stp_state status
Atm Stp is Enabled
-> atm_stp_state disable
-> atm_stp_state enable
```

2314-79

5.27.2 Special Commands

done, quit, exit:

Syntax: done, quit, or exit

Description: The done, quit, or exit command enables the user to exit from Network Tools and return to the Main Menu screen.

Options: Not Applicable

Example:

```
-> done  
  
Connection closed
```

05141-72

APPENDIX A

SPECIFICATIONS

This appendix provides operating specifications for the 2H23-50R and 2H33-37R. Cabletron Systems reserves the right to change these specifications at any time without notice.

A.1 DEVICE SPECIFICATIONS

| | |
|--------------------------------------|---------------------------|
| Processor: | Intel i960 RISC processor |
| Dynamic Random Access Memory (DRAM): | 20 MB |
| FLASH Memory: | 4 MB |

A.2 PHYSICAL PROPERTIES

| | |
|-------------------------|---|
| Dimensions: | 7.11H x 43.18W x 46.99D (cm) 2.8H x 17W x 18.5D (in) |
| Weight (Unit) 2H23-50R: | 3.18 kg (7 lb) |
| Weight (Unit) 2H33-37R: | 5.45 kg (12 lb) |
| MTBF (Predicted): | 200,000 hours |

A.3 ELECTRICAL SPECIFICATIONS

| Line Input Range Volts (V) | Input Current Amperes (A) | Frequency Hertz (Hz) | Input Power Volt Amps (VA) |
|----------------------------|---------------------------|----------------------|----------------------------|
| 100–125 Vac | 2.0 A | 50/60 Hz | 200 VA |
| 200–240 Vac | 1.0 A | | |

A.4 ENVIRONMENTAL REQUIREMENTS

- Operating Temperature: 5°C to 40°C (41°F to 104°F)
- Storage Temperature: -30°C to 73°C (-22°F to 164°F)
- Operating Relative Humidity: 5% to 90% (non-condensing)

A.5 INPUT/OUTPUT PORTS

- 2E23-50R – CONN 1 through CONN 4 (ports 1 through 4) or 2E33-37R – CONN 1 through CONN 3 (ports 1 through 3): Ethernet (10BASE-T and 100BASE-TX compliant) with RJ21 type connectors. Each connector provides connection for 12 UTP ports. Each port can operate on either a 10 Mbps or 100 Mbps segment.

Each port has auto-negotiation capability to establish maximum transmission speed (10 Mbps or 100 Mbps).
- 2E23-50R – Slots for optional Fast Ethernet Interface Modules (ports 5 and 6): Slots accept three types of optional Fast Ethernet Interface Modules: FE100-TX, FE100-FX, and FE100-F3.
- 2E33-37R – Slot for optional HSIM: Slot accepts optional High Speed Interface Modules.

A.6 COM PORT PINOUT ASSIGNMENTS

The COM port is a serial communications port that supports Local Management or connection to a UPS.

Table A-1 shows the COM port pin assignments.

Table A-1 COM Port Pin Assignments

| Pin | Signal Name | Input/Output |
|-----|---------------------------|--------------|
| 1 | Transmit Data (XMT) | Output |
| 2 | Data Carrier Detect (DCD) | Output |
| 3 | Data Set Ready (DSR) | Input |
| 4 | Receive Data (RCV) | Input |
| 5 | Signal Ground (GND) | NA |
| 6 | Data Terminal Ready (DTR) | Output |
| 7 | Request to Send (RTS) | Input |
| 8 | Clear to Send (CTS) | NA |

A.7 REGULATORY COMPLIANCE

This equipment meets the following safety and electromagnetic compatibility (EMC) requirements:

| | |
|--------|---|
| Safety | UL 1950, CSA C22.2 No. 950, EN 60950, IEC 950, and 73/23/EEC. |
| EMC | FCC Part 15, EN 55022, CSA C108.8, EN 50082-1, AS/NZS 3548, VCCI V-3, and 89/336/EEC. |

APPENDIX B

FE-100TX, FE-100FX, AND FE-100F3 SPECIFICATIONS

The 2H23-50R supports three Fast Ethernet Interface Modules:

- FE-100TX (Section B.1)
- FE-100FX (Section B.2)
- FE-100F3 (Section B.3)

This appendix provides the specifications for these modules.

B.1 FE-100TX

The FE-100TX uses an RJ45 connector supporting Category 5 Unshielded Twisted Pair (UTP) cabling.

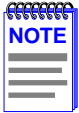

To ensure proper operation, use only Category 5 Unshielded Twisted Pair (UTP) cabling that has an impedance between 85 and 111 ohms.

The slide switch on the FE-100TX determines the crossover status of the cable pairs. If the switch is on the **X** side, the pairs are internally crossed over. If the switch is on the **=** side, the pairs are not internally crossed over. **Figure B-1** shows the pinouts for the FE-100TX in both positions.

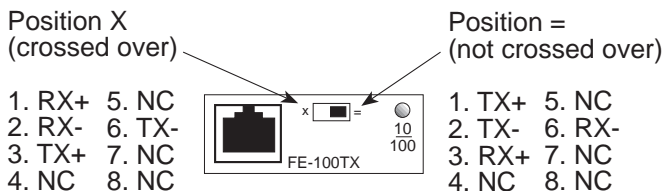

16651_05

Figure B-1 FE-100TX RJ45 Pinouts

B.2 FE-100FX

The FE-100FX shown in **Figure B-2** uses an SC style connector that supports multimode fiber optic cabling. Specifications for the FE-100FX are listed in **Table B-1**, below.

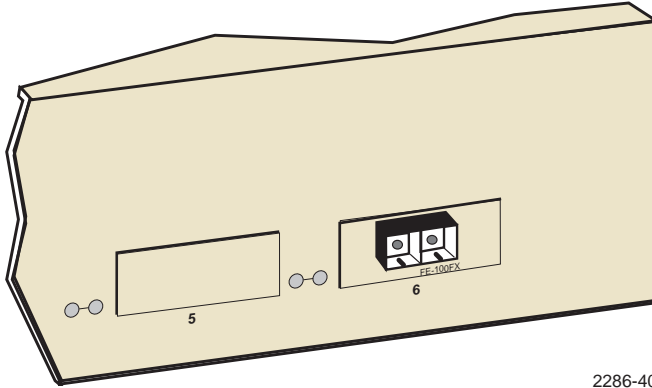
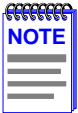

Figure B-2 FE-100FX

Table B-1 Transmitter Power

| Cable Type | Worst Case Budget | Typical Budget |
|------------------------------------|-------------------|----------------|
| 50/125 μm fiber optic | 6.0 dB | 9.0 dB |
| 62.5/125 μm fiber optic | 9.0 dB | 12.0 dB |
| 100/140 μm fiber optic | 15.0 dB | 18.0 dB |



The transmitter power levels and receive sensitivity levels listed are peak power levels after optical overshoot. A peak power meter must be used to correctly compare the values given above to those measured on any particular port. If power levels are being measured with an average power meter, add 3 dB to the measurement to compare the measured values to the values listed above.

B.3 FE-100F3

The FE-100F3 shown in [Figure B-3](#) uses an SC style connector that supports single mode fiber optic cabling. Specifications for the FE-100F3 are listed in [Table B-2](#), below.

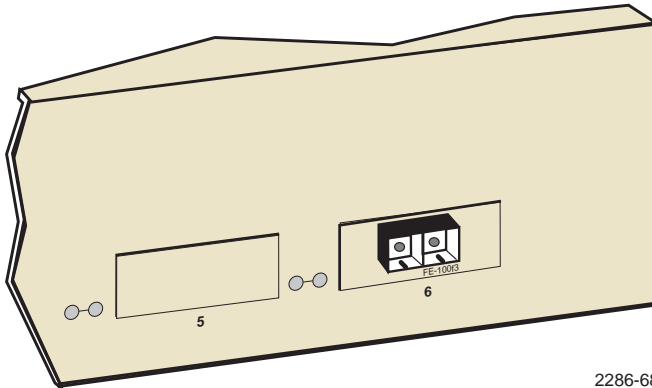

2286-68

Figure B-3 FE-100F3

Table B-2 Transmitter Power

| Cable Type | Worst Case Budget | Typical Budget |
|------------------------------------|-------------------|----------------|
| 8/125 μm fiber optic | >10.0 dB | <10.0 dB |
| 12.5/125 μm fiber optic | >10.0 dB | <10.0 dB |



The transmitter power levels and receive sensitivity levels listed are peak power levels after optical overshoot. A peak power meter must be used to correctly compare the values given above to those measured on any particular port. If power levels are being measured with an average power meter, add 3 dB to the measurement to compare the measured values to the values listed above.

APPENDIX C

OPTIONAL INSTALLATIONS AND MODE SWITCH BANK SETTINGS



ONLY QUALIFIED SERVICE PERSONNEL SHOULD ATTEMPT THE FOLLOWING PROCEDURES.

NUR QUALIFIEZIERTE SERVICE PERSONNALL DIE FOLGENDE PROCEDURE FOLGEN SOLLTEN.

SOLAMENTE PERSONAL CALIFICADO DEBE INTENTAR ESTE PROCEDIMIENTO.

The top cover must be removed to gain access to the mode bank switches and to install the Fast Ethernet Interface Modules and the High Speed Interface Module.

This appendix covers the following items:

- Required tools ([Section C.1](#))
- Removing the chassis cover ([Section C.2](#))
- Locations, functions, and settings for the mode switches ([Section C.2.1](#))
- Installing Optional Fast Ethernet Interface Modules ([Section C.3](#))

C.1 REQUIRED TOOLS

You need the following tools to perform the procedures provided in this appendix:

- Antistatic wrist strap
- Phillips screwdriver

C.2 REMOVING THE CHASSIS COVER

This section describes how to remove the 2H23-50R/2H33-37R chassis cover.



DO NOT REMOVE THE COVER FROM THE 2H23-50R/2H33-37R WHILE POWER IS APPLIED TO THE UNIT. HAZARDOUS VOLTAGES ARE PRESENT AND COULD CAUSE PERSONAL INJURY AND/OR DAMAGE THE UNIT.

DO NOT POWER UP THE 2H23-50R/2H33-37R AGAIN UNTIL THE COVER AND SCREWS ARE IN PLACE.

DECKEL VON DAS 2H23-50R/2H33-37R NICHT ABZIEHEN UNTER SPANNUNG. GEFAHR FÜR DAS PERSONNAL UND/ODER DAS GERÄT WEGEN GEFÄHRLICHE SPANNUNGEN ENSTEHT.

2H23-50R/2H33-37R NICHEINSCHALTEN SO LANG DER DECKEL UND SCHRAUBEN NICHT EINGEBAUT SIND.

NO DEBE DE REMOVER LA TAPA DURENTE QUE ESTE CONELTADO A LA CORRIENTE, UNA DESCARGA ELECTRICA LE PUEDE CAUSAR Y PROBOCARLE DAÑOS, AL IGUAL QUE AL APARATO.

NO ENCHUFE A LA CORRIENTE HASTA QUE LA TAPA Y LOS TORNILLOS ESTEN EN SU LUGAR.



CAUTION: THIS UNIT MAY HAVE MORE THAN ONE POWER SUPPLY CORD. DISCONNECT TWO POWER SUPPLY CORDS BEFORE SERVICING TO AVOID ELECTRIC SHOCK.

VORSICHT: DIESES GERÄT HAT MEHR ALS EINEN NETZANSCHLUß. TRENNEN SIE VOR WARTUNGSARBEITEN DIE 2 NET ZANSCHLÜSSE VOM NETZ, UM ELEKTRISCHE SCHLÄGE ZU VERMEIDEN.

ATTENTION: CET APPAREIL COMPORTE PLUS D'UN CORDON D'ALIMENTATION. RAFIN DE PREVENIR LES CHOCS ELECTRIQUES, DEGRANCHER LES DEUX CORDONS D'ALIMENTATION AVANT DE FAIRE LE DEPANNAGE.

To remove the chassis cover, proceed as follows:

1. Disconnect the 2H23-50R or 2H33-37R from the network as follows:
 - a. Unplug both power cords from the rear of the chassis.



TURN OFF THE 2H23-50R/2H33-37R BY UNPLUGGING THE POWER CORD FROM THE REAR OF THE CHASSIS.

AM HINTEN DES 2H23-50R/2H33-37R STECHEI ABZIEHEN UM AUS ZU SCHALTEN.

APAGUE EL 2H23-50R/2H33-37R DESENCHUFE EL CABLE DE LA UNIDAD.



Before performing step b, mark the cables connected to the 2H23-50R according to their associated port numbers. This is recommended for ease of reinstallation.

- b. Disconnect all network cables attached to the device.
2. If the device is rack mounted, remove it from the rack and remove the rackmount brackets (refer to **Chapter 3, Optional Installations and Mode Switch Bank Settings**).

3. Use a Phillips screwdriver to remove the screws attaching the cover to the chassis. (See **Figure C-1**.)
4. Remove the cover by sliding it back until it clears the front of the chassis and then lifting it straight up and off the chassis.

To reinstall the chassis cover, perform the removal procedures in reverse.

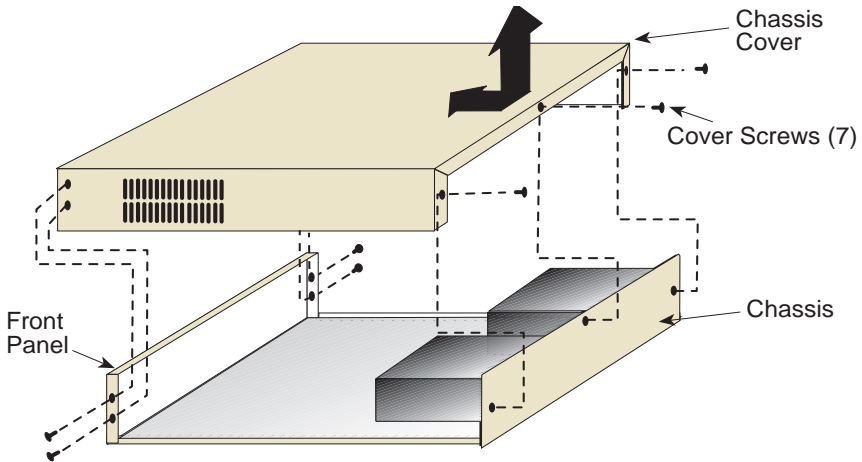

Note: If the device was rack mounted, the four screws fastening the cover to the front panel are removed and installed along with the rackmount brackets.

2286-3

Figure C-1 Removing the Chassis Cover

C.2.1 Setting the Mode Switches

Figure C-2 shows the location of the mode switches and the switch settings for normal operation. These switches are set at the factory and do not need to be changed.

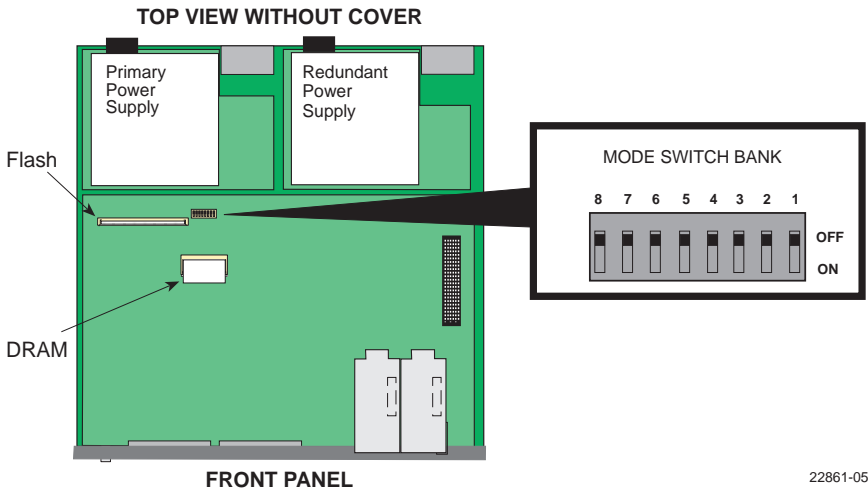

22861-05

Figure C-2 Mode Switch Location/Component Layout

Switch definitions and positions are as follows:

- Switches 1 through 4 – For Cabletron Systems use only.
- Switch 5 – COM Port Autobaud. The default (OFF) position enables Autobaud sensing on the COM port for Local Management sessions. Changing the switch to the ON position disables Autobaud sensing and sets the COM port to 9600 baud for Local Management sessions.
- Switch 6 – Forced BootP. Do NOT attempt a Forced BootP unless a BootP server has been configured for the 2H23-50R or 2H33-37R. The BootP server references the location of a station acting as a Trivial File Transfer Protocol (TFTP) server containing the image file. When the position of Switch 6 is changed and the power is cycled to the device, the device requests the image file location from the BootP server and uses TFTP to download the image from the TFTP server. If one of these requirements is not met, the device continues to request either the BootP server or the TFTP server until the RESET button on the device is pressed. Once the RESET button is pressed, the device resets after one minute and loads the image stored in FLASH memory.

- Switch 7 – Clear NVRAM. Changing the position of this switch resets NVRAM on the next power-up. All user-entered parameters, such as the IP address, device names, etc., are reset to the factory default settings. Once the device resets, you can either use the factory default settings or reenter your own parameters.
- Switch 8 – Reset Password/Community names. Changing the position of this switch clears user-entered passwords stored in NVRAM, and restores the factory default passwords on the next power-up. Once the device resets, you can either use the factory default settings or reenter your own passwords.

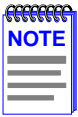

Do not change the position of switch 8 unless it is necessary to reset the module super-user configured passwords to their factory default settings.

C.3 INSTALLING OPTIONAL FAST ETHERNET INTERFACE MODULES

Figure C-3 shows the locations of the Fast Ethernet Interface Module connectors for ports 5 and 6 on the 2H23-50R, and the High Speed Interface Module on the 2H33-37R.

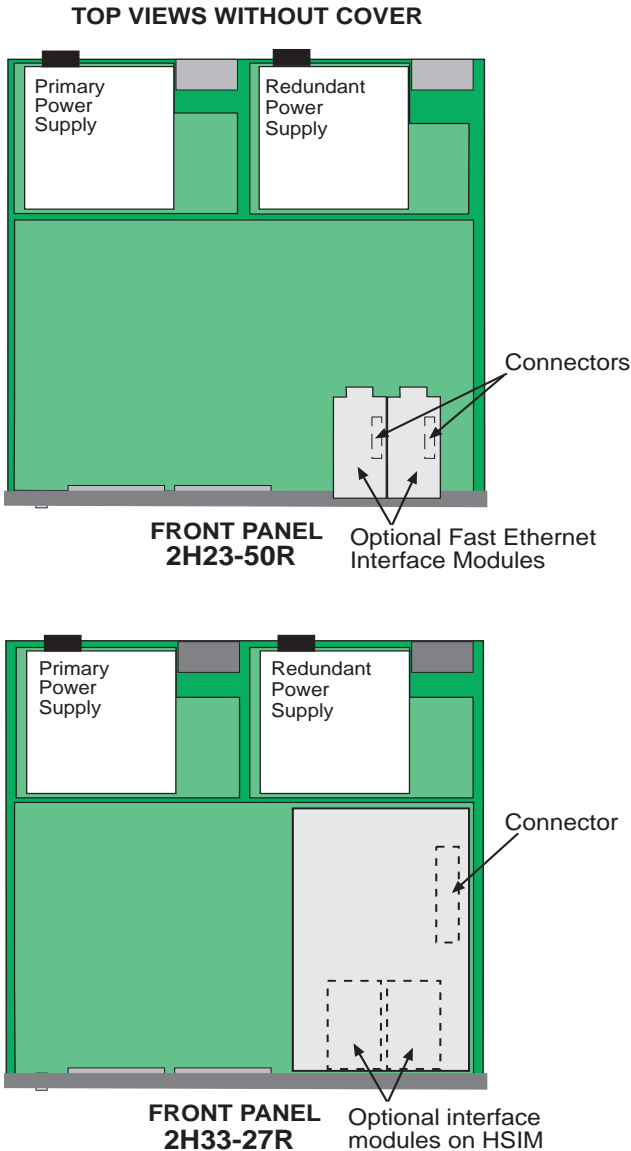

22861-11

Figure C-3 Fast Ethernet Interface Module Connector Location

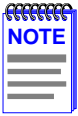

The installation instructions for the High Speed Interface Modules are in the associated user's guide.

To install a Fast Ethernet Interface Module in port slot 5 or 6 of the 2H23-50R, proceed as follows:



The FE-100F3 uses Class 1 lasers. Do not use optical instruments to view the laser output. The use of optical instruments to view laser output increases eye hazard. When viewing the output optical port, power must be removed from the network adapter.



The Fast Ethernet Interface Module and the 2H23-50R are sensitive to static discharges. Use an antistatic wrist strap and observe all static precautions during this procedure. Failure to do so could damage the module or the 2H23-50R.



When installing Fast Ethernet Interface Modules in both port slots 5 and 6, remove the coverplates from both slot openings. In the following instructions, the optional module is shown being installed in port slot 6.

1. Remove the coverplate from the port slot where the Fast Ethernet Interface Module is to be installed. Refer to [Figure C-4](#) and proceed as follows:
 - a. Remove the two screws fastening the coverplate to the standoffs. Save the screws.
 - b. Lift and remove the coverplate from the top of the front standoffs.

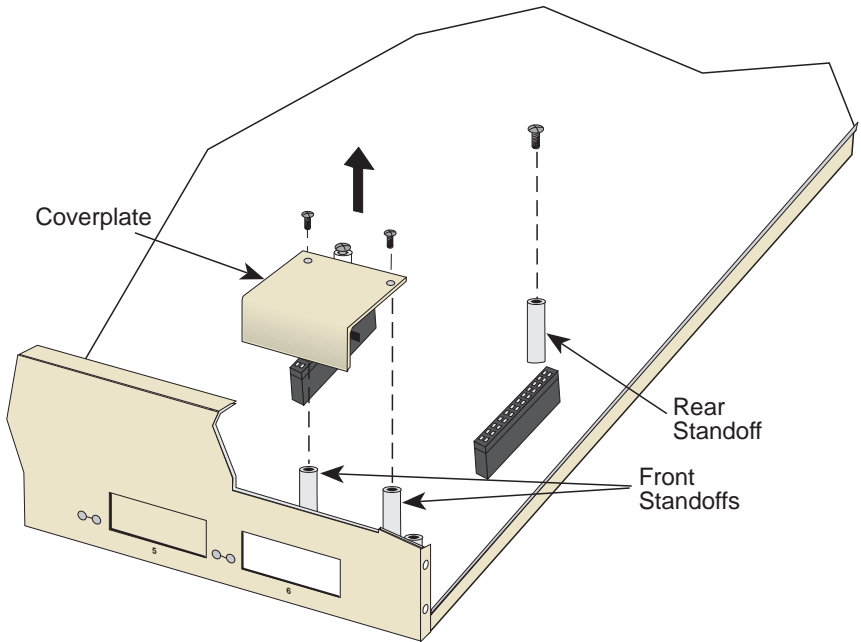

2286-38

Figure C-4 Coverplate Removal

2. Remove the screw from the rear standoff. Save the screw.



When installing an FE-100FX or FE-100F3 module into the 2H23-50R, remove the rubber plug on the module before proceeding.

3. See [Figure C-5](#). Gently pull the faceplate of the 2H23-50R forward to allow room for the Fast Ethernet Interface Modules to be aligned over the connector.



In the following step, take care when inserting the Fast Ethernet Interface Module into the Motherboard connector, so that the pins do not bend. Otherwise, the Fast Ethernet Interface Board and the Motherboard could be damaged.

- Carefully lower the Fast Ethernet Interface Module onto the standoffs while inserting the module connector into the associated motherboard connector.

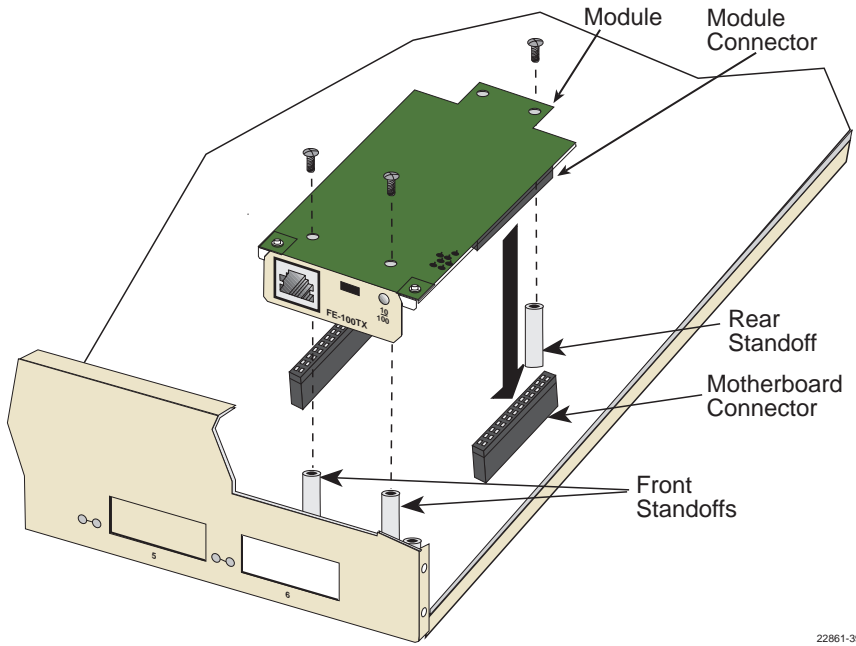

Figure C-5 Installing the Fast Ethernet Interface Module

- Press down firmly on the Fast Ethernet Interface Module until the pins slide all the way into the motherboard connector. Ensure that the Fast Ethernet Interface Module seats flush on the standoffs.
- Secure the Fast Ethernet Interface Module with the screws saved in steps 1 and 2.
- Reinstall the cover.

INDEX

Numerics

- 10BASE-T
 - connection 3-9
 - length 2-2
 - requirements 2-1
- 2H23-50R and 2H33-37R
 - front panel 1-2
- 802.1D switching
 - setting operational mode for 5-26
- 802.1Q switching
 - setting operational mode for 5-26

A

- Access policy 5-34
- Age time 5-40
- Auto-Negotiation 1-4

B

- Broadcast Suppression screen 5-61
 - peak rate 5-62
 - port # 5-62
 - reset peak 5-62
 - threshold 5-62
 - time since peak 5-62
 - total RX 5-62
- Built-in Commands
 - use of 5-97

C

- Cable specifications
 - 100BASE-FX MMF 2-2
 - 100BASE-T network 2-1
 - 100BASE-TX network 2-2
- Chassis cover, removal of C-2
- CLEAR 5-95
- COM port 5-28
 - configuration of 5-28
 - pin assignments A-3
- COM Port Application 5-30
- Command set 5-97
- Connecting to the network 3-8

- Crossover switch B-1

D

- Default gateway 5-18, 5-23
- Device Configuration Menu
 - screen 5-15
- Device date 5-18
- Device Level Security Configuration
 - screen 5-71
 - action on intruder 5-74
 - connector 5-72
 - security state 5-73
- Device Menu screen 5-13
- Device Specific Configuration Menu
 - screen 5-43
- Device Statistics Menu screen 5-79
- Device time 5-18
- Document conventions 1-9

E

- Environmental requirements A-2

F

- FE-100F3
 - transmitter specifications B-3
- FE-100FX
 - transmitter specifications B-2
- FE-100TX
 - RJ45 Pinouts B-1
- Fiber connection
 - SC to SC 3-13
- Flash Download screen 5-52
 - download file name 5-54
 - download method 5-53
 - download serverIP 5-54
 - last image file name 5-54
 - last image serverIP 5-54
 - reboot after download 5-54
 - TFTP gateway IP addr 5-54
- Fragmentation 5-20

G

- General Configuration screen 5-17
 - application 5-20
 - clear NVRAM 5-20
 - com 5-20
 - default gateway 5-18, 5-23
 - device date 5-18
 - device time 5-18, 5-19, 5-24, 5-25
 - IP address 5-18, 5-21
 - IP fragmentation 5-20
 - MAC address 5-17
 - Operational Mode 5-19
 - screen lockout time 5-19, 5-26
 - screen refresh time 5-18, 5-25
 - subnet mask 5-18, 5-22
- Getting Help 1-10

H

- High Speed Configuration Interface screen 5-47
- High Speed Interface screen
 - advertised ability 5-50
 - configuring an FE-100FX or FE-100F3 5-50
 - configuring an FE-100TX 5-51
 - current operational mode 5-49
 - desired operational mode 5-49
 - link status 5-48
 - port type 5-48
 - setting the FE-100FX 5-50
 - setting the FE-100TX 5-51

I

- Installation
 - connecting to the network 3-8
 - Fast Ethernet Interface Module C-7
- Interface Statistics Screen
 - admin status 5-85
 - CLEAR COUNTERS 5-86
 - duplex mode 5-86
 - InDiscards 5-84
 - InErrors 5-84
 - InNonUnicast 5-84

- InOctets 5-84
- interface 5-84, 5-86
- InUnicast 5-84
- InUnknownProtos 5-84
- last change 5-85
- link status 5-86
- MTU 5-86
- name 5-84
- oper status 5-85
- OutDiscards 5-85
- OutErrors 5-85
- OutNonUnicast 5-85
- OutOctets 5-85
- OutQLen 5-85
- OutUnicast 5-85
- speed 5-86
- Interface Statistics screen
 - address 5-85
- IP address 5-18, 5-21
- IP Fragmentation 5-20
 - enabling/disabling of 5-32

K

- Keyboard conventions 5-2

L

- LANVIEW LEDs 4-1
- Local Management
 - exiting from 5-11
 - introduction to 1-6
 - Password screen 5-8
- Local Management screens
 - selection of 5-11

M

- Management
 - use of 1-6
- Management Terminal
 - COM port connection of 5-3, 5-4
 - setup of 5-3, 5-5
- Mode Switch
 - setting C-4

N

Port Redirect Function screen

destination port 5-59

source port 5-59

Network connection

FE-100FX/FE-100F3 3-13

FX-100TX 3-10

Network Connections 3-8

Network Tools

built-in commands 5-97

arp 5-98

atm_stp_state 5-106

bridge 5-99

defroute 5-100

netstat 5-100

ping 5-101

reset 5-102

show 5-102

soft_reset 5-104

telnet 5-104

traceroute 5-103

description of 5-96

special commands 5-97

done 5-107

exit 5-107

quit 5-107

Network Tools screen

accessing of 5-96

NVRAM

clearing of 5-30

O

Operational Mode 5-26

Operational Mode, setting of 5-26

P

Password screen 5-8

Passwords 5-33

Physical properties A-1

Port Level Security Configuration

screen 5-75

action on intruder 5-77

address 5-78

connector # 5-78

network 5-76

port 5-76

security state 5-77

Port Operating Mode

setting of 5-69

Port Redirect Function screen

destination port 5-58

errors 5-59

remap errors 5-59

source port

5-58

status 5-59

Ports

enabling/disabling all ports on a

connector 5-71

enabling/disabling one or

more 5-70

setting all to same operating

mode 5-70

R

Regulatory Compliance A-3

Related manuals 1-11

Repeater Configuration Menu

screen 5-65

Repeater Port Configuration

screen 5-66

connector # 5-69

current oper. 5-68

link stat. 5-68

mode desired oper. 5-68

mode port stat. 5-69

network # 5-68

port # 5-67

set all ports 5-69

Repeater Statistics screen

administration status 5-95

alignment errors 5-94

broadcasts transmitted/

received 5-94

bytes received 5-93

CLEAR COUNTERS 5-95

- collisions 5-94
- CRC errors 5-94
- frames received 5-93
- link status 5-94
- multicasts transmitted/
received 5-94
- NETWORK # 5-95
- network # 5-92
- OOW collisions 5-94
- oversize packets 5-94
- PORT # 5-95
- port # 5-93
- total errors 5-94
- undersize packets 5-94
- RESET button 4-8
- RMON Statistics screen
 - 1024 – 1518 octets 5-91
 - 128 – 255 octets 5-90
 - 256 – 511 octets 5-90
 - 512 – 1023 octets 5-91
 - 64 octets 5-90
 - 65 – 127 5-90
 - 65 – 127 octets 5-90
 - broadcast pkts 5-89
 - CLEAR COUNTERS 5-91
 - collisions 5-89
 - CRC align errors 5-89
 - data source 5-88
 - drop events 5-89
 - fragments 5-90
 - index 5-91
 - jabbers 5-90
 - multicasts 5-89
 - oversize packets 5-89
 - owner 5-88
 - RMON index 5-88
 - status 5-88
 - total octets 5-90
 - total packets 5-90
 - undersize packets 5-89
- Runtime IP address discovery 1-5

S

- Safety information
 - laser iv
- Screen lockout time 5-26
- Screen refresh time 5-25
- Screens
 - Broadcast Suppression screen 5-61
 - Device Configuration Menu screen 5-15
 - Device Level Security Configuration screen 5-71
 - Device Menu screen 5-13
 - Device Specific Configuration Menu screen 5-43
 - Device Statistics Menu screen 5-79
 - exiting from 5-11
 - FLASH Download screen 5-52
 - General Configuration screen 5-17
 - hierarchy of 5-9
 - High Speed Interface Configuration screen 5-47
 - Interface Statistics screen 5-83
 - Network Tools screen 5-96
 - Password screen 5-8
 - Port Level Security Configuration screen 5-75
 - Port Redirect Function screen 5-57
 - Repeater Configuration Menu screen 5-65
 - Repeater Port Configuration screen 5-66
 - Repeater Statistics screen 5-92
 - RMON Statistics screen 5-87
 - selection of 5-11
 - SNMP Community Names screen 5-33
 - SNMP Traps screen 5-36
 - Switch Configuration screen 5-38
 - Switch Statistics screen 5-81
 - System Resources screen 5-45
 - VLAN Main Menu screen 5-64
- SecureFast VLAN
 - setting operational mode for 5-26

- Security
 - setting at the device level 5-74
 - setting at the port level 5-78
 - Setup of
 - management terminal 5-5
 - SmartTrunk
 - introduction to 1-5
 - SNMP Community Names
 - setting of 5-33
 - SNMP Community Names screen
 - access policy 5-34
 - community name 5-34
 - SNMP Traps screen 5-36
 - enable traps 5-37
 - trap community name 5-36
 - trap destination 5-36
 - trap table configuration 5-37
 - Spanning Tree Algorithm 5-40
 - Special commands
 - use of 5-97
 - Special Commands, Network Tools 5-107
 - Specifications A-1
 - Standards compatibility 1-7
 - Subnet mask 5-18, 5-22
 - Switch address 5-39
 - Switch Configuration screen 5-38
 - age time 5-40, 5-42
 - MAC address 5-41
 - number of ports 5-39
 - port # 5-40
 - port status 5-42
 - selecting the STA 5-42
 - state 5-41
 - status 5-41
 - switch address 5-39
 - type of STA 5-40
 - Switch Statistics screen 5-81
 - clearing counters 5-83
 - frames fltrd 5-82
 - frames frwrded 5-82
 - frames rcvd 5-82
 - frames txmtd 5-82
 - interface # 5-82
 - System Resources screen
 - CPU type 5-46
 - current switch utilization 5-46
 - DRAM installed 5-46
 - FLASH memory installed 5-46
 - NVRAM installed 5-46
 - peak switch utilization 5-46
 - reset peak switch utilization 5-46
- T**
- Technical Support. *See* Getting Help 1-10
 - Telnet connections 5-6
 - TFTP gateway IP addr 5-54
 - Trap table configuration 5-37
 - Traps
 - enable 5-37
 - Troubleshooting 4-1
 - checklist 4-7
- U**
- Uninterruptible Power Supply
 - COM configuration for 5-7
 - connection of 5-7
 - Unpacking 3-2
- V**
- VLAN
 - configuration of 5-44
 - VLAN Main Menu screen 5-64

Free Manuals Download Website

<http://myh66.com>

<http://usermanuals.us>

<http://www.somanuals.com>

<http://www.4manuals.cc>

<http://www.manual-lib.com>

<http://www.404manual.com>

<http://www.luxmanual.com>

<http://aubethermostatmanual.com>

Golf course search by state

<http://golfingnear.com>

Email search by domain

<http://emailbydomain.com>

Auto manuals search

<http://auto.somanuals.com>

TV manuals search

<http://tv.somanuals.com>