

## Contents

Introduction .....	2
Before connecting.....	2
Limited warranty.....	3
Safety precautions .....	3
Important safety instructions .....	4
Rear panel connections.....	5
Front panel controls.....	6
Remote control.....	7
Front panel display.....	8
Loudspeaker connections .....	8
Analog audio connections .....	9
Digital audio connections .....	9
Aerial connections.....	9
Front Input connections.....	9
Video connections .....	10
HDMI connections .....	10
5.1 Direct In. ....	11
<b>340R setup .....</b>	<b>12</b>
1. Speaker configuration .....	12
2. Speaker delay .....	13
3. Level calibration.....	13
4. Source setup .....	14
5. Assigning video sources .....	14
Surround sound modes.....	15
Operating instructions .....	16-18
Decode modes.....	17
Audio split mode.....	19
Bass/Treble configuration.....	19
Subwoofer setup.....	19
Advanced bass management .....	19
OSD setup .....	20
Custom installation use .....	20
Reset/Back-up memory .....	20
Troubleshooting .....	21
Technical Specifications .....	21

Visit [www.cambridge-audio.com](http://www.cambridge-audio.com) and register to receive notification of future hardware and software releases.

This guide is designed to make installing and using this product as easy as possible. Information in this document has been carefully checked for accuracy at the time of printing; however, Cambridge Audio's policy is one of continuous improvement, therefore design and specifications are subject to change without prior notice. If you notice any errors please feel free to email us at: [support@cambridgeaudio.com](mailto:support@cambridgeaudio.com)

This document contains proprietary information protected by copyright. All rights are reserved. No part of this manual may be reproduced by any mechanical, electronic or other means, in any form, without prior written permission of the manufacturer. All trademarks and registered trademarks are the property of their respective owners.

© Copyright Cambridge Audio Ltd 2007

"Dolby", "Pro Logic" and the double-D symbol are trademarks of Dolby Laboratories.

"DTS", "DTS Digital Surround" are trademarks of Digital Theater Systems, Inc.

HDMI, the HDMI logo and High-Definition Multimedia Interface are trademarks or registered trademarks of HDMI Licensing LLC.

## Introduction

**Thank you for purchasing this Cambridge Audio Azur range AV Receiver. We hope that you enjoy many years of pleasure from it.**

The 340R is designed for excellent multi-channel surround-sound performance without compromising on music reproduction. As such the five fully discrete audiophile grade amplifiers are kept as separate as possible from the processing and input stages. A large power supply with low flux toroidal transformer and careful design of the audio stages ensure that the 340R can reproduce the dynamics and scale required for modern movie soundtracks whilst also being able to reproduce a genuinely musical performance with either stereo or multi-channel music sources.

Dolby, DTS and Pro Logic II decoding are featured for surround-sound decoding as well as Stereo and Stereo + Sub modes. Support for progressive scan Component video and HDMI allow use with the latest HD/HD ready video sources and TV's. All video inputs are fully freely assignable to any source, making the unit very flexible despite its relatively small size and socket count.

An Advanced Bass Management feature allows separate crossovers and trims for PLII, DD/DTS and Stereo + Sub modes.

Full RS232 control and IR Emitter In make it easy to integrate the 340R into a Custom Install situation if required.

Your 340R can only be as good as the system it is connected to. Please do not compromise on your partnering equipment. Naturally we particularly recommend equipment from the Cambridge Audio Azur range which includes CD and DVD players which have been designed to the same exacting standards as this product. Your dealer can also supply excellent quality Cambridge Audio interconnects to ensure your system realises its full potential.

Thank you for taking the time to read this manual, we do recommend you keep it for future reference.

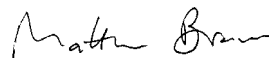

Matthew Bramble,  
Cambridge Audio Technical Director  
and the AV Receiver design team

## Before connecting

The process of setting up the 340R is first to make all the connections to your speakers and source equipment and then set the unit up via its On-Screen Display (OSD), as there are various settings and adjustments that need to be made before the 340R can be used.

**However before you actually decide which connections to make or perform any adjustments it is strongly advised that you read through the '340R setup' section of this manual first, starting on page 12.**

A lot of explanation is included that will help you to choose the right connection types for both your sources and TV.

## Limited warranty

Cambridge Audio warrants this product to be free from defects in materials and workmanship (subject to the terms set forth below). Cambridge Audio will repair or replace (at Cambridge Audio's option) this product or any defective parts in this product. Warranty periods may vary from country to country. If in doubt consult your dealer and ensure that you retain proof of purchase.

To obtain warranty service, please contact the Cambridge Audio authorised dealer from which you purchased this product. If your dealer is not equipped to perform the repair of your Cambridge Audio product, it can be returned by your dealer to Cambridge Audio or an authorised Cambridge Audio service agent. You will need to ship this product in either its original packaging or packaging affording an equal degree of protection.

Proof of purchase in the form of a bill of sale or receipted invoice, which is evidence that this product is within the warranty period, must be presented to obtain warranty service.

This Warranty is invalid if (a) the factory-applied serial number has been altered or removed from this product or (b) this product was not purchased from a Cambridge Audio authorised dealer. You may call Cambridge Audio or your local country Cambridge Audio distributor to confirm that you have an unaltered serial number and/or you purchased from a Cambridge Audio authorised dealer.

This Warranty does not cover cosmetic damage or damage due to acts of God, accident, misuse, abuse, negligence, commercial use, or modification of, or to any part of, the product. This Warranty does not cover damage due to improper operation, maintenance or installation, or attempted repair by anyone other than Cambridge Audio or a Cambridge Audio dealer, or authorised service agent which is authorised to do Cambridge Audio warranty work. Any unauthorised repairs will void this Warranty. This Warranty does not cover products sold AS IS or WITH ALL FAULTS.

REPAIRS OR REPLACEMENTS AS PROVIDED UNDER THIS WARRANTY ARE THE EXCLUSIVE REMEDY OF THE CONSUMER. CAMBRIDGE AUDIO SHALL NOT BE LIABLE FOR ANY INCIDENTAL OR CONSEQUENTIAL DAMAGES FOR BREACH OF ANY EXPRESS OR IMPLIED WARRANTY IN THIS PRODUCT. EXCEPT TO THE EXTENT PROHIBITED BY LAW, THIS WARRANTY IS EXCLUSIVE AND IN LIEU OF ALL OTHER EXPRESS AND IMPLIED WARRANTIES WHATSOEVER INCLUDING, BUT NOT LIMITED TO, THE WARRANTY OF MERCHANTABILITY AND FITNESS FOR A PRACTICAL PURPOSE.

Some countries and US states do not allow the exclusion or limitation of incidental or consequential damages or implied warranties so the above exclusions may not apply to you. This Warranty gives you specific legal rights, and you may have other statutory rights, which vary from state to state or country to country.

### Plug Fitting Instructions (UK Only)

The cord supplied with this appliance is factory fitted with a UK mains plug fitted with a 5 amp fuse inside. If it is necessary to change the fuse, it is important that a 5 amp one is used. If the plug needs to be changed because it is not suitable for your socket, or becomes damaged, it should be cut off and an appropriate plug fitted following the wiring instructions below. The plug must then be disposed of safely, as insertion into a mains socket is likely to cause an electrical hazard. Should it be necessary to fit a 3-pin BS mains plug to the power cord the wires should be fitted as shown in this diagram. The colours of the wires in the mains lead of this appliance may not correspond with the coloured markings identifying the terminals in your plug. Connect them as follows:

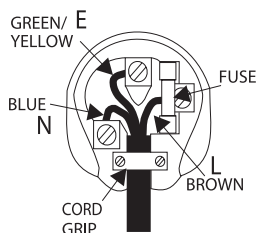

The wire which is coloured BLUE must be connected to the terminal which is marked with the letter 'N' or coloured BLACK.

The wire which is coloured BROWN must be connected to the terminal which is marked with the letter 'L' or coloured RED.

The wire which is coloured GREEN/YELLOW must be connected to the terminal which is marked with the letter 'E' or coloured GREEN.

If your model does not have an earth wire, then disregard this instruction.

If a standard 13 amp (BS 1363) plug is used, a 5 amp fuse must be fitted, or if any other type of plug is used a 5 amp fuse must be fitted, either in the plug or adaptor, or on the distribution board.

## Safety precautions

### Checking the Power Supply Rating

For your own safety please read the following instructions carefully before attempting to connect this unit to the mains.

Check that the rear of your unit indicates the correct supply voltage. If your mains supply voltage is different, consult your dealer.

This unit is designed to operate only on the supply voltage and type that is indicated on the rear panel of the unit. Connecting to other power sources may damage the unit.

This equipment must be switched off when not in use and must not be used unless correctly earthed. To reduce the risk of electric shock, do not remove the unit's cover (or back). There are no user serviceable parts inside. Refer servicing to qualified service personnel. If the power cord is fitted with a moulded mains plug the unit must not be used if the terminal fuse carrier is not in place. Should you lose the fuse carrier the correct part must be reordered from your Cambridge Audio dealer.

 The symbol on this product indicates that it is of CLASS II (double insulated) construction.

The lightning flash with the arrowhead symbol within an equilateral triangle is intended to alert the user to the presence of un-insulated 'dangerous voltage' within the product's enclosure that may be of sufficient magnitude to constitute a risk of electric shock to persons. 

 The exclamation point within an equilateral triangle is intended to alert the user to the presence of important operating and maintenance instructions in the service literature relevant to this appliance.

The crossed-out wheeled bin is the European Union symbol for indicating separate collection for electrical and electronic equipment. This product contains electrical and electronic equipment which should be reused, recycled or recovered and should not be disposed of with unsorted regular waste. Please return the unit or contact the authorised dealer from whom you purchased this product for more information. 

### Approvals

 This product complies with European Low Voltage (73/23/EEC) and Electromagnetic Compatibility (89/336/EEC) Directives when used and installed according to this instruction manual. For continued compliance only Cambridge Audio accessories should be used with this product and servicing must be referred to qualified service personnel.

**NOTE: THE MANUFACTURER IS NOT RESPONSIBLE FOR ANY RADIO OR TV INTERFERENCE CAUSED BY UNAUTHORIZED MODIFICATIONS TO THIS EQUIPMENT. SUCH MODIFICATIONS COULD VOID THE USER AUTHORITY TO OPERATE THE EQUIPMENT.**

This equipment has been tested and found to comply with the limits for a Class B digital device, pursuant to Part 15 of the FCC Rules. These limits are designed to provide reasonable protection against harmful interference in a residential installation. This equipment generates, uses and can radiate radio frequency energy and, if not installed and used in accordance with the instructions, may cause harmful interference to radio communications. However, there is no guarantee that interference will not occur in a particular installation.

If this equipment does cause harmful interference to radio or television reception, which can be determined by turning the equipment off and on, the user is encouraged to try to correct the interference by one or more of the following measures:

- Re-orient or relocate the receiving antenna.
- Increase the separation between the equipment and receiver.
- Connect the equipment into an outlet on a circuit different from that to which the receiver is connected.
- Consult the dealer or an experienced radio/TV technician for help.

## Important safety instructions

Please take a moment to read these notes before installing your 340R, as they will enable you to get the best performance and prolong the life of the unit. We advise you follow all instructions, heed all warnings and keep the instructions for future reference.

### Ventilation

**IMPORTANT** - The unit will become hot when in use.

Please ensure there is ample ventilation (at least 10cm clearance all round). Do not put any objects on top of this unit. Do not situate it on a rug or other soft surface and do not obstruct any air inlets or outlet grilles. Do not install near any heat sources such as radiators, heat registers, stoves, or other apparatus (including amplifiers) that produce heat. Do not stack multiple units on top of each other. Do not place in an enclosed area such as a bookcase or in a cabinet without sufficient ventilation.

Do not obstruct the rear heat tunnel ventilation grille. Ensure that small objects do not fall through any ventilation grille. If this happens, switch off immediately, disconnect from the mains supply and contact your dealer for advice.

### Positioning

Choose the installation location carefully. Avoid placing it in direct sunlight or close to a source of heat. Also avoid locations subject to vibration and excessive dust, cold or moisture. Do not place the unit on an unstable surface or shelf. The unit may fall, causing serious injury to a child or adult as well as serious damage to the product. Do not place other equipment on top of the unit.

This unit must be installed on a sturdy, level surface. Do not place in a sealed area such as a bookcase or in a cabinet. Any space open at the back (such as a dedicated equipment rack) is fine however. When a cart is used, use caution when moving the cart to avoid injury from tip-over.



**WARNING** - To reduce the risk of fire or electric shock, do not expose this unit to rain or moisture. This unit must not be used near water or exposed to dripping or splashing water or other liquids. No objects filled with liquid, such as vases, shall be placed on the unit. In the event, switch off immediately, disconnect from the mains supply and contact your dealer for advice.

Electronic audio components have a running in period of around a week (if used several hours per day). This will allow the new components to settle down, the sonic properties will improve over this time.

### Grounding and polarisation

Do not defeat the safety purpose of the polarized or grounding type plug. A polarized plug has two blades with one wider than the other. A grounding type plug has two blades and a third grounding prong. The wide blade or third prong are provided for your safety. If the provided plug does not fit your outlet, consult an electrician for replacement of the obsolete outlet.

### Power sources

The unit should be operated only from the type of power source indicated on the marking label. If you are not sure of the type of power supply to your home, consult your product dealer or local Power Company.

This unit has been designed to be left in Standby mode when not in use, this will increase the life of the amplifier (this is true with all electronic equipment). To turn the unit off completely switch off on the rear panel. If you do not intend to use this unit for a long period of time, unplug it from the mains socket.

### Power cord protection

The unit must be installed in a manner that makes disconnection of the mains plug from the mains socket outlet (or appliance connector from the rear of the unit) possible. Where the mains plug is used as the disconnect device, the disconnect device shall remain readily operable. Protect the power cord from being walked on or pinched particularly at plugs, convenience receptacles, and the point where they exit from the unit.

Be sure to insert each power cord securely. To prevent hum and noise, do not bundle the interconnect leads with the power cord or speaker leads.

### Overloading

Do not overload wall outlets or extension cord as this can result in a risk of fire or electric shock. Overloaded AC outlets, extension cords, frayed power cords, damaged or cracked wire insulation, and broken plugs are dangerous. They may result in a shock or fire hazard.

### Lightning

For added protection during a thunderstorm, or when it is left unattended and unused for long period of time, unplug the unit from the wall outlet and disconnect the antenna or cable system. This will prevent damage to the unit from lightning and power-line surges.

### Outdoor antenna grounding

If an outside antenna or cable system is connected to the product, be sure the antenna or cable system is grounded so as to provide some protection against voltage surges and built-up static charges. Section 810 of the National Electrical Code, ANSI/NIPA No. 70-1984 (section 54 of Canadian Electrical Code, Part 1) provides information with respect to proper grounding of the mast and supporting structure, grounding of the lead-in wire to an antenna-discharge unit, size of grounding conductors, location of antenna-discharge unit, connection to grounding electrodes, and requirements for the grounding electrode.

### Cleaning

To clean the unit, wipe its case with a dry, lint-free cloth. Do not use any cleaning fluids containing alcohol, ammonia or abrasives. Do not spray an aerosol at or near the amplifier.

### Attachments

Do not use attachments not recommended by your dealer as they may cause harm to the unit. Only use the specified attachments/accessories with this unit.

### Servicing

These units are not user serviceable, never attempt to repair, disassemble or reconstruct the unit if there seems to be a problem. A serious electric shock could result if this precautionary measure is ignored. In the event of a problem or failure, please contact your dealer.

Contact the service department should any of these conditions occur:

- When the power-supply cord or plug is damaged.
- If liquid has been spilled, or objects have fallen into the amp.
- If the unit has been exposed to rain or water.
- If the unit does not operate normally after following the operation instructions, adjust only those controls that are covered by the operation instructions.
- If the unit has been dropped or damaged in any way.
- When the unit exhibits a distinct negative change in performance.

### IMPORTANT

**If the unit is run at a very high level, a sensor will detect a temperature rise and show "PROTECTION OVERLOAD" on the display. The unit will then go into Standby mode. It cannot be switched on again until the temperature has fallen to a more normal level.**

## Rear panel connections

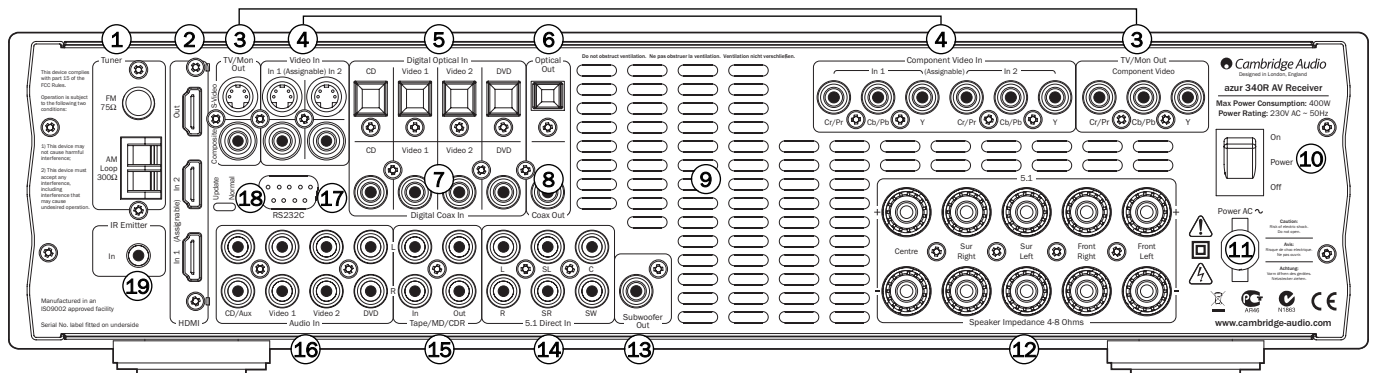

### ① FM/AM antenna

All tuner antenna connections are made here. Refer to the 'Aerial connections' section of this manual for more information.

### ② HDMI

Inputs and output to a suitable TV/Monitor. The HDMI inputs can be assigned in the OSD to the DVD, Video 1, or Video 2 sources (see later section of this manual for more information).

### ③ TV/Mon outputs

**S-Video** - Connect to your television via S-Video cable to display the picture of any S-Video connected unit.

**Composite** - Connect to your television via 75 ohm RCA phono cable to display the picture of any composite video connected unit.

These outputs are also used to view the 340R's on-screen setup menu.

**Component** - Connect to the Cr/Pr, Cb/Pb, & Y terminals of a television set.

**Note:** There is no On-Screen Display setup menu present on the Component Video output.

### ④ Video inputs

**S-Video** - Connect to the S-Video outputs from the source equipment.

**Composite** - Connect to the Composite Video outputs from the source equipment.

**Component** - Connect the Component Video outputs from the source equipment.

**Note:** The preferred connection method for video sources is always HDMI (highest quality) then Component Video then S-Video then Composite Video. HDMI and DVD Component also support Progressive Scan which gives better picture quality if supported by both your DVD player and TV.

### ⑤ Digital Optical Inputs

Connect to the digital optical (Toslink) outputs of source equipment.

### ⑥ Optical Out

Connect to the digital optical (Toslink) input of an external recording device (eg MD/CDR etc) to record from the selected digital audio source.

### ⑦ Digital Coax Inputs

Connect to the digital coaxial (SPDIF) outputs of source equipment.

### ⑧ Coax Out

Connect to the digital coaxial (SPDIF) input of an external recording device (eg MD/CDR etc) to record from the selected digital audio source.

### ⑨ Heat tunnel vent grille

Allows cooling of internal circuitry. **DO NOT OBSTRUCT!**

### ⑩ Power On/Off

Switches the unit on and off.

### ⑪ Mains power lead

Once you have completed all connections, plug the AC power lead into an appropriate mains socket. The AV receiver is now ready for use.

### ⑫ Speaker terminals

Connect to loudspeakers with an impedance of between 4-8 ohms.

### ⑬ Subwoofer Output

Connect to a powered (active) subwoofer.

### ⑭ 5.1 Direct In

Connect to the 5.1 channel output terminals of a DVD player with built-in multi-channel decoding for playing DVD-A or SACD.

### ⑮ Tape/MD/CDR

Connect the Tape Play sockets to the line output terminals of a Tape deck, MD player, CD-R etc. Connect the Tape Rec sockets to the line input terminals of a Tape deck, MD player, CD-R etc.

### ⑯ Audio inputs

Connect to the audio line output terminals of a source device (eg CD, DVD player etc).

### ⑰ RS232C

For use by an installer/dealer for software updates, or for control of the 340R by Custom Install (C.I.) systems.

### ⑱ Update/Normal

**For dealer use only** - Switches the 340R between Normal (default) mode and Software Update mode. Do **not** change the mode to Update or make connections to it in Update mode as damage may result!

### ⑲ IR Emitter In

Allows modulated IR commands from multi-room systems or IR repeater systems to be received by the 340R.

## Front panel controls

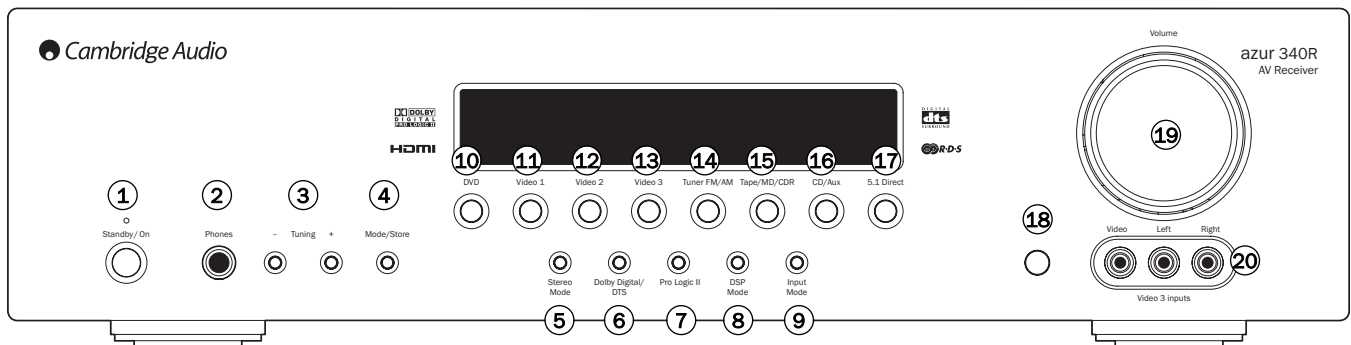

### ① Standby/On

Switches the unit between Standby mode (indicated by dim power LED) and On (indicated by bright power LED). Standby is a low power mode where the power consumption is less than 10 Watts. The unit should be left in Standby mode when not in use.

### ② Phones

Allows for the connection of stereo headphones with a 6.35mm/¼" Jack plug. Headphones with an impedance of between 32 and 600 ohms are recommended.

**Note:** Plugging in headphones will automatically mute the main outputs and select a 2-channel stereo down-mix to be created for headphone use.

### ③ Tuning +/-

Used to tune FM/AM frequencies and skip presets in Tuner mode.

### ④ Mode/Store

Press to cycle between Tuner modes (refer to the 'Operating instructions' section of this manual for more information).

**Note:** The 340R remembers the audio and video input type and processing mode for each individual source input. These are recalled each time a source is selected.

### ⑤ Stereo Modes

Press to listen to a source in either Stereo or Stereo + Sub modes.

### ⑥ Dolby Digital / DTS

Press to select Dolby Digital or DTS surround modes (with suitably encoded digital source material). These modes can only be decoded from digital audio sources (via Coaxial or Optical inputs).

### ⑦ Pro Logic II

Press to select Pro Logic II decoding for matrix encoded analog or digital material or for post-processing DD/DTS material.

**Note:** The 340R is unable to auto-detect this kind of source material as it does not include embedded encoding type flags so manual selection is required.

### ⑧ DSP Mode

The 340R can create a surround sound effect even from non-encoded material by Digital Signal Processing (DSP). Press this button to choose one of the following surround sound effects: THEATER, HALL, MOVIE, MUSIC or ROOM.

### ⑨ Input Mode

Press this button to toggle between analog or optical/coaxial digital input types for the currently selected source. The 340R remembers the input type selected for each source when you return to that source.

### ⑩ DVD

Press to select the DVD source equipment for output through the 340R.

### ⑪ Video 1

Press to select the source equipment connected to Video 1 for output through the 340R.

### ⑫ Video 2

Press to select the source equipment connected to Video 2 for output through the 340R.

### ⑬ Video 3

Press to select a video camera recorder/video games console connected to the Video 3 input sockets.

### ⑭ Tuner FM/AM

Press to select the tuner for output through the 340R. Once in Tuner mode also use this button to switch between FM and AM modes.

### ⑮ Tape/MD/CDR

Press to select the recording device connected to the Tape/MD/CDR input for output through the 340R.

### ⑯ CD/Aux

Press to select the CD or other source equipment connected to CD/Aux on the rear panel for output through the 340R.

### ⑰ 5.1 Direct

Press to select a 5.1 source (DVD-A or SACD player etc) connected to the 5.1 Direct In sockets.

### ⑱ Infrared sensor

Receives IR commands from the supplied Azur remote control. A clear unobstructed line of sight between the remote control and the sensor is required.

### ⑲ Volume

Use to increase/decrease the level of the sound from the outputs of the 340R.

### ⑳ Video 3 input sockets

Allows a video camera recorder/video games console to be connected and selected by the Video 3 source button.

## Remote control

Insert the supplied AAA batteries to activate the supplied remote control. For full details of the various adjustment functions available from the remote, refer to the later sections of this manual.

### On

Press to switch the unit on.

### Standby

Switches the unit into Standby mode. Press the *On* button to exit Standby mode.

### DVD, Video 1, Video 2, Video 3, Tape MD/CDR, CD/Aux

Press the corresponding button to change the input source.

### Tuner FM/AM

Selects Tuner mode. Pressing again to toggle between FM and AM modes.

### PTY (Program Type Search)

Press to search by program type when in Tuner mode. Refer to the 'Operating instructions' section of this manual for more information.

### APS (Auto Program Search)

Hold down for 4 seconds to allocate and memorise radio stations automatically.

### Stereo/Mono

When listening to the FM tuner, press to alternate between stereo and mono modes.

### Store

Press to store the current frequency when in Tuner mode.

### Mode

Press to select Auto/Manual or Preset tuning when in Tuner mode.

### OSD (On-screen Display)

Press to access the on-screen set-up menu when connected to a monitor/screen via composite or S-video connections.

### Display

Press to view the current source material and decoding mode. When listening to FM with RDS, press to cycle round various RDS information modes.

### Volume

Increase or decrease the volume of the AV receiver output. Also used as up/down in the OSD setup menu.

### Tune / Left & Right

Press the right arrow to increase tuner frequency/change preset. Press the left arrow to decrease tuner frequency/change preset. Also used to scroll left/right in the OSD setup menus.

### Enter

Used in the OSD setup menu.

### Bass/Treble

Press for bass/treble adjustment, using the Volume up/down buttons.

### Mute

Mutes the audio on the AV Receiver. Press again to cancel mute.

### Audio Type

Selects between analog or digital audio input for the current source.

### Stereo

For listening in 2-channel stereo.

### Stereo + Sub

2-channel stereo and digitally created subwoofer channel.

### PLII, DD/DTS, DSP Modes

See button details as listed in the 'Front panel controls' section of this manual on the previous page.

### DRC (Dynamic Range Control)

Press to rotate through four dynamic range settings when listening to Dolby Digital/DTS movie soundtracks. Refer to the 'Operating instructions' section of this manual for more information.

### LFE Trim

Press to trim (adjust the level of) the Low Frequency Effects channel using the Volume up/down buttons.

### Sub On/Sub Off

The *Sub On/Off* buttons perform temporary muting of the Subwoofer without affecting the bass management or speaker settings. To make permanent settings to the speaker options including the Subwoofer, use the 'Speaker Config Menu' in the On Screen Display (OSD).

**Note:** Selecting a new decode mode always cancels sub mute.

Also, hold down and then press the volume up and down buttons to adjust the overall sub level if desired.

### 5.1 Direct

Selects the 5.1 Direct input.

The above button descriptions are naturally brief. Please refer to the 'Operating instructions' section of this manual for more information on the relevant functions implemented.

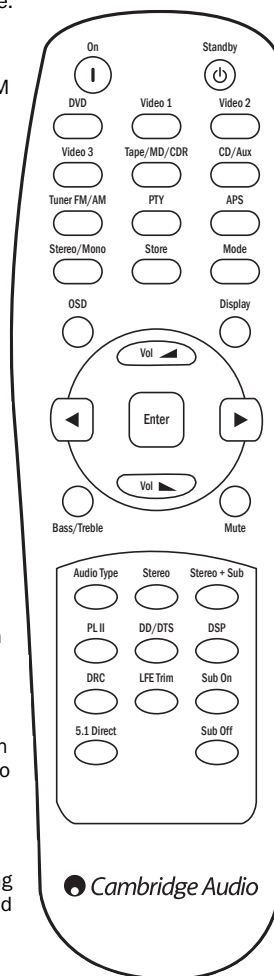

## Front panel display

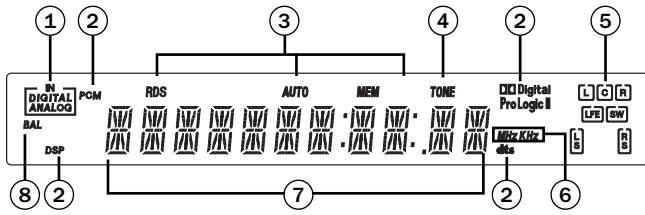

### 1 Digital/Analog indicators

Indicates the current source input type - digital or analog.

### 2 Decoding mode indicators

Shows the current decoding type: Dolby Digital, Pro Logic II or DTS. In conjunction with the Output Channel indicators these give full details of the current processing mode.

### 3 Tuner mode indicators

Shows Memory/Store active, Stereo mode active, AutoScan active and RDS On.

### 4 Tone control indicator

Lights when Bass and Treble controls are active i.e. have been set to anything other than OdB (flat) position.

### 5 Output channel indicators

Shows the currently active channels depending on decoding mode and source material. Icons lit indicate active channels in the source material. Icons with a box around them indicate actual channels being output separately.

### 6 Frequency type

Indicates the tuned frequency in AM or FM Tuner mode.

### 7 Main information display

Shows the current source selected, also the surround mode and station name/frequency when in tuner mode etc.

### 8 Balance indicator

Lights when the Front Left and Right speaker outputs have been set to different levels in the OSD, i.e. a balance adjustment has been made.

## Display examples



- Indicates a 5.1 Dolby Digital source being played back as 5.0 (Sub off). LFE indicates a low frequency effects channel is present in the source material. When this icon isn't boxed it indicates the LFE channel is not being reproduced separately, but is instead being directed to the Left and Front Right speakers.



- Indicates a 2.1 output created in the digital domain from analog input material.

## Loudspeaker connections

To avoid damaging the speakers with a sudden high-level signal, be sure to switch the power off before connecting the speakers. Check the impedance of your speakers. Speakers with an impedance of between 4 and 8 ohms (each) are recommended.

The coloured speaker terminals are positive (+) and the black speaker terminals are negative (-). Make sure correct polarity is maintained at each speaker connector or the sound can become weak and "phasey" with little bass.

Prepare the speaker cords for connection by stripping off approximately 10mm (3/8") or less (no more than 10mm, as this could cause a short-circuit) of the outer insulation. Twist the wire tightly together so there are no loose ends. Unscrew the speaker terminal knob, insert the speaker cable, tighten the knob and secure the cable.

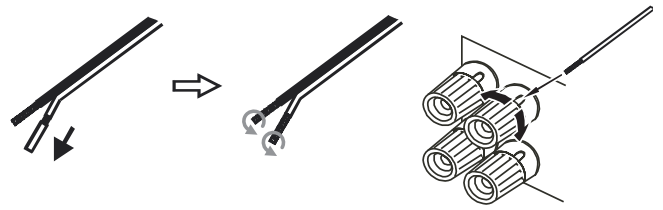

**Note:** All connections are made via loudspeaker cable, except if using an active subwoofer which would be connected via a standard RCA phono cable. Banana Plugs (4mm standard) connected to the speaker cable are recommended for direct insertion into the speaker terminals.

Please refer to the 'Speaker configuration' section of this manual for more information on setting up your speakers.

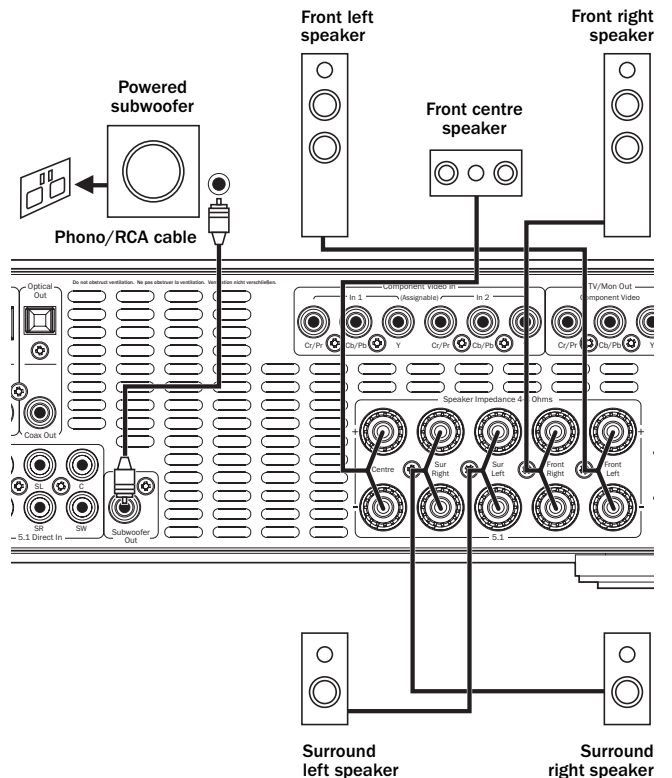



## Analog audio connections

**Note:** Do not plug in the mains power lead or turn the unit on until all connections have been made.

Connect to source equipment using stereo phono cables (stereo 2RCA-2RCA). Tape/MD/CD-R recorder/players require two sets of stereo phono/RCA cables, one for recording, one for listening.

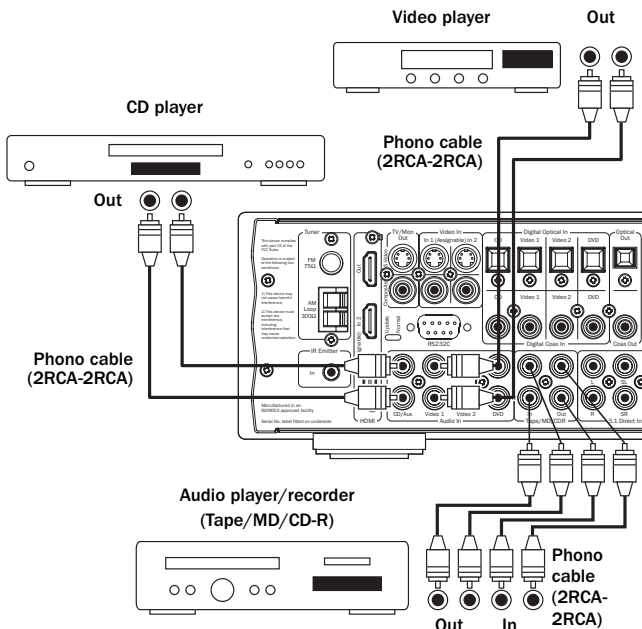

## Aerial connections

### FM aerial

Connect an aerial to the FM 75 ohm socket (a simple wire aerial is supplied only for temporary use). Extend the lead and move the aerial around until you get the best reception. For continued use, we strongly recommended using a 75ohm outdoor FM aerial.

### AM loop aerial

Connect each end of the single length antenna to the antenna terminals. Place the antenna as far from the main system as possible to prevent unwanted noise and to obtain optimum reception. If the AM loop aerial provided does not receive sufficient reception, it may be necessary to use an outdoor AM aerial.

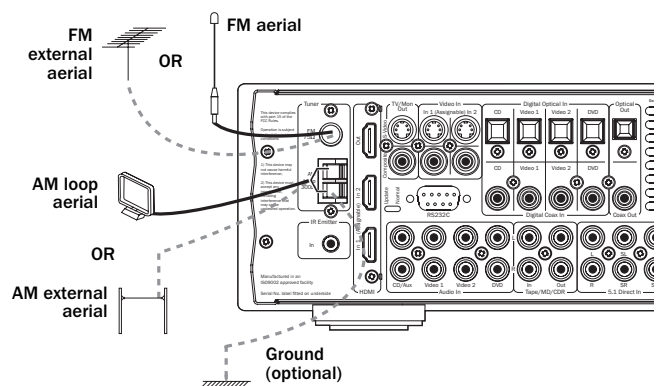

## Digital audio connections

Two types of digital audio connections can be made to the 340R:

1. Optical (Toslink)
2. Coaxial (SPDIF)

Either type can be used for a source as the 340R automatically uses the active one.

**Note:** Only one connection type should be used per source.

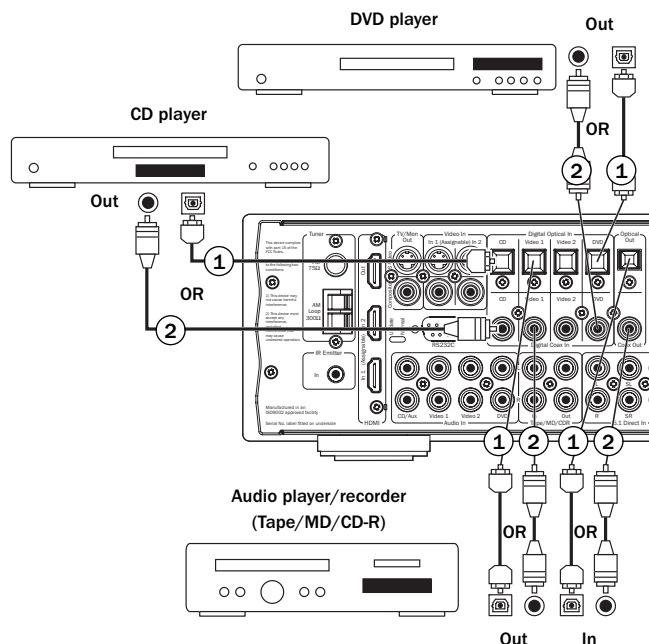

## Front input connections

The front panel Video 3 input is for temporary connections to video games consoles etc.

Remove the cap to access the Video 3 inputs, and connect to a video game console or video camera's outputs using a Composite video cable and stereo phono cable (RCA-RCA).

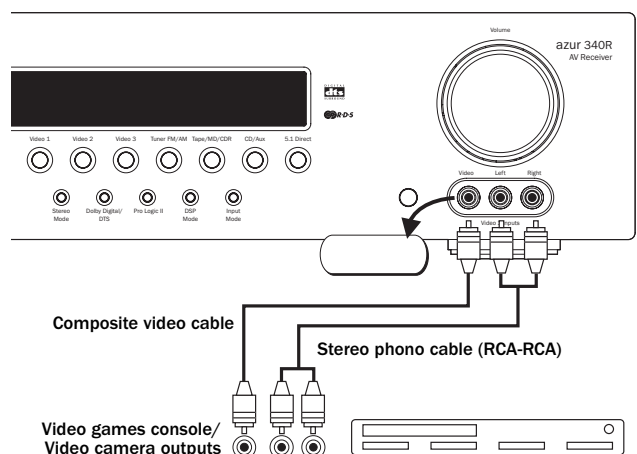

## Video connections

For best picture quality we recommend making a HDMI connection, then in declining order of quality, Component video connections, S-Video connections and then Composite video connections.

To use HDMI (digital connection), see the next section below. For analog video, use one of the following three types of connections:

1. Composite - connect with single 75 ohm video phono cable (RCA-RCA).
2. S-Video - connect with S-Video cable.
3. Component - connect with 75 ohm Component video cables (3RCA-3RCA).

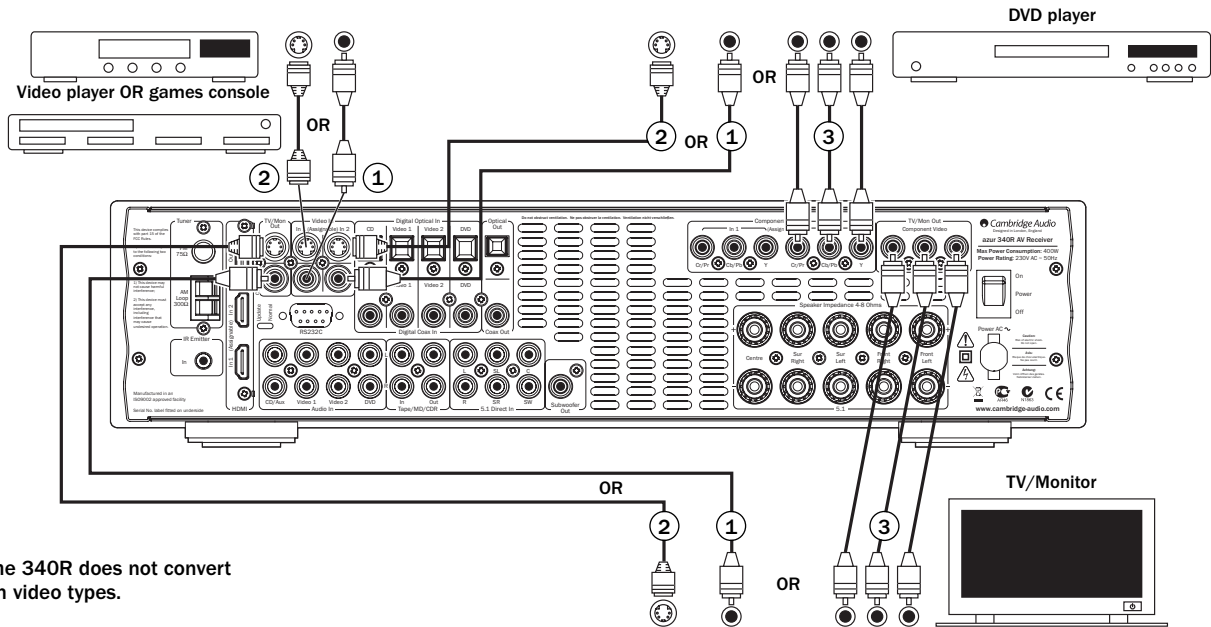

Note: The 340R does not convert between video types.

## HDMI connections

HDMI (High-Definition Multi-Media Interface) is an all digital connection that can carry both audio and video in one cable. Direct digital transfer of video and support for various types of High Definition video content make this the best connection type for picture quality. The two HDMI inputs can be assigned to any one of the DVD, Video 1, Video 2, CD/Aux, Tape/MD and 5.1 Direct inputs (see the 'Assigning HDMI sources' section of this manual for more information).

The 340R routes the HDMI outputs of DVD players, set-top boxes etc to the TV/Monitor without any internal processing. Consult both the source and TV's manuals to find out how to set the best modes for best picture quality. As the 340R only routes/switches HDMI it is not involved in these settings itself.

The sources will also normally supply audio to the TV/Monitor over the HDMI connection, this will be separate from the audio that the 340R decodes.

**In order for the 340R itself to receive audio (including surround-sound) from HDMI (or DVI) sources a Co-axial (SPDIF) or Optical (Toslink) digital audio connection must be made from each source to the 340R.**

DVI switching can be supported simply by using DVI to HDMI adaptors as these two connection types are compatible. When using DVI only video will be passed to the TV/Monitor. Again a Co-axial (SPDIF) or Optical (Toslink) digital audio connection must be made from each source to the 340R for it to be able to receive audio and decode surround sound etc.

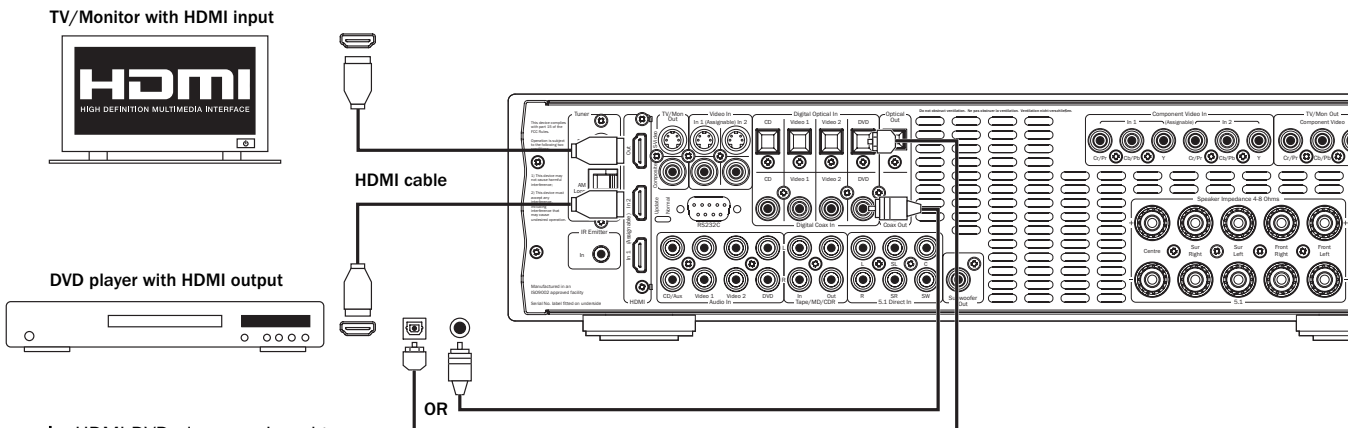

Example: HDMI DVD player assigned to DVD input.

## 5.1 Direct in

DVD-A or SACD players etc can be connected to the 340R via its 5.1 Direct inputs allowing multi-channel music playback from these new sources.

DVD-A and SACD both support 5.1 analog output.

To select the Direct Input press the *5.1 Direct* button on the front panel or remote.

**Note:** These connections are pure analog for best sound quality and no DSP processing or Bass and Treble adjustment by the 340R is possible.

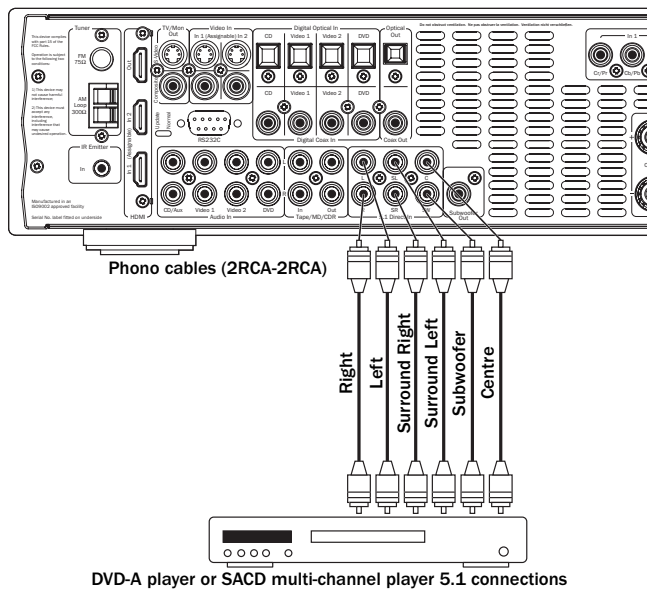

## 340R setup

The setup of the 340R is a 5 stage process as follows:

1. Speaker configuration.
2. Speaker delay
3. Level calibration
4. Source setup (2 settings)
  - Source audio type
  - Source video type
5. Assigning video sources

### 1. Speaker configuration

See below for a typical 5.1 Speaker configuration. Five (5) main speakers are used plus a Subwoofer (the .1) for bass:

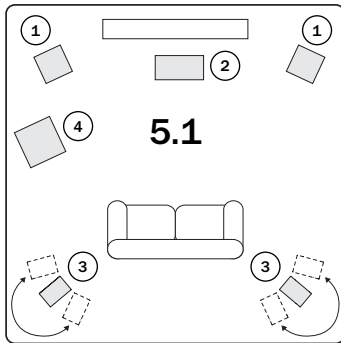

#### ① Front Left and Right speakers

For stereo and multi-channel sound.

#### ② Centre speaker

For dialogue and centre sounds. Ideally position at a similar height to the front left and right speakers (above or below the TV/monitor). Using a centre speaker from the same manufacturer/range as used for the front left and right speakers is advisable. This 'timbre matching' allows surround effects to flow more naturally from left to right without obvious transitions between the speakers.

#### ③ Surround Left and Right speakers

For ambient and multi-channel sound. Floorstanding speakers should be angled towards the listening position. Bookshelf/standmount speakers should be wall mounted or used with dedicated speaker stands, positioned at or above ear height.

#### ④ Subwoofer

For improving the bass in your system, as well as reproducing dedicated LFE cinema effects when playing Dolby Digital or DTS encoded discs. Your subwoofer can often be placed almost anywhere in the room as bass is less directional, but experimentation with positioning is recommended.

The 5.1 relates to the maximum number of speakers that can be used, as the Centre, Sub and Surround speakers can all be deleted if required (although of course performance is reduced). For example, if you choose not to use a Centre Channel speaker you can set this to 'None' in the settings as shown later and the 340R will automatically redirect the centre channel audio information into the Left and Right Front channels, creating what is known as a 'Phantom Centre'.

Similarly, you might decide not to use a subwoofer if your main Left and Right speakers are capable of reproducing enough bass for a satisfying music/movie experience. The 340R will then automatically re-direct the bass from the Subwoofer/Low Frequency Effect channel to the Left and Right Front Speakers.

To setup your speaker configuration, press the OSD button on the remote to activate the On-Screen Display (OSD). **Note:** You must be connected to a TV/Monitor by Composite or S-Video connections first. Highlight the 'Speaker Configuration' menu by using the *Volume Up/Down* buttons on the remote and press the *Enter* button:

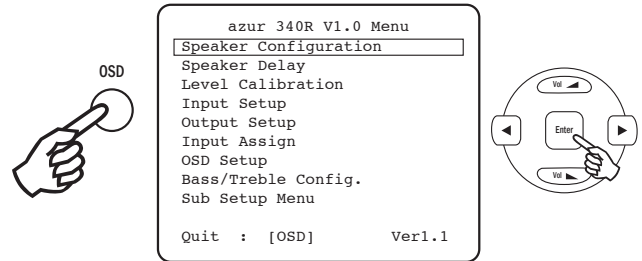

Now move down and by highlighting each speaker in turn and using the *Left* and *Right* arrows select from 'Large', 'Small' or 'None' for each speaker:

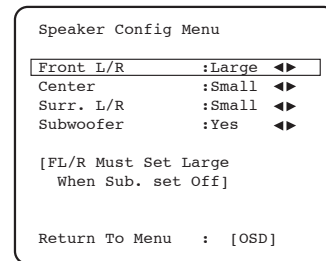

'Large' or 'Small' are used to describe each speaker in terms of bass response, they do not necessarily reflect the actual physical size of the speaker.

**Large** = Speakers with an extended low frequency response of approximately 20-40Hz to 16-20kHz (floorstanders or high quality larger stand-mounted speakers).

**Small** = Speakers with a less extended low frequency response of approximately 80-100Hz to 16-20kHz (small stand-mounted, bookshelf or satellite speakers).

Setting each speaker allows the 340R to perform what is called Bass Management and to direct low frequency bass from music and the Low Frequency Effects channel of surround sound material to those speakers best able to reproduce it. If you do not wish to use any of the speakers change it's setting to 'None'.

The Subwoofer output can also be set to 'Yes' or 'No'. If no sub is being used make sure this setting is set to 'No' to allow the 340R to re-direct the bass information in this channel to other speakers.

**Note:** The 340R will force some speakers to certain settings in some of the following circumstances!

The Front Left and Right speakers may be 'Large' or 'Small' but never 'None' as they are always required for any type of music/movie reproduction.

**Bass must always be reproduced by either the Front Left and Right or Subwoofer channel (or both). The 340R will thus not allow a combination of 'Small' front speakers and no subwoofer.**

If the Front Left and Right cannot reproduce low frequency bass a Subwoofer must be used i.e. If the Front Left and Right are set as 'Small' the Sub must be Set to 'Yes'.

Also, setting the Front Left and Right as 'Small' will always set the other speakers as 'Small' (and the Sub to 'Yes'). This is because LFE/ bass information should not be redirected to the surround channels.

To store the setting simply come back out of the OSD (pressing the OSD button always moves back one menu item, and then exits and stores from the main menu screen).

## 2. Speaker delay

Because the speakers in a surround sound system are usually different distances from the listener the 340R incorporates the ability to apply a variable digital delay to each of the channels so that the sound from each arrives at the same time at the listening position for best surround-sound effect. Each pair of speakers (i.e. Front Left and Right or Surround Left and Right) are subject to the same delay and so must be situated equidistant from the listener.

To set the delay times simply measure the distances from the listening position to each speaker as shown in the following diagram:

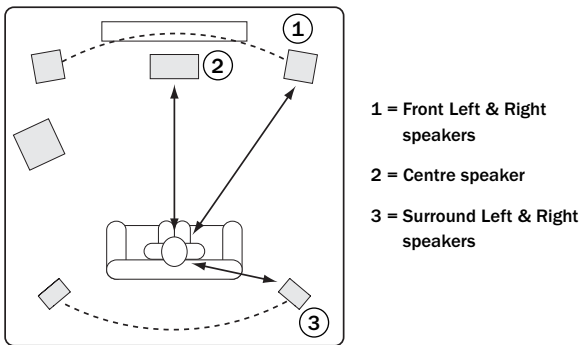

**Note:** No delay setting for the subwoofer is necessary.

Set the distances in the OSD Speaker Delay menu to the nearest value in metres (1 foot = 0.3 metres). The speed of sound is approx 340 metres per second, the 340R thus introduces approx 3mS of delay per metre of distance set.

Go to the 'Speaker Delay Menu' and highlight each speaker in turn. Set the distance to the nearest value to that which you measured by using the *Left* and *Right* arrows (the values do not need to be exact):

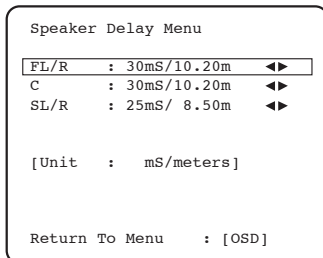

Press the *OSD* button to exit the menu.

**Note:** In addition to the delays as set above Dolby Pro Logic II playback also requires an extra 15 milliseconds delay to the surround channels only. This extra delay is part of the Dolby Pro Logic II specification and ensures that sound from the surrounds arrives just after sound from the front reducing the audibility of sound leakage from the front to the surround speakers. Because the relationship between the Dolby Digital and Dolby Pro Logic II two delays is fixed (15mS extra to the surround channels), it is only necessary to set the delay by measuring the distances as we have described. The 340R will automatically provide the appropriate extra delay whenever you switch to a Pro Logic Mode.

## 3. Level calibration

The 340R allows level calibration to match the acoustic level between different types/sizes or even manufacturers of speaker that may be being used for each channel. This is achieved by adjusting the relative level of each speaker through the 'Level Calibration' menu in the OSD.

The basic process is to listen to or measure with an SPL meter (more accurate and recommended but not essential) the level of sound produced by each speaker and set relative levels for each speaker so that they all sound the same loudness at the normal listening position. The 340R incorporates a Test Signal Generator (broad-band white noise) to facilitate this.

Set the unit to a normal listening level or half maximum volume approximately. Press the *OSD* button on the remote control then select the 'Level Calibration' menu. Now turn on the test signal by highlighting this item and pressing the *Left* or *Right* arrows:

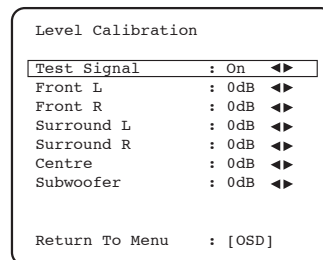

A "rushing" or "hissy" sound should be heard, initially through the Front Left Speaker.

You can now move up and down the channels using *Volume Up/Down* on the remote. Each time a new channel is selected the test signal will be heard to move to that channel. Compare the loudness of all channels as heard at the listening position.

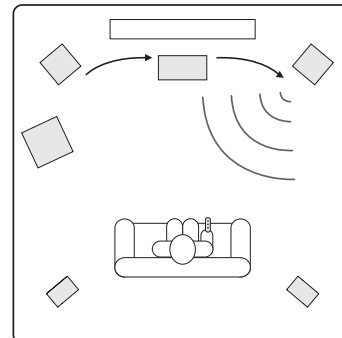

Now adjust the channels so they all sound the same (in terms of loudness only, channels of different frequency responses can sound different in terms of the "tone" of the sound i.e. more or less hissy).

Pick the channel that sounds most different and select it to listen to the test signal. Now adjust the relative level in dB (using Arrow left/right on the remote) and continue comparing it to other channels until it is of equal loudness. The level can be adjusted up to + or - 10dB in 1dB steps. Repeat the process with the next loudest channel etc. Once all channels sound the same in terms of loudness, press the *OSD* button again to save the settings and exit the menu.

## 4. Source setup

The next step is to select each source input in turn on the 340R and tell the unit the type of audio connection you want to use for that source (Analog or Digital input).

**The 340R remembers this setting individually for every source input and automatically recalls it as and when you change source input.**

Select the 'Input Setup' menu. Highlight each source in turn and select either analog or digital input types (use the *Left* and *Right* arrows):

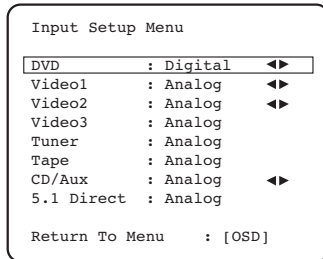

Analog inputs will require a stereo phono/RCA to phono/RCA cable connection to the 340R. Digital inputs will require either a 75ohm digital type phono/RCA to phono/RCA co-axial cable (SPDIF) or an optical fibre cable (TOSLINK). The 340R will automatically use whichever is connected. Do not make connections to both the Optical and Co-axial inputs for a source.

**Note:** Video 3, Tuner, Tape and 5.1 Direct only have analog connections and so are not selectable in this menu.

Once you have set the audio types exit the OSD to save.

This setting can also be changed at any time without using the OSD by pressing the *Input Mode* button on the front panel (or *Audio Type* button on the remote). This will then cycle between analog or digital input types for the currently selected source; as usual they will then be remembered the next time you return to that source.

## 5. Assigning video sources

All of the 340R's rear panel video inputs (S-Video/Composite, Component and HDMI) are freely assignable to the DVD, Video 1, Video 2, Tape/MD, CD/Aux and 5.1 Direct sources for maximum flexibility.

Select the 'Input Assign' menu. Highlight each Video input in turn and select a source to assign it to:

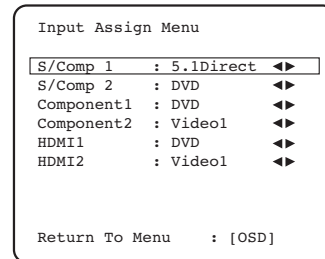

**Note:** The 340R prevents you from setting two sources to the same video input, as this would cause problems, but doesn't prevent you from setting the same source to different video inputs.

The 340R has two HMDI (High Definition Multi-Media Interface) inputs and one HDMI output. HDMI is a fully digital audio/video system that passes the picture and audio to the screen in digital format for best possible picture quality. DVI (Digital Video Interface) is a subset of HDMI that uses different connectors and only passes digital video to the TV/Monitor (no audio). The 340R is fully compatible with DVI in that simple passive DVI-HDMI adaptors are available which allow the conversion of the DVI connector to an HDMI format connector (and back again if required) for routing via the 340R. The 340R can switch both types of signal.

**The 340R performs HDMI switching, not processing, it routes the HDMI signals from the source equipment to the TV/Monitor without any processing, so as far as the 340R is concerned there is no setup involved other than to assign the three inputs to a desired source. The 340R does not receive audio or video over the HDMI, so for surround-sound decoding etc, an audio connection must also be made from your HDMI source to the 340R. As with other sources this can be analog or digital audio. A digital audio SPDIF/Toslink connection is preferred and will be required if it is desired to decode surround-sound for the HDMI sources.**

Press the OSD button to exit the menu.

### HDMI Pre-Emphasis

The HDMI interface is generally specified for transmission over cable lengths up to 5m. Longer cable runs can sometimes be accommodated if very high quality HDMI cables are used. The 340R is able to apply some pre-emphasis to the HDMI signals to allow for cable losses in such situations. For cable runs less than 5m HDMI Pre Emphasis should generally be 'Off'. For runs greater than 5m HDMI Pre Emphasis should be 'On'.

**Note:** The maximum cable length possible depends on cable quality and to some extent on the resolution of the video being transmitted (i.e. higher bit rate signals are harder to transmit over long distances). Use only good quality HDMI cables. Poor quality cables can have problems with HDMI at only 5m and only very high quality cables will work at distances over 5m.

Select the 'Output Setup' menu, highlight 'HDMI PRE' and select either 'Off' or 'On':

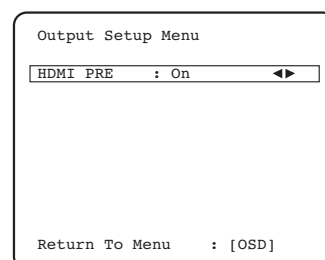

Press the OSD button to exit the menu.

## Surround sound modes

The 340R has several music and home-cinema listening modes available. Before we describe how to operate the 340R, below is a brief guide to surround sound formats:

### **Dolby Digital**

Known also as DD (3/2) or DD 5.1, provides (up to) 5.1 output from suitable encoded Dolby Digital material, with 5 main channels (Front Left, Front Right, Centre, Surround Left, Surround Right) and a Low Frequency Effects Channel for the subwoofer, all discretely encoded. Decoding Dolby Digital requires a Dolby Digital encoded DVD disc and a digital connection from the source equipment (Such as a DVD player) to the 340R.

**Note:** Dolby Digital and DTS formats can sometimes carry less channels than their maximum such as Dolby Digital (2/0) which means a Dolby Digital encoded signal which is actually only carrying a two channel stereo signal (other channels inactive).

### **DTS**

Known also as DTS (3/2) or DTS 5.1, DTS provides (up to) 5.1 output from suitable encoded DTS material, with 5 main channels (Front Left, Front Right, Centre, Surround Left, Surround Right) and a Low Frequency Effects Channel for the subwoofer, all discretely encoded. Decoding DTS requires a suitably encoded DTS disc and a digital connection from the source equipment to the 340R.

### **Pro Logic II**

The replacement for original Pro Logic, Pro Logic II is a technology where 5 channels (Front Left, Front Right, Centre, Surround Left, Surround Right) are encoded into a Stereo mix by an analog matrix process. Dolby Pro Logic II material can be played back by normal Stereo equipment (as Stereo) or decoded into 5 channel surround-sound.

Dolby Pro Logic II is compatible with the earlier 4 channel (Left, Centre, Right and mono Surround) Dolby Pro Logic system (which was the decoding counterpart to Dolby Surround encoding) as used widely on Video tapes, TV broadcasts and earlier films.

**Note:** Pro Logic does not include a Low Frequency Effects channel for the Subwoofer, but the 340R can create a Subwoofer output (for 5.1) via Bass management. Refer to the 'Advanced bass management' section in the 'Operating instructions' part of this manual.

### **Dolby Digital EX**

Known also as DD (3/3) or DD 6.1, an enhanced form of Dolby Digital. On top of the normal discretely encoded 5.1 channels DD EX provides an extra 6th channel (Surround Back) matrix encoded into the rear surrounds. As DD EX 6.1 is backwards compatible with DD 5.1 the 340R can play back DD EX material as 5.1. The 6th Surround Back signal is then present in both Left and Right Rear Surrounds forming a phantom rear centre.

### **DTS-ES 6.1 Matrix, DTS-ES 6.1 Discrete**

Enhanced forms of DTS which also encode an extra 6th channel (Surround Back) into the rear surrounds. Both DTS EX Matrix and DTS EX Discrete are backwards compatible with DTS 5.1 so the 340R can play back DTS ES Matrix or Discrete material as 5.1, the 6th Surround Back signal being present in both Left and Right Rear Surrounds as a phantom rear centre.

## DSP modes

These modes allow a realistic surround-sound experience from source material that has no encoding at all. The surround sound effect is achieved by Digital Signal Processing of the Analog or Digital stereo source used. Five modes are possible: Movie, Music, Room, Theatre and Hall.

## Operating instructions

To activate the 340R, switch the Power button on the rear panel to *On* then press the *Standby/On* button on the front panel.

### Selecting the source

1. Select the desired source by pushing the corresponding source button on the front panel or remote control.

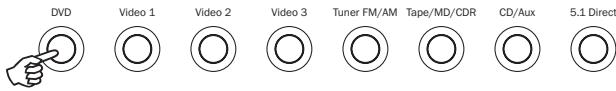

2. If necessary, press the *Input Mode* button to select the input mode of the source equipment, either analog or digital (depending on the connection made on the rear panel).



The digital or analog icons on the display show which is the currently selected input type.

**Note:** The 340R stores the input type for each source so that it is automatically recalled when that source is selected again.

### Selecting the desired listening mode

Select an appropriate mode for the source material/type you are listening to by pressing one of the three main Digital Processing Options buttons and cycling through sub-modes where available.



**In all cases the first time a mode button is pressed the 340R will report the current decoding mode on the front panel display. Pressing the button again will then cycle to the next available mode (if there is one). If no button is pressed for 4 or 5 seconds the 340R returns to normal operation without changing mode.**

**Stereo Modes** - Selects 2 channel Stereo operation for stereo material, pressing again selects Stereo + Sub mode.

This is a digitally processed mode that allows bass and treble controls, and sub generation if required. The input can be either analog (in which case it will be turned into digital by 24 bit A/D conversion) or natively digital.

Digital inputs can be connected to the SPDIF outputs from Tuner's or CD Players etc (LPCM) or the digital outputs of DVD players (set to Bitstream/Raw) playing 2-channel Dolby Digital (2/0) or DTS (2/0) material.

**Pro Logic II** - Selects Pro Logic II decoding for use with appropriate matrix encoded material.

**Dolby Digital / DTS Modes** - Selects a range of digital surround modes with the appropriately digitally encoded material (only). These modes are for use with the digital outputs (set to Bitstream/Raw) from DVD players or satellite receivers etc. In order for the 340R to allow selection of these modes a valid input digital bitstream must be present. This is because the 340R needs to read the incoming flags in order to determine the type of decoding which can be used and present any options that might be possible.

If no bitstream is present, pressing this button will result in the 340R displaying 'MODE UNAVAILABLE'.

**Incoming Dolby Digital/DTS streams are always shown on the front panel display as Dolby Digital (x/x) or DTS (x/x), where the bracketed numbers indicate the active channels in the source material. Active output channels are shown by the icons on the right hand side of the front panel display. Possible incoming DD/DTS types are:**

(1/0) - Mono, Centre channel only

(2/0) - Left/Right stereo

(2/1) - Left/Right stereo and LFE (Sub)

(2/2) - Left/Right stereo and Left/Right surround

(3/0) - Left, Centre, Right

(3/1) - Left, Centre, Right and LFE (Sub)

(3/2) - 5.1: Left, Right, Centre, Left Surround, Right Surround and LFE (Sub)

(3/3) - 6.1: Left, Right, Centre, Left Surround, Right Surround, Surround Back and LFE (Sub). **Note:** The 340R will output 6.1 inputs as 5.1 with a phantom back centre channel as 6.1 decoding is not supported.



## Decode modes



Pro Logic II



Dolby Digital/  
DTS

Incoming audio format	Native channel resolution	Modes (button cycles round)	Output channels	Modes (button cycles round)	Output Channels
PCM	2 (5.1 if PLII encoded)	PLII Movie PLII Music	>5.1 >5.1	PCM	2 ♦
Dolby Digital (2/0)	2	Dolby Digital (2/0) + PLII Movie Dolby Digital (2/0) + PLII Music	>5.1 >5.1	Dolby Digital (2/0)	2
Dolby Digital (3/2)	5.1			Dolby Digital (3/2)	5.1
DTS (2/0)	2			DTS (2/0)	2
DTS (3/2)	5.1			DTS (3/2)	5.1



DSP  
Mode

Modes (button cycles round)	Output channels
Movie	>5.1 ■
Music	>5.1 ▲
Room	>5.1 ■
Theatre	>5.1 ■
Hall	>5.1 ■



Stereo  
Mode

Modes (button cycles round)	Output channels
Stereo	2
Stereo + Sub	2.1
Either native Stereo or downmix of DD/DTS 5.1/6.1 etc.	

Pressing a mode button will first cause the 340R to scroll the current decode mode across the front panel display. Pressing the mode button again whilst text is scrolling on the display or within 4 seconds of it finishing will select and display the next available mode.

### Key

- >5.1 Indicates 5.1 output created by a 2.0 decode, post-processed to 5.1.
- ♦ Stereo or Stereo + Sub, press the *Stereo Modes* button to change.
- Digital Signal Processing created modes for signals with no encoding.
- ▲ DSP Music mode has no active centre channel output, as this is not appropriate for this program type.

**Note:** Bold entries are being output in their native resolution/format.

## Operating instructions continued

### Dynamic Range Control

This setting controls the dynamic range of Dolby Digital or DTS movie soundtracks by compressing the dynamics in four stages to limit the difference in level between loud and quiet passages in the movie.

This can be a useful feature when watching movies late at night for instance. Four settings are possible:

DRC=0/4 No Compression (normal full dynamic range playback)

DRC=1/4

DRC=2/4

DRC=3/4

DRC=4/4 Greatest Compression (reduced dynamic range playback)

DRC can be accessed by the DRC button on the remote, DRC=0/4 etc is displayed, pressing the button again moves to the next setting. When finished make no adjustment for a few seconds and the 340R will save the settings and exit the menu.

**Note:** DRC only works for Dolby Digital or DTS source material which supports this feature.

### Using the Tuner

1. Press the *Tuner FM/AM* button on the front panel or remote control to select Tuner mode.
2. Press the *Tuner FM/AM* button again to select FM or AM if desired.
3. Press the *Mode/Store* button on the front panel (or *Mode* button on the remote control) to select automatic tuning, manual tuning or preset mode.
4. Press the *Tuning +* and *Tuning -* buttons (or the left and right arrow buttons on the remote) to select the station you want to listen to.

In automatic tuning mode the unit scans to the next strong station. In manual tuning mode the user can step manually through the frequencies. In preset mode the unit cycles through the presets only.

Two FM modes are available, stereo and mono - Press the *Stereo/Mono* button on the remote to alternate between Stereo mode and Mono mode. If the *Display* button is pressed, the RDS station names of FM stations will be displayed if available.

### Storing stations

1. Tune in a station you wish to store as explained previously.
2. Press and hold the *Mode/Store* button (or *Store* button on the remote) for 5 seconds to bring up the 'MEM' icon.
3. Use the *Tuning+/-* buttons to select a preset station number (1-15). The station number will be displayed on the screen.
4. Press the *Mode/Store* button (or *Store* button on the remote) to memorise, while the 'MEM' icon is still flashing.

### Radio Data Systems (RDS)

RDS is a method for the transmission of additional information from local radio stations. It is only available in FM mode. RDS will only work if the local broadcasting stations have RDS transmission and the signal is strong enough.

Press the *Display* button on the remote and go through the displayed functions. There are functions for PS, PTY, CT and RT:

PS (Station Name) - current station name will be shown

PTY (Program Type) - current name type of the program will be shown

CT (Clock/Time) - current time from Radio Station will be displayed.

**Note:** Clock/Time will be only transmitted from local radio station once a minute. If the Clock - Time is not available the message 'NO CT' will appear briefly on the display.

RT (Radiotext) - some Text messages will be shown.

### Program Type Search (PTY)

1. Press the *PTY* button on remote control, 'PTY SELECT' will flash on the display.
2. Press *Tuning + /-* to choose the program type, for example NEWS or SPORT.
3. Press the *PTY* button again once you have chosen the program type.

When the selected type of program is tuned in, it will stop searching, otherwise, PTY Search will timeout after approximately 30 seconds.

### Auto Program Search (APS)

1. Press the *Tuner FM/AM* button to select the AM or FM band.
2. Press the *APS* button on the remote to begin the automatic program search through available stations. The searched stations will be memorised in the respective band memory (maximum of 15 stations).

## Audio split mode

The 340R is able to allow the user to listen to one source whilst viewing another. For instance this can be useful if it is desired to watch a sports channel from say a set-top/satellite video source whilst getting audio commentary from the Radio Tuner. Another example might be to listen to a CD whilst watching a video channel, perhaps waiting for a TV programme to start.

First select the Video channel you wish to watch in the normal way. Now press and hold down the button for the channel you wish to listen to. After 4 seconds approx 'Audio Split' will scroll across the display and you will now be listening to the other source.

To cancel audio split mode simply select a new source and normal operation will be resumed.

## Bass/Treble configuration

Select the 'Bass/Treble configuration' menu:

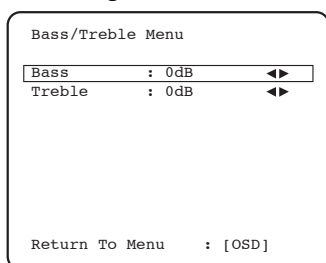

The Bass response can be adjusted +/- 10dB @ 100Hz (shelving). The Treble response can be adjusted +/-10dB @ 10kHz (shelving). The 'Tone' icon will light up on the display if these controls are adjusted away from 0dB (flat).

**Bass/Treble adjustments can also be made from the remote without entering the OSD by pressing the Bass/Treble button and then using the Vol Up/Down buttons.**

## Subwoofer setup

As covered in the '340R Setup' section the 340R performs bass management for any speaker that is set to 'Small' in the OSD. This means that bass for speakers that are unable to reproduce it effectively is instead routed to the subwoofer.

Select the 'Sub Setup' menu:

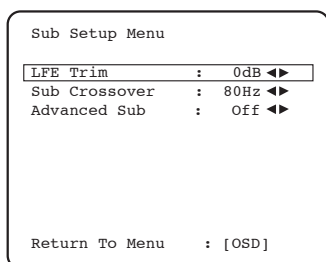

The crossover adjustment in the Sub Setup menu is used to determine the point as which this transition is made. In other words it sets the frequency below which bass is routed away from any 'Small' speakers and into the Subwoofer channel. It should be understood that bass sent to the subwoofer by bass management is different to bass encoded into the surround-sound material as a dedicated Low Frequency Effects channel. The crossover point can be adjusted from 40Hz to 150Hz in 10Hz steps.

If the source material contains a separate LFE channel (ie DD or DTS material) this is always routed to the subwoofer (if it is On) and is not affected by the crossover setting. **Note:** Pro Logic II does not actually have a LFE channel.

**Note:** These adjustments work in the digitally processed Stereo and Surround modes but not in 5.1 Direct mode.

The Sub/LFE channel (for DD / DTS material) can also be trimmed by up to -10dB in 1dB steps useful for late night listening or other situations where it might be desired to reduce the low frequency effect level perhaps temporarily.

**LFE Trim adjustments can also be made from the remote without the OSD by pressing the LFE Trim button and using the Vol Up/Down buttons.**

## Advanced bass management

The 340R also features an advanced bass management system which when turned on allows the user to set different crossover frequencies for different modes of operation, plus a special Bass Augment function.

To enable advanced bass management highlight the 'Advanced Sub' item in the Sub Setup menu and use the *Left* or *Right* arrows to turn it on:

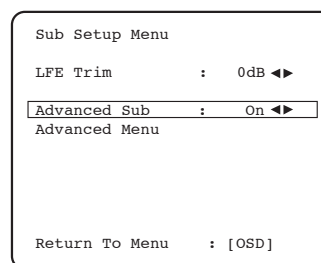

With advanced bass management now on, the 'Sub Crossover' item disappears and a new item called 'Advanced Menu' appears. To make changes to the advanced settings navigate to 'Advanced Menu' and press *Enter*:

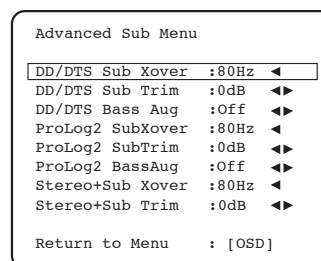

It is now possible to set three separate crossover points and Trim levels (+/- 10dB) for each of the three main types of operation: DD/DTS decoding, Pro Logic II decoding and Stereo + Sub operation.

Also possible is a Bass Augment function for DD/DTS or PLII operation.

In normal operation (Bass Augment Off) if the Front speakers are set to 'Small' (in the 'Speaker Config' menu) their bass is re-directed by high-pass filtering the Fronts and sending that bass to the Sub channel (i.e. bass is removed from the Fronts and sent to the Sub). If they are set to 'Large' no filtering takes place and no bass is sent from them to the Sub channel.

However with the Bass Augment function On and the Front speakers set to 'Large', bass from the Front Left and Right is now sent to the Sub channel without any filtering of the Front Left and Right taking place (i.e. these channels remain full range). In other words, the bass in the Sub channel is augmented by extra bass from the Front Left and Right channels. If the Front Left and Right are set 'Small', Bass Augment has no effect and operation is the same as for Bass Augment Off.

Bass Augment can be On or Off separately for DD/DTS or PLII operation.

There is no Sub Augment function for Stereo + Sub mode because in this mode if the Front speakers are set to 'Large' they will actually always be unfiltered.

## Advanced bass management continued

Bass Augment can be a useful function with PLII material because this encoding type does not include an LFE Channel. This would normally mean that if all the speakers in your setup were set to 'Large', the subwoofer would in fact be inactive (as no bass has been re-directed plus there is no LFE channel). If it is desired to have the subwoofer running with all Large Speakers and PLII encoding, enable Bass Augment for PLII and then set the Crossover point and level by ear. A Sub channel will now be created from the Front Left and Right channels without filtering them. As with all adjustments it is a good idea to experiment to determine what works best with your particular setup.

**Note:** In Advanced Sub On mode, the Subwoofer level control in the 'Level Calibration' menu will be inactive. This is because this setting is overwritten by the three appropriate Sub Trim settings from the 'Advanced Sub' menu.

## OSD setup

On-Screen Display is available on the Composite and S-Video outputs only. **(Not available on Component Video or HDMI.)** Select the 'OSD Setup' menu, select 'OSD Video' and use the *Left* and *Right* arrows to select whether you would like the OSD video source to be Composite or S-Video:

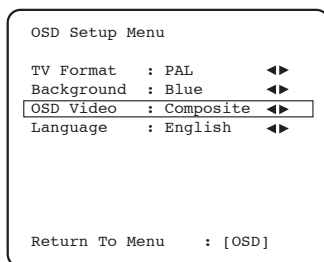

The OSD can be shown either on a blue background or overlaid on the analog video. Select 'Background' and use the *Left* and *Right* arrows to select between 'Blue' and 'Video' backgrounds.

The OSD can also be shown in several different languages. To change the OSD language highlight the 'Language' menu and use the *Left* and *Right* arrows to select between English, Dutch, French, German, Spanish, Italian, Norwegian, Swedish and Danish.

Press the *OSD* button again to exit and save the options.

## Custom installation (C.I.) use

The 340R features an IR Emitter input that allows modulated IR remote control commands to be received electrically by the unit. These control commands are typically generated by custom installation (multi-room) systems or remote IR receiver systems. An RS232C port is also featured which allows the 340R to be controlled by C.I. systems.

In addition the 340R features 'direct' IR/Control codes as well as toggle codes for many of their features to simplify programming custom installation systems. Special direct On/Off commands can be accessed on the supplied remote control for teaching into C.I. systems as follows:

1. Press and hold the *Standby/On* button on the remote control. The remote first generates its standby (toggle) command. Keep the button held down, after 12 seconds an AV receiver 'On' command will be generated. If the button is kept held down for a further 12 seconds, an AV receiver 'Off' command is generated.

Repeat this procedure with the Mute, Sub On/Off, Stereo Mono and Tuner FM/AM buttons to send On/Off commands. The Tuner FM/AM button also provides unique FM and AM commands to allow switching to a specific band.

A full IR code table and RS232 protocol for this product is available on the Cambridge Audio website at: [www.cambridge-audio.com](http://www.cambridge-audio.com)

## Reset/Back-up memory

The 340R has a function that preserves the preset memory and other settings. In the event of a power failure, or if the power cord of the unit is disconnected from the mains outlet, the back-up memory will preserve the preset memory for approximately one week. If the power supply is interrupted for 7 days or longer, the memory settings will be erased.

If it is desired to reset all settings to their factory defaults (or in the unlikely event that the unit locks up due to an electrical discharge etc), with the unit on and out of Standby mode press and hold the *DVD* and *5.1 Direct* buttons on the front panel for three seconds:

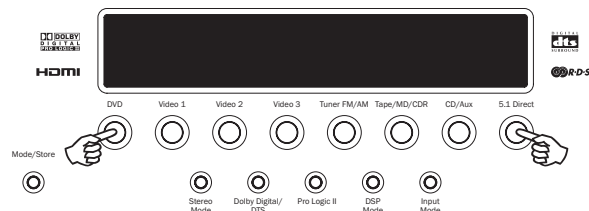

'RESET' will appear briefly on the front panel display before returning to Standby mode.

## Troubleshooting

### A low hum or buzz sound can be heard

Power cords or lighting placed near this product.  
Analog inputs not connected securely.

### Sound is not audible from one channel

Speaker connections disconnected.  
Speaker set to 'None' in OSD setup menu.

### Sound cuts off when listening to music or there is no sound even though power is ON

Speaker impedance is less than prescribed for the 340R.  
The unit is not adequately ventilated and may be overheating.

### Low bass or "phasesy" response

Speaker polarity (+/-) of one or more speakers is reversed.

### An unusual hissing noise is heard when listening to a radio broadcast in stereo, but not heard when listening in mono

A slight noise may be heard because the method used for modulation of FM stereo broadcasts is different than that used for mono broadcasts.  
Aerial quality also effects the level of hiss heard.

### Noise is excessive in both stereo and monaural radio broadcasts

Poor location and/or direction of the antenna.  
Transmitting station is too far away.

### No sound from the rear speakers

Source being played is not recorded in surround sound.  
Speaker/s set to 'None' in OSD setup menu.  
A stereo mode has been selected.

### No sound from the centre speaker

Centre speaker has been set to 'None' in OSD setup menu.  
A stereo mode has been selected.

### No sound from the subwoofer

Sub has been set to 'Off' in the OSD setup menu or via the remote.  
DD PLII mode (which has no LFE channel) has been selected with all speakers set to 'Large'.

### Remote control is not working

The batteries are flat.  
The remote is too far from the receiver or out of the effective range.

### No sound from speakers when connected to a digital input

Audio input type is set to analogue (check display). Press the *Audio Type* button to switch to digital.

### No sound from speakers when connected to an analogue input

Audio input type is set to digital. Press the *Audio Type* button to switch to analog (check display).  
Audio input type can also be set in the Input Setup menu of the OSD.

### OSD not visible

Check that the TV/Monitor is connected to the 340R and is using a Composite or S-Video connection.

For more frequently asked questions (FAQ's), technical advice and information on getting the most out of your 340R, please visit the Support section on Cambridge Audio's website:

[www.cambridgeaudio.com/support.php](http://www.cambridgeaudio.com/support.php)

## Technical specifications

<b>Power Output</b>	80 watts rms per channel, 8 ohms, two channels driven
	50 watts rms per channel, 8 ohms all 5 channels driven
<b>THD</b>	<0.006% @1kHz
<b>Crosstalk</b>	<-60dB
<b>Frequency response</b>	20Hz - 20kHz +/- 1dB
<b>Audio Input Sensitivity</b>	150mV
<b>Audio Input Impedance</b>	47kOhms
<b>Digital Input Impedance</b>	75ohms (Coaxial/SPDIF)
<b>S/N Ratio</b>	>90dB 'A' weighted
<b>Tone Control Range</b>	Bass +/- 10dB Treble +/- 10dB
<b>FM Tuner</b>	87.5-108MHz, 75 ohm coaxial aerial
<b>AM Tuner</b>	522-1629kHz, 300 ohm loop aerial
<b>Video Levels /Impedance</b>	Composite (CVBS) = 1Vp-p / 75ohm
	S-Video (S-VHS) = Y 1Vp-p / 75ohm C 0.286 Vp-p / 75ohm
	Component = Y 1Vp-p / 75ohm Cb/Cr 0.75Vp-p / 75ohm Pb/Pr 0.75Vp-p / 75ohm
<b>HDMI</b>	Transfer of all resolutions up to and including 1080p @ 50/60Hz (1920 x 1080) supported, with HDCP handshaking.
<b>Architecture</b>	CS42518 CODEC CS493263 DSP
<b>Audio Inputs</b>	6 Line Level + Tuner 5.1 Direct input
<b>Audio Outputs</b>	5 Amplified Speaker outputs 1 Subwoofer output 1 Tape/MD/CDR record output
<b>Video Inputs</b>	3 Composite, 2 S-Video, 2 Component Video, 2 HDMI
<b>Video Outputs</b>	1 Composite, 1 S-Video, 1 Component Video, 1 HDMI
<b>Digital Inputs</b>	4 Co-Axial, 4 Optical
<b>Digital Outputs</b>	1 Co-Axial, 1 Optical, 1 HDMI
<b>Stby power consumption</b>	<10w
<b>Max power consumption</b>	400w
<b>Dimensions - H x W x D</b>	150 x 350 x 430mm
<b>Weight</b>	8.9kg (19.6lbs)

Cambridge Audio is a brand of Audio Partnership Plc

Registered Office: Gallery Court, Hankey Place,

London, SE1 4BB, United Kingdom

Registered in England No. 2953313

**[www.cambridge-audio.com](http://www.cambridge-audio.com)**

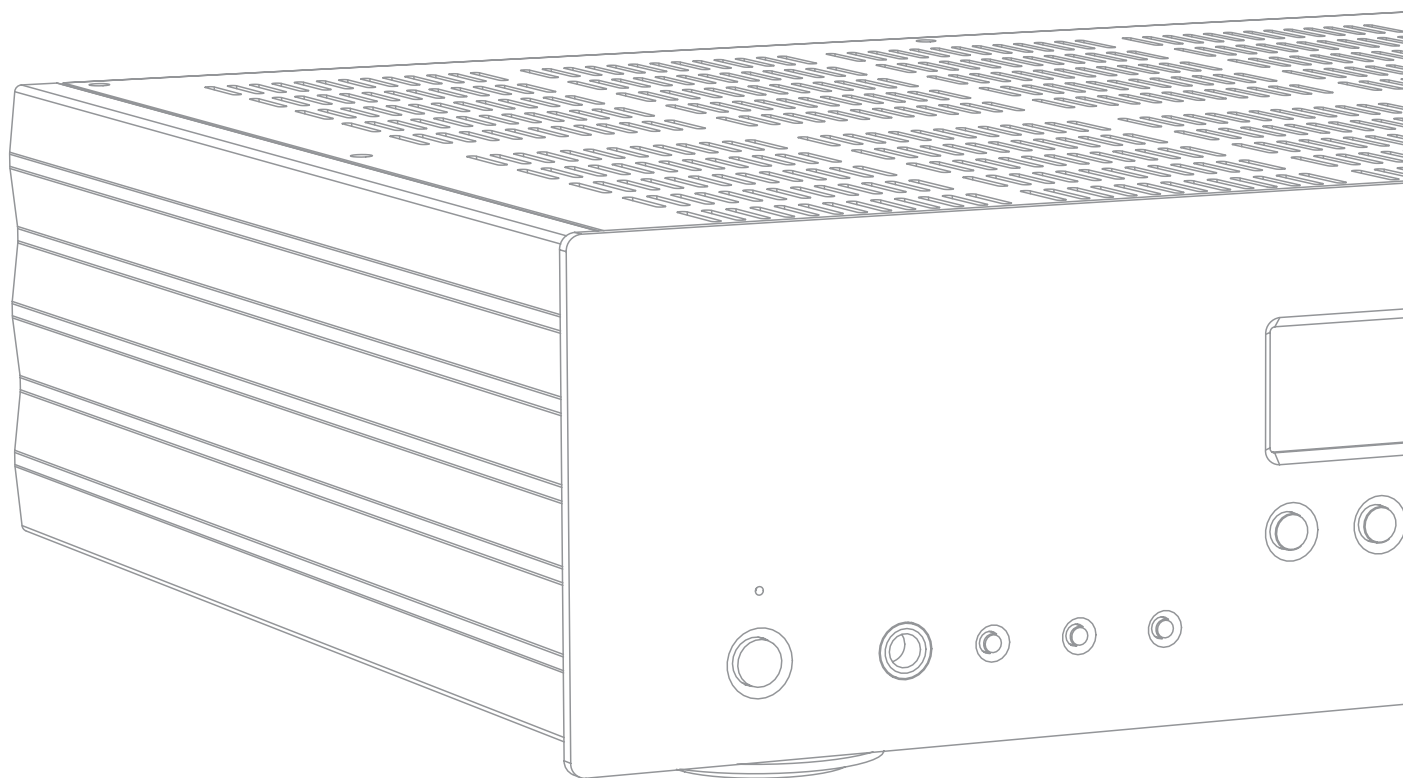

© 2007 Cambridge Audio Ltd

AP21582/2-A

## Free Manuals Download Website

<http://myh66.com>

<http://usermanuals.us>

<http://www.somanuals.com>

<http://www.4manuals.cc>

<http://www.manual-lib.com>

<http://www.404manual.com>

<http://www.luxmanual.com>

<http://aubethermostatmanual.com>

Golf course search by state

<http://golfingnear.com>

Email search by domain

<http://emailbydomain.com>

Auto manuals search

<http://auto.somanuals.com>

TV manuals search

<http://tv.somanuals.com>