CANDY

Washing machine

Instructions for use

AQUA 1000 T



AQUAMATIC

Introduction

Please read these instructions for use carefully and all other information enclosed with the washing machine.

Keep all documentation in a safe place for future reference or for any future owners.

Note: this machine is solely for domestic use.

Notes on disposal

All packaging material used is environmentally-friendly and recyclable. Please help dispose of the packaging via environmentally-friendly means.

Your supplier or local council will be able to give you details of current means of disposal.

Valuable materials can be salvaged from an old appliance via scrap reprocessing.

Note: pull out the mains plug from any old appliance. Cut the power cable and dispose of it, together with the plug.

When disposing of an old washing machine, please ensure that the door lock is rendered inoperable to prevent children shutting themselves in the appliance.

Contents

Page

Introduction	2
General delivery notes	4
Safety notes	4
Quick start	5
Useful advice for the user	6
Description of controls	7
Detergent drawer	10
Programme selector	11
The main wash	11
Programme Table	14
Detergents, washing aids and amounts to use	16
Cleaning and routine maintenance	18
Investigating malfunctions	20
Customer service + Guarantee	21
Technical data	22
Setting up + installation	23

BEFORE SWITCHING ON THE APPLIANCE MAKE SURE IT IS CORRECTLY INSTALLED AND THAT THE TRANSIT BRACKETS ARE REMOVED AS SHOWN IN PAGE 23.

General delivery notes

Please check that the following items are delivered with the appliance:

- Instruction manual
- Certificate of guarantee
- Inlet hose

Check that no damage has occurred during transit, and if so, call your nearest Authorised Technical Support Service agent (see Customer Service)

Safety notes.

Note:
for cleaning or maintenance of the washing machine

- A) Pull out the plug
- B) Turn off the tap
- C) Candy equips all its appliances with earthing. Ensure that the mains supply is earthed, and if it is not, seek assistance from a qualified person.
- D) Do not touch the appliance when hands or feet are wet or damp. Do not use the appliance with bare feet.
- E) The use of adapters, multiple connectors and/or extensions is not recommended.

Note:
water temperature can reach 90°C during the wash cycle

- F) Check there is no water left in the drum before opening the door.
- G) Do not allow children or unauthorised persons to use the appliance without supervision.
- H) Do not pull the power cable or the appliance itself to remove the plug from the socket.
- I) The appliance must not be exposed to weather conditions (rain, direct sun, etc...)
- L) When moving the appliance never lift it by the controls or by the detergent drawer.
When in transit never rest the door against the trolley or transport the appliance without the polystyrene base.

M) **N.B!**

If the appliance is installed on a carpeted floor ensure that the ventilation holes on the base of the appliance are not obstructed.

- N) If the appliance is not running properly or breaks down, switch it off, turn off the tap and do not tamper with the appliance.

Consult only the Authorised Technical Support Service for possible repair and ask them to use original spare parts.

Failure to comply with the above can compromise the safety of the appliance.

- O) If the appliance's power cable should ever need replacing, consult the Authorised Technical Support Service

Quick start

Washing

- Open the porthole by using the DOOR OPEN button "B" (Fig. 1, page 7)
- Select laundry and put it in the machine
- Close the door
- Put detergent in the compartments as indicated in the programme guide in this instruction manual
- Select programme
- Press additional function buttons (if required)
- Press the on/off button (page 7)

After washing

- Wait for the door lock to be released (about 2 minutes after the programme has finished).
- Switch off the washing machine by pressing the On/Off button
- Open the door and remove the laundry

Useful advice for users

Tips on using your domestic appliance in the most environmentally-friendly and economical way

Do a full load in your washing machine

To prevent any possible waste of energy, water or detergent we recommend that you put a full load in your washing machine, not exceed the maximum loads shown below:

Cotton and linen	3,5 kg
Mixed	2 kg
Very delicate	1,5 kg
Wool	1 kg

Up to 50% energy saving can be made with one full load compared to two half load washes

When is prewashing really needed?

Only with particularly dirty loads!

Energy savings of 5 to 15% are made by not selecting the prewash option for normal soiled laundry.

Which wash temperature should you choose?

Using stain removers before machine washing reduces the need to wash at temperatures over 60°C.

Energy savings of up to 50% can be made by using a 60°C wash temperature rather than 90°C

Description of controls

Fig. 1

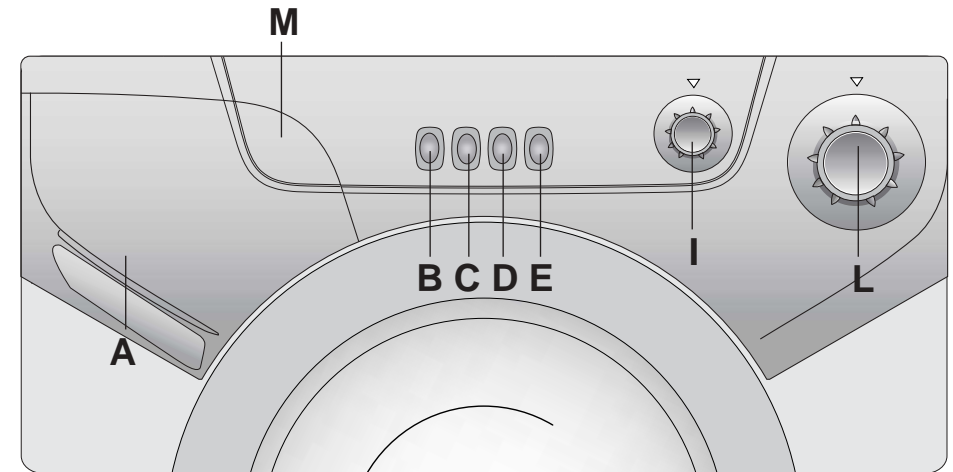

B

Door open button

A special safety device prevents the porthole from being opened immediately after the end of the cycle. **Wait for 2 minutes** after the wash cycle has finished before opening the door.

C

On/off button

Press to start the appliance. At the end of the cycle press again to reset the button and switch off the appliance.

NO SPIN button

D

By pressing this button it is possible to eliminate the spin-drying on all programmes. This operation is suitable for programmes at 90°C and at 60°C in case of special treated fabrics (cottonova or permanent press) or for mixed delicate fabrics.

EXTRA RINSE button

E

This function will allow an extra rinse or more water added at the rinse stage – depending on the programme selected. This is particularly important for avoiding skin irritation from detergent residues for people with particularly sensitive skin.

The extra rinse button is also recommended when washing heavily soiled fabrics, requiring the use of a lot of detergent, or when washing items made of towelling, whose fibres have a greater tendency to retain detergent.

WASH TEMPERATURE selector **I**

I

Can be turned in either direction

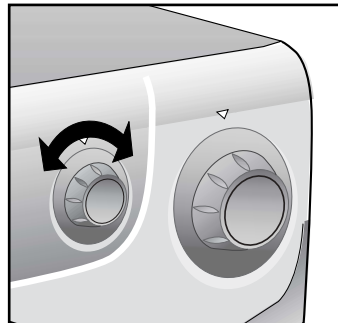

This washing machine is equipped with this device for setting the wash temperature you want. We recommend that the temperature shown on the label inside garments should never be exceeded.

The most suitable temperature and cycle for each type of fabric is shown in the programme guide.

To protect fabrics, if the variable temperature dial has accidentally been set too high than stated in the programme guide, the machine will lower the temperature automatically.

PROGRAMME Selector **L**

L

Note: never turn the dial anti-clockwise (Turn it clockwise and do not press the on/off button before selecting the programme.)

The tables in the washing section describe the various programmes and give the number or symbol to select for them.

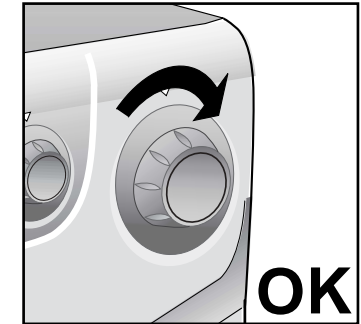
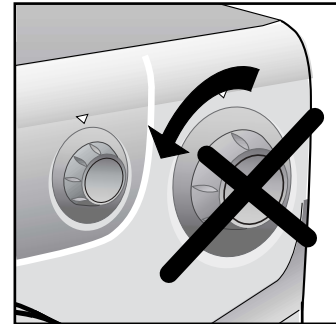

IMPORTANT : IF YOU NEED TO CHANGE A PROGRAMME THAT HAS ALREADY STARTED – SWITCH OFF THE MACHINE BY THE ON / OFF BUTTON AND THEN MOVE THE PROGRAMME DIAL TO THE CORRECT POSITION. IF YOU DO NOT PRESS "OFF" BEFOREHAND, THE DIAL WILL AUTOMATICALLY MOVE TO ITS INITIAL POSITION.

Pull-out wash programme guide **M**

M

Apply the adhesive label supplied in the appropriate language onto the pull-out wash programme guide.

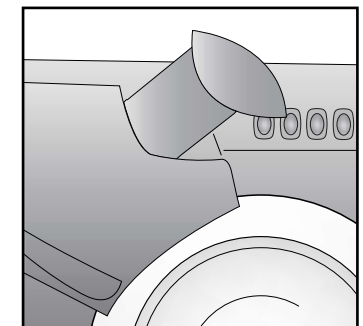



Detergent drawer

A

The detergent draw is split into 2 compartments:

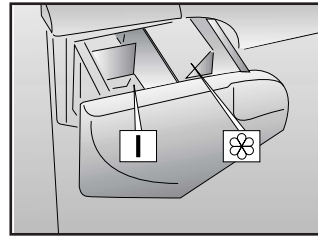
- the first, labelled "I", is for main wash detergent;
- the second, labelled "☼" is for special additives, fabric softeners, fragrances, starch, brighteners etc.



When washing with bleach use the compartment  for softener.

When pre-washing, put the detergent directly in the drum.

When selecting the "32 minute Rapid programme", put the detergent directly in the drum.

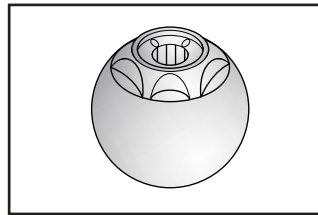

Note: some detergents are difficult to remove. For these, we recommend you use the special dispenser which is placed in the drum.

Note: only put liquid products in the second compartments.

Programme selector

The washing machine has 3 different programme groups according to type of wash, temperature and duration for handling the various types of fabric (see wash programme guide).

1. Colourfast fabric

The programmes are designed for maximum washing and rinsing. With spin stages in between, they guarantee the laundry is rinsed perfectly. The final spin stage ensures laundry is wrung out as much as possible.

COTTONS



2. Mixed fibres and synthetics

Washing and rinsing performance is optimised through drum rotation speeds and water level. The delicate action spin minimises creasing.

SYNTHETICS



3. Delicate fabrics, wool & extra delicate programme

This group of programmes have been specially designed to wash the most delicate fabrics

DELICATES



Use the Delicate programme for delicate fabrics

Use the Woollens programme only for machine washable wool



Use the extra delicate programme for any machine washable handwash garments



Main wash

Automatic Variable Capacity

The washing machine is fitted with an automatic reduction in consumption system (known as Automatic Variable Capacity).

This system enables the machine to use the amount of water needed to wash and rinse the laundry in relation to the particular load.

This results in a reduction in the amount of water used and electricity needed to heat it to the minimum required, without in any way compromising the washing and rinsing performance. In fact the amount of water and electricity used will always be appropriate for the amount of washing.

The washing machine therefore ensures you achieve excellent washing results whilst respecting the environment and saving you money.

Sorting the laundry

- It is recommended you wash only items which are machine washable with water and detergent and not dry-clean items.
- If you need to wash rugs, bedspreads or other heavy items, it is best not to spin them.
- Sort the laundry according to fabric type, degree of soiling and wash temperature: Always follow the wash care advice on the garment label for the most suitable care and treatment of the laundry

Laundry for hot wash 

Coloured, easy-care materials   

Delicates and wool  

Wash by hand 

Items labelled with the following symbol are not suitable for machine washing:

Dry clean 

For very delicate items, such as net curtains, underwear, tights etc., you are advised to use a laundry net or wash bag.

- Woollen items must be labelled with the "Pure New Wool" symbol to be washed in the machine , and must also be labelled "non-matting" or "machine washable".
- Colour often leaks from new coloured items. This can then colour other lighter items being washed. We therefore recommend that coloured items should be washed for the first time separately.

For future washes, colourfast items can only be washed with whites up to 40°C.

Note: when sorting laundry

- check there are no metal objects in the laundry (such as paper clips, safety pins, pins, coins etc...);
- button up pillowcases, fasten zips, hook & eye fasteners, belts and long dressing gown cords;
- remove curtain hooks;
- pay close attention to the labels on items
- if you notice stubborn stains whilst sorting the laundry, remove them using a special detergent or a special stain remover.

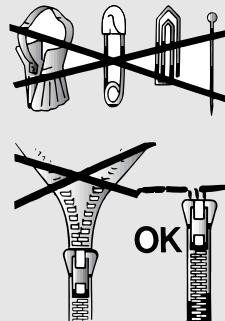

- We recommend that you do not do a full load of towelling items only as these become too heavy since they absorb a lot of water.

The correct way to wash

Preparing the laundry

A) Select the laundry.

Loading the laundry

B) Open the porthole.

C) Put the laundry in the washing machine.

Close the porthole again, ensuring that no items of laundry are obstructing the lock.

Putting detergent in machine

D) Open the drawer, choose the detergent and put in the correct amount, according to the manufacturer's instructions and the advice on page 16.

Add any other laundry aids (see page 16). Close the drawer again.

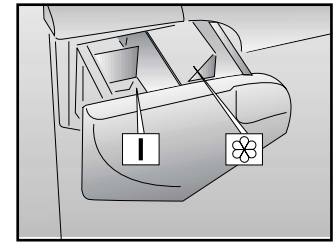
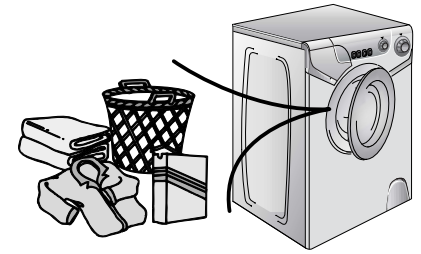

Selecting the wash programme

Note: when setting the programme, make sure that the on/off button is not pressed.

Refer to the programme guide or the programme descriptions on the machine to select the most suitable programme.

The programme is selected by turning the programme selector clockwise and aligning the programme number with the pointer. Set the temperature using the temperature control dial.

Press additional function buttons if necessary.

Press the on/off button.





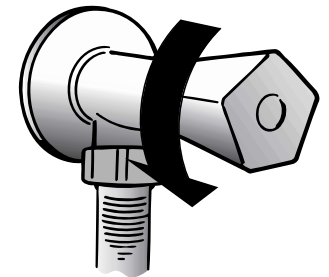











The programme starts.

Check that the tap is turned on and that the discharge hose is positioned correctly.



When the programme is finished

Wait for the door lock to be released (about 2 minutes after the programme has finished). Switch off the machine by resetting the on/off button and open the porthole by using the door open button. Remove the laundry. Turn off the tap.

FABRIC	PROGRAM FOR	WEIGHT MAX kg	SELECT PROG.	SELECT TEMP. °C	CHARGE DETERGENT	
					I	
COTTONS Cotton, linen	Whites & Prewash ¹⁾	3,5	1	Up to 90°	●	●
Cotton, mixed resistant	Whites normal	3,5	2	Up to 90°	●	●
Cotton, mixed	Fast coloured ^{*)}	3,5	3	Up to 60°	●	●
	Non fast coloured	3,5	4	Up to 40°	●	●
Cotton	Rinses	-		-		●
Cotton, linen	Last rinse	-		-		●
	Long spin	-		-		
SYNTHETICS Mixed, resistant	Mixed fabrics ^{*)}	2	5	Up to 60°	●	●
Cotton, mixed fabrics, synthetics	Coloureds	2	6	Up to 50°	●	●
Synthetics (nylon, perlon), mixed cotton	Acrylics	2	7	Up to 40°	●	●
Mixed, delicate synthetics	Rinses	-		-		●
	Last rinse	-		-		●
	Short spin	-		-		
DELICATES	Delicate wash	1,5	8	Up to 40°	●	●
	 WOOLLENS "machine washable" ^{*)}	1	9	Up to 40°	●	●
	 Hand wash	1	10	Up to 30°	●	●
Mixed, delicate synthetics, wool	Rinses	-		-		●
	Last rinse	-		-		●
	Short spin	-		-		
SPECIALS	Rapid cycle 	2	RAPID 32'	Up to 50°		
	Bleaching	3,5		-		
For fabrics that should not be spun	Water discharge	-		-		

Partners please wash heavily soiled laundry it is recommended the load is reduced to 3 kg maximum.

When washing heavily soiled laundry it is recommended the load is reduced to 3 kg maximum.

1)When pre-washing, put the detergent directly in the drum.

*) Programmes according to CENELEC EN 60456.

The variable temperature selector allows a reduction in the wash temperature. For example, an intense cottons cycle can be washed in cold water simply by moving the dial to the tap symbol.

3
MURPOAE T m u r p a e a s c m w i c e b c e
a p t i r d e
g m r m
h e i 3 2 n e
a r p o i g d r m
l l a o w
p a l s e t e
y n c g h
a e t l o
a d r r i



Detergents, washing aids and amounts to use

Choice of detergent

General purpose detergents

- **Powder detergents**, for a thorough wash, with bleaching agent, particularly suitable for use in hot wash programmes (60°C and over), for heavily soiled and stained laundry.
- **Liquid detergents**, particularly suitable for grease stains, such as greasy skin marks, cosmetics and oil.
These detergents are not suitable for washing stained laundry, as they do not contain bleach.
- **Biological detergents**, not all the products available give a really thorough wash.

Special detergents

- **Detergents for coloureds and delicates**, without added bleach, also often without any optical brightening agents, to preserve the colour.
- **Detergents for a thorough wash**, without added bleach or enzymes, particularly suitable for handling woollen fibres.
- **Detergents for curtains** with optical brightening agents, resistant to light, to prevent yellowing from sunlight.
- **Special detergents** for programmed use of chemical substances, depending on fabric type, degree of soiling and water hardness.
Here basic detergents, softeners, bleaches/stain removers can be added separately.

Additional laundry aids

- **Water softener**, means less detergent can be used where water hardness is classed as hard to very hard.
- **Prewash substances**, for the programmed treatment of stains prior to the main wash.
Using them means the subsequent wash can be at a low temperature or with bleach-free detergents.
- **Fabric softener**, prevents static build-up in synthetic fabrics and softens fabrics.
If you own a tumble dryer, clothes are softened even without the use of a fabric softener.

Do not put solvents in the washing machine!

Keep detergents and other laundry products out of children's reach.

Before pouring in the detergent check that there are no foreign bodies in the detergent drawer.

Dosage details are usually shown on the detergent packaging. Follow those instructions.

Dosages

Only use detergents which are suitable for use in a washing machine.

You will obtain the best results from your wash with the minimum use of chemical products and the best care for your laundry if you take into consideration the degree of soiling as well as the type of detergent to choose.

The amount of detergent to use depends on:

- water hardness: depending on the hardness of the water and the type of detergent used, it is possible to reduce the amount of detergent.
- the degree of soiling: it is possible to reduce the amount of detergent used depending on the degree of soiling.
- amount of laundry: it is possible to reduce the amount of detergent when washing only a small amount of laundry.

Dosage for powder detergent

For normal and low concentration detergents: for normally soiled laundry choose a programme without prewash.

Put the detergent in compartment "I" of the drawer.

For heavily soiled laundry, choose the prewash programme before the main wash.

When using water softeners, first put in the detergent, then add the softener to compartment "I".

For highly concentrated detergents not in single dose format, follow what is shown on pack exactly as regards type and amount of dosage.

To avoid the difficulty of checking if the detergent has been taken up, use the dosage aids provided in the detergent packaging.

Liquid detergent dosage

Liquid detergents may be used in accordance with the instructions on the relevant packaging, for all programmes without prewash, by using the special container which is placed in the drum or, for those models that have it, in the special insert for liquid detergents.

Cleaning and routine maintenance

Do not use alcohol-based scourers and /or thinners on the outside of your washing machine, just a wipe with a damp cloth will suffice. The washing machine needs very little maintenance:

- Cleaning the drawer compartments.
- Cleaning the filter.

Cleaning the drawer compartments

Even if it is not strictly necessary, it is good to clean the compartments for bleaching detergents and additives occasionally.

- To do this you just need to pull them out firmly, but without forcing them.
- Clean everything in the compartment under running water.
- Put everything back in its proper place.

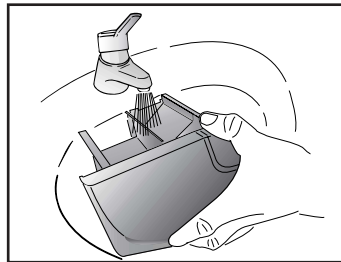

Cleaning the filter

The washing machine is fitted with a special filter for handling large deposits which could block the discharge hose (coins, buttons etc.) and which can, therefore, be easily retrieved.

We recommend that the filter be cleaned at least once a month.

The cleaning operation is as follows:

- Open the lid as shown in picture.
- Turn the filter anti-clockwise until it stops in the vertical position. Remove and clean.
- After cleaning, replace by turning the notch on the end of the filter clockwise. Then follow all procedures described above in reverse order.
- Close the lid.

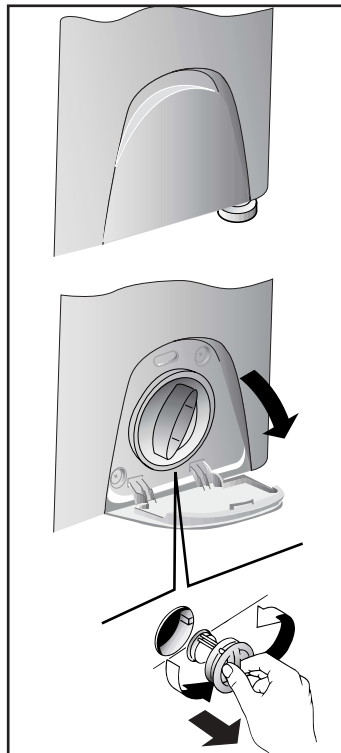

Attention: if the filter needs cleaning while there is washing still in the drum, follow the instructions on the following page to empty the water. This will prevent excessive loss of water via the filter.

Transporting the appliance or long periods when appliance is not in use

If the appliance is being transported or is out of use for long periods in unheated places, all remaining water must be completely removed from the hoses.

Ensure mains power is off, then unclip the hose and point it downwards into a basin until all the water has emptied out.

When finished, repeat the operation in the reverse order.

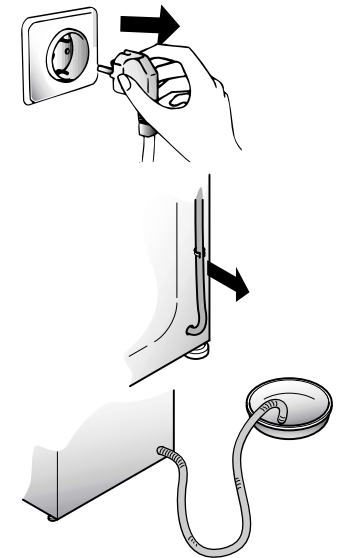

Investigating malfunctions

What might be the cause of...
Defects you can remedy yourself

MALFUNCTION	CAUSE	REMEDY
1. Does not work on any programme	Plug not in socket. Not switched on. Power failure. Fuse blown. Door open.	Plug it in. Switch on. Check. Check. Close door.
2. Does not fill with water	See cause 1. Tap turned off. Programme selector not correctly positioned.	Check. Turn on tap. Position programme selector correctly.
3. Water does not drain away	Kink in discharge hose. Foreign bodies in filter	Straighten discharge hose. Examine filter (see pages 18-19)
4. Water on floor around the washing machine	Leaking gasket between tap and water inlet hose.	Replace gasket and tighten hose and tap well.
5. Does not spin	Water has not yet drained away. "No spin" selected (certain models only).	Wait a few minutes for machine to empty. Reset button or turn "no spin" knob.
6. Machine vibrates a lot during spin	Washing machine not completely level. Transit brackets not removed yet. Load not distributed evenly.	Adjust the special adjustable feet. Remove transit brackets. Rearrange the laundry evenly.
7. Door will not open	Two minutes have not elapsed since the programme finished.	Wait two minutes.

Please note:

It is normal for the programme selector dial to move only from one stage of washing programme to another and not show any movement in-between – so at certain periods, the dial will stay still.
An electronic device is controlling the exact movement of the timer.

The machine makes a different noise when spinning! This is because it has a manifold motor for better performance.

Only a small level of water can be seen in the drum! This is because new machines do not use much water, yet achieve the same standard of washing and rinsing.

Note:

The use of environmentally-friendly, phosphate-free detergents can have the following effects:

- waste water from rinsing may be cloudier because of the presence of zeolites held in suspension, without the rinse performance being adversely affected;
- presence of white powder (zeolites) on laundry after washing, which is not absorbed by the fabric and does not alter the colour of the fabric.
- The presence of foam in the final rinsing water is not necessarily an indication of poor rinsing.
- Anionic surfactants used in washing detergent formulae often prove to be difficult to remove from the laundry itself and, even in small quantities, can still cause considerable foam production.
- Carrying out more rinse cycles does not serve any purpose in such cases.

CUSTOMER SERVICE AND GUARANTEE

Your new appliance is fully guaranteed by the manufacturer for 12 months against electrical/mechanical breakdown excluding:

- A.** Any faults which occur due to bad installation or misuse of the machine.
- B.** Any faults which occur due to repair of, or interference with, the machine by any person not authorised by the manufacturer to carry out service.
- C.** Any faults which arise from parts fitted to the machine which are not the manufacturers original parts.
- D.** Any faults arising from non-domestic use or unusual or abnormal use of the machine.
- E.** Any faults arising from operation at an incorrect voltage.
- F.** Any faults arising from incorrect operation of the machine.

The guarantee applies to Gt. Britain and Northern Ireland only, and is an addition to your statutory rights.

After Sales Service

If, having investigated the possible malfunctions on the chart on the previous page, you believe the appliance is not working correctly, please call our After Sales Service dept. on telephone number 08705 990011

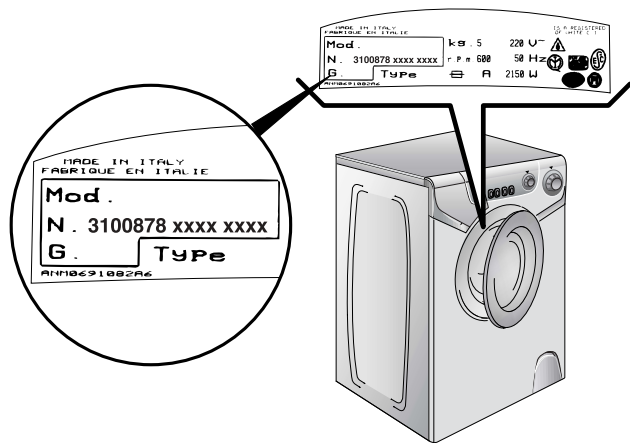

Fig. 2

Technical data

- Max. load of dry laundry
- Water pressure

- Spin speed

Measurements

- Width
- Depth
- Height

3,5 kg

0,05 ÷ 0,8 MPa
1000 rpm

51 cm
43 cm
70 cm

NB: For specifications regarding electrical data, see the data panel on the front of the washing machine (porthole area) - as shown in diagram above.

CE EC Appliance complies with European Directive 89/336/EEC, 73/23/EEC and subsequent amendments.

SETTING UP + INSTALLATION

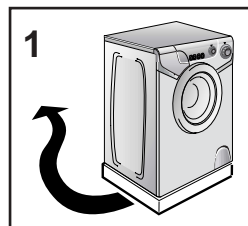

Remove the polystyrene base and place the machine near its permanent position (diagram 1).

Carefully cut through the hose retaining clip at the rear of the appliance (diagram 2).

Unscrews the two top screws **A** and remove the cover, sliding it off horizontally (diagram 3).

Remove the cardboard protection.

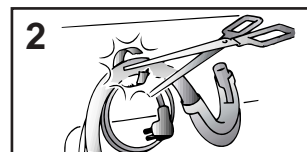

Unscrews the two tie braces **B** on the crosspiece (with an H. 19 spanner) and remove the polystyrene spacers under it (diagram 4).

Please do not fit the 2 tie braces **B** again!

IMPORTANT: DO NOT REMOVE THE SPACERS ABOVE THE CROSSPIECE.

Replace the cover with the two screws **A**.

Please ensure when fitting the table top the locating pins are inserted correctly in their slots, positioned on the side of the cabinet as shown in the diagram 5.

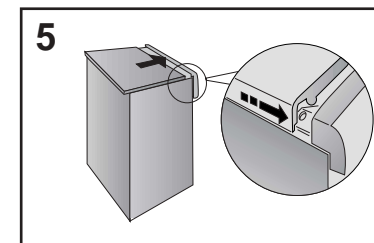
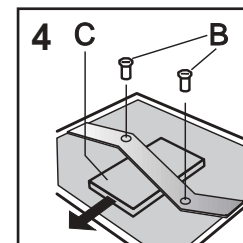
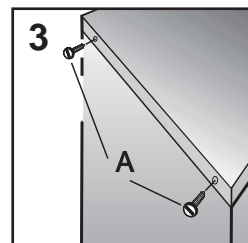

WARNING:
DO NOT LEAVE THE PACKAGING WITHIN REACH OF CHILDREN AS IT IS A POTENTIAL SOURCE OF DANGER.

Apply the insulation sheet of corrugated material to the base as shown in the relevant diagram.

Level the machine by means of the front feet.

- a) Turn the nut clockwise to release the screw adjuster on the foot.
- b) Rotate the foot to raise or lower it until it stands firmly on the ground.
- c) Lock the foot in position by turning the nut anti-clockwise until it comes up against the bottom of the machine.

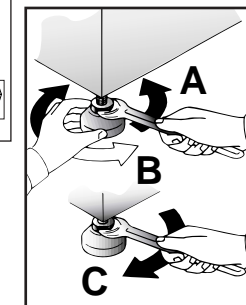
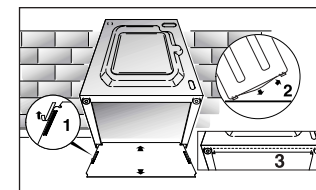

Note: we recommend you keep the transit bracket, braces and screws to immobilise the machine for future transit.

The Manufacturers will not be responsible for any possible damage to the machine caused by not following the rules relating to releasing the mechanism. The user is responsible for all costs of installation.

Water connection

The machine has an inlet hose with 3/4» threaded ferrules fitted to the ends to attach between the threaded connector on the appliance and the cold water supply.

The appliance must be connected to the water mains using new hose-sets. The old hose-sets should not be reused.

The appliance must only be connected to the cold water supply. Connection to a warm water supply, that is over 40°C, may damage certain delicate fabrics.

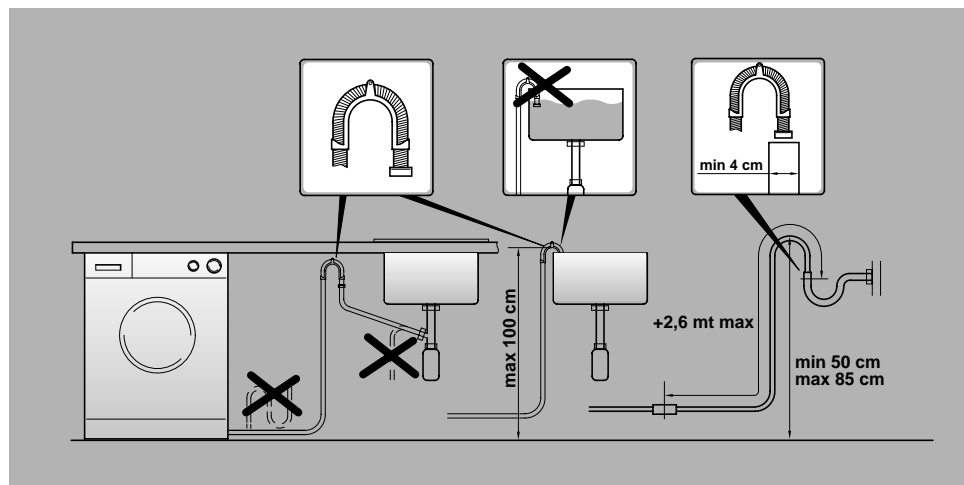
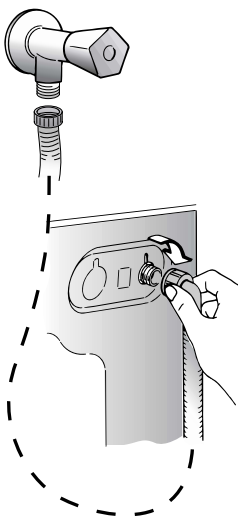

Note: it is advisable to turn off the tap after each wash to isolate the washing machine from the water supply.

For the washing machine to function properly the terminal end of the discharge hose (mouth) must be at a minimum of 50 cm and a maximum of 85 cm from the ground.

ELECTRICAL CONNECTIONS

Washing machines are supplied to operate at a voltage of 230 V, 50 Hz single-phase. Check that the conductor is powerful enough to supply at least 3.0 kW, then connect the plug to a 10 A earthed socket.

After installation, the appliance must be positioned so that the plug is accessible.

Check that the electricity supply to your home has an earthing system.

The socket in your home and the plug on the appliance must be of the same type.

It is generally not advisable to use multiple adapters and/or extension leads.

All **Candy** washing machines comply with the safety requirements laid down by the Quality Trademark Institute.

NOTES

A series of horizontal dotted lines for writing notes on page 26.

A series of horizontal dotted lines for writing notes on page 27.

Lined writing area on page 28.

Lined writing area on page 29.

Lined writing area with horizontal dotted lines.

The manufacturer declines all responsibility in the event of any printing mistakes in this booklet. The manufacturer also reserves the right to make appropriate modifications to its products without changing the essential characteristics.

CANDY



EN

04.03 - 41010569 - Printed in Italy - Imprimé en Italie

Free Manuals Download Website

<http://myh66.com>

<http://usermanuals.us>

<http://www.somanuals.com>

<http://www.4manuals.cc>

<http://www.manual-lib.com>

<http://www.404manual.com>

<http://www.luxmanual.com>

<http://aubethermostatmanual.com>

Golf course search by state

<http://golfingnear.com>

Email search by domain

<http://emailbydomain.com>

Auto manuals search

<http://auto.somanuals.com>

TV manuals search

<http://tv.somanuals.com>