



How to Use This Manual Printing This Manual

MP260 series

On-screen Manual

MC-2746-V1.00



Basic Guide

Describes the summary of this product.



Advanced Guide

Describes the detailed function of this product.



Troubleshooting



Contents

❖ Overview of the Machine

Main Components
LED Display and Basic Operations

❖ Printing from a Memory Card (MP260 series)

Printing Photos Saved on the Memory Card
Inserting the Memory Card
Setting the Language for the Photo Index Sheet

❖ Copying

Copying Documents
Copying Photos
Fit-to-Page Copying

❖ Scanning

Saving Scanned Data

❖ Printing from Your Computer

Printing Photos (Easy-PhotoPrint EX)
Printing Documents (Windows)
Printing Documents (Macintosh)

❖ Other Usages

Printing Photos from a PictBridge Compliant Device (MP240 series)
Solution Menu and My Printer

❖ Loading Paper / Originals

Loading Paper
Loading Originals to Copy or Scan

❖ Routine Maintenance

When Printing Becomes Faint or Colors Are Incorrect
Replacing a FINE Cartridge
Cleaning the Machine

❖ Appendix

Safety Precautions
Legal Limitations on Use of Your Product and Use of Images
Tips on How to Use Your Machine

Overview of the Machine

This section shows the component names of the machine and describes the basic operations you need to know before using it.

Main Components

[Front View](#)

[Rear View](#)

[Inside View](#)

[Operation Panel](#)

LED Display and Basic Operations



[↑ Page top](#)

Main Components

■ Front View

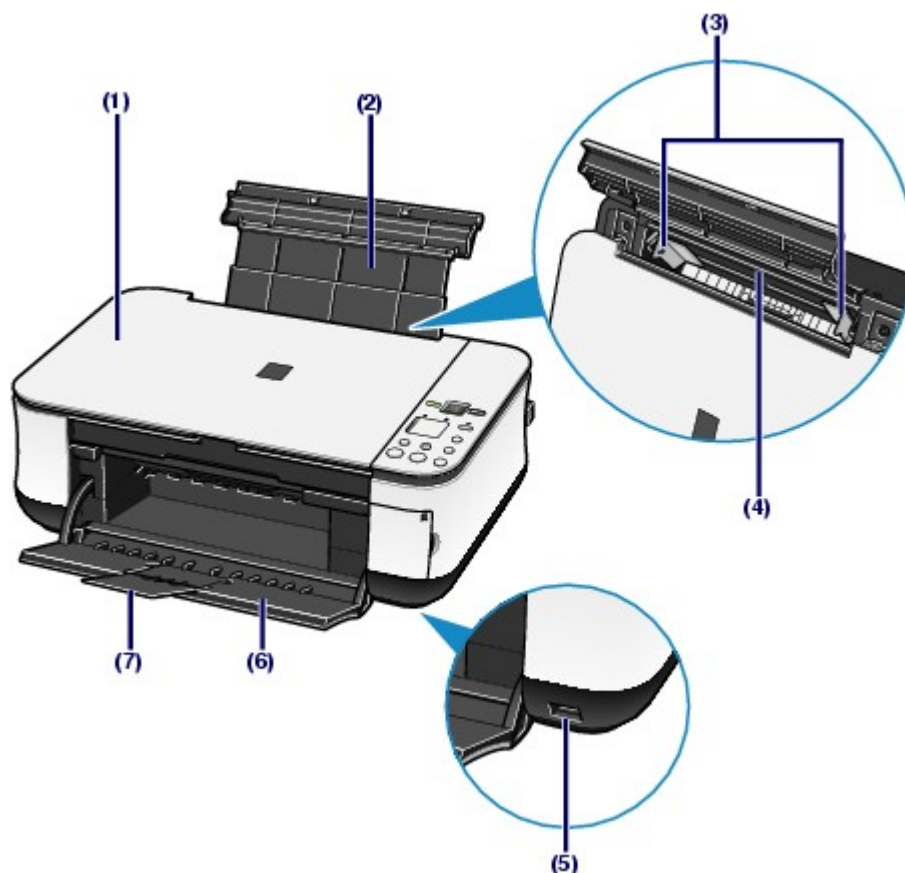

(1) Document Cover

Open to load an original on the Platen Glass.

(2) Paper Support

Raise and tip back to load paper in the Rear Tray.

(3) Paper Guides

Slide to align with both sides of the paper stack.

(4) Rear Tray

Load various sizes or types of paper which you can use on the machine. Two or more sheets of the same size and type of paper can be loaded at the same time, and fed automatically one sheet at a time.

(5) Direct Print Port (MP240 series)

Connect a PictBridge compliant device such as a digital camera when printing directly.

See [Printing Photos from a PictBridge Compliant Device \(MP240 series\)](#).

Warning

- Do not connect any equipment other than PictBridge compliant devices to the Direct Print Port of the machine. This may cause fire, electric shock, or damage to the machine.

Caution

- Do not touch the metal casing.

(6) Paper Output Tray

Opens automatically when printing or copying starts and printed papers are ejected.

(7) Output Tray Extension

Open to support the printouts. Open it when printing or copying.

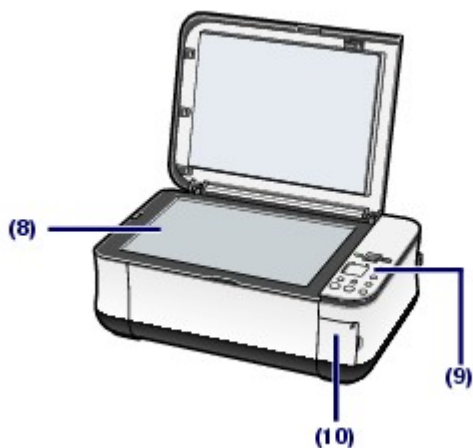

(8) Platen Glass

Load an original to copy or scan.

(9) Operation Panel

Use to change the settings of the machine or to operate it.

See [Operation Panel](#).



Note

- The LED and lamps on the Operation Panel other than the **Power** lamp will go out if the machine is not operated for about 5 minutes. To restore them, press any button except the **ON** button or perform the print operation.

(10) Card Slot Cover (MP260 series)

Open to insert a memory card.

See [Inserting the Memory Card](#).

■ Rear View



(11) USB Port

Plug in the USB cable to connect the machine with a computer.



Caution

- Do not touch the metal casing.



Important

- Do not plug in or unplug the USB cable while the machine is printing from or scanning originals to the computer, or the computer is in the sleep mode or standby mode.

(12) Power Cord Connector

Plug in the supplied power cord.

■ Inside View

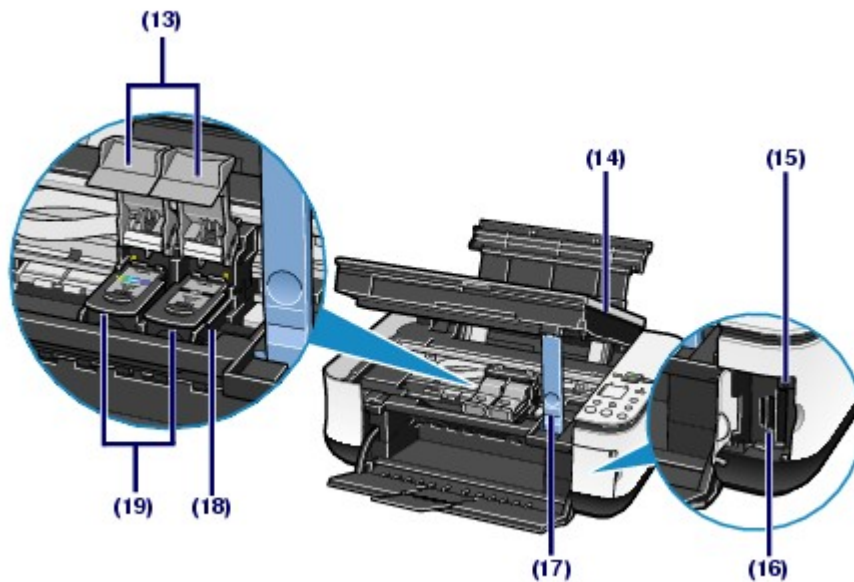

(13) Ink Cartridge Locking Covers

Locks the FINE Cartridges into place.

(14) Scanning Unit (Cover)

Scans originals. Open it to replace the FINE Cartridges or remove jammed paper inside the machine. When opening the Scanning Unit (Cover), lift it with the Document Cover closed.

(15) Access lamp (MP260 series)

Lights or flashes to indicate the memory card status.

See [Inserting the Memory Card](#).

(16) Card Slot (MP260 series)

Insert a memory card.

See [Inserting the Memory Card](#).

(17) Scanning Unit Support

Holds the Scanning Unit (Cover) being opened.

(18) FINE Cartridge Holder

Install the FINE Cartridges.

The Color FINE Cartridge should be installed into the left slot and the Black FINE Cartridge should be installed into the right slot.

(19) FINE Cartridges (Ink Cartridges)

A replaceable cartridge that is integrated with Print Head and ink tank.



Note

- For details on installing the FINE Cartridges, refer to the printed manual: Getting Started.



Important

- The area (A) indicated in the figure below may be splattered with ink. It does not affect the performance of the machine.
- Do not touch the area (A). The machine may not print properly if you touch it.

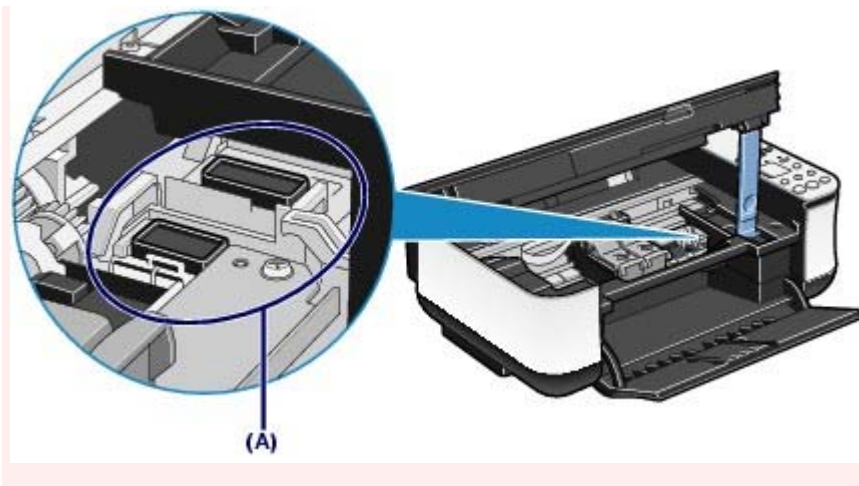

■ Operation Panel

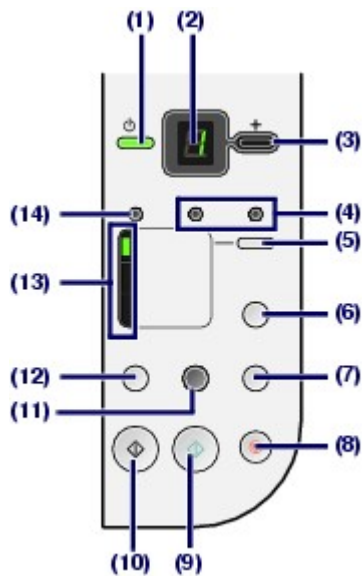

(1) ON button / Power lamp

Turns the power on or off. Before turning on the power, make sure that the Document Cover is closed.



Note

Power and Alarm lamps

- You can check the status of the machine with the **Power** lamp and **Alarm** lamp.
 - **Power** lamp Off: The power is off.
 - **Power** lamp lit green: The machine is ready to print.
 - **Power** lamp flashing green: The machine is initializing or shutting down.
 - **Alarm** lamp lit or flashing orange: An error has occurred and the machine is not ready to print. For details, refer to the "[Troubleshooting](#)" in the on-screen manual: *Advanced Guide*.
 - **Power** lamp flashes green once and **Alarm** lamp flashes orange once alternately: An error that requires contacting your Canon service representative may have occurred. For details, refer to the "[Troubleshooting](#)" in the on-screen manual: *Advanced Guide*.



Important

Disconnecting the power plug

- When disconnecting the power plug after turning off the power, be sure to confirm that the **Power** lamp is not lit. If the power plug is disconnected from the wall outlet while the **Power** lamp is lit or flashing, the machine may become unable to print since the Print Head is not protected.

(2) LED (Light Emitting Diode)

Displays the number of copies, Maintenance menu code, or operational status such as an error code.

(3) [+] button

Specifies the number of copies.

(4) Ink lamps

Lights or flashes orange when ink runs out, etc. The lamp on the left indicates the Color FINE Cartridge status and the lamp on the right indicates the Black FINE Cartridge status.

(5) Paper button

Switches the page size and media type.

(6) Photo Index Sheet button (MP260 series)

Prints the Photo Index Sheet or starts scanning the Photo Index Sheet to print selected photos on the memory card.

(7) SCAN button

Starts scanning an original to save it on the memory card (MP260 series) or the computer.

(8) Stop/Reset button

Cancels operations. You can also press this button to cancel operation when a print job is in progress.

(9) Color button*

Starts color copying. You can also press this button to finalize your selection for the menu or setting item.

(10) Black button*

Starts black & white copying. You can also press this button to finalize your selection for the menu or setting item.

(11) Fit to Page button / Fit to Page lamp

Enables the Fit-to-Page copy function. You can copy an original automatically enlarged or reduced to fit the selected page size. When the Fit-to-Page copy function is disabled, you can make copies in the same size as an original.

(12)  (Maintenance) button

Accesses the Maintenance menu.

(13) Paper lamp

Lights to indicate the selected page size and media type.

(14) Alarm lamp

Lights or flashes orange when an error, such as paper-out or ink-out, occurs.

* In the software applications or manuals, the **Black** and **Color** buttons are collectively called the "**Start**" or "**OK**" button.



 [Page top](#)



LED Display and Basic Operations

You can use the machine to make copies or print out without a computer. This section describes the LED display and basic operations on the Operation Panel.

The number **1** appears on the LED normally when turning on the power.



The LED display indicates the machine status as follows.

Machine Status	LED Display
While copying	Number of copies (flashing)
While printing, scanning, or performing maintenance operations	 (flashing in order)
When an error occurs	<ul style="list-style-type: none"> ● E and number appear alternately. For details on the error codes, refer to the "Troubleshooting" in the on-screen manual: <i>Advanced Guide</i>. ● P and number appear alternately. An error that requires contacting your Canon service representative may have occurred. For details, refer to the "Troubleshooting" in the on-screen manual: <i>Advanced Guide</i>.
While the Scanning Unit (Cover) is open	 (flashing)

Note

- When a PictBridge compliant device such as a digital camera is connected to the machine, **C** appears on the LED (MP240 series).

● Number of Copies

When copying starts, the specified number of copies appears on the LED. While copying is in progress, the number on the LED is flashing and reduced by one to indicate the remaining number of copies to be made.



Each time you press the [+] button, the number on the LED increases by one. When **F** appears, the number of copies is set to "20". Press the [+] button again to return to "1".





● Maintenance Codes

To perform maintenance of the machine, press the  (Maintenance) button repeatedly until the desired code appears on the LED, and then press the **Black** or **Color** button.

Maintenance Code	Operation	See
	Prints the nozzle check pattern.	Printing the Nozzle Check Pattern
	Cleans the Print Head.	Cleaning the Print Head
	Cleans the Print Head deeply.	Cleaning the Print Head Deeply
	Prints the print head alignment sheet.	Aligning the Print Head
	Scans the print head alignment sheet.	Aligning the Print Head
	Prints the current head position adjustment values.	Aligning the Print Head
	Cleans the Paper Feed Roller.	Cleaning the Paper Feed Roller
	Cleans the inside of the machine.	Cleaning the Inside of the Machine (Bottom Plate Cleaning)
	Switches the size of paper loaded in the Rear Tray between A4 and 8.5" x 11" (Letter). (This setting is used for making copies.)	Switching the Page Size between A4 or 8.5" x 11" (Letter)
	Sets the machine to prevent paper abrasion.	Refer to the "Paper is Smudged/Printed Surface is Scratched" in the "Troubleshooting" of the on-screen manual: <i>Advanced Guide</i> .
	Selects the read/write attribute of the Card Slot (MP260 series).	Setting the Read/Write Attribute of the Card Slot
	Prints the Language Selection Sheet for the Photo Index Sheet (MP260 series).	Setting the Language for the Photo Index Sheet
	Scans the Language Selection Sheet for the Photo Index Sheet (MP260 series).	Setting the Language for the Photo Index Sheet

● Error Codes

When an error occurs, **E** and number appear alternately on the LED to indicate the error code.

Error Code	LED Display
E + 1-digit number	 (flashing in order)
E + 2-digit number	 (flashing in order)



Note

- For details on the error codes, refer to the "Troubleshooting" in the on-screen manual: *Advanced Guide*.
- If an error code with **P** appears, an error that requires contacting your Canon service representative may have occurred. For details, refer to the "Troubleshooting" in the on-screen manual: *Advanced Guide*.



[↑ Page top](#)

Printing from a Memory Card (MP260 series)

You can print thumbnails of photos saved on the memory card on A4 or Letter-sized paper and select photos to print.

Printing Photos Saved on the Memory Card

Inserting the Memory Card

- [Before Inserting the Memory Card](#)

- [Inserting the Memory Card](#)

- [Removing the Memory Card](#)

- [Setting the Read/Write Attribute of the Card Slot](#)

Setting the Language for the Photo Index Sheet



[↑ Page top](#)

Printing Photos Saved on the Memory Card

Thumbnails of photos on the memory card are printed on A4 or Letter-sized paper (this printed sheet is called Photo Index Sheet). You can select photos, number of copies, page size, etc. on this sheet, and print them.

For the operation, see the notes and operation procedure described in the reference page.



You need to prepare:

A memory card on which photos are saved. See [Before Inserting the Memory Card](#).



A4 or Letter-sized plain paper for printing the Photo Index Sheet.

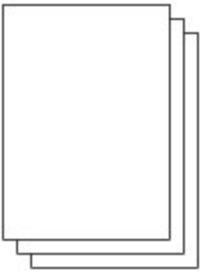

Paper for printing. See [Media Types You Can Use](#).

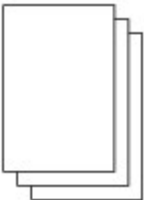

1. Prepare for printing.

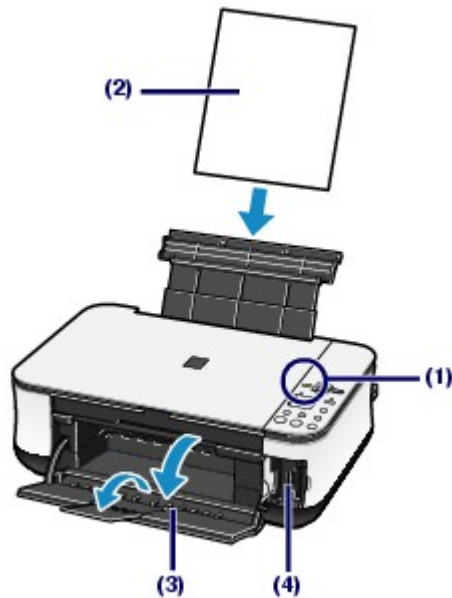

(1) Turn on the power.

See [Operation Panel](#).

(2) Load two or more sheets of A4 or Letter-sized plain paper in the Rear Tray.

See [Loading Paper](#).



Note

- If there are more than 30 photos on the memory card, two or more Photo Index Sheets will be printed.

(3) Open the Paper Output Tray gently, and open the Output Tray Extension.

(4) Insert a memory card into the Card Slot.

For the types of memory cards you can use and the locations to insert them, see [Inserting the Memory Card](#)



Important

- Do not remove the memory card until printing with the Photo Index Sheet is completed.



Note

- When the read/write attribute of the Card Slot is set to the "Writable from PC" mode, you cannot print photos on a memory card with the Photo Index Sheet. Set the read/write attribute to the "Not writable from PC" mode. See [Setting the Read/Write Attribute of the Card Slot](#).

2. Make sure that no original is left on the Platen Glass, and press the **Photo Index Sheet** button to start printing the Photo Index Sheet.

The Photo Index Sheet(s) will be printed.

Thumbnails of all photos saved on the memory card are printed in order from the latest photo first.



Important

- Depending on the country or region of purchase, the Language Selection Sheet will be printed when you press the **Photo Index Sheet** button if the language for the Photo Index Sheet has not been selected. To set the language used to print the Photo Index Sheet, follow the procedures from step 4 onwards in [Setting the Language for the Photo Index Sheet](#).



Note

- To cancel printing, press the **Stop/Reset** button.

3. Fill in the appropriate circles on the Photo Index Sheet.

Fill in the appropriate circles with a dark pencil or a black ink pen to select photos to print and the print settings.

● Good



● Bad



(A)



(B)



(C)

(A) Check mark

(B) Line only

(C) Too light

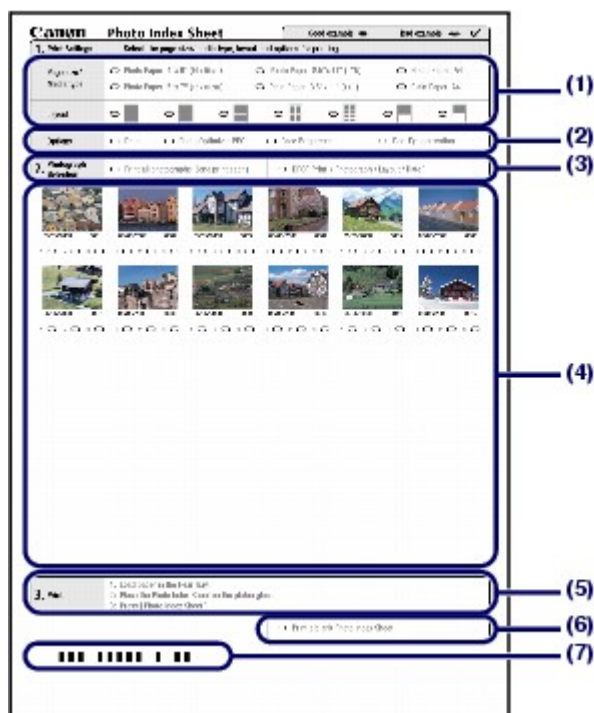

(1) Select the page size, media type, and layout.



Note

- When printing photos using the Photo Index Sheet, you can select 4" x 6" (10 x 15 cm), 5" x 7" (13 x 18 cm), 8.5" x 11" (LTR), or A4 for the page size.
- When you select Plain Paper 8.5" x 11" (LTR) or Plain Paper A4 in Page size/Media type, photos are printed with borders even if you select the borderless print in Layout.

(2) Select Date / Photo Optimizer PRO / Face Brightener / Red-Eye correction as necessary.

(3) Fill in the circle of Print all photographs to print a copy of all photos.

* If you filled in this circle, any other circles you have filled in for the number of copies to print for each photo will be disregarded, and only one copy each of all photos will be printed.

Fill in the circle of DPOF Print to print according to the DPOF settings on the digital camera, such as photos to print, date, and layout settings.

* You can specify the Standard Print, Multi-Image Print, or Index Print in the DPOF settings. Available layouts or image correction options are different depending on each print setting. For details, refer to the on-screen manual: [Advanced Guide](#).

(4) Select the number of copies (fill in a circle under each photo to print).

(5) Confirm and follow the described printing procedure.

(6) Fill in this circle to print the same Photo Index Sheet again.

* If you filled in this circle, all other settings will be disregarded.

(7) Be sure not to stain the bar-code.

* If the bar-code gets stained or wrinkled, the Photo Index Sheet may not be scanned properly.

Important

- Be sure to fill in a circle for every setting item except options.
- If there are two or more Photo Index Sheets, fill in all the sheets.
- If the filled circles on the Photo Index Sheet are not dark enough, the machine may not scan the settings.

4. Scan the Photo Index Sheet, and print photos.

(1) Load paper.

See [Loading Paper](#).

Make sure that the page size and media type of the loaded paper match those specified on the Photo Index Sheet.

(2) Place the Photo Index Sheet on the Platen Glass.

Place the Photo Index Sheet with the filled-in side **FACING DOWN** and align the sheet with the alignment mark as shown below.

Then close the Document Cover gently.



(3) Press the **Photo Index Sheet** button.

The Photo Index Sheet is scanned and the specified photos will be printed.

Important

- Do not open the Document Cover or move the loaded Photo Index Sheet until scanning is completed.
- Be careful not to get the Photo Index Sheet dirty. If the Photo Index Sheet is stained or wrinkled, it may not be scanned properly.
- If the error code "E, 3, 2" or "E, 3, 3" appears on the LED, confirm the following.
 - The Platen Glass and the Photo Index Sheet are not dirty.
 - The Photo Index Sheet is placed in the correct position with the filled-in side facing down.
 - You have filled in all the necessary circles on the sheet.
 - Only one option is selected for items that do not accept two or more selections.
 - The filled circles are dark enough.
- For details, refer to the "[Troubleshooting](#)" in the on-screen manual: *Advanced Guide*.
- If you selected to print according to the DPOF settings but there is no DPOF information on the memory card, the error code "E, 3, 4" will appear on the LED. For details, refer to the "[Troubleshooting](#)" in the on-screen manual: *Advanced Guide*.
- Do not remove the memory card until printing is completed.

Note

- To cancel printing, press the **Stop/Reset** button.
- To continue to print photos using subsequent Photo Index Sheets, repeat the procedure from step 3.
- If the memory card has been removed and then reinserted before printing photos with the Photo Index Sheet, it may take some time before printing starts.
- To remove the memory card after printing is completed, see [Removing the Memory Card](#).



[↑ Page top](#)

Inserting the Memory Card



■ Before Inserting the Memory Card

The following types of memory cards and image data are compatible with the machine.

● Important

- If you took and saved photos on a type of memory card that is not guaranteed operation to be used on your digital camera, the image data may be unreadable on the machine or damaged. For information on memory cards that your digital camera guarantees operation, refer to the instruction manual supplied with your digital camera.
- Format the memory card with a digital camera compliant with DCF ver. 1.0/2.0 standard. The memory card may not be usable with the machine if it is formatted on a computer.





● Memory Cards that Do Not Require a Card Adapter

	<ul style="list-style-type: none"> ● SD Secure Digital memory card ● SDHC memory card ● MultiMediaCard (ver.4.1) ● MultiMediaCard Plus (ver.4.1)
	<ul style="list-style-type: none"> ● Compact Flash (CF) Card Supports Type I/II (3.3 V) ● Microdrive
	<ul style="list-style-type: none"> ● Memory Stick ● Memory Stick PRO ● Memory Stick Duo ● Memory Stick PRO Duo

● Memory Cards that Require a Card Adapter

● Important

- Be sure to attach the special card adapters to the following memory cards before inserting to the Card Slot.
If one of the following memory cards is inserted without the card adapter, you may not be able to remove the memory card. In this case, refer to the " [Troubleshooting](#) " in the on-screen manual: *Advanced Guide*.

	<ul style="list-style-type: none"> ● miniSD Card *1 ● miniSDHC Card *1
	<ul style="list-style-type: none"> ● microSD Card *1 ● microSDHC Card *1
	<ul style="list-style-type: none"> ● xD-Picture Card *2 ● xD-Picture Card Type M *2 ● xD-Picture Card Type H *2
	<ul style="list-style-type: none"> ● RS-MMC (ver.4.1) *3
	<ul style="list-style-type: none"> ● Memory Stick Micro *4

*1 Use the special "SD Card Adapter".

*2 Requires purchase of a separate compact flash card adapter for xD-Picture Card.

*3 Use the special card adapter.

*4 Use the special "Memory Stick Micro Duo size Adapter".

● Printable Image Data

This machine supports images created by DCF ver. 1.0/2.0 standard compliant digital cameras (Exif ver. 2.2/2.21 compliant, including TIFF etc.). Other image or movie types such as RAW images cannot be printed.

■ Inserting the Memory Card



Note

- When the read/write attribute of the Card Slot is set to the "Writable from PC" mode on the Maintenance menu, you cannot print photos on a memory card with the Photo Index Sheet. After using the Card Slot as the memory card drive of a computer, remove the memory card and be sure to set the read/write attribute to the "Not writable from PC" mode. See [Setting the Read/Write Attribute of the Card Slot](#).
- When you use a computer to edit or enhance photos saved on a memory card, be sure to print them from the computer. If you print the photos with the Photo Index Sheet, they may not be printed properly.

1. Prepare your memory card.

Attach a special card adapter if your memory card requires one.

See [Memory Cards that Require a Card Adapter](#).

2. Turn on the power, and open the Card Slot Cover.



3. Insert only one memory card into the Card Slot.

The location to insert a memory card varies depending on each type of memory card. Insert your memory card straightforward WITH THE LABELED SIDE FACING TO THE LEFT into the Card Slot, according to the insert location in the figure below.

When the memory card is inserted properly, the **Access** lamp (A) will light up.

Be sure to attach the card adapter to the memory card with the mark * (asterisk) below, and then insert it into the Card Slot.

For Memory Stick Duo, Memory Stick PRO Duo, or Memory Stick Micro*:

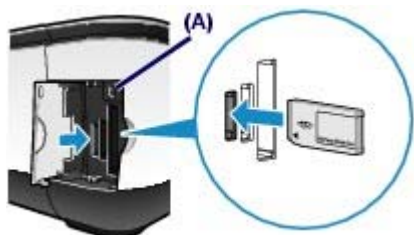

For SD Secure Digital memory card, SDHC memory card, miniSD Card*, miniSDHC Card*, microSD Card*, microSDHC Card*, Memory Stick, Memory Stick PRO, MultiMediaCard (ver.4.1), MultiMediaCard Plus (ver.4.1), or RS-MMC (ver.4.1)*:

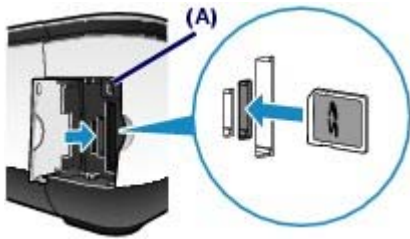

For Compact Flash (CF), Microdrive, or xD-Picture Card*, xD-Picture Card Type M*, xD-Picture Card Type H*:

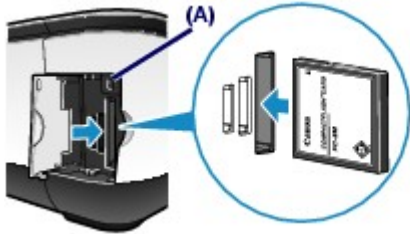

Caution

- Part of the memory card will stick out of the Card Slot, but do not force it into the slot any further. This can damage the machine or the memory card.
- Make sure that the memory card is correctly oriented before inserting it into the Card Slot. If you force the memory card into the Card Slot in the wrong orientation, the memory card or the machine can be damaged.

Important

- Do not insert more than one memory card at a time.

4. Close the Card Slot Cover.

■ Removing the Memory Card

Important

- If you used the Card Slot as the memory card drive of a computer, you must perform the "safe removal" operation on your computer before physically removing the memory card from the machine.
 - In Windows, right-click the removable disk icon and click **Eject**. If **Eject** does not appear on the screen, make sure that the **Access** lamp is not flashing, and then remove the memory card.
 - In Macintosh, drag  (Mount drive) into the Trash.

1. Open the Card Slot Cover.

2. Make sure that the **Access** lamp is lit, and remove the memory card.

Hold the part of the memory card that is sticking out and remove it from the machine straightforward.

Caution

- Do not remove the memory card while the **Access** lamp is flashing. The **Access** lamp flashes while the machine is reading or writing data from/to the memory card. If you remove the memory card or turn off the power while the **Access** lamp is flashing, the data saved on the memory card can be damaged.

3. Close the Card Slot Cover.

■ Setting the Read/Write Attribute of the Card Slot

1. Press the  (Maintenance) button repeatedly until **c** appears.



2. Set the read/write attribute.

To select the "Not writable from PC" mode

Press the **Color** button.

To select the "Writable from PC" mode

Press the **Black** button.



Note

- Remove a memory card from the Card Slot of the machine before setting the read/write attribute. You cannot set the read/write attribute when a memory card is inserted.
- When the read/write attribute is set to the "Writable from PC" mode, you cannot print photos on a memory card with the Photo Index Sheet.



[↑ Page top](#)

Setting the Language for the Photo Index Sheet

You can select a language for the Photo Index Sheet that is used to print photos saved on a memory card.

Note

- Depending on the country or region of purchase, the Language Selection Sheet will be printed when you press the **Photo Index Sheet** button if the language for the Photo Index Sheet has not been selected. In this case, follow the procedures from step 4 onwards.

You need to prepare: A4 or Letter-sized plain paper and a memory card on which photos are saved

- Make sure that the power is turned on, and load two or more sheets of A4 or Letter-sized plain paper in the Rear Tray.
- Open the Paper Output Tray gently, and open the Output Tray Extension.
- Print the Language Selection Sheet.
 - Make sure that the memory card is inserted.

Note

- Do not remove the memory card until all the operations are completed.

- Press the  (Maintenance) button repeatedly until **h** appears.



- Press the **Black** or **Color** button.
The Language Selection Sheet will be printed.

- Fill in the circle of a desired language used to print the Photo Index Sheet.

Fill in the circle with a dark pencil or a black ink pen to select a language.

- Good



- Bad

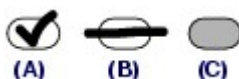

- (A) Check mark
(B) Line only
(C) Too light

For details, refer to the "[Troubleshooting](#)" in the on-screen manual: *Advanced Guide*.

- If the Photo Index Sheet is not printed in the selected language, be sure to place the Language Selection Sheet on the Platen Glass correctly and press the **Photo Index Sheet** button to scan it again.



Note

- If you only want to set the language, press the  (Maintenance) button repeatedly until **n** appears, and press the **Black** or **Color** button.



[↑ Page top](#)

Copying

You can make enlarged or reduced copies to fit the page size, and borderless copies of photos, besides standard copies.

Copying Documents

[Switching the Page Size between A4 or 8.5" x 11" \(Letter\)](#)

Copying Photos

Fit-to-Page Copying



[↑ Page top](#)

Copying Documents

This section describes the basic operation to copy documents.

For the operation, see the notes and operation procedure described in the reference page.

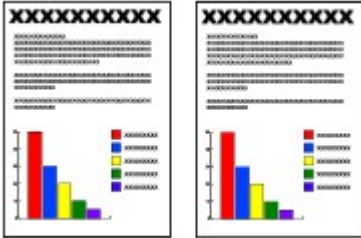

You need to prepare:

Originals to copy. See [Originals You Can Load](#).

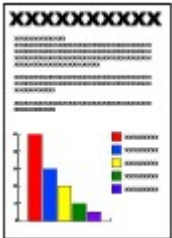

Paper for printing. See [Media Types You Can Use](#).



1. Prepare for copying.

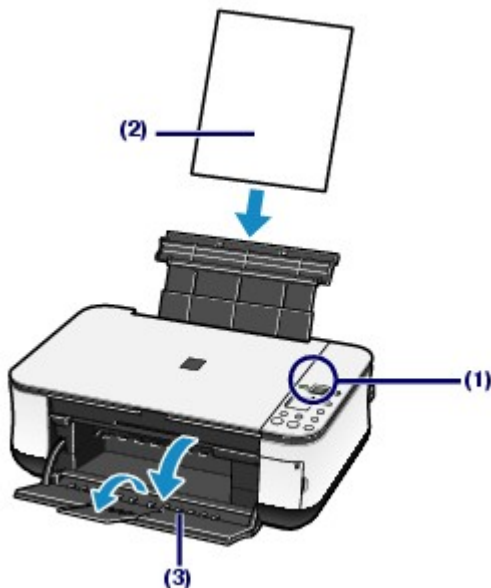

(1) Turn on the power.

See [Operation Panel](#).

(2) Load paper.

See [Loading Paper](#).

(3) Open the Paper Output Tray gently, and open the Output Tray Extension.**(4)** Load an original on the Platen Glass.

Load the original with the side to copy facing down and align it with the alignment mark as shown below.

See [Loading Originals to Copy or Scan](#).

**2.** Start copying.**(1)** Press the [+] button repeatedly to specify the number of copies (max. 20 copies).**To make 1 to 9 copies or 20 copies**

Display the desired number of copies on the LED.

Each time you press the [+] button, the number on the LED increases by one. When **F** appears, the number of copies is set to "20". Press the [+] button again to return to "1".

To make 10 to 19 copies**(1)** Display **F** on the LED.**(2)** Load only the desired number of sheets to copy in the Rear Tray.**(2)** Press the **Paper** button repeatedly to specify the page size and media type.

The **Paper** lamp indicates the selected page size and media type.

A4 or 8.5" x 11" Plain Paper / A4 or 8.5" x 11" Photo Paper / 4" x 6" Photo Paper

**Note**

- You can switch the size of paper loaded in the Rear Tray between A4 and 8.5" x 11" (Letter) regardless of the size indicated on the Operation Panel.
See [Switching the Page Size between A4 or 8.5" x 11" \(Letter\)](#).
- When the Fit-to-Page copy function is enabled, you can copy an original in the size automatically enlarged or reduced to fit the selected page size. In this case, the original is copied with borders on the plain paper and without borders on the photo paper.
Cancel the Fit-to-Page copy function to copy an original in the same size.
See [Fit-to-Page Copying](#).

(3) Press the **Color** button for color copying, or the **Black** button for black & white copying.

The machine starts copying.

While copying is in progress, the number on the LED is flashing and reduced by one to indicate the

remaining number of copies to be made.

To make 10 to 19 copies

The paper-out error will occur ("E, 2" appears on the LED) when all of the loaded paper has been used to print. Press the **Stop/Reset** button to release the error.



Note

- You can set the print quality to "Fast" only when A4 or Letter-sized plain paper is selected for the page size and media type.

To set the print quality to "Fast"

- Press and hold down the **Color** or **Black** button for 2 or more seconds.

The LED flashes once.

* When you press the **Color** or **Black** button for less than 2 seconds, the machine starts copying in the print quality "Standard".

- Release the button.

The machine starts copying.

- When the print quality is set to "Fast", print speed is given priority over quality. To give priority to quality, copy in the print quality "Standard".



Important

- Do not open the Document Cover or move the loaded original until copying is completed.



Note

- To cancel copying, press the **Stop/Reset** button.

■ Switching the Page Size between A4 or 8.5" x 11" (Letter)

You can switch the size of paper loaded in the Rear Tray between A4 and 8.5" x 11" (Letter).

This setting is useful if you usually load Letter-sized paper in the Rear Tray regardless of the page size indication "A4" on the Operation Panel, and vice versa.

- Press the  (Maintenance) button repeatedly until **d** appears.



- Press the **Black** button to select A4, or the **Color** button to select 8.5" x 11" (Letter).



Note

- When you switch the page size to A4 or 8.5" x 11" (Letter), load paper of the selected size regardless of the size indicated on the Operation Panel.
 - When the page size is set to A4: A4 Plain Paper / A4 Photo Paper
 - When the page size is set to 8.5" x 11" (Letter): 8.5" x 11" Plain Paper / 8.5" x 11" Photo Paper



[↑ Page top](#)

Copying Photos

This section describes the basic operation to copy photos.



You need to prepare:

Printed photos.



Paper for printing. See [Media Types You Can Use](#).

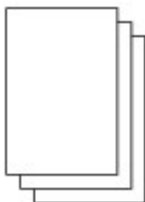

1. Prepare for copying a photo.

(1) Turn on the power.

See [Operation Panel](#).

(2) Load paper.

See [Loading Paper](#).

(3) Open the Paper Output Tray gently, and open the Output Tray Extension.

(4) Load a photo on the Platen Glass.

See [Loading Originals to Copy or Scan](#).

2. Start copying.

(1) Press the **[+]** button repeatedly to specify the number of copies.

See [Start copying](#).

(2) Press the **Paper** button repeatedly to specify the page size and media type.

The **Paper** lamp indicates the selected page size and media type.

A4 or 8.5" x 11" Photo Paper / 4" x 6" Photo Paper



Note

- You can switch the size of paper loaded in the Rear Tray between A4 and 8.5" x 11" (Letter) regardless of the size indicated on the Operation Panel.
See [Switching the Page Size between A4 or 8.5" x 11" \(Letter\)](#).
- When the Fit-to-Page copy function is enabled, you can copy an original in the size automatically enlarged or reduced to fit the selected page size. In this case, the original is copied with borders on the plain paper and without borders on the photo paper.
Cancel the Fit-to-Page copy function to copy an original in the same size.
See [Fit-to-Page Copying](#).

(3) Press the **Color** button for color copying, or the **Black** button for black & white

copying.

The machine starts copying.



Important

- Do not open the Document Cover or move the loaded photo until copying is completed.



Note

- To cancel copying, press the **Stop/Reset** button.



[↑ Page top](#)

Fit-to-Page Copying

The Fit-to-Page copy function enables you to copy originals automatically enlarged or reduced to fit the selected page size.

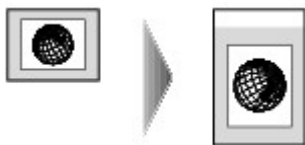

1. Prepare for copying.

See [Prepare for copying](#).

2. Press the **[+]** button repeatedly to specify the number of copies.

3. Press the **Paper** button repeatedly to select the page size and media type.



Note

- When the plain paper is selected for the media type, the original is copied with borders. When the photo paper is selected for the media type, the original is copied without borders and fills the entire page.

4. Press the **Fit to Page** button.

The **Fit to Page** lamp lights up and the Fit-to-Page copy function is enabled. The original is copied in the size automatically enlarged or reduced to fit the selected page size.



Note

- Press the **Fit to Page** button again to cancel the Fit-to-Page copy function and copy the original in the same size.

5. Press the **Color** button for color copying, or the **Black** button for black & white copying.

The machine starts Fit-to-Page copying.



Important

- Do not open the Document Cover or move the loaded original until copying is completed.



Note

- You can set the print quality to "Fast" only when A4 or Letter-sized plain paper is selected for the page size and media type. See [To set the print quality to "Fast"](#).
- To cancel copying, press the **Stop/Reset** button.



Scanning

You can send scanned data to your computer, edit or process them with the supplied software application, then save them. You can also save scanned data on a memory card inserted into the machine (MP260 series).

Saving Scanned Data

[Saving Scanned Data on the Memory Card \(MP260 series\)](#)

[Saving Scanned Data on the Computer](#)



[↑ Page top](#)

Saving Scanned Data

This section describes the operation to scan originals and save them on the memory card in PDF format (MP260 series) or save them on the computer using the Operation Panel on the machine.

For the operation on scanning from the computer, refer to the on-screen manual: [Advanced Guide](#). You can find the detailed procedures to scan images or print scanned images with various settings, such as image correction.

Important

- We recommend that you make a backup of the data on the memory card regularly and save it on other storage media, in case of accidental loss.
- Please note that Canon shall not be liable for any damage or loss of the data for any reason whatsoever, even within the warranty period of the machine.

■ Saving Scanned Data on the Memory Card (MP260 series)

1. Prepare for scanning.

(1) Turn on the power.

See [Operation Panel](#).

(2) Insert a memory card into the Card Slot.

For the types of memory cards you can use and locations to insert them, see [Inserting the Memory Card](#).



Note

- When the read/write attribute of the Card Slot is set to the "Writable from PC" mode, you cannot save scanned data on a memory card. Set the read/write attribute to the "Not writable from PC" mode. See [Setting the Read/Write Attribute of the Card Slot](#).

2. Load an original on the Platen Glass.

See [Loading Originals to Copy or Scan](#).



Note

- The size of original that can be scanned is either A4 or 8.5" x 11" (Letter) depending on the country or region of purchase.

3. Press and hold down the **SCAN** button for 2 or more seconds to start scanning.

The LED flashes once.

The scanned data will be saved on the memory card in PDF format.



Important

- Do not open the Document Cover or move the loaded original until scanning is completed.
- Do not remove the memory card or turn off the power while the machine is operating.
- The scanned data will be saved in the folder "CANON_SC" on the memory card. You cannot print the saved data using the Operation Panel on the machine.



Note

- If you press the **SCAN** button for less than 2 seconds, the scanned data will be saved on the computer.
- You can correct/enhance or print image data saved on the memory card, using MP Navigator EX supplied with your machine. For details, refer to the on-screen manual: [Advanced Guide](#).
- To remove the memory card after scanning is completed, see [Removing the Memory Card](#).

■ Saving Scanned Data on the Computer

Before scanning originals, confirm the following.

- Are the necessary software applications (MP Drivers and MP Navigator EX) installed?
If the software applications are not installed, refer to the printed manual: *Getting Started*.
- Does the original to be scanned meet the requirements for an original to be set on the Platen Glass?
For details, see [Loading Originals to Copy or Scan](#).
- Is the machine connected to a computer correctly?
Confirm that the connection between the machine and the computer is physically secure.

Important

- Do not plug in or unplug the USB cable while the machine is scanning originals, or the computer is in the sleep mode or standby mode.

1. (Macintosh only) Prepare your computer before scanning.

Important

- Make sure that MP Navigator EX is installed and that the computer is connected to the machine before starting up Image Capture.

When you are using Mac OS X v.10.3.9, follow the procedure below to set MP Navigator EX as the starting software application in Image Capture under Applications. This operation is not necessary for Mac OS X v.10.4.x or later.

When you are using Mac OS X v.10.3.9

Select Applications on the Go menu, and double-click the Image Capture icon. Click Options at lower left of the scanner window, select MP Navigator EX 2 in Application to launch when scanner button is pressed, and click OK. To quit Image Capture, select Quit Image Capture on the Image Capture menu.

Important

- If Options does not appear, select Preferences on the Image Capture menu, click Scanner, and click Use TWAIN software whenever possible to clear the option. Then quit Image Capture and restart it.

2. Prepare for scanning.

(1) Turn on the power.

See [Operation Panel](#).

(2) Load an original on the Platen Glass.

See [Loading Originals to Copy or Scan](#).

3. Press the **SCAN** button to start scanning.

MP Navigator EX will start up.

Important

- Do not open the Document Cover or move the loaded original until scanning is completed.
- If the position or size of an original is not scanned correctly depending on the type of original, refer to the on-screen manual: [Advanced Guide](#) and change the MP Navigator EX Document Type and Document Size settings to match the original being scanned.



Note

- When you are using Windows Vista operating system, the program selection screen may appear after performing step 3. In this case, select MP Navigator EX Ver2.0 and click OK. You can set MP Navigator EX to launch whenever performing step 3. For details, refer to the on-screen manual: [Advanced Guide](#).
- When you are using Windows XP, the program selection screen may appear after performing step 3 for the first time. In this case, specify MP Navigator EX Ver2.0 as the application

software to use, select Always use this program for this action, then click OK. From the next time, MP Navigator EX will be automatically started.



[↑ Page top](#)

Printing from Your Computer

This section describes how to print documents or photos with a computer. You can easily print photos taken with your digital camera by using Easy-PhotoPrint EX supplied with your machine.

Printing Photos (Easy-PhotoPrint EX)

[Using Various Functions of Easy-PhotoPrint EX](#)

Printing Documents (Windows)

Printing Documents (Macintosh)

[For Mac OS X v.10.5.x](#)

[For Mac OS X v.10.4.x or Mac OS X v.10.3.9](#)



[↑ Page top](#)

Printing Photos (Easy-PhotoPrint EX)

Print image data saved on your computer by using Easy-PhotoPrint EX supplied with your machine. This section describes the procedure, using print setting for borderless photo print on 4" x 6" / 10 x 15 cm photo paper as a sample.

For details on Easy-PhotoPrint EX, refer to the on-screen manual: [Advanced Guide](#).



Note

- The screens used in this section are for printing with Windows. The operations are also the same for printing with Macintosh.
- Install Easy-PhotoPrint EX from the *Setup CD-ROM* when it has not been installed or has been uninstalled. To install Easy-PhotoPrint EX, select Easy-PhotoPrint EX in Custom Install.

1. Prepare for printing.

(1) Make sure that the machine is turned on.

See [Operation Panel](#).

(2) Load paper.

See [Loading Paper](#).

Here we load 4" x 6" / 10 x 15 cm photo paper in the Rear Tray.



2. Open the Paper Output Tray gently, and open the Output Tray Extension.

3. Start Easy-PhotoPrint EX, and select Photo Print.



(1) Start Easy-PhotoPrint EX.



Double-click  (Easy-PhotoPrint EX) on the desktop.





Click Here: [Easy-PhotoPrint EX](#)



Macintosh

Select the Go menu, Applications, Canon Utilities, Easy-PhotoPrint EX, then double-click Easy-PhotoPrint EX.

**Note****Windows**

- To start Easy-PhotoPrint EX from Solution Menu, double-click  (Solution Menu) on the desktop and click  (Print photos or albums, etc.). See [To Start Solution Menu](#).
- To start Easy-PhotoPrint EX from the Start menu, select All Programs (Programs in Windows 2000), Canon Utilities, Easy-PhotoPrint EX, then Easy-PhotoPrint EX.

Macintosh

- To start Easy-PhotoPrint EX from Solution Menu, click  (Solution Menu) in the Dock and click  (Print photos or albums, etc.). See [To Start Solution Menu](#).

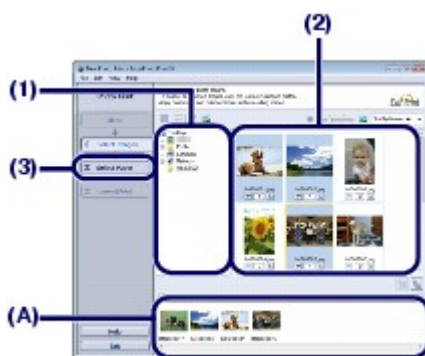

(2) Click Photo Print.**Note**

- You can select Album, Calendar, Stickers, etc., besides Photo Print. See [Using Various Functions of Easy-PhotoPrint EX](#).

4. Select a photo to print.**(1) Select the folder in which images are saved.****(2) Click the image to print.**

The number of copies appears as "1", and the image you selected appears in the selected image area (A). You can select two or more images at the same time.

**Note**

- To print two or more copies, click  (Up arrow) to change the number of copies.
- To cancel the selection, click the image to cancel in the selected image area and click  (Delete Imported Image). You can also use  (Down arrow) to change the number of copies to zero.
- You can also correct or enhance the selected image. See [Using Various Functions of Easy-PhotoPrint EX](#).

(3) Click Select Paper.**5. Select the loaded paper.**

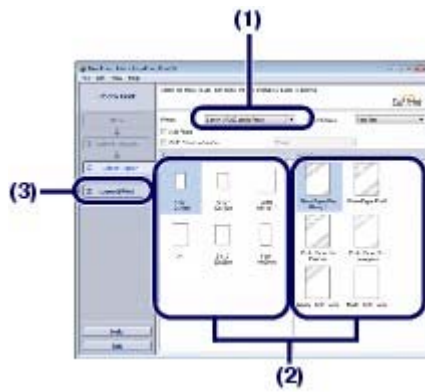

- (1) Make sure that your machine's name is selected in Printer.
- (2) Select the loaded paper in Paper Size and Media Type.
Here we select 4"x6" 10x15cm in Paper Size and the type of loaded photo paper in Media Type.



Note

- If you select the wrong media type, the machine may not print with the proper print quality.

- (3) Click Layout/Print.

6. Select a layout and start printing.



- (1) Select the layout of the photo.
Here we select Borderless [full].
The preview appears in the selected layout for confirmation of the required print result.



Note

- You can change the direction of photo or crop a part of photo (trimming) to print.
For details on the operation, refer to the on-screen manual: [Advanced Guide](#).

- (2) Click Print.



Note

Windows

- To cancel a print job in progress, press the **Stop/Reset** button on the machine or click Cancel Printing on the printer status monitor.
To display the printer status monitor, click Canon XXX Printer (where "XXX" is your machine's name) on the taskbar.

Macintosh

- Click the printer icon in the Dock to display the list of print jobs in progress.
- To cancel a print job in progress, select the desired job in the Name list and click Delete.



Basic Guide[Advanced Guide](#) [Troubleshooting](#)

[Contents](#) > [Printing from Your Computer](#) > [Printing Photos \(Easy-PhotoPrint EX\)](#) > Using Various Functions of Easy-PhotoPrint EX

■ Using Various Functions of Easy-PhotoPrint EX

This section describes a few of the useful functions of Easy-PhotoPrint EX.

For details on the operation, refer to the on-screen manual: [Advanced Guide](#).

● Creating Your Own Prints

You can create an album or calendar using your photos.



Album



Calendar



Stickers

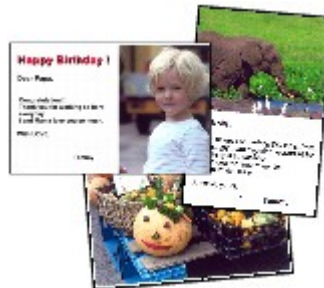

Layout Print

● Correcting Images

You can use Red-Eye Correction, Face Sharpener, Digital Face Smoothing, Brightness, Contrast, etc. to adjust, correct, or enhance images automatically or manually.

Sample of the correction



Brightness



[↑ Page top](#)

Printing Documents (Windows)



Note

- Operations may vary depending on your software application. For details on the operation, refer to the instruction manual of your application.
- The screens used in this section are for printing with Windows Vista Ultimate Edition (hereafter referred to as "Windows Vista").

1. Make sure that the machine is turned on.

See [Operation Panel](#).

2. Load paper.

See [Loading Paper](#).

3. Open the Paper Output Tray gently, and open the Output Tray Extension.

4. Create (or open) a document to print using an appropriate software application.

5. Open the printer properties dialog box.

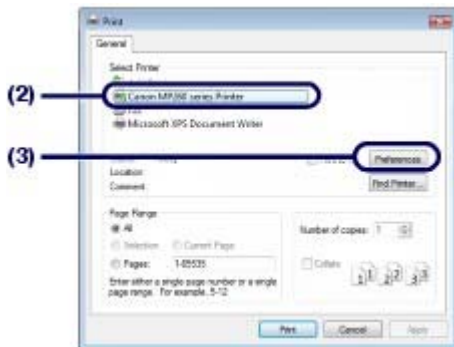

(1) Select Print on the File menu or the command bar in your software application.

The Print dialog box appears.

(2) Make sure that your machine's name is selected.



Note

- If another printer's name is selected, click and select your machine's name.

(3) Click Preferences (or Properties).

6. Specify the required print settings.

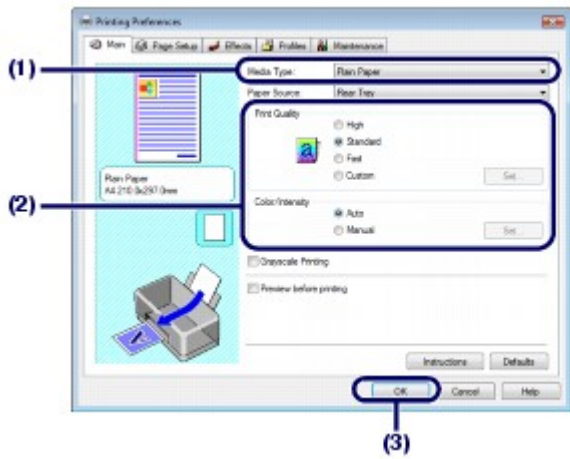

(1) Select the media type of the loaded paper in Media Type.



Note

- If you select the wrong media type, the machine may not print with the proper print quality.

(2) Specify the print quality, etc. in Print Quality and Color/Intensity as required.



Note

- For details on the print settings, refer to the on-screen manual: [Advanced Guide](#).

(3) Click OK.



Note

- To confirm the page size, click the Page Setup tab. If the setting does not match the document's page size already set in the software application, you need to reset the page size, or otherwise use Scaled Printing or Fit-to-Page Printing. For details, refer to the on-screen manual: [Advanced Guide](#).
- For details on the printer driver functions, click Help or Instructions to view the online help or the on-screen manual: *Advanced Guide*. The Instructions button appears on the Main and Maintenance sheets if the on-screen manual is installed on your computer.
- To display the preview to confirm the print result, select the Preview before printing check box on the Main sheet. Some software applications may not have a preview function.

7. Start printing.

Click Print (or OK) to start printing.



Note

- The message on how to load envelopes will appear when printing on them. This message will not appear next time if you select the Do not show this message again. check box.
- To cancel a print job in progress, press the **Stop/Reset** button on the machine or click Cancel Printing on the printer status monitor. To display the printer status monitor, click Canon XXX Printer (where "XXX" is your machine's name) on the taskbar.
- If printed ruled lines are misaligned or print results are unsatisfactory, adjust the print head

position. See [Aligning the Print Head](#).



[↑ Page top](#)

Printing Documents (Macintosh)



Note

- Operations may vary depending on your software application. For details on the operation, refer to the instruction manual of your application.

■ For Mac OS X v.10.5.x

1. Make sure that the machine is turned on.

See [Operation Panel](#).

2. Load paper.

See [Loading Paper](#).

3. Open the Paper Output Tray gently, and open the Output Tray Extension.

4. Create (or open) a document to print using an appropriate software application.

5. Open the Print dialog box.

Select Print on the File menu in your software application.
The Print dialog box appears.



Note

- If the dialog box below appears, click  (Down arrow).

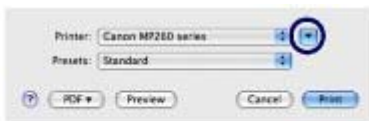

6. Specify the required print settings.

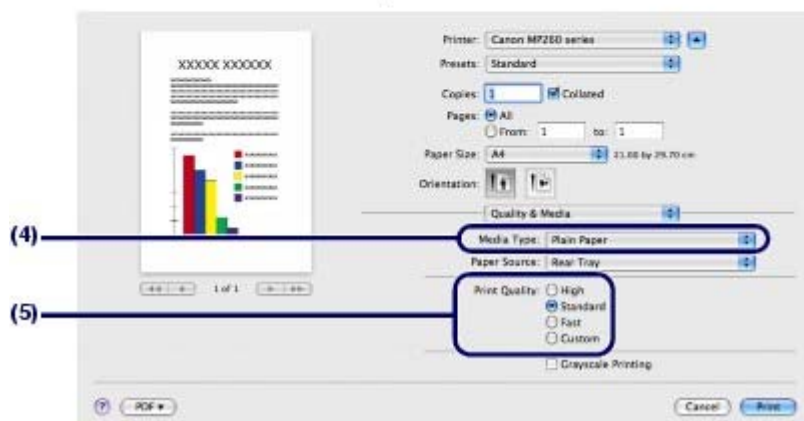

- (1) Make sure that your machine's name is selected in Printer.
- (2) Select the page size of the loaded paper in Paper Size.
- (3) Select Quality & Media in the pop-up menu.
- (4) Select the media type of the loaded paper in Media Type.



Note

- If you select the wrong media type, the machine may not print with the proper print quality.

- (5) Select the print quality in Print Quality.



Note

- For details on the print quality, refer to the on-screen manual: [Advanced Guide](#).



Note

- For details on the printer driver functions, click (Question) on the Quality & Media, Color Options, Borderless Printing, or Margin screen to view the on-screen manual: *Advanced Guide*. If the on-screen manual is not installed, it does not appear even if (Question) is clicked.
- The preview appears on the left of the dialog box to confirm the print result. Some software applications may not have a preview function.

7. Start printing.

Click Print to start printing.



Note

- Click the printer icon in the Dock to display the list of print jobs in progress.
- To cancel a print job in progress, select the desired job in the Name list and click Delete. To temporarily stop a job in progress, click Hold. To temporarily stop all the jobs in the list, click Pause Printer.
- If printed ruled lines are misaligned or print results are unsatisfactory, adjust the print head position. See [Aligning the Print Head](#).

■ For Mac OS X v.10.4.x or Mac OS X v.10.3.9

Note

- The screens used in this section are for printing in Mac OS X v.10.4.x.

1. Make sure that the machine is turned on.
See [Operation Panel](#).
2. Load paper.
See [Loading Paper](#).
3. Open the Paper Output Tray gently, and open the Output Tray Extension.
4. Create (or open) a document to print using an appropriate software application.
5. Specify the page size.



- (1) Select Page Setup on the File menu in your software application.
The Page Setup dialog box appears.
- (2) Make sure that your machine's name is selected in Format for.
- (3) Select the page size of the loaded paper in Paper Size.
- (4) Click OK.

6. Specify the required print settings.

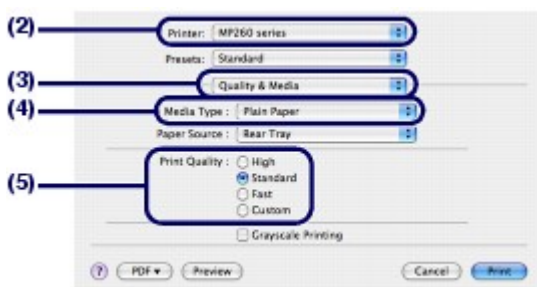

- (1) Select Print on the File menu in your software application.
The Print dialog box appears.
- (2) Make sure that your machine's name is selected in Printer.
- (3) Select Quality & Media in the pop-up menu.
- (4) Select the media type of the loaded paper in Media Type.



**Note**

- If you select the wrong media type, the machine may not print with the proper print quality.

(5) Select the print quality in Print Quality.**Note**

- For details on the print quality, refer to the on-screen manual: [Advanced Guide](#).

**Note**

- For details on the printer driver functions, click  (Question) on the Quality & Media, Color Options, Special Effects, Borderless Printing, or Margin screen to view the on-screen manual: *Advanced Guide*. If the on-screen manual is not installed, it does not appear even if  (Question) is clicked.
- To display the preview to confirm the print result, click Preview. Some software applications may not have a preview function.

7. Start printing.

Click Print to start printing.

**Note**

- Click the printer icon in the Dock to display the list of print jobs in progress.
- To cancel a print job in progress, select the desired job in the Name list and click Delete. To temporarily stop a job in progress, click Hold. To temporarily stop all the jobs in the list, click Stop Jobs.
- If printed ruled lines are misaligned or print results are unsatisfactory, adjust the print head position. See [Aligning the Print Head](#).



 [Page top](#)

Other Usages

This section describes the function to print photos from your digital camera connected with a USB cable (MP240 series) and the useful function to start supplied software applications.

[Printing Photos from a PictBridge Compliant Device \(MP240 series\)](#)

[Solution Menu and My Printer](#)



[↑ Page top](#)

Printing Photos from a PictBridge Compliant Device (MP240 series)

Connecting the PictBridge compliant device to this machine with a USB cable that is recommended by the device's manufacturer, you can print saved images directly.

For details on how to print saved images connecting with the PictBridge compliant device, refer to the on-screen manual: [Advanced Guide](#).

For details on the print settings on the PictBridge compliant device, refer to the instruction manual supplied with the device.



Connectable devices:

Any PictBridge compliant device can be connected to this machine regardless of the manufacturer or model as long as it is compliant with the PictBridge standard.



Note

- PictBridge is the standard to print your photos directly without using a computer, connecting a device such as a digital still camera, digital camcorder, or camera-equipped mobile phone.



(PictBridge) A device with this mark is PictBridge compliant.

Printable image data format:

This machine prints images taken with a DCF (Design rule for Camera File system) ver. 1.0/2.0-compatible digital camera (Exif ver. 2.2/2.21 compliant), as well as PNG files.



[↑ Page top](#)

Solution Menu and My Printer

Using Solution Menu or My Printer (Windows only), you can easily get the information on the machine or change the print settings by only clicking buttons on a screen.

With Solution Menu, you can start the software applications supplied with the machine or display the operating instructions. It also provides you with the information on troubleshooting.

With My Printer, you can display the printer properties dialog box of the printer driver. It also provides you with the information on how to take an action when you have trouble with the operation. My Printer is not available in Macintosh.

● To Start Solution Menu



Double-click  (Solution Menu) on the desktop.



Click Here: [Solution Menu](#)



Click  (Solution Menu) in the Dock.

* The screens below are for Windows Vista.



Click the button of a function to use.



After starting Solution Menu, click  (Window size: small) on the title bar to reduce the window size.



Note

- Install Solution Menu from the *Setup CD-ROM* when it has not been installed or has been uninstalled. To install Solution Menu, select Solution Menu in Custom Install.
- The buttons displayed on the screen may vary depending on the country or region of purchase.



- To start Solution Menu from the Start menu, select All Programs (Programs in Windows 2000), Canon Utilities, Solution Menu, then Solution Menu.



- To start Solution Menu from the menu bar, select the Go menu, Applications, Canon Utilities, Solution Menu, then double-click Solution Menu.

● To Start My Printer



Double-click  (My Printer) on the desktop.



Note

- You can also start My Printer from Solution Menu.
- Install My Printer from the *Setup CD-ROM* when it has not been installed or has been uninstalled. To install My Printer, select My Printer in Custom Install.
- To start My Printer from the Start menu, select All Programs (Programs in Windows 2000), Canon Utilities, My Printer, then My Printer.



[↑ Page top](#)

Loading Paper / Originals

This section describes types of paper or originals you can load, how to load printing paper in the Rear Tray, and how to load originals to copy or scan.

Loading Paper

[Media Types You Can Use](#)

[Media Types You Cannot Use](#)

[Loading Paper](#)

[Loading Envelopes](#)

Loading Originals to Copy or Scan

[Originals You Can Load](#)

[Loading Originals](#)



[↑ Page top](#)

Loading Paper

Media Types You Can Use



Choose paper suitable for printing, for the best print results. Canon provides you various types of paper to enhance the fun of printing, such as stickers as well as papers for photo or document. We recommend the use of Canon genuine paper for printing your important photos.

Media Types

Commercially available papers

Name of Paper <Model No.> *1	Rear Tray Paper Load Limit	Paper Output Tray Load Limit	Settings in Printer Driver: Media Type
Plain Paper (Recycled paper)*2	Approx. 100 sheets	Approx. 50 sheets	Plain Paper
Envelopes*3	10 envelopes	*5	Envelope

Canon genuine papers

Name of Paper < Model No.> *1	Rear Tray Paper Load Limit	Paper Output Tray Load Limit	Settings in Printer Driver: Media Type
For printing documents:			
Super White Paper <SW-201>	Approx. 80 sheets	Approx. 50 sheets	Plain Paper
For printing photos:			
			
Photo Paper Pro Platinum <PT-101>*4	A4, Letter / 8.5" x 11", 5" x 7" / 13 x 18 cm, and 8" x 10" / 20 x 25 cm: 10 sheets 4" x 6" / 10 x 15 cm: 20 sheets	*5	Photo Paper Pro Platinum
Photo Paper Pro II <PR-201>*4			Photo Paper Pro II
Glossy Photo Paper "Everyday Use" <GP-501>*4			Glossy Photo Paper
Photo Paper Glossy <GP-502>*4			Glossy Photo Paper
Photo Paper Plus Glossy II <PP-201>*4			Photo Paper Plus Glossy II
Photo Paper Plus Semi-gloss <SG-201>*4			Photo Paper Plus Semi-gloss
Matte Photo Paper <MP-101>			Matte Photo Paper
For printing business documents:			
			
High Resolution Paper <HR-101N>*3	80 sheets	50 sheets	High Resolution Paper

For creating your own prints:			
			
T-Shirt Transfers <TR-301>*3	1 sheet	*5	T-Shirt Transfers
Photo Stickers <PS-101>*3	1 sheet		Glossy Photo Paper

*1 Paper with a Model Number is Canon genuine paper. Refer to the instruction manual supplied with the paper for detailed information on the printable side and notes on handling paper. For information on the page sizes available for each Canon genuine paper, visit our website. You may not be able to purchase some Canon genuine papers depending on the country or region of purchase. Paper is not sold in the US by Model Number. Purchase paper by name.

*2 Proper feeding of paper may not be possible at the maximum capacity depending on the type of paper or environmental conditions (either very high or low temperature or humidity). In such cases, reduce the number of paper you load at a time to less than half (100% recycled paper can be used).

*3 Available only when printing from your computer.

*4 When loading paper in stacks, the print side may become marked as it is fed or paper may not feed properly. In this case, load one sheet at a time.

*5 We recommend that you remove the previously printed sheet from the Paper Output Tray before continuously printing to avoid blurs and discoloration.

Important

- If you select "Photo Paper" on the Operation Panel when copying, use the following media types for the best print results.
 - Glossy Photo Paper "Everyday Use" GP-501
 - Photo Paper Glossy GP-502
 - Photo Paper Plus Glossy II PP-201
 - Photo Paper Plus Semi-gloss SG-201

● Page Sizes

You can use the following page sizes.

- In Macintosh, Choukei 3 and Choukei 4 are not available.

Standard sizes:

- Letter (8.50 x 11.00 inches / 215.9 x 279.4 mm)
- Legal (8.50 x 14.00 inches / 215.9 x 355.6 mm)
- A5 (5.83 x 8.27 inches / 148.0 x 210.0 mm)
- A4 (8.27 x 11.69 inches / 210.0 x 297.0 mm)
- B5 (7.17 x 10.12 inches / 182.0 x 257.0 mm)
- 4" x 6" (4.00 x 6.00 inches / 10 x 15 cm)
- 4" x 8" (4.00 x 8.00 inches / 101.6 x 203.2 mm)
- 5" x 7" (5.00 x 7.00 inches / 13 x 18 cm)
- 8" x 10" (8.00 x 10.00 inches / 20 x 25 cm)
- L (3.50 x 5.00 inches / 89.0 x 127.0 mm)
- 2L (5.00 x 7.01 inches / 127.0 x 178.0 mm)
- Hagaki (3.94 x 5.83 inches / 100.0 x 148.0 mm)
- Hagaki 2 (7.87 x 5.83 inches / 200.0 x 148.0 mm)
- Comm. Env. #10 (4.12 x 9.50 inches / 104.6 x 241.3 mm)
- DL Env. (4.33 x 8.66 inches / 110.0 x 220.0 mm)
- Choukei 3 (4.72 x 9.25 inches / 120.0 x 235.0 mm)
- Choukei 4 (3.54 x 8.07 inches / 90.0 x 205.0 mm)
- Youkei 4 (4.13 x 9.25 inches / 105.0 x 235.0 mm)
- Youkei 6 (3.86 x 7.48 inches / 98.0 x 190.0 mm)
- Card (2.16 x 3.58 inches / 55.0 x 91.0 mm)
- Wide (4.00 x 7.10 inches / 101.6 x 180.6 mm)

Non-standard sizes:

You can also specify a custom size within the following range.

- Minimum size: 2.17 x 3.58 inches / 55.0 x 91.0 mm
- Maximum size: 8.5 x 26.61 inches / 215.9 x 676.0 mm

● Paper Weight

17 to 28 lb / 64 to 105 gsm (plain paper except for Canon genuine paper)

Do not use heavier or lighter paper (except for Canon genuine paper), as it could jam in the machine.

● Notes on Storing Paper

- Take out only the necessary number of paper from the package, just before printing.
- To avoid curling, when you do not print, put unused paper back into the package and keep it on a level surface. And also, store it avoiding heat, humidity, and direct sunlight.



[↑ Page top](#)

■ Media Types You Cannot Use

Do not use the following types of paper. Using such paper will not only produce unsatisfactory results, but can also cause the machine to jam or malfunction.

- Folded, curled, or wrinkled paper
- Damp paper
- Paper that is too thin (weighing less than 17 lb / 64 gsm)
- Paper that is too thick (plain paper, except for Canon genuine paper, weighing more than 28 lb / 105 gsm)
- Paper thinner than a postcard, including plain paper or notepad paper cut to a small size (when printing on A5 or smaller sized paper)
- Picture postcards
- Postcards affixed with photos or stickers
- Envelopes with a double flap (or sticker flaps)
- Envelopes with pressure seals
- Envelopes with an embossed or treated surface
- Envelopes whose gummed flaps are already moistened and adhesive
- Any type of paper with holes
- Paper that is not rectangular
- Paper bound with staples or glue
- Paper with adhesives
- Paper decorated with glitter, etc.



[↑ Page top](#)

■ Loading Paper

⊘ Important

- Always load paper in the portrait orientation (A). Loading paper in the landscape orientation (B) can cause paper jams.

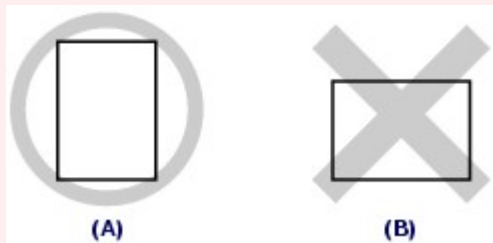

- If you cut plain paper into small size such as 4" x 6" / 10 x 15 cm, 4" X 8" / 101.6 x 203.2 mm, 5" x 7" / 13 x 18 cm, or 2.16" x 3.58" / 55.0 x 91.0 mm (Card size) to perform trial print, it can cause paper jams.

📖 Note

- We recommend Canon genuine photo paper for printing photos. For details on the Canon genuine paper, see [Media Types You Can Use](#).
- You can use general copy paper. When printing on both sides, we recommend Canon's Super White Paper. For the page size and paper weight you can use for this machine, see [Media Types You Can Use](#).

1. Flatten the four corners of paper before loading it.

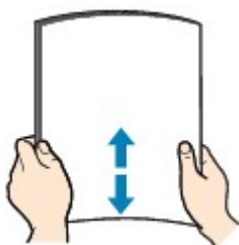

📖 Note

- Align the edges of paper neatly before loading. Loading paper without aligning the edges may cause paper jams.
- If paper is curled, hold the curled corners and gently bend them in the opposite direction until the paper becomes completely flat. For details on how to flatten curled paper, refer to the "[Troubleshooting](#)" in the on-screen manual: *Advanced Guide*.

2. Prepare for loading paper.

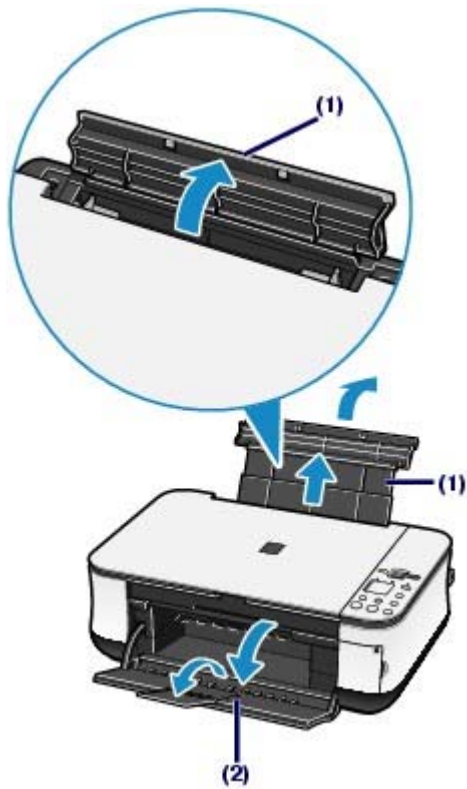

- (1) Open the Paper Support, raise it, then tip it back.
- (2) Open the Paper Output Tray gently, and open the Output Tray Extension.

3. Load paper.

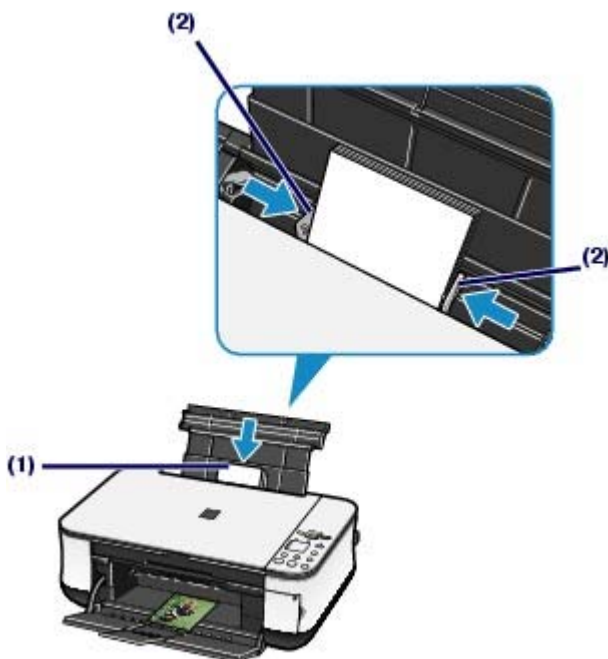

- (1) Slide the Paper Guides to open them, and load the paper in the center of the Rear Tray WITH THE PRINT SIDE FACING YOU.
- (2) Slide the Paper Guides to align them with both sides of the paper stack.
Do not slide the Paper Guides too hard. The paper may not be fed properly.



Note

- Do not load higher than the Load Limit Mark (A).

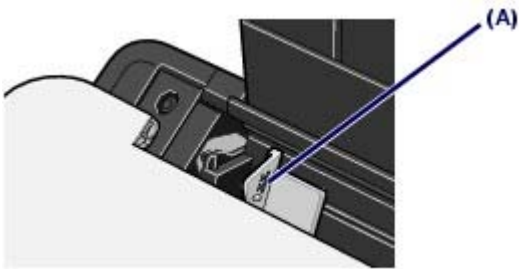

- The machine may make operating noise when feeding paper.
-



Note

After loading paper

- When printing with the Photo Index Sheet, make sure that the size and type of the loaded paper match those specified in Page size/Media type on the Photo Index Sheet. See [Printing Photos Saved on the Memory Card](#).
 - When copying without using a computer, select the size and type of the loaded paper on the Operation Panel. See [Copying](#).
 - When printing with a computer, select the size and type of the loaded paper in Page Size (or Paper Size) and Media Type in the printer driver. See [Printing Documents \(Windows\)](#) or [Printing Documents \(Macintosh\)](#).
-



[↑ Page top](#)

■ Loading Envelopes

You can print on European DL and US Comm. Env. #10-sized envelopes.

The address is automatically rotated and printed according to the envelope's direction by specifying with the printer driver properly.

⊘ Important

- You can only print on envelopes with the computer.
- You cannot use the following envelopes.
 - Envelopes with an embossed or treated surface
 - Envelopes with a double flap (or sticker flaps)
 - Envelopes with pressure seals
 - Envelopes whose gummed flaps are already moistened and adhesive



Note

- In Windows, the message on how to load envelopes will appear when printing on them. This message will not appear next time if you select the **Do not show this message again.** check box.

1. Prepare envelopes.

- Press down on all four corners and edges of the envelopes to flatten them.

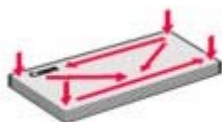

- If the envelopes are curled, hold the opposite corners and gently twist them in the opposite direction.



- If the corner of the envelope flap is folded, flatten it.
- Use a pen to press the leading edge in the inserting direction flat and sharpen the crease.

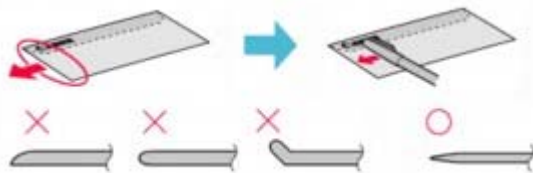

The figures above show a side view of the leading edge of the envelope.

⊘ Important

- The envelopes may jam in the machine if they are not flat or the edges are not aligned. Make sure that no curl or puff exceeds 0.1 inches / 3 mm.

2. Load envelopes.

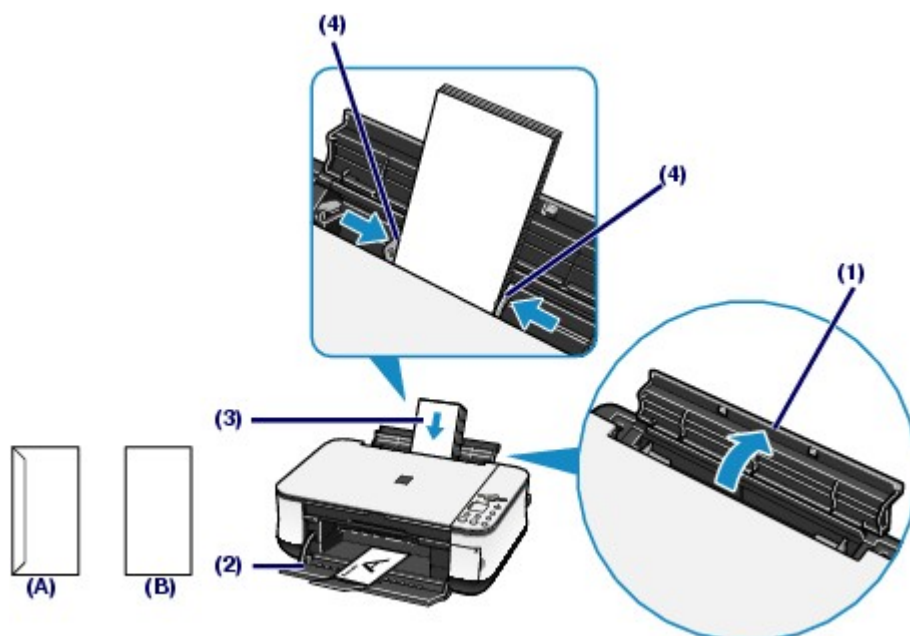

(A) Rear side

(B) Address side

(1) Open the Paper Support.

(2) Open the Paper Output Tray gently, and open the Output Tray Extension.

(3) Slide the Paper Guides to open them, and load the envelopes in the center of the Rear Tray **WITH THE ADDRESS SIDE FACING YOU**.

The folded flap of the envelope will be faced down on the left side.

Up to 10 envelopes can be loaded at once.

(4) Slide the Paper Guides to align them with both sides of the envelopes.

Do not slide the Paper Guides too hard. The envelopes may not be fed properly.

3. Specify the settings in the printer driver.

(1) Select Envelope in Media Type.

(2) Select the size for envelopes.



Select DL Env. or Comm. Env. #10 in Page Size.



Select DL Envelope or #10 Envelope in Paper Size.

(3) Select Landscape in Orientation.



Important

- If you do not specify Page Size (or Paper Size) or Orientation properly, the address will be printed upside down or will be turned to 90 degrees.



Note

- The machine may make operating noise when feeding envelopes.
- In Windows, if the print result is upside down, select Rotate 180 degrees on the Page Setup sheet in the printer properties dialog box of the printer driver.



Loading Originals to Copy or Scan

■ Originals You Can Load

You can copy or scan the following originals.

Types of originals: Photos or Texts (documents, books, magazines, etc.)

Size (W x L): Max. 8.5 x 11.7 inches / 216 x 297 mm



[↑ Page top](#)

■ Loading Originals

Load originals to copy or scan on the Platen Glass.

⚠ Important

- After loading the original, be sure to close the Document Cover before starting to copy or scan.
- When scanning from a computer using a software application, you need to load originals in a different way. For details, refer to the on-screen manual: [Advanced Guide](#).



Note

- Make sure any glue, ink, correction fluid, or the like on the original is completely dry before loading it.

1. Load an original on the Platen Glass.

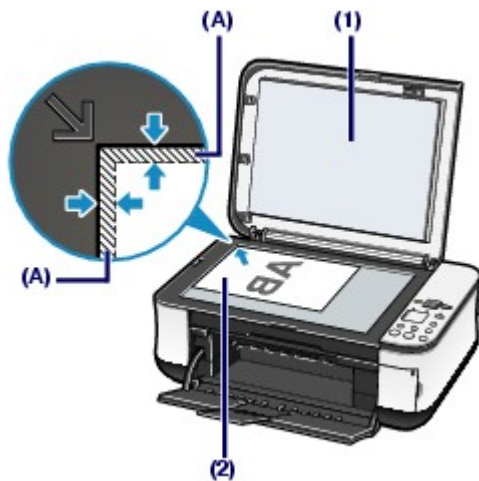

(1) Open the Document Cover.

(2) Load an original with the side to copy or scan **FACING DOWN** on the Platen

Glass.

Align the corner of the original with the alignment mark .



Important

- Do not place any objects weighing more than 4.4 lb / 2.0 kg on the Platen Glass.
- Do not press or put weight on the original with pressure exceeding 4.4 lb / 2.0 kg. Doing so may cause the scanner to malfunction or the Platen Glass to break.
- The machine cannot scan the shaded area (A) (0.04 inches / 1 mm from the edges of the Platen Glass).

2. Close the Document Cover gently.





 [Page top](#)

Routine Maintenance

This section describes how to replace FINE Cartridges when they run out of ink, to clean the machine when the print result is faint, or to take an action when paper does not feed properly.

When Printing Becomes Faint or Colors Are Incorrect

- [Printing the Nozzle Check Pattern](#)
- [Examining the Nozzle Check Pattern](#)
- [Cleaning the Print Head](#)
- [Cleaning the Print Head Deeply](#)
- [Aligning the Print Head](#)

Replacing a FINE Cartridge

- [Checking the Ink Status](#)
- [Replacing Procedure](#)

Cleaning the Machine

- [Cleaning the Paper Feed Roller](#)
- [Cleaning the Inside of the Machine \(Bottom Plate Cleaning\)](#)
- [Cleaning the Protrusions inside the Machine](#)



[↑ Page top](#)

When Printing Becomes Faint or Colors Are Incorrect

If print results are blurred or colors are not printed correctly, the print head nozzles (FINE Cartridges) are probably clogged. Follow the procedure below to print the nozzle check pattern, check the print head nozzle condition, then clean the Print Head.

If printed ruled lines are misaligned or print results are otherwise unsatisfactory, aligning the Print Head may improve print quality.

Caution

- Do not rinse or wipe the FINE Cartridges. This can cause trouble with the FINE Cartridges.

Note

Before performing maintenance

- Check if ink remains in the FINE Cartridge. See [Checking the Ink Status](#).
- Check if the FINE Cartridges are installed correctly. See [Replacing Procedure](#).
- Check if the orange protective tape on the bottom of the FINE Cartridge is removed. See [Replacing Procedure](#).
- If the **Alarm** lamp lights or flashes orange, refer to the " [Troubleshooting](#) " in the on-screen manual: [Advanced Guide](#).
- Increasing the print quality in the printer driver settings may improve the print result. For details, refer to the on-screen manual: [Advanced Guide](#).

When the Print Results Are Blurred or Uneven:

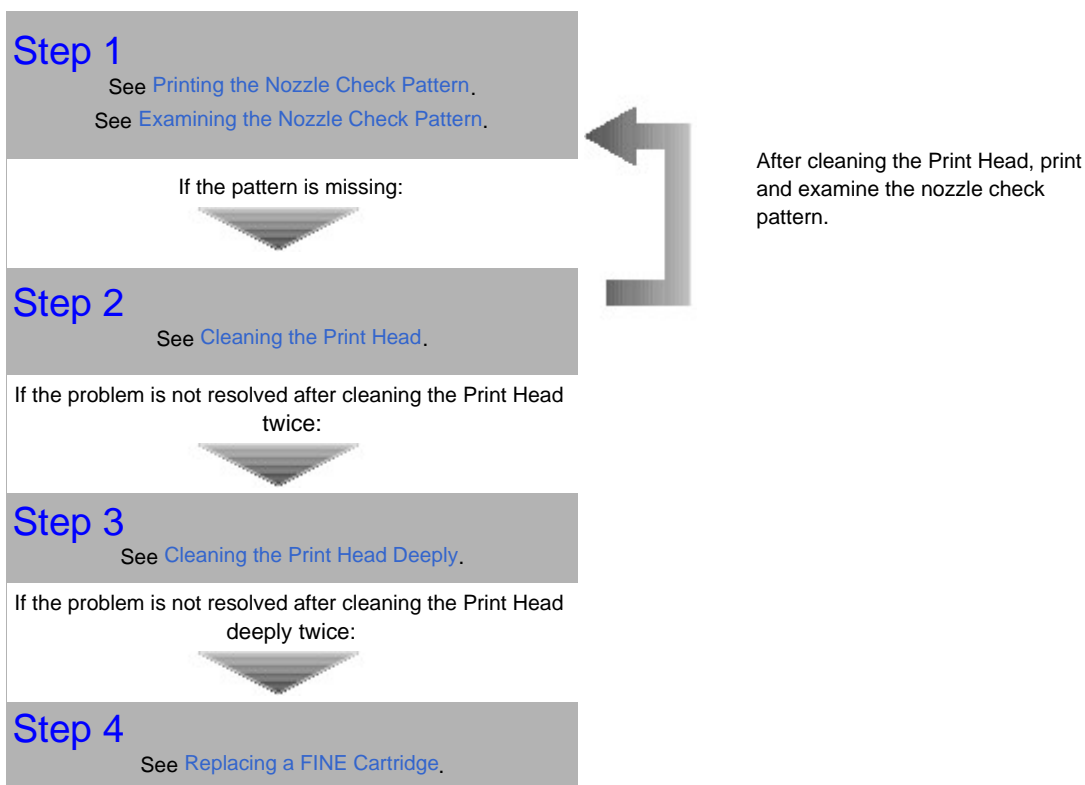

When the Print Results Are Not Even such as the Ruled Lines Are Misaligned:

See [Aligning the Print Head](#).

Note

- You can also perform the maintenance operations from your computer.

For details, refer to the on-screen manual: [Advanced Guide](#).



 [Page top](#)

[Contents](#) > [Routine Maintenance](#) > [When Printing Becomes Faint or Colors Are Incorrect](#) > [Printing the Nozzle Check Pattern](#)

■ Printing the Nozzle Check Pattern

Print the nozzle check pattern to determine whether the ink ejects properly from the print head nozzles.



Note

- If the remaining ink level is low, the nozzle check pattern will not be printed correctly. Replace the FINE Cartridge whose ink is low. See [Replacing a FINE Cartridge](#).

You need to prepare: a sheet of A4 or Letter-sized plain paper

1. Make sure that the power is turned on, and load a sheet of A4 or Letter-sized plain paper in the Rear Tray.
2. Open the Paper Output Tray gently, and open the Output Tray Extension.
3. Print the nozzle check pattern.
 - (1) Press the  (Maintenance) button repeatedly until **A** appears.



- (2) Press the **Black** or **Color** button.
The nozzle check pattern will be printed.

4. Examine the nozzle check pattern.
See [Examining the Nozzle Check Pattern](#).



[↑ Page top](#)

■ Examining the Nozzle Check Pattern

Examine the nozzle check pattern, and clean the Print Head if necessary.

1. Check if there are no missing lines in the pattern (1) or no white streaks in the pattern (2).

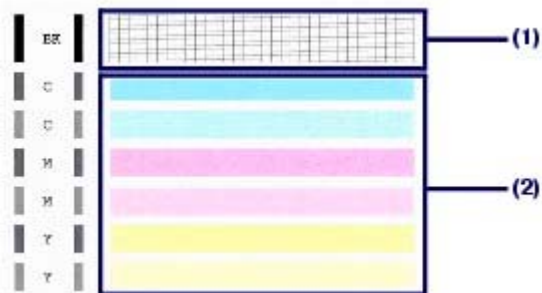

- (1) Check if lines are missing in this pattern.

If yes, the cleaning is required. See [Cleaning the Print Head](#).



(A) Good

(B) Bad (Lines are missing)

- (2) Check if white streaks are present in this pattern.

If yes, the cleaning is required. See [Cleaning the Print Head](#).



(A) Good

(B) Bad (White streaks are present)



[↑ Page top](#)

■ Cleaning the Print Head

Clean the Print Head if lines are missing or if white streaks are present in the printed nozzle check pattern. Cleaning unclogs the nozzles and restores the print head condition. Cleaning the Print Head consumes ink, so clean the Print Head only when necessary.

1. Make sure that the power is turned on.

2. Clean the Print Head.

(1) Press the  (Maintenance) button repeatedly until **H** appears.



(2) Press the **Black** or **Color** button.

The machine starts cleaning the Print Head.

Do not perform any other operations until the machine completes the cleaning of the Print Head. This takes about 1 to 2 minutes.

3. Check the print head condition.

When the cleaning is completed, the LED returns to the standby mode.

To check the print head condition, print the nozzle check pattern. See [Printing the Nozzle Check Pattern](#).



Note

- If the problem is not resolved after cleaning the Print Head twice, clean the Print Head deeply. See [Cleaning the Print Head Deeply](#).



[↑](#) Page top

[Contents](#) > [Routine Maintenance](#) > [When Printing Becomes Faint or Colors Are Incorrect](#) > [Cleaning the Print Head Deeply](#)

■ Cleaning the Print Head Deeply

If print quality does not improve by the standard cleaning of the Print Head, clean the Print Head deeply. Cleaning the Print Head deeply consumes more ink than the standard cleaning of the Print Head, so clean the Print Head deeply only when necessary.

1. Make sure that the power is turned on.

2. Clean the Print Head deeply.

(1) Press the  (Maintenance) button repeatedly until **y** appears.



(2) Press the **Black** or **Color** button.

The machine starts cleaning the Print Head deeply.

Do not perform any other operations until the machine completes the deep cleaning of the Print Head. This takes about 2 minutes.

3. Check the print head condition.

When the deep cleaning is completed, the LED returns to the standby mode.

To check the print head condition, print the nozzle check pattern. See [Printing the Nozzle Check Pattern](#).

If the problem is not resolved, clean the Print Head deeply again.

If the problem is still not resolved, ink may have run out. Replace the FINE Cartridge with a new one. See [Replacing a FINE Cartridge](#).



[↑ Page top](#)

■ Aligning the Print Head

If printed ruled lines are misaligned or print results are otherwise unsatisfactory, adjust the print head position.

You need to prepare: a sheet of A4 or Letter-sized plain paper

1. Make sure that the power is turned on, and load a sheet of A4 or Letter-sized plain paper in the Rear Tray.
2. Open the Paper Output Tray gently, and open the Output Tray Extension.
3. Print the print head alignment sheet.

(1) Press the  (Maintenance) button repeatedly until **u** appears.



Note

- Select **L** on the LED to print the current head position adjustment values.



(2) Press the **Black** or **Color** button.
The print head alignment sheet will be printed.

4. Adjust the print head position.
 - (1) Check the printed patterns, and fill in the corresponding circle with a dark pencil or a black ink pen to select the number of the pattern in column A that has the least noticeable streaks.

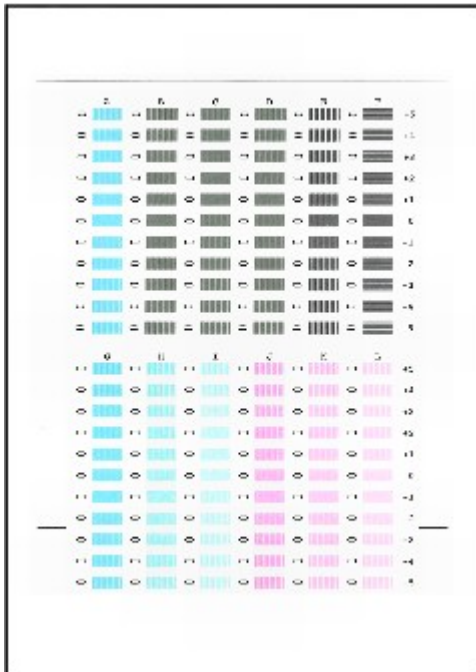

Note

- If it is difficult to select the best pattern, select the pattern that has the least noticeable white streaks.



(A)



(B)



(C)



(D)

- (A) Less noticeable vertical white streaks
- (B) More noticeable vertical white streaks
- (C) Less noticeable horizontal white streaks
- (D) More noticeable horizontal white streaks

- Repeat the same procedure until you finish selecting the number of the pattern in column L.

- Place the print head alignment sheet on the Platen Glass.

Place the print head alignment sheet with the filled-in side **FACING DOWN** and align the upper corner of the sheet with the alignment mark as shown below.

Then close the Document Cover gently.



- Make sure that **U** appears on the LED, and press the **Black** or **Color** button.

The print head alignment sheet is scanned and the print head position is adjusted automatically.

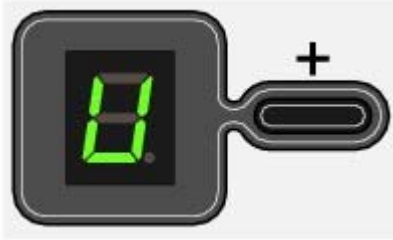

Important

- Do not open the Document Cover or move the loaded print head alignment sheet until scanning is completed.

Note

- If adjusting the print head position has failed, the error code appears on the LED.
For details, refer to the "[Troubleshooting](#)" in the on-screen manual: *Advanced Guide*.
- If the print results are still not satisfactory after adjusting the print head position as described above, adjust the print head position from the computer.
For details, refer to the on-screen manual: [Advanced Guide](#).



 [Page top](#)

Replacing a FINE Cartridge

When ink runs out while printing, the **Ink** lamp flashes orange and the error code appears on the LED to inform you of the error.



Note

- For information on the compatible FINE Cartridges, refer to the printed manual: *Getting Started*.
-



[↑ Page top](#)

■ Checking the Ink Status

You can check the ink status on the computer screen or with the **Ink** lamps on the Operation Panel.



Note

- The ink level detector is mounted on the machine to detect the remaining ink level. The machine considers as ink is full when a new FINE Cartridge is installed, and then starts to detect a remaining ink level. If you install a used FINE Cartridge, the indicated ink level of it may not be correct. In such case, refer to the ink level information only as a guide.

● With the Ink Lamps on the Operation Panel

Make sure that the LED is in the standby mode. You can confirm the status of each FINE Cartridge by the **Ink** lamps.

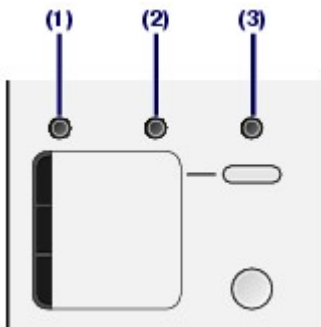

- (1) Alarm lamp
- (2) Color Ink lamp
- (3) Black Ink lamp

Color Ink lamp or Black Ink lamp lights

Ink is low. You can continue printing for a while, but we recommend you to have a new FINE Cartridge available.

Color Ink lamp or Black Ink lamp flashes, while Alarm lamp lights

- If "E, 1, 6" appears on the LED, ink has run out.
Refer to the "[Troubleshooting](#)" in the on-screen manual: *Advanced Guide*.
- If "E, 1, 3" appears on the LED, ink may have run out.
Refer to the "[Troubleshooting](#)" in the on-screen manual: *Advanced Guide*.

Color Ink lamp or Black Ink lamp flashes, while Alarm lamp is off

The function for detecting the remaining ink level is disabled.

● With the Computer Screen

You can confirm the status of each FINE Cartridge on the printer status monitor (Windows) or Canon IJ Printer Utility (Macintosh).





(A) Check if any symbol appears on the screen.



The ink is running low.

(Ink low) You can continue printing for a while, but we recommend you to have a new FINE Cartridge available.



Note

- An error message may appear while printing. Confirm the message and take an appropriate action.

Follow the procedure below to open each of the confirmation screens.



1. Open the printer properties dialog box from the Control Panel.

Refer to the on-screen manual: [Advanced Guide](#).

2. Click View Printer Status on the Maintenance sheet.

To confirm the FINE Cartridge information, click the Ink Details menu.



Note

- You can also display the printer status monitor by clicking Canon XXX Printer (where "XXX" is your machine's name) which appears on the taskbar during printing.



1. Open the Canon IJ Printer Utility.

Refer to the on-screen manual: [Advanced Guide](#).

2. Select Ink Level Information in the pop-up menu.

To confirm the FINE Cartridge information, click Ink Details.



[↑ Page top](#)

■ Replacing Procedure

When FINE Cartridges run out of ink, follow the procedure below to replace them.

⚠ Important

Handling FINE Cartridges

- Do not touch the electrical contacts or print head nozzles on a FINE Cartridge. The machine may not print properly if you touch it.

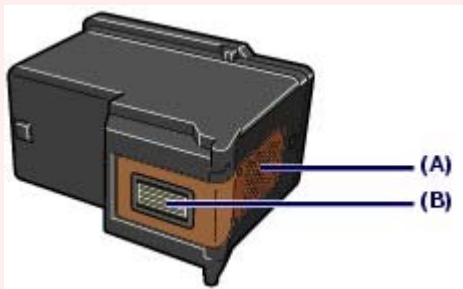

(A) Electrical contacts

(B) Print head nozzles

- To maintain optimal print quality, we recommend the use of specified Canon brand FINE Cartridges. Refilling ink is not recommended.
- If you remove a FINE Cartridge, replace it immediately. Do not leave the machine with FINE Cartridges removed.
- Use new FINE Cartridges for replacement. Installing used FINE Cartridges may cause the nozzles to clog. Furthermore, with such cartridges, the machine will not be able to inform you when to replace the cartridges properly.
- To maintain optimal print quality, install FINE Cartridges in the machine within the date indicated on the package box. And also use FINE Cartridges within 6 months of first use. (We recommend you to put down the date when installing them.)



Note

- If a FINE Cartridge runs out of ink, you can print with either Color or Black FINE Cartridge, in whichever ink remains, only for a while. However the print quality may be reduced compared to when printing with both cartridges. We recommend to use new FINE Cartridges in order to obtain optimum qualities. Even when printing with one ink only, print with leaving the empty FINE Cartridge installed. If either of the Color FINE Cartridge or Black FINE Cartridge is not installed, an error occurs and the machine cannot print. For information on how to configure this setting, refer to the on-screen manual: [Advanced Guide](#).
- Color ink may be consumed even when printing a black-and-white document or when black-and-white printing is specified. Every ink is also consumed in the standard cleaning and deep cleaning of the Print Head, which may be necessary to maintain the machine's performance. When ink has run out, replace the FINE Cartridge immediately with a new one.

1. Make sure that the power is turned on, and open the Paper Output Tray.
2. Lift the Scanning Unit (Cover), then hold it open with the Scanning Unit Support (C).
The FINE Cartridge Holder moves to the replacement position.



⚠ Caution

- The inside of the machine may be stained with ink. Be careful not to stain your hands or clothing when replacing FINE Cartridges. You can easily wipe off the ink from the inside of the machine with a dry cloth or the like. For details on the cleaning, refer to the printed manual: *Getting Started*.
- When opening the Scanning Unit (Cover), lift it with the Document Cover closed.
- Do not hold the FINE Cartridge Holder to stop or move it forcibly.
- Do not touch the metallic parts or other parts inside the machine.

⚠ Important

- If the Scanning Unit (Cover) is left open for more than 10 minutes, the FINE Cartridge Holder moves to the right. In this case, close and reopen the Scanning Unit (Cover).

3. Remove the empty FINE Cartridge.

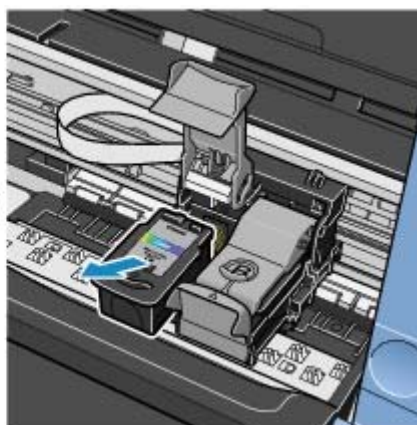
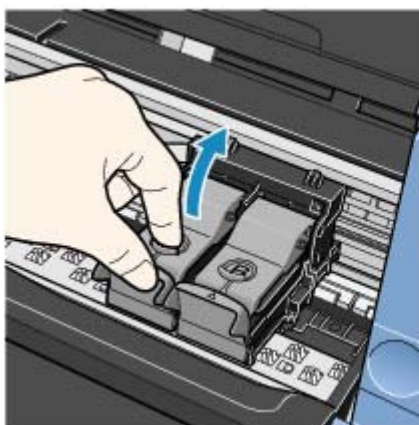

- (1) Pinch the tabs and open the Ink Cartridge Locking Cover.
- (2) Remove the FINE Cartridge.

⚠ Important

- Handle FINE Cartridges carefully to avoid staining of clothing or the surrounding area.
- Discard empty FINE Cartridges according to the local laws and regulations regarding disposal of consumables.

4. Prepare the new FINE Cartridge.

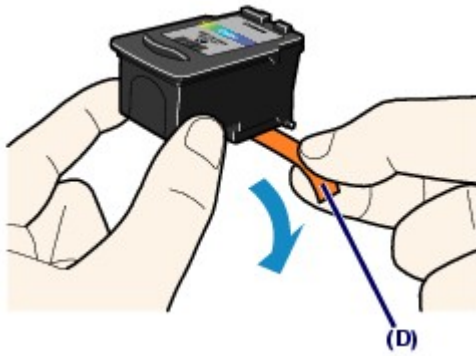

- (1) Take a new FINE Cartridge out of its package and remove the orange protective tape (D) gently.

 **Important**

- If you shake a FINE Cartridge, ink may spill out and stain your hands and the surrounding area. Handle a FINE Cartridge carefully.
- Be careful not to stain your hands and the surrounding area with ink on the removed protective tape.
- Do not reattach the protective tape once you have removed it. Discard it according to the local laws and regulations regarding disposal of consumables.
- Do not touch the electrical contacts or print head nozzles on a FINE Cartridge. The machine may not print properly if you touch it.

5. Install the FINE Cartridge.

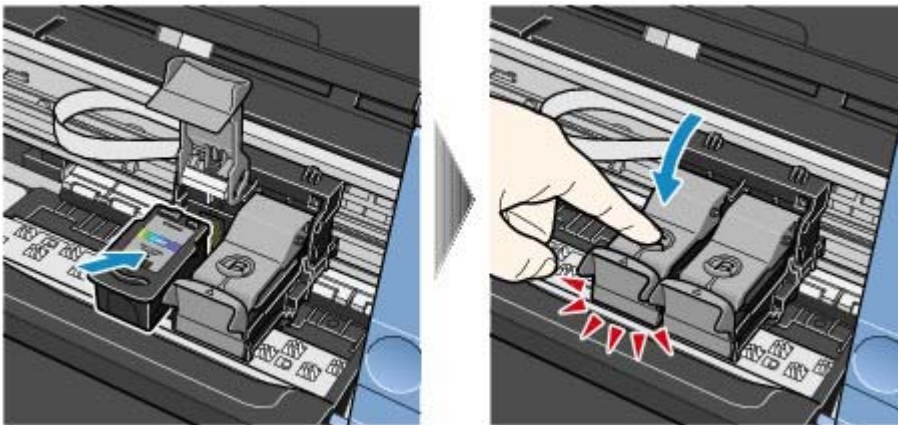

- (1) Put a new FINE Cartridge in the FINE Cartridge Holder.
The Color FINE Cartridge should be installed into the left slot and the Black FINE Cartridge should be into the right slot.
- (2) Close the Ink Cartridge Locking Cover to lock the FINE Cartridge into place.
Push down the Ink Cartridge Locking Cover until it clicks.
- (3) Confirm that the Ink Cartridge Locking Cover is closed correctly.

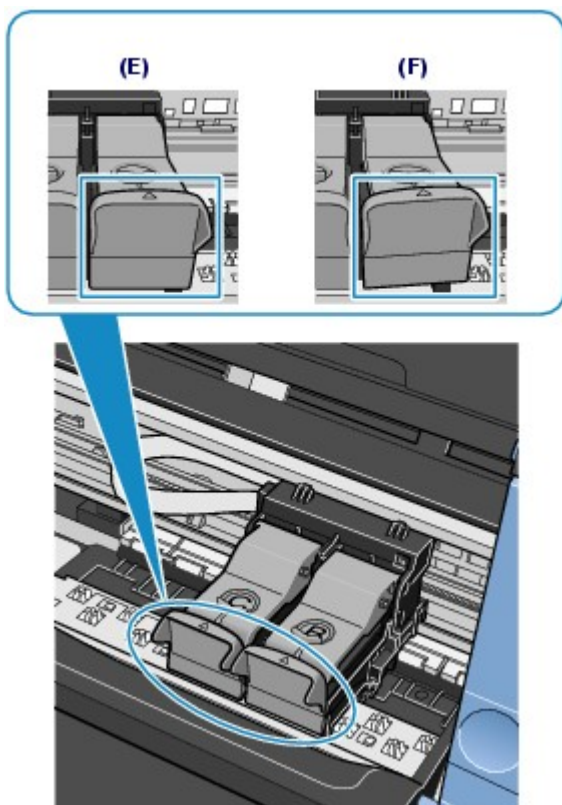

(E) Closed correctly

(F) Not closed correctly (the cover is tilted)



Note

- If the Ink Cartridge Locking Cover is not closed correctly, push down the Ink Cartridge Locking Cover until it clicks.



Important

- The machine cannot print unless both the Color and Black FINE Cartridges are installed. Be sure to install both the FINE Cartridges.

6. Lift the Scanning Unit (Cover) slightly to set the Scanning Unit Support back to its original position, and gently close the Scanning Unit (Cover).

If you replaced the FINE Cartridge while printing, the machine resumes printing automatically.



Caution

- When setting the Scanning Unit Support back to its original position, be sure to hold the Scanning Unit (Cover) firmly, and be careful not to get your fingers caught.



Note

- If the **Alarm** lamp lights or flashes orange after the Scanning Unit (Cover) is closed, refer to the "[Troubleshooting](#)" in the on-screen manual: *Advanced Guide*.
- When you start printing after replacing the FINE Cartridge, the machine starts cleaning the Print Head automatically. Do not perform any other operations until the machine completes the cleaning of the Print Head.
- If ruled lines are printed with misaligned or the print head position is misaligned, adjust the print head position. See [Aligning the Print Head](#).



Cleaning the Machine

This section describes how to clean the inside of the machine.



[↑ Page top](#)

■ Cleaning the Paper Feed Roller

If the Paper Feed Roller is dirty or paper powder is attached to it, paper may not be fed properly. In this case, clean the Paper Feed Roller. Cleaning will wear out the Paper Feed Roller, so perform this only when necessary.

You need to prepare: three sheets of A4 or Letter-sized plain paper

1. Make sure that the power is turned on, and remove any paper from the Rear Tray.
2. Clean the Paper Feed Roller.
 - (1) Press the  (Maintenance) button repeatedly until **b** appears.



- (2) Press the **Black** or **Color** button.
The Paper Feed Roller will rotate as it is cleaned.

3. Make sure that the Paper Feed Roller stops rotating, and load three sheets of A4 or Letter-sized plain paper in the Rear Tray.
4. Open the Paper Output Tray gently, and open the Output Tray Extension.
5. Repeat the procedure in step 2 again.
The paper is ejected after cleaning.

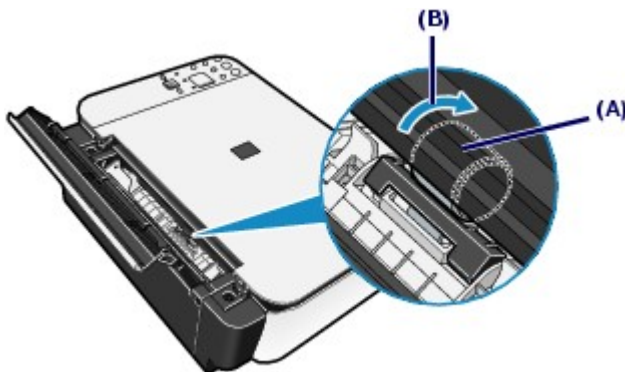

If the problem is not resolved after cleaning the Paper Feed Roller (A) as described above, turn off the power, unplug the power cord, then wipe the Paper Feed Roller located in the center inside the Rear Tray with a moistened cotton swab or the like. Rotate the roller manually in the direction of the arrow (B) as you clean it. Do not touch the roller with your fingers; rotate it with the cotton swab.

If this does not solve the problem, contact your Canon service representative.



 [Page top](#)

Basic Guide■ **Advanced Guide** ■ **Troubleshooting**[Contents](#) > [Routine Maintenance](#) > [Cleaning the Machine](#) > [Cleaning the Inside of the Machine \(Bottom Plate Cleaning\)](#)**■ Cleaning the Inside of the Machine (Bottom Plate Cleaning)**

Remove stains from the inside of the machine. If the inside of the machine becomes dirty, printed paper may get dirty, so we recommend performing cleaning regularly.

Important

- Do not perform any other operations while performing the Bottom Plate Cleaning.

You need to prepare: a sheet of A4 or Letter-sized plain paper

1. Make sure that the power is turned on, and remove any paper from the Rear Tray.
2. Fold a single sheet of A4 or Letter-sized plain paper in half widthwise, and unfold the paper.
3. Load only this sheet of paper in the Rear Tray with the open side facing you.



4. Open the Paper Output Tray gently, and open the Output Tray Extension.
5. Clean the inside of the machine.

(1) Press the  (Maintenance) button repeatedly until **J** appears.



(2) Press the **Black** or **Color** button.

The paper cleans the inside of the machine as it feeds through the machine.

Check the folded area of the ejected paper. If it is smudged with ink, perform the Bottom Plate Cleaning again.

If the problem is not resolved after performing the Bottom Plate Cleaning twice, the protrusions inside the machine may be stained. See [Cleaning the Protrusions inside the Machine](#) to clean them.

Note

- When performing the Bottom Plate Cleaning again, make sure to use a new piece of paper.
-



[↑ Page top](#)

■ Cleaning the Protrusions inside the Machine

⚠ Caution

- Be sure to turn off the power and unplug the power cord before cleaning the machine.

If the protrusions inside the machine are stained, wipe off any ink from the protrusions using a cotton swab or the like.

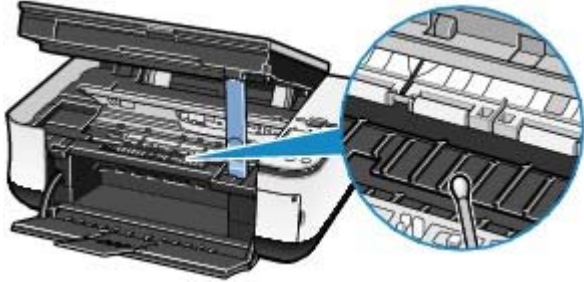

[↑ Page top](#)

Appendix

[Safety Precautions](#)

[Legal Limitations on Use of Your Product and Use of Images](#)

[Tips on How to Use Your Machine](#)



[↑ Page top](#)

⚠ Safety Precautions

Please read the safety warnings and cautions provided in this manual to ensure that you use the machine safely. Do not attempt to use the machine in any way not described in this manual. It causes unexpected accident, fire, or electrical shock.

⚠ Warning



- You may cause an electric shock, fire, or damage the machine if you ignore any of these safety precautions.

<p>Choosing a location</p>	<p>Do not place the machine close to flammable solvents such as alcohol or thinners.</p>
<p>Power supply</p>	<p>Never attempt to plug in or unplug the machine from the power supply when your hands are wet.</p> <p>Always push the plug all the way into the power outlet.</p> <div data-bbox="360 779 635 972"> </div> <p>Never damage, modify, stretch or excessively bend or twist the power cord. Do not place heavy objects on the power cord.</p> <div data-bbox="360 994 635 1187"> </div> <p>Never plug the machine into a power socket that is shared with other equipment (extension lead/cord, 2- or 3-way adapter, etc.).</p> <p>Never use the machine if the power cord is bundled or knotted.</p> <p>If you detect smoke, unusual smells or strange noises around the machine, immediately unplug the machine at the power supply and call for service.</p> <div data-bbox="360 1397 635 1590"> </div> <p>Periodically, unplug the machine and use a dry cloth to wipe off any dust or dirt collected on the plug and the power outlet. If the machine is placed at a location exposed to a lot of dust, smoke, or high humidity, the dust collected on the plug absorbs moisture and may cause insulation failure and fire.</p> <p>If you hear thunder, disconnect the power supply of the machine and refrain from using it. Leaving the machine plugged in may cause fire, electric shock, or damage to the machine, depending on the thunder storm.</p> <p>Use the power cable included with the machine.</p>
<p>Cleaning the machine</p>	<div data-bbox="360 1868 635 2060"> </div> <p>Use a damp cloth to clean the machine. Never use flammable solvents such as alcohol, benzene or thinners.</p> <p>If flammable solvents come in contact with electrical components inside the machine, it could cause a fire or electric shock.</p> <p>Always unplug the machine from the power outlet before cleaning the machine.</p> <p>If you accidentally switch the machine on while cleaning it, you could</p>

	injure yourself or damage the machine.
Maintaining the machine	Do not attempt to disassemble or modify the machine. There are no user serviceable parts inside the machine. The machine contains high-voltage components. Never attempt any maintenance procedure not described in this guide.
Working around the machine	Do not use highly flammable sprays near the machine. This could cause a fire or electric shock if the spray comes into contact with electrical components inside the machine.

Caution

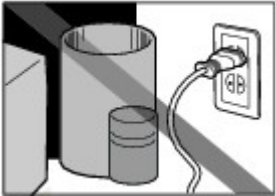
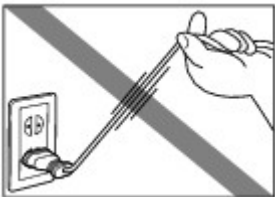
- You may cause injury or damage the machine if you ignore any of these safety precautions.

Choosing a location	Do not install the machine in a location that is unstable or subject to excessive vibration.
	Do not install the machine in locations that are very humid or dusty, in direct sunlight, outdoors, or close to a heating source. To avoid the risk of fire or electric shocks, install the machine in a location with an ambient temperature range of 5°C to 35°C (41°F to 95°F) and humidity of 10% to 90% (condensation free).
	Do not place the machine on a thick rug or carpet.
	Do not place the machine with its back attached to the wall.
Power supply	 Ensure that the area around the power outlet is kept clear at all times so you can easily unplug the power cord if necessary.
	 Never remove the plug by pulling on the cord.
	 Do not use an extension lead/cord.
Working around the machine	Never put your hands or fingers in the machine while it is printing.
	Do not place any object on the machine.
	Do not place metal objects (paper clips, staples, etc.) or containers of flammable solvents (alcohol, thinners, etc.) on top of the machine.
	If any foreign object (metal or liquid) fall into the machine, unplug the power cord and call for service.
	Do not transport or store the machine on a slant, vertically or upside-down, as the ink may leak and damage the machine.
	When loading a thick book on the Platen Glass, do not press hard on the Document Cover. The Platen Glass may break and cause injury.
FINE Cartridges	Keep FINE Cartridges (Ink Cartridges) out of the reach of

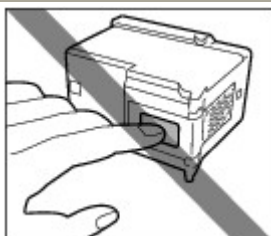
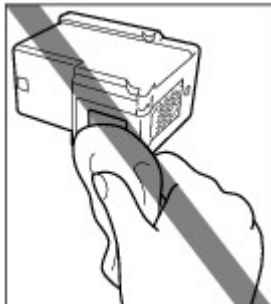
(Ink Cartridges)	<p>children. In case ink is accidentally licked or swallowed, rinse out mouth or give one or two glasses of water to drink. If irritation or discomfort occurs, obtain medical advice immediately.</p> <p>In case ink gets in contact with eyes, rinse with water immediately. In case ink gets in contact with skin, wash with soap and water immediately. If irritation to eyes or skin persists, obtain medical advice immediately.</p> <p>Do not shake FINE Cartridges (Ink Cartridges). Ink may spill out and stain clothing or the surrounding area.</p> <div data-bbox="384 472 655 707">  </div> <p>Never touch the electrical contacts or print head nozzles on a FINE Cartridge (Ink Cartridge) after printing. The metal parts may be very hot and could cause burns.</p> <p>Do not throw FINE Cartridges (Ink Cartridges) into fire.</p> <p>Do not attempt to disassemble or modify the FINE Cartridges.</p> <p>Do not handle the FINE Cartridges roughly such as applying them excessive pressure or dropping them.</p> <p>Do not rinse or wipe the FINE Cartridges.</p> <div data-bbox="384 976 655 1279">  </div> <p>Once you have installed the FINE Cartridges, do not remove them unnecessarily.</p>
-------------------------	---

- **Note when you place the machine near other electrical appliances such as fluorescent lamps**
Place the machine at least 5.91 inches / 15 cm away from other electrical appliances such as fluorescent lamps. If the machine is placed closer to those, it may not be able to work properly due to fluorescent noises.

- **When you turn off the power**

When you turn off the power, always press the **ON** button and be sure that the **Power** lamp (in green) has gone out. If you disconnect the power plug from the power outlet when the **Power** lamp lights or flashes, the Print Head cannot be protected and you may not be able to print later.



[↑ Page top](#)

Legal Limitations on Use of Your Product and Use of Images

It may be unlawful to make copies of, scan, print, or use reproductions of the following documents.

The list provided is non-exhaustive. When in doubt, check with a legal representative in your jurisdiction.

- Paper money
- Money orders
- Certificates of deposit
- Postage stamps (canceled or uncanceled)
- Identifying badges or insignias
- Selective service or draft papers
- Checks or drafts issued by governmental agencies
- Motor vehicle licenses and certificates of title
- Traveler's checks
- Food stamps
- Passports
- Immigration papers
- Internal revenue stamps (canceled or uncanceled)
- Bonds or other certificates of indebtedness
- Stock certificates
- Copyrighted works/works of art without permission of copyright owner



[↑ Page top](#)

Tips on How to Use Your Machine

This section introduces the tips on how to use your machine and for printing with optimal quality.

■ Ink is used for various purposes.

● How is ink used for various purposes other than printing?

Ink may be used for purposes other than printing. Ink is not only used for printing, but also for cleaning the Print Head to maintain the optimal printing quality.

The machine has the function to automatically clean the ink jet nozzles to prevent clogging. In the cleaning procedure, ink is pumped out from the nozzles. Used ink for nozzle cleaning is limited to a small amount.



Important

- The ink pumped out from the nozzles, such as when cleaning the Print Head, is absorbed by ink absorber in the machine. The ink absorber needs to be replaced when it is full. You cannot replace it by yourself. When the error code or message appears, contact your Canon service representative as soon as possible.
Refer to the "[Troubleshooting](#)" in the on-screen manual: *Advanced Guide*.

● Does black-and-white printing use color ink?

The use of color or black ink varies depending on the color of image to be printed or the contents of document. Black-and-white printing may also use color ink. So, color ink is consumed even when printing in black-and-white.

■ Printing on special paper: How to print with optimal quality!?

● Tip!: Check the machine status before printing!

● Is the Print Head ok?

If print head nozzles are clogged, print will be faint and papers will be wasted. Print the nozzle check pattern to check the Print Head.

See [When Printing Becomes Faint or Colors Are Incorrect](#) .

● Is the inside of the machine smeared with ink?

After printing large quantities of paper or performing borderless printing, the area where papers go through may get smeared with ink. Clean the inside of your machine with the Bottom Plate Cleaning.

See [Cleaning the Inside of the Machine \(Bottom Plate Cleaning\)](#) .

● Tip!: Check how to load the paper correctly!

● Is the paper loaded in the correct orientation?



To load paper in the Rear Tray, load paper with the printing side facing you.

● Is the paper curled?

The curled paper causes paper jam. Flatten the curled paper, then reload it.

Refer to the "[Troubleshooting](#)" in the on-screen manual: *Advanced Guide*.

● Tip!: After loading paper, be sure to specify the paper settings!

After loading paper, be sure to select the loaded paper in Media Type of the printer driver or with the **Paper** button on the Operation Panel. If the type of paper is not selected, you may not be able to get the satisfactory print result.

See [Loading Paper](#).

There are various types of paper: paper with special coating on the surface for printing photos with optimal quality and paper suitable for documents. Media Type of the printer driver has different settings for each type of paper in advance (such as using ink, ejecting ink, or distance from nozzles) so that you can print on each paper with the optimal image quality. The **Paper** button on the Operation Panel, which is used for making copies, also has some settings similar to Media Type of the printer driver. You can print with different settings in Media Type of the printer driver or with the **Paper** button on the Operation Panel, suitable for each type of loaded paper.

■ Use the Stop/Reset button to cancel printing!

● Tip!: Never press the ON button!

If you press the **ON** button while printing is in progress, the print data sent from the computer queues in the machine and you may not be able to continue to print.

Press the **Stop/Reset** button to cancel printing.



Note

- If you cannot cancel printing by pressing the **Stop/Reset** button while printing from a computer, open the printer properties dialog box to delete the unnecessary print jobs from the printer status monitor (Windows).

■ How to maintain the optimal printing quality?

The key to printing with the optimal printing quality is to prevent the Print Head from drying or clogging. Always follow the following steps for optimal printing quality.

● Follow the procedure below to turn the power off.

- 1 Press the **ON** button on the machine to turn it off.
- 2 Be sure that the **Power** lamp is not lit.
- 3 Unplug the power cord from the wall outlet, or turn off the extender cable connector.

If you press the **ON** button to turn off the power, the machine caps the Print Head (nozzles) automatically to prevent from drying. If you unplug the power cord from the wall outlet or turn off the extender cable connector before the **Power** lamp is turned off, the Print Head will not be capped properly and this will cause drying or clogging.

To turn off the power, be sure to follow this procedure.

● Print periodically!

Just as the tip of a felt pen becomes dry and unusable if it has not been used for a long time, even if it is capped, the Print Head too, may become dried or clogged if the machine has not been used for a long time.

We recommend the machine to be used at least once a month.



Note

- Depending on the type of paper, ink may blur if you trace the printed area with a highlight pen or paint-stick, or bleed if water or sweat comes in contact with the printed area.

- Does the machine need to be handled with care when storing or transporting?

- **Tip!: Do not store or transport the machine vertically or slanted!**

If the machine is stored or transported vertically or slanted, the machine may become damaged or ink may leak from the machine.

Be sure not to store or transport the machine vertically or slanted.



- Colors are uneven, and print results are blurred.

- **Tip!: Print the nozzle check pattern to check if the nozzles are clogged.**

If the print head nozzles are clogged, colors may become uneven or the print results may be blurred.



In this case



Print the nozzle check pattern

Check the printed check pattern to see if the nozzles are clogged.

See [When Printing Becomes Faint or Colors Are Incorrect](#) .



[↑ Page top](#)

Basic Guide 

Printing

Scanning

Copying

Troubleshooting

How to Use This Manual

Printing This Manual

Maintenance

Changing the Machine Settings

Appendix

When you display this On-screen Manual in a language environment other than English, some English descriptions may be displayed.

Printing

Printing from a Computer

Printing with the Bundled Application Software

What Is Easy-PhotoPrint EX?

Printing Photos

Starting Easy-PhotoPrint EX

Selecting a Photo

Selecting the Paper

Printing

Creating an Album

Starting Easy-PhotoPrint EX

Selecting the Paper and Layout

Selecting a Photo

Editing

Printing

Printing Calendars

Starting Easy-PhotoPrint EX

Selecting the Paper and Layout

Selecting a Photo

Editing

Printing

Printing Stickers

Starting Easy-PhotoPrint EX

Selecting the Paper and Layout

Selecting a Photo

Editing

Printing

Printing Layout

Starting Easy-PhotoPrint EX

Selecting the Paper and Layout

Selecting a Photo

Editing

Printing

Correcting and Enhancing Photos

Using the Auto Photo Fix Function

Using the Red-Eye Correction Function

Using the Face Brightener Function

Using the Face Sharpener Function

Using the Digital Face Smoothing Function

Using the Blemish Remover Function

Adjusting Images

Correct/Enhance Images Window

Questions and Answers

How Can I Move (or Copy) the Saved File?

Which Side of the Displayed Image Does the Printing Start from?

How Do I Print with Even Margins?

What Is "C1" or "C4"?

Appendix 1: Easy-PhotoPrint EX Settings

Printing Vivid Photos

Reducing Photo Noise

Cropping Photos (Photo Print)

Printing Dates on Photos (Photo Print)

Printing Multiple Photos on One Page

Printing an Index

Printing ID Photos (ID Photo Print)

Printing Photo Information

Saving Photos

Opening Saved Files

Changing Layout

Changing Background

Adding Photos

Swapping Positions of Photos

Replacing Photos

Changing Position, Angle and Size of Photos

Cropping Photos

Framing Photos

Printing Dates on Photos

Attaching Comments to Photos

Adding Text to Photos

Saving

Setting Holidays

Setting Calendar Display

Printing with Other Application Software

Various Printing Methods

Printing with Easy Setup

Setting a Page Size and Orientation

Setting the Number of Copies and Printing Order

Setting the Stapling Margin

Borderless Printing

Fit-to-Page Printing

Scaled Printing

Page Layout Printing

Poster Printing

Booklet Printing

Duplex Printing

Stamp/Background Printing

Saving a Stamp Setting

Saving Image Data to be Used as a Background

Printing an Envelope

- Displaying the Print Results before Printing
- Setting Paper Dimensions (Custom Size)
- Changing the Print Quality and Correcting Image Data
 - Selecting a Combination of the Print Quality Level and a Halftoning Method
 - Printing a Color Document in Monochrome
 - Specifying Color Correction
 - Optimal Photo Printing of Image Data
 - Adjusting Colors with the Printer Driver
 - Printing with ICC Profiles
 - Adjusting Color Balance
 - Adjusting Brightness
 - Adjusting Intensity
 - Adjusting Contrast
 - Simulating an Illustration
 - Representing Image Data with a Single Color
 - Presenting Image Data with Vivid Colors
 - Smoothing Jagged Outlines
 - Changing Color Properties to Improve Coloration
 - Reducing Photo Noise
- Overview of the Printer Driver
 - Canon IJ Printer Driver
 - How to Open the Printer Driver Setup Window
 - Maintenance Tab
 - Canon IJ Status Monitor
 - The Canon IJ Preview

Printing Photographs Directly from a Compliant Device (MP240 series)

- Printing Photographs Directly from a Compliant Device
 - Printing Photographs Directly from a Compliant Device
 - About PictBridge Print Settings
 - Settings on a PictBridge Compliant Device

Scanning

Scanning

- Scanning Images
 - Scanning Images
 - Before Scanning
 - Placing Documents
 - Saving Scanned Data to PC Using the Operation Panel of the Machine
 - Appendix: Various Scan Settings
 - Selecting a Response to Commands from the Operation Panel Using MP Navigator EX
- Scanning with the Bundled Application Software
 - What Is MP Navigator EX (Supplied Scanner Software)?
 - Let's Try Scanning
 - Starting MP Navigator EX
 - Scanning Photos and Documents
 - Scanning Multiple Documents at One Time

- Scanning Images Larger than the Platen (Stitch Assist)

- Easy Scanning with One-click

- Useful MP Navigator EX Functions

- Correcting/Enhancing Images Automatically

- Correcting/Enhancing Images Manually

- Adjusting Images

- Searching Images

- Classifying Images into Categories

- Utilizing Images in MP Navigator EX

- Saving

- Saving as PDF Files

- Creating/Editing PDF Files

- Printing Documents

- Printing Photos

- Sending via E-mail

- Editing Files

- Setting Passwords for PDF Files

- Opening/Editing Password-protected PDF Files

- MP Navigator EX Screens

- Navigation Mode Screen

- Scan/Import Documents or Images Tab

- View & Use Images on your Computer Tab

- Custom Scan with One-click Tab

- Photos/Documents (Platen) Screen (Scan/Import Window)

- Scan Settings Dialog Box (Photos/Documents)

- Save Dialog Box

- Save as PDF file Dialog Box

- PDF Settings Dialog Box

- Memory Card Screen (Scan/Import Window)

- View & Use Window

- Create/Edit PDF file Window

- Print Document Dialog Box

- Print Photo Dialog Box

- Send via E-mail Dialog Box

- Correct/Enhance Images Window

- One-click Mode Screen

- Save Dialog Box (One-click Mode Screen)

- Scan Settings Dialog Box

- Save Dialog Box

- Exif Setting Dialog Box

- PDF Dialog Box

- Save as PDF file Dialog Box

- Mail Dialog Box

- OCR Dialog Box

- Custom Dialog Box

- Preferences Dialog Box

- Scanner Button Settings Tab (Save)

- Appendix: Opening Files Other than Scanned Images

- Importing Images Saved on a Memory Card
- Opening Images Saved on a Computer
- Scanning with Other Application Software
 - What Is ScanGear (Scanner Driver)?
 - Scanning with Advanced Settings Using ScanGear (Scanner Driver)
 - Starting ScanGear (Scanner Driver)
 - Scanning in Basic Mode
 - Scanning in Advanced Mode
 - Scanning in Auto Scan Mode
 - Scanning Multiple Documents at One Time in Advanced Mode
 - Correcting Images and Adjusting Colors
 - Correcting Images (Unsharp Mask, Reduce Dust and Scratches, Fading Correction, etc.)
 - Adjusting Colors Using a Color Pattern
 - Adjusting Saturation and Color Balance
 - Adjusting Brightness and Contrast
 - Adjusting Histogram
 - Adjusting Tone Curve
 - Setting Threshold
 - ScanGear (Scanner Driver) Screens
 - Basic Mode Tab
 - Advanced Mode Tab
 - Input Settings
 - Output Settings
 - Image Settings
 - Color Adjustment Buttons
 - Auto Scan Mode Tab
 - Preferences Dialog Box
 - Scanner Tab
 - Preview Tab
 - Scan Tab
 - Color Settings Tab
 - Appendix: Useful Information on Scanning
 - Adjusting Cropping Frames
 - Resolution
 - File Formats
 - Color Matching
 - Other Scanning Methods
 - Scanning with WIA Driver
 - Scanning using the Control Panel (Windows XP Only)

Copying

Printing Using the Operation Panel of the Machine

- Copying
 - Making copies
 - Reducing or Enlarging a Copy
 - Using Useful Copy Functions
 - Switching the Page Size between A4 and Letter

Copying without Borders (Borderless Copy)

Troubleshooting**Troubleshooting**

If an Error Occurs

The Machine Can Not Be Powered On

LED Cannot Be Seen At All

An Error Code Is Displayed on the LED

Alarm Lamp Flashes Orange

Power Lamp Flashes Green and Alarm Lamp Flashes Orange Alternately

Cannot Install the MP Drivers

Cannot Connect to Computer Properly

Printing or Scanning Speed Is Slow / Hi-Speed USB Connection Does Not Work/"This device can perform faster" Message Is Displayed

Print Results Not Satisfactory

Cannot Print to End of Job

No Printing Results/Printing Is Blurred/Colors Are Wrong/White Streaks

Colors Are Unclear

Lines Are Misaligned

Printed Paper Curls or Has Ink Blots

Paper Is Smudged/Printed Surface Is Scratched

Back of the Paper Is Smudged

Vertical Lines Are Printed on the Sides of the Printout

Colors Are Uneven or Streaked

Printing Does Not Start

Copying/Printing Stops Before It Is Completed

Machine Moves But Ink Is Not Ejected

Printing Speed Not as Fast as Expected

FINE Cartridge Holder Does Not Move to the Position for Replacing

Paper Does Not Feed Properly

Paper Jams

Message Appears on the Computer Screen

Service Error 5100 Is Displayed

Writing Error/Output Error/Communication Error

Error Number: 300 Is Displayed

Error Number: 1700 Is Displayed

Ink Info Number: 1688 Is Displayed

Ink Info Number: 1686 Is Displayed

Error Number: 2001 Is Displayed (MP240 series)

Error Number: 2002 Is Displayed (MP240 series)

Other Error Messages

For Windows Users

Printer Status Monitor Is Not Displayed

The Inkjet Printer/Scanner Extended Survey Program screen is displayed

Error Message Appears on a PictBridge Compliant Device (MP240 series)

Cannot Print Properly from a Photo Index Sheet (MP260 series)

Cannot Remove a Memory Card (MP260 series)

Problems with Scanning

Scanner Does Not Work

ScanGear (Scanner Driver) Does Not Start

Error Message Appears and the ScanGear (Scanner Driver) Screen Does Not Appear

Scan Quality (Image Displayed on the Monitor) Is Poor

Scanned Image Is Surrounded by Extra White Areas

Cannot Scan Properly with Multi Crop

Slow Scanning Speed

"There is not enough memory." Message Is Displayed

Computer Stops Operating during Scanning

Scanner Does Not Work After Upgrading Windows

Software Problems

E-mail Software Program You Want to Use Does Not Appear in the Screen for Selecting an E-mail Software Program

Scanned Image Is Printed Enlarged (Reduced)

Scanned Image Is Enlarged (Reduced) on the Computer Monitor

Scanned Image Does Not Open

MP Navigator EX Problems

Cannot Scan at the Correct Size

Position or Size of the Image Cannot Be Detected Correctly When Scanning Using the Operation Panel

Document Is Placed Correctly, but the Scanned Image Is Slanted

Document Is Placed Correctly, but the Orientation Changes in the Scanned Image

FAQs

If You Cannot Resolve the Problem

Instructions for Use (Printer Driver)

General Notes (Scanner Driver)

Using Easy-PhotoPrint EX

Using MP Navigator EX

About Solution Menu

Advanced Guide

Advanced Guide > How to Use This Manual

How to Use This Manual

- ➔ [Operating the Contents Screen](#)
- ➔ [Operating the Explanation Screen](#)
- ➔ [Printing This Manual](#)
- ➔ [Using Keywords to Find a Topic](#)
- ➔ [Registering Topics to My Manual](#)
- ➔ [Symbols Used in this Document](#)
- ➔ [Trademarks](#)

[Page top](#) ↕

Advanced Guide

Advanced Guide > How to Use This Manual > Operating the Contents Screen

Operating the Contents Screen

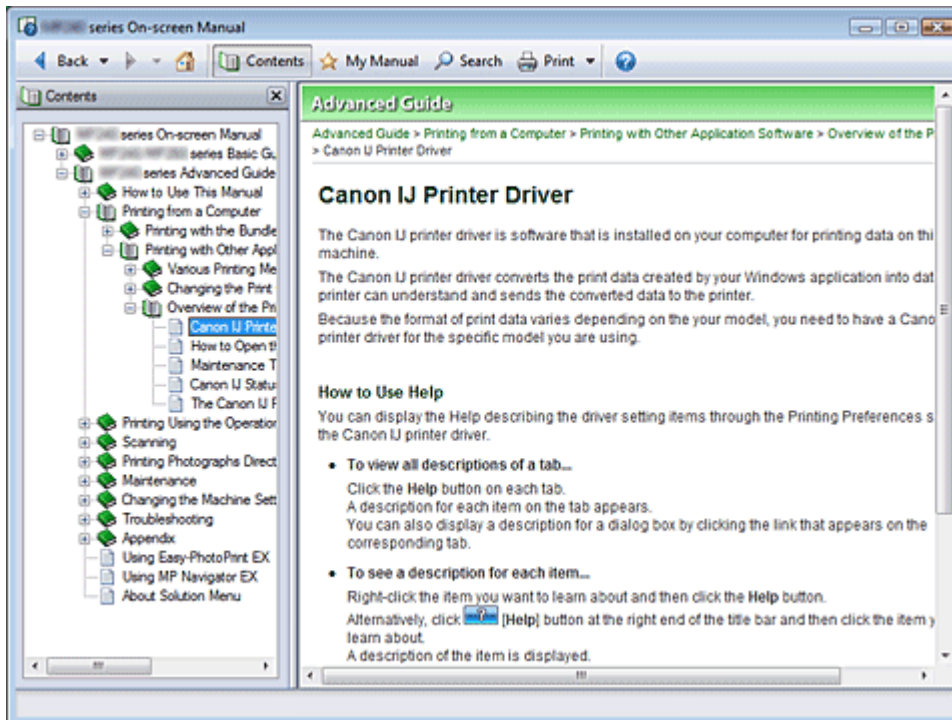

When you click a title displayed in the Contents screen found to the left of the On-screen Manual, the pages of that title are displayed in the Description window.

When you click  found to the left of , the titles found in the lower hierarchies are displayed.

Note

- Click  to close or display the Contents screen.

[Page top](#) 

Advanced Guide

Advanced Guide > How to Use This Manual > Operating the Explanation Screen

Operating the Explanation Screen

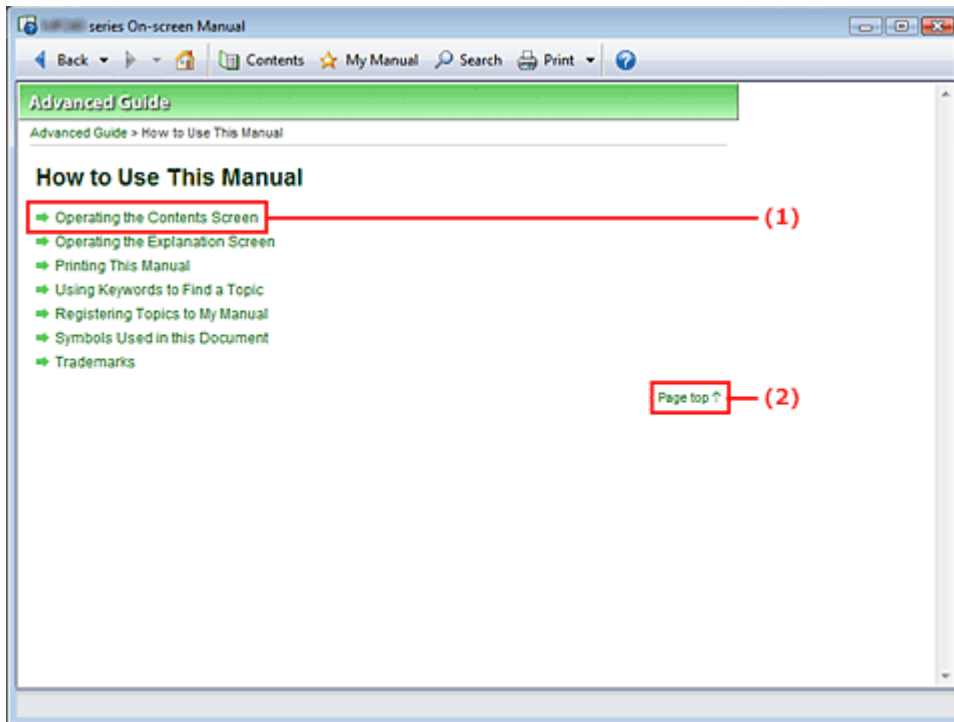

(1) Click the green characters to jump to the corresponding page.

(2) The cursor jumps to the top of this page.

Note

- The diagrams and computer screens in this guide refer to MP260 series. The operations are exactly the same as those for the MP240 series, unless otherwise described.

[Page top ↕](#)

Advanced Guide

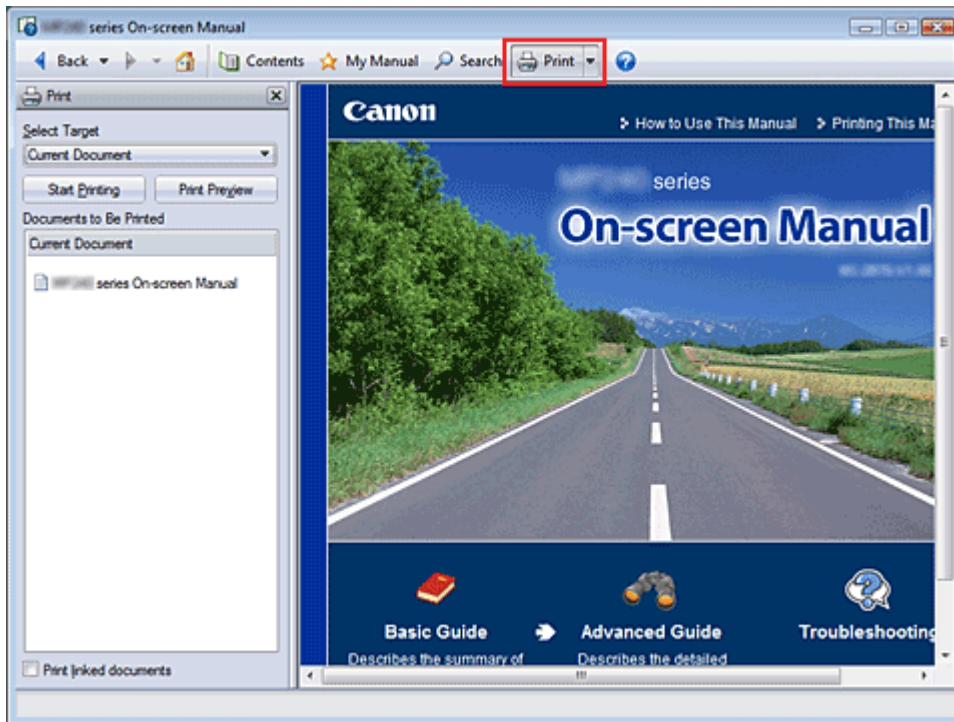

Advanced Guide > How to Use This Manual > Printing This Manual

Printing This Manual



Click  to display the Print window to the left of the On-screen Manual.

Note

- Click  to close or display the Print window.
- Click , and then click Option Settings to display the Option Settings dialog box. You can then set up the printing operation.

The following four methods of printing are available:

- [Current Document](#)
- [Selected Documents](#)
- [My Manual](#)
- [All Documents](#)

Current Document

You can print the currently displayed topic.

1. From Select Target, select Current Document

The title of the currently displayed topic is displayed in the Documents to Be Printed list.

Note

- By selecting Print linked documents, you can also print documents that are linked to the current document. The linked documents are added to the Documents to Be Printed list.
- Click Print Preview to display and check what the print results will look like before you actually print the document.

2. Click Start Printing

The Print Page Count Confirmation dialog box is displayed.

3. Execute print

Confirm the number of pages to be printed, and then click Yes.
The topics that are currently displayed are printed.

Selected Documents

You can select and print the topics that you want printed.

1. From Select Target, select Selected Documents

The titles of all topics are displayed in the Documents to Be Printed list.

2. Select the topics to be printed

From the Documents to Be Printed list, select the title check boxes of the topics to be printed.



Note

- When you select the Automatically select documents in lower hierarchies check box, the check boxes of all titles found in the lower hierarchies are selected.
- Click Select All to select the check boxes of all titles.
Click Clear All to clear the check boxes of all titles.
- Click Print Preview to display and check what the print results will look like before you actually print the document.

3. Click Start Printing

The Print Page Count Confirmation dialog box is displayed.

4. Execute print

Confirm the number of pages to be printed, and then click Yes.
All topics with selected check boxes are printed.

My Manual

You can select and print topics registered in My Manual.

For details about My Manual, see "[Registering Topics to My Manual](#)."

1. From Select Target, select My Manual

The titles of the topics that have been registered to My Manual are displayed in the Documents to Be Printed list.

2. Select the topics to be printed

From the Documents to Be Printed list, select the title check boxes of the topics to be printed.



Note

- Click Select All to select the check boxes of all titles.
Click Clear All to clear the check boxes of all titles.
- Click Print Preview to display and check what the print results will look like before you actually print the document.

3. Click Start Printing

The Print Page Count Confirmation dialog box is displayed.

4. Execute print

Confirm the number of pages to be printed, and then click Yes.
All topics with selected check boxes are printed.

All Documents

You can print all topics of the On-screen Manual.

1. From Select Target, select All Documents

The titles of all topics are displayed in the Documents to Be Printed list, and the check boxes are automatically selected.

**Note**

- If you clear the check box of a topic, that topic is not printed.
- Click Select All to select the check boxes of all titles.
Click Clear All to clear the check boxes of all titles.
- Click Print Preview to display and check what the print results will look like before you actually print the document.

2. Click Start Printing

The Print Page Count Confirmation dialog box is displayed.

3. Execute print

Confirm the number of pages to be printed, and then click Yes.

All topics are printed.

**Important**

- A large amount of paper is necessary to print all topics. Before printing, be sure to check the number of print pages displayed in the Print Page Count Confirmation dialog box.

[Page top](#) ↕

Advanced Guide

Advanced Guide > How to Use This Manual > Using Keywords to Find a Topic

Using Keywords to Find a Topic

You can enter a keyword to search for a target page.

All installed On-screen Manuals (user's guides) are searched.

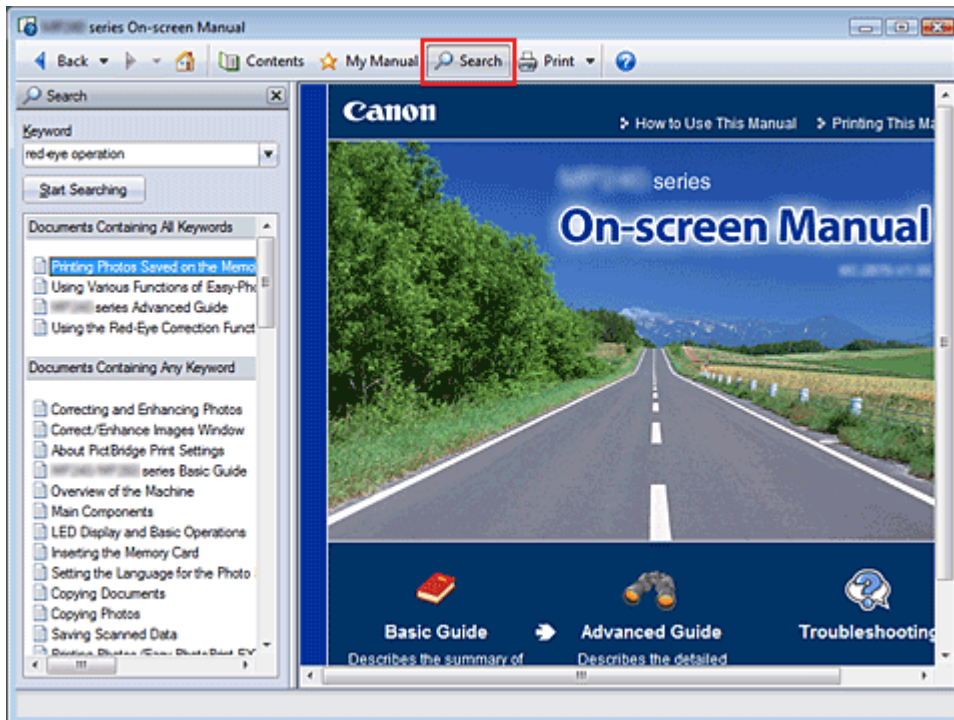

1. Click

A search window is displayed to the left of the On-screen Manual.

Note

- Click  to close or display the Search window.

2. Enter a keyword

In Keyword, enter a keyword for the item to be checked.

If you want to enter multiple keywords, insert a space between the keywords.

Note

- You can enter up to 10 keywords or up to 255 characters.
- Uppercase and lowercase are not discriminated.
- The program can also search for keywords that contain spaces.

3. Click Start Searching

The search is started, and the titles of topics containing the keyword are displayed in the search results list.

When you execute a search by entering multiple keywords, the search results are displayed as shown below.

[Documents Containing Perfect Match]

Topics containing the entire search character string (including spaces) exactly as entered (perfect match)

[Documents Containing All Keywords]

Topics containing all keywords that were entered

[Documents Containing Any Keyword]

Topics containing at least one of the keywords that were entered

4. Display the topic that you want to read

From the search results list, double-click (or select and press Enter) the title of the topic you want to read.

When the pages of that title are displayed, the keywords found on those pages are highlighted.

[Page top ↕](#)

Advanced Guide

Advanced Guide > How to Use This Manual > Registering Topics to My Manual

Registering Topics to My Manual

Register frequently read pages as My Manual topics so that you can refer to those pages easily at any time.

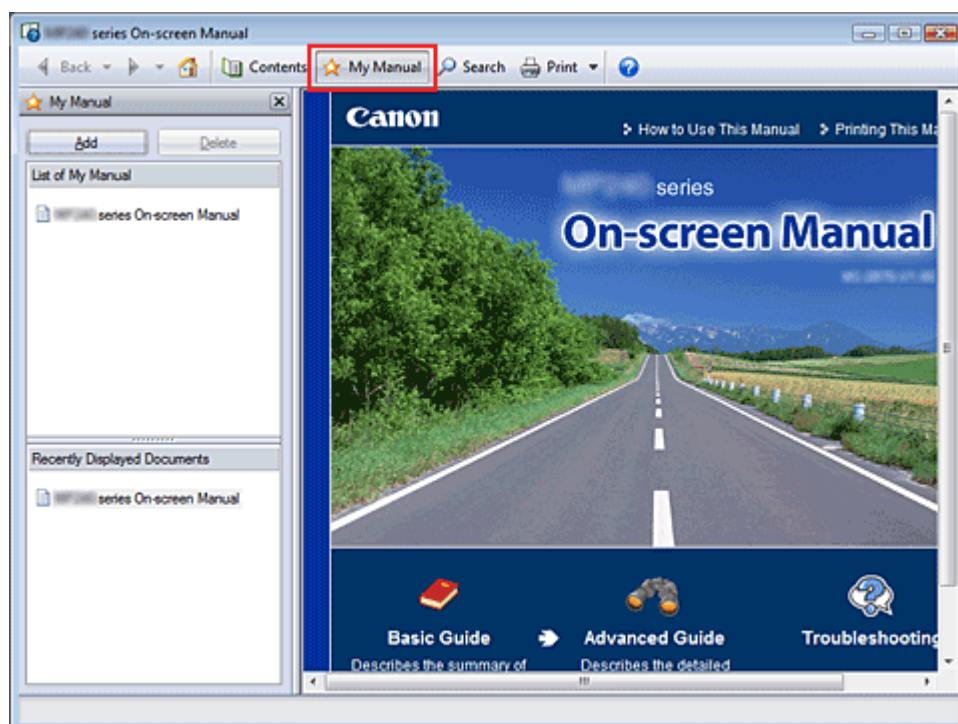

1. Display the topic

Display the topic to be added to My Manual.

2. Click My Manual

The My Manual window is displayed to the left of the On-screen Manual.

Note

- Click  to close or display the My Manual window.

3. Register the topic to My Manual

Click Add.

The currently displayed topic is added to List of My Manual.

Note

- Alternatively, from the Recently Displayed Documents list, double-click (or select and press Enter) the topic to be added to My Manual to display that topic, and then click Add.

4. Display My Manual

When you double-click (or select and press Enter) a topic displayed in List of My Manual, that topic is displayed in the Description window.

Note

- To delete a topic from List of My Manual, select that topic from the list, and then click Delete (or press Delete).

[Page top](#) 

Advanced Guide

[Advanced Guide](#) > [How to Use This Manual](#) > [Symbols Used in this Document](#)

Symbols Used in this Document

Warning

Instructions that, if ignored, could result in death or serious personal injury caused by incorrect operation of the equipment. These must be observed for safe operation.

Caution

Instructions that, if ignored, could result in personal injury or material damage caused by incorrect operation of the equipment. These must be observed for safe operation.

Important

Instructions that must be observed for safe operation.

Note

Instructions as notes for operation or additional explanations.

Windows

Indicates operations in Windows.

Macintosh

Indicates operations in Macintosh.

[Page top](#) 

Advanced Guide

[Advanced Guide](#) > [How to Use This Manual](#) > [Trademarks](#)

Trademarks

- Microsoft is a registered trademark of Microsoft Corporation.
- Windows is a trademark or registered trademark of Microsoft Corporation in the U.S. and/or other countries.
- Windows Vista is a trademark or registered trademark of Microsoft Corporation in the U.S. and/or other countries.
- Macintosh and Mac are trademarks of Apple Inc., registered in the U.S. and other countries.
- Adobe, Adobe Photoshop, Adobe RGB and Adobe RGB (1998) are either registered trademarks or trademarks of Adobe Systems Incorporated in the United States and or other countries.

[Page top](#) ↕

Advanced Guide

Advanced Guide > Printing from a Computer

Printing from a Computer

- ➔ [Printing with the Bundled Application Software](#)
- ➔ [Printing with Other Application Software](#)

[Page top](#) ↑

Advanced Guide

[Advanced Guide](#) > [Printing from a Computer](#) > [Printing with the Bundled Application Software](#)

Printing with the Bundled Application Software

- ➔ [What Is Easy-PhotoPrint EX?](#)
- ➔ [Printing Photos](#)
- ➔ [Creating an Album](#)
- ➔ [Printing Calendars](#)
- ➔ [Printing Stickers](#)
- ➔ [Printing Layout](#)
- ➔ [Correcting and Enhancing Photos](#)
- ➔ [Questions and Answers](#)
- ➔ [Appendix 1: Easy-PhotoPrint EX Settings](#)

[Page top](#) ↕

Advanced Guide

Advanced Guide > Printing from a Computer > Printing with the Bundled Application Software > What Is Easy-PhotoPrint EX?

What Is Easy-PhotoPrint EX?

Easy-PhotoPrint EX allows you to create albums, calendars and stickers easily using photos taken with digital cameras.

You can also print borderless photos easily.

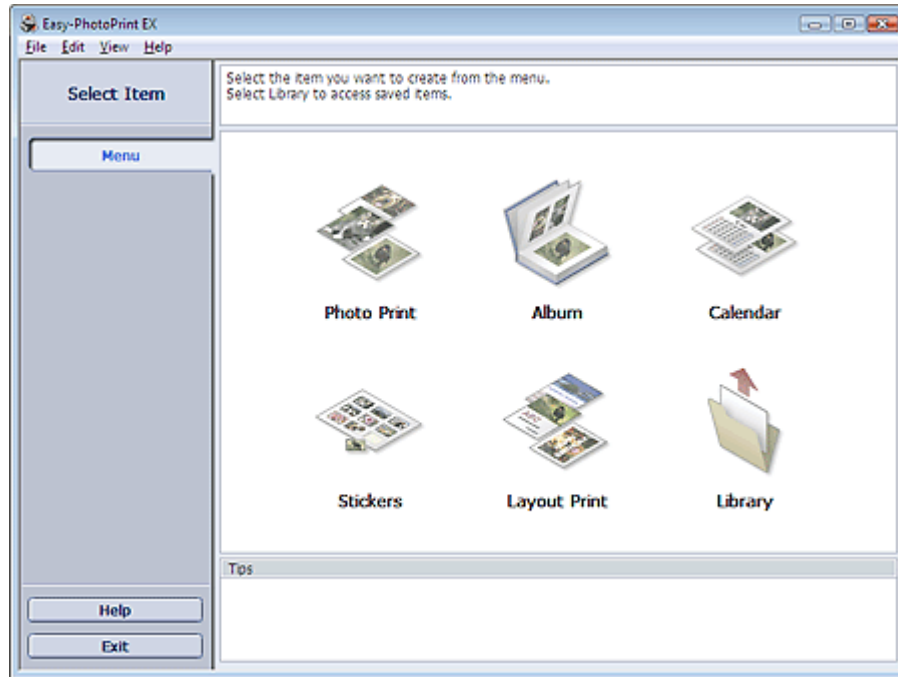

Important

- Easy-PhotoPrint EX does not support Windows 95, Windows 98, Windows Me, or Windows NT4.
- Easy-PhotoPrint EX can only be used with Canon inkjet printers. It does not support some printers, including Canon compact printers (SELPHY CP series).
- If a printer that supports Easy-PhotoPrint EX is not installed, you cannot print items you create.
- If Easy-PhotoPrint EX is installed on a computer that already has Easy-LayoutPrint installed, Easy-LayoutPrint will be replaced by Easy-PhotoPrint EX.

Note

- Printing on paper larger than A4 is available with supported printers only. See your printer manual for details.
- See Help of Easy-PhotoPrint EX for descriptions of Easy-PhotoPrint EX screens. Click Help in a screen or dialog box, or select Easy-PhotoPrint EX Help from the Help menu. Help appears.

About Exif Print

Easy-PhotoPrint EX supports "Exif Print." Exif Print is a standard for enhancing the communication between digital cameras and printers.

By connecting to an Exif Print-compliant digital camera, the image data at the time of shooting is used and optimized, yielding extremely high quality prints.

Starting Easy-PhotoPrint EX from Other Applications

Easy-PhotoPrint EX can be started from other applications.

See the application's manual for details on the procedure for starting.

The Album function is available with the following applications:

- MP Navigator EX Ver.1.00 or later
- ZoomBrowser EX Ver.5.8 or later

The Photo Print function is available with the following applications:

- MP Navigator EX Ver.1.00 or later
- ZoomBrowser EX Ver.6.0 or later
- Digital Photo Professional Ver.3.2 or later

Note

- Easy-PhotoPrint EX is subject to the following restrictions when started from Digital Photo Professional:
 - Menu does not appear in the step button area on the left side of the screen.
 - Images cannot be corrected/enhanced.
 - Image display order cannot be changed.
 - Edited images cannot be saved.
 - Options other than Enable ICC Profile cannot be selected for Color correction for printing on the Advanced tab of the Preferences dialog box. Therefore, you cannot use the Vivid Photo and Photo Noise Reduction functions.

Supported Image File Formats (Extensions)

- BMP (.bmp)
- JPEG (.jpg, .jpeg)
- TIFF (.tif, .tiff)
- PICT (.pict, .pct)
- Easy-PhotoPrint image files (.epp)

Important

- When selecting an image, if there is a TIFF file in the selected folder, the image may not be displayed correctly or Easy-PhotoPrint EX may shut down depending on the TIFF format. In such cases, move the TIFF file to another folder or recreate the file in a different file format, and then select the folder again.



- The thumbnails of files in unsupported formats are displayed as  (Question Mark).

Note

- When Easy-PhotoPrint EX is started from Digital Photo Professional, all image files supported by Digital Photo Professional will be displayed.

File Formats (Extensions) Supported by Easy-PhotoPrint EX

- Easy-PhotoPrint EX Photo Print file (.el6)
- Easy-PhotoPrint EX Album file (.el1)
- Easy-PhotoPrint EX Stickers file (.el2)
- Easy-PhotoPrint EX Calendar file (.el4)
- Easy-PhotoPrint EX Layout file (.el5)

[Page top](#) 

Advanced Guide

Advanced Guide > Printing from a Computer > Printing with the Bundled Application Software > Printing Photos

Printing Photos

Easy-PhotoPrint EX allows you to print your favorite photos in a variety of layouts.

You can also create borderless photos easily.

Corrections suitable for photos will be applied automatically when printing.



Steps

1. Starting Easy-PhotoPrint EX
2. Selecting a Photo
3. Selecting the Paper
4. Printing

Try This

- ➔ Correcting and Enhancing Photos
- ➔ Printing Vivid Photos
- ➔ Reducing Photo Noise
- ➔ Cropping Photos (Photo Print)
- ➔ Printing Dates on Photos (Photo Print)
- ➔ Printing Multiple Photos on One Page
- ➔ Printing an Index
- ➔ Printing ID Photos (ID Photo Print)
- ➔ Printing Photo Information
- ➔ Saving Photos
- ➔ Opening Saved Files

Questions and Answers

- ➔ How Can I Move (or Copy) the Saved File?
- ➔ Which Side of the Displayed Image Does the Printing Start from?
- ➔ How Do I Print with Even Margins?

[Page top](#)↑

Advanced Guide

Advanced Guide > Printing from a Computer > Printing with the Bundled Application Software > Printing Photos > Starting Easy-PhotoPrint EX

Starting Easy-PhotoPrint EX

1. From the Start menu, select (All) Programs > Canon Utilities > Easy-PhotoPrint EX > Easy-PhotoPrint EX.

Easy-PhotoPrint EX starts and Menu appears.

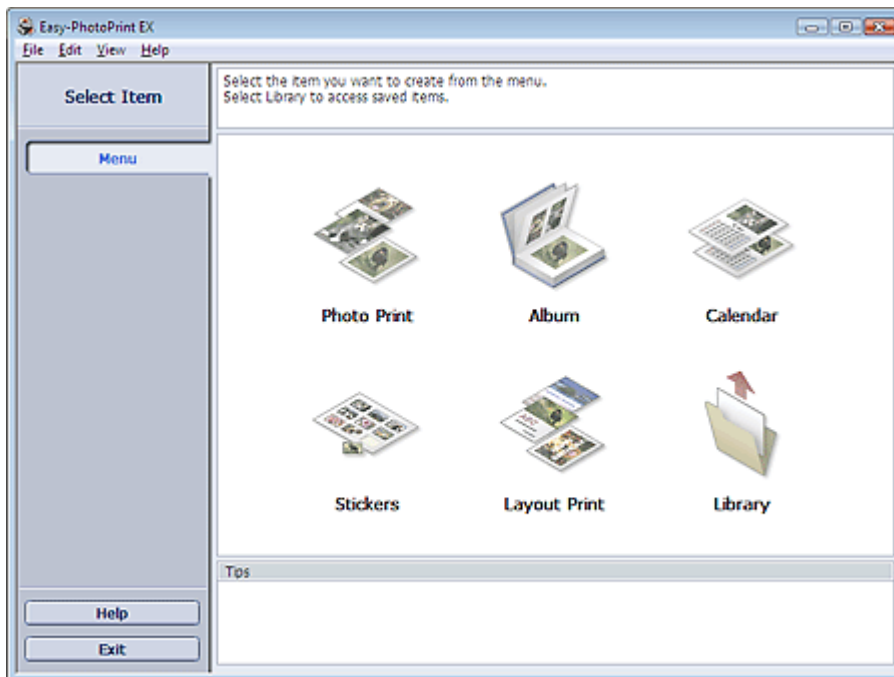

[Page top](#)↑

Advanced Guide

Advanced Guide > Printing from a Computer > Printing with the Bundled Application Software > Printing Photos > Selecting a Photo

Selecting a Photo

1. Click Photo Print from Menu.

The Select Images screen appears.

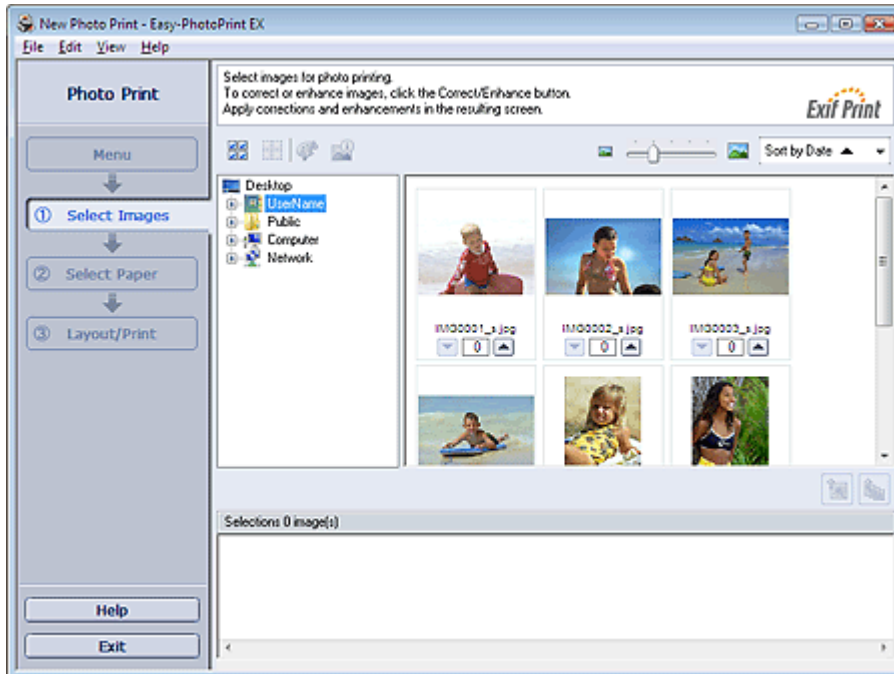

Important

- The reduced images (thumbnails) displayed in the screen may appear as follows:
 - A black line appears along an edge of the image.
 - An edge of the image appears cropped.
 However, such images will be displayed normally when enlarged or previewed, and print results will not be affected.

2. Select the folder that contains the image you want to print from the folder tree area.

The images in the folder will be displayed as thumbnails (miniatures).

Note

- If Easy-PhotoPrint EX is started from another application (MP Navigator EX, ZoomBrowser EX or Digital Photo Professional), the folder tree area will not be displayed. The images opened in the application will be displayed as thumbnails.



3. Click the image you want to print.

The number of copies appears as "1" below the clicked image, while the selected image itself will appear in the selected image area.

Note

- To delete an image in the selected image area, select the image you want to delete and click  (Delete Imported Image).

To delete all images from the selected image area, click  (Delete All Imported Images).

- To print two or more copies of an image, click  (Up arrow) until the number of copies you want is reached. To reduce the number of copies shown in the box, click  (Down arrow).
- You can change the order of photos using the list located at the top right corner of the screen. You can select the printing order from Sort by Date and Sort by Name.

 **Note**

-
- You can correct or enhance the selected image before printing.
 - ➔ [Correcting and Enhancing Photos](#)
 - See Help for details on the Select Images screen.
-

[Page top](#)↑

Advanced Guide

Advanced Guide > Printing from a Computer > Printing with the Bundled Application Software > Printing Photos > Selecting the Paper

Selecting the Paper

1. Click Select Paper.

The Select Paper screen appears.

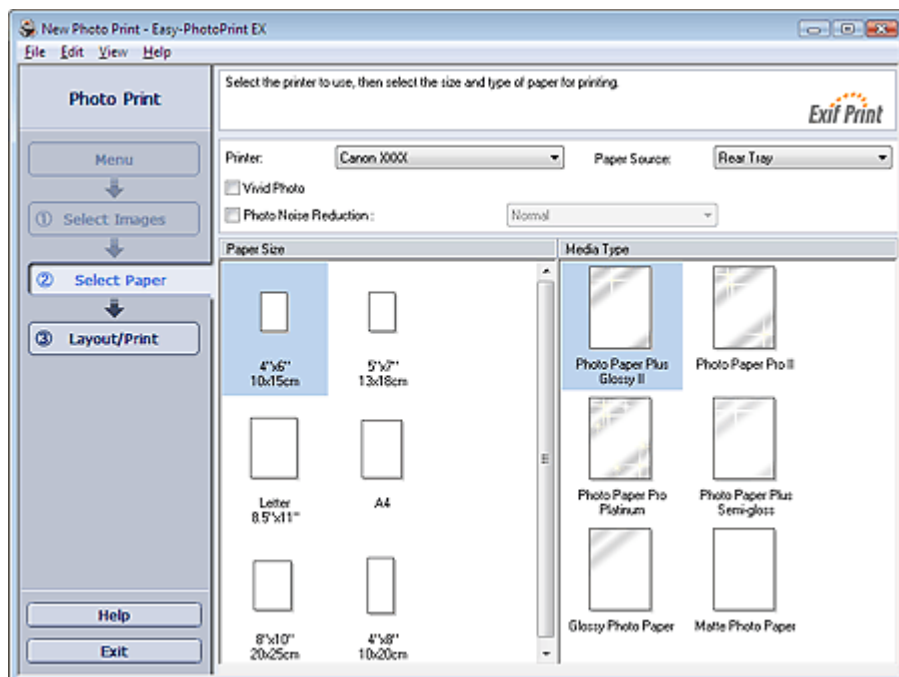

2. Set the following items according to the printer and paper to be used:

Printer

Paper Source

Paper Size

Media Type



Note

- The paper sizes and media types may vary depending on the printer. See Help for details.
- The paper sources may vary depending on the printer and the media type.

Important

- When Fine Art Photo Rag is selected for Media Type, a 1.38 inch (35 mm) margin is automatically left at the top and bottom of the paper. It is recommended that you check the print range with the image shown in Preview before printing.



Note

- You can print photos with more vivid colors or you can reduce the photo noise.
 - ➔ [Printing Vivid Photos](#)
 - ➔ [Reducing Photo Noise](#)
- See Help for details on the Select Paper screen.



[Page top](#) ↑

Advanced Guide

Advanced Guide > Printing from a Computer > Printing with the Bundled Application Software > Printing Photos > Printing

Printing

1. Click Layout/Print.

The Layout/Print screen appears.

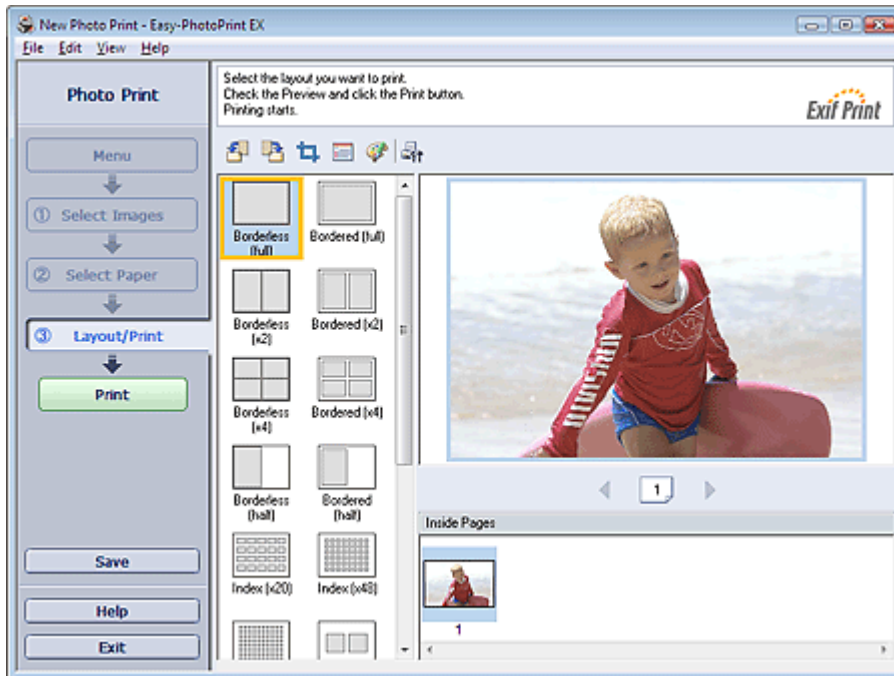

Important

- The reduced images (thumbnails) displayed in the screen may appear as follows:
 - A black line appears along an edge of the image.
 - An edge of the image appears cropped.
 However, such images will be displayed normally when enlarged or previewed, and print results will not be affected.

2. Select a layout you want to use.

Click a borderless layout to print borderless photos.

Note

- The layouts that can be selected may vary depending on the printer, paper size, and media type.

3. Click Print.

Important

- When you print on large size paper such as A3/A3+, some computers cannot print properly if you print more than one page or copy at a time. It is recommended that you print page by page when you print on such paper.
- While printing on paper larger than A4 or printing high-resolution images, data may be printed only to the middle if many images are printed at one time. In such cases, select the Spool print job page by page checkbox in the Preferences dialog box, and then print again.

To display the Preferences dialog box, click  (Settings) or select Preferences... from the File menu.

- When Fine Art Photo Rag is selected for Media Type in the Select Paper screen, a 1.38 inch (35 mm) margin is automatically left at the top and bottom of the paper. It is recommended that you check the print range with the image shown in Preview before printing.

Note

- The photo print settings will be discarded if you exit Easy-PhotoPrint EX without saving the settings.

It is recommended that you save the printed image if you want to print it again.

➔ [Saving Photos](#)

- When you print on a bordered layout, the margins on the left and right or the top and bottom may become wider than the other.

➔ [How Do I Print with Even Margins?](#)

- You can crop images or print dates on photos.

➔ [Cropping Photos \(Photo Print\)](#)

➔ [Printing Dates on Photos \(Photo Print\)](#)

- You can correct or enhance the selected image before printing.

➔ [Correcting and Enhancing Photos](#)

- You can specify advanced Photo Print settings (number of copies, print quality, etc.) in the Preferences dialog box.

To display the Preferences dialog box, click  (Settings) or select Preferences... from the File menu.

- See Help for details on the Layout/Print screen.
-



[Page top](#)↑

Advanced Guide

Advanced Guide > Printing from a Computer > Printing with the Bundled Application Software > Creating an Album

Creating an Album

Easy-PhotoPrint EX allows you to create your own personalized photo album.

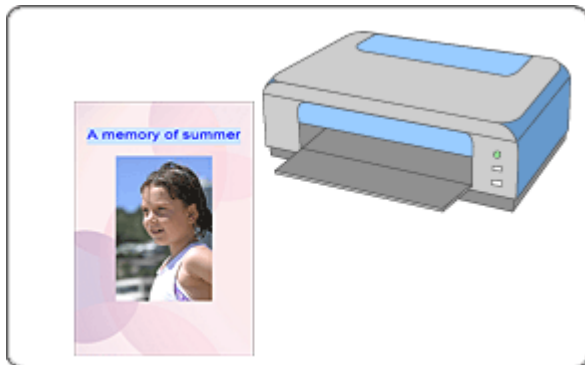

Steps

1. Starting Easy-PhotoPrint EX
2. Selecting the Paper and Layout
3. Selecting a Photo
4. Editing
5. Printing

Try This

- ➔ Correcting and Enhancing Photos
- ➔ Changing Layout
- ➔ Changing Background
- ➔ Adding Photos
- ➔ Swapping Positions of Photos
- ➔ Replacing Photos
- ➔ Changing Position, Angle and Size of Photos
- ➔ Cropping Photos
- ➔ Framing Photos
- ➔ Printing Dates on Photos
- ➔ Attaching Comments to Photos
- ➔ Adding Text to Photos
- ➔ Saving
- ➔ Opening Saved Files

Questions and Answers

- ➔ How Can I Move (or Copy) the Saved File?
- ➔ What Is "C1" or "C4"?

[Page top](#)↑

Advanced Guide

Advanced Guide > Printing from a Computer > Printing with the Bundled Application Software > Creating an Album > Starting Easy-PhotoPrint EX

Starting Easy-PhotoPrint EX

1. From the Start menu, select (All) Programs > Canon Utilities > Easy-PhotoPrint EX > Easy-PhotoPrint EX.

Easy-PhotoPrint EX starts and Menu appears.

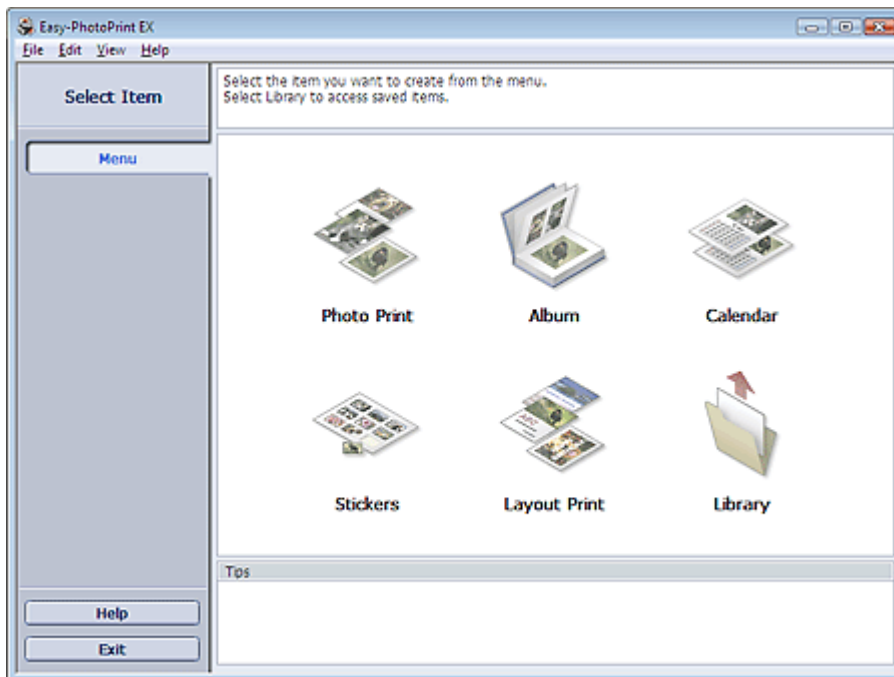

[Page top](#)↑

Advanced Guide

Advanced Guide > Printing from a Computer > Printing with the Bundled Application Software > Creating an Album > Selecting the Paper and Layout

Selecting the Paper and Layout

1. Click Album from Menu.

The Page Setup screen appears.

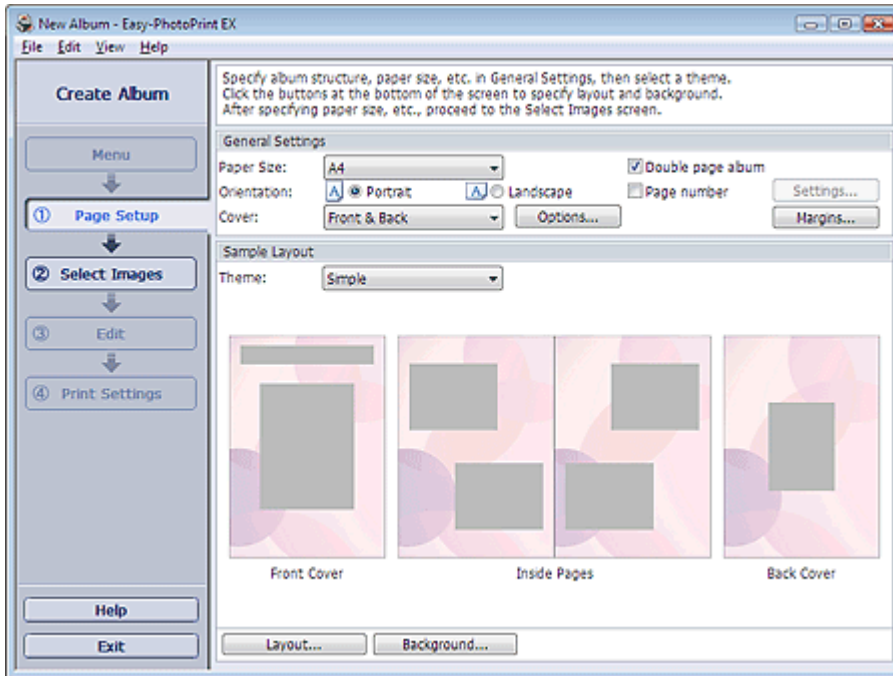

2. Set the following items in the General Settings section:

Paper Size

Orientation

Cover

Double page album

Page number

Note

- See Help on the paper size that can be selected.
- You can select whether to display images on the inside of the front and back covers in the Cover Options dialog box. To display the Cover Options dialog box, select Front or Front & Back for Cover and click Options....
- Select the Double page album checkbox to enable the spread page layout (consisting of two-page master). In a double-page album, you can arrange an image across the left and right pages.
- You can customize the page numbers (position, font size, etc.) in the Page Number Settings dialog box. To display the Page Number Settings dialog box, select the Page number checkbox and click Settings....
- You can customize the margins of the front cover, inside pages and back cover in the Margin Settings dialog box. To display the Margin Settings dialog box, click Margins....

3. Select the theme you want to use from Theme in Sample Layout.

4. If you want to change the layout, click Layout....

The Change Layout dialog box appears.

In the Change Layout dialog box, you can change the layout or select whether to print the date (on which the picture was taken) on the photo.

Note

- The album layouts that can be selected may vary depending on the Paper Size, Orientation, Double page album, or the type of page selected (front cover, inside pages or back cover).
 - You can customize the date (position, size and color) in the Date Settings dialog box. To display the Date Settings dialog box, select the Print date checkbox in the Change Layout dialog box and click Date Settings....
-

5. If you want to change the background, click Background....

The Change Background dialog box appears.

In the Change Background dialog box, you can paint the background in a single color or paste an image file to it.

Note

- See Help for details on the Page Setup screen.
-



[Page top](#)↑

Advanced Guide

Advanced Guide > Printing from a Computer > Printing with the Bundled Application Software > Creating an Album > Selecting a Photo

Selecting a Photo

1. Click Select Images.

The Select Images screen appears.

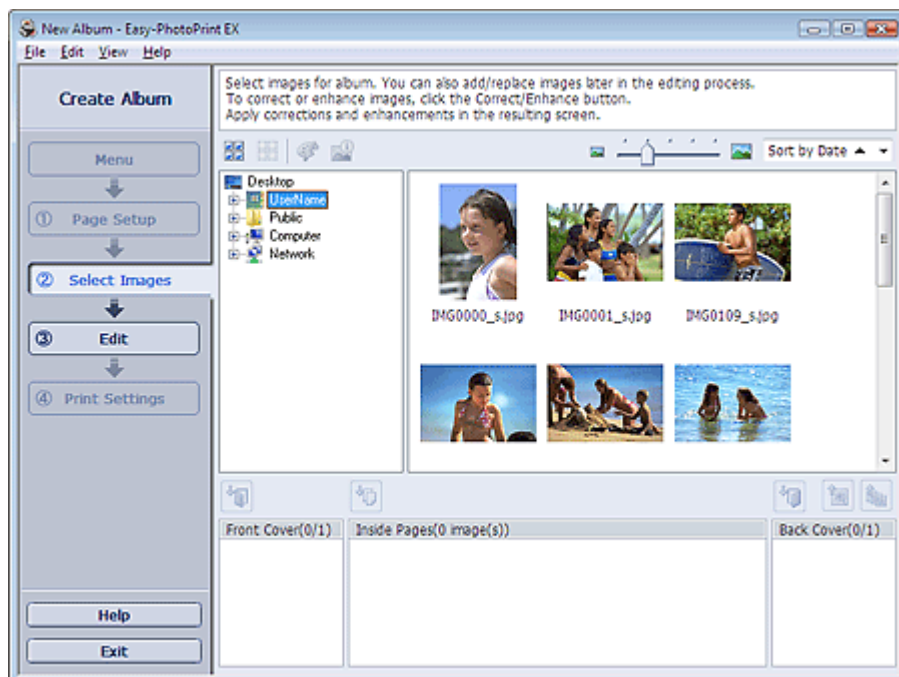

2. Select the folder that contains the image you want to print from the folder tree area.

The images in the folder will be displayed as thumbnails (miniatures).

Note

- If Easy-PhotoPrint EX is started from another application (MP Navigator EX or ZoomBrowser EX), the folder tree area will not be displayed. The images opened in MP Navigator EX or ZoomBrowser EX will be displayed as thumbnails.

3. Select the image(s) you want to print, and click one of the buttons below.

To print on the front cover, click  (Import to Front Cover).

To print on the inside pages, click  (Import to Inside Pages).

To print on the back cover, click  (Import to Back Cover).

The selected images are displayed in the selected image area.

You can also select the image(s) you want to print by dragging them into the selected image area.

Note

- To delete an image in the selected image area, select the image you want to delete and click

 (Delete Imported Image).

To delete all images from the selected image area, click  (Delete All Imported Images).

Note

- See Help for details on the Select Images screen.



[Page top](#)↑

Advanced Guide

Advanced Guide > Printing from a Computer > Printing with the Bundled Application Software > Creating an Album > Editing

Editing

1. Click Edit.

The Edit screen appears.

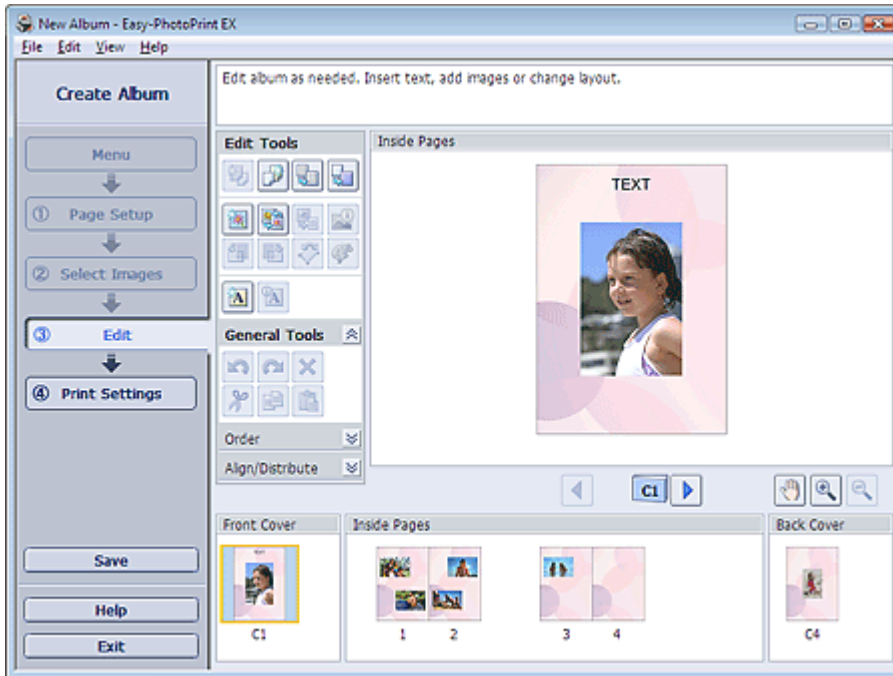

2. Edit your album if necessary.

- ➔ Changing Layout
- ➔ Changing Background
- ➔ Adding Photos
- ➔ Swapping Positions of Photos
- ➔ Replacing Photos
- ➔ Changing Position, Angle and Size of Photos
- ➔ Cropping Photos
- ➔ Framing Photos
- ➔ Printing Dates on Photos
- ➔ Attaching Comments to Photos
- ➔ Adding Text to Photos

Note

- The edit information will be discarded if you exit Easy-PhotoPrint EX without saving the edited album. It is recommended that you save the item if you want to edit it again.
- The page numbers on the front and back covers of the album are displayed as follows:

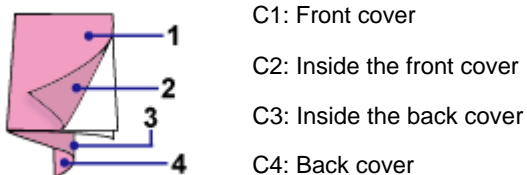

- ➔ Saving
- See Help for details on the Edit screen.



Advanced Guide

Advanced Guide > Printing from a Computer > Printing with the Bundled Application Software > Creating an Album > Printing

Printing

1. Click Print Settings.

The Print Settings screen appears.

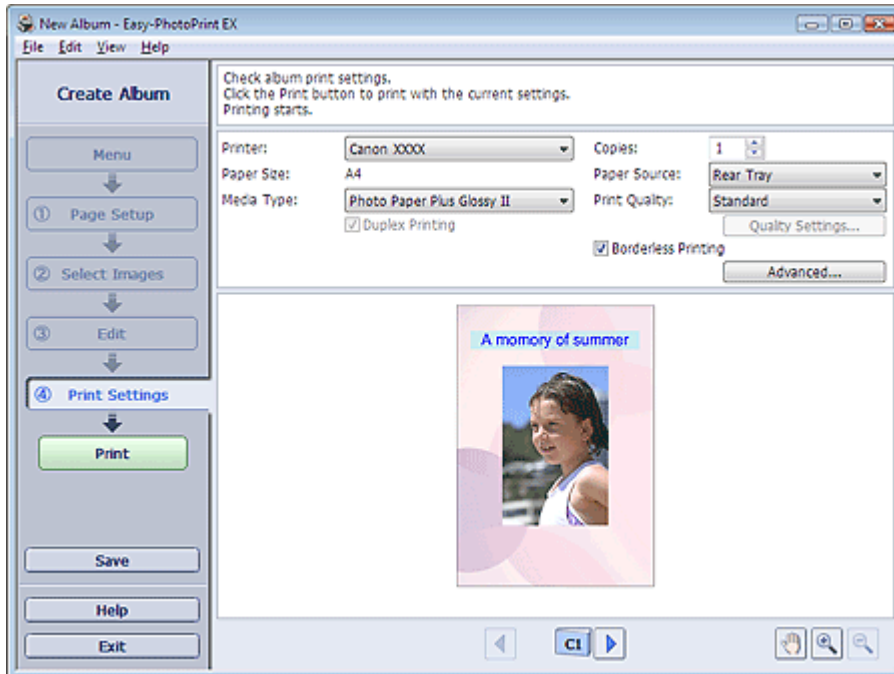

2. Set the following items according to the printer and paper to be used:

Printer

Media Type

Copies

Paper Source

Print Quality

Borderless Printing



Note

- The media types may vary depending on the printer and the paper size.
- Duplex Printing appears if the selected printer and media type support duplex printing. Select this checkbox to print on both sides of the paper.
- Automatic appears if you select the Duplex Printing checkbox after selecting a printer that supports automatic duplex printing and media type that supports duplex printing. Select this checkbox to print on both sides of the paper automatically.
- The paper sources may vary depending on the printer and the media type.
- You can set a custom print quality level in the Print Quality Settings dialog box. To display the Print Quality Settings dialog box, select Custom for Print Quality and click Quality Settings....
- Select the Borderless Printing checkbox to print borderless photos.
- You can specify the print range and the amount of extension for borderless printing in the Print Settings dialog box. To display the Print Settings dialog box, click Advanced....

3. Click Print.



Note

- See Help for details on the Print Settings screen.



Advanced Guide

Advanced Guide > Printing from a Computer > Printing with the Bundled Application Software > Printing Calendars

Printing Calendars

Easy-PhotoPrint EX allows you to create your own calendar using your favorite photos.

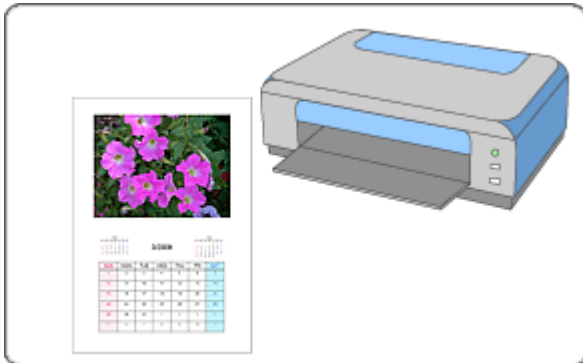

Steps

1. Starting Easy-PhotoPrint EX
2. Selecting the Paper and Layout
3. Selecting a Photo
4. Editing
5. Printing

Try This

- ➔ Correcting and Enhancing Photos
- ➔ Changing Layout
- ➔ Changing Background
- ➔ Adding Photos
- ➔ Swapping Positions of Photos
- ➔ Replacing Photos
- ➔ Changing Position, Angle and Size of Photos
- ➔ Cropping Photos
- ➔ Framing Photos
- ➔ Printing Dates on Photos
- ➔ Adding Text to Photos
- ➔ Setting Calendar Display
- ➔ Setting Holidays
- ➔ Saving
- ➔ Opening Saved Files

Questions and Answers

- ➔ How Can I Move (or Copy) the Saved File?

[Page top](#)↑

Advanced Guide

Advanced Guide > Printing from a Computer > Printing with the Bundled Application Software > Printing Calendars > Starting Easy-PhotoPrint EX

Starting Easy-PhotoPrint EX

1. From the Start menu, select (All) Programs > Canon Utilities > Easy-PhotoPrint EX > Easy-PhotoPrint EX.

Easy-PhotoPrint EX starts and Menu appears.

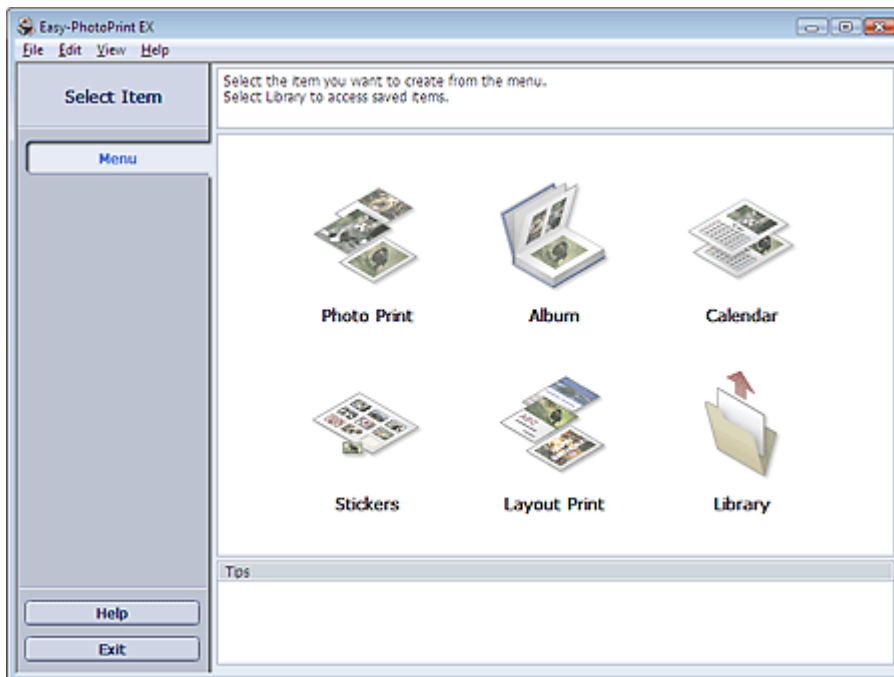

[Page top](#)↑

Advanced Guide

Advanced Guide > Printing from a Computer > Printing with the Bundled Application Software > Printing Calendars > Selecting the Paper and Layout

Selecting the Paper and Layout

1. Click Calendar from Menu.

The Page Setup screen appears.

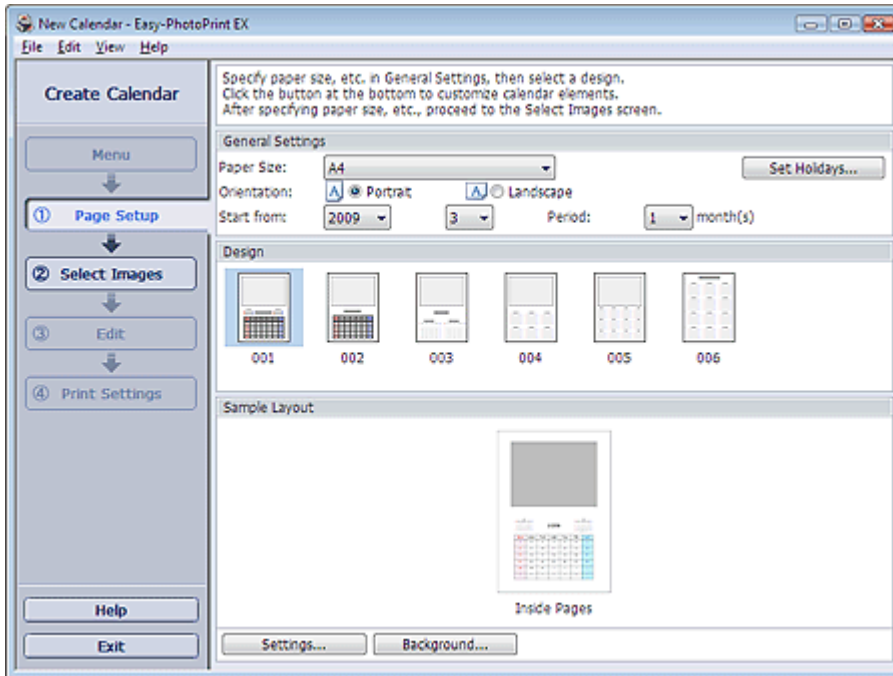

2. Set the following items in the General Settings section:

Paper Size

Orientation

Start from

Period



Note

- See Help on the paper size that can be selected.
- You can add holidays to your calendar.
➔ [Setting Holidays](#)

3. Select a layout.

If necessary, make advanced settings on the calendar and set the background.



Note

- You can customize the calendar display (font colors of the dates and days of the week, position and size of the calendar, etc.).
➔ [Setting Calendar Display](#)
- You can paint the background in a single color or paste an image file to it in the Change Background dialog box. To display the Change Background dialog box, click Background....



Note

- See Help for details on the Page Setup screen.



Advanced Guide

Advanced Guide > Printing from a Computer > Printing with the Bundled Application Software > Printing Calendars > Selecting a Photo

Selecting a Photo

1. Click Select Images.

The Select Images screen appears.

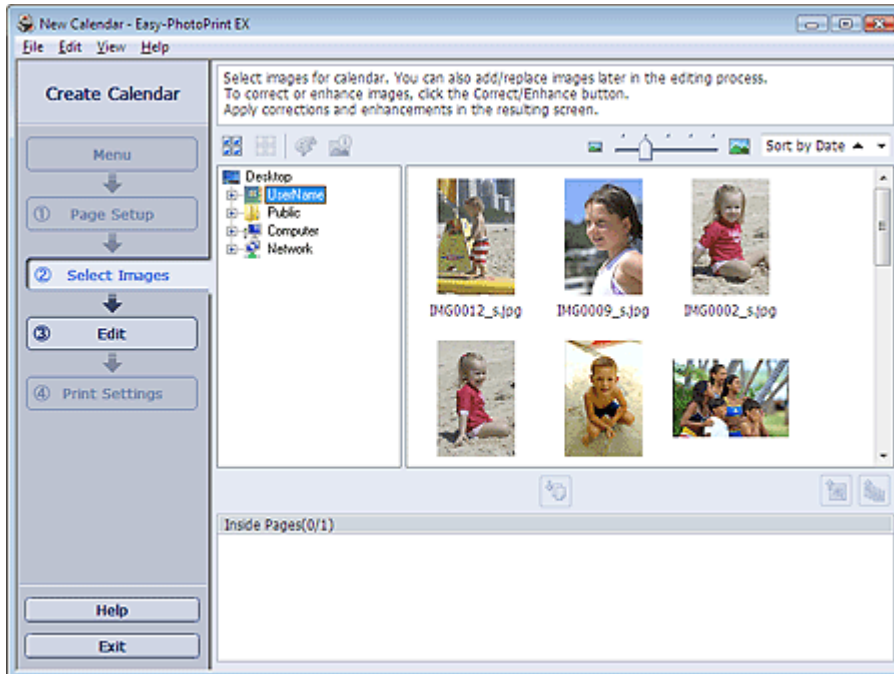

2. Select the folder that contains the image you want to print from the folder tree area.

The images in the folder will be displayed as thumbnails (miniatures).

3. Select the image(s) you want to print and click (Import to Inside Pages).

The selected images are displayed in the selected image area.

You can also select the image(s) you want to print by dragging them into the selected image area.

Note

- To delete an image in the selected image area, select the image you want to delete and click



(Delete Imported Image).

To delete all images from the selected image area, click  (Delete All Imported Images).

Note

- See Help for details on the Select Images screen.



Page top↑

Advanced Guide

Advanced Guide > Printing from a Computer > Printing with the Bundled Application Software > Printing Calendars > Editing

Editing

1. Click Edit.

The Edit screen appears.

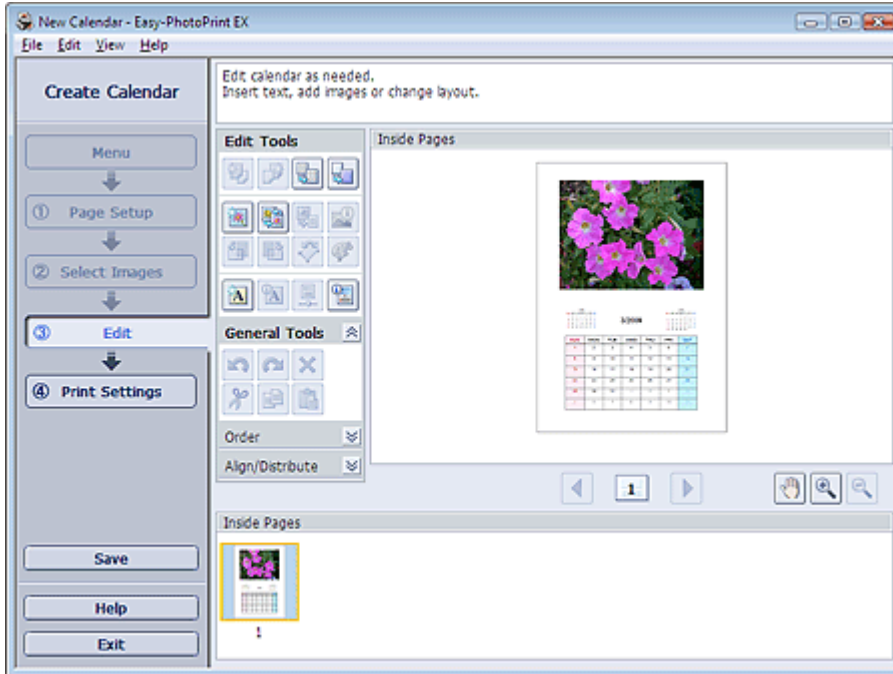

2. Edit the calendar if necessary.

- ➔ Changing Layout
- ➔ Changing Background
- ➔ Adding Photos
- ➔ Swapping Positions of Photos
- ➔ Replacing Photos
- ➔ Changing Position, Angle and Size of Photos
- ➔ Cropping Photos
- ➔ Framing Photos
- ➔ Printing Dates on Photos
- ➔ Adding Text to Photos
- ➔ Setting Calendar Display
- ➔ Setting Holidays

Note

- The edit information will be discarded if you exit Easy-PhotoPrint EX without saving the edited calendar. It is recommended that you save the item if you want to edit it again.
 - ➔ Saving
- See Help for details on the Edit screen.



[Page top](#)↑

Advanced Guide

Advanced Guide > Printing from a Computer > Printing with the Bundled Application Software > Printing Calendars > Printing

Printing

1. Click Print Settings.

The Print Settings screen appears.

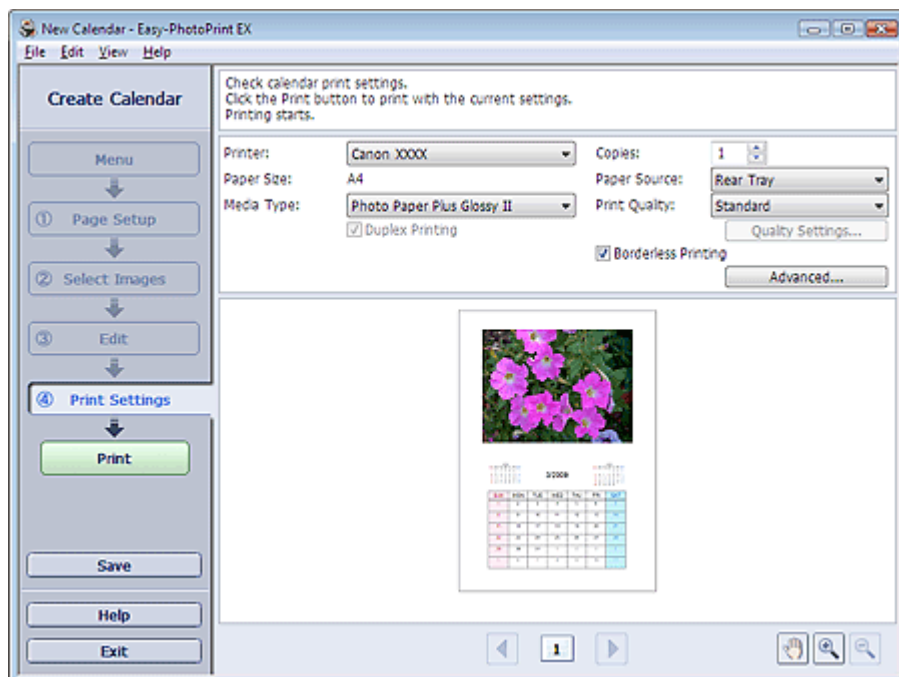

2. Set the following items according to the printer and paper to be used:

Printer

Media Type

Copies

Paper Source

Print Quality

Borderless Printing



Note

- The media types may vary depending on the printer and the paper size.
- Duplex Printing appears if the selected printer and media type support duplex printing. Select this checkbox to print on both sides of the paper.
- Automatic appears if you select the Duplex Printing checkbox after selecting a printer that supports automatic duplex printing and media type that supports duplex printing. Select this checkbox to print on both sides of the paper automatically.
- The paper sources may vary depending on the printer and the media type.
- You can set a custom print quality level in the Print Quality Settings dialog box. To display the Print Quality Settings dialog box, select Custom for Print Quality and click Quality Settings....
- You can specify the print range and the amount of extension for borderless printing in the Print Settings dialog box. To display the Print Settings dialog box, click Advanced....

3. Click Print.



Note

- See Help for details on the Print Settings screen.



Page top↑

Advanced Guide

Advanced Guide > Printing from a Computer > Printing with the Bundled Application Software > Printing Stickers

Printing Stickers

You can print your favorite photos on compatible sticker sheets.



Steps

1. Starting Easy-PhotoPrint EX
2. Selecting the Paper and Layout
3. Selecting a Photo
4. Editing
5. Printing

Try This

- ➔ Correcting and Enhancing Photos
- ➔ Adding Photos
- ➔ Swapping Positions of Photos
- ➔ Replacing Photos
- ➔ Changing Position, Angle and Size of Photos
- ➔ Cropping Photos
- ➔ Framing Photos
- ➔ Adding Text to Photos
- ➔ Saving
- ➔ Opening Saved Files

Questions and Answers

- ➔ How Can I Move (or Copy) the Saved File?

[Page top](#)↑

Advanced Guide

Advanced Guide > Printing from a Computer > Printing with the Bundled Application Software > Printing Stickers > Starting Easy-PhotoPrint EX

Starting Easy-PhotoPrint EX

1. From the Start menu, select (All) Programs > Canon Utilities > Easy-PhotoPrint EX > Easy-PhotoPrint EX.

Easy-PhotoPrint EX starts and Menu appears.

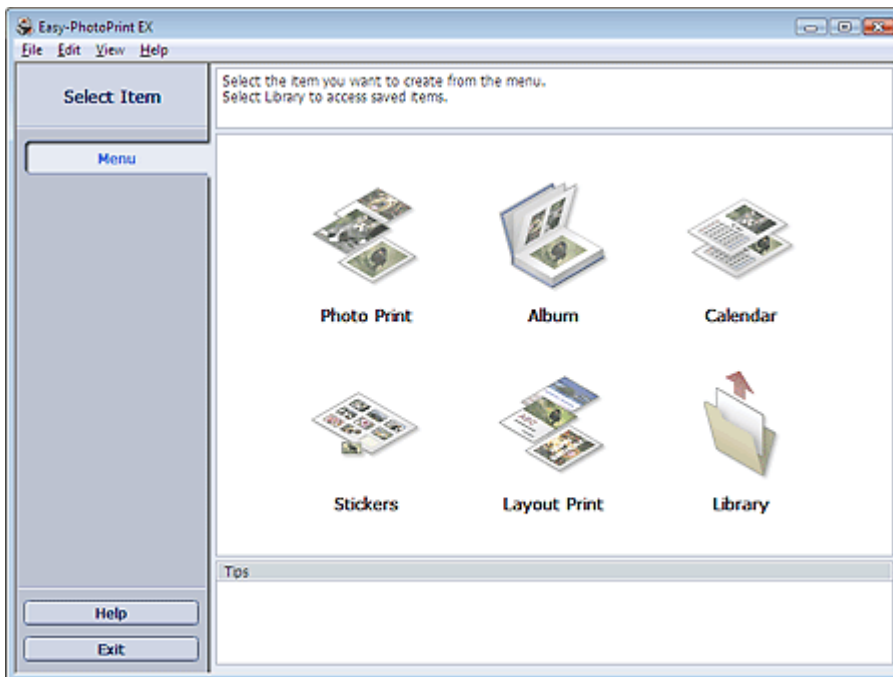

[Page top](#)↑

Advanced Guide

Advanced Guide > Printing from a Computer > Printing with the Bundled Application Software > Printing Stickers > Selecting the Paper and Layout

Selecting the Paper and Layout

1. Click Stickers from Menu.

The Page Setup screen appears.

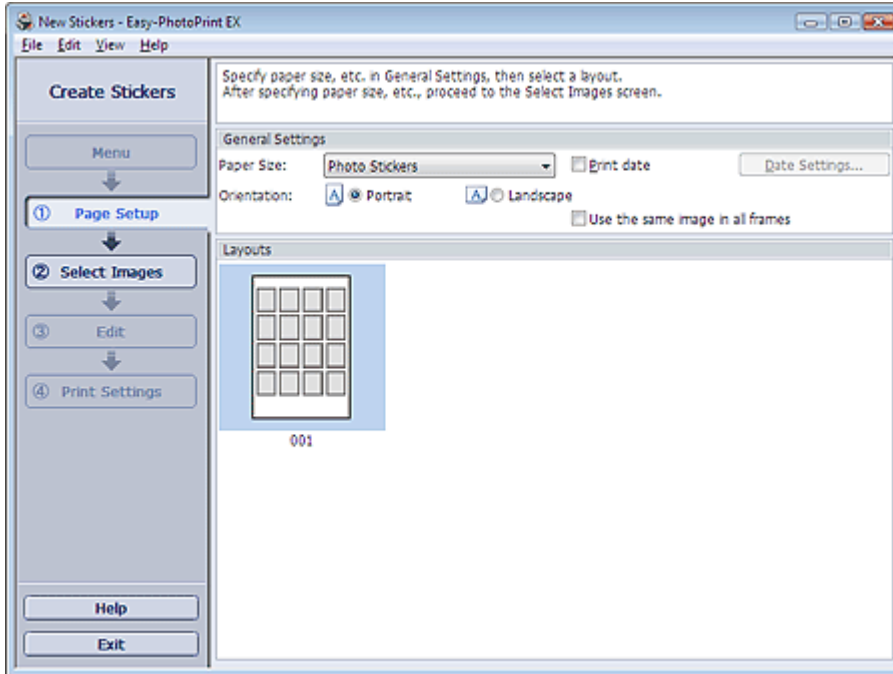

2. Set the following items in the General Settings section:

Paper Size

Orientation

Print date

Use the same image in all frames



Note

- Paper sizes other than Photo Stickers cannot be selected.
- Select the Use the same image in all frames checkbox to use the same image in all the frames on the page.
- You can customize the date (position, size and color) in the Date Settings dialog box. To display the Date Settings dialog box, select the Print date checkbox and click Date Settings....



Note

- See Help for details on the Page Setup screen.



Page top↑

Advanced Guide

Advanced Guide > Printing from a Computer > Printing with the Bundled Application Software > Printing Stickers > Selecting a Photo

Selecting a Photo

1. Click Select Images.

The Select Images screen appears.

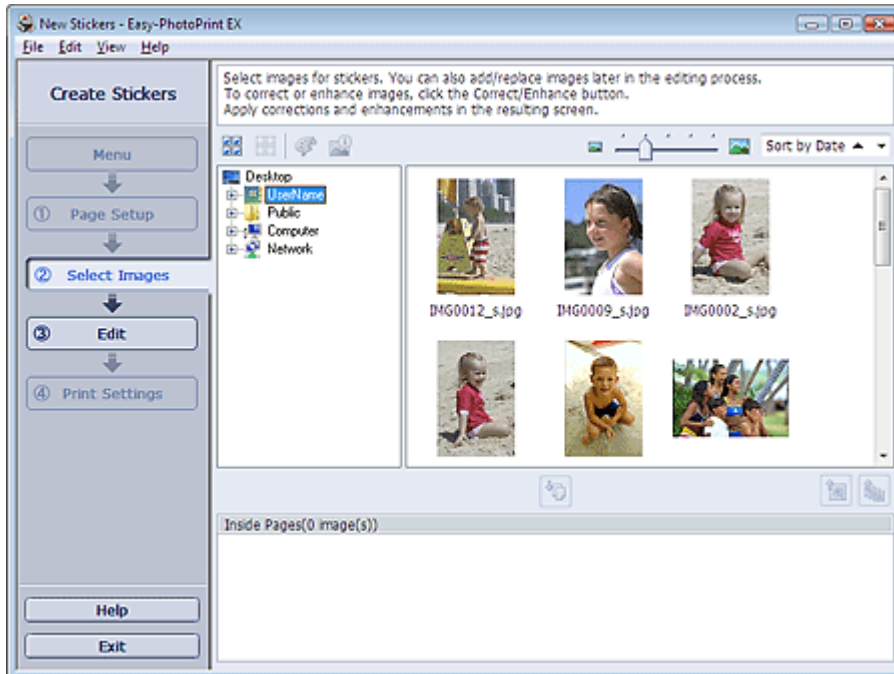

2. Select the folder that contains the image you want to print from the folder tree area.

The images in the folder will be displayed as thumbnails (miniatures).

3. Select the image(s) you want to print and click (Import to Inside Pages).

The selected images are displayed in the selected image area.

You can also select the image(s) you want to print by dragging them into the selected image area.

Note

- To delete an image in the selected image area, select the image you want to delete and click



(Delete Imported Image).

To delete all images from the selected image area, click  (Delete All Imported Images).

Note

- See Help for details on the Select Images screen.



Page top↑

Advanced Guide

Advanced Guide > Printing from a Computer > Printing with the Bundled Application Software > Printing Stickers > Editing

Editing

1. Click Edit.

The Edit screen appears.

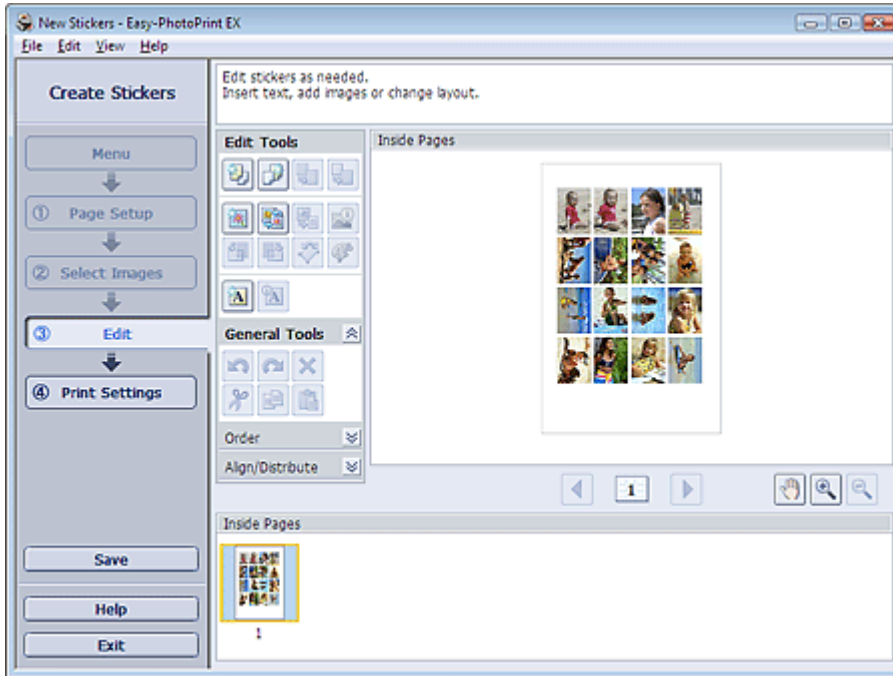

2. Edit the stickers if necessary.

- ➔ Adding Photos
- ➔ Swapping Positions of Photos
- ➔ Replacing Photos
- ➔ Changing Position, Angle and Size of Photos
- ➔ Cropping Photos
- ➔ Printing Dates on Photos
- ➔ Adding Text to Photos

Note

- The edit information will be discarded if you exit Easy-PhotoPrint EX without saving the edited stickers. It is recommended that you save the item if you want to edit it again.
 - ➔ Saving
- See Help for details on the Edit screen.



[Page top](#)↑

Advanced Guide

Advanced Guide > Printing from a Computer > Printing with the Bundled Application Software > Printing Stickers > Printing

Printing

1. Click Print Settings.

The Print Settings screen appears.

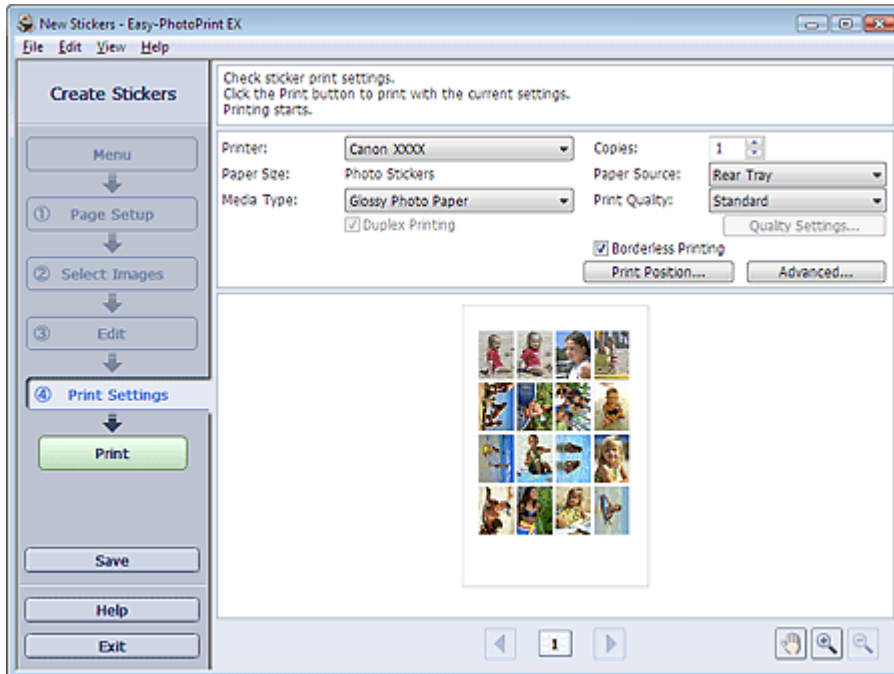

2. Set the following items according to the printer and paper to be used:

Printer

Media Type

Copies

Paper Source

Print Quality

Borderless Printing



Note

- The media types may vary depending on the printer and the paper size.
- The paper sources may vary depending on the printer and the media type.
- You can set a custom print quality level in the Print Quality Settings dialog box. To display the Print Quality Settings dialog box, select Custom for Print Quality and click Quality Settings....
- You can adjust the printing position in the Adjust Print Position dialog box. To display the Adjust Print Position dialog box, click Print Position....
- You can specify the print range and the amount of extension for borderless printing in the Print Settings dialog box. To display the Print Settings dialog box, click Advanced....

3. Click Print.



Note

- See Help for details on the Print Settings screen.



Page top↑

Advanced Guide

Advanced Guide > Printing from a Computer > Printing with the Bundled Application Software > Printing Layout

Printing Layout

You can add text to your favorite photos and print them in a variety of layouts.



Steps

1. Starting Easy-PhotoPrint EX
2. Selecting the Paper and Layout
3. Selecting a Photo
4. Editing
5. Printing

Try This

- ➔ Correcting and Enhancing Photos
- ➔ Changing Layout
- ➔ Adding Photos
- ➔ Swapping Positions of Photos
- ➔ Replacing Photos
- ➔ Changing Position, Angle and Size of Photos
- ➔ Cropping Photos
- ➔ Printing Dates on Photos
- ➔ Adding Text to Photos
- ➔ Saving
- ➔ Opening Saved Files

Questions and Answers

- ➔ How Can I Move (or Copy) the Saved File?

[Page top](#)↑

Advanced Guide

Advanced Guide > Printing from a Computer > Printing with the Bundled Application Software > Printing Layout > Starting Easy-PhotoPrint EX

Starting Easy-PhotoPrint EX

1. From the Start menu, select (All) Programs > Canon Utilities > Easy-PhotoPrint EX > Easy-PhotoPrint EX.

Easy-PhotoPrint EX starts and Menu appears.

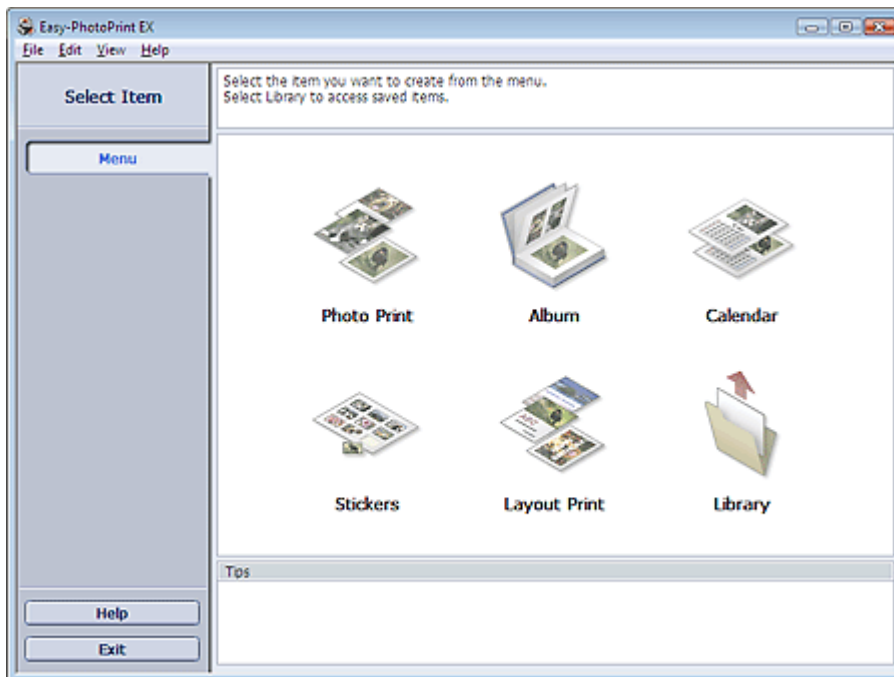

[Page top](#)↑

Advanced Guide

Advanced Guide > Printing from a Computer > Printing with the Bundled Application Software > Printing Layout > Selecting the Paper and Layout

Selecting the Paper and Layout

1. Click Layout Print from Menu.

The Page Setup screen appears.

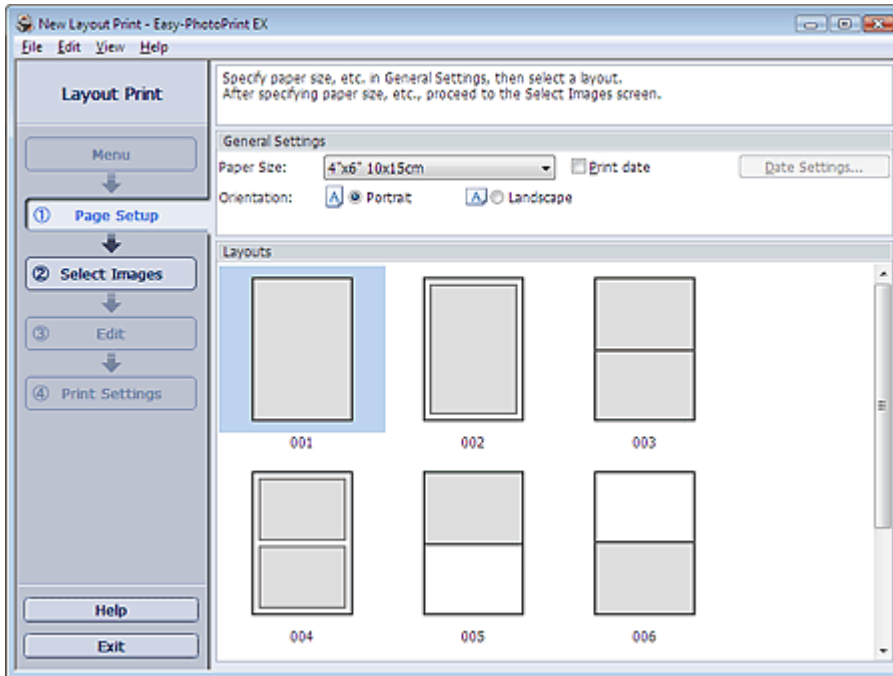

2. Set the following items in the General Settings section:

Paper Size

Orientation

Print date

Note

- See Help on the paper size that can be selected.
- You can customize the date (position, size and color) in the Date Settings dialog box. To display the Date Settings dialog box, select the Print date checkbox and click Date Settings....

3. Select a layout from Layouts.

Note

- The layouts displayed may vary depending on the Orientation.

Note

- See Help for details on the Page Setup screen.



Page top↑

Advanced Guide

Advanced Guide > Printing from a Computer > Printing with the Bundled Application Software > Printing Layout > Selecting a Photo

Selecting a Photo

1. Click Select Images.

The Select Images screen appears.

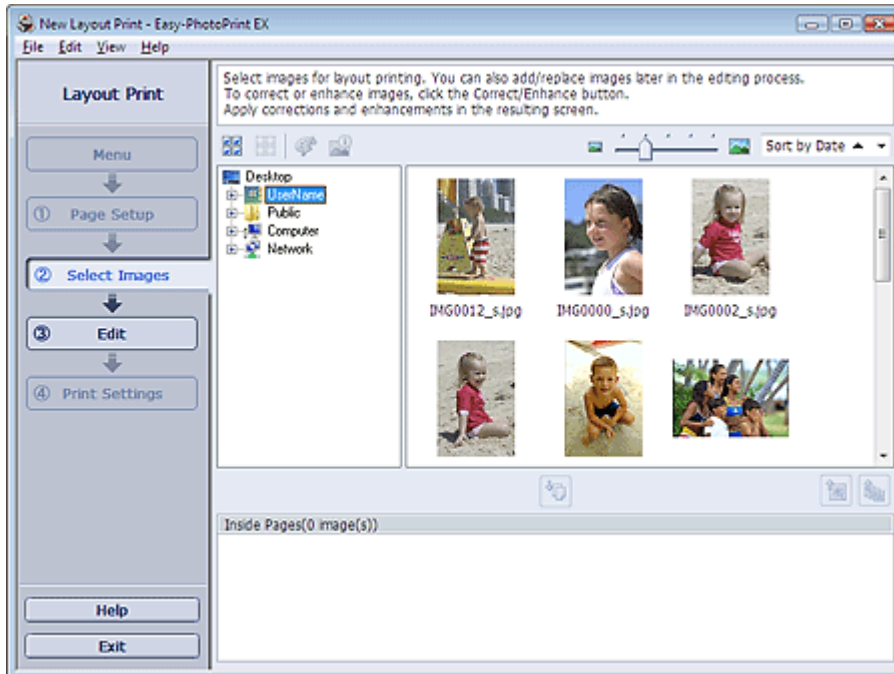

2. Select the folder that contains the image you want to print from the folder tree area.

The images in the folder will be displayed as thumbnails (miniatures).

3. Select the image(s) you want to print and click (Import to Inside Pages).

The selected images are displayed in the selected image area.

You can also select the image(s) you want to print by dragging them into the selected image area.

Note

- To delete an image in the selected image area, select the image you want to delete and click



(Delete Imported Image).

To delete all images from the selected image area, click  (Delete All Imported Images).

Note

- See Help for details on the Select Images screen.



Page top↑

Advanced Guide

Advanced Guide > Printing from a Computer > Printing with the Bundled Application Software > Printing Layout > Editing

Editing

1. Click Edit.

The Edit screen appears.

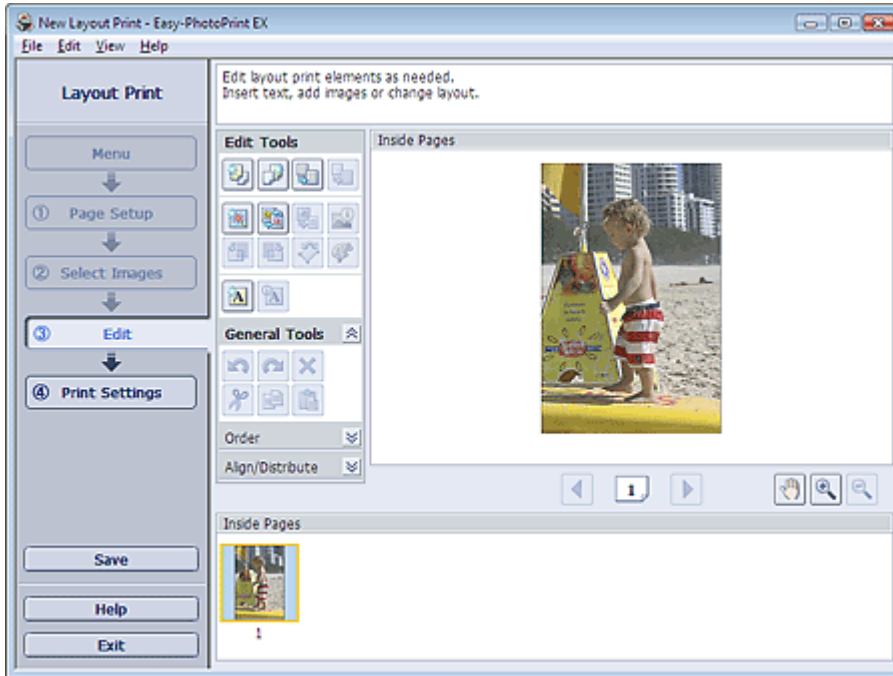

2. Edit the layout if necessary.

- ➔ Changing Layout
- ➔ Adding Photos
- ➔ Swapping Positions of Photos
- ➔ Replacing Photos
- ➔ Changing Position, Angle and Size of Photos
- ➔ Cropping Photos
- ➔ Printing Dates on Photos
- ➔ Adding Text to Photos

Note

- The edit information will be discarded if you exit Easy-PhotoPrint EX without saving the edited layout. It is recommended that you save the item if you want to edit it again.
 - ➔ Saving
- See Help for details on the Edit screen.



Page top↑

Advanced Guide

Advanced Guide > Printing from a Computer > Printing with the Bundled Application Software > Printing Layout > Printing

Printing

1. Click Print Settings.

The Print Settings screen appears.

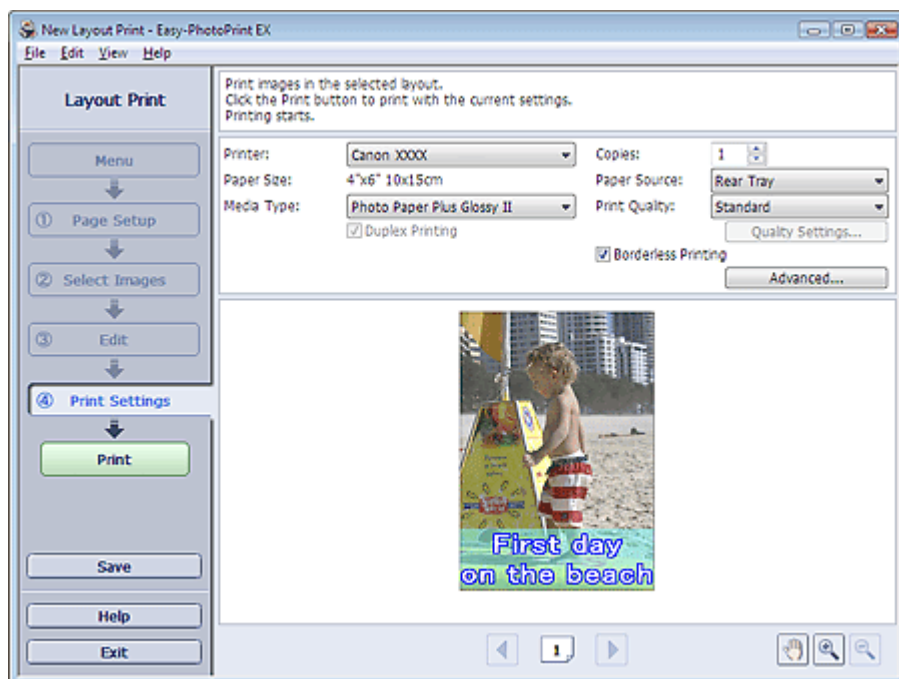

2. Set the following items according to the printer and paper to be used:

Printer

Media Type

Copies

Paper Source

Print Quality

Borderless Printing



Note

- The media types may vary depending on the printer and the paper size.
- Duplex Printing appears if the selected printer and media type support duplex printing. Select this checkbox to print on both sides of the paper.
- Automatic appears if you select the Duplex Printing checkbox after selecting a printer that supports automatic duplex printing and media type that supports duplex printing. Select this checkbox to print on both sides of the paper automatically.
- The paper sources may vary depending on the printer and the media type.
- You can set a custom print quality level in the Print Quality Settings dialog box. To display the Print Quality Settings dialog box, select Custom for Print Quality and click Quality Settings....
- Select the Borderless Printing checkbox to print borderless photos.
- You can specify the print range and the amount of extension for borderless printing in the Print Settings dialog box. To display the Print Settings dialog box, click Advanced....

3. Click Print.



Note

- See Help for details on the Print Settings screen.



Advanced Guide

Advanced Guide > Printing from a Computer > Printing with the Bundled Application Software > Correcting and Enhancing Photos

Correcting and Enhancing Photos

You can correct and enhance images.

Click  (Correct/Enhance Images) in the Select Images or Edit screen, or in the Layout/Print screen of Photo Print. You can make the following corrections and enhancements in the Correct/Enhance Images window.

Important

- For Photo Print, if you select Enable ICC Profile in the Advanced tab of the Preferences dialog box, you cannot correct/enhance images.

Note

- See "[Correct/Enhance Images Window](#)" for details on the Correct/Enhance Images window.

Auto Photo Fix

This function will automatically analyze the captured scene and apply suitable corrections.

➡ [Using the Auto Photo Fix Function](#)

Red-Eye Correction Function

You can correct red eyes caused by a camera flash.

➡ [Using the Red-Eye Correction Function](#)

Face Brightener Function

You can brighten dark faces caused by bright background.

➡ [Using the Face Brightener Function](#)

Face Sharpener Function

You can sharpen out-of-focus faces in a photo.

➡ [Using the Face Sharpener Function](#)

Digital Face Smoothing Function

You can enhance skin beautifully by removing blemishes and wrinkles.

➡ [Using the Digital Face Smoothing Function](#)

Blemish Remover Function

You can remove moles.

➡ [Using the Blemish Remover Function](#)

Image Adjustment

You can make fine adjustments to the overall brightness, contrast, etc. of images.

➡ [Adjusting Images](#)

[Page top](#)↑

Advanced Guide

Advanced Guide > Printing from a Computer > Printing with the Bundled Application Software > Correcting and Enhancing Photos > Using the Auto Photo Fix Function

Using the Auto Photo Fix Function

Apply optimum corrections automatically to the photos used for an album or calendar.

Important

- The Auto Photo Fix function is not available for Photo Print. Photo Print allows you to automatically apply suitable corrections to all photos when printing. Select this option in Image on the Advanced tab of the Preferences dialog box. To display the Preferences dialog box, click  (Settings) in the Layout/Print screen or select Preferences... from the File menu.
- Once image is corrected with Auto Photo Fix and saved, it cannot be corrected again with Auto Photo Fix.

Also, Auto Photo Fix may not be available for images edited using an application, digital camera, etc. manufactured by other companies.

1. Select photos in the Select Images screen, then click  (Correct/Enhance Images).

The Correct/Enhance Images window appears.

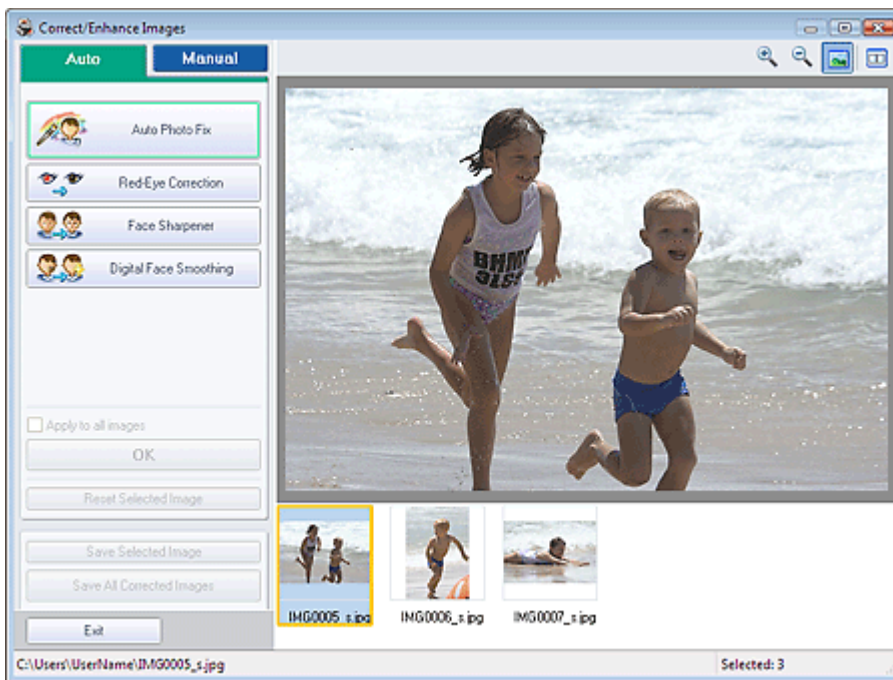

Note

- You can also display the Correct/Enhance Images window by clicking  (Correct/Enhance Images) in the Layout/Print or Edit screen. In that case, only the image displayed in Preview can be corrected/enhanced.
- See "[Correct/Enhance Images Window](#)" for details on the Correct/Enhance Images window.

2. Select the image you want to correct from the list displayed in the lower part of the Correct/Enhance Images window.

The image appears in Preview.

Note

- If only one image is selected, the thumbnail does not appear below Preview.

3. Make sure that Auto is selected.

4. Click Auto Photo Fix, then click OK.

The entire photo is corrected automatically and the  (Correction/Enhancement) mark appears on the upper left of the image.

Note

- Click  (Compare) to display the images before and after the correction side by side so that you can compare and check the result.
 - Click Reset Selected Image to undo the correction operation.
 - If you want to apply the correction to all the selected images at once, select the Apply to all images checkbox.
-

5. Click Save Selected Image or Save All Corrected Images.

You can save corrected images as new files.

Note

- To save only the image you like, click Save Selected Image. To save all images, click Save All Corrected Images.
 - Only JPEG/Exif file format is available for corrected images.
-

6. Click Exit.

Note

- The corrections will be lost if you exit before saving corrected images.
-

[Page top](#)↑

Advanced Guide

Advanced Guide > Printing from a Computer > Printing with the Bundled Application Software > Correcting and Enhancing Photos > Using the Red-Eye Correction Function

Using the Red-Eye Correction Function

You can correct red eyes caused by a camera flash.

You can perform the Red-Eye Correction function either automatically or manually.

Note

- Photo Print allows you to automatically correct red eyes when printing. To correct automatically, select Enable Auto Photo Fix in Color correction for printing on the Advanced tab of the Preferences dialog box and select the Enable Red-Eye Correction checkbox.

- Select photos in the Select Images screen, then click  (Correct/Enhance Images).

The Correct/Enhance Images window appears.

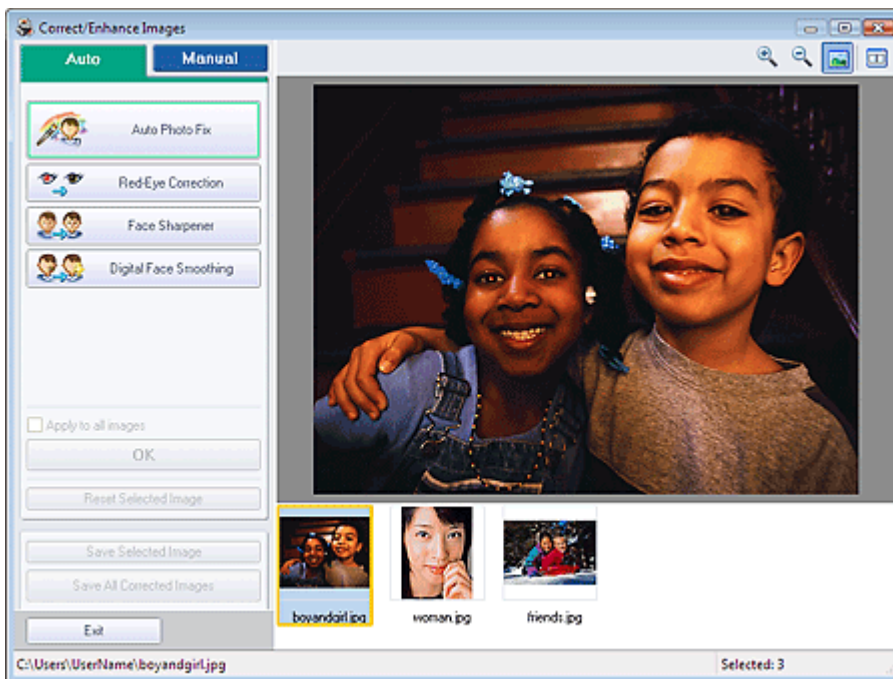

Note

- You can also display the Correct/Enhance Images window by clicking  (Correct/Enhance Images) in the Layout/Print or Edit screen. In that case, only the image displayed in Preview can be corrected/enhanced.
- See "[Correct/Enhance Images Window](#)" for details on the Correct/Enhance Images window.

- Select the image you want to correct from the list displayed in the lower part of the Correct/Enhance Images window.

The image appears in Preview.

Note

- If only one image is selected, the thumbnail does not appear below Preview.

Auto Correction

- Make sure that Auto is selected.
- Click Red-Eye Correction.

5. Click OK.

Red eyes are corrected and the  (Correction/Enhancement) mark appears on the upper left of the image.

Important

- Areas other than the eyes may be corrected depending on the image.

Note

- Click  (Compare) to display the images before and after the correction side by side so that you can compare and check the result.
- Click Reset Selected Image to undo the correction operation.
- If you want to apply the correction to all the selected images at once, select the Apply to all images checkbox.

Manual Correction**3. Click Manual, then click Correct/Enhance.****4. Click Red-Eye Correction.**

Move the cursor over the image. The shape of the cursor changes to  (Paintbrush).

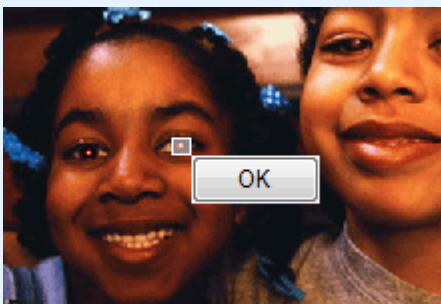
**5. Drag to select the red area you want to correct, then click OK that appears over the image.**

Red eye is corrected and the  (Correction/Enhancement) mark appears on the upper left of the image.

Note

- Click Undo to undo the preceding correction operation.
- Effect levels can be changed using the slider below Red-Eye Correction.

6. Click Save Selected Image or Save All Corrected Images.

You can save corrected images as new files.

Note

- To save only the image you like, click Save Selected Image. To save all images, click Save All Corrected Images.
 - Only JPEG/Exif file format is available for corrected images.
-

7. Click Exit.

Note

- The corrections will be lost if you exit before saving corrected images.
-

[Page top](#) 

Advanced Guide

Advanced Guide > Printing from a Computer > Printing with the Bundled Application Software > Correcting and Enhancing Photos > Using the Face Brightener Function

Using the Face Brightener Function

You can brighten dark faces caused by bright background.

1. Select photos in the Select Images screen, then click  (Correct/Enhance Images).

The Correct/Enhance Images window appears.



Note

- You can also display the Correct/Enhance Images window by clicking  (Correct/Enhance Images) in the Layout/Print or Edit screen. In that case, only the image displayed in Preview can be corrected/enhanced.
- See "[Correct/Enhance Images Window](#)" for details on the Correct/Enhance Images window.

2. Select the image you want to correct from the list displayed in the lower part of the Correct/Enhance Images window.

The image appears in Preview.

Note

- If only one image is selected, the thumbnail does not appear below Preview.

3. Click Manual, then click Correct/Enhance.

4. Click Face Brightener.

Move the cursor over the image. The shape of the cursor changes to  (Cross).

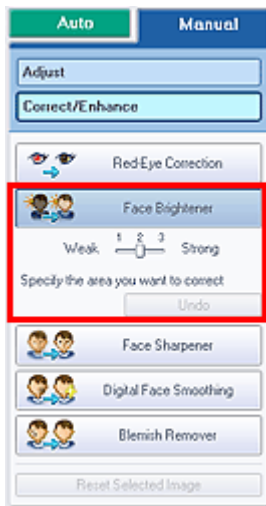

5. Drag to select the area you want to correct, then click OK that appears over the image.

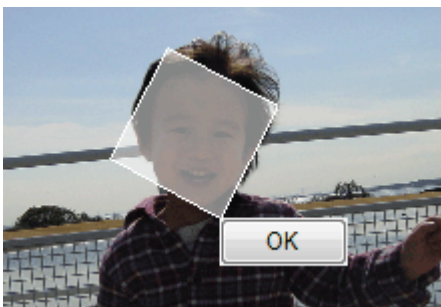

The entire image is corrected so that the selected area containing the face becomes brighter, and the 🗑️ (Correction/Enhancement) mark appears on the upper left of the image.

Note

- You can also drag to rotate the rectangle.
- Click Undo to undo the preceding correction operation.
- Effect levels can be changed using the slider below Face Brightener.

6. Click Save Selected Image or Save All Corrected Images.

You can save corrected images as new files.

Note

- To save only the image you like, click Save Selected Image. To save all images, click Save All Corrected Images.
- Only JPEG/Exif file format is available for corrected images.

7. Click Exit.

Note

- The corrections will be lost if you exit before saving corrected images.

[Page top↑](#)

Advanced Guide

Advanced Guide > Printing from a Computer > Printing with the Bundled Application Software > Correcting and Enhancing Photos > Using the Face Sharpener Function

Using the Face Sharpener Function

You can sharpen out-of-focus faces in a photo.

You can perform the Face Sharpener function either automatically or manually.

1. Select photos in the Select Images screen, then click  (Correct/Enhance Images).

The Correct/Enhance Images window appears.

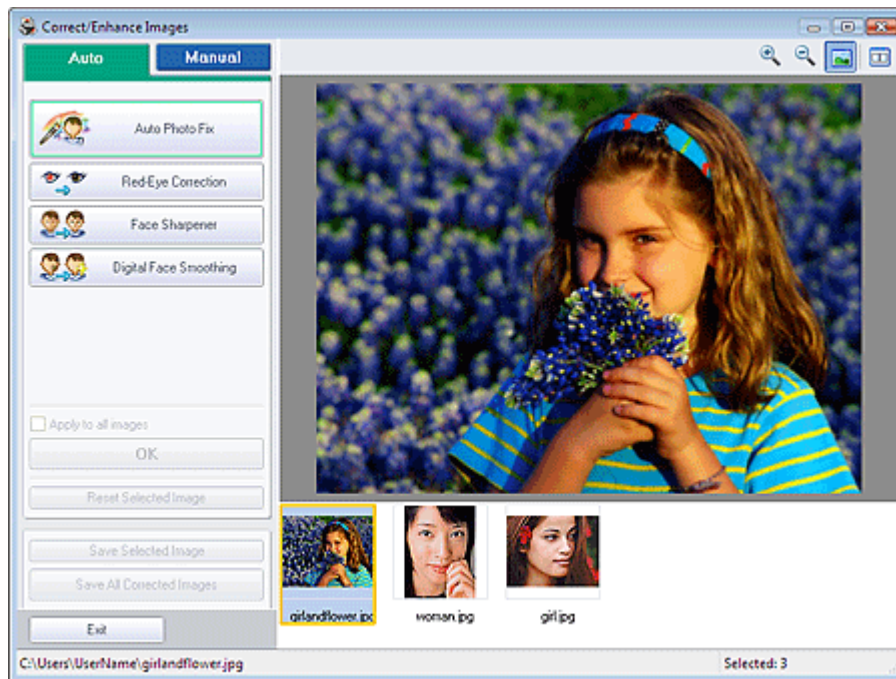

Note

- You can also display the Correct/Enhance Images window by clicking  (Correct/Enhance Images) in the Layout/Print or Edit screen. In that case, only the image displayed in Preview can be corrected/enhanced.
- See "[Correct/Enhance Images Window](#)" for details on the Correct/Enhance Images window.

2. Select the image you want to correct from the list displayed in the lower part of the Correct/Enhance Images window.

The image appears in Preview.

Note

- If only one image is selected, the thumbnail does not appear below Preview.

Auto Correction

3. Make sure that Auto is selected.
4. Click Face Sharpener.
5. Click OK.

The face is sharpened and the  (Correction/Enhancement) mark appears on the upper left of the image.

 **Note**

- Effect levels can be changed using the slider below Face Sharpener.
- Click  (Compare) to display the images before and after the correction side by side so that you can compare and check the result.
- Click Reset Selected Image to undo the correction operation.
- If you want to apply the correction to all the selected images at once, select the Apply to all images checkbox.

Manual Correction

3. Click Manual, then click Correct/Enhance.

4. Click Face Sharpener.

Move the cursor over the image. The shape of the cursor changes to  (Cross).

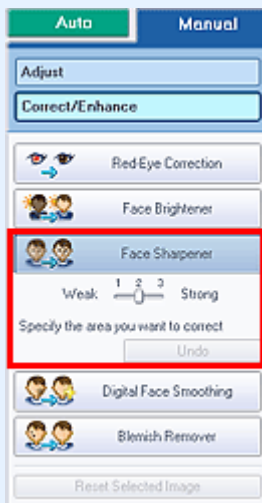

5. Drag to select the area you want to correct, then click OK that appears over the image.

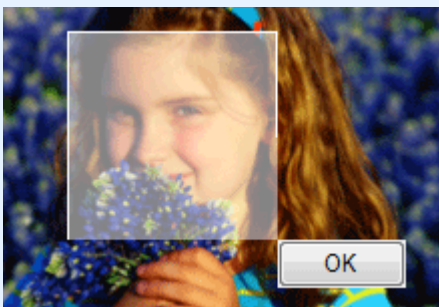

The facial area in and around the selected area is sharpened and the  (Correction/Enhancement) mark appears on the upper left of the image.

 **Note**

- You can also drag to rotate the rectangle.
- Click Undo to undo the preceding correction operation.
- Effect levels can be changed using the slider below Face Sharpener.

6. Click Save Selected Image or Save All Corrected Images.

You can save corrected images as new files.

 **Note**

- To save only the image you like, click Save Selected Image. To save all images, click Save All Corrected Images.

- Only JPEG/Exif file format is available for corrected images.
-

7. Click Exit.



Note

- The corrections will be lost if you exit before saving corrected images.
-

[Page top](#)↑

Advanced Guide

Advanced Guide > Printing from a Computer > Printing with the Bundled Application Software > Correcting and Enhancing Photos > Using the Digital Face Smoothing Function

Using the Digital Face Smoothing Function

You can enhance skin beautifully by removing blemishes and wrinkles.

You can perform the Digital Face Smoothing function either automatically or manually.

1. Select photos in the Select Images screen, then click  (Correct/Enhance Images).

The Correct/Enhance Images window appears.



Note

- You can also display the Correct/Enhance Images window by clicking  (Correct/Enhance Images) in the Layout/Print or Edit screen. In that case, only the image displayed in Preview can be corrected/enhanced.
- See "[Correct/Enhance Images Window](#)" for details on the Correct/Enhance Images window.

2. Select the image you want to enhance from the list displayed in the lower part of the Correct/Enhance Images window.

The image appears in Preview.

Note

- If only one image is selected, the thumbnail does not appear below Preview.

Auto Enhancement

3. Make sure that Auto is selected.
4. Click Digital Face Smoothing.
5. Click OK.

Skin is enhanced beautifully and the  (Correction/Enhancement) mark appears on the upper left of the image.

Note

- Effect levels can be changed using the slider below Digital Face Smoothing.
- Click  (Compare) to display the images before and after the enhancement side by side so that you can compare and check the result.
- Click Reset Selected Image to undo the enhancement operation.
- If you want to apply the enhancement to all the selected images at once, select the Apply to all images checkbox.

Manual Enhancement

3. Click Manual, then click Correct/Enhance.

4. Click Digital Face Smoothing.

Move the cursor over the image. The shape of the cursor changes to  (Cross).



5. Drag to select the area you want to enhance, then click OK that appears over the image.

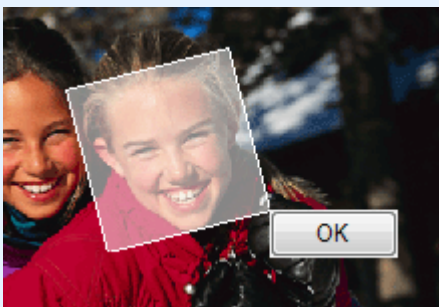

Skin in and around the selected area is enhanced beautifully and the  (Correction/Enhancement) mark appears on the upper left of the image.

Note

- You can also drag to rotate the rectangle.
- Click Undo to undo the preceding enhancement operation.
- Effect levels can be changed using the slider below Digital Face Smoothing.

6. Click Save Selected Image or Save All Corrected Images.

You can save enhanced images as new files.

Note

- To save only the image you like, click Save Selected Image. To save all images, click Save All Corrected Images.

- Only JPEG/Exif file format is available for enhanced images.
-

7. Click Exit.



Note

- The enhancements will be lost if you exit before saving enhanced images.
-

[Page top](#)↑

Advanced Guide

Advanced Guide > Printing from a Computer > Printing with the Bundled Application Software > Correcting and Enhancing Photos > Using the Blemish Remover Function

Using the Blemish Remover Function

You can remove moles.

1. Select photos in the Select Images screen, then click  (Correct/Enhance Images).

The Correct/Enhance Images window appears.

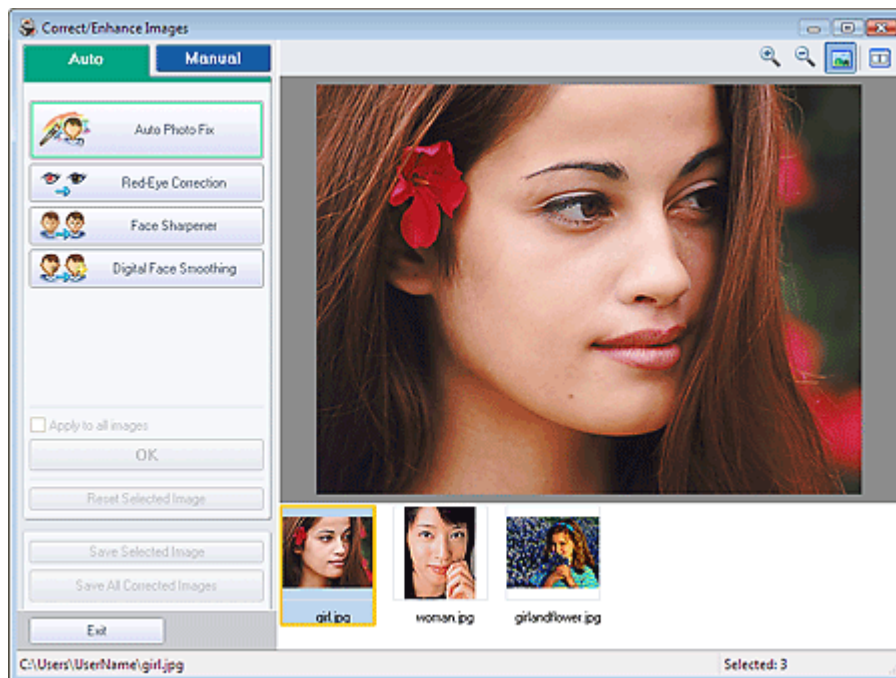

Note

- You can also display the Correct/Enhance Images window by clicking  (Correct/Enhance Images) in the Layout/Print or Edit screen. In that case, only the image displayed in Preview can be corrected/enhanced.
- See "[Correct/Enhance Images Window](#)" for details on the Correct/Enhance Images window.

2. Select the image you want to enhance from the list displayed in the lower part of the Correct/Enhance Images window.

The image appears in Preview.

Note

- If only one image is selected, the thumbnail does not appear below Preview.

3. Click Manual, then click Correct/Enhance.

4. Click Blemish Remover.

Move the cursor over the image. The shape of the cursor changes to  (Cross).



5. Drag to select the area you want to enhance, then click OK that appears over the image.

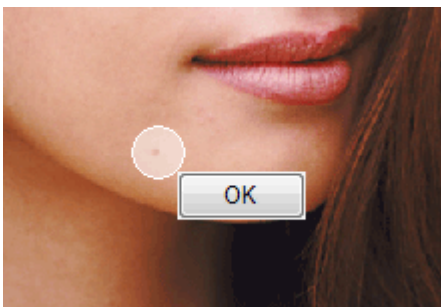

Moles in and around the selected area are removed and the 🧑🏻 (Correction/Enhancement) mark appears on the upper left of the image.

Note

- Click Undo to undo the preceding enhancement operation.

6. Click Save Selected Image or Save All Corrected Images.

You can save enhanced images as new files.

Note

- To save only the image you like, click Save Selected Image. To save all images, click Save All Corrected Images.
- Only JPEG/Exif file format is available for enhanced images.

7. Click Exit.

Note

- The enhancements will be lost if you exit before saving enhanced images.

[Page top](#)↑

Advanced Guide

Advanced Guide > Printing from a Computer > Printing with the Bundled Application Software > Correcting and Enhancing Photos > Adjusting Images

Adjusting Images

You can make fine adjustments to the overall brightness, contrast, etc. of images.

1. Select photos in the Select Images screen, then click  (Correct/Enhance Images).

The Correct/Enhance Images window appears.

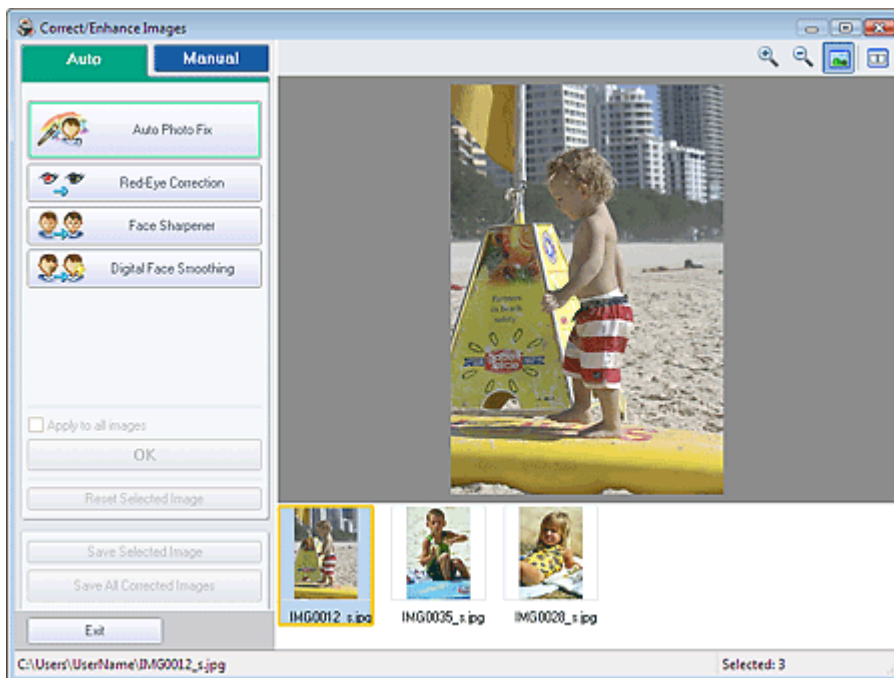

Note

- You can also display the Correct/Enhance Images window by clicking  (Correct/Enhance Images) in the Layout/Print or Edit screen. In that case, only the image displayed in Preview can be corrected/enhanced.
- See "[Correct/Enhance Images Window](#)" for details on the Correct/Enhance Images window.

2. Select the image you want to adjust from the list displayed in the lower part of the Correct/Enhance Images window.

The image appears in Preview.

Note

- If only one image is selected, the thumbnail does not appear below Preview.

3. Click Manual, then click Adjust.
4. Move the slider of the item you want to adjust and set the effect level.

The following adjustments are available:

Brightness
 Contrast
 Sharpness
 Blur
 Show-through Removal

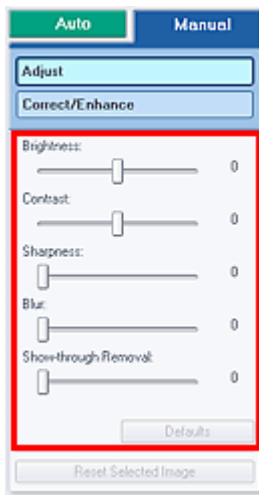
**Note**

- Click Defaults to reset all adjustments.

5. Click Save Selected Image or Save All Corrected Images.

You can save adjusted images as new files.

**Note**

- To save only the image you like, click Save Selected Image. To save all images, click Save All Corrected Images.
- Only JPEG/Exif file format is available for adjusted images.

6. Click Exit.**Note**

- The adjustments will be lost if you exit before saving adjusted images.

[Page top](#)↑

Advanced Guide

Advanced Guide > Printing from a Computer > Printing with the Bundled Application Software > Correcting and Enhancing Photos > Correct/Enhance Images Window

Correct/Enhance Images Window

You can correct/enhance images in this window.

To display the Correct/Enhance Images window, click  (Correct/Enhance Images) in the Select Images or Edit screen, or in the Layout/Print screen of Photo Print.

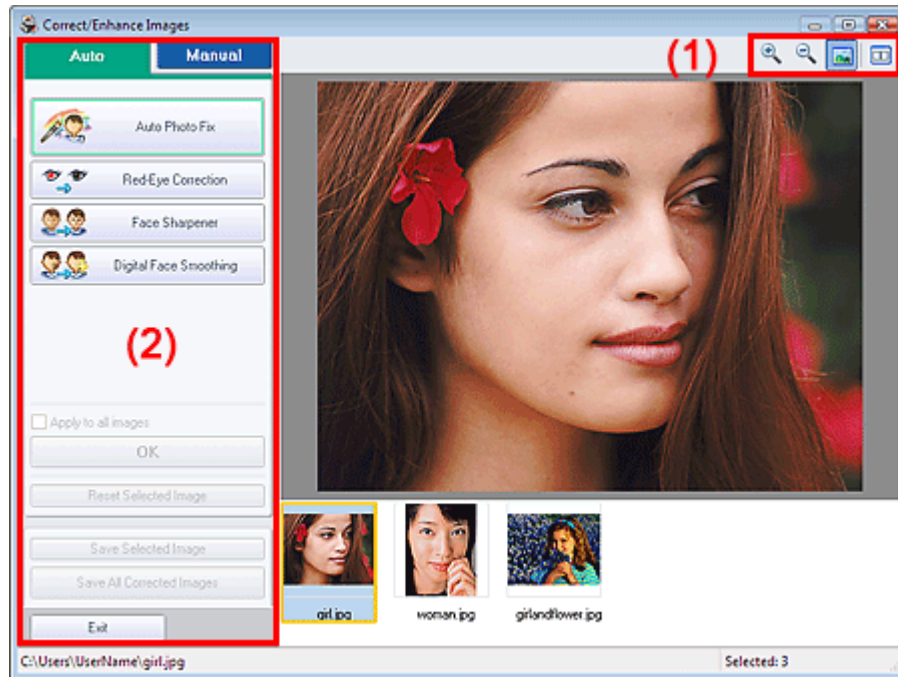

(1)Toolbar

Toolbar



(Zoom In/Zoom Out)

Displays the enlarged or reduced preview of the page.



(Full Screen)

Displays the entire image in Preview.



(Compare)

Displays the Compare Images window. You can compare the images before and after the correction side by side.

The image before the correction/enhancement is displayed on the left, and the image after the correction/enhancement is displayed on the right.

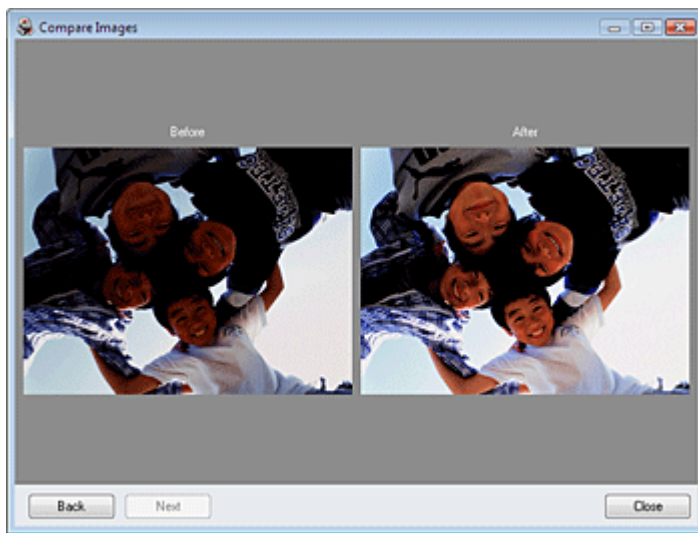

(2)Task Area

Available tasks and settings may vary between the Auto and Manual tabs. Click Auto or Manual to display the corresponding tab.

Auto Tab

Select to correct automatically.

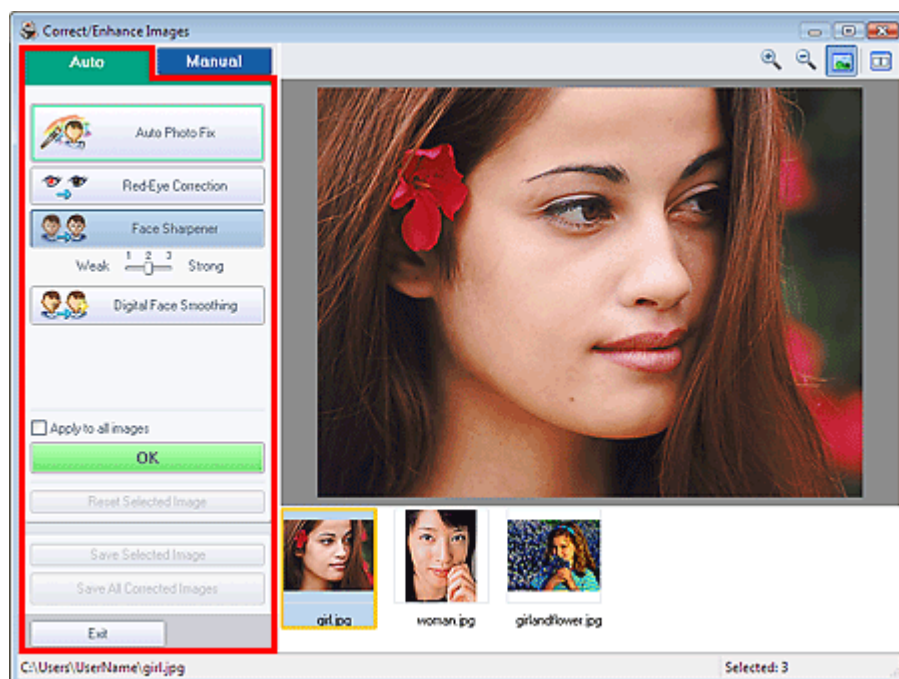

Auto Photo Fix

Applies automatic corrections suitable for photos.

Important

- The Auto Photo Fix function is not available for Photo Print. Photo Print allows you to automatically apply suitable corrections to all photos when printing. Select this option in Image on the Advanced tab of the Preferences dialog box. To display the Preferences dialog box, click  (Settings) in the Layout/Print screen or select Preferences... from the File menu.

Red-Eye Correction

Corrects red eyes.

Note

- For Photo Print, you can also correct red eyes by selecting Enable Auto Photo Fix in Color correction for printing on the Advanced tab of the Preferences dialog box and selecting the Enable Red-Eye Correction checkbox.

Face Sharpener

Sharpens out-of-focus faces.

You can adjust the effect level using the slider.

Digital Face Smoothing

Enhances skin beautifully by removing blemishes and wrinkles.

You can adjust the effect level using the slider.

Apply to all images

Automatically corrects all the images displayed in the list.

OK

Applies the selected effect to the selected image or all images.

Reset Selected Image

Cancels all corrections and enhancements applied to the selected image.

Save Selected Image

Saves the selected image.

Save All Corrected Images

Saves all the images displayed in the list.

Exit

Click to close the Correct/Enhance Images window.

Manual Tab

Select to correct manually.

Use Adjust to adjust brightness and contrast, or to sharpen the entire image.

Use Correct/Enhance to correct/enhance specific areas.

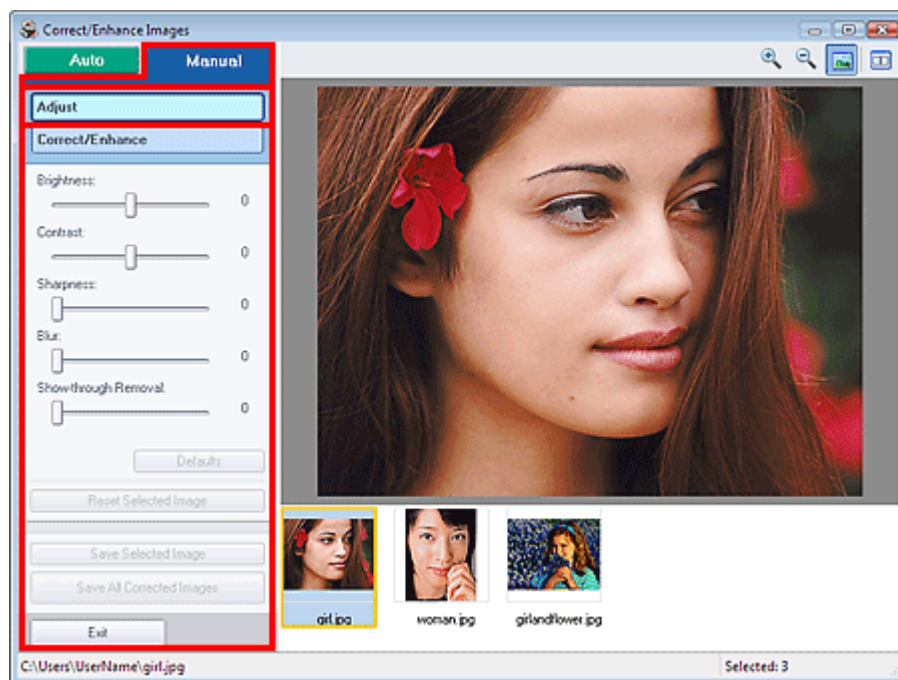
Adjust**Brightness**

Adjusts the overall image brightness.

Move the slider to the left to darken and right to brighten the image.

Contrast

Adjusts the contrast of the image. Adjust the contrast when the image is flat due to lack of contrast.

Move the slider to the left to decrease and right to increase the contrast of the image.

Sharpness

Emphasizes the outline of the subjects to sharpen the image. Adjust the sharpness when the photo is out of focus or text is blurred.

Move the slider to the right to sharpen the image.

Blur

Blurs the outline of the subjects to soften the image.
Move the slider to the right to soften the image.

Show-through Removal

Removes show-through of text from the reverse side or removes the base color. Adjust the show-through level to prevent text on the reverse side of thin document or the base color of the document from appearing on the image.

Move the slider to the right to increase the show-through removal effect.

Defaults

Resets all adjustments (brightness, contrast, sharpness, blur, and show-through removal).

Reset Selected Image

Cancels all adjustments applied to the selected image.

Save Selected Image

Saves the selected image.

Save All Corrected Images

Saves all the images displayed in the list.

Exit

Click to close the Correct/Enhance Images window.

Correct/Enhance**Red-Eye Correction**

Corrects red eyes.

You can specify the area you want to apply the effect to. You can adjust the effect level using the slider.

**Note**

- For Photo Print, red eyes are automatically corrected when Enable Auto Photo Fix is selected in Color correction for printing on the Advanced tab of the Preferences dialog box and the Enable Red-Eye Correction checkbox is selected. To disable the automatic correction, deselect the checkbox.

Face Brightener

Corrects the entire image so that the selected facial area is brightened.

You can adjust the effect level using the slider.

Face Sharpener

Sharpens out-of-focus faces.

You can specify the area you want to apply the effect to. You can adjust the effect level using the slider.

Digital Face Smoothing

Enhances skin beautifully by removing blemishes and wrinkles.

You can specify the area you want to apply the effect to. You can adjust the effect level using the slider.

Blemish Remover

Removes moles.

You can specify the area you want to apply the effect to.

Undo

Cancels the latest correction/enhancement.

OK

Applies the selected effect to the specified area.

Reset Selected Image

Cancels all corrections and enhancements applied to the selected image.

Save Selected Image

Saves the selected image.

Save All Corrected Images

Saves all the images displayed in the list.

Exit

Click to close the Correct/Enhance Images window.

[Page top](#)↑

Advanced Guide

[Advanced Guide](#) > [Printing from a Computer](#) > [Printing with the Bundled Application Software](#) > [Questions and Answers](#)

Questions and Answers

- ➡ [How Can I Move \(or Copy\) the Saved File?](#)
- ➡ [Which Side of the Displayed Image Does the Printing Start from?](#)
- ➡ [How Do I Print with Even Margins?](#)
- ➡ [What Is "C1" or "C4"?](#)

[Page top](#)↑

Advanced Guide

Advanced Guide > Printing from a Computer > Printing with the Bundled Application Software > Questions and Answers > How Can I Move (or Copy) the Saved File?

How Can I Move (or Copy) the Saved File?

If you want to move (or copy) a file created and saved with Easy-PhotoPrint EX from one folder to another, you need to move (or copy) the folder that was automatically created when originally saving that file as well.

For example, when you save a file named "MyAlbum.e1," a folder named "MyAlbum.e1.Data" is automatically created in the same folder that contains the "MyAlbum.e1" file. If you want to move (or copy) the "MyAlbum.e1" file to another folder, move (or copy) the "MyAlbum.e1.Data" folder as well.

The "MyAlbum.e1.Data" folder contains the photos used in the album.

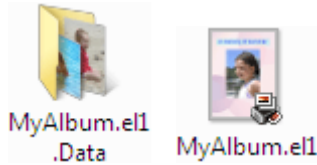

Note

- The icons may vary depending on the items.

Important

- Do not change the Data folder name; otherwise you will not be able to display the photos you edited with Easy-PhotoPrint EX.

[Page top](#)↑

Advanced Guide

Advanced Guide > Printing from a Computer > Printing with the Bundled Application Software > Questions and Answers > Which Side of the Displayed Image Does the Printing Start from?

Which Side of the Displayed Image Does the Printing Start from?

As shown below, printing starts from the left side of the image displayed in the Layout/Print screen.



Outputs the paper in the direction as the arrow indicates.

See your printer manual for details on how to load paper (to print on the front/back, etc.).

[Page top](#)

Advanced Guide

[Advanced Guide](#) > [Printing from a Computer](#) > [Printing with the Bundled Application Software](#) > [Questions and Answers](#)
> [How Do I Print with Even Margins?](#)

How Do I Print with Even Margins?

When you print on a bordered layout, the margins on the left and right or the top and bottom may become wider than the other, depending on the image and printer.

To always print with even margins, select the Always crop images when selecting a layout with margins checkbox on the Advanced tab of the Preferences dialog box.

To display the Preferences dialog box, click  (Settings) in the Layout/Print screen or select Preferences... from the File menu.

Crop the photo to apply even margins individually.

➔ [Cropping Photos \(Photo Print\)](#)



Note

- The following setting is available for Photo Print only.
-

[Page top](#)↑

Advanced Guide

Advanced Guide > Printing from a Computer > Printing with the Bundled Application Software > Questions and Answers
> What Is "C1" or "C4"?

What Is "C1" or "C4"?

When an album is printed, labels such as "C1" and "C4" are printed as page numbers.

The "C1" and "C4" represent the front cover and back cover, respectively.

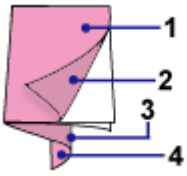

C1: Front cover

C2: Inside the front cover

C3: Inside the back cover

C4: Back cover

[Page top](#)↑

Advanced Guide

Advanced Guide > Printing from a Computer > Printing with the Bundled Application Software > Appendix 1: Easy-PhotoPrint EX Settings

Appendix 1: Easy-PhotoPrint EX Settings

- ➔ Printing Vivid Photos
- ➔ Reducing Photo Noise
- ➔ Cropping Photos (Photo Print)
- ➔ Printing Dates on Photos (Photo Print)
- ➔ Printing Multiple Photos on One Page
- ➔ Printing an Index
- ➔ Printing ID Photos (ID Photo Print)
- ➔ Printing Photo Information
- ➔ Saving Photos
- ➔ Opening Saved Files
- ➔ Changing Layout
- ➔ Changing Background
- ➔ Adding Photos
- ➔ Swapping Positions of Photos
- ➔ Replacing Photos
- ➔ Changing Position, Angle and Size of Photos
- ➔ Cropping Photos
- ➔ Framing Photos
- ➔ Printing Dates on Photos
- ➔ Attaching Comments to Photos
- ➔ Adding Text to Photos
- ➔ Saving
- ➔ Setting Holidays
- ➔ Setting Calendar Display

[Page top](#)↑

Advanced Guide

Advanced Guide > Printing from a Computer > Printing with the Bundled Application Software > Appendix 1: Easy-PhotoPrint EX Settings > Printing Vivid Photos

Printing Vivid Photos

Select the Vivid Photo checkbox in the Select Paper screen to boost the colors in a photo before printing.

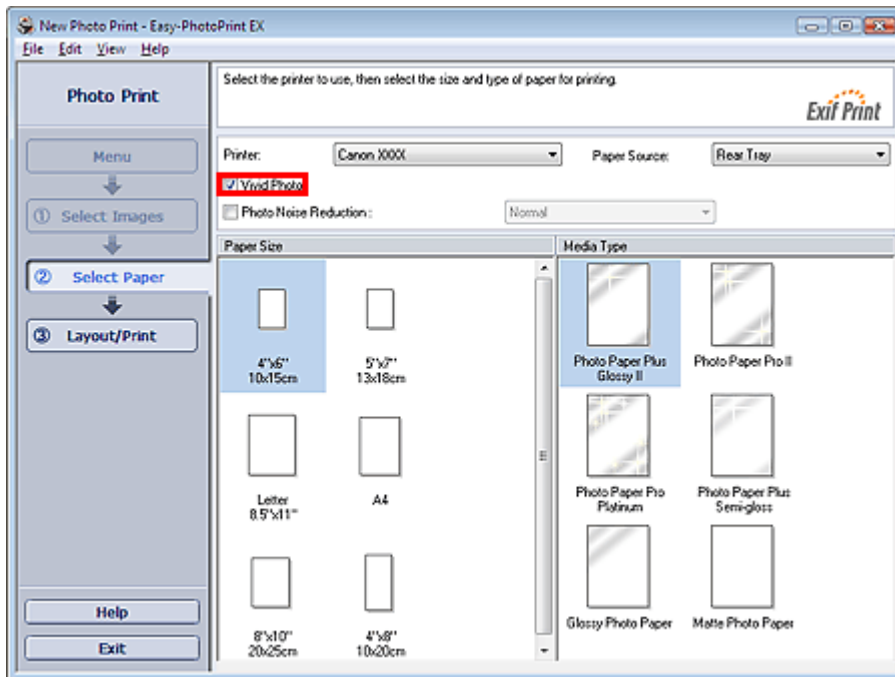

Important

- This function is available only with a printer that supports Vivid Photo.
- This function is not available when Enable ICC Profile is selected on the Advanced tab of the Preferences dialog box.

Note

- Even if you select the Vivid Photo checkbox, this effect applies only to the print result. The original image or preview image will not be affected.

[Page top](#)

Advanced Guide

Advanced Guide > Printing from a Computer > Printing with the Bundled Application Software > Appendix 1: Easy-PhotoPrint EX Settings > Reducing Photo Noise

Reducing Photo Noise

When a photo is taken in a dark location such as night scene using digital camera, noise may appear in the image.

Select the Photo Noise Reduction checkbox in the Select Paper screen to reduce noise in the image and make the printed photos more vivid.

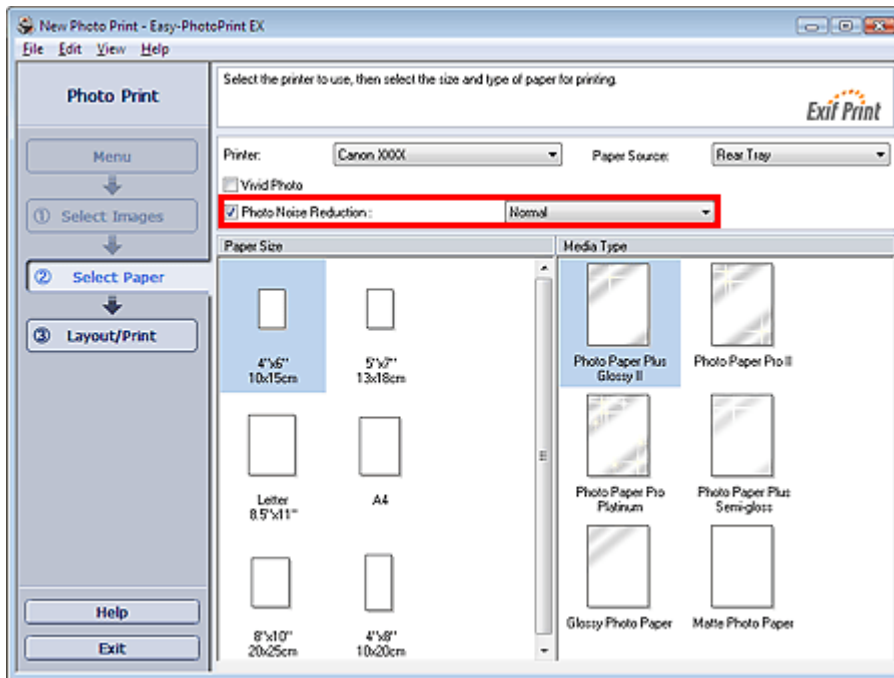

Important

- This function is not available when Enable ICC Profile is selected on the Advanced tab of the Preferences dialog box.

Note

- When the noise is severe, change Normal to Strong.
- The noise reduction effect applies only to the print result. The original image or preview image will not be affected.

[Page top](#) ↑

Advanced Guide

Advanced Guide > Printing from a Computer > Printing with the Bundled Application Software > Appendix 1: Easy-PhotoPrint EX Settings > Cropping Photos (Photo Print)

Cropping Photos (Photo Print)

Cropping a photo is the act of removing the unnecessary portions of the photo by selecting the necessary portions.

Click  (Crop Image) in the Layout/Print screen.

Move the white frame to the portion to print and click OK.

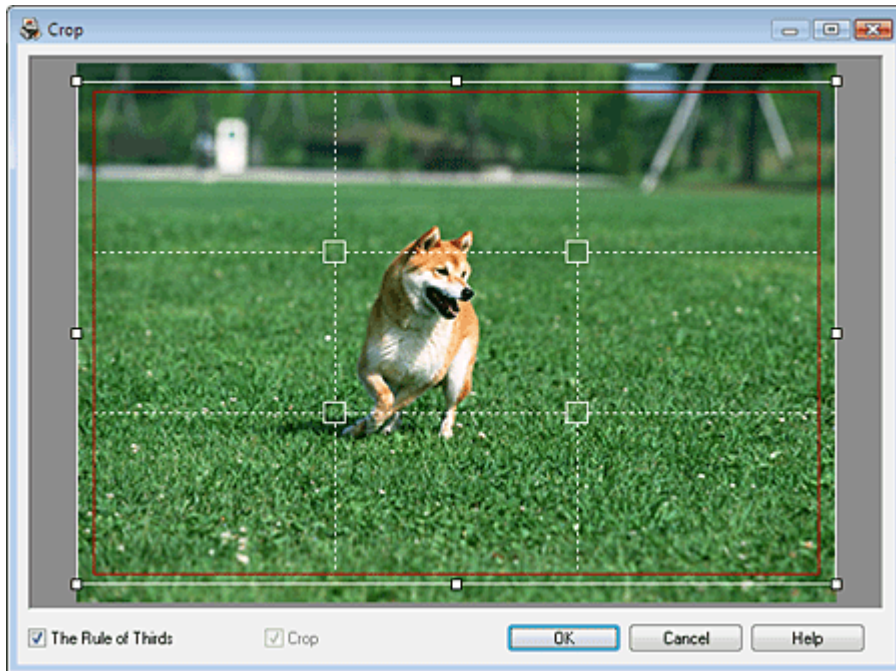

Note

- To move the cropping area, place the cursor within the white frame and drag it. Drag the white lines to enlarge/reduce the cropping area.
- Select the The Rule of Thirds checkbox to display white broken lines. To create a balanced composition, drag any of the intersecting points (white squares) or white broken lines over the main subject of the photo.

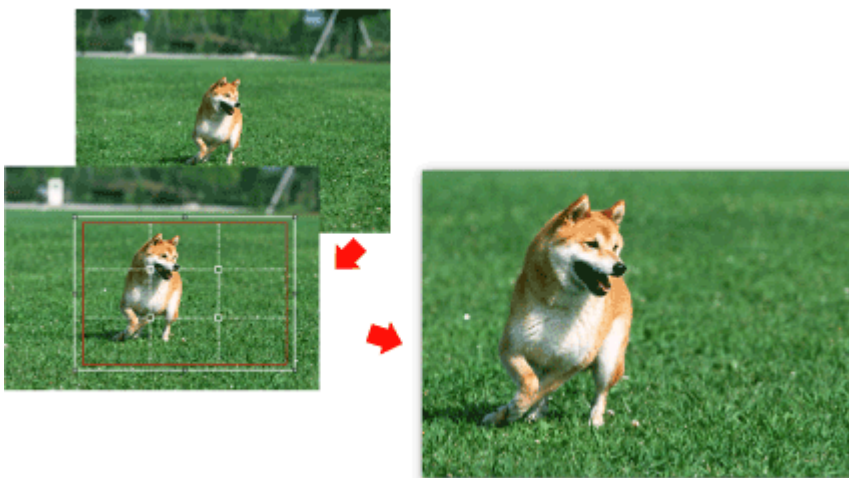

- The cropping effect applies only to the print result. The original image will not be cropped.
- See Help for details on the Crop window.

[Page top](#) 

Advanced Guide

Advanced Guide > Printing from a Computer > Printing with the Bundled Application Software > Appendix 1: Easy-PhotoPrint EX Settings > Printing Dates on Photos (Photo Print)

Printing Dates on Photos (Photo Print)

To print the date the photo was taken on the photo, click  (Date Settings) in the Layout/Print screen, then select the Print date checkbox in the Date Settings dialog box.

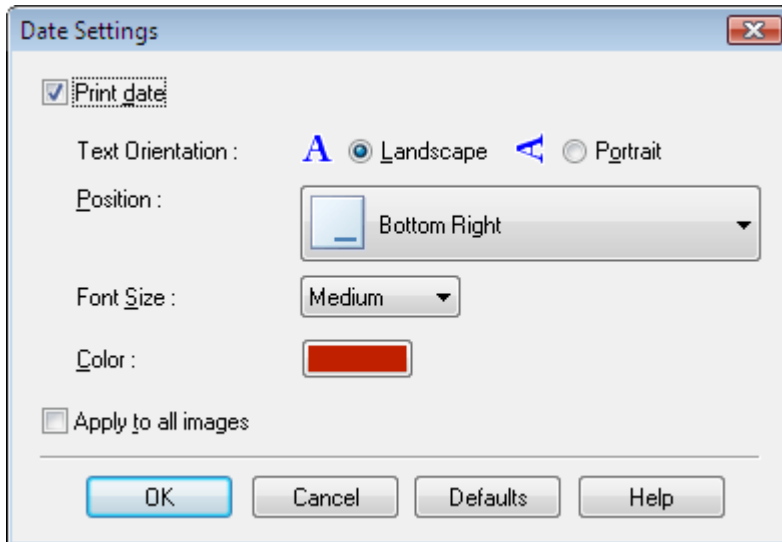

Note

- The date is displayed in the short date format (mm/dd/yyyy, etc.) specified in your operating system.
- In the Date Settings dialog box, you can change the orientation, position, size and color of the date according to the orientation and background of the photo. See Help for details.

[Page top](#)↑

Advanced Guide

Advanced Guide > Printing from a Computer > Printing with the Bundled Application Software > Appendix 1: Easy-PhotoPrint EX Settings > Printing Multiple Photos on One Page

Printing Multiple Photos on One Page

You can print multiple photos on one page by selecting a multiple-photo layout in the Layout/Print screen.

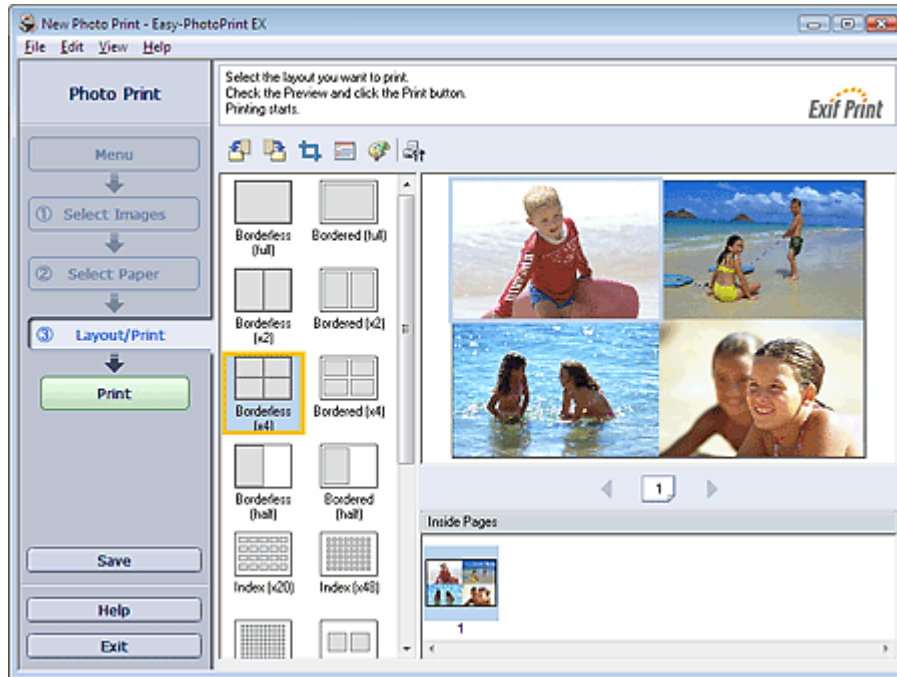

Note

- See the following section for details on how to select photos.
 - ➔ [Selecting a Photo](#)
- The available number of photos and layout may vary depending on the media type.
- Photos are arranged in the following order.
Example: Borderless (x4)

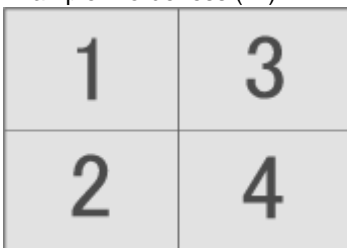

- You can change the printing order in Printing Order on the Print tab of the Preferences dialog box. You can select the printing order from By Date, By Name and By Selection.

To display the Preferences dialog box, click  (Settings) or select Preferences... from the File menu.

[Page top](#)

Advanced Guide

Advanced Guide > Printing from a Computer > Printing with the Bundled Application Software > Appendix 1: Easy-PhotoPrint EX Settings > Printing an Index

Printing an Index

You can print an index of selected photos. An index print shows the thumbnails of the photos in one page. It is convenient for managing your photos.

To print an index, select Index from the layouts in the Layout/Print screen.

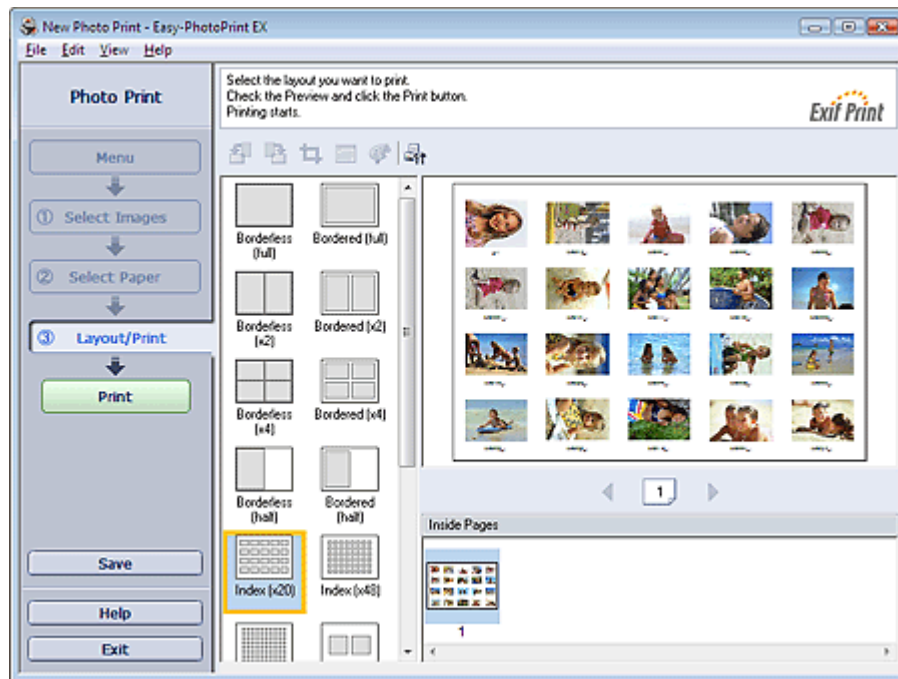

Note

- See the following section for details on how to select photos.
➔ [Selecting a Photo](#)
- Index print will be disabled if you select any of the following paper sizes.
 - Credit Card
 - Fine Art A4
 - Fine Art A3
 - Fine Art A3+
 - Fine Art Letter
- Up to 80 thumbnails can be printed on one page.
- Photos are arranged in the following order.
Example: Index (x20)

1	2	3	4	5
6	7	8	9	10
11	12	13	14	15
16	17	18	19	20

- You can change the printing order in Printing Order on the Print tab of the Preferences dialog box. You can select the printing order from By Date, By Name, and By Selection.

To display the Preferences dialog box, click  (Settings) or select Preferences... from the File menu.

Advanced Guide

Advanced Guide > Printing from a Computer > Printing with the Bundled Application Software > Appendix 1: Easy-PhotoPrint EX Settings > Printing ID Photos (ID Photo Print)

Printing ID Photos (ID Photo Print)

You can print a variety of ID photos.

Important

- The photo may not qualify as an official ID photo depending on its use. For details, contact the party to whom you will be submitting the photo.

To print ID photos, select 4"x6" 10x15cm for Paper Size in the Select Paper screen, and select a layout of the ID photo from the layouts in the Layout/Print screen.

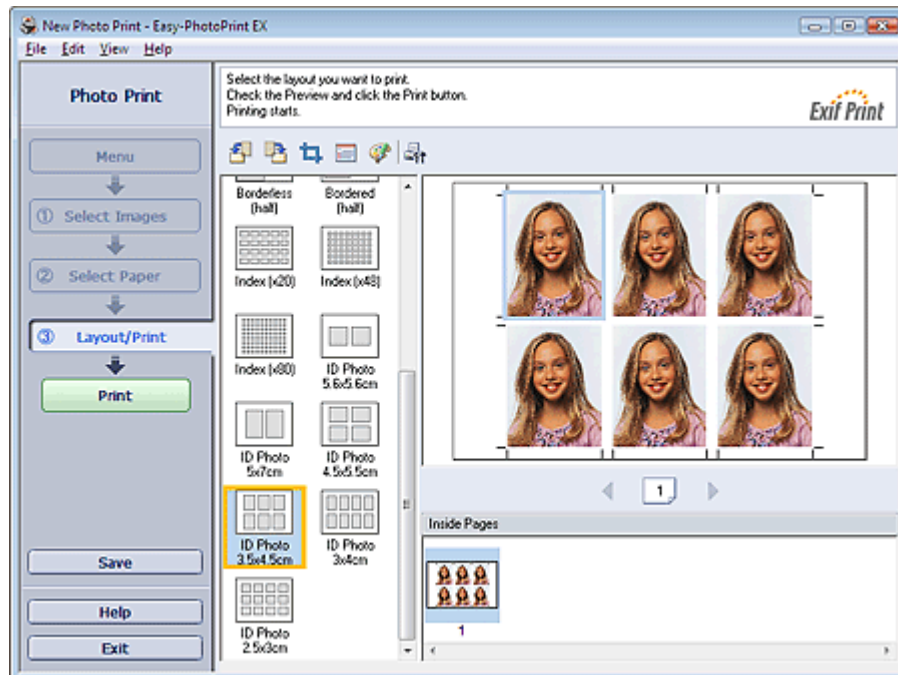

Note

- See the following section for details on how to select photos.
 - ➔ [Selecting a Photo](#)
- Photos are arranged in the following order.
Example: ID Photo 3.5x4.5cm



- You can change the printing order in Printing Order on the Print tab of the Preferences dialog box. You can select the printing order from By Date, By Name, and By Selection.

To display the Preferences dialog box, click  (Settings) or select Preferences... from the File menu.

[Page top](#)↑

Advanced Guide

Advanced Guide > Printing from a Computer > Printing with the Bundled Application Software > Appendix 1: Easy-PhotoPrint EX Settings > Printing Photo Information

Printing Photo Information

Select Captured Info from the layouts in the Layout/Print screen to print the photo and the Exif information side by side.

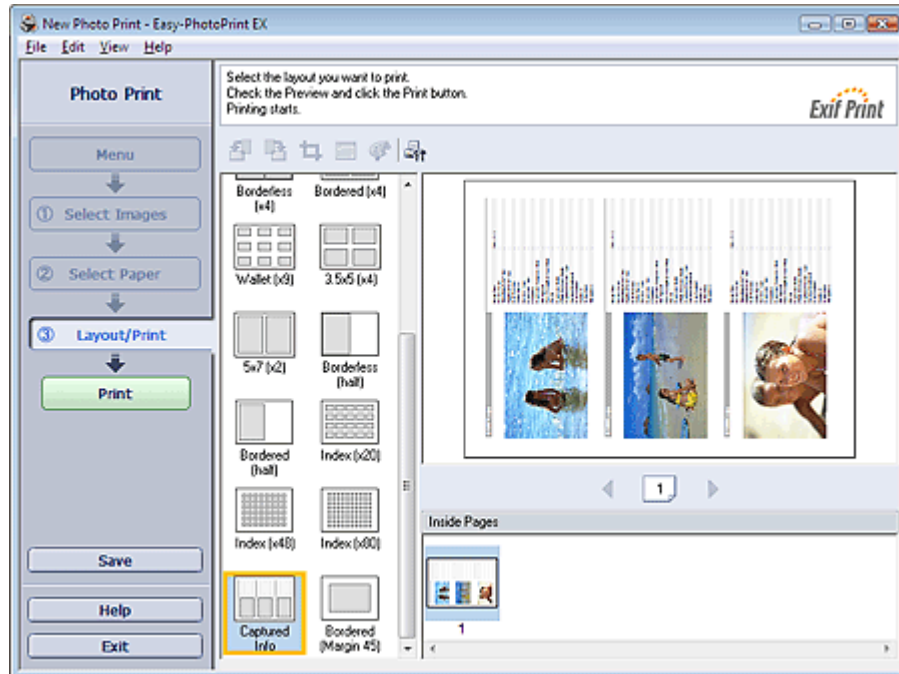

Note

- See the following section for details on how to select photos.
 - ➔ [Selecting a Photo](#)
- This function is available only on paper sizes Letter 8.5"x11" and A4.

[Page top](#)↑

Advanced Guide

Advanced Guide > Printing from a Computer > Printing with the Bundled Application Software > Appendix 1: Easy-PhotoPrint EX Settings > Saving Photos

Saving Photos

You can save edited photos. The information of cropping and layout can be saved.

Click Save in the Layout/Print screen.

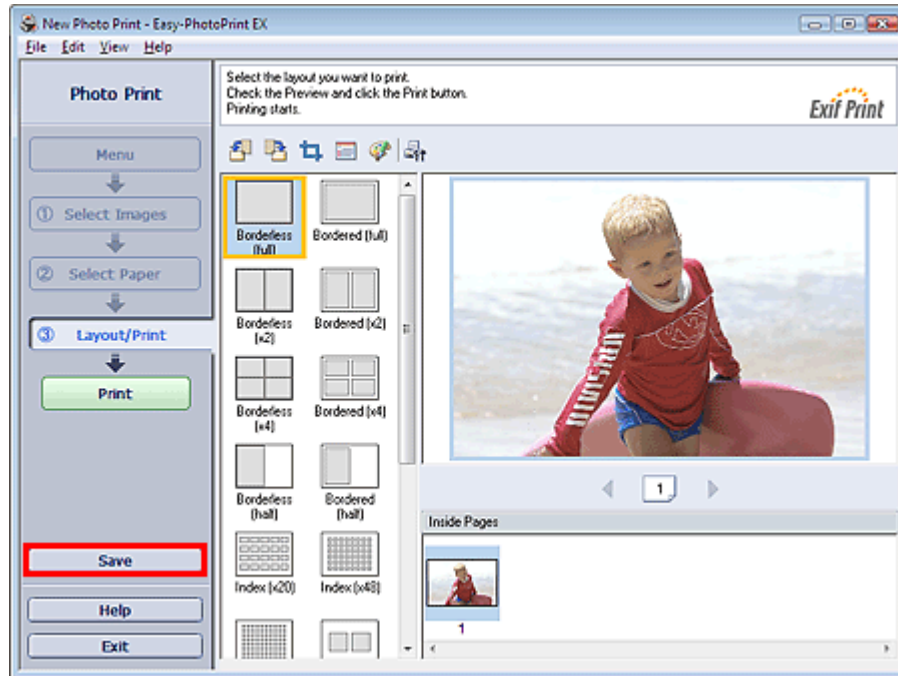

When the Save As dialog box appears, specify the save location and file name, then click Save.

Important

- If you edit a saved file and save it again, the file will be overwritten.
To save a file again with a new name or to a different location, select Save As... from the File menu and save.

Note

- Save will not be displayed in the Select Images or Select Paper screen.

[Page top](#)↑

Advanced Guide

Advanced Guide > Printing from a Computer > Printing with the Bundled Application Software > Appendix 1: Easy-PhotoPrint EX Settings > Opening Saved Files

Opening Saved Files

You can open files created with Easy-PhotoPrint EX.

1. Click Library from Menu.

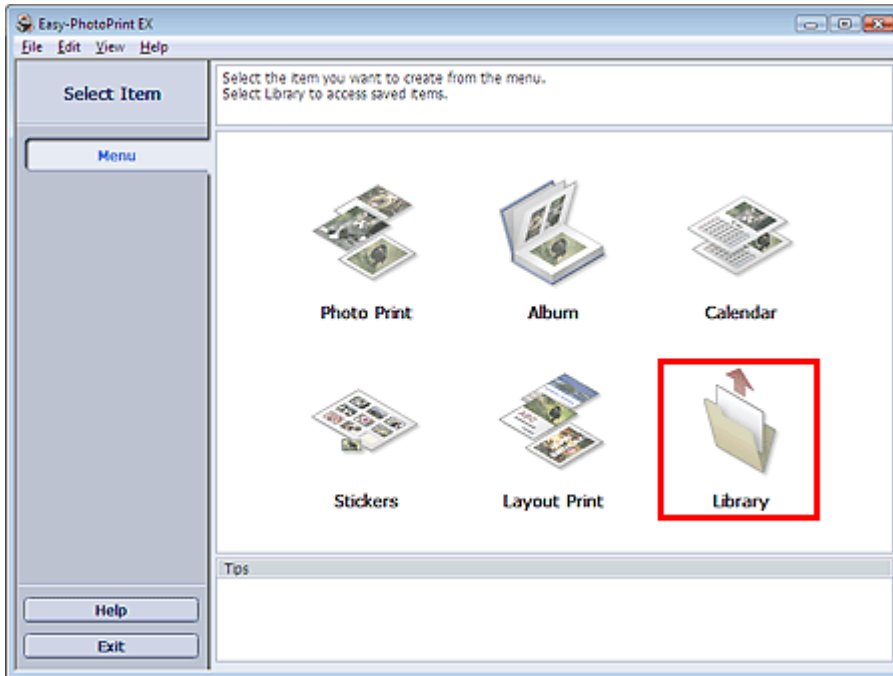

The Open dialog box appears.

You can check files created and saved with Easy-PhotoPrint EX by icon view (only for Windows Vista) or thumbnail view.

Important

- When using 64bit Edition of Windows Vista or Windows XP, the contents of files cannot be displayed on Explorer.

2. Select the file you want to open and click Open.

The Edit or Select Paper screen appears.

Note

- Easy-PhotoPrint EX supports the following file formats (extensions).
 - Easy-PhotoPrint EX Photo Print file (.el6)
 - Easy-PhotoPrint EX Album file (.el1)
 - Easy-PhotoPrint EX Stickers file (.el2)
 - Easy-PhotoPrint EX Calendar file (.el4)
 - Easy-PhotoPrint EX Layout file (.el5)

3. Edit the file if necessary.

Note

- See the following sections for details on the editing procedures.
 - ➔ [Editing Album](#)
 - ➔ [Editing Calendar](#)
 - ➔ [Editing Stickers](#)
 - ➔ [Editing Layout Print](#)

Note

- You can open files created with Easy-PhotoPrint EX with the following methods, besides from

Library in Menu.

- Double-click or click the file.
 - From the File menu, click Open..., then select the file you want to edit.
 - You can also open a recently used file by clicking the file name shown in the File menu.
-

[Page top](#)↑

Advanced Guide

Advanced Guide > Printing from a Computer > Printing with the Bundled Application Software > Appendix 1: Easy-PhotoPrint EX Settings > Changing Layout

Changing Layout

You can change the layout of each page separately.

Select the page you want to change the layout of in the Edit screen, then click  (Change Layout).
Select the layout you want to use in the Change Layout dialog box and click OK.

Album

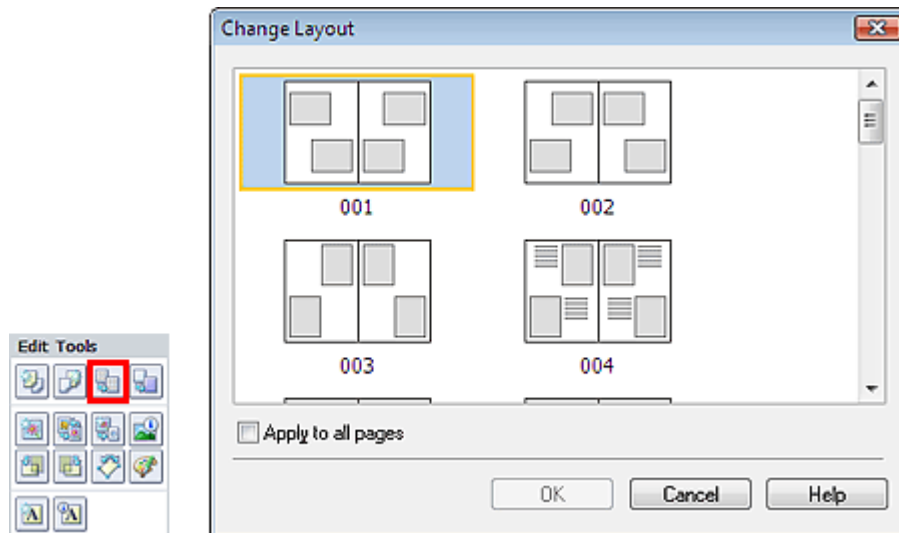

Important

- The album layouts that can be selected may vary depending on the Paper Size, Orientation, or the type of page selected (front cover, inside pages or back cover).
- If the new layout has a different number of frames per page from the current layout, the following will happen:

If the number of layout frames is increased	: Images will move from the subsequent pages to fill all the frames in the new layout.
If the number of layout frames is decreased	: Pages with the new layout will be added until all the images on the pages with the current layout can be fitted.
- If you change the selected layout for the front or back cover to one that has fewer layout frames, any image that does not fit in the new layout will be deleted, starting with the last image that was added to the former layout page.

Note

- Select the Apply to all pages checkbox to change the layouts of all pages to the one you newly selected.

Calendar

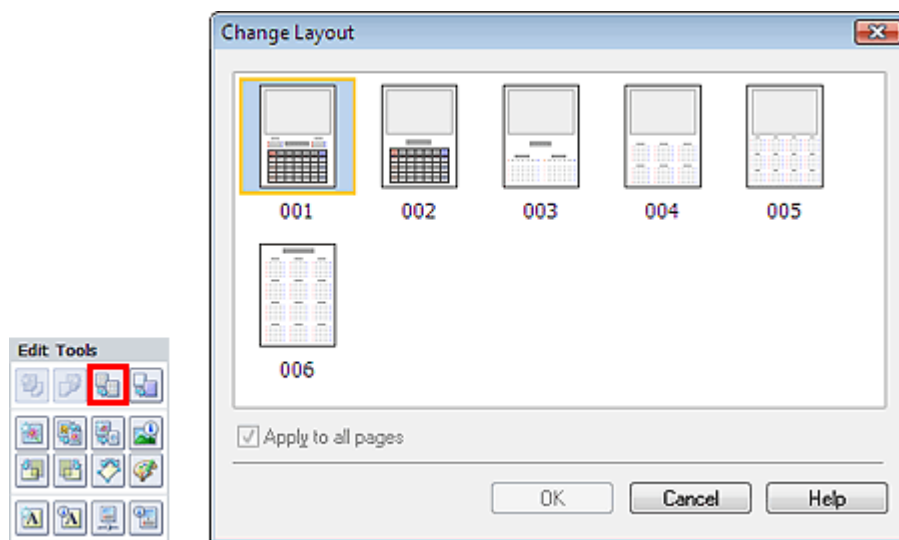

Important

- The layouts that can be selected may vary depending on the Paper Size and Orientation.
- The layouts of all pages are changed to the selected layout.
- All images that do not fit in the new layout will be collected on one page.

Layout Print

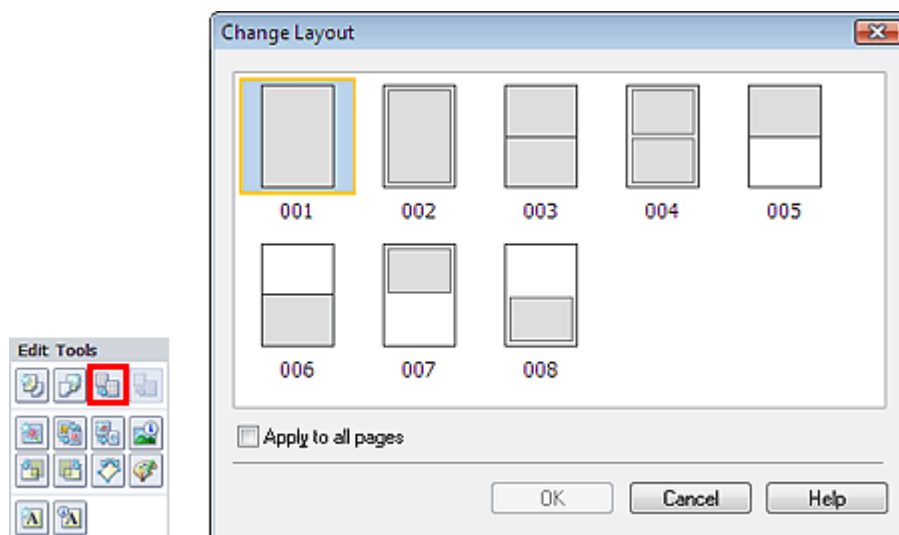

Important

- The layouts that can be selected may vary depending on the Paper Size and Orientation.
- If the new layout has a different number of frames per page from the current layout, the following will happen:

If the number of layout frames is increased	: Images will move from the subsequent pages to fill all the frames in the new layout.
If the number of layout frames is decreased	: Pages with the new layout will be added until all the images on the pages with the current layout can be fitted.

Note

- Select the Apply to all pages checkbox to change the layouts of all pages to the one you newly selected.

[Page top↑](#)

Advanced Guide

Advanced Guide > Printing from a Computer > Printing with the Bundled Application Software > Appendix 1: Easy-PhotoPrint EX Settings > Changing Background

Changing Background

You can change the background of each page.

Important

- You cannot change the background of the Photo Print, Stickers, and Layout Print.

Select the page you want to change the background of in the Edit screen, then click  (Change Background).

Note

- The screens for Album printing are used as examples in the following descriptions. The screens may vary depending on what you create.

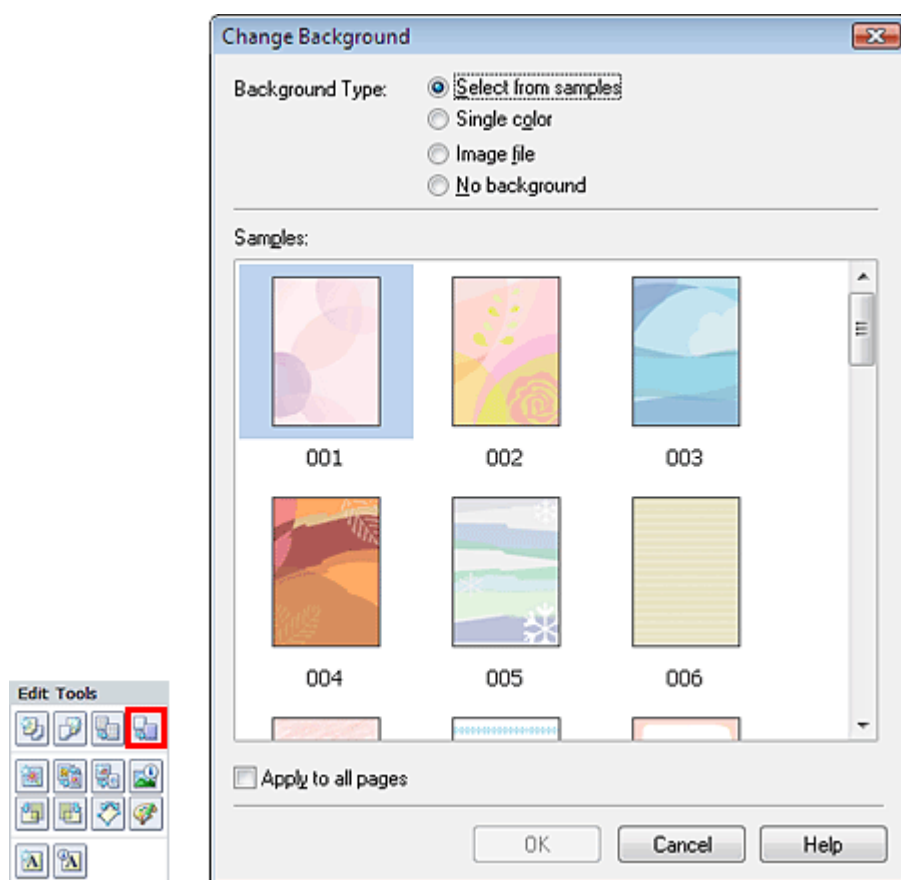

Select the type of background you want to use in the Change Background dialog box.

When Select from samples is Selected

Select the image you want to use from Samples and click OK.

Note

- Select from samples will be displayed only if Album has been selected.

When Single color is Selected

Select the color you want to use from Standard color or Custom color and click OK.

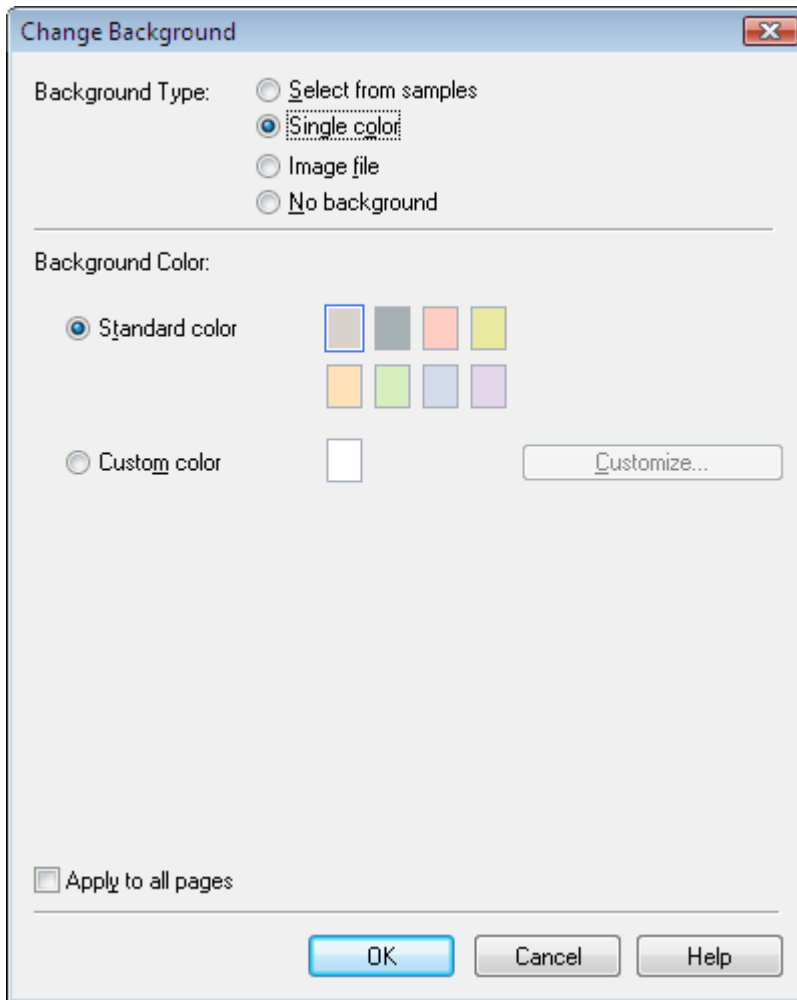

When Image file is Selected

Set Image File Path and Image Layout, then click OK.

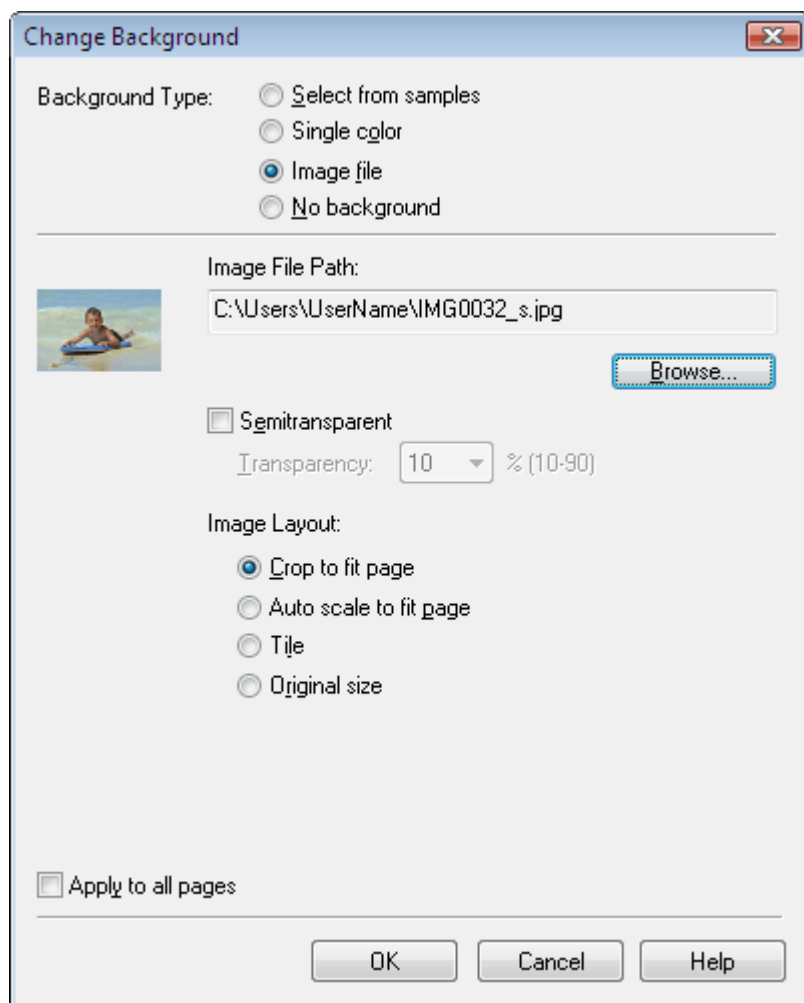
**Note**

- See Help for details on how to set the background in the Change Background dialog box.

[Page top↑](#)

Advanced Guide

Advanced Guide > Printing from a Computer > Printing with the Bundled Application Software > Appendix 1: Easy-PhotoPrint EX Settings > Adding Photos

Adding Photos

You can add images to pages.

Select the page you want to add photos in the Edit screen, then click  (Add Image).

Note

- The screens for Album printing are used as examples in the following descriptions. The screens may vary depending on what you create.

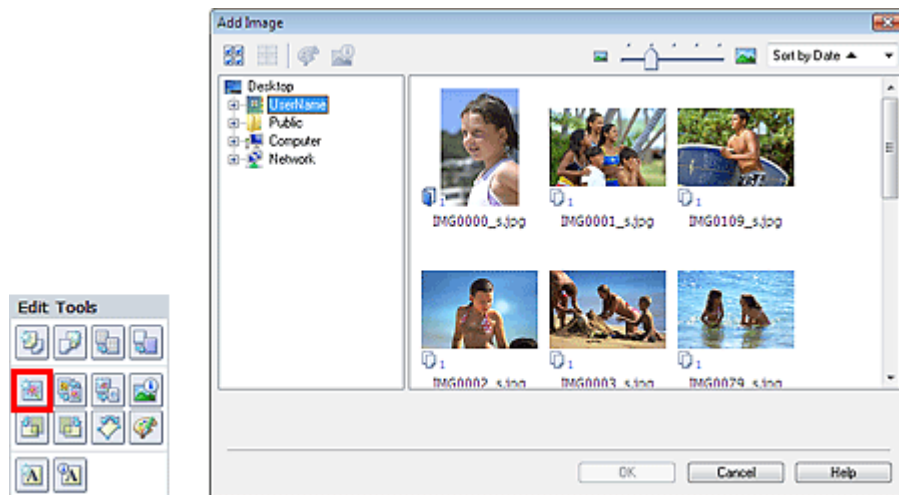

Select the folder containing the image you want to add from the folder tree area on the left of the Add Image dialog box, and select the image you want to add from the thumbnail window on the right.

Note

- Click an image to select it (background turns blue) or deselect it (background turns white). You can also select multiple images.

Select an option for Add to and click OK.

Important

- You can add up to 20 images at one time to a single page.
- Up to 99 of the same images can be added to all pages combined.
- You cannot add two or more of the same image at one time. In that case, add it one at a time.
- If you increase the number of pages to add images, you cannot add images beyond page 400.

Note

- In the Add Image dialog box, you can select all images at one time or change the display size and order of the thumbnails. See Help for details.

[Page top](#)

Advanced Guide

Advanced Guide > Printing from a Computer > Printing with the Bundled Application Software > Appendix 1: Easy-PhotoPrint EX Settings > Swapping Positions of Photos

Swapping Positions of Photos

You can swap the positions of images.

Click  (Swap Image Positions) in the Edit screen.

Note

- The screens for Album printing are used as examples in the following descriptions. The screens may vary depending on what you create.



Select the target and source images you want to swap, then click Swap.
When you finish swapping all images you want to swap, click Back to Edit.

[Page top](#)↑

Advanced Guide

Advanced Guide > Printing from a Computer > Printing with the Bundled Application Software > Appendix 1: Easy-PhotoPrint EX Settings > Replacing Photos

Replacing Photos

You can replace an image with another image.

Select the image you want to replace in the Edit screen, then click  (Replace Selected Image).

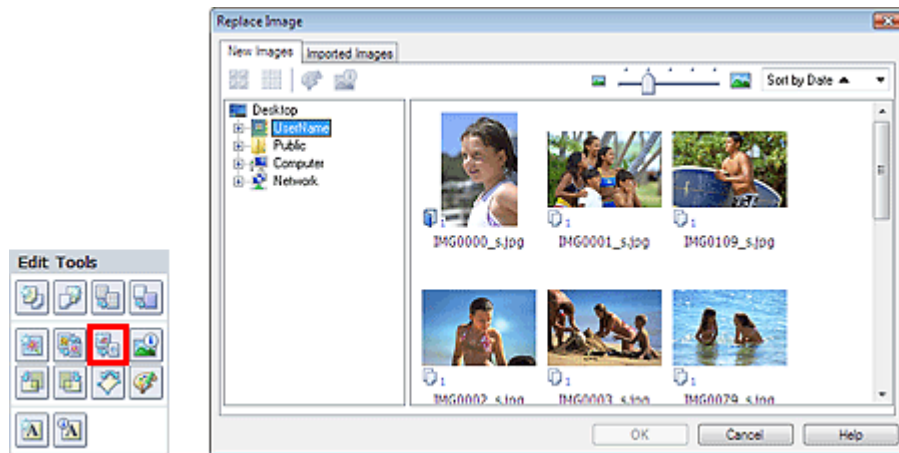

Select the folder containing the image you want to replace with from the folder tree area on the left of the Replace Image dialog box.

Select the image you want to replace with from the thumbnail window on the right of the screen and click OK.

If you want to select from the images already imported, click the Imported Images tab and select the image you want to replace with from the thumbnail window and click OK.

Important

- You cannot select multiple images in the Replace Image dialog box.

Note

- If you select multiple images in the Edit screen and use the replacement function, all the images selected in the Edit screen will be replaced with the image selected in the Replace Image dialog box.
- When images are replaced, the following settings of the old image are inherited to the new image.
 - Position
 - Size
 - Frame
 - Position and size of the date
 The cropping information and image orientation are not inherited.
- In the Replace Image dialog box, you can change the display size and order of the thumbnails. See Help for details.

[Page top](#)

Advanced Guide

Advanced Guide > Printing from a Computer > Printing with the Bundled Application Software > Appendix 1: Easy-PhotoPrint EX Settings > Changing Position, Angle and Size of Photos

Changing Position, Angle and Size of Photos

You can adjust the position, angle and size of images.

Select the image of which you want to change the position or size in the Edit screen and click  (Edit Image) or double-click the image.

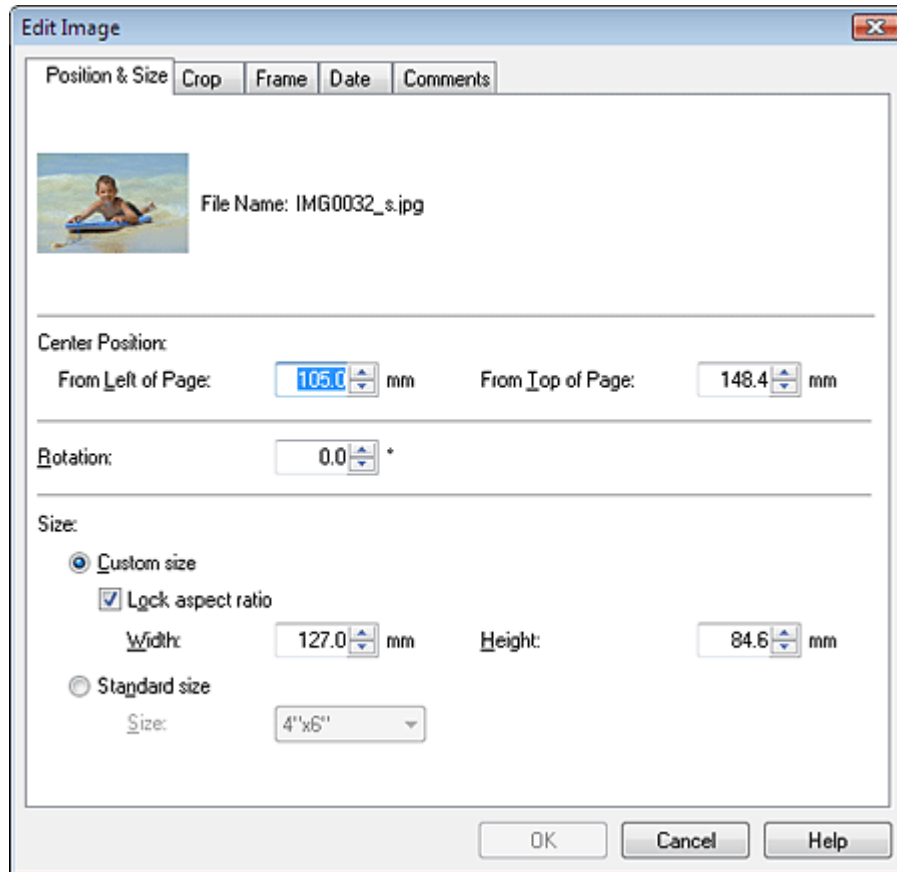

Set the Center Position, Rotation and Size, then click OK.

Note

- You can also change the position and size of an image by dragging it in the Edit screen.
- Select an image in the Edit screen, then click  (Free Rotate) and drag a corner of the image to rotate it.
- See Help for details on the position and size of images.

[Page top](#) ↑

Advanced Guide

Advanced Guide > Printing from a Computer > Printing with the Bundled Application Software > Appendix 1: Easy-PhotoPrint EX Settings > Cropping Photos

Cropping Photos

Cropping an image is the act of removing the unnecessary portions of the image by selecting the necessary portions.

Select the image you want to crop in the Edit screen and click  (Edit Image) or double-click the image.

Click the Crop tab in the Edit Image dialog box.

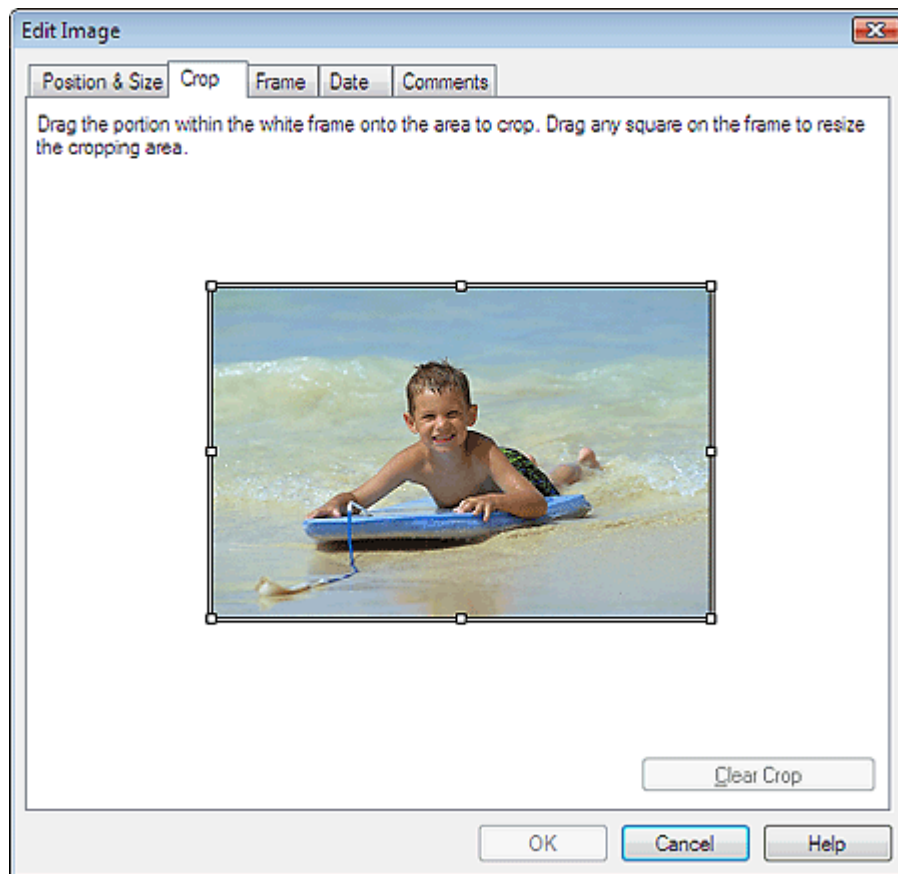

Drag the white squares on the image to change the area to be cropped and click OK.

Note

- See Help for details on cropping.

[Page top](#)↑

Advanced Guide

Advanced Guide > Printing from a Computer > Printing with the Bundled Application Software > Appendix 1: Easy-PhotoPrint EX Settings > Framing Photos

Framing Photos

You can add frames to images.

Important

- You cannot add frames to images in Photo Print, Stickers, and Layout Print.

Select the image you want to frame in the Edit screen and click  (Edit Image) or double-click the image.

Click the Frame tab in the Edit Image dialog box.

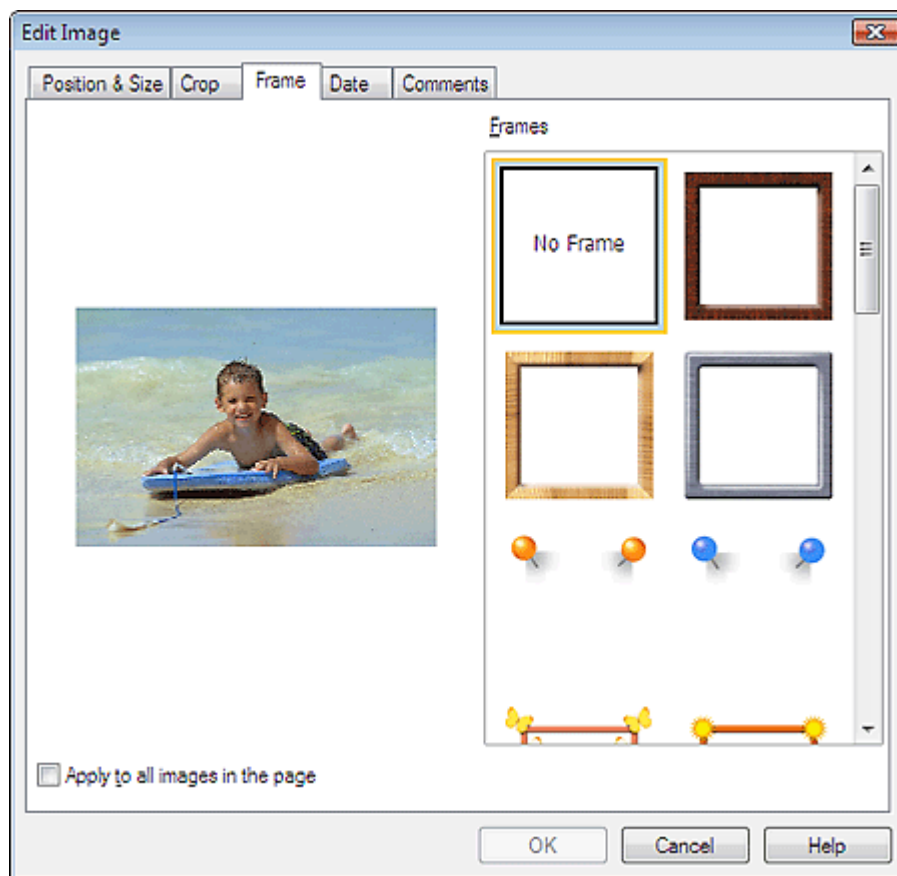

Select the frame you want to use from Frames and click OK.

Important

- You cannot print dates on framed photos.

Note

- Select the Apply to all images in the page checkbox to add the same frame to all the images on a selected page at one time.
- See Help for details on frames.

[Page top](#) 

Advanced Guide

Advanced Guide > Printing from a Computer > Printing with the Bundled Application Software > Appendix 1: Easy-PhotoPrint EX Settings > Printing Dates on Photos

Printing Dates on Photos

You can print dates on images.

Select the image you want to print the date in the Edit screen and click  (Edit Image) or double-click the image.

Click the Date tab in the Edit Image dialog box.

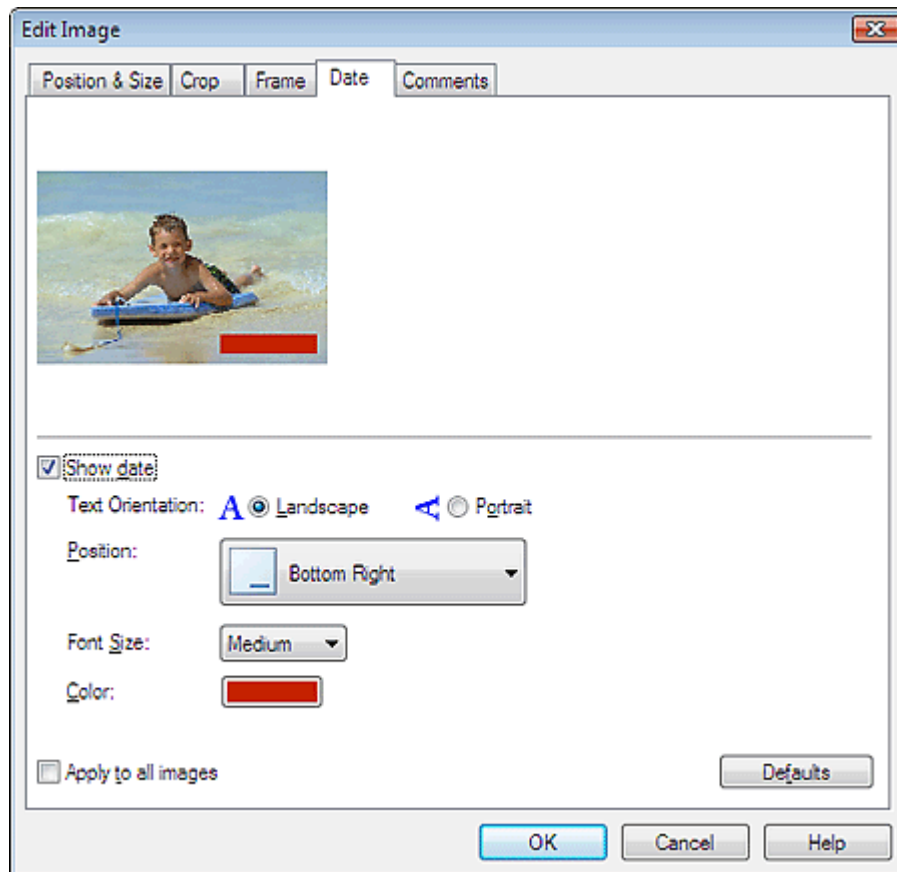

Select the Show date checkbox.

Set the Text Orientation, Position, Font Size and Color, then click OK.

Important

- You cannot print dates on framed images.

Note

- The date is displayed in the short date format (mm/dd/yyyy, etc.) specified in your operating system.
- See Help for details on setting dates.

[Page top](#) 

Advanced Guide

Advanced Guide > Printing from a Computer > Printing with the Bundled Application Software > Appendix 1: Easy-PhotoPrint EX Settings > Attaching Comments to Photos

Attaching Comments to Photos

You can attach comments to images and display them in your album. The photo name, shooting date and comments are displayed (from top to bottom) in a comment box.



Important

- You cannot attach comments to Photo Print, Calendar, Stickers, and Layout Print.

Select the image you want to attach comments to in the Edit screen and click  (Edit Image) or double-click the image.

Click the Comments tab in the Edit Image dialog box.

Select the Show comment box checkbox.

Select the checkboxes of the items you want to display, and enter comments.

Set the size and color of font, and position, etc. of the comments, then click OK.

Note

- See Help for details on comments.

[Page top](#)↑

Advanced Guide

Advanced Guide > Printing from a Computer > Printing with the Bundled Application Software > Appendix 1: Easy-PhotoPrint EX Settings > Adding Text to Photos

Adding Text to Photos

You can add text to photos.

Click  (Add Text) in the Edit screen and drag the mouse over the area in which you want to add text.

Note

- The screens for Album printing are used as examples in the following descriptions. The screens may vary depending on what you create.

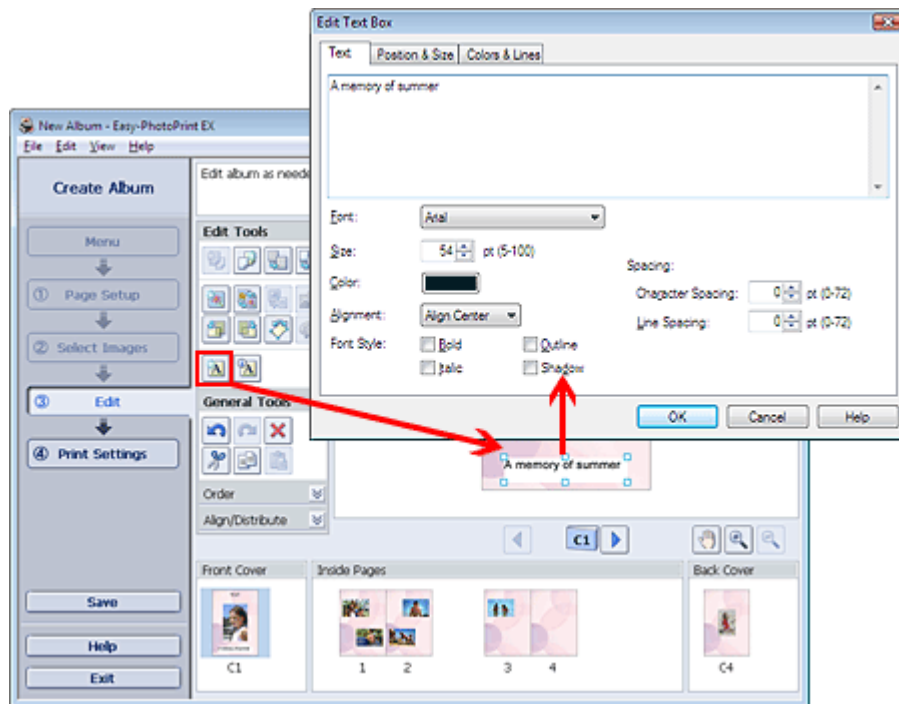

Select the Text tab in the Edit Text Box dialog box and enter text.

Note

- In the Edit Text Box dialog box, you can change the position, angle and size of the text. You can also set the color and line of the text box. See Help for details.
- To change the entered text, select it and click  (Edit Text Box). The Edit Text Box dialog box appears. You can change the text.

[Page top](#)↑

Advanced Guide

Advanced Guide > Printing from a Computer > Printing with the Bundled Application Software > Appendix 1: Easy-PhotoPrint EX Settings > Saving

Saving

You can save edited items.

Click Save in the Edit or Print Settings screen.

Note

- The screens for Album printing are used as examples in the following descriptions. The screens may vary depending on what you create.

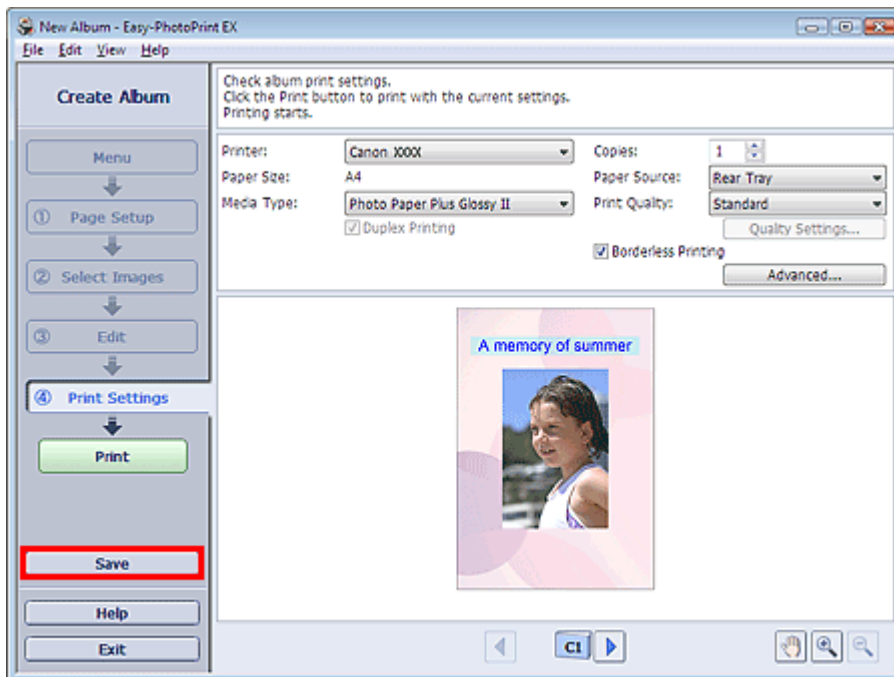

When the Save As dialog box appears, specify the save location and file name, then click Save.

Important

- If you edit a saved file and save it again, the file will be overwritten.
To save a file again with a new name or to a different location, select Save As... from the File menu and save.

Note

- Save will not be displayed in the Page Setup or Select Images screen.

[Page top](#)

Advanced Guide

Advanced Guide > Printing from a Computer > Printing with the Bundled Application Software > Appendix 1: Easy-PhotoPrint EX Settings > Setting Holidays

Setting Holidays

You can add holidays to your calendar.

Click Set Holidays... in the Page Setup screen of Calendar, or click  (Setup Period/Holiday) in the Edit screen and click Set Holidays... in the Calendar General Settings dialog box to display the Holiday Settings dialog box.

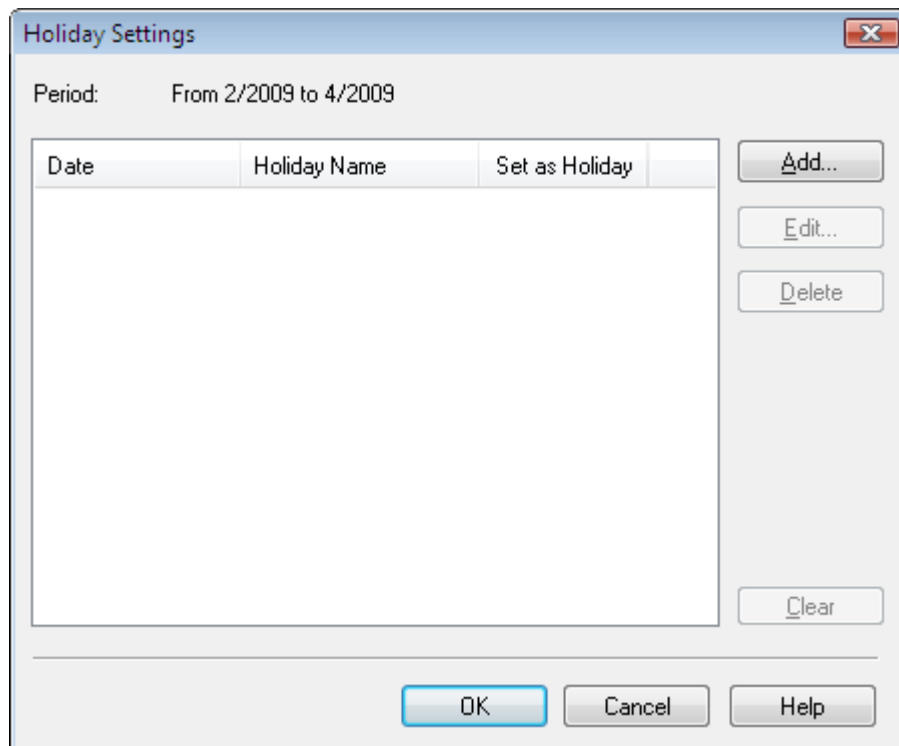

To add a holiday, click Add.... The Add/Edit Holiday dialog box appears. To edit a saved holiday, select it and click Edit....

To delete a holiday, select it and click Delete. To delete all the saved holidays within your calendar period, click Clear.

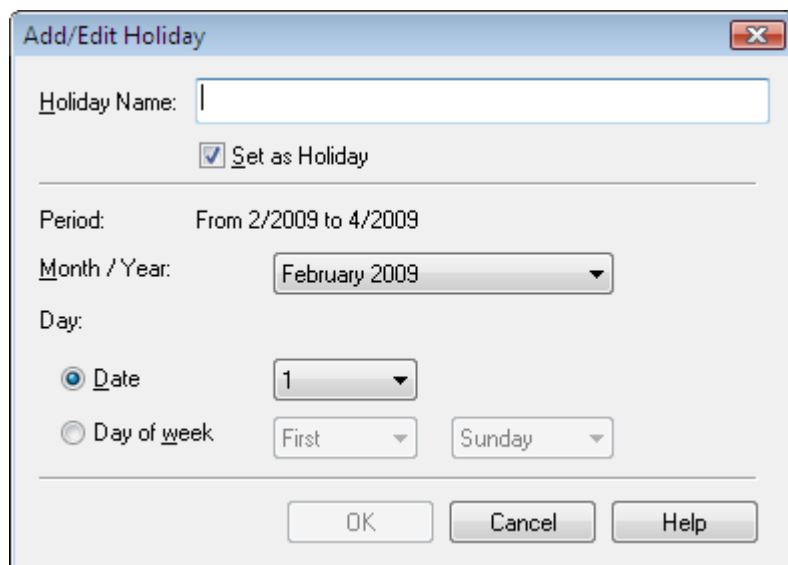

Enter the name in Holiday Name and specify the date.

Select the Set as Holiday checkbox to display that day as a holiday in your calendar.

Note

- See Help for details on each dialog box.
-

[Page top↑](#)

Advanced Guide

Advanced Guide > Printing from a Computer > Printing with the Bundled Application Software > Appendix 1: Easy-PhotoPrint EX Settings > Setting Calendar Display

Setting Calendar Display

You can customize the calendar display (fonts, lines, colors, position, size, etc.).

Click Settings... in the Page Setup screen of Calendar, or select a calendar in the Edit screen and click



(Setup Calendar) to display the Calendar Settings dialog box.

Important

- The Position & Size tab is displayed only when the Calendar Settings dialog box is displayed from the Edit screen.

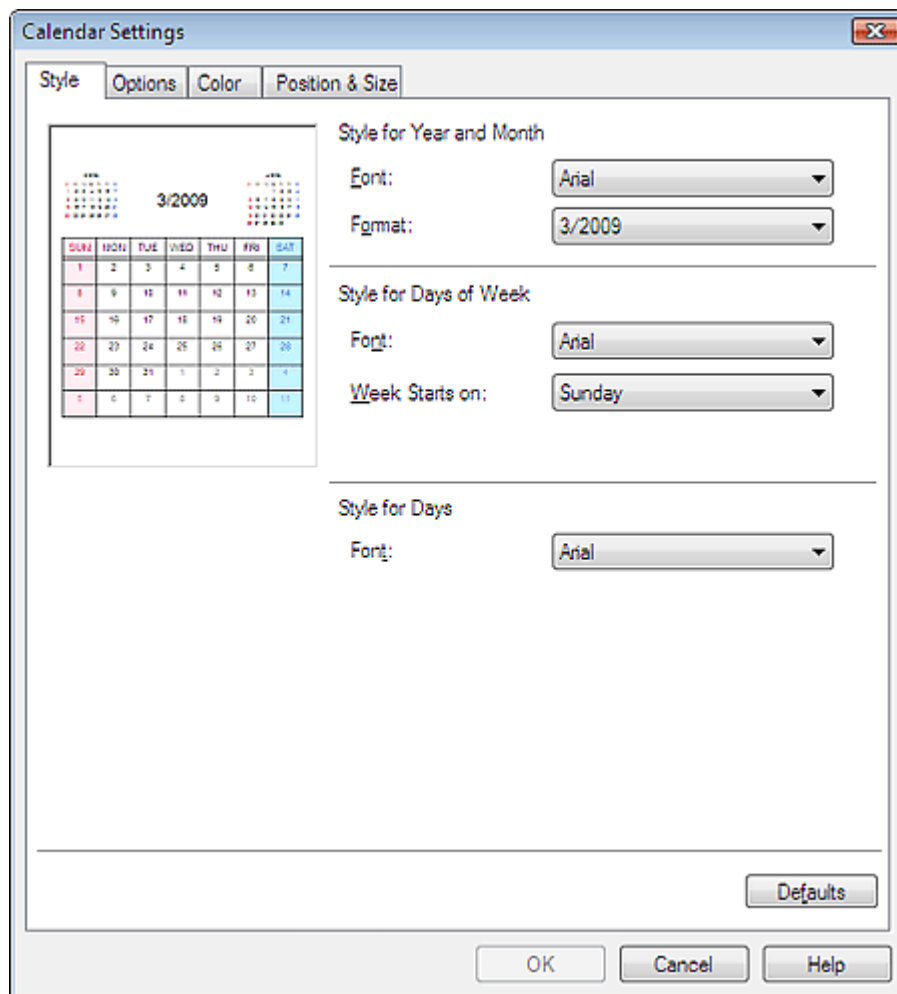

Note

- See Help for details on the Calendar Settings dialog box.

[Page top](#)

Advanced Guide

[Advanced Guide](#) > [Printing from a Computer](#) > [Printing with Other Application Software](#)

Printing with Other Application Software

- ➔ [Various Printing Methods](#)
- ➔ [Changing the Print Quality and Correcting Image Data](#)
- ➔ [Overview of the Printer Driver](#)

[Page top](#) ↕

Advanced Guide

[Advanced Guide](#) > [Printing from a Computer](#) > [Printing with Other Application Software](#) > [Various Printing Methods](#)

Various Printing Methods

- ➔ [Printing with Easy Setup](#)
- ➔ [Setting a Page Size and Orientation](#)
- ➔ [Setting the Number of Copies and Printing Order](#)
- ➔ [Setting the Stapling Margin](#)
- ➔ [Borderless Printing](#)
- ➔ [Fit-to-Page Printing](#)
- ➔ [Scaled Printing](#)
- ➔ [Page Layout Printing](#)
- ➔ [Poster Printing](#)
- ➔ [Booklet Printing](#)
- ➔ [Duplex Printing](#)
- ➔ [Stamp/Background Printing](#)
- ➔ [Saving a Stamp Setting](#)
- ➔ [Saving Image Data to be Used as a Background](#)
- ➔ [Printing an Envelope](#)
- ➔ [Displaying the Print Results before Printing](#)
- ➔ [Setting Paper Dimensions \(Custom Size\)](#)

[Page top](#) ↕

Advanced Guide

Advanced Guide > Printing from a Computer > Printing with Other Application Software > Various Printing Methods > Printing with Easy Setup

Printing with Easy Setup

The procedure for setting the basic print setup, which is necessary to print data properly with this machine, is as follows:

1. Open the [printer driver setup window](#)
2. Select the media type

Select the type of paper loaded in the machine from the Media Type list on the Main tab.

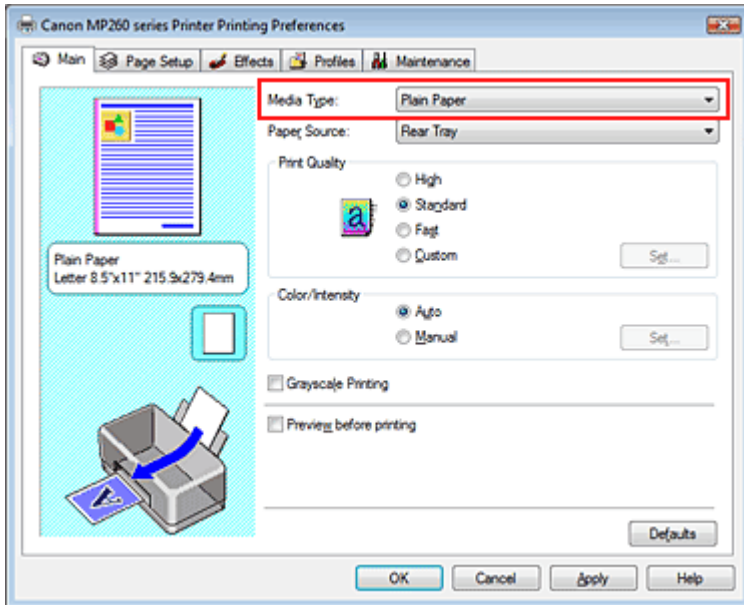

3. Select the print quality

Select High, Standard, or Fast for Print Quality.

4. Select color/intensity

Select Auto for Color/Intensity.

5. Check the settings

Check the specified settings such as paper type displayed in the Settings Preview on the left side of the window.

6. Complete the setup

Click OK.

When you execute print, the document will be printed in accordance with the type of media.

[Page top](#) ↑

Advanced Guide

Advanced Guide > Printing from a Computer > Printing with Other Application Software > Various Printing Methods > Setting a Page Size and Orientation

Setting a Page Size and Orientation

The paper size and orientation are essentially determined by the application. If the page size and orientation set for Page Size and Orientation on the Page Setup tab are same as those set with the application, you do not need to select them on the Page Setup tab.

If you are not able to specify them with the application, the procedure for selecting a page size and orientation is as follows:

1. Open the [printer driver setup window](#)
2. Select the paper size

Select a page size from the Page Size list on the Page Setup tab.

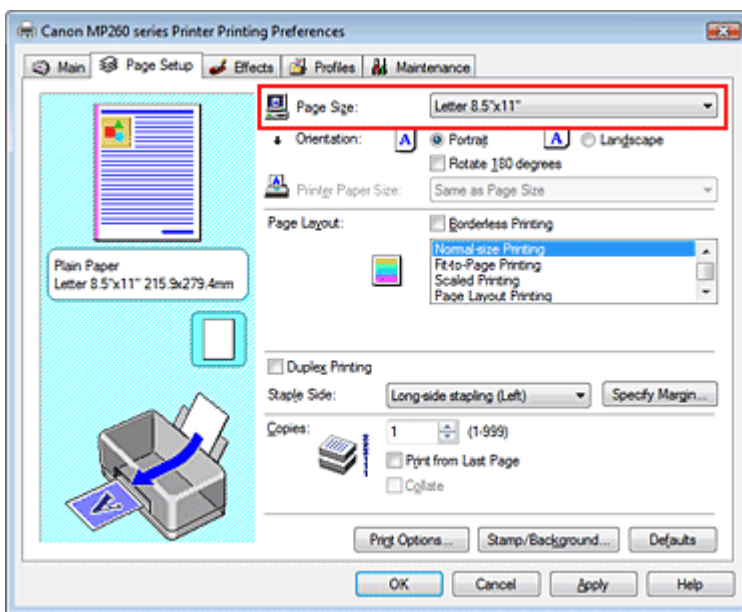

3. Select Orientation

Select Portrait or Landscape for Orientation. Check Rotate 180 degrees check box if you want to perform printing with the original being rotated 180 degrees.

4. Complete the setup

Click OK.

The document will be printed with the selected page size and the orientation.

[Page top](#) ↑

Advanced Guide

Advanced Guide > Printing from a Computer > Printing with Other Application Software > Various Printing Methods > Setting the Number of Copies and Printing Order

Setting the Number of Copies and Printing Order

Default Setting



Print from Last Page

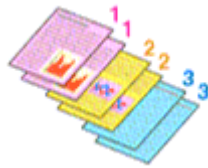

Collate

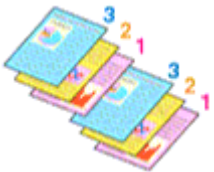

Print from Last Page + Collate

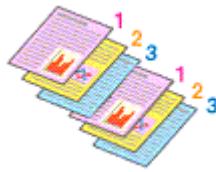

The procedure for specifying the number of copies and printing order is as follows:

1. Open the **printer driver setup window**
2. Specify the number of copies to be printed

For Copies on the Page Setup tab, specify the number of copies to be printed.

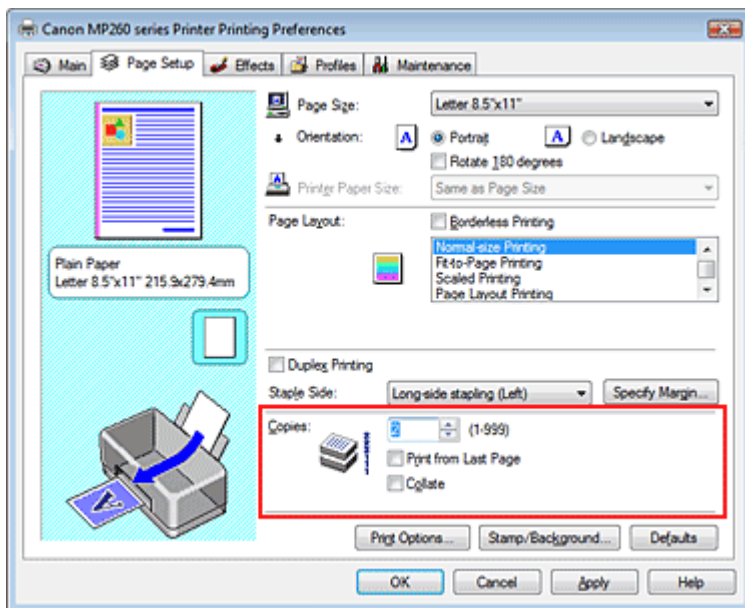

3. Specify the print sequence

Check the Print from Last Page check box if you want to print from the last page in order. If you do this, you do not need to sort pages into their correct order after printing.

4. Set up collated printing when you specify multiple copies in the Copies box

Check the Collate check box if you are specifying multiple copy together.
Uncheck this check box to print all pages with the same page number together.

5. Complete the setup

Click OK.

The specified number of copies will be printed with the specified printing order.



Important

- If your application has the same function, make the settings with the application. If you specify the number of copies and the printing order with both the application and this printer driver, the number of copies may be multiplied numbers of the two settings or the specified printing order may not be enabled.
- Print from Last Page and Collate appear grayed out and are unavailable if Booklet Printing is selected for Page Layout.
- Print from Last Page appears grayed out and is unavailable if Poster Printing is selected for Page Layout.

 **Note**

- By setting both Print from Last Page and Collate, you can perform printing so that papers are collated one by one starting from the last page.
These settings can be used in combination with Borderless Printing, Normal-size Printing, Fit-to-Page Printing, Scaled Printing, Page Layout Printing, and Duplex Printing.
-

[Page top](#) ↑

Advanced Guide

Advanced Guide > Printing from a Computer > Printing with Other Application Software > Various Printing Methods > Setting the Stapling Margin

Setting the Stapling Margin

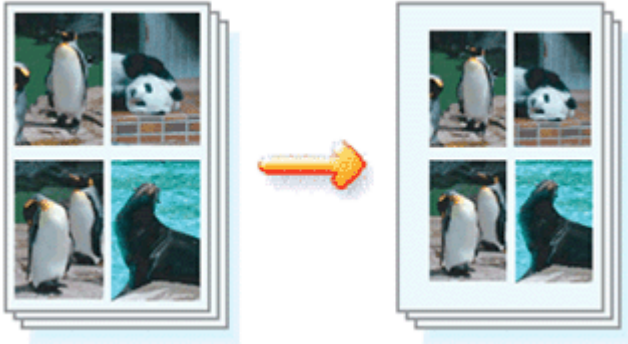

The procedure for setting the stapling direction and the width of the stapling margin is as follows:

1. Open the printer driver setup window
2. Specify the side to be stapled

Check the position of the stapling margin from Staple Side on the Page Setup tab.

The printer analyzes the Orientation and Page Layout settings, and automatically selects the best staple position. If you want to change the setting, select from the list.

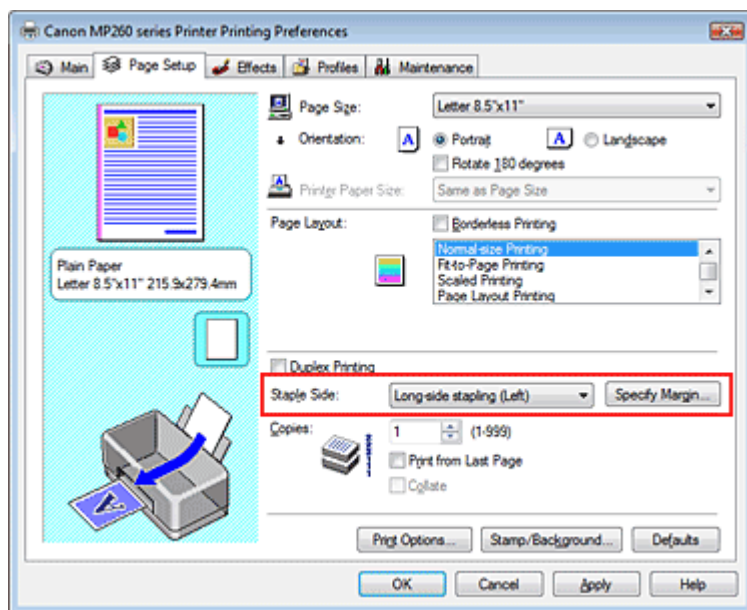

3. Set the margin width

If necessary, click Specify Margin... and set the width of the stapling margin, and then click OK.

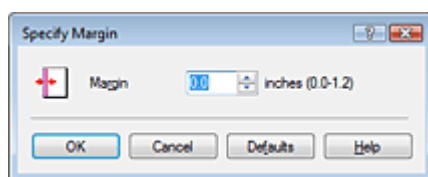

4. Complete the setup

Click OK on the Page Setup tab.

When you execute print, the data is printed with the specified staple side and margin.

Important

- Staple Side and Specify Margin... appear grayed out and are unavailable when:

- Poster Printing or Booklet Printing is selected for Page Layout.
- Scaled Printing is selected for Page Layout (If Duplex Printing is also selected, only Staple Side is selectable).
- Borderless Printing check box is checked (If Duplex Printing is also selected, only Staple Side is selectable).

[Page top](#) ↑

Advanced Guide

Advanced Guide > Printing from a Computer > Printing with Other Application Software > Various Printing Methods > Borderless Printing

Borderless Printing

The borderless printing function allows you to print data without any margin by enlarging the data so that it extends slightly off the paper. Without the borderless printing function, a margin is provided around the printed data. If you want to print data such as a photo without providing any margin around it, select Borderless Printing.

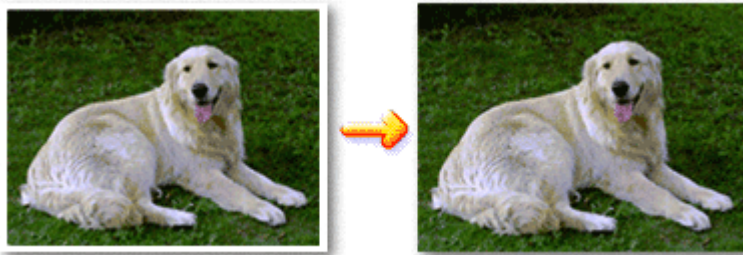

The procedure for performing borderless printing is as follows:

Setting Borderless Printing

1. Open the printer driver setup window

2. Set borderless printing

Check the Borderless Printing check box on the Page Setup tab.

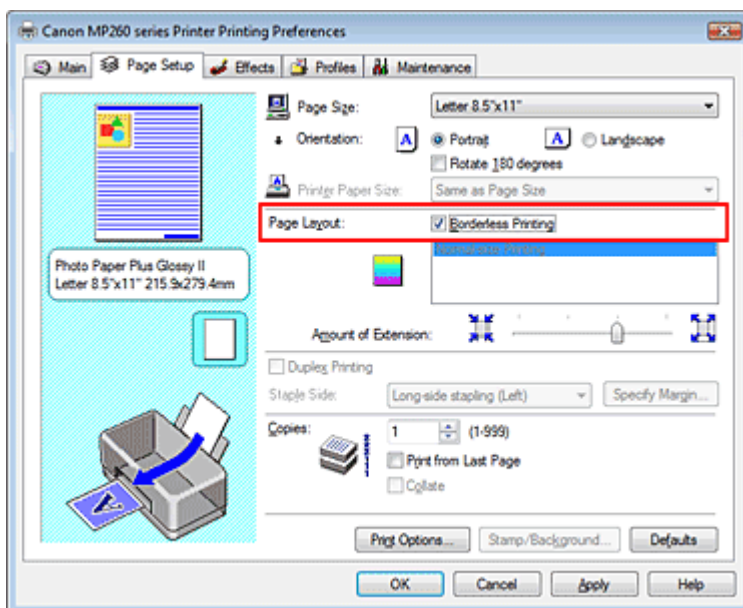

Click OK when the confirmation message appears.

When a message prompting you to change the media type appears, select a media type from the list and click OK.

3. Check the paper size

Check the Page Size list. If you want to change, select another page size from the list. The list displays only sizes that can be used for borderless printing.

4. Adjust the amount of extension from the paper

Adjust the amount of extension using the Amount of Extension slider as necessary.

Moving the slider to the right makes the amount larger and moving the slider to the left makes the amount smaller.

It is recommended to set the slider at the second position from the right for most cases.



Important

- If you set the slider at the rightmost position, the back side of the paper may become smudged.

5. Complete the setup

Click OK.

The data will be printed without any margins on the paper.

Important

- If a page size that cannot be used for borderless printing is selected, the size is automatically changed to the valid page sizes for borderless printing.
- When High Resolution Paper, T-Shirt Transfers, or Envelope is selected from the Media Type list on the Main tab, you cannot perform borderless printing.
- When Borderless Printing is checked, the Printer Paper Size, Page Layout, Staple Side (when Duplex Printing is not selected) settings, and the Stamp/Background... button on the Page Setup tab appear grayed out and are unavailable.
- Print quality may deteriorate or the sheet may be stained at the top and bottom depending on the type of the media used.
- When the ratio of the height to the width differs greatly from the image data, a portion of the image may not be printed depending on the size of the media used.
In this case, crop the image data with an application software according to the paper size.

Note

- When Plain Paper is selected for Media Type on the Main tab, borderless printing is not recommended, and therefore the dialog box for media selection appears.
If you are using plain paper for test printing, select Plain Paper, and click OK.

Expanding the range of the document to print

Specifying a large amount of extension allows you to perform borderless printing with no problems. However, the portion of the document that extends off the paper range will not be printed. Subjects around the perimeter of a photo may not be printed.

Try borderless printing once. If you are not satisfied with the result of borderless printing, reduce the amount of extension. The extension amount becomes shorter as the Amount of Extension slider is moved to the left.

Important

- If the Amount of Extension is shortened, an unexpected margin may be produced on the print, depending on the size of the paper.

Note

- If Preview before printing is checked on the Main tab, you can confirm before printing whether there will be no border.

[Page top](#) ↑

Advanced Guide

Advanced Guide > Printing from a Computer > Printing with Other Application Software > Various Printing Methods > Fit-to-Page Printing

Fit-to-Page Printing



The procedure for printing document, which is enlarged or reduced to fit to the page size, is as follows:

1. Open the printer driver setup window
2. Set fit-to-page printing

Select Fit-to-Page Printing from the Page Layout list on the Page Setup tab.

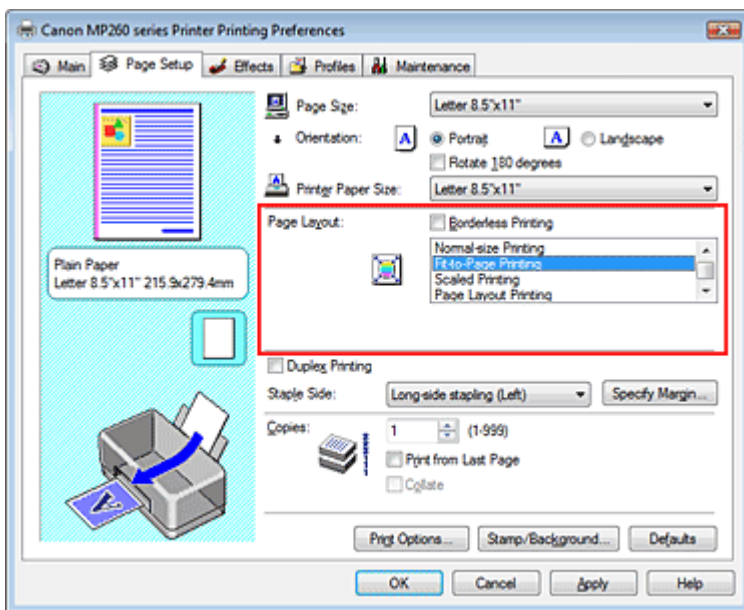

3. Select the paper size for the data

Using Page Size, select the page size that was set with your application.

4. Select the print paper size

Select the size of the paper loaded in the machine from the Printer Paper Size list.

If the printer paper size is smaller than the Page Size, the page image will be reduced. If the printer paper size is larger than the page size, the page image will be enlarged.

The current settings are displayed in the Settings Preview on the left side of the printer driver.

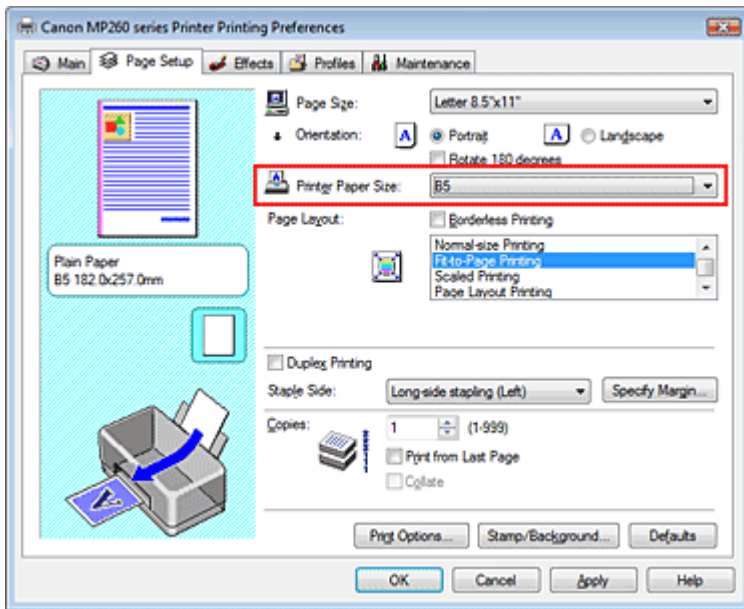

5. Complete the setup

Click OK.

When you execute print, the document will be enlarged or reduced to fit to the page size.

Important

- When Borderless Printing check box is checked, Fit-to-Page Printing cannot be selected.

[Page top](#) ↑

Advanced Guide

Advanced Guide > Printing from a Computer > Printing with Other Application Software > Various Printing Methods > Scaled Printing

Scaled Printing



The procedure for printing a document with pages enlarged or reduced is as follows:

1. Open the printer driver setup window
2. Set scaled printing

Select Scaled Printing from the Page Layout list on the Page Setup tab.

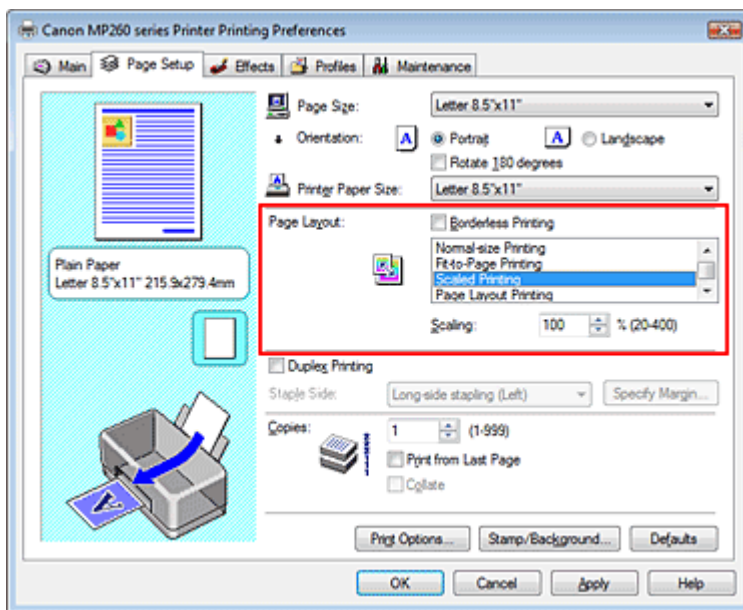

3. Select the paper size for the data
Using Page Size, select the page size that was set with your application.
4. Set the scaling rate by using one of the following methods:
 - **Select a Printer Paper Size**

Select a printer paper size, which is different from the Page Size, from the Printer Paper Size list. If the printer paper size is smaller than the Page Size, the page image will be reduced. If the printer paper size is larger than the page size, the page image will be enlarged.

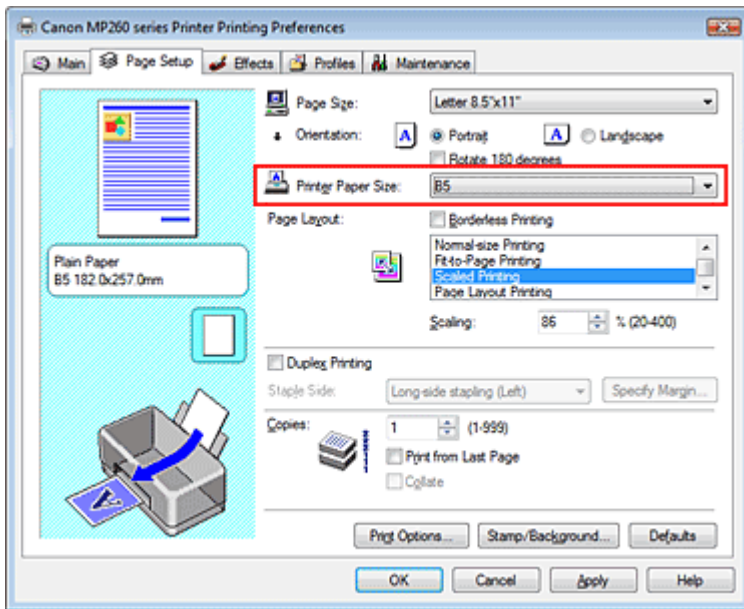

- **Specify a scaling factor**

Directly type in a value into the Scaling box.

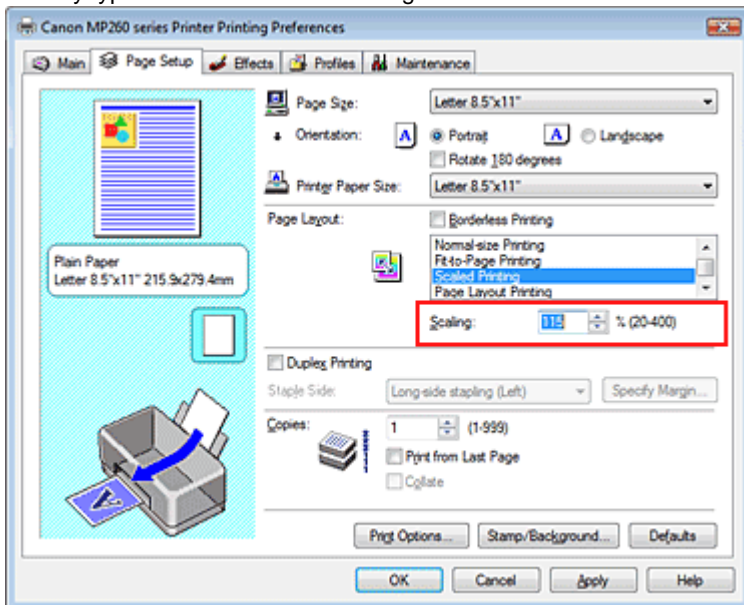

The current settings are displayed in the Settings Preview on the left side of the printer driver.

5. Complete the setup

Click OK.

When you execute print, the document will be printed with the specified scale.

Important

- If the application software with which you created the original has the scaled printing function, configure the settings on your application software. You do not need to also configure the same setting in the printer driver.
- When Scaled Printing is selected, the Staple Side list box appears grayed out and is unavailable (when Duplex Printing is not selected).
- When Borderless Printing check box is checked, Scaled Printing cannot be selected.

Note

- Selecting Scaled Printing changes the printable area.

[Page top](#) ↑

Advanced Guide

Advanced Guide > Printing from a Computer > Printing with Other Application Software > Various Printing Methods > Page Layout Printing

Page Layout Printing

The page layout printing function allows you to print more than one page image on a single sheet of paper.

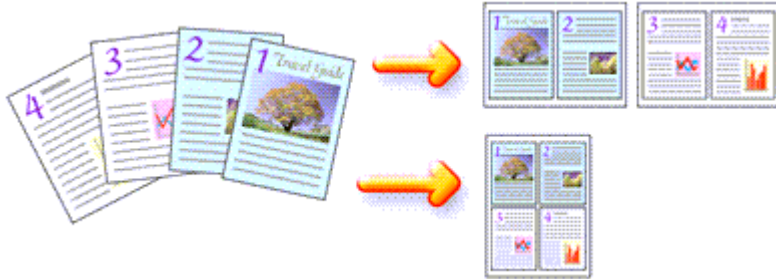

The procedure for performing page layout printing is as follows:

1. Open the **printer driver setup window**
2. Set page layout printing

Select Page Layout Printing from the Page Layout list on the Page Setup tab.

The current settings are displayed in the Settings Preview on the left side of the printer driver.

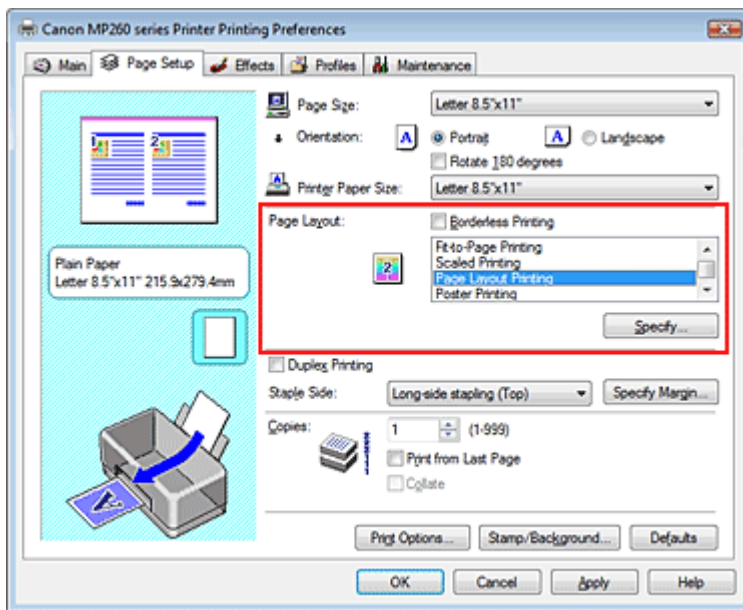

3. Select the print paper size

Select the size of the paper loaded in the machine from the Printer Paper Size list.

Now you have finished setting the layout of the document from left to right.

4. Set the number of pages to be printed on one sheet and the page sequence

If necessary, click Specify..., specify the following settings in the Page Layout Printing dialog box, and click OK.

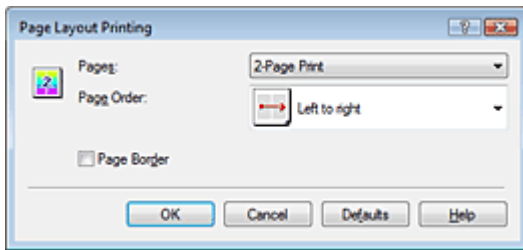
**Pages**

To increase the number of pages to be included on a single sheet of paper, select a desired number of pages from the list.

Page Order

To change the page arrangement order, select an icon from the list to change the page placement order.

Page Border

To print a page border around each document page, check this check box.

5. Complete the setup

Click OK on the Page Setup tab.

When you execute print, the specified number of pages will be arranged on each sheet of paper in the specified order.

Important

- When Borderless Printing check box is checked, Page Layout Printing cannot be selected.

[Page top](#) ↑

Advanced Guide

Advanced Guide > Printing from a Computer > Printing with Other Application Software > Various Printing Methods > Poster Printing

Poster Printing

The poster printing function allows you to enlarge image data, divide it into several pages, and print these pages on separate sheets of paper. When the pages are pasted together, they form a large print like a poster.

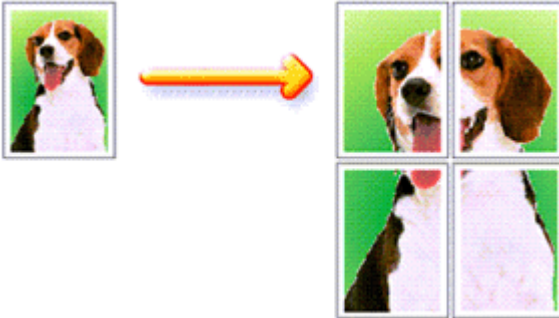

The procedure for performing poster printing is as follows:

Setting Poster Printing

1. Open the printer driver setup window
2. Set poster printing

Select Poster Printing from the Page Layout list on the Page Setup tab.

The current settings are displayed in the Settings Preview on the left side of the printer driver.

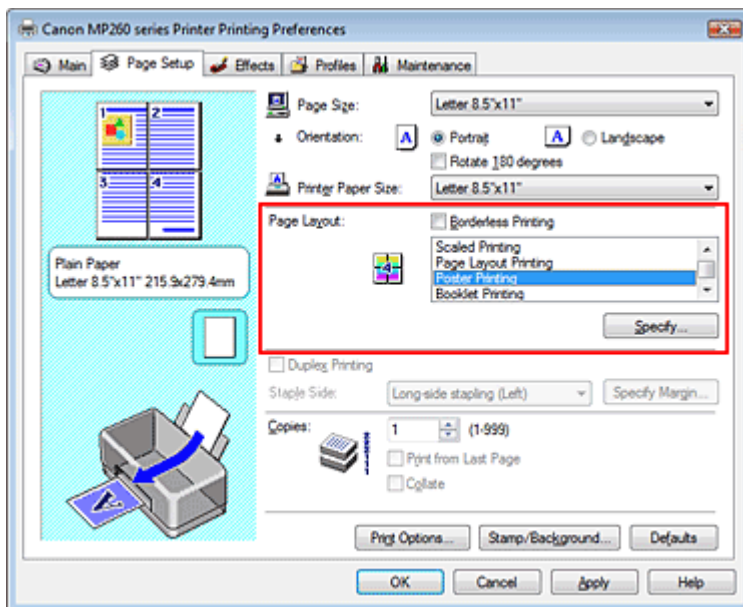

3. Select the print paper size

Select the size of the paper loaded in the machine from the Printer Paper Size list. Now you have finished setting 2 by 2-page poster printing.

4. Set the number of image divisions and the pages to be printed.

If necessary, click Specify..., specify the following settings in the Poster Printing dialog box, and then click OK.

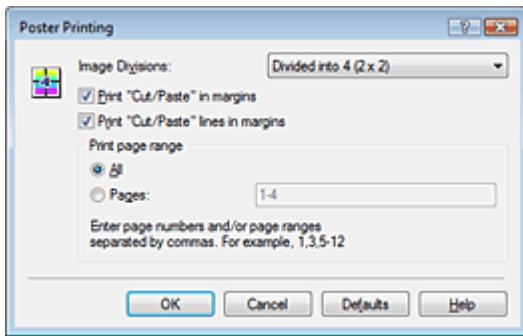

Image Divisions

Select the number of divisions (vertical x horizontal) from the Image Divisions list. As the number of divisions increases, the number of sheets used for printing increases, allowing you to create a larger poster.

Print "Cut/Paste" in margins

To leave out words "Cut" and "Paste", uncheck this check box.



Important

- This feature is unavailable when the 64-bit printer driver is used.

Print "Cut/Paste" lines in margins

To leave out cut lines, uncheck this check box.

Pages

To reprint only specific pages, enter the page number you want to print. To print multiple pages, specify by separating the pages with commas or entering a hyphen between the page numbers.



Note

- You can also specify the print range by clicking the pages in the setup preview.

5. Complete the setup

Click OK on the Page Setup tab.

When you execute print, the document will be divided into several pages during printing.

After all poster pages have been printed, paste the pages together to create a poster.

Printing Only Specific Pages

If ink becomes faint or runs out during printing, you can print the pages you still need, by following the procedure below:

1. Set the print range

In the Settings Preview on the left of the Page Setup tab, click the pages that do not need to be printed.

The pages that were clicked are deleted, and only the pages to be printed are displayed.

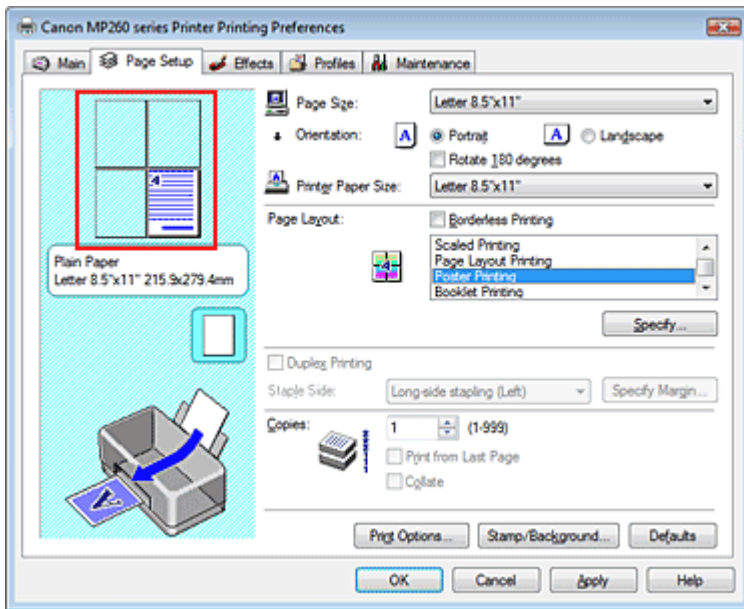

Note

- Click the deleted pages to display them again.
- Right-click the Settings Preview to select Print all pages or Delete all pages.

2. Complete the setup

After completing the page selection, click OK.

When you execute print, only specified pages will be printed.

Important

- When Poster Printing is selected, the Duplex Printing and Print from Last Page check boxes and the Staple Side list box appear grayed out and are unavailable.
- When Borderless Printing check box is checked, Poster Printing cannot be selected.
- Since poster printing enlarges the document when printing it, the print results may become coarse.

[Page top](#) ↑

Advanced Guide

Advanced Guide > Printing from a Computer > Printing with Other Application Software > Various Printing Methods > Booklet Printing

Booklet Printing

The booklet printing function allows you to print data for a booklet. Data is printed on both sides of the paper. This type of printing ensures that pages can be collated properly, in page number order, when the printed sheets are folded and stapled at the center.

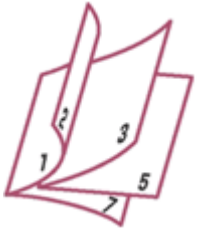

The procedure for performing booklet printing is as follows:

1. Open the printer driver setup window
2. Set booklet printing

Select Booklet Printing from the Page Layout list on the Page Setup tab.

The current settings are displayed in the Settings Preview on the left side of the window.

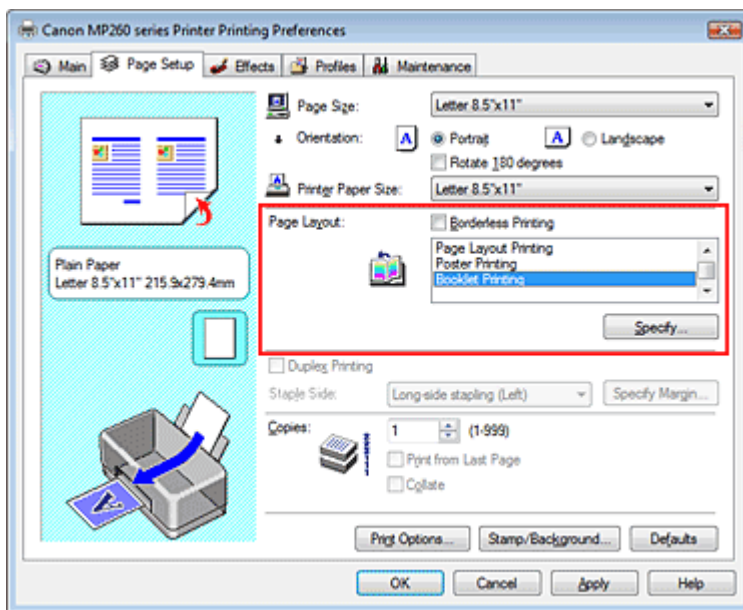

3. Select the print paper size

Select the size of the paper loaded in the machine from the Printer Paper Size list.

4. Set the margin for stapling and the margin width

Click Specify..., specify the following settings in the Booklet Printing dialog box, and then click OK.

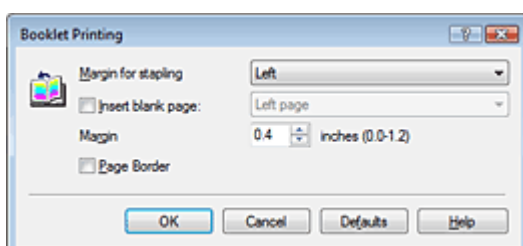

Margin for stapling

Select which side the stapling margin should be on when the booklet is completed.

Insert blank page

To leave one side of a sheet blank, check Insert blank page check box, and select the page to be left blank.

Margin

Enter the margin width. The specified width from the center of the sheet becomes the margin for one page.

Page Border

To print a page border around each document page, check the Page Border check box.

5. Complete the setup

Click OK on the Page Setup tab.

When you execute print, the document will be printed on one side of a sheet of paper. When the printing of one side is complete, set the paper correctly by following the message and click OK. When the printing of the other side is complete, fold the paper at the center of the margin and make a booklet.

 **Important**

- Booklet Printing is unavailable when:
 - A media type other than Plain Paper is selected from the Media Type list.
 - Borderless Printing check box is checked.
- When Booklet Printing is selected, Duplex Printing, Staple Side, Print from Last Page, and Collate appear grayed out and are unavailable.

 **Note**

- The stamp and background are not printed on blank sheets inserted with the Insert blank page function of Booklet Printing.

[Page top](#) ↑

Advanced Guide

Advanced Guide > Printing from a Computer > Printing with Other Application Software > Various Printing Methods > Duplex Printing

Duplex Printing

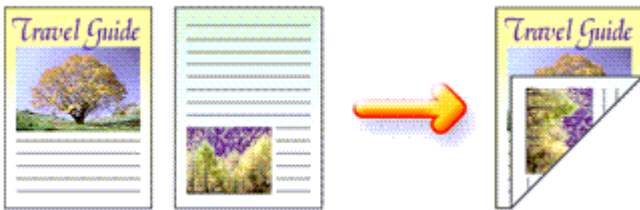

The procedure for printing data on both sides of a sheet of paper is as follows:

1. Open the **printer driver setup window**
2. Set duplex printing

Check the Duplex Printing check box on the Page Setup tab.

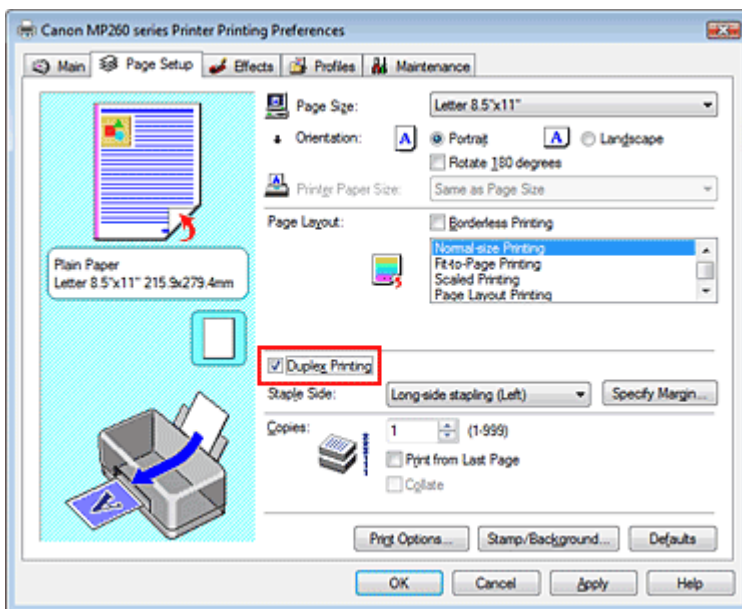

3. Select the layout

Select Normal-size Printing (or Fit-to-Page Printing, Scaled Printing, or Page Layout Printing) from the Page Layout list.

4. Specify the side to be stapled

The printer analyzes the Orientation and Page Layout settings, and automatically selects the best Staple Side. If you want to change the setting, select another value from the list.

5. Set the margin width

If necessary, click Specify Margin... and set the width of the stapling margin, and then click OK.

6. Complete the setup

Click OK on the Page Setup tab.

When you execute print, the document will be printed on one side of a sheet of paper. When the printing of one side is complete, set the paper correctly by following the message and click OK. The document will be printed on the opposite side.



Important

- Duplex Printing is unavailable when:
 - A media type other than Plain Paper is selected from the Media Type list.
 - Poster Printing is selected from the Page Layout list.
- When Booklet Printing is selected from the Page Layout list, Duplex Printing and Staple Side appear grayed out and are unavailable.

 **Note**

- If the Media Type dialog box appears when performing borderless printing during duplex printing, select Plain Paper.
 - If the back side of the paper becomes smudged during duplex printing, perform Bottom Plate Cleaning in the Maintenance tab.
-

[Page top](#) ↑

Advanced Guide

Advanced Guide > Printing from a Computer > Printing with Other Application Software > Various Printing Methods > Stamp/Background Printing

Stamp/Background Printing

This feature is unavailable when the 64-bit printer driver is used.

The Stamp function allows you to print a stamp text or a bitmap over or behind document data. The Background function allows you to print a light illustration behind the document data.

The procedure for performing stamp/background printing is as follows:

Printing a stamp

"CONFIDENTIAL," "IMPORTANT," and other stamps that are used often in companies are pre-registered.

1. Open the [printer driver setup window](#)
2. Click Stamp/Background... on the Page Setup tab

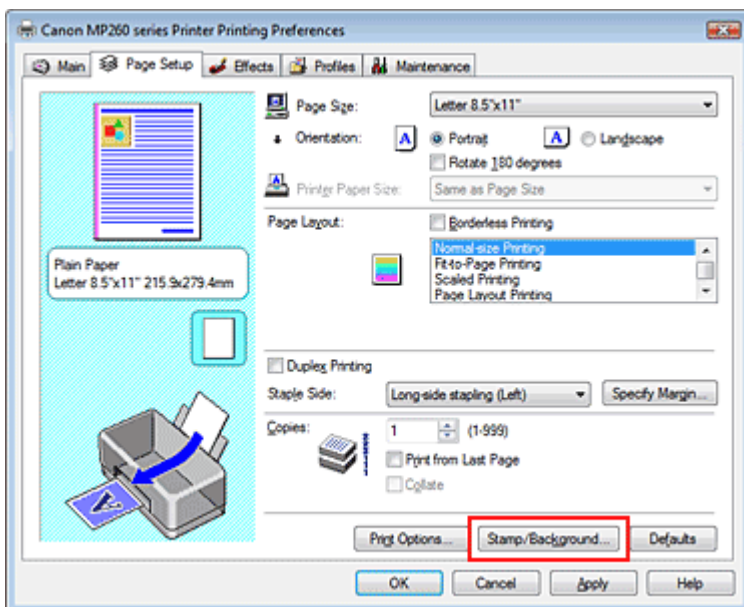

The Stamp/Background dialog box opens.

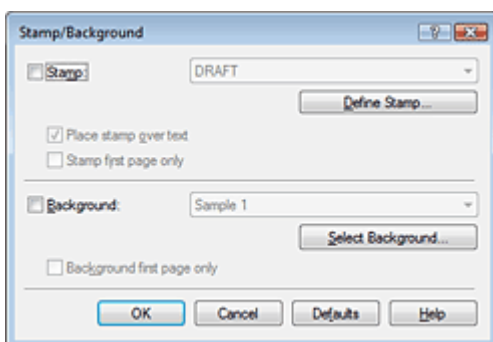

3. Select a stamp

Check the Stamp check box, and select a desired stamp from the list.

The current settings are displayed in the Settings Preview on the left side of the Page Setup tab.

4. Set the stamp details

If necessary, complete the following settings, and then click OK.

Place stamp over text

To print the stamp on the front of the document, check this check box.

 **Note**

- The stamp is given priority because the stamp is printed over the document data in the sections where the stamp and the document data overlap. If the Place stamp over text check box is unchecked, the stamp is printed behind the document data and may be hidden in the overlapping sections depending on the application used.

Background first page only

To print the stamp only on the first page, check this check box.

Define Stamp... button

To change the stamp text, bitmap, or position, click this (refer to Saving a Stamp Setting).

5. Complete the setup

Click OK on the Page Setup tab.

When you execute print, the data is printed with the specified stamp.

Printing a background**1. Select the background for which the settings are to be changed**

Two bitmap files are pre-registered as samples.

2. Click Stamp/Background... on the Page Setup tab

The Stamp/Background dialog box opens.

3. Select the background

Check the Background check box, and select a desired background from the list.

The current settings are displayed in the Settings Preview on the left side of the Page Setup tab.

4. Set the background details

If necessary, complete the following settings, and then click OK.

Background first page only

To print the background only on the first page, check this check box.

Select Background... button

To use another bitmap file or change the layout or density of a background, click this (refer to [Saving Image Data to be Used as a Background](#)).

5. Complete the setup

Click OK on the Page Setup tab.

When you execute print, the data is printed with the specified background.

 **Important**

- When the Borderless Printing check box is checked, the Stamp/Background... button appears grayed out and is unavailable.

 **Note**

- The stamp and background are not printed on blank sheets inserted with the Insert blank page function of Booklet Printing.

Related Topics

➔ [Saving a Stamp Setting](#)

➔ [Saving Image Data to be Used as a Background](#)



[Page top](#) ↑

Advanced Guide

Advanced Guide > Printing from a Computer > Printing with Other Application Software > Various Printing Methods > Stamp/Background Printing > Saving a Stamp Setting

Saving a Stamp Setting

This feature is unavailable when the 64-bit printer driver is used.

You can create and save a new stamp. You can also change and register some of the settings of an existing stamp. Unnecessary stamps can be deleted at any time.

The procedure for registering a new stamp is as follows:

Registering a new stamp

1. Open the [printer driver setup window](#)
2. Click Stamp/Background... on the Page Setup tab

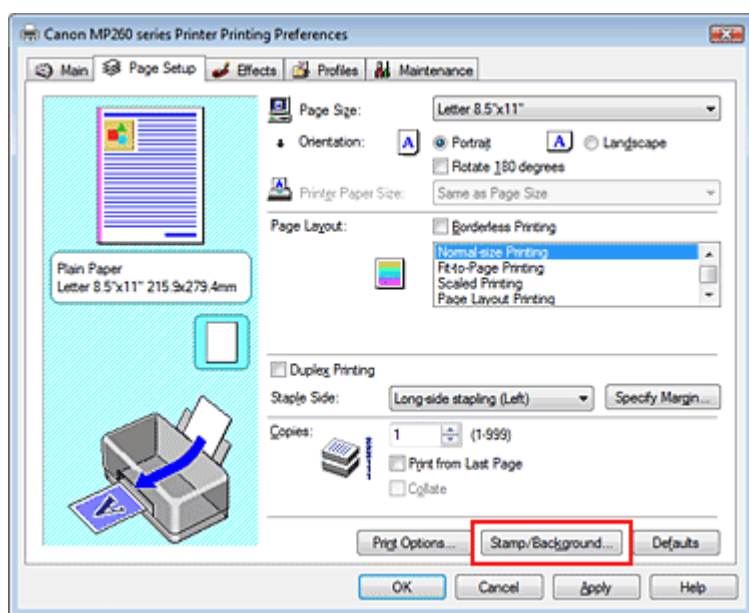

The Stamp/Background dialog box opens.

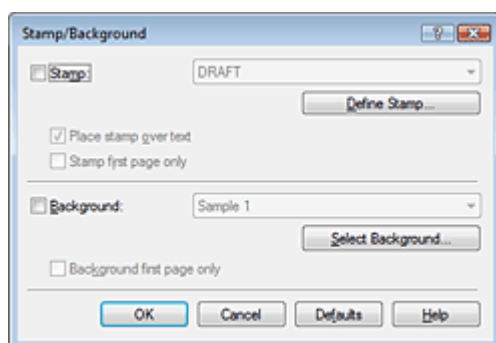

3. Click Define Stamp...

The Stamp Settings dialog box opens.

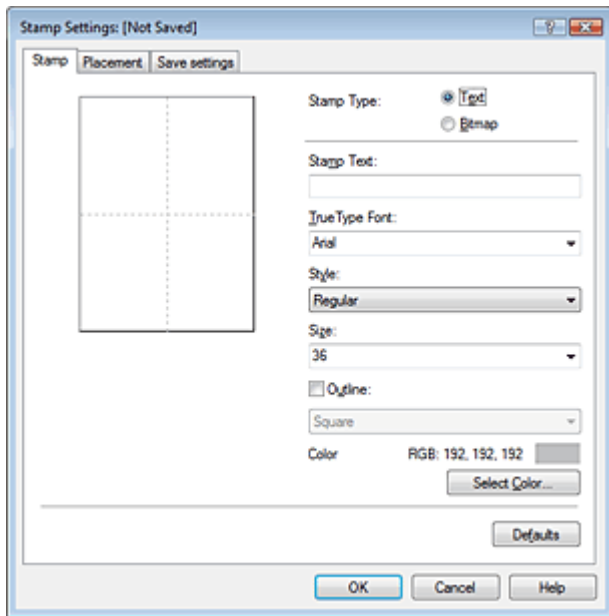

4. Configure the stamp while viewing the preview window

- **Stamp tab**

Select Text or Bitmap with Stamp Type.

When registering a text, the characters must already be entered in Stamp Text. Change the True Type Font, Style, Size, and Outline settings, as necessary. You can select the color of the stamp by clicking Select Color...

For Bitmap, click Select File... and select the bitmap file (.bmp) to be used. Change the settings of the Size and Transparent white area if necessary.

- **Placement tab**

Select the stamp position from the Position list. You can also select Custom from the Position list and specify coordinates for X-Position and Y-Position.

You can also change the stamp position by dragging the stamp in the preview window.

To change the stamp position angle, type a value in the Orientation box directly.

5. Save the stamp

Click the Save settings tab and enter a new stamp title in the Title box, and then click Save.

Click OK when the confirmation message appears.

6. Complete the setup

Click OK. The Stamp/Background dialog box opens again.

The registered title appears in the Stamp list.

Changing and registering some of stamp settings

1. Select the stamp for which the settings are to be changed

Check the Stamp check box in the Stamp/Background dialog box, and then select the title of the stamp to be changed from the Stamp list.

2. Click Define Stamp...

The Stamp Settings dialog box opens.

3. Configure the stamp while viewing the preview window

4. Save the stamp

Click Save overwrite on the Save settings tab.

If you want to save the stamp with a different title, type a new title in the Title box and click Save.

Click OK when the confirmation message appears.

5. Complete the setup

Click OK. The Stamp/Background dialog box opens again.
The registered title appears in the Stamp list.

Deleting an unnecessary stamp

1. Click Define Stamp... in the Stamp/Background dialog box

The Stamp Settings dialog box opens.

2. Select the stamp to be deleted

Select the title of the stamp you want to delete from the Stamps list on the Save settings tab. Then click Delete.

Click OK when the confirmation message appears.

3. Complete the setup

Click OK. The Stamp/Background dialog box opens again.



[Page top](#) ↑

Advanced Guide

Advanced Guide > Printing from a Computer > Printing with Other Application Software > Various Printing Methods > Stamp/Background Printing > Saving Image Data to be Used as a Background

Saving Image Data to be Used as a Background

This feature is unavailable when the 64-bit printer driver is used.

You can select a bitmap file and save it as a new background. You can also change and register some of the settings of an existing background. An unnecessary background can be deleted at any time.

The procedure for registering image data to be used as a background is as follows:

Registering image data to be used as a background

1. Open the [printer driver setup window](#)
2. Click Stamp/Background... on the Page Setup tab

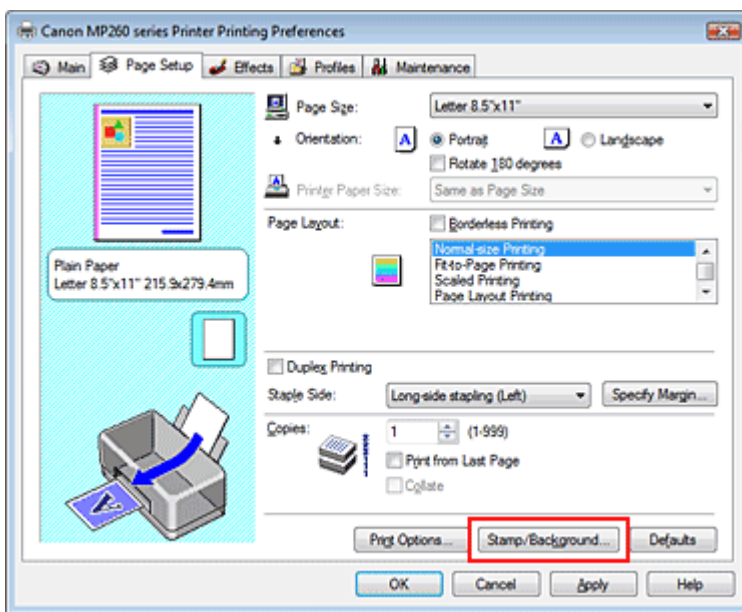

The Stamp/Background dialog box opens.

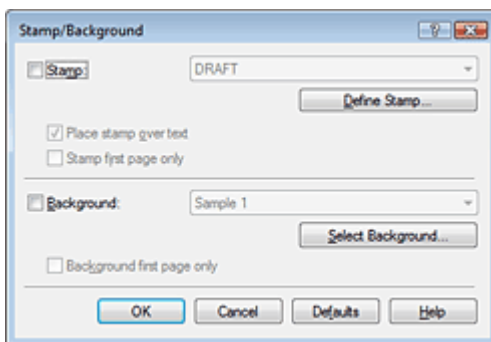

3. Click Select Background...

The Background Settings dialog box opens.

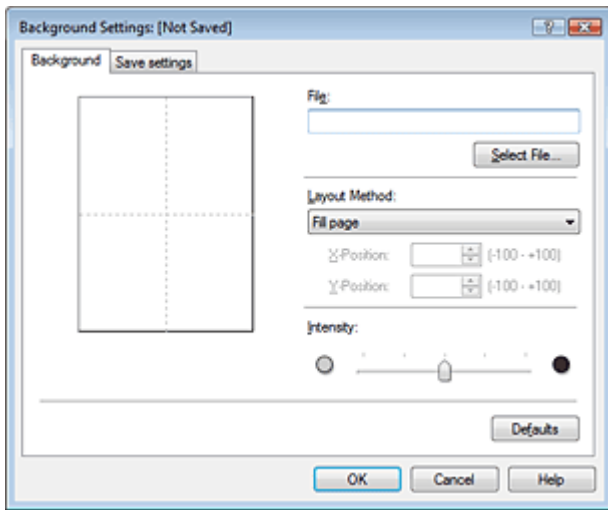

4. Select the image data to be registered to the background
Click Select File.... Select the target image data (bitmap file), and then click Open.
5. Specify the following settings while viewing the preview window

Layout Method

Select how the background image data is to be placed.

When Custom is selected, you can set coordinates for X-Position and Y-Position.

You can also change the background position by dragging the image in the preview window.

Intensity

Set the intensity of the background image data with the Intensity slider. To lighten the background, move the slider to the left. To darken the background, move the slider to the right. To print the background at the original bitmap intensity, move the slider to the rightmost position.

6. Save the background
Click the Save settings tab and enter a new stamp title in the Title box, and then click Save.
Click OK when the confirmation message appears.
7. Complete the setup
Click OK. The Stamp/Background dialog box opens again.
The registered title appears in the Background list.

Changing and saving some background settings

1. Select the background for which the settings are to be changed
Check the Background check box in the Stamp/Background dialog box, and then select the title of the background you want to change from the Background list.
2. Click Select Background...
The Background Settings dialog box opens.
3. While viewing the preview, set the items on the Background tab
4. Save the background
Click Save overwrite on the Save settings tab. If you want to save the background with a different title, type a new title in the Title box and click Save.
Click OK when the confirmation message appears.
5. Complete the setup
Click OK. The Stamp/Background dialog box opens again.
The registered title appears in the Background list.

Deleting an unnecessary background

1. Click Select Background... in the Stamp/Background dialog box

The Background Settings dialog box opens.

2. Select the background to be deleted

Select the title of the background you want to delete from the Backgrounds list on the Save settings tab, and then click Delete.

Click OK when the confirmation message appears.

3. Complete the setup

Click OK. The Stamp/Background dialog box opens again.



[Page top](#) ↑

Advanced Guide

Advanced Guide > Printing from a Computer > Printing with Other Application Software > Various Printing Methods > Printing an Envelope

Printing an Envelope

For details on how to load an envelope into the machine, refer to the "Loading Envelopes" in the manual: Basic Guide.

The procedure for performing envelope printing is as follows:

1. Load an envelop into the machine

Fold down the envelope flap.

Orient the envelope so that the flap is on the left and the folded surface is facing down.

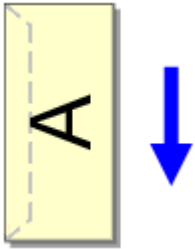

2. Open the printer driver setup window

3. Select the media type

Select Envelope from the Media Type list on the Main tab.

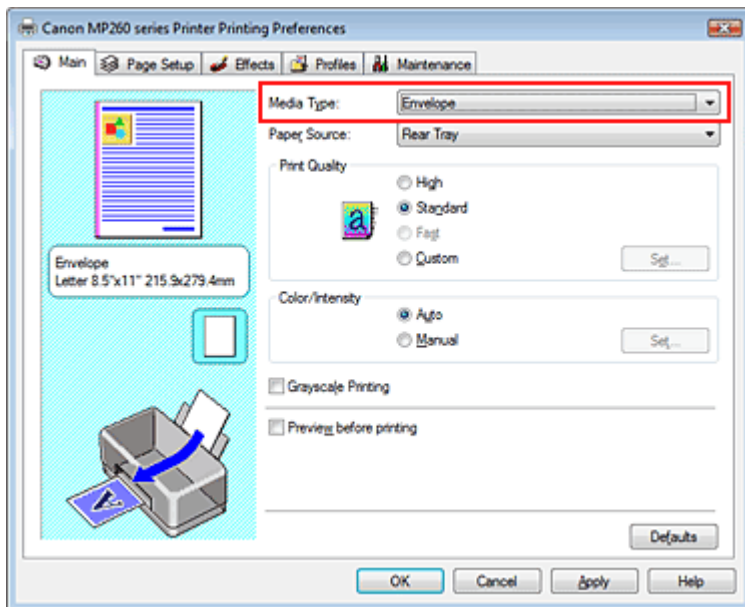

4. Select the paper size

Click the Page Setup tab, and select Youkei 4, Youkei 6, Comm.Env. #10, or DL Env. for Page Size.

5. Select the landscape for orientation

To print the addressee horizontally, select Landscape for Orientation.

6. Complete the setup

Click OK.

When you execute print, the information is printed on the envelope.

Advanced Guide

Advanced Guide > Printing from a Computer > Printing with Other Application Software > Various Printing Methods > Displaying the Print Results before Printing

Displaying the Print Results before Printing

You can display and check the print result before printing.

The procedure for displaying the print result before printing is as follows:

1. Open the [printer driver setup window](#)
2. Set the preview

Check the Preview before printing check box on the Main tab.

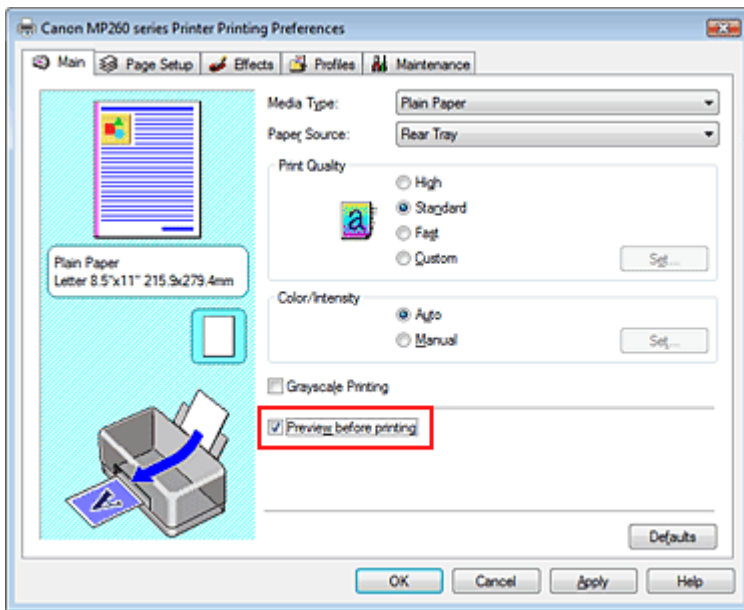

3. Complete the setup

Click OK.

The Canon IJ Preview will start and the print result will be displayed before printing.

Related Topic

➔ [Canon IJ Preview](#)

[Page top](#) ↑

Advanced Guide

Advanced Guide > Printing from a Computer > Printing with Other Application Software > Various Printing Methods > Setting Paper Dimensions (Custom Size)

Setting Paper Dimensions (Custom Size)

You can specify the height and width of paper if its size cannot be selected in Page Size. Such a paper size is called a custom size.

The procedure for specifying a custom size is as follows:

1. Set the custom size in the application software

On your application's paper size feature, specify your custom size.

Important

- If the application software that created the document has a function for specifying the height and width values, use the application software to set the values. If the application software does not have such a function or if the document does not print correctly, use the printer driver to set the values.

2. Open the printer driver setup window

3. Select the paper size

Select Custom... for Page Size on the Page Setup tab.

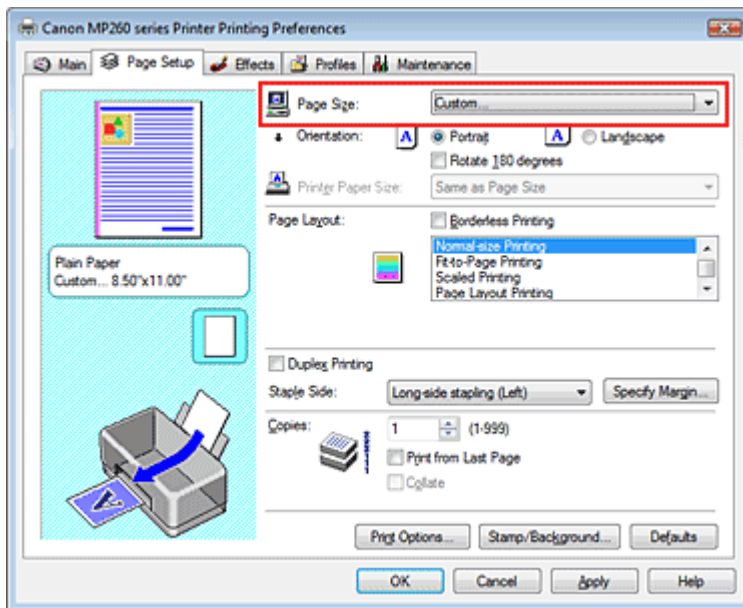

The Custom Paper Size dialog box opens.

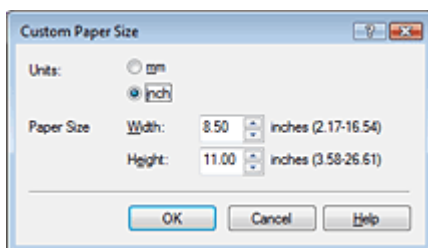

4. Set the custom size in the application software

Specify Units, and enter the Width and Height of the paper to be used. Then click OK.

5. Complete the setup

Click OK on the Page Setup tab.

When you execute print, the data is printed with the specified paper size.

[Page top](#) ↑

Advanced Guide

Advanced Guide > Printing from a Computer > Printing with Other Application Software > Changing the Print Quality and Correcting Image Data

Changing the Print Quality and Correcting Image Data

- ➔ Selecting a Combination of the Print Quality Level and a Halftoning Method
- ➔ Printing a Color Document in Monochrome
- ➔ Specifying Color Correction
- ➔ Optimal Photo Printing of Image Data
- ➔ Adjusting Colors with the Printer Driver
- ➔ Printing with ICC Profiles
- ➔ Adjusting Color Balance
- ➔ Adjusting Brightness
- ➔ Adjusting Intensity
- ➔ Adjusting Contrast
- ➔ Simulating an Illustration
- ➔ Representing Image Data with a Single Color
- ➔ Presenting Image Data with Vivid Colors
- ➔ Smoothing Jagged Outlines
- ➔ Changing Color Properties to Improve Coloration
- ➔ Reducing Photo Noise

[Page top](#) ↕

Advanced Guide

Advanced Guide > Printing from a Computer > Printing with Other Application Software > Changing the Print Quality and Correcting Image Data > Selecting a Combination of the Print Quality Level and a Halftoning Method

Selecting a Combination of the Print Quality Level and a Halftoning Method

You can set the print quality level and the halftoning method.



The procedure for setting the print quality level and the halftoning method is as follows:

1. Open the printer driver setup window
2. Select the print quality

Select Custom for Print Quality on the Main tab, and click Set...

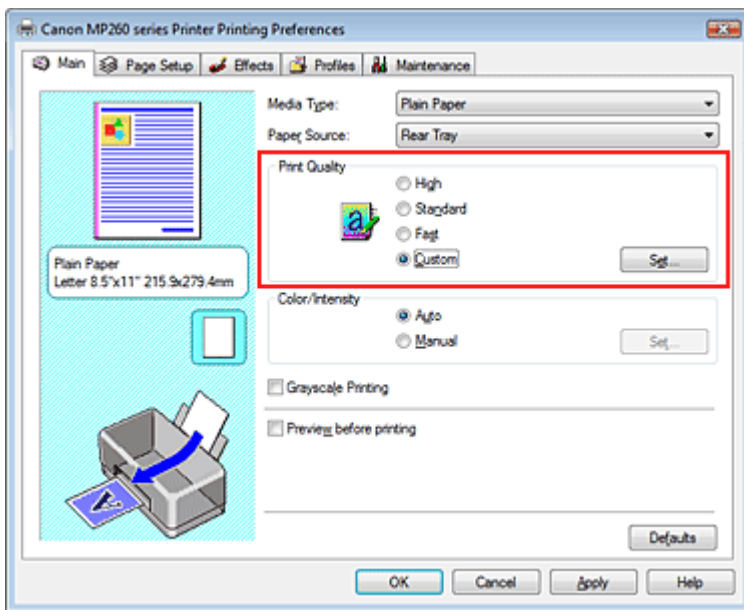

The Custom dialog box opens.

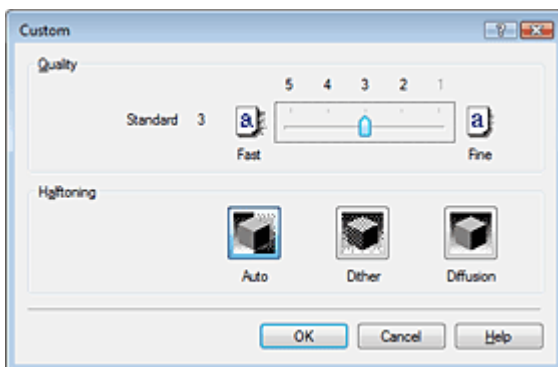

3. Setting the print quality and halftone expression method

Move the Quality slider to select the quality level.
Select Halftoning and click OK.



Note

- Halftones refer to color shades between the darkest color and the brightest color. The printer replaces the color shades with a collection of small dots to express the halftones. Dither arranges the dots according to fixed rules to express the halftones. Diffusion places the dots randomly to express the halftones. When you select Auto, the data is printed with the optimal halftoning method for the selected print quality.
-

4. Complete the setup

Click OK on the Main tab.

When you execute print, the data is printed with the specified quality level and halftoning method.

Important

- Certain print quality levels and halftoning methods cannot be selected depending on the settings of Media Type.

Note

- When the part of the object is not printed, selecting Diffusion for Halftoning may solve the problem.
-

Related Topics

- ➔ [Specifying Color Correction](#)
- ➔ [Adjusting Color Balance](#)
- ➔ [Adjusting Brightness](#)
- ➔ [Adjusting Intensity](#)
- ➔ [Adjusting Contrast](#)

[Page top](#) ↑

Advanced Guide

Advanced Guide > Printing from a Computer > Printing with Other Application Software > Changing the Print Quality and Correcting Image Data > Printing a Color Document in Monochrome

Printing a Color Document in Monochrome

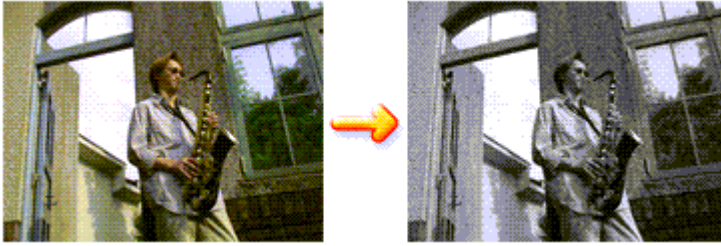

The procedure for printing a color document in monochrome is as follows:

1. Open the **printer driver setup window**
2. Set grayscale printing

Check the Grayscale Printing check box on the Main tab.

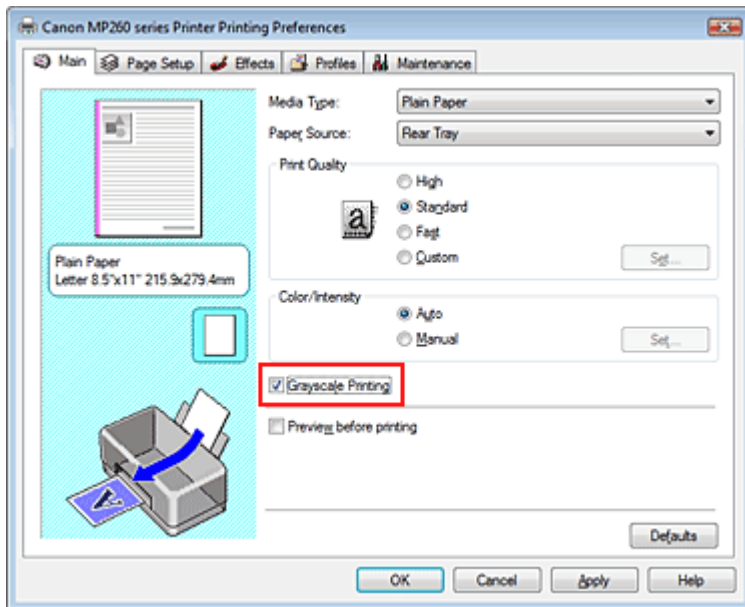

3. Complete the setup

Click OK.

When you execute print, the document is converted to grayscale data. It allows you to print the color document in monochrome.

Important

- When the Grayscale Printing check box is checked, the printer driver processes image data as sRGB data. In this case, actual colors printed may differ from those in the original image data. When using the grayscale printing function to print Adobe RGB data, convert the data to sRGB data using an application software.

Note

- During Grayscale Printing, color inks may be used as well as black ink.

[Page top](#) ↑

Advanced Guide

Advanced Guide > Printing from a Computer > Printing with Other Application Software > Changing the Print Quality and Correcting Image Data > Specifying Color Correction

Specifying Color Correction

You can specify the color correction method suited to the type of document to be printed. Normally, the printer driver adjusts the colors by using Canon Digital Photo Color so that data is printed with color tints that most people prefer. This method is suitable for printing sRGB data.

If you want to print by using the color space of sRGB or Adobe RGB data effectively, select ICM. If you want to use an application software to specify an ICC profile, select None.

The procedure for specifying color correction is as follows:

1. Open the [printer driver setup window](#)
2. Select the manual color adjustment

On the Main tab, select Manual for Color/Intensity, and click Set....

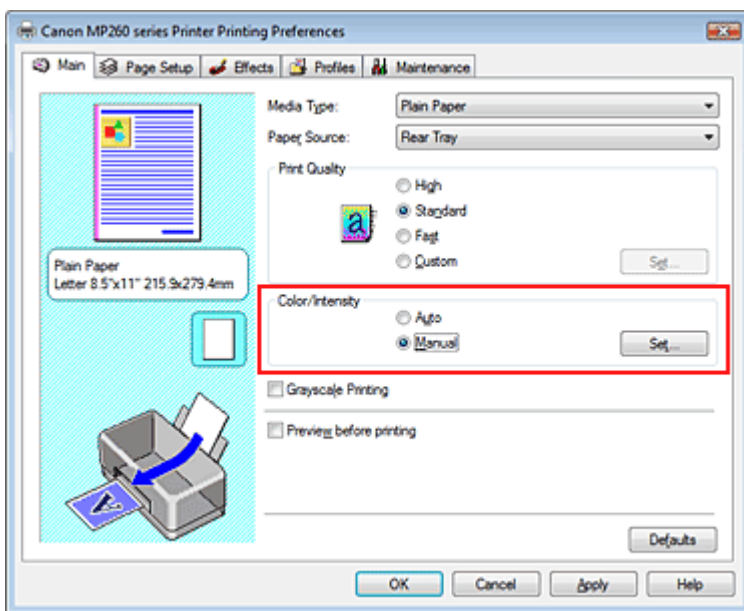

The Manual Color Adjustment dialog box opens.

3. Select color correction

Click Matching tab, select Color Correction setting suited to your purpose from the following, and click OK.

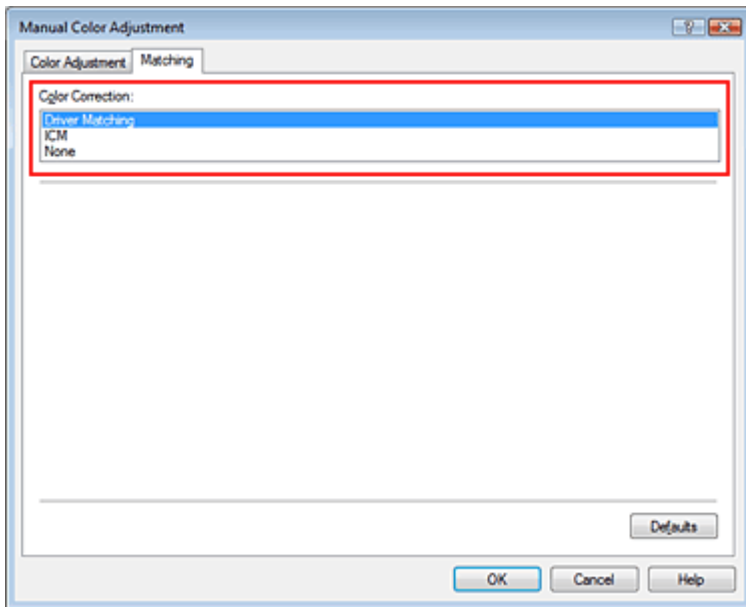

Driver Matching

By using Canon Digital Photo Color, you can print sRGB data with color tints that most people prefer.

Driver Matching is the default setting for Color Correction.

ICM

You can print by using the color space of sRGB or Adobe RGB data effectively.

None

The printer driver does not perform color adjustment. Select this value if you are specifying an individually created profile or a profile for special Canon paper in an application software to print data.

4. Complete the setup

Click OK on the Main tab.

When you execute print, the data is printed with the specified color adjustment method.

Important

- If ICM is disabled in the application software, ICM is unavailable for Color Correction and the printer may not be able to print the image data properly.
- When the Grayscale Printing check box on the Main tab is checked, Color Correction appears grayed out and is unavailable.

Related Topics

- ➔ [Optimal Photo Printing of Image Data](#)
- ➔ [Adjusting Colors with the Printer Driver](#)
- ➔ [Printing with ICC Profiles](#)



[Page top](#) ↑

Advanced Guide

[Advanced Guide](#) > [Printing from a Computer](#) > [Printing with Other Application Software](#) > [Changing the Print Quality and Correcting Image Data](#) > [Specifying Color Correction](#) > [Optimal Photo Printing of Image Data](#)

Optimal Photo Printing of Image Data

When people print images taken with digital cameras, they sometimes feel that the printed color tones differ from those of actual image or those displayed on the monitor.

To get the print results as close as possible to the desired color tones, you must select a printing method that is best suited to the application software used or to your purpose.

Color Management

Devices such as digital cameras, scanners, monitors, and printers handle color differently. Color management (color matching) is a method that manages device-dependent "colors" as a common color space. For Windows, a color management system called "ICM" is built into the operating system. sRGB and Adobe RGB are popularly used as common color spaces. Adobe RGB has a wider color space than sRGB.

ICC profiles convert device-dependent "colors" into a common color space.

By using an ICC profile and carrying out color management, you can draw out the color space of the image data within the color reproduction area that the printer can express.

Selecting a printing method suited to the image data

The recommended printing method depends on the color space (Adobe RGB or sRGB) of the image data or the application software to be used. There are two typical printing methods. Check the color space (Adobe RGB or sRGB) of the image data and the application software to be used, and then select the printing method suited to your purpose.

- **To print using Canon Digital Photo Color**

Target data: sRGB data

Printing method: [Adjusting Colors with the Printer Driver](#)

- **To print using the color space of the data effectively**

Target data: Adobe RGB data or sRGB data

Application software: An ICC profile can or cannot be specified.

Printing method: [Printing with ICC Profiles](#)



[Page top](#) ↑

Advanced Guide

Advanced Guide > Printing from a Computer > Printing with Other Application Software > Changing the Print Quality and Correcting Image Data > Specifying Color Correction > Adjusting Colors with the Printer Driver

Adjusting Colors with the Printer Driver

You can specify the color correction function of the printer driver to print sRGB data with color tints that most people prefer (through the use of Canon Digital Photo Color).

The procedure for adjusting colors with the printer driver is as follows:

1. Open the printer driver setup window

2. Select the media type

Select the type of paper loaded in the machine from the Media Type list on the Main tab.

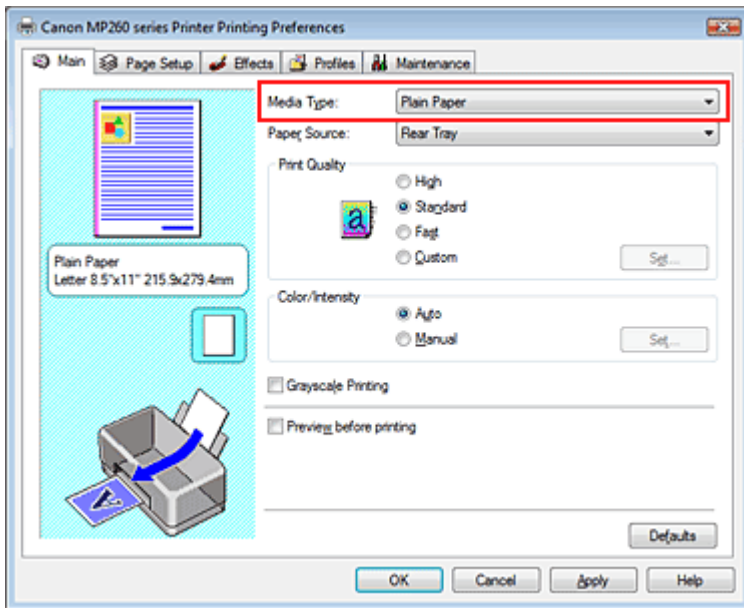

3. Select the print quality

Select High, Standard, or Fast for Print Quality.

4. Select the manual color adjustment

Select Manual for Color/Intensity, and click Set....
The Manual Color Adjustment dialog box opens.

5. Select color correction

Click Matching tab, and select Driver Matching for Color Correction.

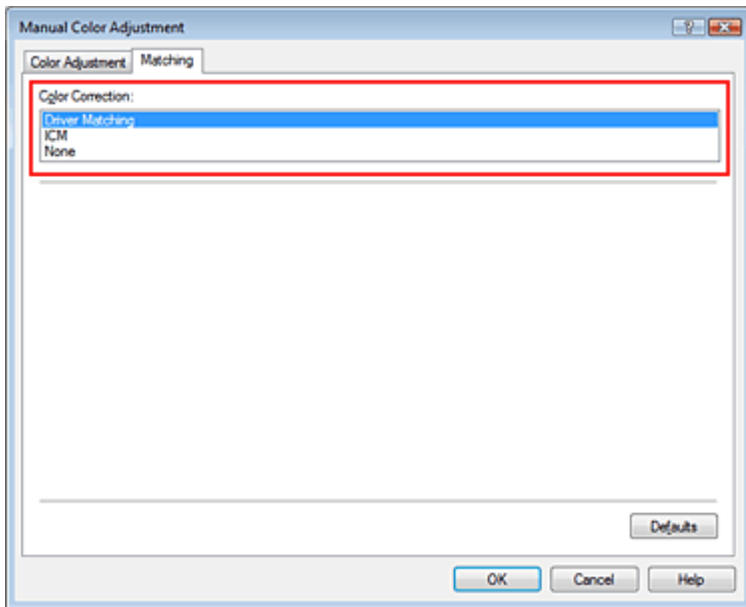

6. Set the other items

If necessary, click Color Adjustment tab, and adjust the color balance of Cyan, Magenta, Yellow, and adjust Brightness, Intensity, and Contrast settings, and then click OK.

7. Complete the setup

Click OK on the Main tab.

When you execute print, the printer driver adjusts the colors when printing the data.

Related Topics

- ➔ [Selecting a Combination of the Print Quality Level and a Halftoning Method](#)
- ➔ [Specifying Color Correction](#)
- ➔ [Adjusting Color Balance](#)
- ➔ [Adjusting Brightness](#)
- ➔ [Adjusting Intensity](#)
- ➔ [Adjusting Contrast](#)



[Page top](#) ↑

Advanced Guide

Advanced Guide > Printing from a Computer > Printing with Other Application Software > Changing the Print Quality and Correcting Image Data > Specifying Color Correction > Printing with ICC Profiles

Printing with ICC Profiles

If the image data has a specified ICC profile, you can effectively use the color space (Adobe RGB or sRGB) of the data when printing.

The printer driver setting procedure varies depending on the application software used to print.

Printing image data from the application software that can specify an ICC profile

When using Adobe Photoshop, Canon Digital Photo Professional, or any other application software that allows you to specify an ICC profile, you can use the color management system (ICM) found in Windows when printing the data. You can print the editing and touch-up results of an application software by effectively using the color space of the ICC profile specified in the image data.

To use this printing method, you must first use an application software to specify an ICC profile in the image data. For instructions on specifying an ICC profile with an application software program, refer to the manual of the application software you are using.

1. Open the printer driver setup window

2. Select the media type

Select the type of paper loaded in the machine from the Media Type list on the Main tab.

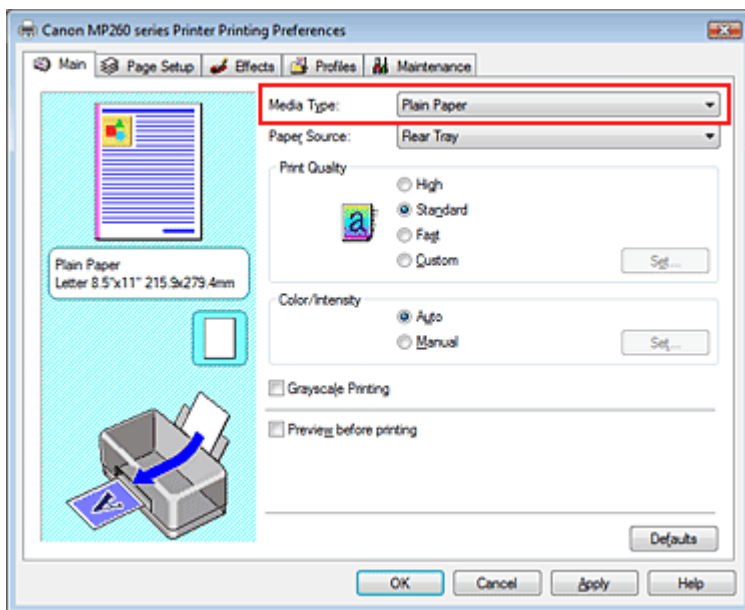

3. Select the print quality

Select High, Standard, or Fast for Print Quality.

4. Select the manual color adjustment

Select Manual for Color/Intensity, and click Set....
The Manual Color Adjustment dialog box opens.

5. Select color correction

Click Matching tab, and select ICM for Color Correction.

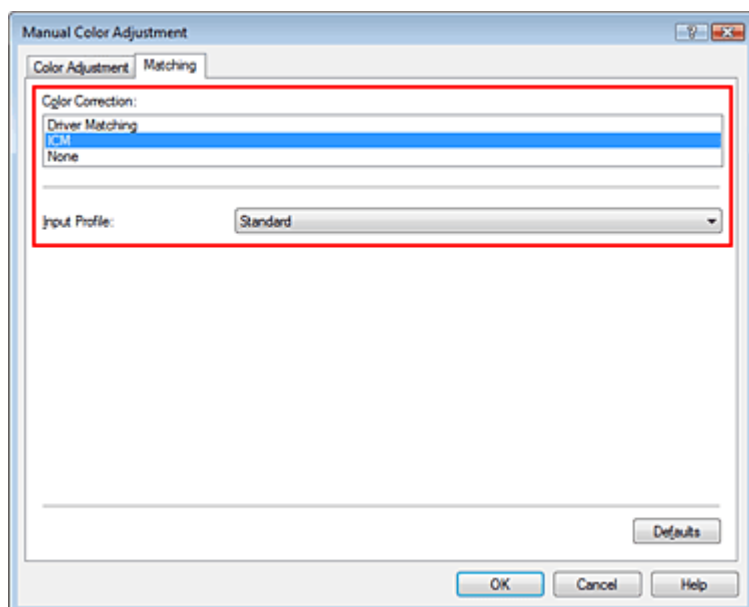

6. Set the other items

If necessary, click Color Adjustment tab, and adjust the color balance of Cyan, Magenta, Yellow, and adjust Brightness, Intensity, and Contrast settings, and then click OK.

7. Complete the setup

Click OK on the Main tab.

When you execute print, the printer uses the color space of the image data.

Important

- If you print an image by specifying an individually created profile or a profile for special Canon paper in an application software, select None from the Color Correction menu of the printer driver.

Printing image data from the application software that cannot specify an ICC profile

When printing from an application software that does not allow you to specify an ICC profile, specify the ICC profile in the print settings of the printer driver and print the data. When printing Adobe RGB data, you can print the data with the Adobe RGB color space even if the application software does not support Adobe RGB.

1. Open the printer driver setup window

2. Select the media type

Select the type of paper loaded in the machine from the Media Type list on the Main tab.

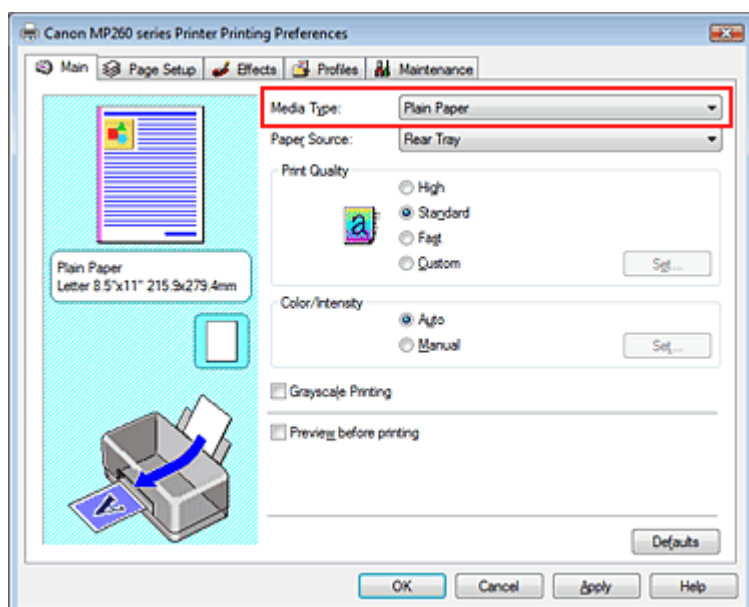

3. Select the print quality

Select High, Standard, or Fast for Print Quality.

4. Select the manual color adjustment

Select Manual for Color/Intensity, and click Set...
Manual Color Adjustment dialog box opens.

5. Select color correction

Click Matching tab, and select ICM for Color Correction.

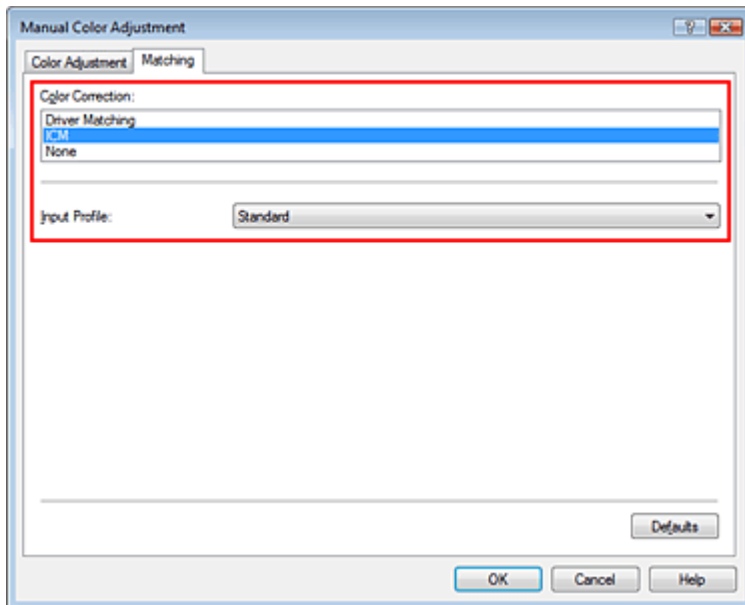

6. Select the input profile

Select an Input Profile that matches the color space of the image data.

- **For sRGB data or data without an ICC profile:**
Select Standard.
- **For Adobe RGB data:**
Select Adobe RGB (1998).

Important

- If the application software specifies an input profile, the input profile setting of the printer driver becomes invalid.
- If no ICC profiles are installed on your computer, Adobe RGB (1998) is not displayed. You can install ICC profiles from the Setup CD-ROM that accompanies the machine.

7. Set the other items

If necessary, click Color Adjustment tab, and adjust the color balance of Cyan, Magenta, Yellow, and adjust Brightness, Intensity, and Contrast settings, and then click OK.

8. Complete the setup

Click OK on the Main tab.

When you execute print, the data is printed with the color space of the selected image data.

Related Topics

- ➔ [Selecting a Combination of the Print Quality Level and a Halftoning Method](#)
- ➔ [Specifying Color Correction](#)
- ➔ [Adjusting Color Balance](#)
- ➔ [Adjusting Brightness](#)
- ➔ [Adjusting Intensity](#)
- ➔ [Adjusting Contrast](#)



[Page top](#) ↑

Advanced Guide

Advanced Guide > Printing from a Computer > Printing with Other Application Software > Changing the Print Quality and Correcting Image Data > Adjusting Color Balance

Adjusting Color Balance

You can adjust the color tints during printing.

Since this function adjusts color balance of the output by changing the ink ratios of each color, it changes the total color balance of the document. Use the application software if you want to change the color balance significantly. Use the printer driver only if you want to adjust the color balance slightly.

The following sample shows the case when Color Balance is used to intensify cyan and to diminish yellow so that the overall colors are more uniform.



No adjustment

Adjusted in Color Balance

The procedure for adjusting color balance is as follows:

1. Open the **printer driver setup window**
2. Select the manual color adjustment

On the Main tab, select Manual for Color/Intensity, and click Set....

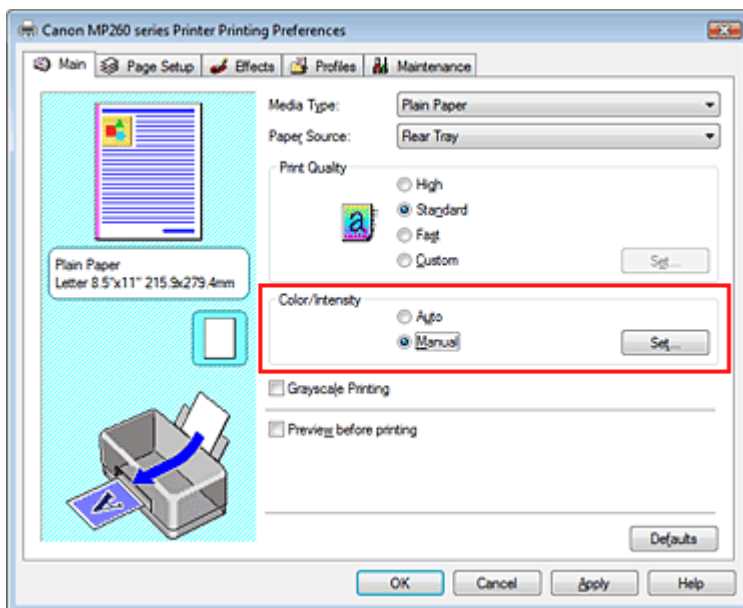

The Manual Color Adjustment dialog box opens.

3. Adjust color balance

There are individual sliders for Cyan, Magenta, and Yellow. Each color becomes stronger when the corresponding slider is moved to the right, and becomes weaker when the corresponding slider is moved to the left. For example, if cyan becomes weaker, the color red becomes stronger.

You can also directly enter a value linked to the slider. Enter a value in the range from -50 to 50.

After adjusting each color, click OK.

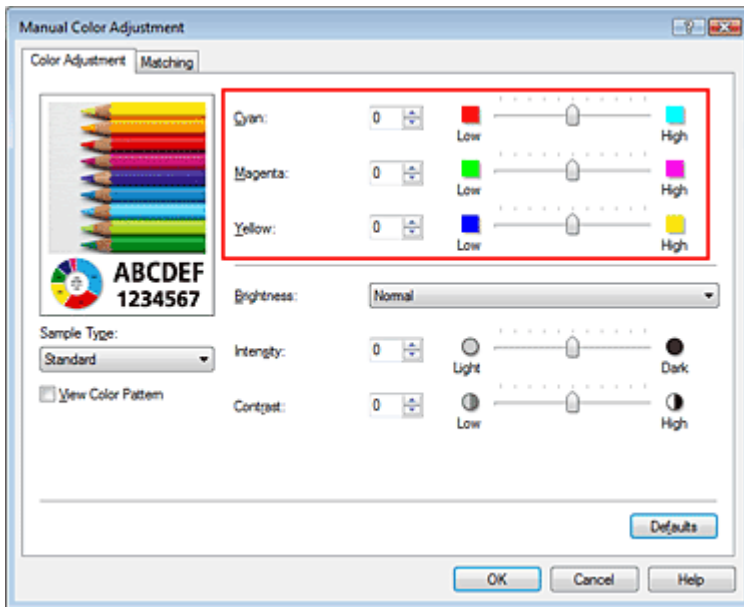

4. Complete the setup

Click OK on the Main tab.

When you execute print, the document is printed with the adjusted color balance.

Important

- When the Grayscale Printing check box on the Main tab is checked, Cyan, Magenta, and Yellow appear grayed out and are unavailable.

Related Topics

- ➔ [Selecting a Combination of the Print Quality Level and a Halftoning Method](#)
- ➔ [Specifying Color Correction](#)
- ➔ [Adjusting Brightness](#)
- ➔ [Adjusting Intensity](#)
- ➔ [Adjusting Contrast](#)

[Page top](#) ↑

Advanced Guide

Advanced Guide > Printing from a Computer > Printing with Other Application Software > Changing the Print Quality and Correcting Image Data > Adjusting Brightness

Adjusting Brightness

You can change the brightness of the overall image data during printing. This function does not change pure white or pure black but it changes the brightness of the intermediate colors.

The following sample shows the print result when the Brightness specification is changed.



Light is selected

Normal is selected

Dark is selected

The procedure for adjusting brightness is as follows:

1. Open the **printer driver setup window**
2. Select the manual color adjustment

On the Main tab, select Manual for Color/Intensity, and click Set....

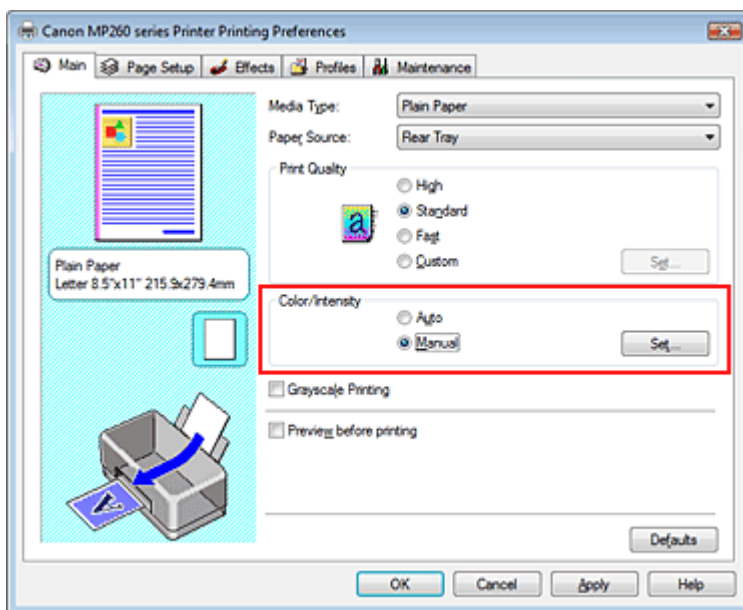

The Manual Color Adjustment dialog box opens.

3. Specify the brightness

Select Light, Normal, or Dark for Brightness, and click OK.

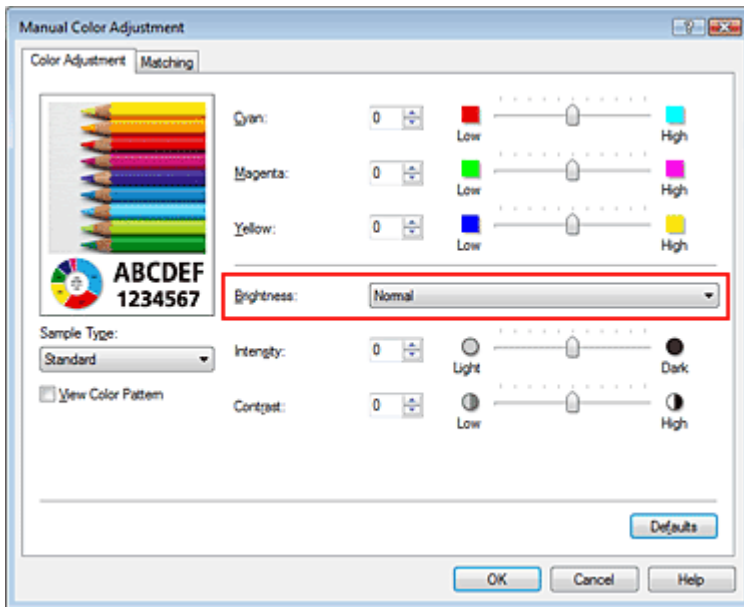

4. Complete the setup

Click OK on the Main tab.

When you execute print, the data is printed at the specified brightness.

Related Topics

- [Selecting a Combination of the Print Quality Level and a Halftoning Method](#)
- [Specifying Color Correction](#)
- [Adjusting Color Balance](#)
- [Adjusting Intensity](#)
- [Adjusting Contrast](#)

[Page top](#) ↑

Advanced Guide

Advanced Guide > Printing from a Computer > Printing with Other Application Software > Changing the Print Quality and Correcting Image Data > Adjusting Intensity

Adjusting Intensity

You can dilute (brighten) or intensify (darken) the colors of the overall image data during printing.

If you want to sharpen the print results, you should intensify the colors.

The following sample shows the case when the intensity is increased so that all colors become more intense when the image data is printed.



No adjustment

Higher Intensity

The procedure for adjusting intensity is as follows:

1. Open the **printer driver setup window**

2. Select the manual color adjustment

Select Manual for Color/Intensity on the Main tab, and click Set....

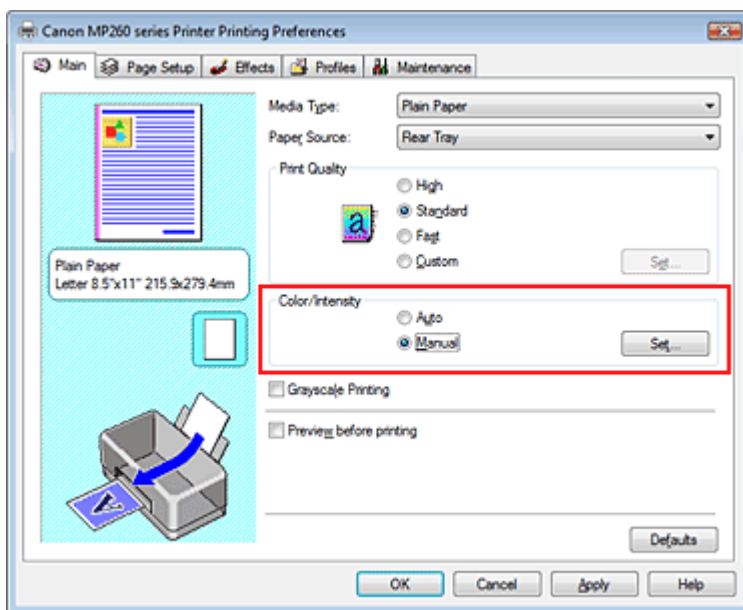

The Manual Color Adjustment dialog box opens.

3. Adjust intensity

Moving the Intensity slider to the right intensifies (darkens) the colors. Moving the slider to the left dilutes (brightens) the colors.

You can also directly enter a value linked to the slider. Enter a value in the range from -50 to 50.

After adjusting each color, click OK.

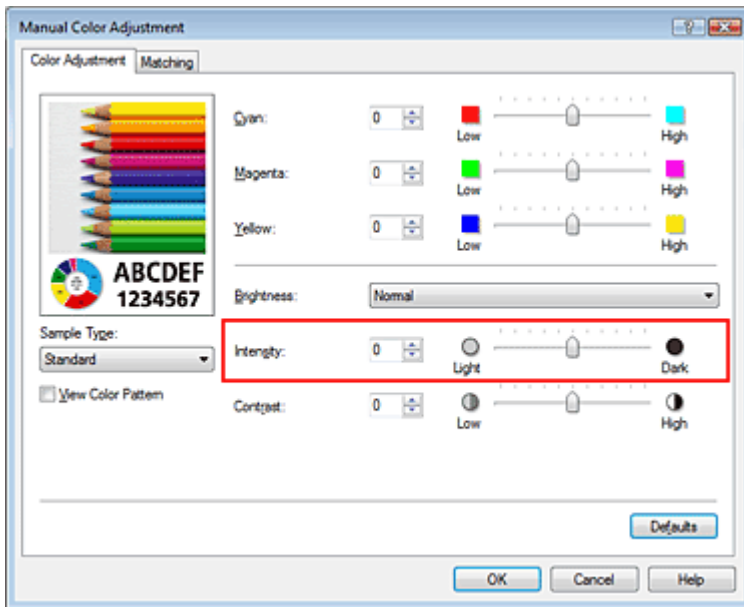

Important

- Adjust the slider gradually.

4. Complete the setup

Click OK on the Main tab.

When you execute print, the image data is printed with the adjusted intensity.

Related Topics

- ➔ [Selecting a Combination of the Print Quality Level and a Halftoning Method](#)
- ➔ [Specifying Color Correction](#)
- ➔ [Adjusting Color Balance](#)
- ➔ [Adjusting Brightness](#)
- ➔ [Adjusting Contrast](#)

[Page top](#) ↑

Advanced Guide

Advanced Guide > Printing from a Computer > Printing with Other Application Software > Changing the Print Quality and Correcting Image Data > Adjusting Contrast

Adjusting Contrast

You can adjust the image contrast during printing.

To make the differences between the light and dark portions of images greater and more distinct, increase the contrast. On the other hand, to make the differences between the light and dark portions of images smaller and less distinct, reduce the contrast.



No adjustment

Adjust the contrast

The procedure for adjusting contrast is as follows:

1. Open the **printer driver setup window**
2. Select the manual color adjustment

On the Main tab, select Manual for Color/Intensity, and click Set....

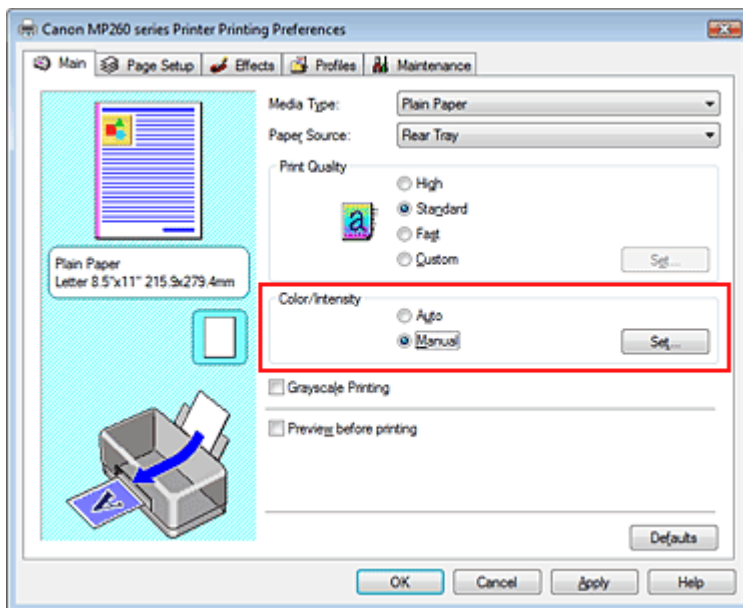

The Manual Color Adjustment dialog box opens.

3. Adjust the contrast

Moving the Contrast slider to the right increases the contrast, and moving it to the left decreases the contrast.

You can also directly enter a value linked to the slider. Enter a value in the range from -50 to 50.

After adjusting each color, click OK.

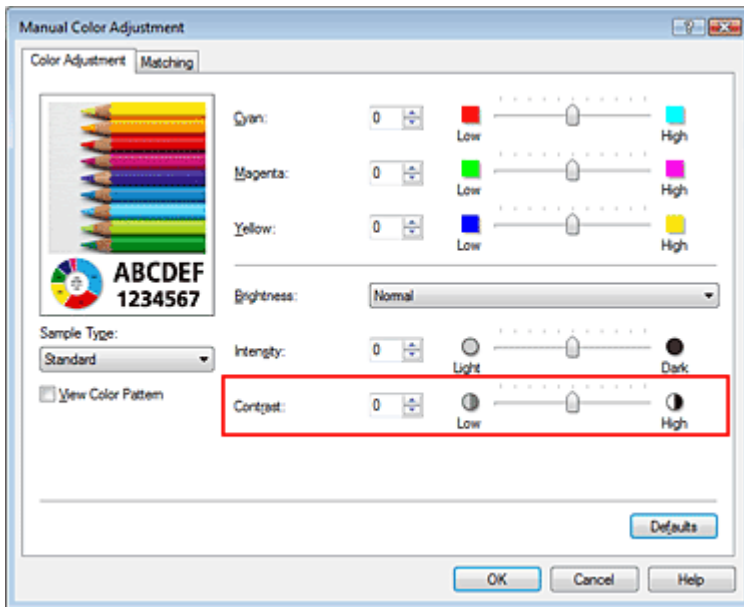

4. Complete the setup

Click OK on the Main tab.

When you execute print, the image is printed with the adjusted contrast.

Related Topics

- Selecting a Combination of the Print Quality Level and a Halftoning Method
- Specifying Color Correction
- Adjusting Color Balance
- Adjusting Brightness
- Adjusting Intensity

[Page top](#) ↑

Advanced Guide

Advanced Guide > Printing from a Computer > Printing with Other Application Software > Changing the Print Quality and Correcting Image Data > Simulating an Illustration

Simulating an Illustration

With the Simulate Illustration function, you can print full-color or 256-color image data so that it looks like a hand-drawn illustration. You can add different effects to the original profile and colors.

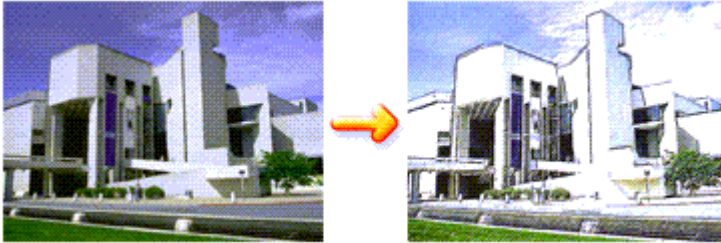

The procedure for performing Simulate Illustration is as follows:

1. Open the printer driver setup window
2. Set the Simulate Illustration

Check the Simulate Illustration check box on the Effects tab, and adjust the Contrast as necessary. Moving the slider to the right lightens the image data and moving the slider to the left darkens the image data.

The current settings are displayed in the Settings Preview on the left side of the printer driver.

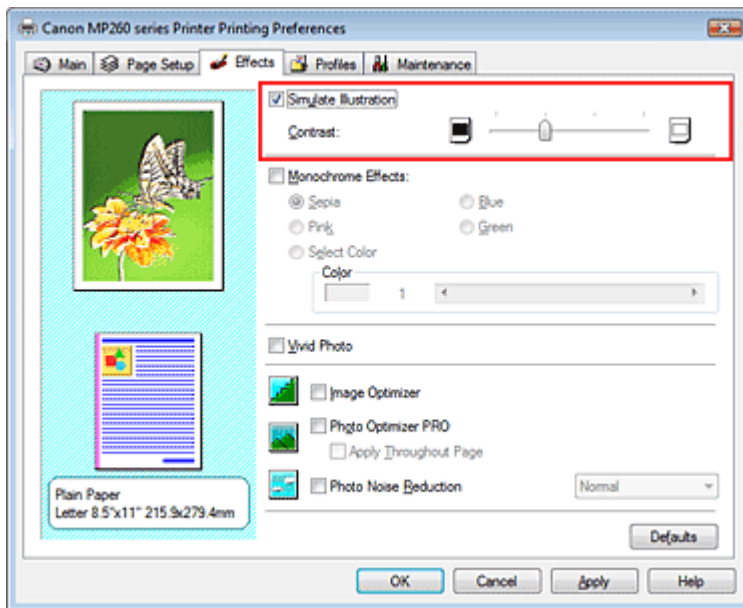

3. Complete the setup

Click OK.

When you execute print, the image will be printed so that it looks hand-drawn.

[Page top](#) ↑

Advanced Guide

Advanced Guide > Printing from a Computer > Printing with Other Application Software > Changing the Print Quality and Correcting Image Data > Representing Image Data with a Single Color

Representing Image Data with a Single Color

With the Monochrome Effects function, you can benefit from coloring effects such as changing a photograph to a sepia tone image.

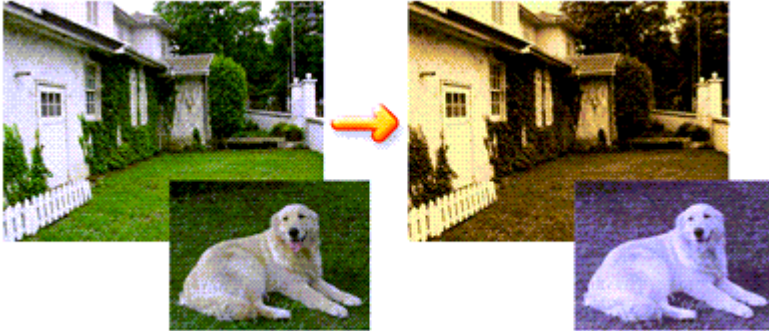

The procedure for performing Monochrome Effects is as follows:

1. Open the **printer driver setup window**
2. Set Monochrome Effects

Check the Monochrome Effects check box on the Effects tab and select your desired color.

If you use Select Color, move the Color slider to specify the color you want.

The current settings are displayed in the Settings Preview on the left side of the printer driver.

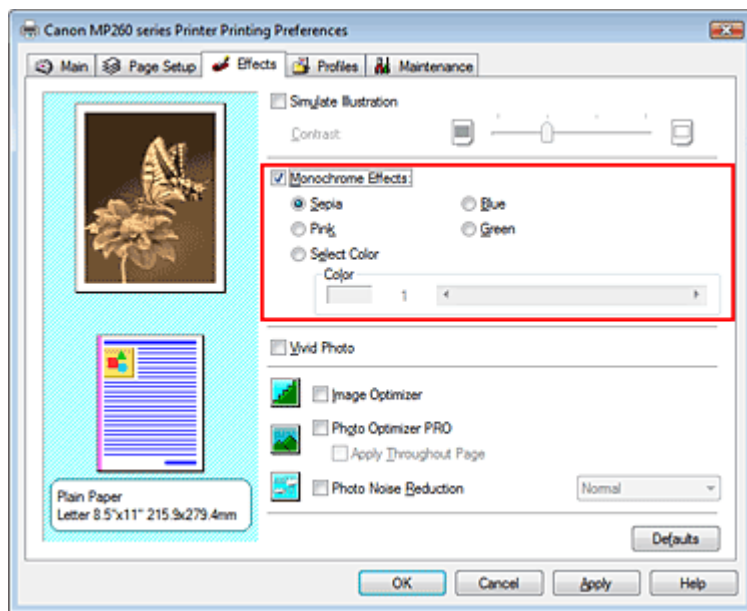

3. Complete the setup

Click OK.

When you execute print, the image will be printed with a single color.

Important

- When the Grayscale Printing check box on the Main tab is checked, Monochrome Effects appears grayed out and is unavailable.

[Page top](#) ↑

Advanced Guide

Advanced Guide > Printing from a Computer > Printing with Other Application Software > Changing the Print Quality and Correcting Image Data > Presenting Image Data with Vivid Colors

Presenting Image Data with Vivid Colors

The Vivid Photo function allows you to print image data with vivid colors. The notable feature of Vivid Photo is that it emphasizes the colors in background sceneries while maintaining the human skin color natural. By using this function, you can make vivid hues appear even more vivid.

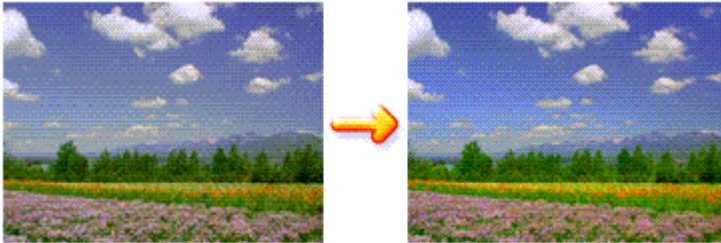

The procedure for performing Vivid Photo is as follows:

1. Open the **printer driver setup window**
2. Set Vivid Photo

Check the Vivid Photo check box on the Effects tab.

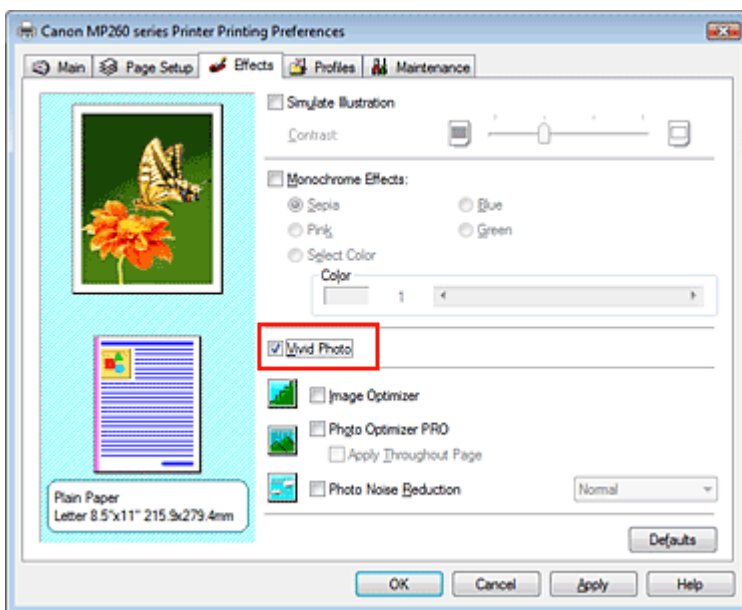

3. Complete the setup

Click OK.

When you execute print, the image will be printed with vivid colors.

[Page top](#) ↑

Advanced Guide

Advanced Guide > Printing from a Computer > Printing with Other Application Software > Changing the Print Quality and Correcting Image Data > Smoothing Jagged Outlines

Smoothing Jagged Outlines

The Image Optimizer function allows you to smooth jagged outlines in photos and graphics that have been enlarged with your application. This feature is especially useful when printing low-resolution images from Web pages.

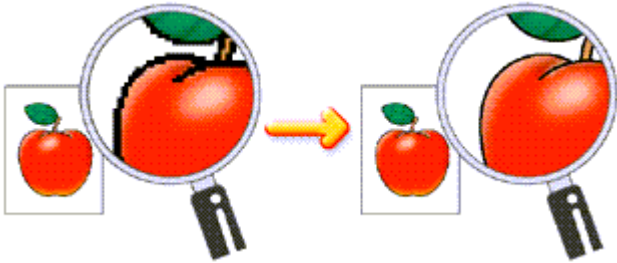

The procedure for performing Image Optimizer is as follows:

1. Open the [printer driver setup window](#)
2. Perform Image Optimizer

Check the Image Optimizer check box on the Effects tab.

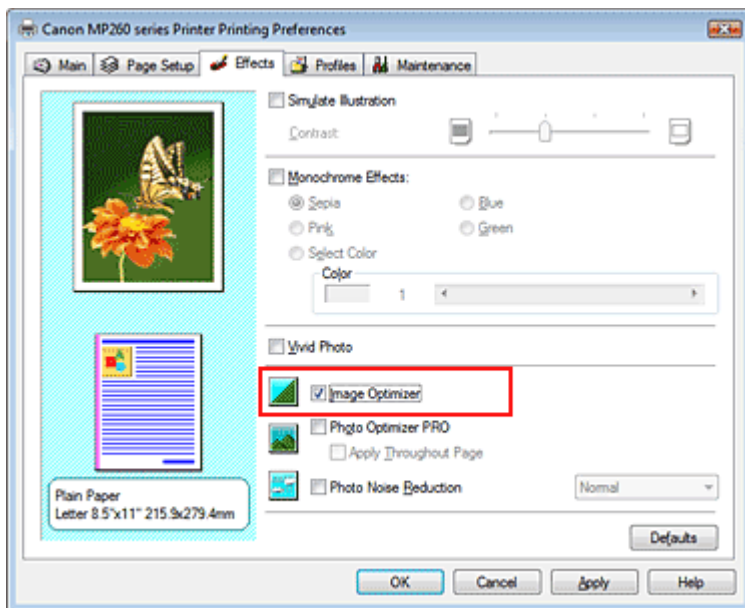

3. Complete the setup

Click OK.

The photos and graphics will be printed with jagged outlines smoothed.

Note

- Depending on application software or resolution of image data, the Image Optimizer may have no discernible effects.
- It may take longer to complete printing if the Image Optimizer is used.

[Page top](#) ↑

Advanced Guide

Advanced Guide > Printing from a Computer > Printing with Other Application Software > Changing the Print Quality and Correcting Image Data > Changing Color Properties to Improve Coloration

Changing Color Properties to Improve Coloration

The Photo Optimizer PRO function corrects colors of digital camera images or scanned images. It is specially designed to compensate for color shift, overexposure, and underexposure.

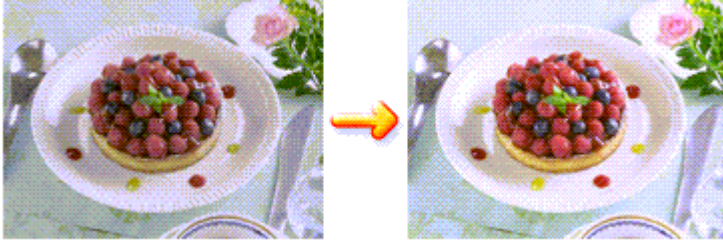

The procedure for performing Photo Optimizer PRO is as follows:

1. Open the printer driver setup window
2. Set the Auto Photo mode

Check the Photo Optimizer PRO check box on the Effects tab.

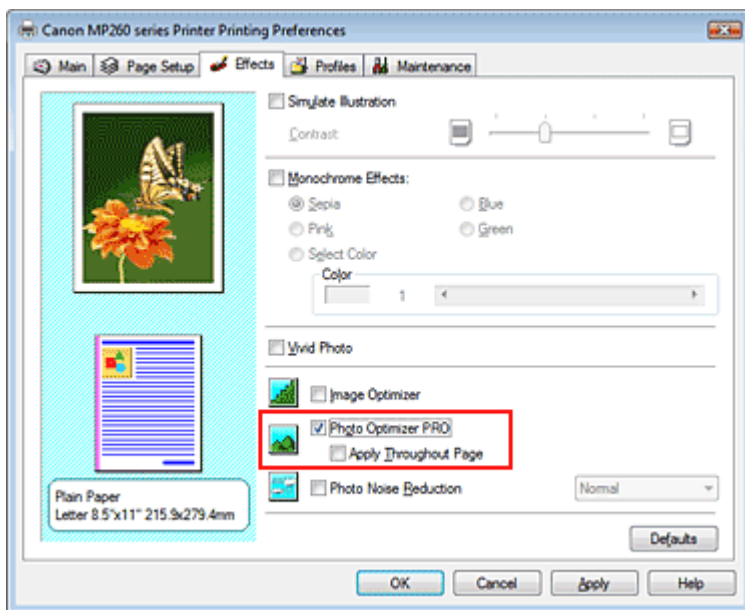

Normally there is no need to check the Apply Throughout Page check box. Images within each page are optimized on an image-by-image basis.

Note

- Check the Apply Throughout Page check box when printing image data that has been processed, such as being cropped or rotated. In this case the entire page will be treated as a single image to be optimized.

3. Complete the setup

Click OK.

When you execute print, the images will be printed with color compensation.

Important

- Photo Optimizer PRO does not function when:
 - Background is set in the Stamp/Background dialog box on the Page Setup tab.
 - Define Stamp... is selected in the Stamp/Background dialog box on the Page Setup tab, and the bitmapped stamp is configured.

 **Note**

- Depending on images, the Photo Optimizer PRO may have no discernible effect.
-

[Page top](#) ↑

Advanced Guide

Advanced Guide > Printing from a Computer > Printing with Other Application Software > Changing the Print Quality and Correcting Image Data > Reducing Photo Noise

Reducing Photo Noise

With the Photo Noise Reduction function, you can reduce the digital camera noise and improve the image quality of the digital print.

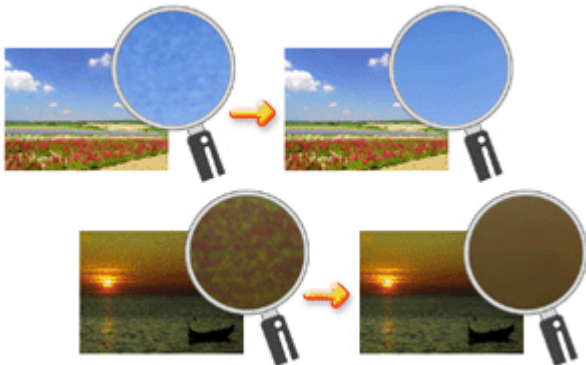

The procedure for performing Photo Noise Reduction is as follows:

1. Open the [printer driver setup window](#)
2. Set Photo Noise Reduction

Check the Photo Noise Reduction check box on the Effects tab and select Normal or Strong for the level.

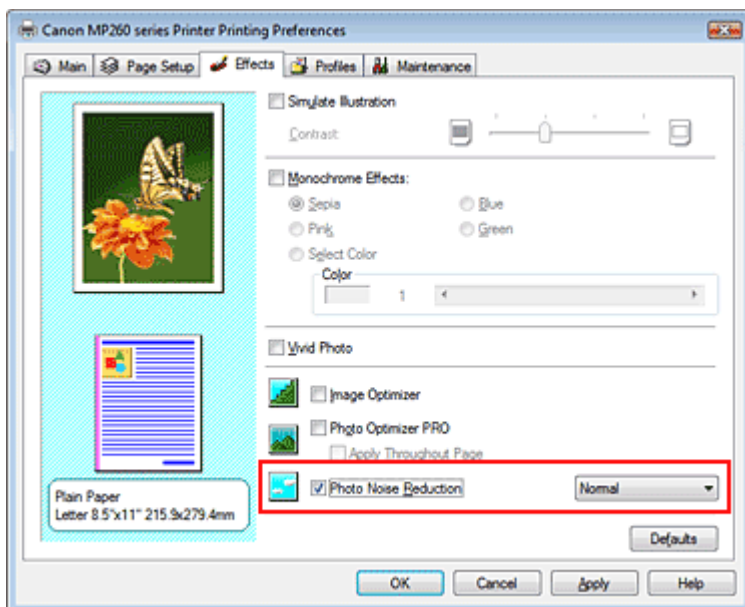

3. Complete the setup

Click OK.

When you execute print, the image will be printed with the digital camera noise being reduced.

Note

- It is recommended to select Normal for most cases. Select Strong if you have selected Normal and the noise still bothers you.
- Depending on application software or resolution of image data, effects of digital camera noise reduction may not be obvious.
- When this function is used for other than photos taken by digital cameras, image may be distorted.

Advanced Guide

[Advanced Guide](#) > [Printing from a Computer](#) > [Printing with Other Application Software](#) > [Overview of the Printer Driver](#)
> [Overview of the Printer Driver](#)

Overview of the Printer Driver

- [Canon IJ Printer Driver](#)
- [How to Open the Printer Driver Setup Window](#)
- [Maintenance Tab](#)
- [Canon IJ Status Monitor](#)
- [The Canon IJ Preview](#)

[Page top](#) ↕

Advanced Guide

[Advanced Guide](#) > [Printing from a Computer](#) > [Printing with Other Application Software](#) > [Overview of the Printer Driver](#)
> [Canon IJ Printer Driver](#)

Canon IJ Printer Driver

The Canon IJ printer driver is software that is installed on your computer for printing data on this machine.

The Canon IJ printer driver converts the print data created by your Windows application into data that your printer can understand and sends the converted data to the printer.

Because the format of print data varies depending on the your model, you need to have a Canon IJ printer driver for the specific model you are using.

How to Use Help

You can display the Help describing the driver setting items through the Printing Preferences screen of the Canon IJ printer driver.

- **To view all descriptions of a tab...**

Click the Help button on each tab.

A description for each item on the tab appears.

You can also display a description for a dialog box by clicking the link that appears on the corresponding tab.

- **To see a description for each item...**

Right-click the item you want to learn about and then click the Help button.

Alternatively, click  [Help] button at the right end of the title bar and then click the item you want to learn about.

A description of the item is displayed.

Related Topic

➔ [How to Open the Printer Driver Setup Window](#)



[Page top](#) ↑

Advanced Guide

Advanced Guide > Printing from a Computer > Printing with Other Application Software > Overview of the Printer Driver > Canon IJ Printer Driver > How to Open the Printer Driver Setup Window

How to Open the Printer Driver Setup Window

The printer driver setup window can be displayed through the application software in use or the Start menu of the Windows.

Note

- This guide mainly describes operations on the Windows Vista. Operations may differ depending on versions of the Windows.

Open the Printer Driver Setup Window through the Application Software

Follow the procedure below to configure print settings when printing.

1. Select the command you perform printing on the application software in use

In general, select Print on the File menu to open the Print dialog box.

2. Select your model name and click Preferences (or Properties)

The printer driver setup window appears.

Note

- Depending on application software you use, command names or menu names may vary and there may be more steps. For details, refer to the user's manual of your application software.

Open the Printer Driver Setup Window through the Start Menu

Follow the procedure below to perform maintenance operations such as print head cleaning, or to configure print settings that are common for all application software.

1. Select items from the Start menu as shown below:

- In Windows Vista, select the Start menu -> Control Panel -> Hardware and Sound -> Printers.
- In Windows XP, select the Start menu -> Control Panel -> Printers and Other Hardware -> Printers and Faxes.
- In Windows 2000, select the Start menu -> Settings -> Printers.

2. Right-click your model name icon, and then select Printing Preferences from the displayed menu.

The printer driver setup window appears.

Important

- Opening the printer driver setup window through Properties displays such tabs regarding the Windows functions as the Ports (or Advanced) tab. Those tabs do not appear when opening through Printing Preferences or application software. About tabs regarding Windows functions, refer to the user's manual for the Windows.



[Page top](#) ↑

Advanced Guide

Advanced Guide > Printing from a Computer > Printing with Other Application Software > Overview of the Printer Driver > Canon IJ Printer Driver > Maintenance Tab

Maintenance Tab

The Maintenance tab allows you to perform machine maintenance or change the settings of the machine.

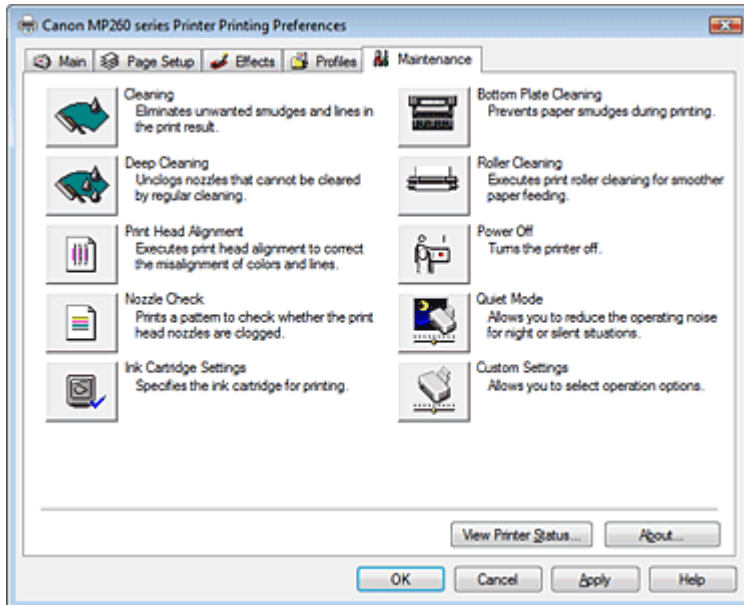

Features

- ➔ Cleaning the Print Heads
- ➔ Cleaning the Paper Feed Rollers
- ➔ Aligning the Print Head Position
- ➔ Checking the Print Head Nozzles
- ➔ Cleaning Inside the Machine
- ➔ Setting the Ink Cartridge
- ➔ Managing the Machine Power

Related features

- ➔ Reducing the Machine Noise/Quiet Mode
- ➔ Changing the Machine Operation Mode



[Page top](#) ↑

Advanced Guide

Advanced Guide > Printing from a Computer > Printing with Other Application Software > Overview of the Printer Driver > Canon IJ Status Monitor

Canon IJ Status Monitor

The Canon IJ Status Monitor is an application software that shows the status of the printer and the progress of printing on the Windows screen. You will know the status of the printer with graphics, icons, and messages.

Launching the Canon IJ Status Monitor

The Canon IJ Status Monitor launches automatically when data is sent to the printer. When launched, the Canon IJ Status Monitor appears as a button on the Task Bar.



Click the Status Monitor button displayed on the Task Bar. The Canon IJ Status Monitor appears.

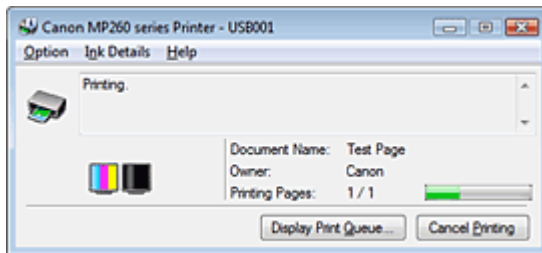

Note

- To open the Canon IJ Status Monitor when the printer is not printing, open the [printer driver setup window](#) and click View Printer Status... on the Maintenance tab.

When Errors Occur

The Canon IJ Status Monitor is automatically displayed when an error occurs (e.g., if the printer runs out of paper or if the ink is low).

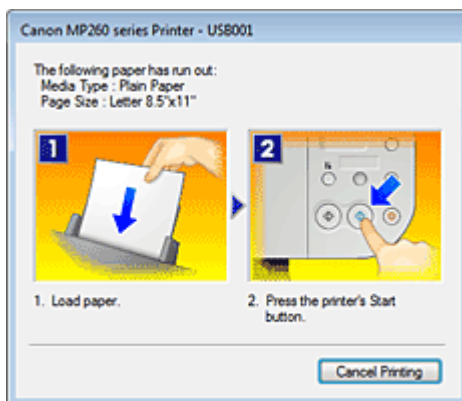

In such cases, take the appropriate action as described.

[Page top](#) ↑

Advanced Guide

[Advanced Guide](#) > [Printing from a Computer](#) > [Printing with Other Application Software](#) > [Overview of the Printer Driver](#)
> [The Canon IJ Preview](#)

The Canon IJ Preview

The Canon IJ Preview is an application software that displays what the print result will look like before a document is actually printed.

The preview reflects the information that is set within the printer driver and allows you to check the document layout, print sequence, and number of pages. You can also change the media type settings.

If you want to display a preview before printing, open the [printer driver setup window](#), click the Main tab, and check the Preview before printing check box.

If you do not want to display a preview before printing, uncheck the check box.

Related Topic

➔ [Displaying the Print Results before Printing](#)

[Page top](#) ↑

Advanced Guide

Advanced Guide > Printing Using the Operation Panel of the Machine

Printing Using the Operation Panel of the Machine

➔ Copying

[Page top](#) ↕

Advanced Guide

Advanced Guide > Printing Using the Operation Panel of the Machine > Copying

Copying

- ➔ Making Copies
- ➔ Using Useful Copy Functions

[Page top](#) ↑

Advanced Guide

Advanced Guide > Printing Using the Operation Panel of the Machine > Copying > Making Copies

Making Copies

For the basic procedure to make copies, refer to [Copying](#).

- ➔ [Reducing or Enlarging a Copy](#)
- ➔ [Using Useful Copy Functions](#)

[Page top](#) ↕

Advanced Guide

Advanced Guide > Printing Using the Operation Panel of the Machine > Copying > Making Copies > Reducing or Enlarging a Copy

Reducing or Enlarging a Copy

1. Make sure that the machine is turned on.
2. Load plain paper on the Rear Tray.
3. Load the original document on to the Platen Glass.
4. Press the **Paper** button to select Plain paper.



Note

- You can switch the size of paper loaded on the Rear Tray between A4 and Letter. ➔ [Switching the Page Size between A4 and Letter](#)

5. Press the **Fit to Page** button.

The **Fit to Page** lamp lights up. To cancel the Fit to Page copying, press the **Fit to Page** button again.



Note

- You can use the **Fit to Page** button only when you are using the copy function.
- Copied images are automatically reduced or enlarged in the lengthwise/widthwise direction to fit the page size you select.

6. Press the **+** button repeatedly to specify the number of copies.



Note

- By pressing the **+** button repeatedly, F will be displayed on the LED. The number of copies will be set as 20.
- When you want to make 10 to 19 copies, specify the number of copies to 20, then load the same number of pieces of paper. In this case, the machine will stop copying in an error. Press the **Stop/Reset** button to release the error.
- Pressing the **Stop/Reset** button returns the number of copies to 1.

7. Press the **Color** button for color copying, or the **Black** button for black & white copying.

The machine starts fit-to-page copying.

• To make high speed copies

1. Hold down the **Color** or **Black** button for longer than 2 seconds.

The LED flashes once.

2. Release the button.

The machine starts high speed copying.



Important

- Do not open the Document Cover or remove the original from the Platen Glass until copying is complete.



Note

- High speed copying is suitable for printing text-only documents on plain paper. If the quality is not as good as expected, try normal copying.
- When you want to make 10 to 19 copies, specify the number of copies to 20, then load the same number of pieces of paper. In this case, the machine will stop copying in an error. Press

the **Stop/Reset** button to release the error.

- To cancel copying, press the **Stop/Reset** button.
-

[Page top ↑](#)

Advanced Guide

[Advanced Guide](#) > [Printing Using the Operation Panel of the Machine](#) > [Copying](#) > [Using Useful Copy Functions](#)

Using Useful Copy Functions

- **Borderless Copy**

You can copy images so that they fill the entire page without borders.

➔ [Copying without Borders \(Borderless Copy\)](#)

[Page top](#) ↕

Advanced Guide

Advanced Guide > Printing Using the Operation Panel of the Machine > Copying > Using Useful Copy Functions > Switching the Page Size between A4 and Letter

Switching the Page Size between A4 and Letter

You can switch the size of paper loaded on the Rear Tray between A4 and Letter.

1. Press the **Maintenance** button repeatedly until d appears.
2. Press the **Black** button to select A4, or the **Color** button to select Letter.



Note

- You can switch the size of paper selected when the machine is turned on between A4 and Letter.
-

[Page top](#) 

Advanced Guide

Advanced Guide > Printing Using the Operation Panel of the Machine > Copying > Using Useful Copy Functions > Copying without Borders (Borderless Copy)

Copying without Borders (Borderless Copy)

You can copy images so that they fill the entire page without borders.

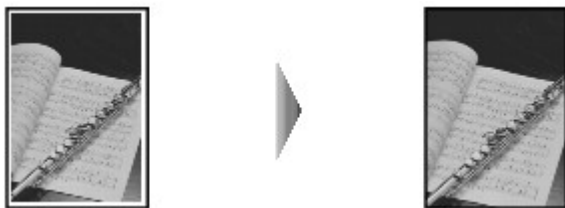

1. Load photo paper on the Rear Tray.
2. Press the **Paper** button to select the page size you loaded on the Rear Tray.

Note

- You can switch the size of paper loaded on the Rear Tray between A4 and Letter. → [Switching the Page Size between A4 and Letter](#)
- When Plain Paper is selected, borderless copying is not available.

3. Press the **Fit to Page** button.

The **Fit to Page** lamp lights up. To cancel the borderless copying, press the **Fit to Page** button again.

Note

- You can use the **Fit to Page** button only when you are using the copy function.
- Copied images are automatically reduced or enlarged to fit the page size you select for a borderless copy.

4. Press the **+** button repeatedly to specify the number of copies.

Note

- By pressing the **+** button repeatedly, F will be displayed on the LED. The number of copies will be set as 20.
- When you want to make 10 to 19 copies, specify the number of copies to 20, then load the same number of pieces of paper. In this case, the machine will stop copying in an error. Press the **Stop/Reset** button to release the error.
- Pressing the **Stop/Reset** button returns the number of copies to 1.

5. Press the **Color** button for color copying, or the **Black** button for black & white copying.

The machine starts borderless copying.

Important

- Do not open the Document Cover or remove the original from the Platen Glass until copying is complete.

Note

- Slight cropping may occur at the edges since the copied image is enlarged to fill the whole page.
- To cancel copying, press the **Stop/Reset** button.

[Page top](#) ↕

Advanced Guide

Advanced Guide > Scanning

Scanning

- ➔ [Scanning Images](#)
- ➔ [Scanning with the Bundled Application Software](#)
- ➔ [Scanning with Other Application Software](#)
- ➔ [Other Scanning Methods](#)

[Page top](#) ↑

Advanced Guide

Advanced Guide > Scanning > Scanning Images

Scanning Images

- ➔ Scanning Images
- ➔ Before Scanning
- ➔ Placing Documents
- ➔ Saving Scanned Data to PC Using the Operation Panel of the Machine
- ➔ Appendix: Various Scan Settings

[Page top](#) ↕

Advanced Guide

[Advanced Guide](#) > [Scanning](#) > [Scanning Images](#) > [Scanning Images](#)

Scanning Images

You can scan images from the machine to a computer without printing them and save them in popular image data, such as JPEG, TIFF, bitmap, or PDF. You can also save scanned images in PDF format on the memory card (MP260 series).

Select the scanning method according to your purpose.

- ➡ [Saving Scanned Data to PC Using the Operation Panel of the Machine](#)
- ➡ [Scanning with the Bundled Application Software](#)
- ➡ [Scanning with Other Application Software](#)

[Page top](#) ↑

Advanced Guide

[Advanced Guide](#) > [Scanning](#) > [Scanning Images](#) > [Before Scanning](#)

Before Scanning

Before scanning images, confirm the following:

- **Does the original to be scanned meet the requirements for an original to be set on the Platen Glass?**

If you save the data to PC, refer to [Placing Documents](#) for details. If you save the data to the Memory Card (MP260 series), refer to [Loading paper / Originals](#) for details.

[Page top](#) ↑

Advanced Guide

Advanced Guide > Scanning > Scanning Images > Placing Documents







Placing Documents

Learn how to place documents on the machine's Platen. Place documents correctly according to the type of document to be scanned. Otherwise, documents may not be scanned correctly.

Important

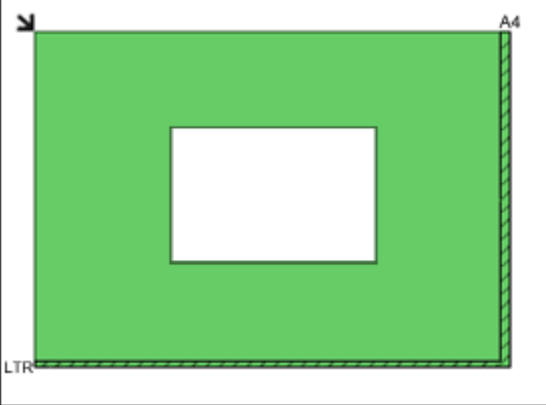
- Close the Document Cover when scanning documents.
- Place documents as described below to allow the machine to detect the document automatically.
When scanning by specifying the document size, always align an upper corner of the document with the corner at the arrow of the Platen, regardless of the document type.

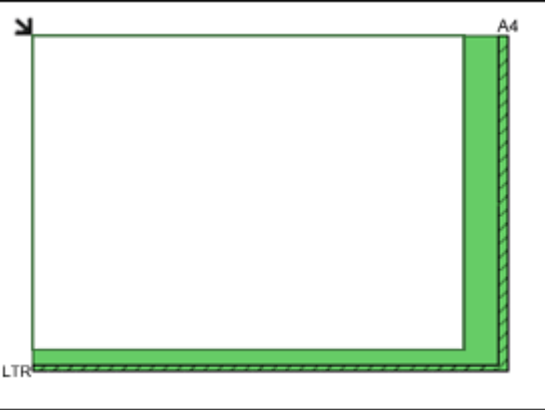
Placing Documents

When Scanning Photos, Hagaki, Business Cards or CD/DVD	When Scanning Magazines, Newspapers or Text Documents
 <p style="text-align: center;"></p> <p>Placing a Single Document</p> <p>Place the document face-down on the Platen, with 3/8 inches (1 cm) or more space between the edges of the Platen and the document.</p> 	 <p style="text-align: center;"></p> <p>Place the the document face-down and align correctly with the arrow/marks on the Platen.</p> 
<h3> Important</h3> <ul style="list-style-type: none"> If the document is large (such as an A4 photo) and cannot be placed away from the edges/arrow of the Platen, scan by specifying the file format. 	
<p>Placing Multiple Documents</p> <p>Allow 3/8 inches (1 cm) or more space between the edges of the Platen and documents, and between documents.</p>	

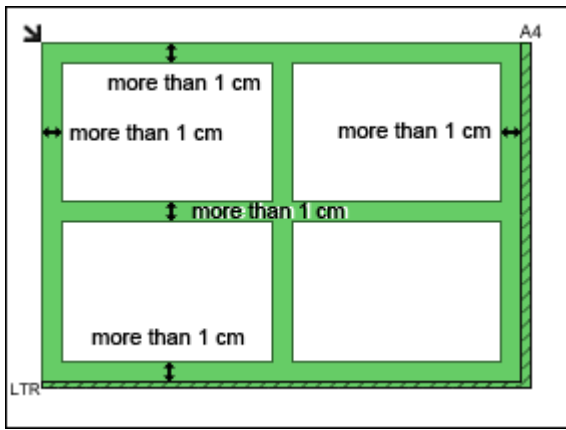
**Note**

- You can place up to 10 documents.
- Positions of slanted documents (10 degrees or less) are corrected automatically.

[Top of Page↑](#)

Advanced Guide

Advanced Guide > Scanning > Scanning Images > Saving Scanned Data to PC Using the Operation Panel of the Machine

Saving Scanned Data to PC Using the Operation Panel of the Machine

You can scan images using the Operation Panel of the Machine.

Important

- If the software (MP Navigator EX) is not yet installed, refer to your setup manual.

1. Prepare your computer before scanning.

You need to set MP Navigator EX as the starting application software in Image Capture under Applications of Mac OS X.

This operation is not necessary for Mac OS X v.10.4.x.

If you are using Mac OS X v.10.3.9:

Select Applications on the Go menu, then double-click the Image Capture icon. Click Options at the lower left of the scanner window, select MP Navigator EX 2 in Application to launch when the scanner button is pressed, then click OK. To quit Image Capture, select Quit Image Capture on the Image Capture menu.

Important

- If Options is not displayed, select Preferences on the Image Capture menu, click Scanner, and click Use TWAIN software whenever possible to clear the option. Then quit Image Capture and restart it.

2. Make sure that the machine is turned on.

3. Load the original on the Platen Glass.

Note

- Refer to [Placing Documents](#) for how to load the Original on the Platen Glass.

4. Press the **SCAN** button.

The settings configured from MP Navigator EX apply when scanning.

5. To specify MP Navigator EX 2.0

If you are using Windows Vista:

The program selection screen may be displayed after pressing the **SCAN** button. In this case, select MP Navigator EX Ver2.0 and click OK.

You can set MP Navigator EX to launch whenever pressing the **SCAN** button. For details, refer to [Selecting a Response to Commands from the Operation Panel Using MP Navigator EX](#).

If you are using Windows XP:

The program selection screen may be displayed after pressing the **SCAN** button for the first time. In this case, specify MP Navigator EX 2.0 as the application software to use, select Always use this program for this action, then click OK. From the next time, MP Navigator EX is automatically started.

Important

- If the position or size of an image is not scanned in correctly depending on the type of the original, refer to [Scanning Photos and Documents](#) and change the MP Navigator EX Document Type and Document Size settings to match the original being scanned.

• If You Want to Edit or Print the Scanned Images

MP Navigator EX enables you to edit the scanned images, such as optimizing or trimming.

You can also start application software from MP Navigator EX to edit or print the scanned images.

➔ [Let's Try Scanning](#)

• If You Want to Scan Originals with Advanced Settings

ScanGear enables you to scan originals with advanced settings such as the resolution.

➔ [Scanning with Advanced Settings Using ScanGear \(Scanner Driver\)](#)



Note

- You can use a TWAIN- or WIA- (Windows Vista and Windows XP only) compliant application software and the Control Panel (Windows Vista and Windows XP only) to scan originals with this machine.
For details, refer to [Other Scanning Methods](#).
-

[Page top](#) ↕

Advanced Guide

[Advanced Guide](#) > [Scanning](#) > [Scanning Images](#) > [Appendix: Various Scan Settings](#)

Appendix: Various Scan Settings

- **Specifying how to respond when scanning using the Operation Panel of the machine**
 - ➔ [Selecting a Response to Commands from the Operation Panel Using MP Navigator EX](#)

[Top of Page](#)↑

Advanced Guide

Advanced Guide > Scanning > Scanning Images > Appendix: Various Scan Settings > Selecting a Response to Commands from the Operation Panel Using MP Navigator EX

Selecting a Response to Commands from the Operation Panel Using MP Navigator EX

MP Navigator EX enables you to specify the response resulting from pressing the Color Start or Black Start button on the machine. You can specify the response individually for each event.

1. Start MP Navigator EX.

➔ Starting MP Navigator EX

2. Click Preferences.

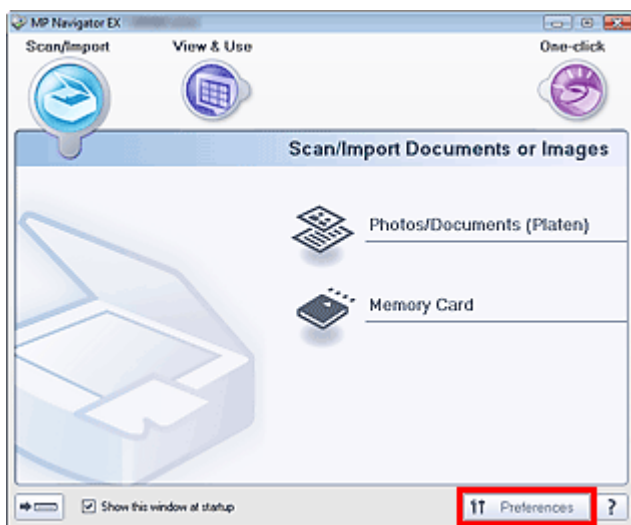

The Preferences dialog box opens.

Note

- The Preferences dialog box can also be opened by clicking Preferences in the One-click Mode screen.

3. On the Scanner Button Settings tab, specify Actions.

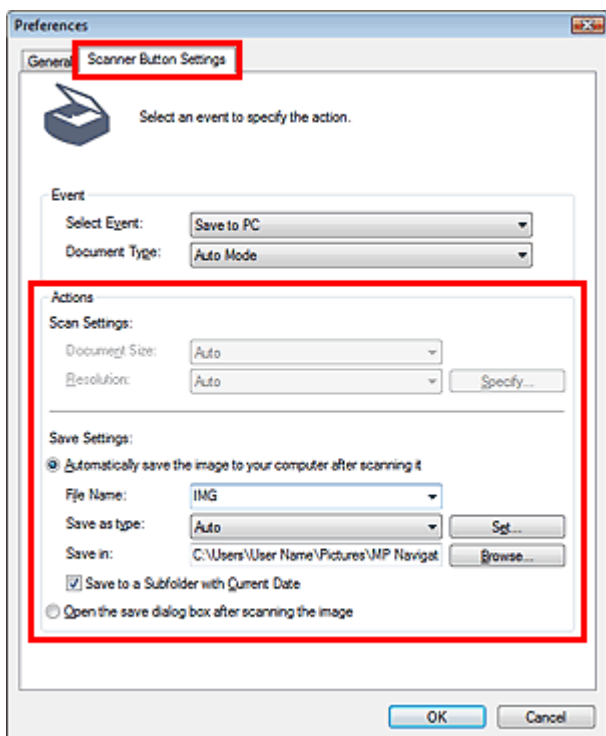



Note

- See the section below for details.
 - ➔ [Scanner Button Settings Tab \(Save\)](#)

4. Click OK.

The operation will be performed according to the settings when you press the Color Start or Black Start button on the machine.

[Top of Page](#)↑

Advanced Guide

[Advanced Guide](#) > [Scanning](#) > [Scanning with the Bundled Application Software](#)

Scanning with the Bundled Application Software

- ➡ [What Is MP Navigator EX \(Supplied Scanner Software\)?](#)
- ➡ [Let's Try Scanning](#)
- ➡ [Useful MP Navigator EX Functions](#)
- ➡ [Utilizing Images in MP Navigator EX](#)
- ➡ [MP Navigator EX Screens](#)
- ➡ [Appendix: Opening Files Other than Scanned Images](#)

[Page top](#) ↑

Advanced Guide

Advanced Guide > Scanning > Scanning with the Bundled Application Software > What Is MP Navigator EX (Supplied Scanner Software)?

What Is MP Navigator EX (Supplied Scanner Software)?

MP Navigator EX is an application that enables you to easily scan photos and documents. It is suitable even for beginners.

What You Can Do with this Software

This software allows you to scan multiple documents at one time, or scan images larger than the Platen. You can also save scanned images, attach them to e-mail or print them using the supplied applications.

Screens

Main Menus

There are two types of MP Navigator EX Main Menu: Navigation Mode screen and One-click Mode screen.

Navigation Mode Screen

You can start various tasks from the Navigation Mode screen, including simple scanning, scanning using ScanGear (scanner driver), and enhancing/correcting images.

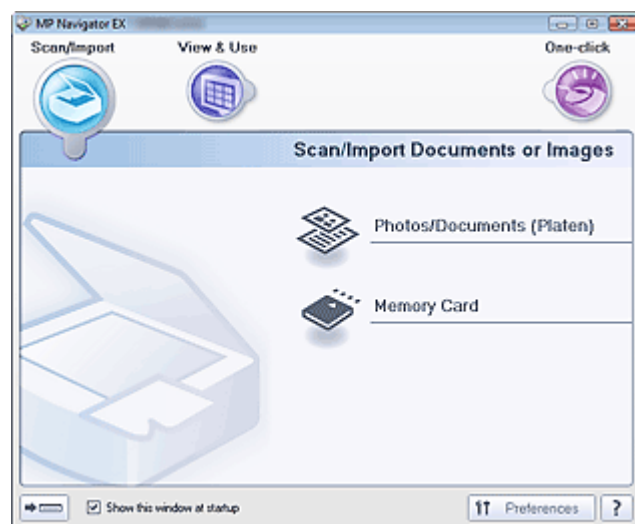

One-click Mode Screen

You can complete from scanning to saving, etc. at one time by simply clicking the corresponding icon on the One-click Mode screen.

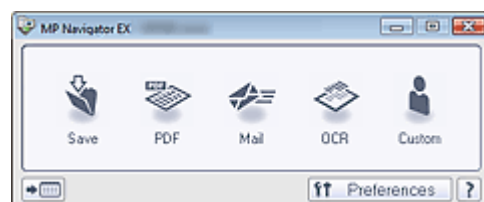

Note

- Click  (Switch Mode) to switch to the Navigation Mode screen.

Scan/Import Window

Use the Scan/Import window to scan photos and documents, or import images saved on memory cards.

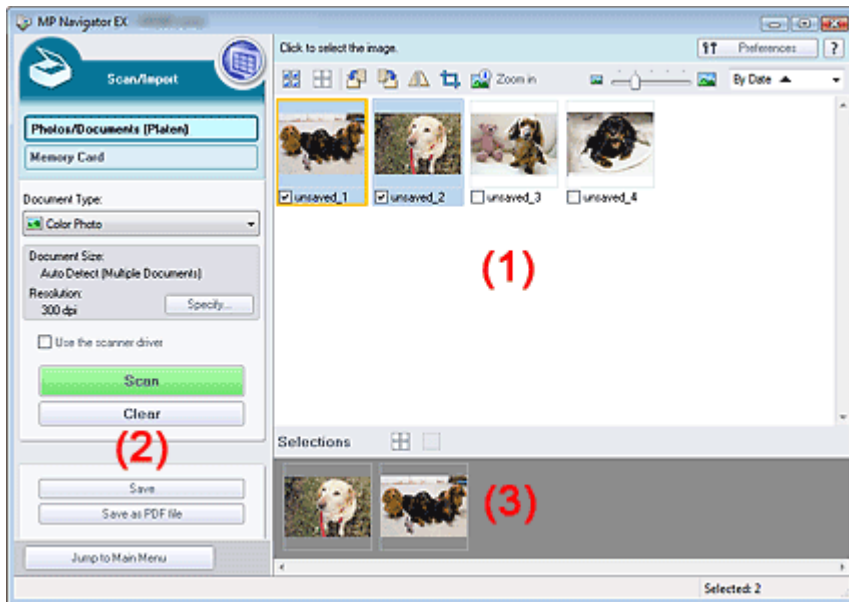

(1) Thumbnail Window

Thumbnails of scanned images are displayed.

(2) Settings and Operation Buttons

Customize scan settings, start scanning, save, etc.

(3) Selected Images Area

Thumbnails of the selected images are displayed.

View & Use Window

Use the View & Use window to select what you want to do with the scanned images.

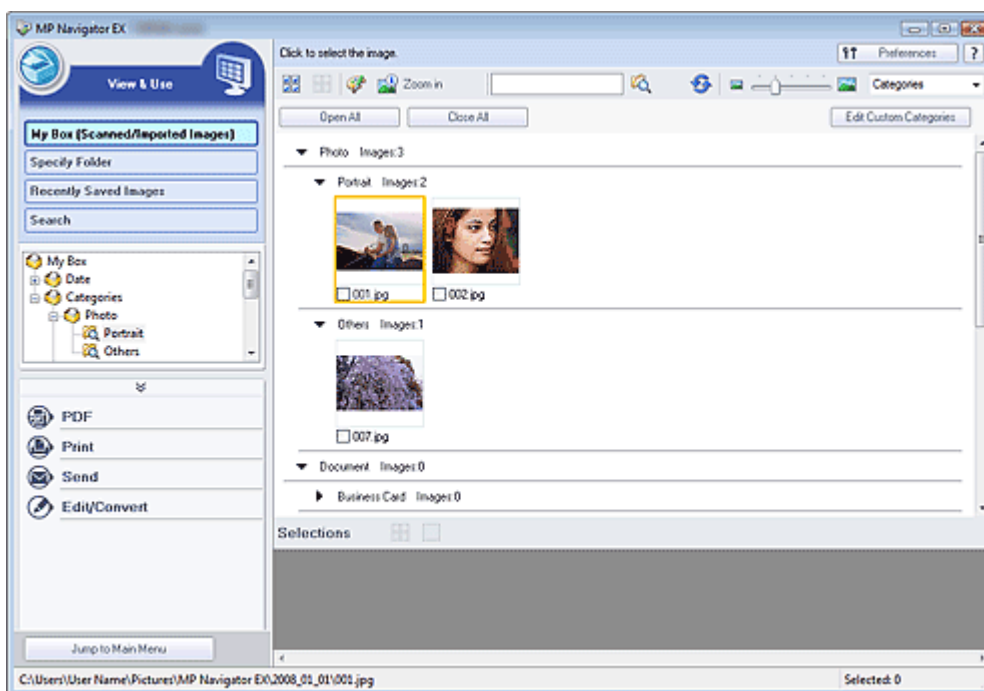

Note

- MP Navigator EX may not start from a button on the machine. In that case, restart the computer.

[Top of Page↑](#)

Advanced Guide

[Advanced Guide](#) > [Scanning](#) > [Scanning with the Bundled Application Software](#) > [Let's Try Scanning](#)

Let's Try Scanning

Try scanning using MP Navigator EX.

- **Starting MP Navigator EX**
 - ➔ [Starting MP Navigator EX](#)
- **Scanning documents, photos, magazines, etc. from the Platen**
 - ➔ [Scanning Photos and Documents](#)
- **Scanning two or more photos (small documents) at one time**
 - ➔ [Scanning Multiple Documents at One Time](#)
- **Scanning images larger than the Platen**
 - ➔ [Scanning Images Larger than the Platen \(Stitch Assist\)](#)
- **Scanning easily according to purpose (scan and save, attach to e-mail, etc.)**
 - ➔ [Easy Scanning with One-click](#)

[Top of Page](#)↑

Advanced Guide

Advanced Guide > Scanning > Scanning with the Bundled Application Software > Let's Try Scanning > Starting MP Navigator EX

Starting MP Navigator EX

Starting MP Navigator EX



1. Double-click  MP Navigator EX 2.0 icon on the desktop.
MP Navigator EX starts.



Note

- Alternatively, from the Start menu, select (All) Programs > Canon Utilities > MP Navigator EX 2.0 > MP Navigator EX 2.0.

Switching between Navigation Mode screen and One-click Mode screen

1. Click  or  at the bottom left of the screen.
The mode switches.

Navigation Mode Screen (Click  in One-click Mode Screen)

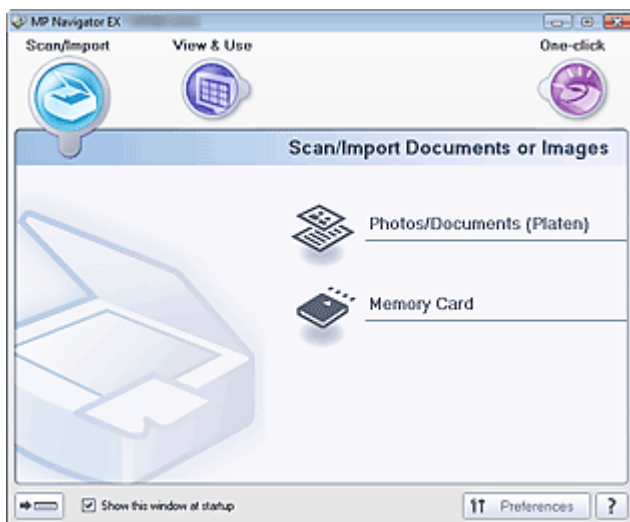

One-click Mode Screen (Click  in Navigation Mode Screen)

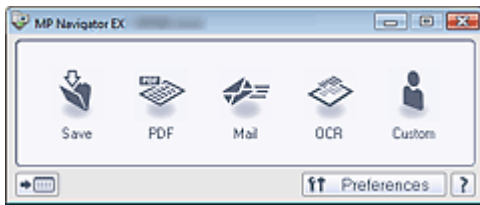

Note

- Select the Show this window at startup checkbox in the Navigation Mode screen to always open the Navigation Mode screen at startup. If this checkbox is not selected, the last used screen appears at startup.
-

[Top of Page](#)↑

Advanced Guide

Advanced Guide > Scanning > Scanning with the Bundled Application Software > Let's Try Scanning > Scanning Photos and Documents

Scanning Photos and Documents

Scan photos and documents placed on the Platen.

1. Start MP Navigator EX and open the Navigation Mode screen.

➔ Starting MP Navigator EX

2. Point to Scan/Import and click Photos/Documents (Platen).

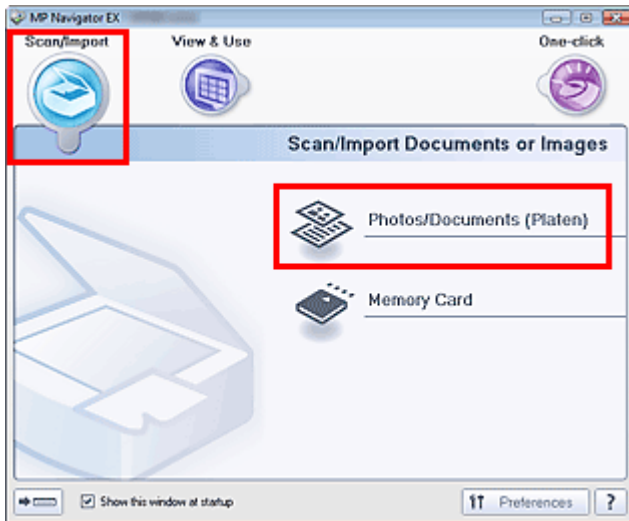

3. Place the document on the Platen, then select Document Type.

➔ Placing Documents

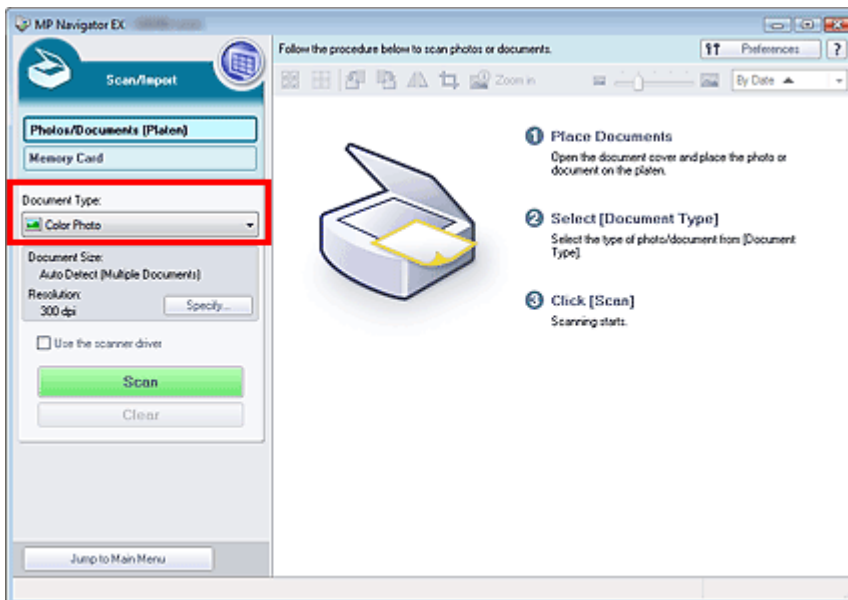

Note

- When you select Magazine(Color), the Descreen function will be enabled and scanning takes longer than usual. To disable the Descreen function, deselect the Descreen checkbox in the Scan Settings dialog box.
- Select Text(OCR) to extract the text in the image and convert to editable text.

4. Click Specify... and specify the document size and resolution as required.

The [Scan Settings Dialog Box \(Photos/Documents\)](#) opens.

 **Note**

- If the document is large (such as an A4 photo) and cannot be placed away from the edges/arrow of the Platen, specify the document size in the Scan Settings dialog box.

5. Click Scan.

Scanning starts.

When scanning is completed, the Scan Complete dialog box opens. Select Scan or Exit. Select Scan to scan the next document, or select Exit to end.

The scanned images appear in the Thumbnail window.

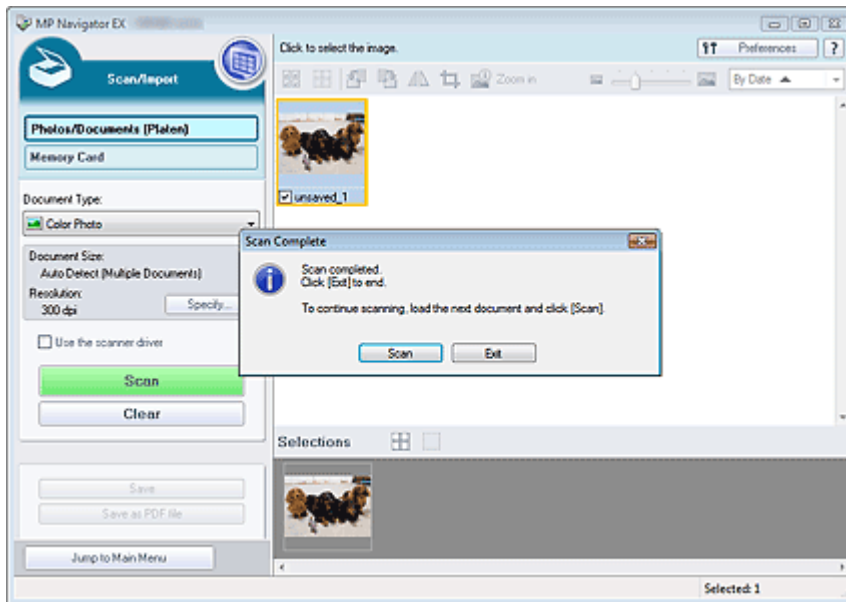
**6. Edit the scanned images as required.**

Use Edit Tools to rotate images, select a part of an image, etc.

See the Edit Tools in "[Photos/Documents \(Platen\) Screen \(Scan/Import Window\)](#)" for details.

 **Note**

- First select images to edit. (Selected images are outlined in orange.) Drag the mouse or use Shift + arrow keys to select multiple images.

7. Save the scanned images.

➔ Saving

➔ Saving as PDF Files

[Top of Page](#)↑

Advanced Guide

Advanced Guide > Scanning > Scanning with the Bundled Application Software > Let's Try Scanning > Scanning Multiple Documents at One Time

Scanning Multiple Documents at One Time

You can scan two or more photos (small documents) at one time by setting Document Size to Auto Detect (Multiple Documents) in the Scan Settings dialog box of MP Navigator EX.

Important

- The following types of documents cannot be cropped correctly.
 - Documents smaller than 1.18 inches (3 cm) square.
 - Photos that have been cut to various shapes.
 - The following types of documents may not be cropped correctly. In that case, start ScanGear (scanner driver), then adjust the cropping frame in Advanced Mode tab and scan again.
 - Photos that have a whitish border.
 - Documents printed on white paper, hand-written text, business cards, etc.
 - Thin documents
 - Thick documents
- ➔ [Scanning in Advanced Mode](#)

1. Place the document on the Platen.

➔ [Placing Documents](#)

2. Start MP Navigator EX and open the Navigation Mode screen.

➔ [Starting MP Navigator EX](#)

3. Point to Scan/Import and click Photos/Documents (Platen).

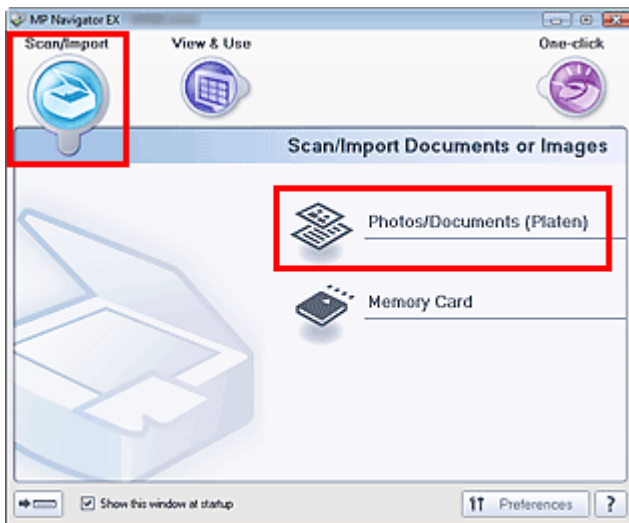

4. Select Document Type according to the document to be scanned.

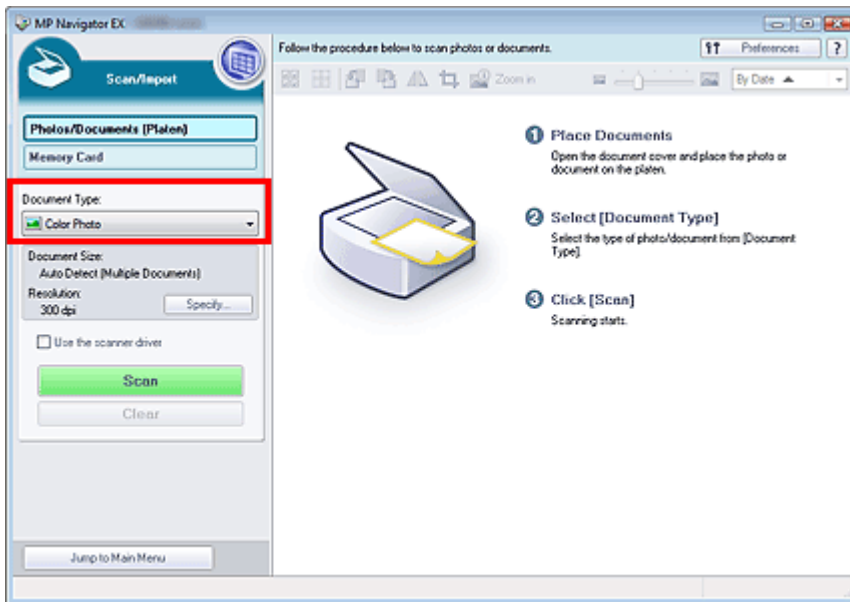

5. Click Specify....

The Scan Settings Dialog Box (Photos/Documents) opens.

6. Select Auto Detect (Multiple Documents) for Document Size and click OK.

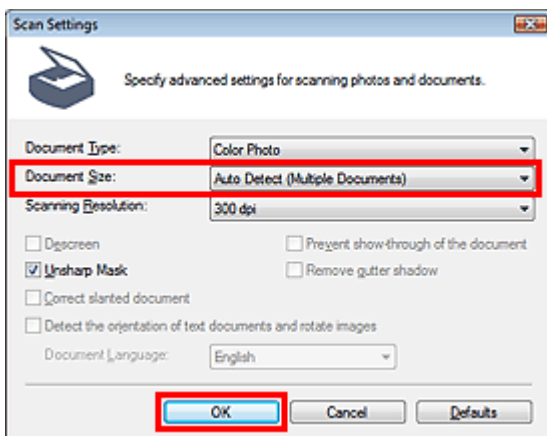

7. Return to the Scan/Import window and click Scan.

Multiple documents are scanned at one time.

When scanning is completed, the Scan Complete dialog box opens. Select Scan or Exit. Select Scan to scan the next document, or select Exit to end.

The scanned images appear in the Thumbnail window.

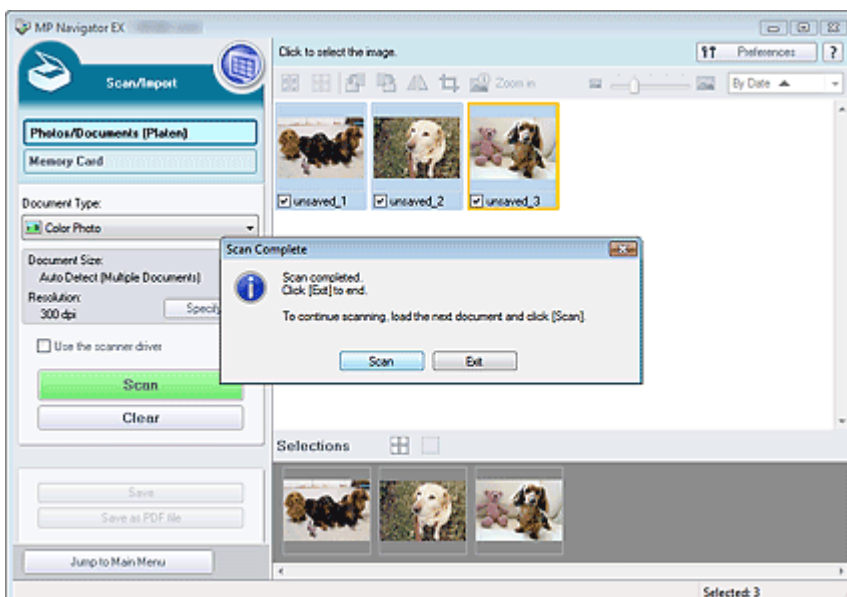

8. Edit the scanned images as required.

Use Edit Tools to rotate images, select a part of an image, etc.

See the Edit Tools in " [Photos/Documents \(Platen\) Screen \(Scan/Import Window\)](#) " for details.



Note

- First select images to edit. (Selected images are outlined in orange.) Drag the mouse or use Shift + arrow keys to select multiple images.
-

9. Save the scanned images.

➔ [Saving](#)

➔ [Saving as PDF Files](#)



Note

- See "[Scanning Multiple Documents at One Time in Advanced Mode](#) " to preview and scan multiple documents at one time.
-

[Top of Page](#)↑

Advanced Guide

Advanced Guide > Scanning > Scanning with the Bundled Application Software > Let's Try Scanning > Scanning Images Larger than the Platen (Stitch Assist)

Scanning Images Larger than the Platen (Stitch Assist)

Stitch Assist allows you to scan the left and right halves of a large document separately and combine the scanned images back into one image. You can scan documents that are up to twice as large as the Platen.

1. Start MP Navigator EX and open the Navigation Mode screen.

➔ Starting MP Navigator EX

Note

- You can complete from scanning to saving, etc. at one time by simply clicking the corresponding icon on the One-click Mode screen. Stitch Assist is available from the One-click Mode screen as well, by changing the document size. Click the corresponding icon and select Stitch Assist for Document Size. Then skip ahead to Step 5.

2. Point to Scan/Import and click Photos/Documents (Platen).

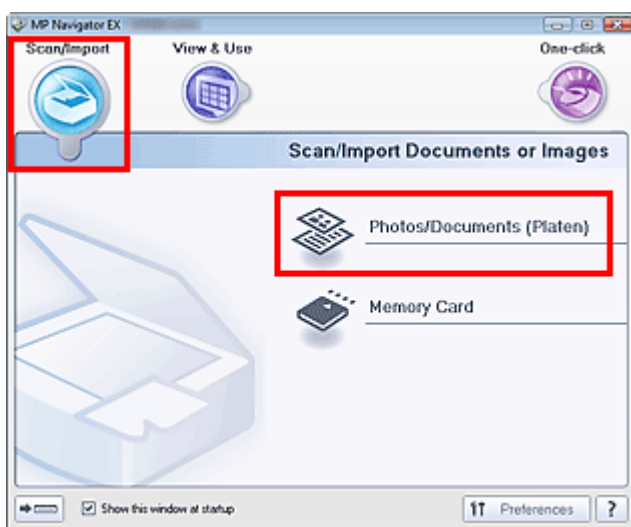

3. Select Document Type according to the document to be scanned.

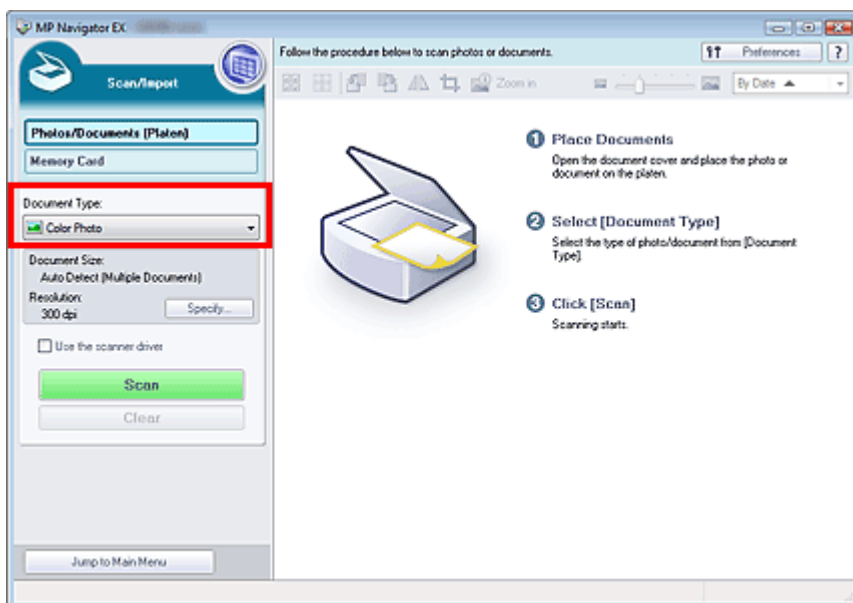

4. Click Specify....

The Scan Settings Dialog Box (Photos/Documents) opens.

Select Stitch Assist for Document Size, then specify Scanning Resolution as required.

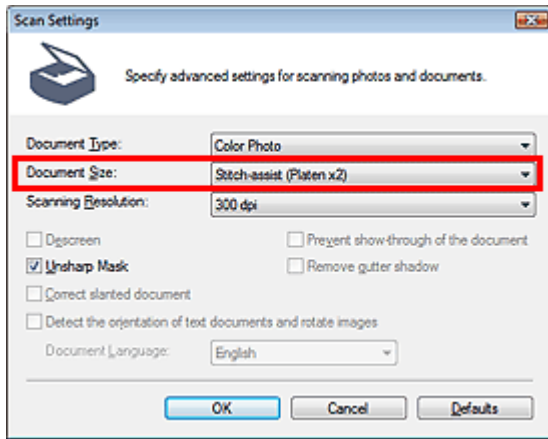

5. Return to the Scan/Import window and click Scan.

The Stitch-assist window opens.

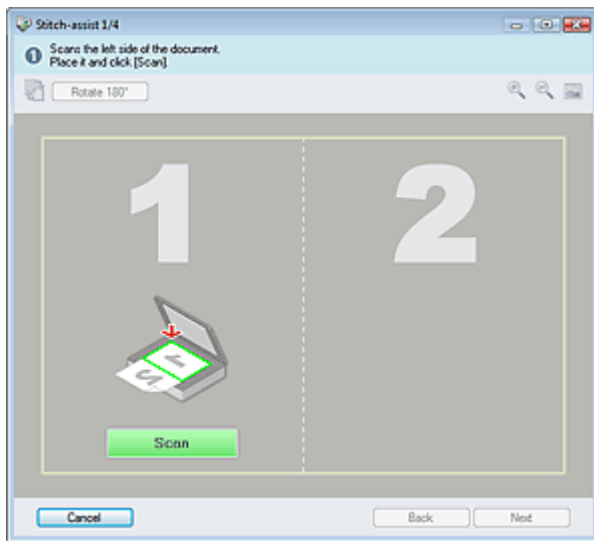

6. Place the left half of the document face-down on the Platen.

7. Click Scan.

The left half of the document is scanned and appears in the Stitch-assist window.



8. Place the right half of the document face-down on the Platen.

9. Click Scan.

The right half of the document is scanned.

10. Adjust the scanned image as required.

Use the icons to swap the left and right halves, rotate the image 180 degrees or enlarge/reduce the image.

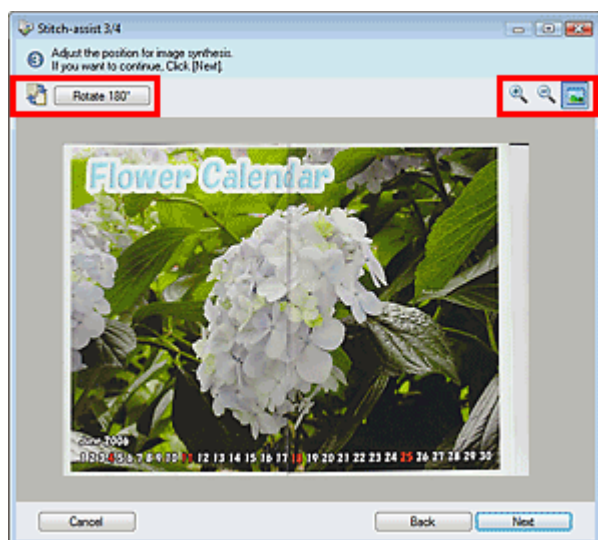

- 
(Swap Left & Right)
 Swaps the left and right halves.

Important

- This function is not available while the image is enlarged/reduced.

- 
Rotate 180°
 Rotates the image 180 degrees.

Important

- This function is not available while the image is enlarged/reduced.

- 
(Enlarge)
 Enlarges the displayed image.

- 
(Reduce)
 Reduces the displayed image.

- 
(Full-screen)
 Enlarges/reduces the image to display it full-screen.

Note

- Enlarge/Reduce/Full Screen does not affect the actual size of the scanned image.
- When the document is scanned upside down, the image displayed in the Stitch-assist window will also be upside down. Click Rotate 180° to rotate the image to the correct orientation.
- You can drag the right half of the image from right to left or up and down to adjust the position.
- If the left and right halves do not match due to a slanted document, place the document correctly and click Back, then scan again.

11. Click Next.

12. Drag the mouse to specify the area to be saved, then click OK.

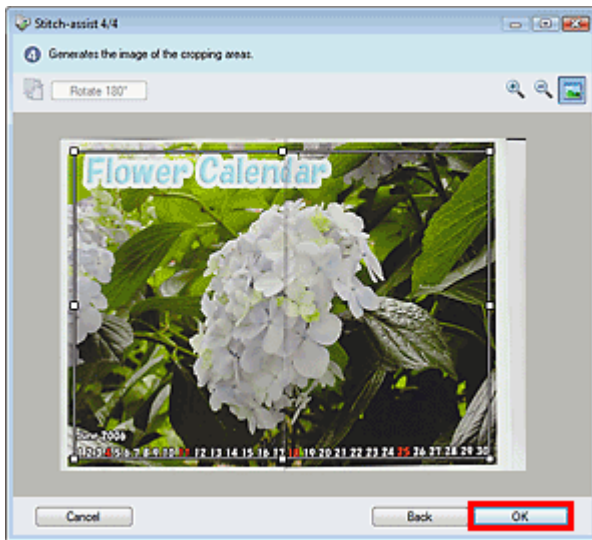

The combined image appears in the Thumbnail window.

When scanning is completed, the Scan Complete dialog box opens. Select Scan or Exit. Select Scan to scan the next document, or select Exit to end.

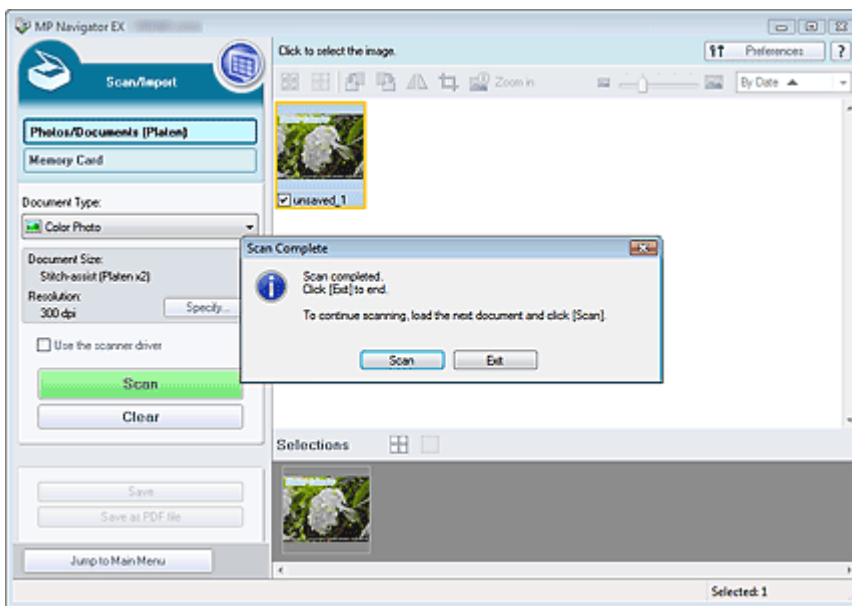

13. Save the scanned images.

- ➔ Saving
- ➔ Saving as PDF Files

[Top of Page](#)↑

Advanced Guide

Advanced Guide > Scanning > Scanning with the Bundled Application Software > Let's Try Scanning > Easy Scanning with One-click

Easy Scanning with One-click

You can complete from scanning to saving at one time by simply clicking the corresponding icon.

1. Place the document on the Platen.

➔ Placing Documents

2. Start MP Navigator EX.

➔ Starting MP Navigator EX

The MP Navigator EX Navigation Mode screen or One-click Mode screen appears.

Navigation Mode Screen

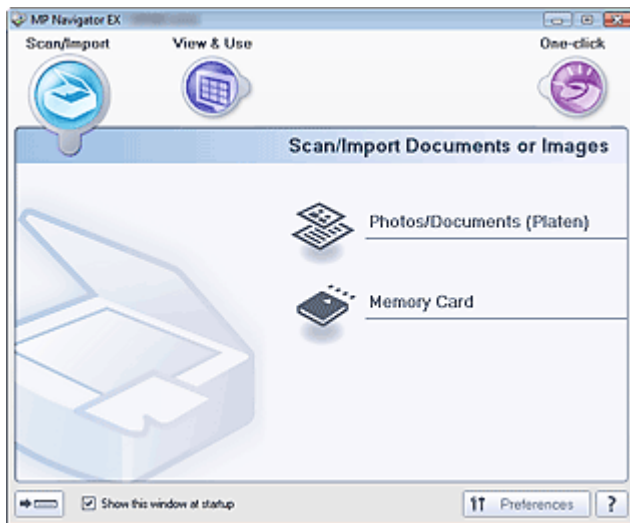

One-click Mode Screen

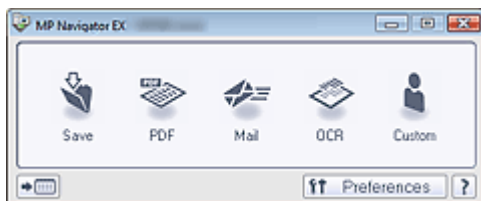

Note

- Skip ahead to Step 4 if One-click Mode screen is open.

3. Point to One-click.

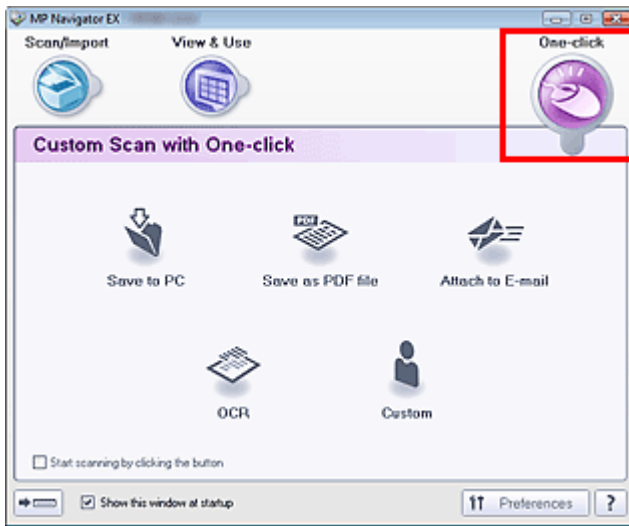

4. Click the corresponding icon.

Note

- See the corresponding sections below for details on each icon.
 - ➔ Custom Scan with One-click Tab
 - ➔ One-click Mode Screen

[Top of Page](#)↑

Advanced Guide

[Advanced Guide](#) > [Scanning](#) > [Scanning with the Bundled Application Software](#) > [Useful MP Navigator EX Functions](#)

Useful MP Navigator EX Functions

With MP Navigator EX, you can correct/enhance scanned images beautifully, and search saved images quickly.

- **Correcting/enhancing images automatically**
 - ➔ [Correcting/Enhancing Images Automatically](#)
- **Correcting/enhancing images manually**
 - ➔ [Correcting/Enhancing Images Manually](#)
- **Adjusting color characteristics such as brightness and contrast**
 - ➔ [Adjusting Images](#)
- **Searching for lost images**
 - ➔ [Searching Images](#)
- **Classifying and sorting images**
 - ➔ [Classifying Images into Categories](#)

[Top of Page](#)↑

Advanced Guide

Advanced Guide > Scanning > Scanning with the Bundled Application Software > Useful MP Navigator EX Functions > Correcting/Enhancing Images Automatically

Correcting/Enhancing Images Automatically

MP Navigator EX will analyze and correct/enhance scanned images automatically.

1. Scan documents into MP Navigator EX and save them, then open the View & Use window from the Navigation Mode screen and select the photos you want to correct/enhance.

Note

- See "Let's Try Scanning" to scan images into MP Navigator EX.
- You can also select images saved on a memory card or computer.
 - ➔ [Importing Images Saved on a Memory Card](#)
 - ➔ [Opening Images Saved on a Computer](#)

2. Click Edit/Convert, then click Fix photo images on the list.

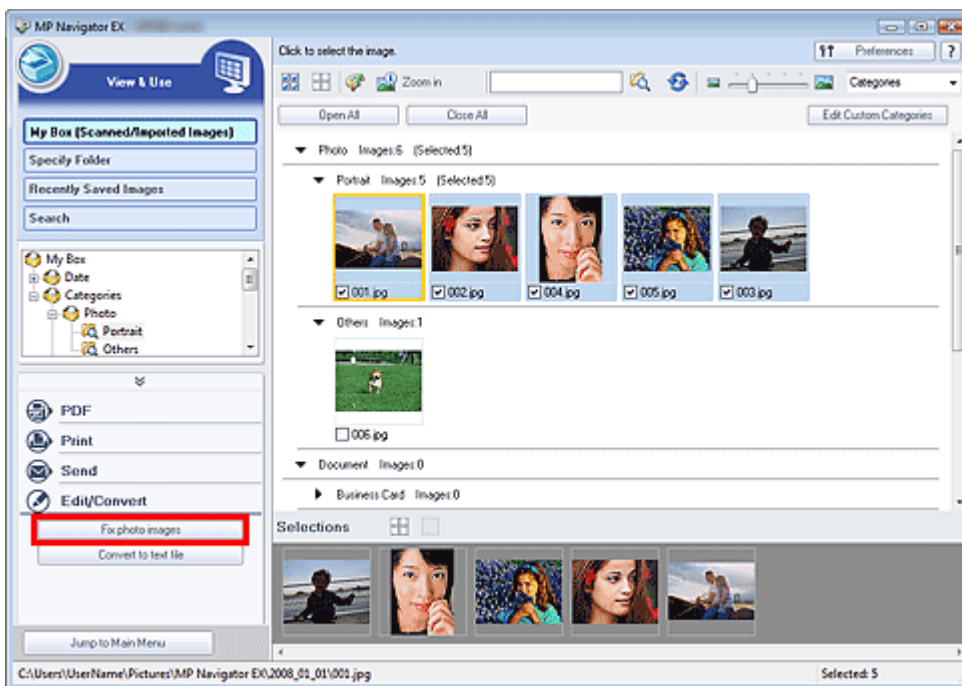

The Correct/Enhance Images window opens.

Note

- The Correct/Enhance Images window can also be opened by clicking  (Image Correction/Enhancement) on the Toolbar or in the Zoom in dialog box. In that case, only the target image (outlined in orange) can be corrected/enhanced.

3. Select the image you want to correct/enhance from the thumbnail list.

The selected image appears in Preview.



Note

- If you selected only one image in the View & Use window, the thumbnail list does not appear and only the preview image appears.

4. Make sure that Auto is selected.
5. Click Auto Photo Fix, Face Sharpener or Digital Face Smoothing.

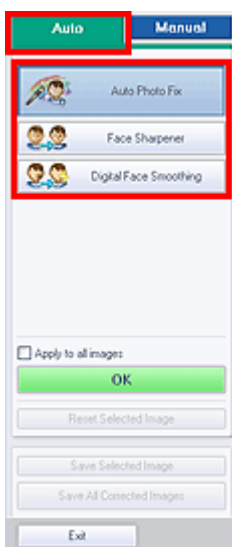

- **Auto Photo Fix**
Analyzes the image and makes suitable corrections automatically.
- **Face Sharpener**
Sharpens out-of-focus faces.
- **Digital Face Smoothing**
Enhances skin beautifully by removing blemishes and wrinkles.

Note

- The Face Sharpener and Digital Face Smoothing effect levels can be changed using the slider that appears by clicking the corresponding buttons.
- Once image is corrected with Auto Photo Fix and saved, it cannot be corrected again with Auto Photo Fix. Auto Photo Fix may not be available for images edited using an application, digital camera, etc. manufactured by other companies.

6. Click OK.

The entire image is corrected/enhanced automatically and  (Correct/Enhance) appears on the upper left of the thumbnail and preview image.

 **Note**

-
- Click Reset Selected Image to undo the correction/enhancement.
 - Select the Apply to all images checkbox to correct/enhance all selected images.
-

7. Click Save Selected Image or Save All Corrected Images.

You can save corrected/enhanced images as new files.

 **Note**

-
- To save only the images you like, select them and click Save Selected Image. To save all images, click Save All Corrected Images.
 - The file format of corrected/enhanced images is JPEG/Exif.
 - Adobe RGB images are saved as sRGB images.
-

8. Click Exit. **Note**

-
- The corrections/enhancements will be lost if you exit before saving corrected/enhanced images.
-

[Top of Page](#)↑

Advanced Guide

Advanced Guide > Scanning > Scanning with the Bundled Application Software > Useful MP Navigator EX Functions > Correcting/Enhancing Images Manually

Correcting/Enhancing Images Manually

You can correct/enhance scanned images manually.

1. Scan documents into MP Navigator EX and save them, then open the View & Use window from the Navigation Mode screen and select the photos you want to correct/enhance.

Note

- See "Let's Try Scanning" to scan images into MP Navigator EX.
- You can also select images saved on a memory card or computer.
 - ➔ [Importing Images Saved on a Memory Card](#)
 - ➔ [Opening Images Saved on a Computer](#)

2. Click Edit/Convert, then click Fix photo images on the list.

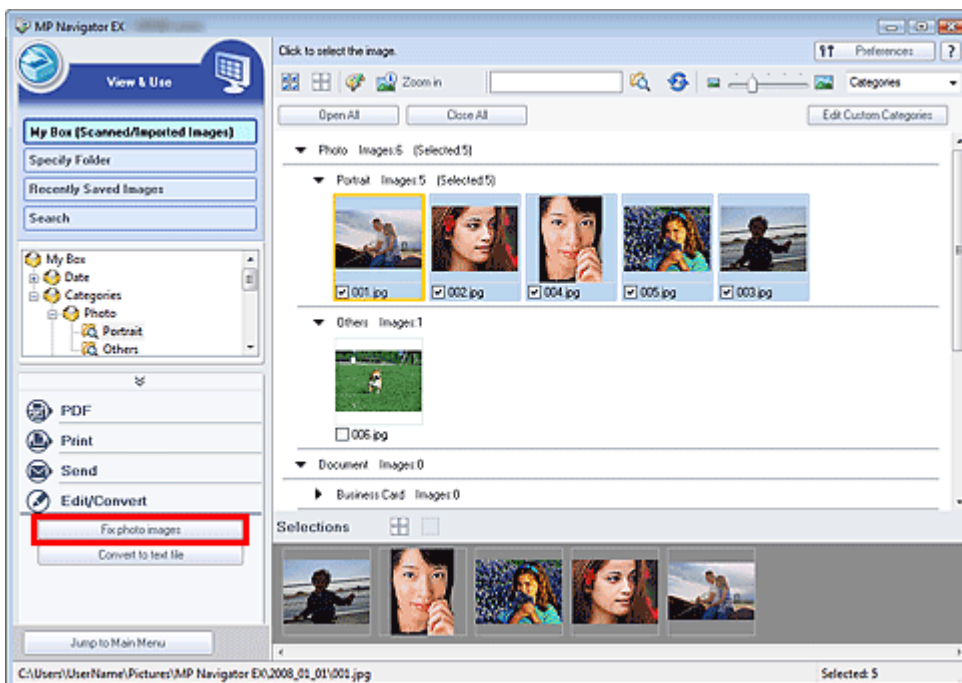

The Correct/Enhance Images window opens.

Note

- The Correct/Enhance Images window can also be opened by clicking  (Image Correction/Enhancement) on the Toolbar or in the Zoom in dialog box. In that case, only the target image (outlined in orange) can be corrected/enhanced.

3. Select the image you want to correct/enhance from the thumbnail list.

The selected image appears in Preview.



Note

- If you selected only one image in the View & Use window, the thumbnail list does not appear and only the preview image appears.

4. Click Manual, then click Correct/Enhance.
5. Click Face Brightener, Face Sharpener, Digital Face Smoothing or Blemish Remover.





- **Face Brightener**
Brightens dark faces in backlit photos.
- **Face Sharpener**
Sharpens out-of-focus faces.
- **Digital Face Smoothing**
Enhances skin beautifully by removing blemishes and wrinkles.
- **Blemish Remover**
Removes moles.

Note

- Move the cursor over the image. The shape of the cursor changes to .

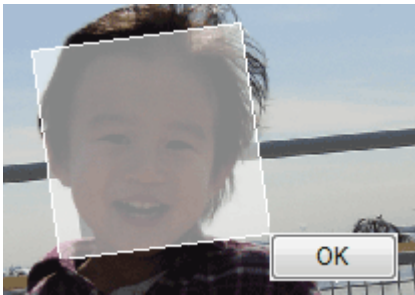
6. Drag to select the area you want to correct/enhance, then click OK that appears over the image.



The portion in and around the selected area is corrected/enhanced and  appears on the upper left of the thumbnail.

 **Note**

- For Face Brightener, Face Sharpener and Digital Face Smoothing, you can drag to rotate the rectangle.
 - Click Undo to undo the latest correction/enhancement.
 - The Face Brightener, Face Sharpener and Digital Face Smoothing effect levels can be changed using the slider that appears by clicking the corresponding buttons.
 - Click Reset Selected Image to undo the correction/enhancement.
-

7. Click Save Selected Image or Save All Corrected Images.

You can save corrected/enhanced images as new files.

 **Note**

- To save only the images you like, select them and click Save Selected Image. To save all images, click Save All Corrected Images.
 - The file format of corrected/enhanced images is JPEG/Exif.
-

8. Click Exit.

 **Note**

- The corrections/enhancements will be lost if you exit before saving corrected/enhanced images.
-

[Top of Page](#) 

Advanced Guide

Advanced Guide > Scanning > Scanning with the Bundled Application Software > Useful MP Navigator EX Functions > Adjusting Images

Adjusting Images

You can make fine adjustments to the overall brightness, contrast, etc. of images.

1. Scan documents into MP Navigator EX and save them, then open the View & Use window from the Navigation Mode screen and select the photos you want to adjust.



Note

- See "Let's Try Scanning" to scan images into MP Navigator EX.
- You can also select images saved on a memory card or computer.
 - ➔ [Importing Images Saved on a Memory Card](#)
 - ➔ [Opening Images Saved on a Computer](#)

2. Click Edit/Convert, then click Fix photo images on the list.

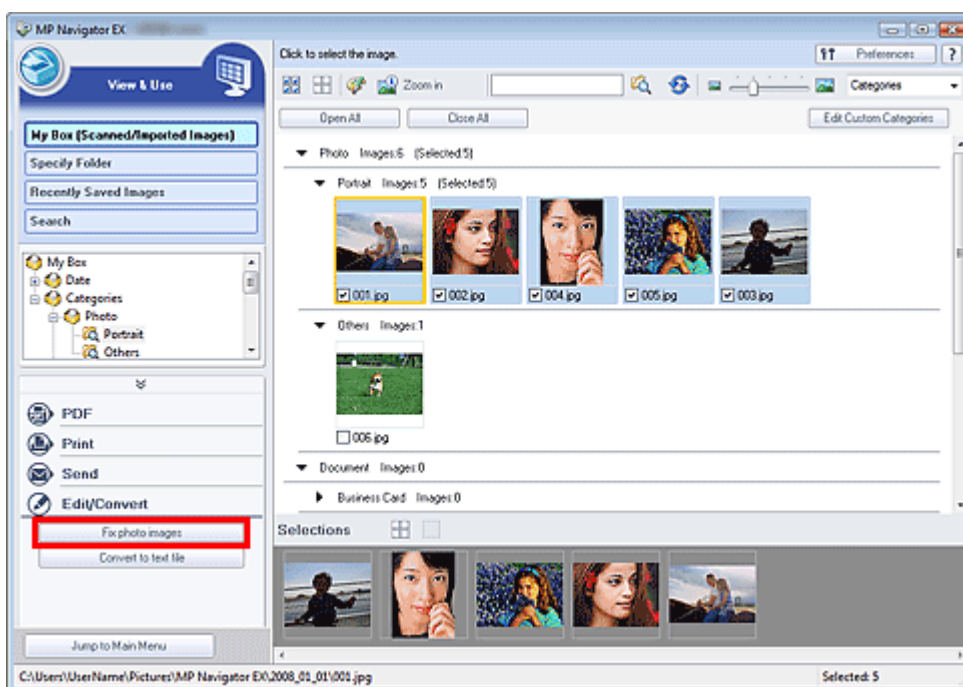

The Correct/Enhance Images window opens.



Note

- The Correct/Enhance Images window can also be opened by clicking  (Image Correction/Enhancement) on the Toolbar or in the Zoom in dialog box. In that case, only the target image (outlined in orange) can be corrected/enhanced.

3. Select the image you want to adjust from the thumbnail list.

The selected image appears in Preview.



Note

- If you selected only one image in the View & Use window, the thumbnail list does not appear and only the preview image appears.

4. Click Manual, then click Adjust.

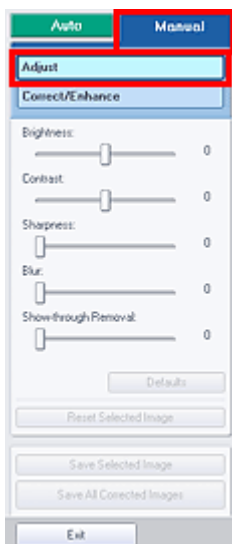

5. Move the slider of the item you want to adjust and set the effect level.

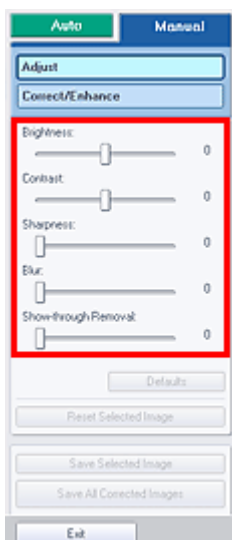

• Brightness

Adjusts the overall image brightness. Adjust the brightness when the image is too dark or too bright.

Move the slider to the left to darken and right to brighten the image.

- **Contrast**

Adjusts the contrast of the image. Adjust the contrast when the image is flat due to lack of contrast.

Move the slider to the left to decrease and right to increase the contrast of the image.

- **Sharpness**

Emphasizes the outline of the subjects to sharpen the image. Adjust the sharpness when the photo is out of focus or text is blurred.

Move the slider to the right to sharpen the image.

- **Blur**

Blurs the outline of the subjects to soften the image.

Move the slider to the right to soften the image.

- **Show-through Removal**

Removes show-through of text from the reverse side or removes the base color. Adjust the show-through level to prevent text on the reverse side of thin document or the base color of the document from appearing on the image.

Move the slider to the right to increase the show-through removal effect.



Note

- Click Defaults to reset all adjustments.
-

6. Click Save Selected Image or Save All Corrected Images.

You can save adjusted images as new files.



Note

- To save only the images you like, select them and click Save Selected Image. To save all images, click Save All Corrected Images.
 - The file format of corrected/enhanced images is JPEG/Exif.
-

7. Click Exit.



Note

- The adjustments will be lost if you exit before saving adjusted images.
-

[Top of Page](#)↑

Advanced Guide

Advanced Guide > Scanning > Scanning with the Bundled Application Software > Useful MP Navigator EX Functions > Searching Images

Searching Images



In the View & Use window of the Navigation Mode screen, you can search images saved on your computer and open them in MP Navigator EX. Opened images can be printed, edited, etc.

Note

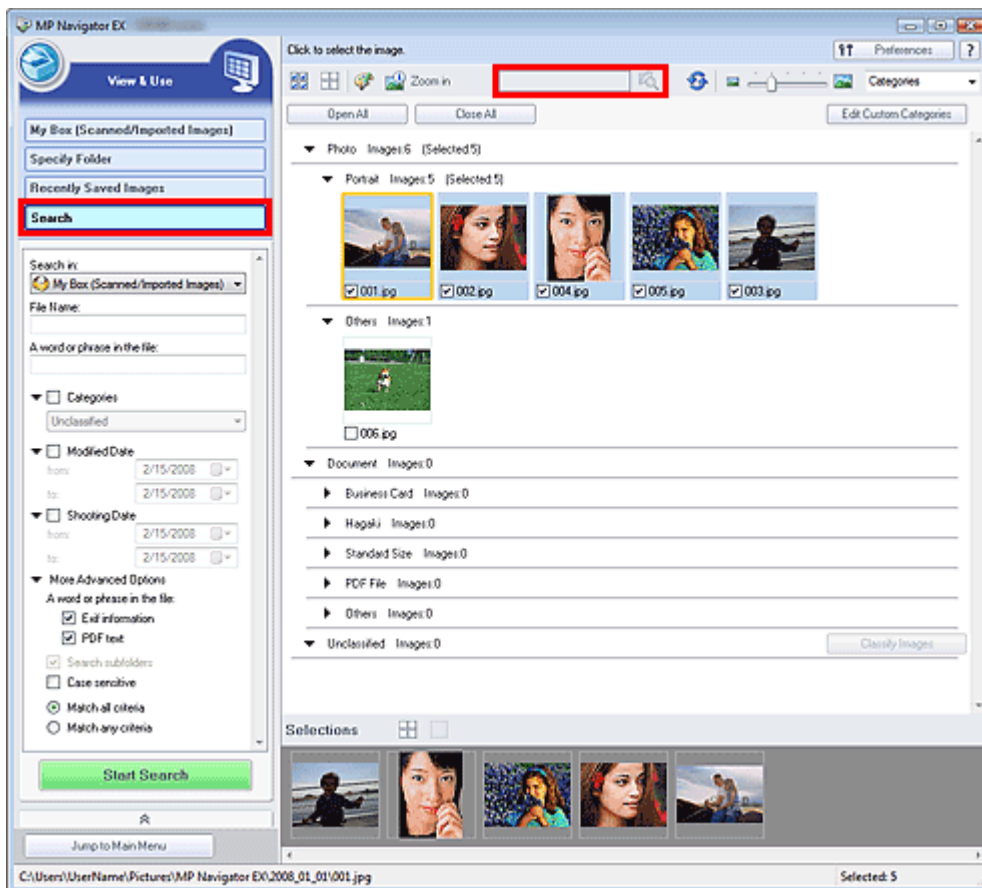
- Search images in My Box (Scanned/Imported Images), Recently Saved Images or a selected folder and its subfolders. You can also specify folder and search in Specify Folder.



Quick Search

In  on the Toolbar, enter a word or phrase included in the file name, Exif information or PDF text of the image you want to search for, then click . For Exif information, text in Maker, Model, Description and User Comment is searched.

Advanced Search

Click Search on the left of the screen to open search options. Enter information of the image you want to search for, then click Start Search.

- **Search in**

If you know where to look for, select the drive, folder or network from Specify Folder.

- **File Name**

If you know the file name, enter it.

- **A word or phrase in the file**

Enter a word or phrase included in the items selected in More Advanced Options.



Note

- For PDF files, you can only search for those created with MP Navigator EX. You cannot search PDF files created or edited in other applications. Also, searching PDF files is available only when keyword search is set.
For details of creating PDF files that enables keyword search, see "[PDF Settings Dialog Box](#)."
- Password-protected PDF files cannot be searched.

- **Categories**

You can search for images by category.

- **Modified Date**

To search for files that have been updated in a specific time period, enter the first and last dates of the period.

- **Shooting Date**

To search for images captured in a specific time period, enter the first and last dates of the period.



Note

- Captured date is the date and time of data creation, which are included in the document's Exif information.

- **More Advanced Options**

- **A word or phrase in the file**

In A word or phrase in the file, select the items to search. If you select the Exif information checkbox, text in Maker, Model, Description and User Comment is searched. If you select the PDF text checkbox, text in PDF files is searched.



Note

- Text in password-protected PDF files cannot be searched.
-

- **Search subfolders**

Select this checkbox to search subfolders.

- **Case sensitive**

Select this checkbox to match case.

- **Match all criteria**

Searches for files that meet all the specified criteria.

- **Match any criteria**

Searches for files that meet any of the specified criteria.

- **Start Search**

Click to start search.

**Note**

- See "[View & Use Window](#)" for details on the View & Use window.
-

[Top of Page](#)↑

Advanced Guide

Advanced Guide > Scanning > Scanning with the Bundled Application Software > Useful MP Navigator EX Functions > Classifying Images into Categories

Classifying Images into Categories

You can display images scanned with MP Navigator EX by category. Unclassified images can be classified automatically, and you can also create custom categories.

1. Scan documents into MP Navigator EX and save them, then open the View & Use window from the Navigation Mode screen.

Note

- See "Let's Try Scanning" to scan images into MP Navigator EX.
- You can also select images saved on a memory card or computer.
 - ➔ [Importing Images Saved on a Memory Card](#)
 - ➔ [Opening Images Saved on a Computer](#)

2. In (Sort by), select Categories.

Images are automatically sorted by category and appear in the Thumbnail window.

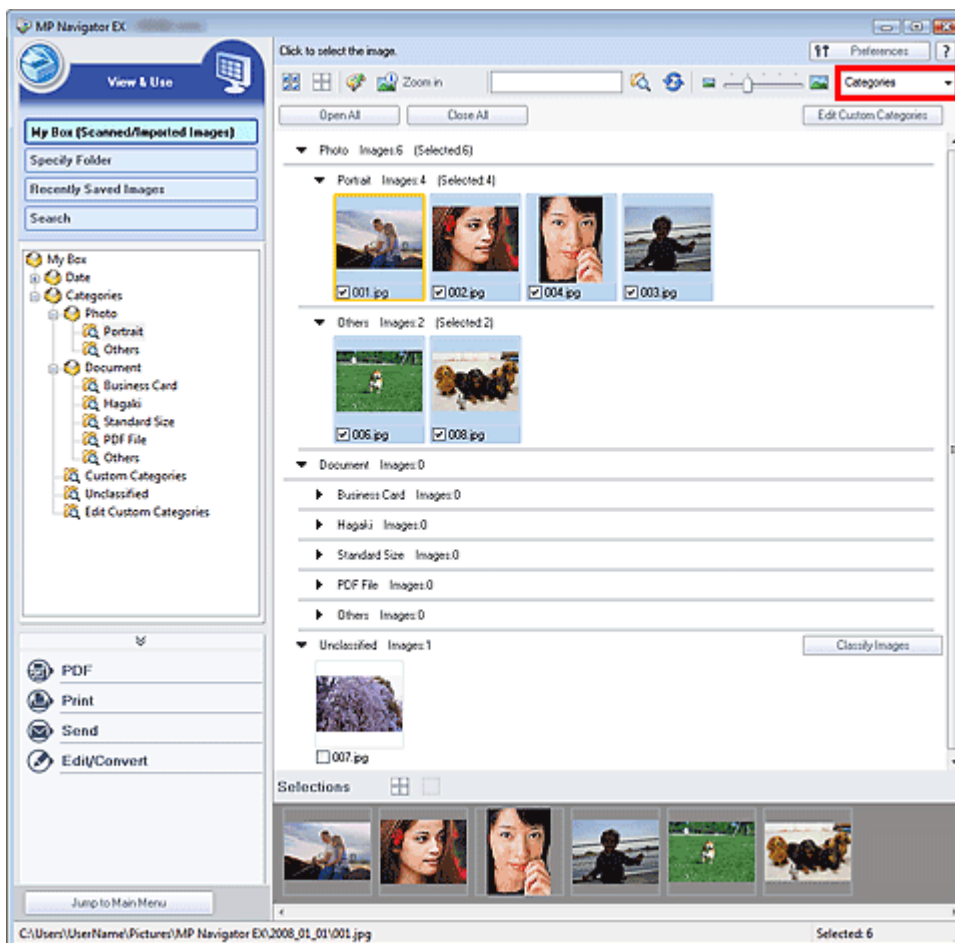

Images are sorted into the following categories.

Photos: Portrait, Others

Documents: Business Card, Hagaki, Standard Size, PDF File, Others

Custom categories: Displays your custom categories.

To create custom categories, see "[Creating Custom Categories](#)."

Unclassified: Displays images that have not yet been classified.

Important

- Category classification information of the images saved in the removable media will be deleted, when you remove the media such as USB flash memory, external hard disk, etc. From

the next time, the images are classified to Unclassified.

Note

- Click Classify Images to classify images displayed in Unclassified automatically. Click Cancel to stop. Some images may not be detected correctly and classified to wrong category.
- Drag and drop an image to move it from one category to another.
- Images cannot be classified when Recently Saved Images is selected in the View & Use window.
- You can search for images by category. See "[Searching Images](#)" for details.

Creating Custom Categories

1. In the View & Use window, sort images by category and click Edit Custom Categories.

The Edit Custom Categories dialog box opens.

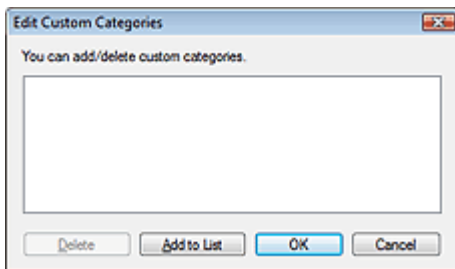

2. Click Add to List.

The Add Category dialog box opens.

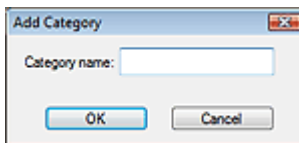

3. Enter Category name and click OK.

Important

- You can create up to 20 custom categories.
- Up to 50 single-byte characters can be used for a category name.

Note

- Select a custom category and click Delete to delete it.

Note

- See "[View & Use Window](#)" for details on the View & Use window.

[Top of Page](#)↑

Advanced Guide

[Advanced Guide](#) > [Scanning](#) > [Scanning with the Bundled Application Software](#) > [Utilizing Images in MP Navigator EX](#)

Utilizing Images in MP Navigator EX

You can save or print scanned images using MP Navigator EX.

- **Saving scanned images to computer**
 - ➔ [Saving](#)
- **Saving scanned image as PDF Files**
 - ➔ [Saving as PDF Files](#)
- **Creating PDF files from scanned images and editing PDF files**
 - ➔ [Creating/Editing PDF Files](#)
- **Printing multiple scanned images at one time or printing at specific size, quality, etc.**
 - ➔ [Printing Documents](#)
- **Printing scanned photos**
 - ➔ [Printing Photos](#)
- **Sending scanned images via e-mail**
 - ➔ [Sending via E-mail](#)
- **Correcting/enhancing scanned images or converting them to text**
 - ➔ [Editing Files](#)
- **Setting passwords for created PDF files**
 - ➔ [Setting Passwords for PDF Files](#)
 - ➔ [Opening/Editing Password-protected PDF Files](#)

[Top of Page](#)↑

Advanced Guide

Advanced Guide > Scanning > Scanning with the Bundled Application Software > Utilizing Images in MP Navigator EX > Saving

Saving

Save images scanned with MP Navigator EX to a computer.

1. Select the checkboxes of the images you want to save, then click Save.

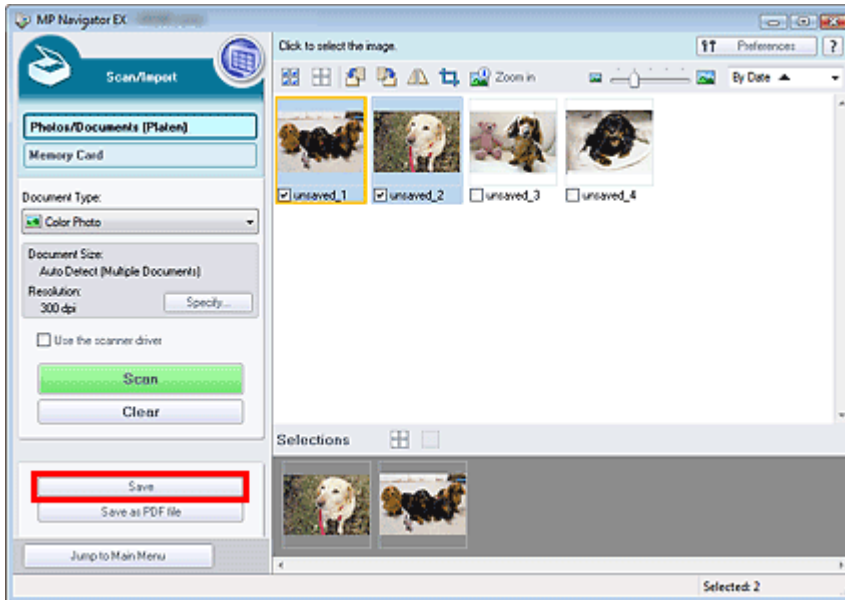

2. In the Save dialog box, specify the save settings.

Specify the destination folder, file name and file type.

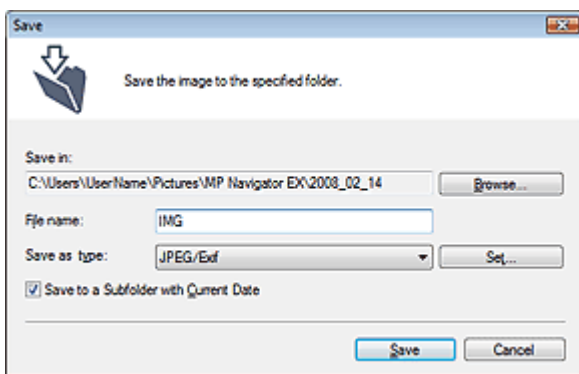

Important

- You cannot select JPEG/Exif when Document Type is Text(OCR).

Note

- See "Save Dialog Box" for details on the Save dialog box.
- By default, the following folders are specified as the destination folders.
Windows Vista: MP Navigator EX folder in Picture folder
Windows XP: MP Navigator EX folder in My Pictures folder
Windows 2000: MP Navigator EX folder in My Pictures folder

3. Click Save.

Scanned images are saved according to the settings.

To further use/edit the scanned images on MP Navigator EX, click Open saved location in the Save Complete dialog box.

- ➔ [Creating/Editing PDF Files](#)
- ➔ [Printing Documents](#)

- ➡ Printing Photos
- ➡ Sending via E-mail
- ➡ Editing Files

[Top of Page↑](#)

Advanced Guide

Advanced Guide > Scanning > Scanning with the Bundled Application Software > Utilizing Images in MP Navigator EX > Saving as PDF Files

Saving as PDF Files

Save images scanned with MP Navigator EX as PDF files.

1. Select the checkboxes of the images you want to save, then click Save as PDF file.

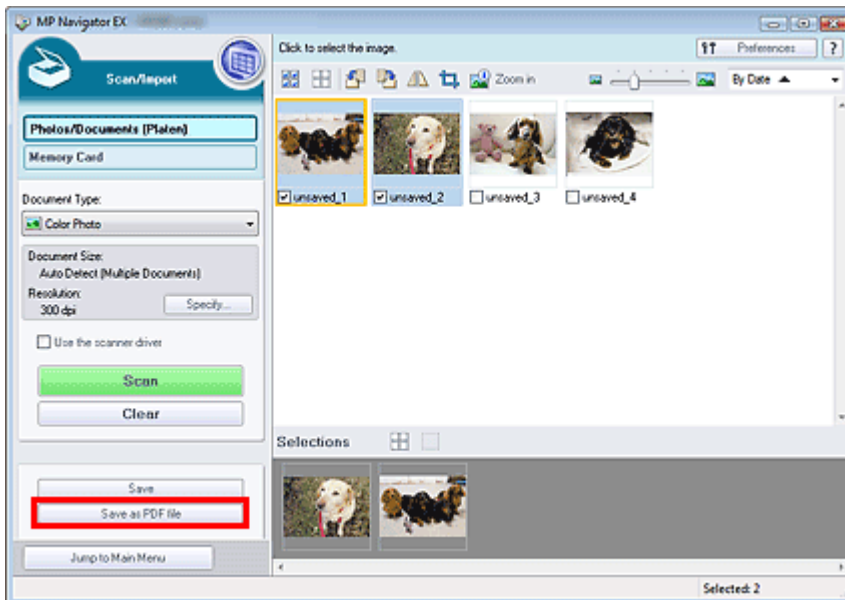

2. In the Save as PDF file dialog box, specify the save settings. Specify the file type, file name and destination folder.

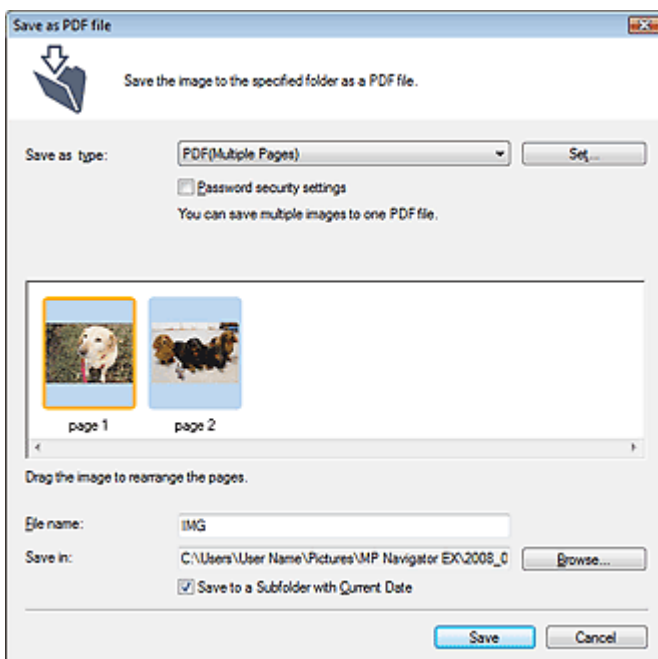

Select from the following PDF file types:

- **PDF**
Save each of the selected images as a separate PDF file.
- **PDF(Multiple Pages)**
Save multiple images in one PDF file.

Important

- PDF(Multiple Pages) is displayed when multiple images are selected.

- **PDF(Add Page)**

Add the scanned images to a PDF file. The images are added to the end of the PDF file. You cannot rearrange the pages of the PDF file to which the images are added.

**Important**

- Images can only be added to PDF files created with MP Navigator EX. You cannot specify PDF files created with other applications. PDF files edited in other applications cannot be specified as well.
- If a password-protected PDF file is edited, the passwords will be deleted. Reset the passwords.

**Note**

- See "[Save as PDF file Dialog Box](#)" for details on the Save as PDF file dialog box and Set....
- By default, the following folders are specified as the destination folders.
 - Windows Vista: MP Navigator EX folder in Picture folder
 - Windows XP: MP Navigator EX folder in My Pictures folder
 - Windows 2000: MP Navigator EX folder in My Pictures folder
- You can set passwords for PDF files.
 - ➔ [Setting Passwords for PDF Files](#)

3. Click Save.

Scanned images are saved according to the settings.

To further use/edit the scanned images on MP Navigator EX, click Open saved location in the Save Complete dialog box.

- ➔ [Creating/Editing PDF Files](#)
- ➔ [Printing Documents](#)
- ➔ [Printing Photos](#)
- ➔ [Sending via E-mail](#)
- ➔ [Editing Files](#)

[Top of Page](#)↑

Advanced Guide

Advanced Guide > Scanning > Scanning with the Bundled Application Software > Utilizing Images in MP Navigator EX > Creating/Editing PDF Files

Creating/Editing PDF Files

Create/edit PDF files. You can add/delete pages, rearrange page order, etc.

1. Scan documents into MP Navigator EX and save them, then open the View & Use window from the Navigation Mode screen and select what you want to do with the images.

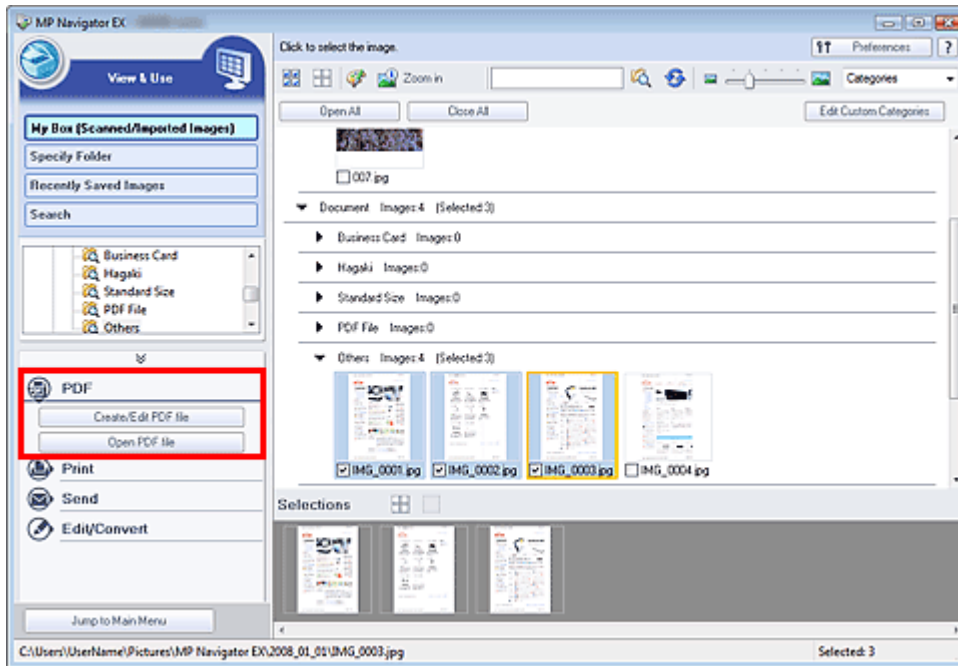

Note

- See "Let's Try Scanning" to scan images into MP Navigator EX.
- You can also select images saved on a memory card or computer.
 - ➔ [Importing Images Saved on a Memory Card](#)
 - ➔ [Opening Images Saved on a Computer](#)

Creating/Editing PDF Files with MP Navigator EX

2. Select files and click PDF.
3. Click Create/Edit PDF file on the list.

Important

- You can select PDF, JPEG, TIFF and BMP files.
- For PDF files, you can only edit those created with MP Navigator EX. You cannot edit PDF files created with other applications. PDF files edited in other applications cannot be edited as well.
- If a password-protected PDF file is selected, you will be prompted to enter the password.
 - ➔ [Opening/Editing Password-protected PDF Files](#)

4. Add/delete pages as required.

To add an existing file, click Add Page and select the file. To delete a page, select it and click Delete Selected Pages.

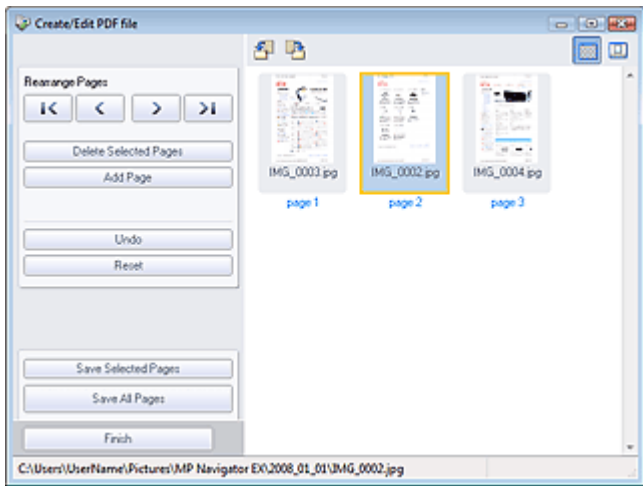

Note

- You can add PDF, JPEG, TIFF and BMP files.
- When adding a password-protected PDF file, you will be prompted to enter the password.

5. Rearrange the page order as required.

Use the icons to rearrange the order. Alternatively, drag and drop the thumbnail to the target location.

Note

- See "[Create/Edit PDF file Window](#)" for details on the Create/Edit PDF file window.

6. Click Save Selected Pages or Save All Pages.

The Save as PDF file dialog box opens.

Important

- You cannot save images scanned at 10501 pixels or more in the vertical and horizontal directions.
- If a password-protected PDF file is edited, the passwords will be deleted. Reset the passwords in the Save as PDF file dialog box.
➔ [Setting Passwords for PDF Files](#)

Note

- See "[Save as PDF file Dialog Box](#)" for details on the Save as PDF file dialog box.

7. Specify the save settings in the Save as PDF file dialog box, then click Save.

Images are saved according to the settings.

Opening PDF Files in an Application

You can open PDF files created with MP Navigator EX in an associated application and edit or print them.

2. Select PDF files and click PDF.

Important

- For PDF files, you can only select those created with MP Navigator EX. You cannot select PDF files created with other applications. PDF files edited in other applications cannot be selected as well.

3. Click Open PDF file on the list.

The application associated with the .pdf file extension by the operating system starts.

Important

- Password-protected PDF files cannot be opened in applications not supporting security setting.

4. Use the application to edit/print the file.

For details, refer to the application's manual.



Important

- In some applications, the commands (print, edit, etc.) restricted by Permissions Password may differ from those in MP Navigator EX.

[Top of Page](#)↑

Advanced Guide

Advanced Guide > Scanning > Scanning with the Bundled Application Software > Utilizing Images in MP Navigator EX > Printing Documents

Printing Documents

You can print multiple scanned images at one time, print at specific quality, etc. using MP Navigator EX.

1. Scan documents into MP Navigator EX and save them, then open the View & Use window from the Navigation Mode screen and select images.

Note

- See "Let's Try Scanning" to scan images into MP Navigator EX.
- You can also select images saved on a memory card or computer.
 - ➔ Importing Images Saved on a Memory Card
 - ➔ Opening Images Saved on a Computer

2. Click Print, then click Print Document on the list.

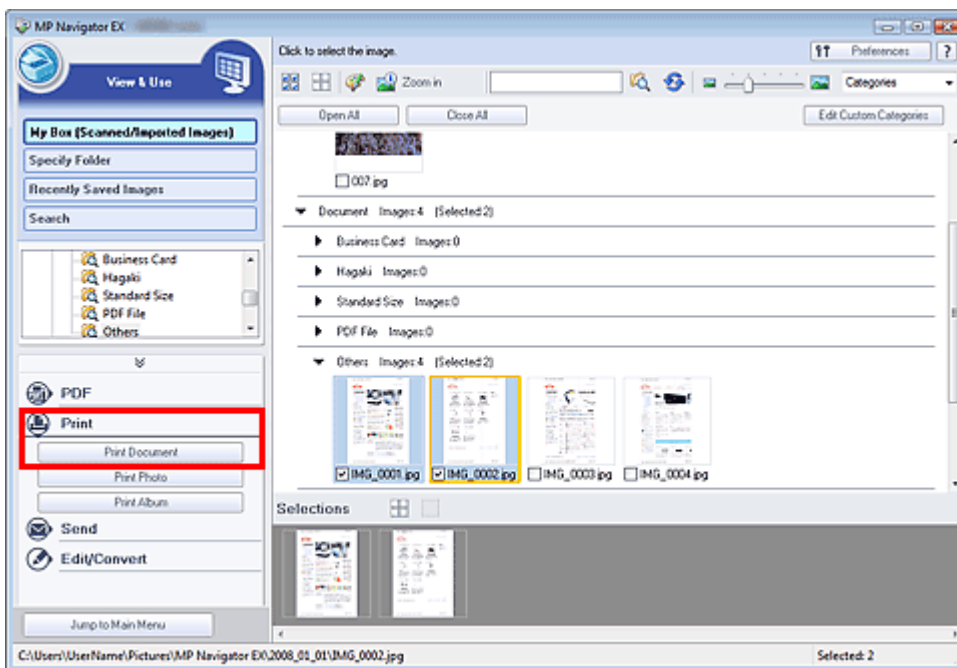

Important

- If a password-protected PDF file is selected, you will be prompted to enter the password.
 - ➔ Opening/Editing Password-protected PDF Files

3. Specify print settings as required.

In the displayed dialog box, specify print count, quality, scale, etc.

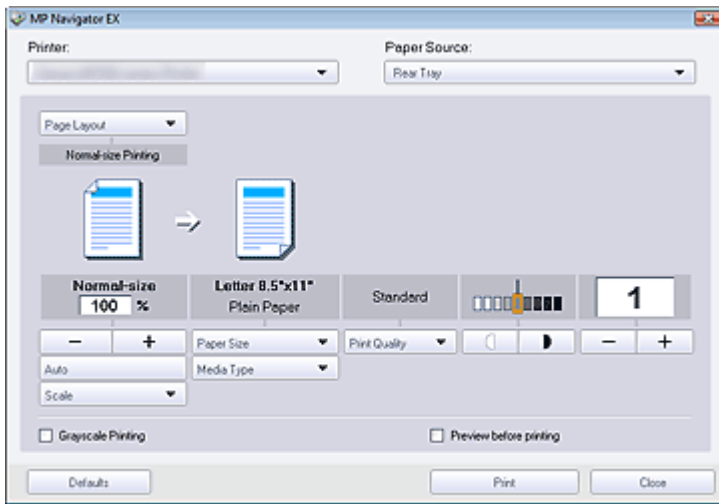

Important

- At 100% Normal-size, some images may be printed small or with some portions cropped. In that case, select Auto to resize the print in proportion to the paper size.

Note

- See "[Print Document Dialog Box](#)" for details.

4. Click Print.

Printing starts.

Important

- When printing a multiple-page PDF file via Print Document, printing may take time depending on your computer. In that case, follow these steps and change settings.
 - From the Start menu, select Control Panel.
 - Click Printers.
 - Right-click the icon of your printer and click Properties.
The printer properties dialog box opens.
 - Click the Advanced tab.
 - Select Spool print documents so program finishes printing faster.
 - Select Start printing after last page is spooled.
 - After printing, return the setting on the Preferences tab to Start printing immediately.

Note

- To cancel while spooling, click Cancel. To cancel while printing, select the printer icon on the taskbar and click Cancel Printing.

[Top of Page](#)↑

Advanced Guide

Advanced Guide > Scanning > Scanning with the Bundled Application Software > Utilizing Images in MP Navigator EX > Printing Photos

Printing Photos

You can print scanned photos using MP Navigator EX or an application that accompanies the machine.

1. Scan documents into MP Navigator EX and save them, then open the View & Use window from the Navigation Mode screen and select images.

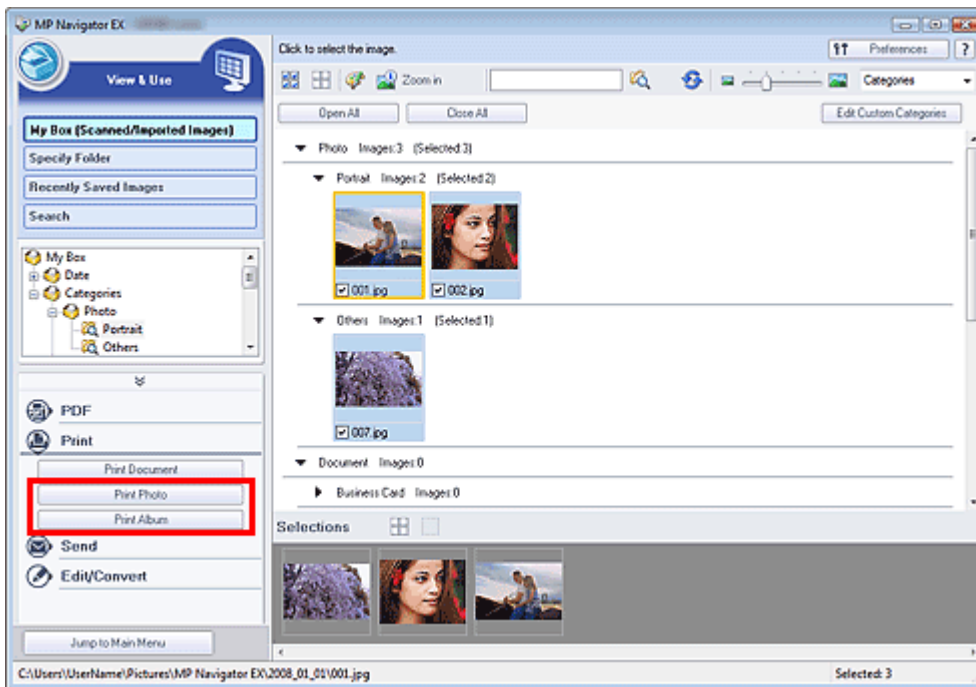

Note

- See "Let's Try Scanning" to scan images into MP Navigator EX.
- You can also select images saved on a memory card or computer.
 - ➔ [Importing Images Saved on a Memory Card](#)
 - ➔ [Opening Images Saved on a Computer](#)

When printing photos using an application that accompanies the machine

You can use an application that accompanies the machine to print scanned photos at high quality or to layout and print images.

2. Click Print, then click Print Photo or Print Album on the list.

Easy-PhotoPrint EX starts. See "[Printing Photos](#)" for details.

Note

- If Easy-PhotoPrint EX is not installed, print with MP Navigator EX.

When printing photos using MP Navigator EX

2. Click Print, then click Print Photo on the list.

3. Specify print settings as required.

In the displayed dialog box, specify paper size, print count, etc.

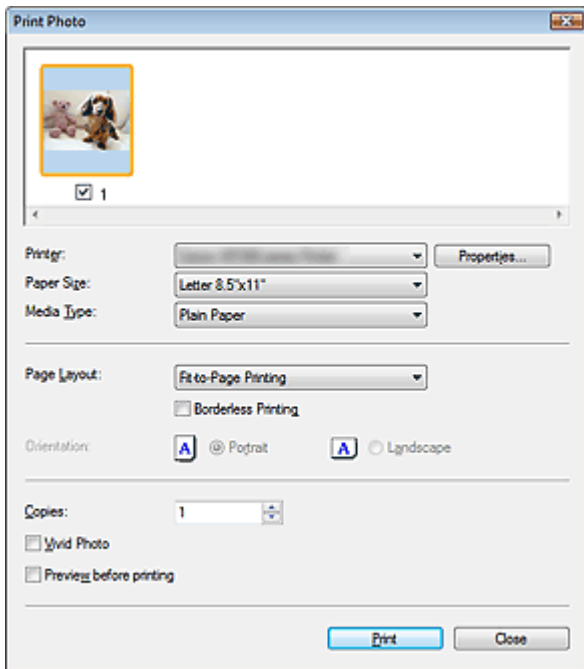

Note

- See "Print Photo Dialog Box" for details.
-

4. Click Print.

Printing starts.

Note

- To cancel while spooling, click Cancel. To cancel while printing, select the printer icon on the taskbar and click Cancel Printing.
-

[Top of Page↑](#)

Advanced Guide

Advanced Guide > Scanning > Scanning with the Bundled Application Software > Utilizing Images in MP Navigator EX > Sending via E-mail

Sending via E-mail

Send scanned images via e-mail.

Important

- MP Navigator EX is compatible with the following e-mail software programs:
 - Windows Mail (Windows Vista)
 - Outlook Express (Windows XP/Windows 2000)
 - Microsoft Outlook
 - EUDORA
 - Netscape Mail
 (If an e-mail software program does not operate properly, check that the program's MAPI is enabled. To enable MAPI, refer to the manual of the e-mail software program.)

1. Scan documents into MP Navigator EX and save them, then open the View & Use window from the Navigation Mode screen and select images.

Note

- See "[Let's Try Scanning](#)" to scan images into MP Navigator EX.
- You can also select images saved on a memory card or computer.
 - ➔ [Importing Images Saved on a Memory Card](#)
 - ➔ [Opening Images Saved on a Computer](#)

2. Click Send, then click Attach to E-mail on the list.

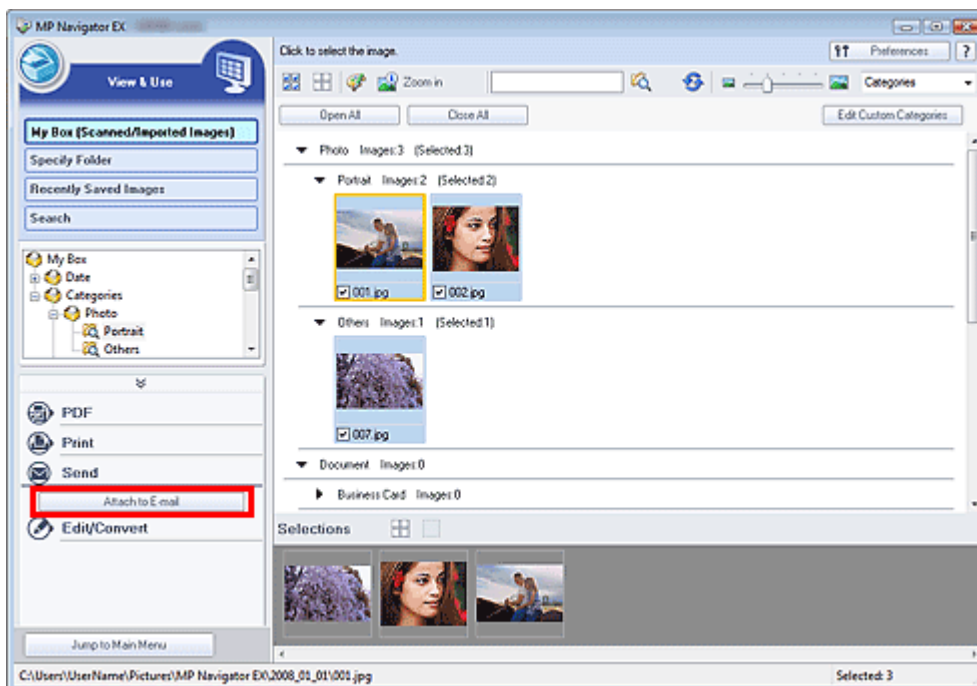

3. Set save options as required.

Specify the destination folder and file name.

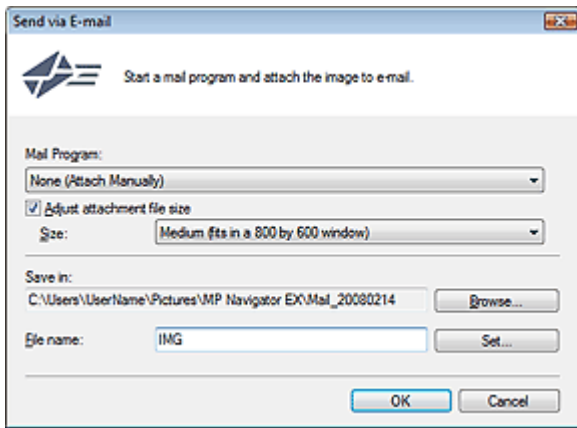

Important

- You can select a compression type when sending JPEG images via e-mail. Click Set... to open a dialog box and select High(Low Compression), Standard or Low(High Compression).

Note

- See "[Send via E-mail Dialog Box](#)" for details on the Send via E-mail dialog box.

4. Click OK.

Files are saved according to the settings, and the e-mail software program starts.

5. Specify the recipient, enter the subject and message, then send e-mail.

For details, refer to the manual of the e-mail software program.

[Top of Page](#)↑

Advanced Guide

Advanced Guide > Scanning > Scanning with the Bundled Application Software > Utilizing Images in MP Navigator EX > Editing Files

Editing Files

You can edit scanned images using MP Navigator EX, or convert them to text using an application that accompanies the machine.

1. Scan documents into MP Navigator EX and save them, then open the View & Use window from the Navigation Mode screen and select what you want to do with the images.

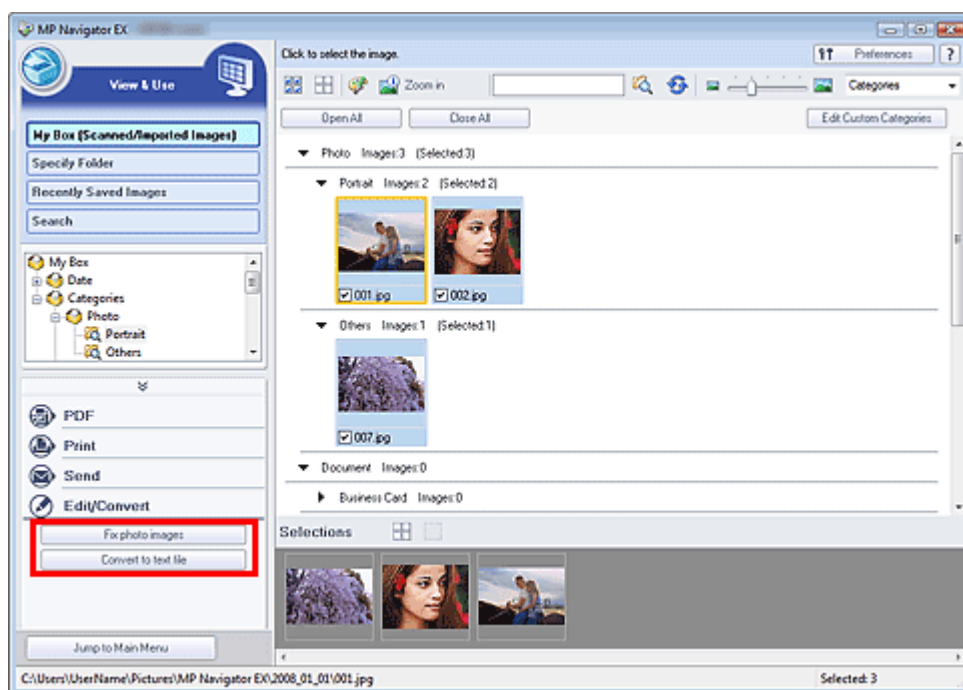

Note

- See "Let's Try Scanning" to scan images into MP Navigator EX.
- You can also select images saved on a memory card or computer.
 - ➔ Importing Images Saved on a Memory Card
 - ➔ Opening Images Saved on a Computer

Correcting photo images

You can correct/enhance images in the Correct/Enhance Images window.

2. Select images and click Edit/Convert, then click Fix photo images on the list.
The Correct/Enhance Images window opens.
3. Correct/enhance images in the Correct/Enhance Images window.

Note

- See "Correct/Enhance Images Window" for details on the Correct/Enhance Images window.
- See the corresponding sections below for correcting/enhancing images.
 - ➔ Correcting/Enhancing Images Automatically
 - ➔ Correcting/Enhancing Images Manually

Converting documents to text

Use NotePad to convert text in magazines and newspapers scanned as images to text that can be edited in word processors and other programs.

2. Select images and click Edit/Convert, then click Convert to text file on the list.

NotePad starts and editable text appears.



Note

- Text displayed in NotePad is for guidance only and may not be as accurate as text converted with commercial OCR software.
Text in the image of the following types of documents may not be detected correctly.
 - Documents containing text with font size outside the range of 8 points to 40 points (at 300 dpi).
 - Slanted documents.
 - Documents placed in the wrong orientation.
 - Documents containing special fonts, effects, italics, or hand-written text.
 - Documents with narrow line spacing.
 - Documents with colors in the background of text.
- Click Set... on the General tab and specify the language.

[➡ Preferences Dialog Box](#)

[Top of Page↑](#)

Advanced Guide

Advanced Guide > Scanning > Scanning with the Bundled Application Software > Utilizing Images in MP Navigator EX > Setting Passwords for PDF Files

Setting Passwords for PDF Files

Set passwords for opening, editing and printing PDF files.

You can set two passwords: one for opening the file and one for editing/printing it.

Important

- Internet Explorer 5.5 Service Pack 2 or later is required to use this function.
- You will not be able to open/edit the file if you forget the password. Record your passwords in a safe place for future reference.
- Password-protected PDF files cannot be opened in applications not supporting security settings.
- In some applications, the commands (print, edit, etc.) restricted by Permissions Password may differ from those in MP Navigator EX.
- Password-protected PDF files cannot be searched by text from the [View & Use window](#).

1. Scan documents into MP Navigator EX, then click Save as PDF file.
Alternatively, edit existing files in the Create/Edit PDF file window, then click Save Selected Pages or Save All Pages.

The Save as PDF file dialog box opens.

Note

- See "[Let's Try Scanning](#)" to scan images.
- See "[Creating/Editing PDF Files](#)" to create PDF files from existing images or to edit files.
- Passwords cannot be set when images are automatically saved after scanning, such as when scanning from the One-click Mode screen or scanning using the Operation Panel of the machine.

2. Select the Password security settings checkbox.

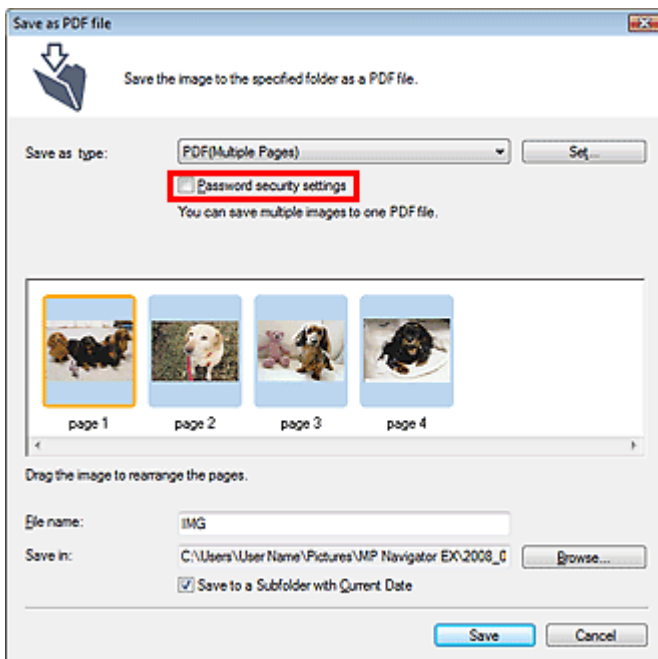

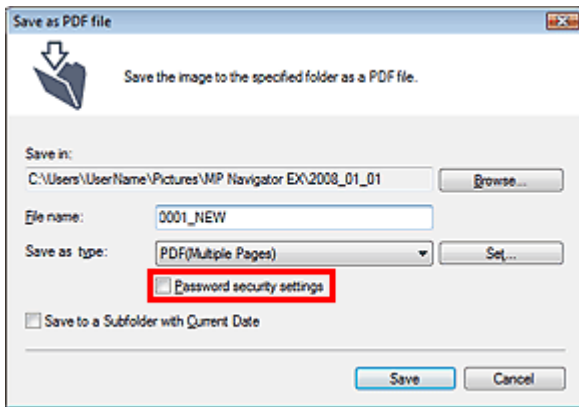

The Password Security -Settings dialog box opens.

Note

- You can also open the Password Security -Settings dialog box by clicking Set..., then selecting Password Security for Security in the PDF Settings dialog box.

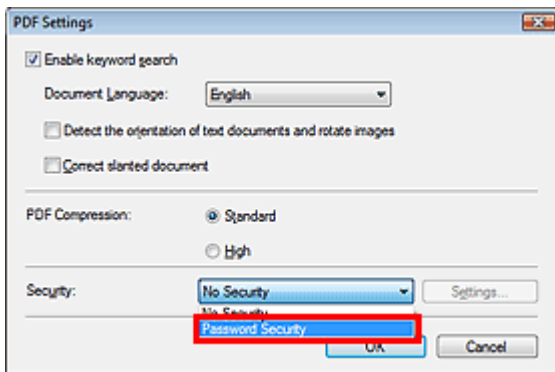

- Select the Require a password to open the document or Use a password to restrict printing and editing of the document and its security settings checkbox, then enter a password.

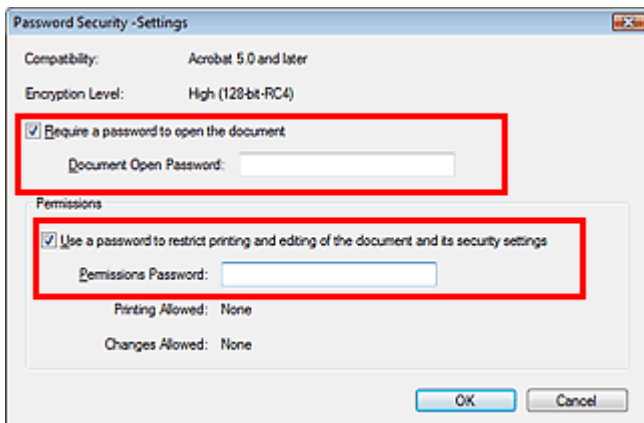

Important

- Up to 32 single-byte alphanumeric characters can be used for the password. Passwords are case sensitive.

Note

- Select both checkboxes to set both Document Open Password and Permissions Password. You cannot use the same password for both.

- Click OK.

The Confirm Document Open Password or Confirm Permissions Password dialog box opens.

Document Open Password

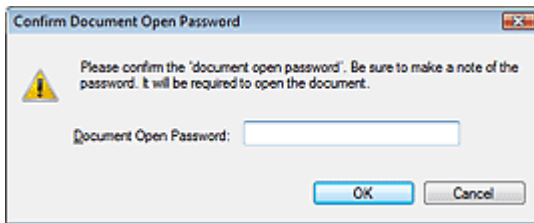

Permissions Password

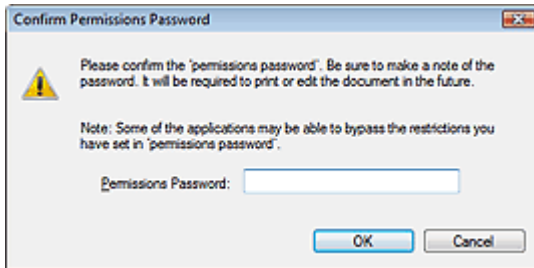

5. Re-enter the password and click OK.

The Save as PDF file dialog box returns.

Important

- If you close the Save as PDF file dialog box without clicking Save, the settings in the Password Security -Settings dialog box will be deleted.
- Passwords are deleted once the file is edited. Reset the passwords when saving edited files.

Note

- If you set the passwords via the PDF Settings dialog box, the PDF Settings dialog box returns. Click OK. The Save as PDF file dialog box returns.

6. Click Save.

Files are saved according to the settings.

Related Topic

- ▶ [Opening/Editing Password-protected PDF Files](#)

[Top of Page](#)↑

Advanced Guide

Advanced Guide > Scanning > Scanning with the Bundled Application Software > Utilizing Images in MP Navigator EX > Opening/Editing Password-protected PDF Files

Opening/Editing Password-protected PDF Files

Enter a password to open or edit/print password-protected PDF files.

Password entry method varies by operation. The following procedures are examples only.

Important

- You can open, edit or print only PDF files whose passwords were set with MP Navigator EX. You cannot edit PDF files edited in other applications or whose passwords were set with other applications. Only MP Navigator EX version 1.1 and 2.0 or later supports opening, editing and printing password-protected PDF files.
- Internet Explorer 5.5 Service Pack 2 or later is required to open, edit or print password-protected PDF files.
- Passwords are case sensitive.

Entering a Password to Open a File

1. In the View & Use window, select the PDF file you want to open and click  Zoom in.

Alternatively, double-click the PDF file.

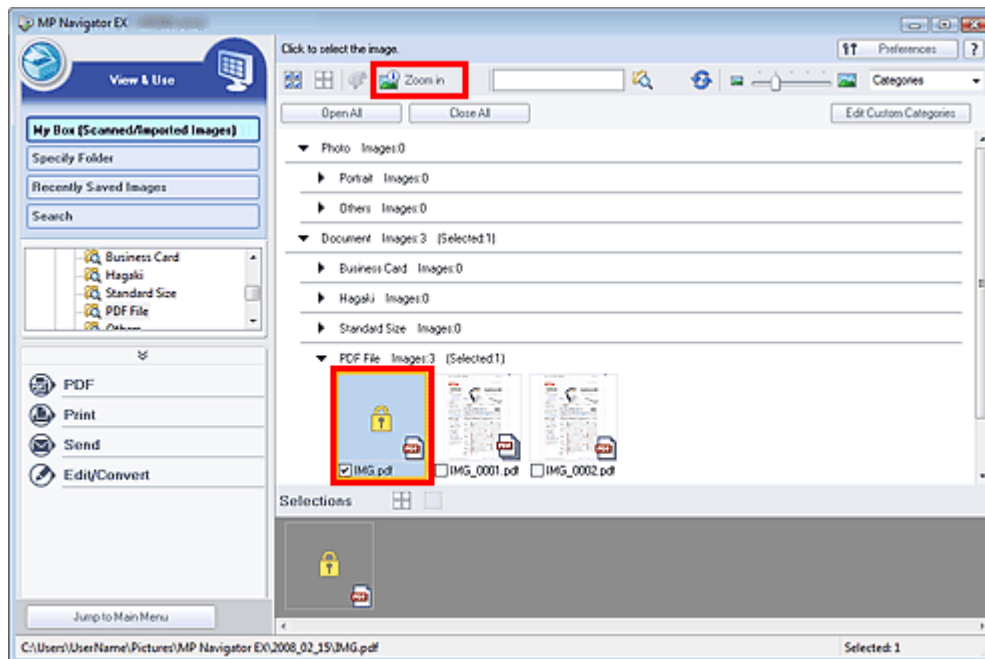

Note

- Only the Document Open Password will be required. The Permissions Password will not be required.
- If the Zoom in dialog box with a lock icon opens, click Enter Password.

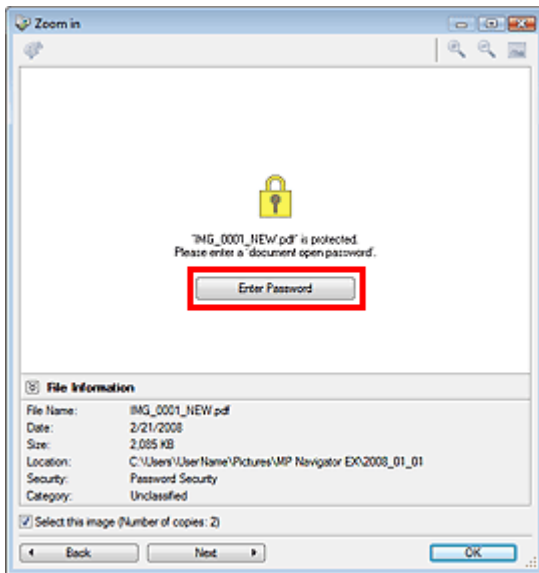

2. The Password dialog box opens. Enter the password and click OK.

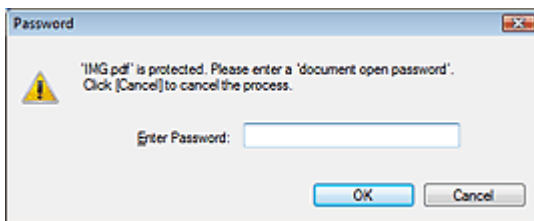

The PDF file opens in the Zoom in dialog box.

Important

- To reopen the file after closing the Zoom in dialog box, re-enter the password.

Entering a Password (Permissions Password) to Edit or Print a File

1. In the View & Use window, select PDF files and click PDF or Print.

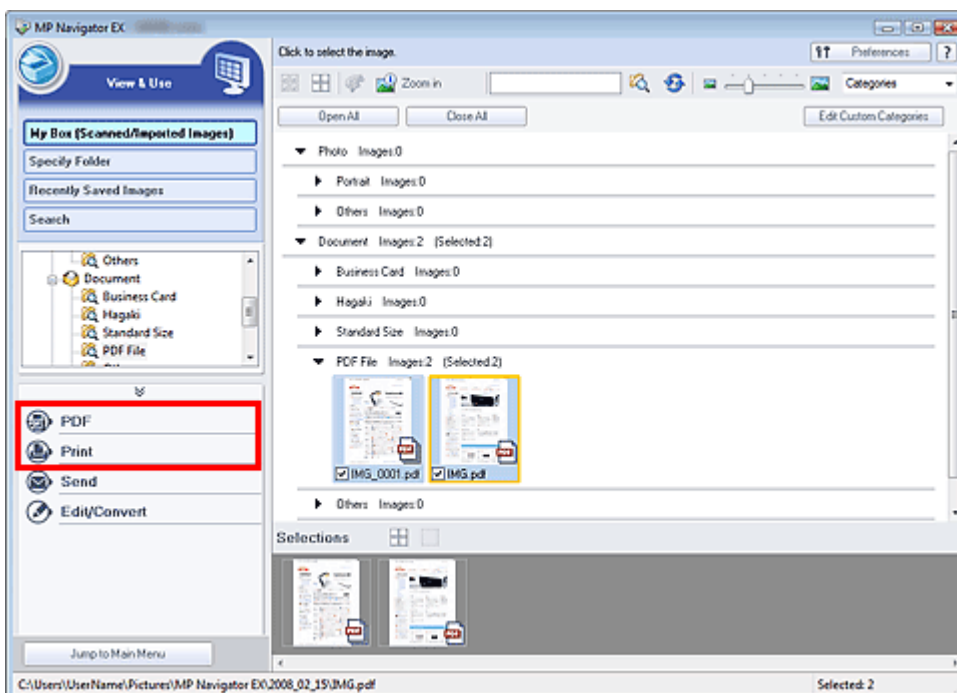

2. To create a PDF file or edit the file, select Create/Edit PDF file on the list. To print the file, click Print Document.

In the Password dialog box, you will be prompted to enter a password.

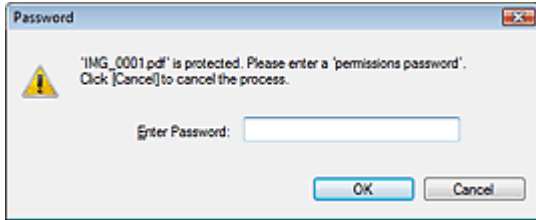

Important

- If the Document Open Password is set as well, the Document Open Password will be required, then the Permissions Password will be required.

3. Enter the password and click OK.

The corresponding dialog box opens.

Important

- If a password-protected PDF file is edited, the passwords will be deleted. Reset the passwords.

➔ [Setting Passwords for PDF Files](#)

Related Topic

▶ [Setting Passwords for PDF Files](#)

[Top of Page](#)↑

Advanced Guide

Advanced Guide > Scanning > Scanning with the Bundled Application Software > MP Navigator EX Screens

MP Navigator EX Screens

Learn about the screens and functions of MP Navigator EX.

Navigation Mode Screen

- ➔ Scan/Import Documents or Images Tab
- ➔ View & Use Images on your Computer Tab
- ➔ Custom Scan with One-click Tab
- ➔ Photos/Documents (Platen) Screen (Scan/Import Window)
 - Scan Settings Dialog Box (Photos/Documents)
 - Save Dialog Box
 - Save as PDF file Dialog Box
 - PDF Settings Dialog Box
- ➔ Memory Card Screen (Scan/Import Window)
- ➔ View & Use Window
 - Create/Edit PDF file Window
 - Print Document Dialog Box
 - Print Photo Dialog Box
 - Send via E-mail Dialog Box
 - Correct/Enhance Images Window

One-click Mode Screen

- ➔ Save Dialog Box (One-Click Mode Screen)
 - Scan Settings Dialog Box
 - Save Dialog Box
 - Exif Settings Dialog Box
- ➔ PDF Dialog Box
 - Save as PDF file Dialog Box
- ➔ Mail Dialog Box
- ➔ OCR Dialog Box
- ➔ Custom Dialog Box

Preferences Dialog Box

- ➔ Scanner Button Settings Tab (Save)

[Top of Page](#)↑

Advanced Guide

Advanced Guide > Scanning > Scanning with the Bundled Application Software > MP Navigator EX Screens > Navigation Mode Screen

Navigation Mode Screen

This is one of the startup screens of MP Navigator EX.

Point to the icon at the top of the screen to display each tab. Use each tab depending on what you want to do.

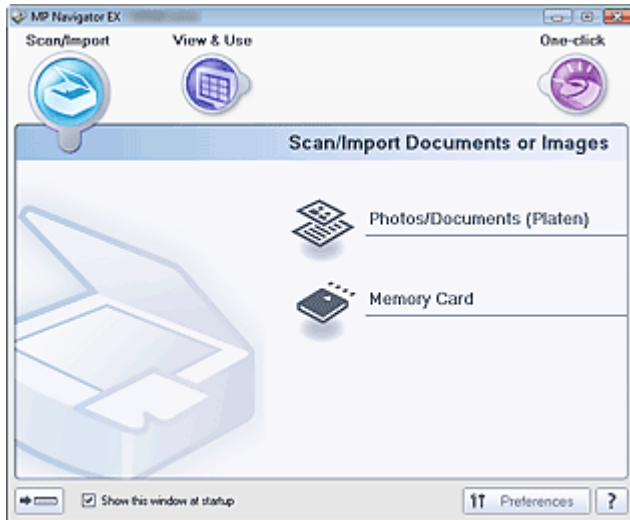

- **Scan/Import**

You can scan photos and documents, or import images saved on memory cards.

➔ [Scan/Import Documents or Images Tab](#)

- **View & Use**

You can open images saved on a computer and print them or attach them to e-mail. You can also edit them using an application that accompanies the machine.

➔ [View & Use Images on your Computer Tab](#)

- **One-click**

You can complete from scanning to saving at one time by simply clicking the corresponding icon.

➔ [Custom Scan with One-click Tab](#)

-  **(Switch Mode)**

Switch to One-click Mode. In One-click Mode, you can complete from scanning to saving, etc. at one time by simply clicking the corresponding icon.

➔ [One-click Mode Screen](#)

- **Show this window at startup**

Select this checkbox to open the Main Menu at startup. If this checkbox is not selected, the last used screen appears.

-  Preferences **Preferences**

The Preferences dialog box opens. In the Preferences dialog box, you can make advanced settings to MP Navigator EX functions.

➔ [Preferences Dialog Box](#)

-  **(Guide)**

Click to open this guide.

[Top of Page](#) ↕

Advanced Guide

Advanced Guide > Scanning > Scanning with the Bundled Application Software > MP Navigator EX Screens > Scan/Import Documents or Images Tab

Scan/Import Documents or Images Tab

Point to Scan/Import in the Navigation Mode screen to display the Scan/Import Documents or Images tab.

You can scan photos and documents, or import images saved on memory cards.

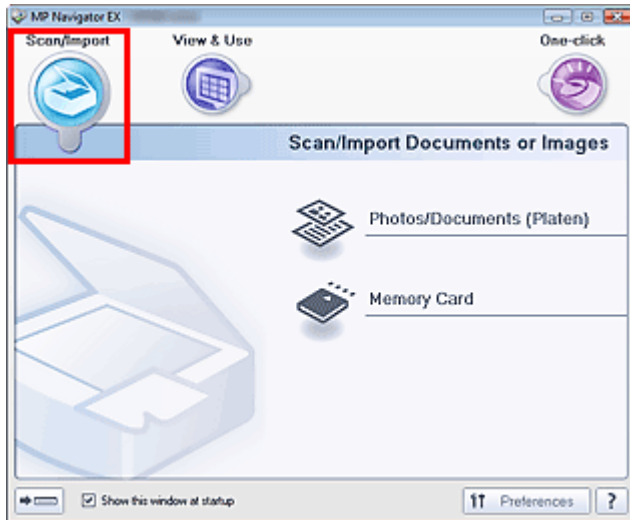

- **Photos/Documents (Platen)**

Click to open the Scan/Import window. Scan photos and documents placed on the Platen.

➔ [Photos/Documents \(Platen\) Screen \(Scan/Import Window\)](#)

- **Memory Card**

Click to open the Scan/Import window with Memory Card selected. Import images saved on memory cards.

➔ [Memory Card Screen \(Scan/Import Window\)](#)

-  **(Switch Mode)**

Switch to One-click Mode screen. In One-click Mode, you can complete from scanning to saving, etc. at one time by simply clicking the corresponding icon.

➔ [One-click Mode Screen](#)

- **Show this window at startup**

Select this checkbox to open the Main Menu at startup. If this checkbox is not selected, the last used screen appears.

-  **Preferences**

The Preferences dialog box opens. In the Preferences dialog box, you can make advanced settings to MP Navigator EX functions.

➔ [Preferences Dialog Box](#)

-  **(Guide)**

Click to open this guide.

[Top of Page](#)↑

Advanced Guide

Advanced Guide > Scanning > Scanning with the Bundled Application Software > MP Navigator EX Screens > View & Use Images on your Computer Tab

View & Use Images on your Computer Tab

Point to View & Use in the Navigation Mode screen to display the View & Use Images on your Computer tab.

You can open images saved on a computer and print them or attach them to e-mail. You can also edit them using an application that accompanies the machine.

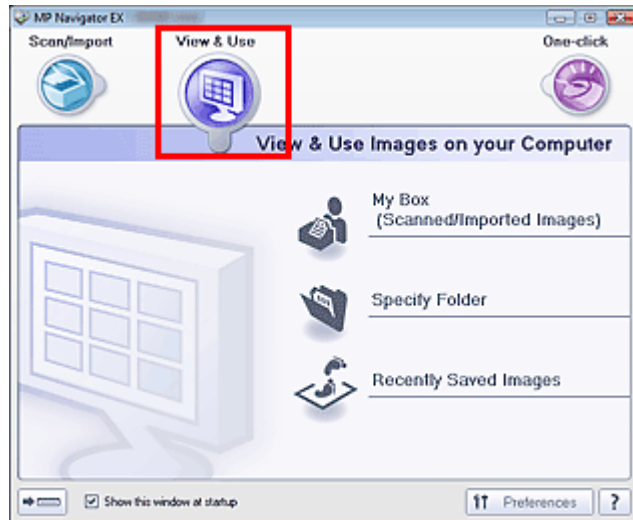

- **My Box (Scanned/Imported Images)**

Click to open the View & Use window with My Box (Scanned/Imported Images) selected.

You can open and use images saved in My Box.

My Box is a specific folder for saving images scanned with MP Navigator EX.

Note

- The following folders are specified by default.
Windows Vista: MP Navigator EX folder in Picture folder
Windows XP: MP Navigator EX folder in My Pictures folder
Windows 2000: MP Navigator EX folder in My Pictures folder

- **Specify Folder**

Click to open the View & Use window with Specify Folder selected.

You can open and use images saved in specific folders.

- **Recently Saved Images**

Click to open the View & Use window with Recently Saved Images selected.

You can open and use images that have been "Scanned/Imported" , "Attached to E-mail" , or "Sent to Application" recently.

Note

- See "View & Use Window" for details on the View & Use window.

-  **(Switch Mode)**

Switch to One-click Mode. In One-click Mode, you can complete from scanning to saving, etc. at one time by simply clicking the corresponding icon.

➔ [One-click Mode Screen](#)

- **Show this window at startup**

Select this checkbox to open the Main Menu at startup. If this checkbox is not selected, the last used screen appears.

-  **Preferences**

The Preferences dialog box opens. In the Preferences dialog box, you can make advanced settings to MP Navigator EX functions.

➔ [Preferences Dialog Box](#)

-  (Guide)

Click to open this guide.

Related Topic

- ▶ [Opening Images Saved on a Computer](#)

[Top of Page](#)↑

Advanced Guide

Advanced Guide > Scanning > Scanning with the Bundled Application Software > MP Navigator EX Screens > Custom Scan with One-click Tab

Custom Scan with One-click Tab

Point to One-click in the Navigation Mode screen to display the Custom Scan with One-click tab.
You can complete from scanning to saving at one time by simply clicking the corresponding icon.

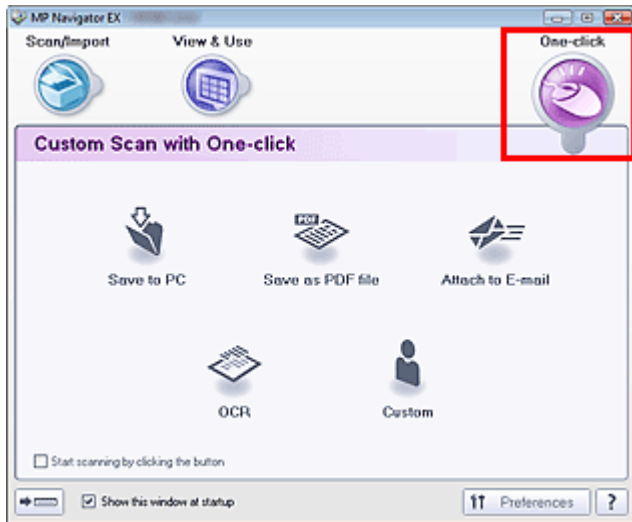

- **Save to PC**

Scan and save documents. Document type is automatically detected. File format is automatically set. Files are saved to a computer.

When you click this icon, the Save dialog box opens and you can specify the scan/save settings.

➔ [Save Dialog Box \(One-Click Mode Screen\)](#)

- **Save as PDF file**

Scan documents and save them as PDF files.

When you click this icon, the PDF dialog box opens and you can specify the scan/save and application settings.

➔ [PDF Dialog Box](#)

- **Attach to E-mail**

Scan documents or photos and attach them to e-mail.

When you click this icon, the Mail dialog box opens and you can specify the scan/save and e-mail software program settings.

➔ [Mail Dialog Box](#)

- **OCR**

Scan text documents then extract and display text in the image on NotePad.

When you click this icon, the OCR dialog box opens and you can specify the scan/save and application settings.

➔ [OCR Dialog Box](#)

Important

- For further procedures, refer to the application's manual.

- **Custom**

Scan documents and open them in a specified application. Document type is automatically detected.

When you click this icon, the Custom dialog box opens and you can specify the scan/save and application settings.



➔ [Custom Dialog Box](#)

Important

- For further procedures, refer to the application's manual.

- **Start scanning by clicking the button**

Select this checkbox and click an icon to start scanning immediately.

-  **(Switch Mode)**
Switch to One-click Mode and the One-click Mode screen opens.
[➔ One-click Mode Screen](#)
- **Show this window at startup**
Select this checkbox to open the Main Menu at startup. If this checkbox is not selected, the last used screen appears.
-  **Preferences**
The Preferences dialog box opens. In the Preferences dialog box, you can make advanced settings to MP Navigator EX functions.
[➔ Preferences Dialog Box](#)
-  **(Guide)**
Click to open this guide.

Important

- The following restrictions apply when you scan with Document Type set to Auto Mode in the Save or Custom dialog box.
Specify Document Type (other than Auto Mode) to extract the text in the image and convert to editable text after scanning.

Related Topic

- ▶ [Easy Scanning with One-click](#)

[Top of Page](#)↑

Advanced Guide

Advanced Guide > Scanning > Scanning with the Bundled Application Software > MP Navigator EX Screens > Photos/Documents (Platen) Screen (Scan/Import Window)

Photos/Documents (Platen) Screen (Scan/Import Window)

Point to Scan/Import in the Navigation Mode screen and click Photos/Documents (Platen).

Open this window to scan documents from the Platen.

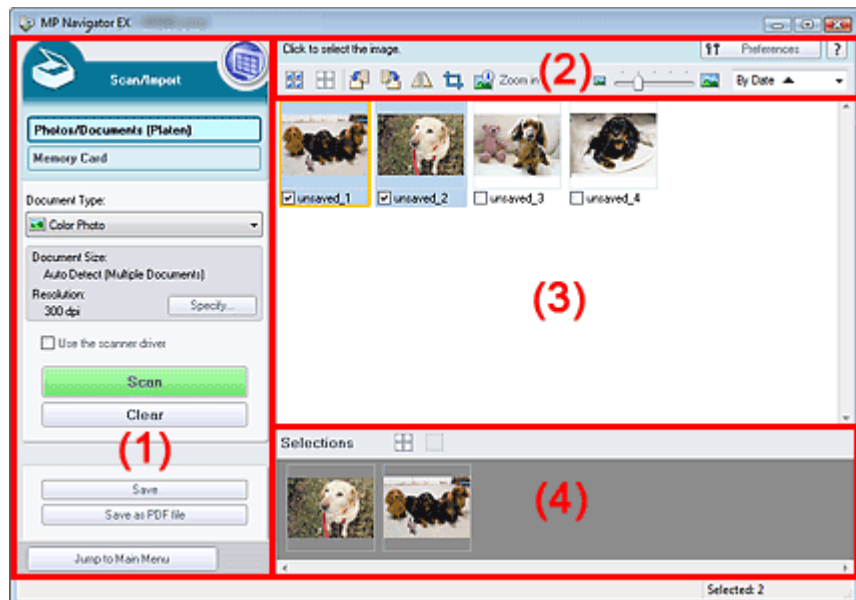

(1) Settings and Operation Buttons

(2) Toolbar

(3) Thumbnail Window

(4) Selected Images Area

Settings and Operation Buttons

-  **(View & Use)**
 Click this when you want to open images and PDF files saved on your computer. The View & Use window opens.
 ➔ [View & Use Window](#)
- Photos/Documents (Platen)**
 Displays the screen for scanning photos, documents, magazines and other printed materials.
- Memory Card**
 Click this when you want to import images saved on a memory card. The screen for importing images from a memory card appears.
 ➔ [Memory Card Screen \(Scan/Import Window\)](#)
- Document Type**
 Select the type of document to be scanned.
 Scanning photos: Color Photo or Black and White Photo
 Scanning text documents: Color Document, Black and White Document or Text(OCR)
 Scanning magazines: Magazine(Color)

Important

- You cannot select Document Type when the Use the scanner driver checkbox is selected.

- Specify...**
 Specify the document size, resolution, and other advanced scan settings.
 ➔ [Scan Settings Dialog Box \(Photos/Documents\)](#)

Important

- Specify... is not available if the Use the scanner driver checkbox is selected.

- **Use the scanner driver**

Select this checkbox when you want to scan with ScanGear (scanner driver). Use ScanGear (scanner driver) to correct images and adjust colors when scanning documents.

- **Scan**

Scanning starts.



Note

- This button changes to Open Scanner Driver when you select the Use the scanner driver checkbox.

- **Open Scanner Driver**

ScanGear (scanner driver) starts.

See "[ScanGear \(Scanner Driver\) Screens](#)" for details on ScanGear (scanner driver) screens.



Note

- This button changes to Scan when you deselect the Use the scanner driver checkbox.

- **Clear**

Delete all images in the Thumbnail window.



Important

- Images not saved on a computer will be deleted. To keep important images, use Save or other methods to save them to a computer before clicking Clear.

- **Save**







Save the selected images. Click to open the [Save Dialog Box](#) and specify the save settings.

- **Save as PDF file**

Save the selected images as PDF files. Click to open the [Save as PDF file Dialog Box](#) and specify the save settings.

-  **Jump to Main Menu**
Jump to the Main Menu.

Toolbar

-  **Preferences**
The Preferences dialog box opens. In the Preferences dialog box, you can make advanced settings to MP Navigator EX functions.
[➔ Preferences Dialog Box](#)
-  **(Guide)**
Click to open this guide.
- **Edit Tools**
 -  **(Select All)**
Selects all images in the Thumbnail window.
 -  **(Cancel All)**
Cancels all image selections in the Thumbnail window.
 -  **(Rotate Left)**
Rotates the target image (outlined in orange) 90 degrees counter-clockwise.
 -  **(Rotate Right)**
Rotates the target image (outlined in orange) 90 degrees clockwise.
 -  **(Invert)**

Inverts the target image (outlined in orange) horizontally.

-  **(Trimming)**

Trims the target image (outlined in orange) in the Thumbnail window. Trimming is the act of selecting the area you want to keep in a photo and discarding the rest. Click this button to open the Crop window and specify the trimming frame.

-  **Zoom in**

Enlarges the target image (outlined in orange). You can also enlarge the image by double-clicking it.

-  **(Display Size)**

Changes the size of images in the Thumbnail window.

-  **(Sort by)**

Sorts the images in the Thumbnail window by category or by date (ascending or descending).

Thumbnail Window

- **Thumbnail Window**

Images scanned from the Platen are displayed.

When you select the checkbox of an image, the image appears in the Selected Images area.

Important

- Thumbnails may appear as "?" when there is not enough memory to display the images.

When Images are Sorted by Categories

-  **Open All**

Displays all images.

-  **Close All**

Hides all images.

Selected Images Area

-  **(Cancel All)**

Cancels the selection of all images in the Selected Images area.

-  **(Cancel Selection)**

Cancels the selection of the target image (outlined in orange) in the Selected Images area.

- **Selected Images Area**

Images selected in the Thumbnail window are displayed.

Related Topic

- ▶ [Scanning Photos and Documents](#)

[Top of Page](#)↑

Advanced Guide

Advanced Guide > Scanning > Scanning with the Bundled Application Software > MP Navigator EX Screens > Scan Settings Dialog Box (Photos/Documents)

Scan Settings Dialog Box (Photos/Documents)

The Scan Settings dialog box opens when you click Specify... in the Scan/Import window.

In the Scan Settings dialog box, you can make advanced scan settings.

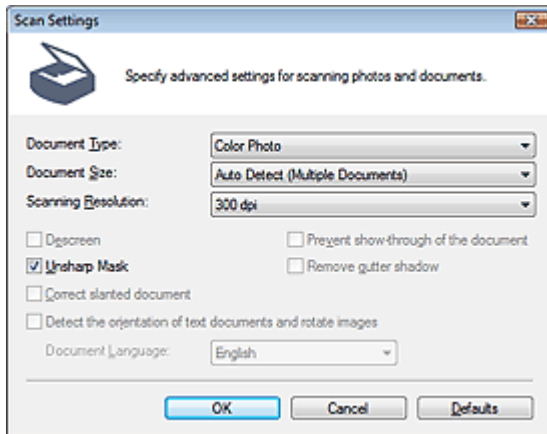

• Document Type

Select the type of document to be scanned.

Scanning photos: Color Photo or Black and White Photo

Scanning text documents: Color Document, Black and White Document or Text(OCR)

Scanning magazines: Magazine(Color)



Important

- To scan correctly, select a document type that matches the document to be scanned.

• Document Size

Select the size of the document to be scanned.

When you select Custom, a dialog box in which you can specify the document size opens. Select a Units, then enter the Width and Height and click OK.

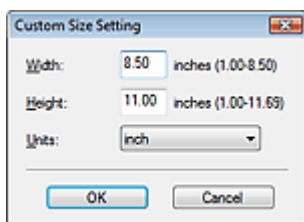

Important

- When you select Auto Detect, the image may not be scanned at the correct position and size. In that case, change the size to the actual document size (A4, Letter, etc.) and align a corner of the document with the corner at the arrow of the Platen. See "[Placing Documents](#)" for details on how to place documents.
- You cannot select Auto Detect (Multiple Documents) or Auto Detect when Document Type is Text(OCR).

• Scanning Resolution

Select the resolution at which to scan documents.

➔ Resolution



Note

- The following scanning resolutions can be specified when Document Type is Text(OCR).
300 dpi / 400 dpi

• Descreen

Select this checkbox to reduce moire patterns.

Printed photos and pictures are displayed as a collection of fine dots. Moire is a phenomenon where

dots may interfere with each other and cause uneven gradation and a stripe pattern in the image. Descreen is the function for reducing this moire effect.

Important

- You cannot select this checkbox when Document Type is Color Photo, Black and White Photo or Text(OCR).

Note

- Scanning takes longer than usual when you enable Descreen.

• Unsharp Mask

Select this checkbox to emphasize the outline of the subjects and sharpen the image.

Important

- You cannot select this checkbox when Document Type is Text(OCR).

• Prevent show-through of the document

Select this checkbox to sharpen text in a document or reduce show-through in newspapers.

Important

- You cannot select this checkbox when Document Type is Color Photo, Black and White Photo or Text(OCR).
- Select this checkbox when Document Type is text document and show-through is apparent in the scanned image.

• Remove gutter shadow

Select this checkbox to correct shadows that appear between pages when scanning open booklets.

Important

- Align the document correctly with the marks on the Platen.
- Gutter shadows can be corrected only when Document Size is set to a standard size.
- You cannot select this checkbox when Document Size is Auto Detect, Auto Detect (Multiple Documents) or Stitch Assist.

Note

- Use ScanGear's Advanced Mode tab to correct gutter shadows when scanning non-standard size documents or when custom cropping frames are set.
For details, see Gutter Shadow Correction in "[Image Settings](#)" (ScanGear's Advanced Mode tab).

• Correct slanted document

Select this checkbox to detect the scanned text and correct the angle (within -0.1 to -10 degrees or +0.1 to +10 degrees) of the document.

Important

- You cannot select this checkbox when Document Type is Color Photo, Black and White Photo.
- You cannot select this checkbox when Document Size is Stitch Assist.
- The inclination of the following types of documents may not be corrected, as the text cannot be detected correctly.
 - Documents in which the text lines are inclined more than 10 degrees or the angles vary by line.
 - Documents containing both vertical and horizontal text.
 - Documents with extremely large or small fonts.
 - Documents with small amount of text.
 - Documents containing figures/images or hand-written text.
 - Documents containing both vertical and horizontal lines (tables).

Note

- Scanning takes longer than usual when you enable Correct slanted document.

• Detect the orientation of text documents and rotate images

Select this checkbox to detect the orientation of the document from the scanned text and rotate the scanned image to the correct orientation. Select the language of the document to be scanned in Document Language.

Important

- You cannot select this checkbox when Document Type is Color Photo, Black and White Photo.
- You cannot select this checkbox when Document Size is Stitch Assist.
- This function may not work properly depending on the document language. Only text documents written in languages that can be selected from Document Language are supported.
- The orientation of the following types of documents may not be corrected, as the text cannot be detected correctly. In that case, select the scanned image in the Thumbnail window of the [Photos/Documents \(Platen\) Screen \(Scan/Import Window\)](#) and rotate it with Edit Tools.
 - Resolution is outside the range of 300 dpi to 600 dpi.
 - Font size is outside the range of 8 points to 48 points.
 - Documents containing special fonts, effects, italics, or hand-written text.
 - Documents with patterned backgrounds.



Note

- Scanning takes longer than usual when you enable Detect the orientation of text documents and rotate images.

• Document Language

Select the language of the document to be scanned.



Important

- You cannot select this checkbox when Document Type is Color Photo, Black and White Photo.
- You cannot select this checkbox when Document Size is Stitch Assist.

• Defaults

Click to restore the default settings.

[Top of Page](#)↑

Advanced Guide

Advanced Guide > Scanning > Scanning with the Bundled Application Software > MP Navigator EX Screens > Save Dialog Box

Save Dialog Box

The Save dialog box opens when you click Save in the Scan/Import window.

In the Save dialog box, you can make settings for saving images to a computer.

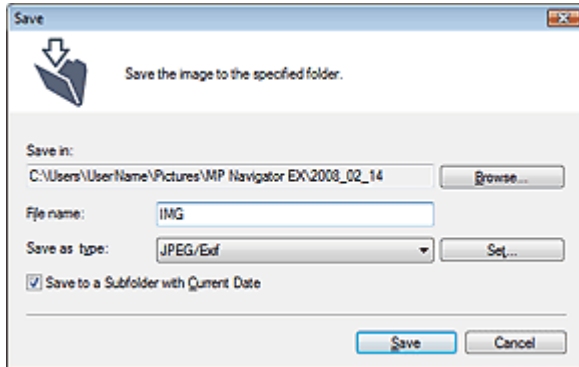

- **Save in**

Displays the folder in which to save the scanned images. To change the folder, click Browse... to specify another one.

The following folders are specified by default.

Windows Vista: MP Navigator EX folder in Picture folder

Windows XP: MP Navigator EX folder in My Pictures folder

Windows 2000: MP Navigator EX folder in My Pictures folder



Important

- When saving to a memory card, enable writing on the Card Slot of the machine. For details on how to enable writing, refer to "[Setting Up the Card Slot as the Memory Card Drive of the Computer.](#)"

- **File name**

Enter the file name of the image to be saved (up to 32 characters). When saving multiple files, 4 digits are appended to each file name.

- **Save as type**

Select a file type to save the scanned images.

Select JPEG/Exif, TIFF or BMP.



Important

- You cannot select JPEG/Exif when Document Type is Text(OCR).

- **Set...**

You can specify a compression type for JPEG files.

Select High(Low Compression), Standard or Low(High Compression).



Important

- This setting is available only when Save as type is JPEG/Exif.

- **Save to a Subfolder with Current Date**

Select this checkbox to create a subfolder in the folder specified in Save in with the current date and save imported files in it. A subfolder with a name such as "2008_01_01" (Year_Month_Date) will be created.

If this checkbox is not selected, files are saved directly in the folder specified in Save in.

[Top of Page](#)↑

Advanced Guide

Advanced Guide > Scanning > Scanning with the Bundled Application Software > MP Navigator EX Screens > Save as PDF file Dialog Box

Save as PDF file Dialog Box

In the Save as PDF file dialog box, you can make advanced settings for saving scanned images as PDF files. You can save multiple documents as one PDF file or add pages to a PDF file created with MP Navigator EX.

Important

- You cannot save images scanned at 10501 pixels or more in the vertical and horizontal directions.

Dialog box that opens when Save as PDF file in the Scan/Import window is clicked

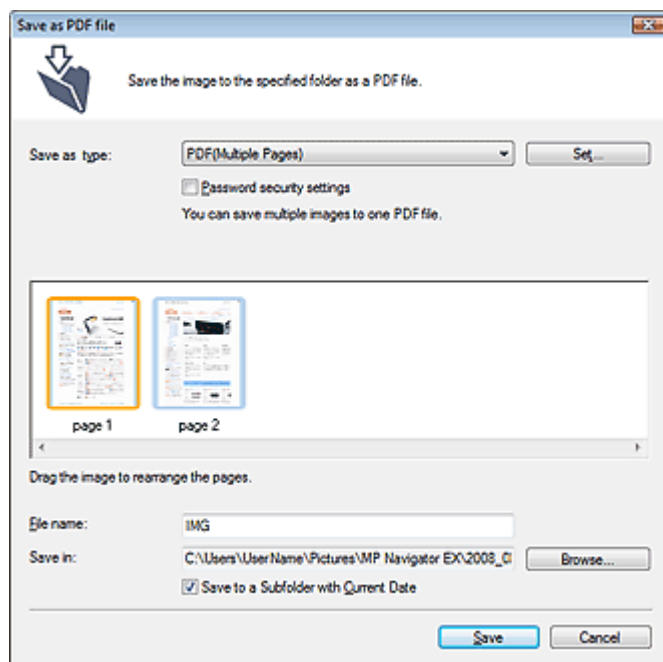

Dialog box that opens when Save Selected Pages or Save All Pages is clicked in the Create/Edit PDF file window

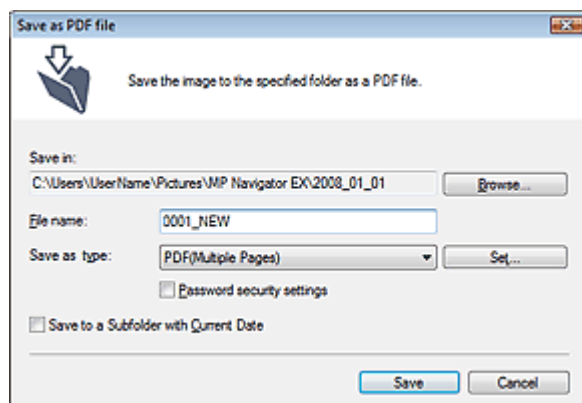

• Save as type

Select a PDF file type to save the scanned images.

- **PDF**
Save each of the selected images as a separate PDF file.
- **PDF(Multiple Pages)**
Save multiple images in one PDF file.

Important

- PDF(Multiple Pages) is displayed when multiple images are selected.

- **PDF(Add Page)**

Add the scanned images to a PDF file. The images are added to the end of the PDF file. You cannot rearrange the pages of the PDF file to which the images are added.

**Important**

- Images can only be added to PDF files created with MP Navigator EX. You cannot specify PDF files created with other applications. PDF files edited in other applications cannot be specified as well.
- If a password-protected PDF file is edited, the passwords will be deleted. Reset the passwords.
 - ➔ [Setting Passwords for PDF Files](#)

- **Set...**

Make advanced settings for creating PDF files.
See "[PDF Settings Dialog Box](#)" for details.

- **Password security settings**

Select this checkbox to open the Password Security -Settings dialog box in which you can set passwords for opening, editing and printing created PDF files.

➔ [Setting Passwords for PDF Files](#)

- **Add to**

This is displayed when you select PDF(Add Page) for Save as type and specify the PDF file to which images are added. To change the file, click Browse... to specify another one.

**Important**

- Images can only be added to PDF files created with MP Navigator EX. You cannot specify PDF files created with other applications. PDF files edited in other applications cannot be specified as well.

- **File name**

Enter the file name of the image to be saved (up to 32 characters). When saving multiple files, 4 digits are appended to each file name.

- **Save in**

Displays the folder in which to save the PDF files. To change the folder, click Browse... to specify another one.

The following folders are specified by default.

Windows Vista: MP Navigator EX folder in Picture folder

Windows XP: MP Navigator EX folder in My Pictures folder

Windows 2000: MP Navigator EX folder in My Pictures folder

- **Save to a Subfolder with Current Date**

Select this checkbox to create a subfolder in the folder specified in Save in with the current date and save imported files in it. A subfolder with a name such as "2008_01_01" (Year_Month_Date) will be created.

If this checkbox is not selected, files are saved directly in the folder specified in Save in.

[Top of Page](#)↑

Advanced Guide

Advanced Guide > Scanning > Scanning with the Bundled Application Software > MP Navigator EX Screens > PDF Settings Dialog Box

PDF Settings Dialog Box

In the PDF Settings dialog box, you can specify the PDF compression type and other advanced settings for creating PDF files.

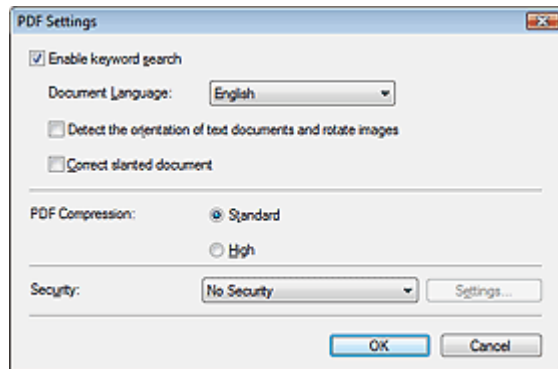

- **Enable keyword search**

Select this checkbox to convert characters in a document to text data. This will enable an easy search by keyword.

- **Document Language**

Select the language of the document to be scanned.

- **Detect the orientation of text documents and rotate images**

Select this checkbox to detect the orientation of the document from the scanned text and rotate the scanned image to the correct orientation.

Important

- This function may not work properly depending on the document language. Only text documents written in languages that can be selected from Document Language are supported.
- The orientation of the following types of documents may not be corrected, as the text cannot be detected correctly.
 - Resolution is outside the range of 300 dpi to 600 dpi.
 - Font size is outside the range of 8 points to 48 points.
 - Documents containing special fonts, effects, italics, or hand-written text.
 - Documents with patterned backgrounds.

- **Correct slanted document**

Select this checkbox to detect the scanned text and correct the angle (within -0.1 to -10 degrees or +0.1 to +10 degrees) of the document.

Important

- The inclination of the following types of documents may not be corrected, as the text cannot be detected correctly.
 - Documents in which the text lines are inclined more than 10 degrees or the angles vary by line.
 - Documents containing both vertical and horizontal text.
 - Documents with extremely large or small fonts.
 - Documents with small amount of text.
 - Documents containing figures/images or hand-written text.
 - Documents containing both vertical and horizontal lines (tables).

- **PDF Compression**

Select a compression type for saving.

- **Standard**

It is recommended that you normally select this setting.

- **High**

Compresses the file size when saving, allowing you to reduce the load on your network/server.

Note

- The following images can be compressed with high efficiency.
 - Images with resolutions within the range of 75 dpi to 600 dpi.
-

- **Security**

Set passwords for opening, editing and printing the created PDF files.

**Important**

- Internet Explorer 5.5 Service Pack 2 or later is required to use this function.
- This function is not available when images are automatically saved after scanning, such as when scanning from the One-click Mode screen or scanning using the Operation Panel of the machine.

**Note**

- Select Password Security and set passwords in the Password Security -Settings dialog box.
 - ➔ [Setting Passwords for PDF Files](#)
-

[Top of Page](#)↑

Advanced Guide

Advanced Guide > Scanning > Scanning with the Bundled Application Software > MP Navigator EX Screens > Memory Card Screen (Scan/Import Window)

Memory Card Screen (Scan/Import Window)

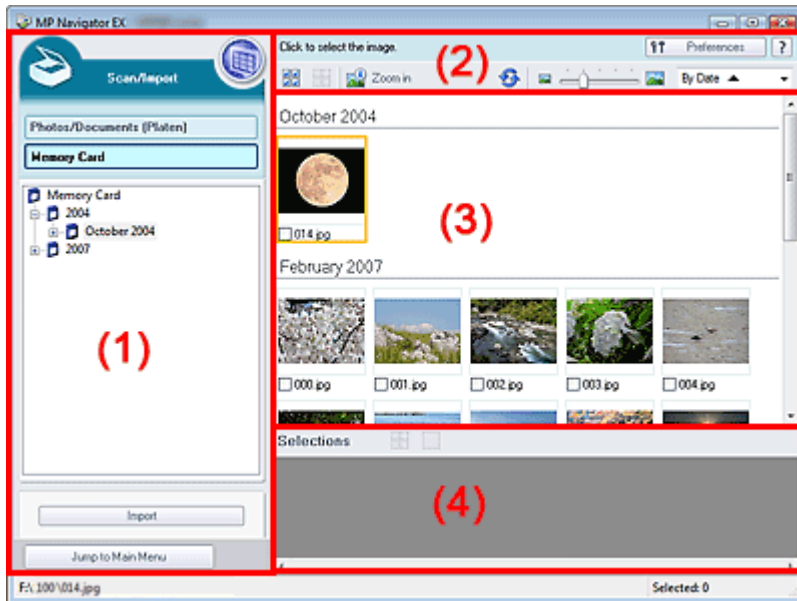

Point to Scan/Import in the Navigation Mode screen and click Memory Card, or click Memory Card in the Scan/Import window.

Open this window to import images (including PDF files scanned with the operation pannel) saved on a memory card.



- (1) Settings and Operation Buttons
- (2) Toolbar
- (3) Thumbnail Window
- (4) Selected Images Area

Settings and Operation Buttons

-  **(View & Use)**
Click this when you want to open images and PDF files saved on your computer. The View & Use window opens.
➔ [View & Use Window](#)
- **Photos/Documents (Platen)**
Click this when you want to scan photos, documents, magazines and other printed materials. The screen for scanning photos and documents appears.
➔ [Photos/Documents \(Platen\) Screen \(Scan/Import Window\)](#)
- **Memory Card**
Displays folders of images and PDF files (grouped by year, year/month and year/month/date) on a memory card in tree view. Select a folder to display its contents in the Thumbnail window to the right. File date is the captured or updated date.
- **Import**
Click to import the selected images and open them in the View & Use window.
➔ [View & Use Window](#)
-  **Jump to Main Menu**
Jump to the Main Menu.

Toolbar

-  Preferences **Preferences**

The Preferences dialog box opens. In the Preferences dialog box, you can make advanced settings to MP Navigator EX functions.

➔ [Preferences Dialog Box](#)

-  **(Guide)**

Click to open this guide.

- **Edit Tools**

-  **(Select All)**

Selects all images in the Thumbnail window.

-  **(Cancel All)**

Cancels all image selections in the Thumbnail window.

-  **Zoom in**

Enlarges the target image (outlined in orange). You can also enlarge the image by double-clicking it. You can check all pages when you select a PDF file.

-  **(Refresh)**

Refreshes the Thumbnail window contents.

-  **(Display Size)**

Changes the size of images in the Thumbnail window.

-  **(Sort by)**

Sorts the images in the Thumbnail window by date (ascending or descending).

Thumbnail Window

- **Thumbnail Window**

Images saved on the memory card are displayed by year or year/month.

When you select the checkbox of an image, the image appears in the Selected Images area.

Selected Images Area

-  **(Cancel All)**

Cancels the selection of all images in the Selected Images area.

-  **(Cancel Selection)**

Cancels the selection of the target image (outlined in orange) in the Selected Images area.

- **Selected Images Area**

Images selected in the Thumbnail window are displayed.

Related Topic

▶ [Importing Images Saved on a Memory Card](#)

[Top of Page](#)↑

Advanced Guide

Advanced Guide > Scanning > Scanning with the Bundled Application Software > MP Navigator EX Screens > View & Use Window

View & Use Window

In the Navigation Mode screen, point to View & Use and click My Box (Scanned/Imported Images), Specify Folder or Recently Saved Images.

Open this window to display or use scanned images or images saved on a computer.

Important

- For PDF files, only those created with MP Navigator EX are displayed. You cannot display PDF files created with other applications. PDF files edited in other applications cannot be displayed as well.

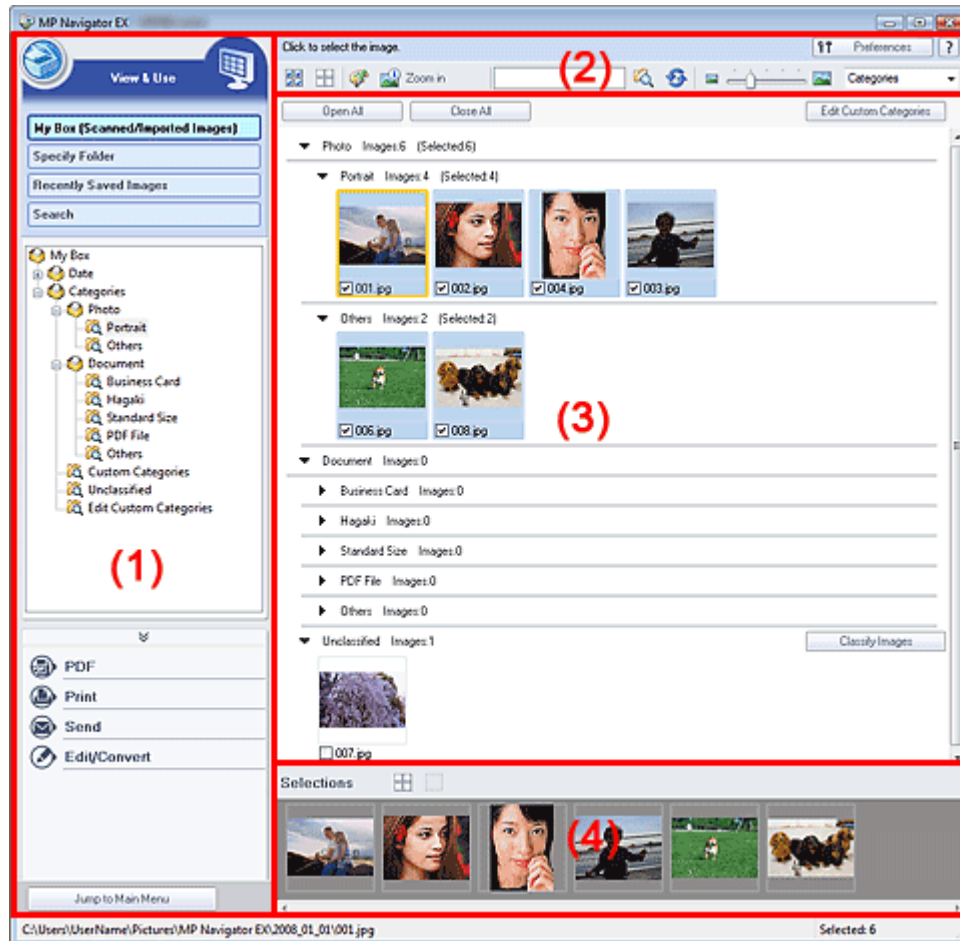

- (1) Settings and Operation Buttons
- (2) Toolbar
- (3) Thumbnail Window
- (4) Selected Images Area

Settings and Operation Buttons

-  **(Scan/Import)**
 Click this when you want to scan photos, documents, magazines and other printed materials. The Scan/Import window opens.
 ➔ Photos/Documents (Platen) Screen (Scan/Import Window)
- My Box (Scanned/Imported Images)**
 Displays folders of images (grouped by year, year/month, year/month/date and category) in My Box in tree view. Select a folder to display its contents in the Thumbnail window to the right. Image date is the scanned, captured or updated date.
- Specify Folder**

Displays all hard disks and folders in tree view. Select a folder to display images in the Thumbnail window to the right.

- **Recently Saved Images**

Images that have been "Scanned/Imported", "Attached to E-mail" or "Sent to Application" recently are displayed in tree view by date. For "Scanned/Imported" images, "Scanned from the Machine" and "Imported from Memory Cards" are displayed separately. Select a Year/Month/Day folder to display images by date in the Thumbnail window to the right. Image date is the scanned or sent date.

- **Search**

The advanced search options open.

➔ [Searching Images](#)

- **Task Button Area**

Specify what to do with the selected images. See the corresponding sections below for details on each button.

➔ [Creating/Editing PDF Files](#)

➔ [Printing Documents](#)

➔ [Printing Photos](#)

➔ [Sending via E-mail](#)

➔ [Editing Files](#)



Note

- The buttons in the Task Button area are displayed when the corresponding applications are installed.

 Jump to Main Menu

- **Jump to Main Menu**

Jump to the Main Menu.

Toolbar

 Preferences

- **Preferences**

The Preferences dialog box opens. In the Preferences dialog box, you can make advanced settings to MP Navigator EX functions.

➔ [Preferences Dialog Box](#)

 (Guide)

Click to open this guide.

- **Edit Tools**

-  **(Select All)**

Selects all images in the Thumbnail window.

-  **(Cancel All)**

Cancels all image selections in the Thumbnail window.

-  **(Image Correction/Enhancement)**

Allows you to correct the target image (outlined in orange). Click this button to open the Correct/Enhance Images window in which you can correct/enhance images and also adjust the brightness, contrast, etc.

Important

- Image correction/enhancement cannot be applied to PDF files or black and white binary files.



Note

- See "[Correct/Enhance Images Window](#)" for details.

-  **Zoom in**

Enlarges the target image (outlined in orange). You can also enlarge the image by double-

clicking it. You can check all pages when you select a PDF file.

You can also check file information such as file name, date, size and security setting. A lock icon appears for PDF files with Document Open Password set.



Note

- See "Opening/Editing Password-protected PDF Files " to open password-protected files.

- (Search)**

Enter a word or phrase included in the file name, Exif information or PDF text of the image you want to search for, then click . For Exif information, text in Maker, Model, Description and User Comment is searched.



Note

- Search images in My Box (Scanned/Imported Images), Recently Saved Images or a selected folder and its subfolders.

- (Refresh)**

Refreshes the Thumbnail window contents.

- (Display Size)**

Changes the size of images in the Thumbnail window.

- (Sort by)**

Sorts the images in the Thumbnail window by category, date (ascending or descending) or name (ascending or descending).
Images can be sorted by category only when My Box (Scanned/Imported Images) or Specify Folder is displayed.

Thumbnail Window

- Thumbnail Window**

Images scanned from the Platen are displayed.

When you select the checkbox of an image, the image appears in the Selected Images area.



Important

- A lock icon appears for PDF files with Document Open Password set.
- Images may appear as "?" in the following cases.
 - Opening unsupported images.
 - File size is too large and there is not enough memory to display the image.
 - The file is corrupted.
- Internet Explorer 5.5 Service Pack 2 or later is required to open password-protected PDF files.

When Images are Sorted by Categories

Images scanned from the Platen are displayed in tree view by category.



Note

- Some images may not be detected correctly and classified to wrong category. In that case, drag and drop an image and move it from one category to another.

- Category name Images: N (Selected: N)**

▼ Photo Images:3 (Selected:1)

▼ Portrait Images:2 (Selected:1)

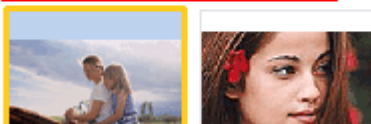

- Category name**

The category name (Photos, Documents, Custom categories, Unclassified, etc.) is displayed.

- **Image: N**
The number of images classified into the category is displayed.
- **(Selected: n)**
The number of images with the checkbox selected is displayed.

**Note**

- This portion is displayed only when one or more images are selected.

-  **Open All**

Displays all images.

-  **Close All**

Hides all images.

-  **Edit Custom Categories**

When My Box (Scanned/Imported Images) or Specify Folder is displayed, click to open the Edit Custom Categories dialog box.

In the Edit Custom Categories dialog box, you can add/delete categories displayed in Custom Categories.

See "[Classifying Images into Categories](#)" for details.

-  **Classify Images**

Images imported from hard disks or memory cards appear in Unclassified. Click Classify Images to classify them automatically.

This button is displayed only when My Box (Scanned/Imported Images) or Specify Folder is displayed.

Selected Images Area

-  **(Cancel All)**

Cancel the selection of all images in the Selected Images area.

-  **(Cancel Selection)**

Cancel the selection of the target image (outlined in orange) in the Selected Images area.

- **Selected Images Area**

Images selected in the Thumbnail window are displayed.

Related Topic

- ▶ [Opening Images Saved on a Computer](#)

[Top of Page](#)↑

Advanced Guide

Advanced Guide > Scanning > Scanning with the Bundled Application Software > MP Navigator EX Screens > Create/Edit PDF file Window

Create/Edit PDF file Window

Click PDF in the View & Use window, then click Create/Edit PDF file on the list to open the Create/Edit PDF file window.

In the Create/Edit PDF file window, you can add/delete pages and rearrange the page order of PDF files created with MP Navigator EX.

Important

- You cannot save images scanned at 10501 pixels or more in the vertical and horizontal directions.
- If a password-protected PDF file is edited, the passwords will be deleted. Reset the passwords.
 ➔ [Setting Passwords for PDF Files](#)

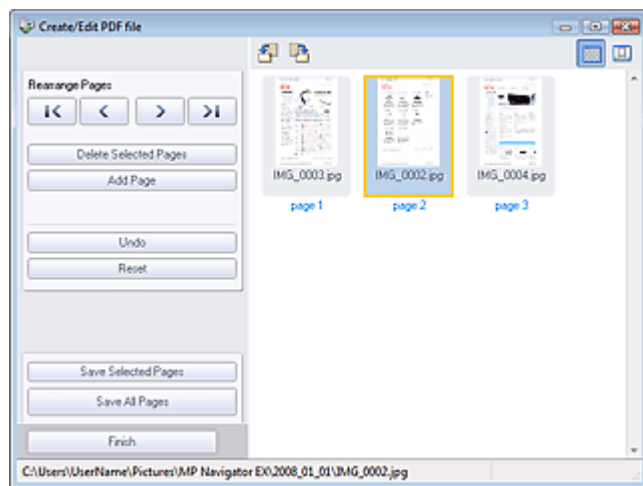

• Rearrange Pages

You can move the selected image (outlined in orange).



- Moves the selected image to the top.



- Moves the selected image up one page.



- Moves the selected image down one page.



- Moves the selected image to the end.

Note

- You can also drag and drop the image to rearrange the order.

• Delete Selected Pages

Deletes the selected image.

• Add Page

Allows you to select and add an existing PDF file.

Note

- A password will be required to add a password-protected PDF file.

• Undo

Cancels the latest change made.

- **Reset**

Cancels all the changes made.

- **Save Selected Pages**

Opens the Save as PDF file dialog box. Specify the save settings. Only the selected page is saved.



Note

- When multiple pages are selected, a multiple-page PDF file is created.
- See "[Save as PDF file Dialog Box](#)" for details on the Save as PDF file dialog box.

- **Save All Pages**

Opens the Save as PDF file dialog box. Specify the save settings. All PDF files in the list will be saved as one PDF file.

- **Finish**

Closes the Create/Edit PDF file window.

- **Toolbar**



- **(Rotate Left)**

Rotates the file 90 degrees counter-clockwise.



- **(Rotate Right)**

Rotates the file 90 degrees clockwise.



- **(Preview Mode)**

Switches to Preview Mode.

The selected file appears in Preview.

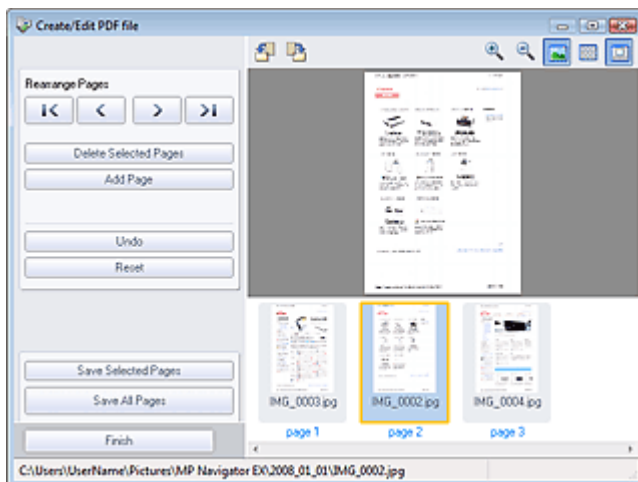

- **(Enlarge)**

Enlarges the image displayed in Preview.



- **(Reduce)**

Reduces the image displayed in Preview.



- **(Full-screen)**

Enlarges/reduces the image to display it fully in Preview.



- **(Thumbnail Mode)**

Switches to Thumbnail Mode. Thumbnails of files are displayed.

[Top of Page](#)↑

Advanced Guide

Advanced Guide > Scanning > Scanning with the Bundled Application Software > MP Navigator EX Screens > Print Document Dialog Box

Print Document Dialog Box

Click Print in the View & Use window, then click Print Document on the list to open the Print Document dialog box.

In the Print Document dialog box, you can make advanced settings for printing multiple scanned images at one time.

Note

- The setting items in the Print Document dialog box vary by printer.

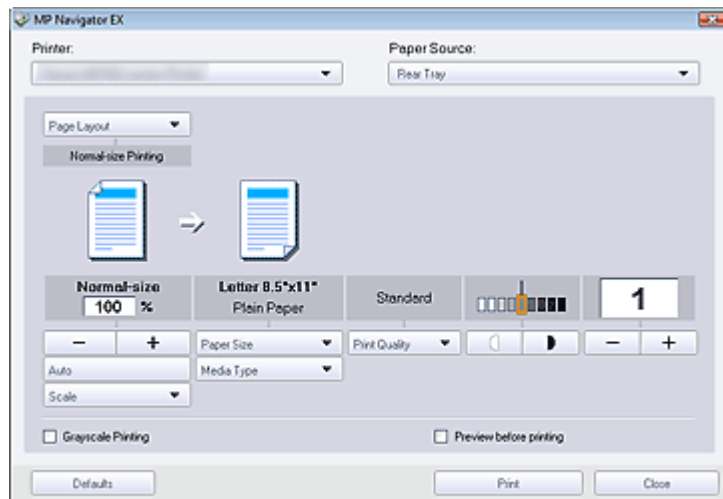

- **Printer**
Select the printer to use.
- **Paper Source**
Select paper source.
- **Page Layout**
Select a print type.
 - **Normal-size Printing**
Print one image per sheet.
 - **Scaled Printing**
Print images at the selected scale (enlarged or reduced).
 - **Fit-to-Page Printing**
Print an image at the paper size (enlarged or reduced).
 - **Borderless Printing**
Print the image on an entire sheet of paper without margins.
 - **Page Layout Printing (2 on 1)**
Layout and print two images on a sheet of paper.
 - **Page Layout Printing (4 on 1)**
Layout and print four images on a sheet of paper.
- **Enlarge/Reduce**
Enlarge or reduce images to print.



- Print a reduced or enlarged image by specifying a scale in increments of 1%.
- **100% Normal-size**
Print the image in normal size.
- **Scaled Printing**
Select a scale from the list.

- **Auto**

Scale is adjusted automatically according to the detected paper width and the selected paper size. Image may be printed rotated 90 degrees depending on its size.

**Important**

- At 100% Normal-size, some images may be printed small or with some portions cropped. In that case, select Auto to resize the print in proportion to the paper size.

- **Paper Size**

Select the size of paper for printing. Match the size to the size of the paper set in the machine.

**Note**

- Selectable paper sizes depend on the selected printer.

- **Media Type**

Select the type of paper for printing. Print quality may be fixed depending on the paper type.

**Note**

- Selectable paper types depend on the selected printer.

- **Print Quality**

Select the print quality.

- **Density**

Click  to select the print density.

Density cannot be changed for images scanned with Document Type set to Text(OCR).

- **Copies**

Click  to select the number of copies to be printed.

- **Grayscale Printing**

Select this checkbox to print the document in black and white.

- **Preview before printing**

Select this checkbox to display the print result before printing.

- **Defaults**

Click to restore the default settings.

- **Print**

Click to start printing with the specified settings.

**Note**

- To cancel while spooling, click Cancel. To cancel while printing, select the printer icon on the taskbar and click Cancel Printing.

[Top of Page](#)↑

Advanced Guide

Advanced Guide > Scanning > Scanning with the Bundled Application Software > MP Navigator EX Screens > Print Photo Dialog Box

Print Photo Dialog Box

Click Print in the View & Use window, then click Print Photo on the list to open the Print Photo dialog box.

Important

- The Print Photo dialog box will not open if Easy-PhotoPrint EX is installed.
- PDF files cannot be printed.

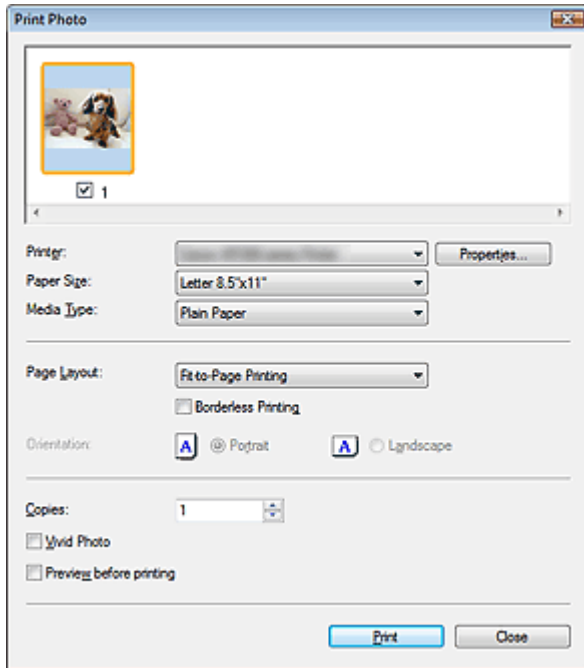

Note

- Double-click an image to display it in a different window.

Printer

Select the printer to use.

Properties...

Display the selected printer's advanced setting screen.

Paper Size

Select the size of paper for printing. Match the size to the size of the paper set in the machine.

Media Type

Select the type of paper for printing. Print quality may be fixed depending on the paper type.

Page Layout

Select a print type.

• Normal-size Printing

Print one image per sheet.

• Fit-to-Page Printing

Print an image at the paper size (enlarged or reduced).

Borderless Printing

Select this checkbox to print the image on an entire sheet of paper without margins.

Important

- Page Layout setting will be disabled when you select Borderless Printing.
- This setting is only available with printers that support borderless printing.

Orientation

Specify the print orientation.

**Important**

- This setting is available only when Page Layout is Normal-size Printing. For others, the image is automatically rotated according to the aspect ratio of the paper.

• Copies

Specify the number of copies to print.

• Vivid Photo

Select this checkbox to print the image in vivid colors.

• Preview before printing

Select this checkbox to display the print result before printing.

• Print

Click to start printing.

**Note**

- Only the images in the Thumbnail window with the checkbox selected are printed.

• Close

Closes the dialog box without printing the photo.

[Top of Page](#)↑

Advanced Guide

Advanced Guide > Scanning > Scanning with the Bundled Application Software > MP Navigator EX Screens > Send via E-mail Dialog Box

Send via E-mail Dialog Box

Click Send in the View & Use window, then click Attach to E-mail on the list to open the Send via E-mail dialog box.

In the Send via E-mail, you can make advanced settings for attaching images to e-mail.

Important

- MP Navigator EX is compatible with the following e-mail software programs:
 - Windows Mail (Windows Vista)
 - Outlook Express (Windows XP/Windows 2000)
 - Microsoft Outlook
 - EUDORA
 - Netscape Mail
 (If an e-mail software program does not operate properly, check that the program's MAPI is enabled. To enable MAPI, refer to the manual of the e-mail software program.)

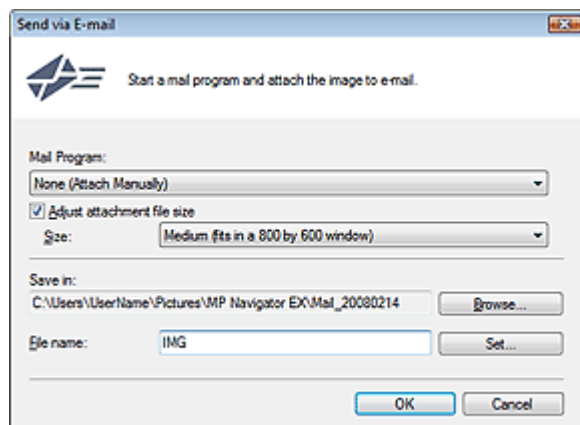

• Mail Program

The e-mail software program set up via Preferences in the Navigation Mode screen is displayed. Select the e-mail software program you want to use.

• Adjust attachment file size

When Save as type is JPEG, selecting this checkbox allows you to resize the images. Select a size from Size.

• Save in

Displays the folder in which to save the images. To change the folder, click Browse... to specify another one. If resized, the resized images are saved.

The following folders are specified by default.

Windows Vista: MP Navigator EX folder in Picture folder

Windows XP: MP Navigator EX folder in My Pictures folder

Windows 2000: MP Navigator EX folder in My Pictures folder

• File name

Enter the file name of the image to be attached (up to 32 characters). When saving multiple files, 4 digits are appended to each file name.

• Set...

You can specify a compression type for JPEG files.

Select High(Low Compression), Standard or Low(High Compression).

[Top of Page](#) 

Advanced Guide

Advanced Guide > Scanning > Scanning with the Bundled Application Software > MP Navigator EX Screens > Correct/Enhance Images Window

Correct/Enhance Images Window

Click  (Image Correction/Enhancement) in the View & Use window or click Fix photo images in the Task Button area to open the Correct/Enhance Images window.

In the Correct/Enhance Images window, you can make advanced settings including image correction/enhancement and brightness/contrast adjustment.

You can also display the source image and corrected image side by side for comparison.

Important

- Image correction/enhancement cannot be applied to PDF files or black and white binary files.

Note

- The Correct/Enhance Images window can also be opened by clicking  (Image Correction/Enhancement) on the Toolbar or in the Zoom in dialog box.
- It may take a while to correct large images.



(1) Task Area

(2) Toolbar

Task Area

Available tasks and settings vary between the Auto and Manual tabs.

Click Auto or Manual to open the corresponding tab.

Auto Tab

Use the functions in the Auto tab to apply corrections and enhancements to the entire image.

See "[Correcting/Enhancing Images Automatically](#)" for details.

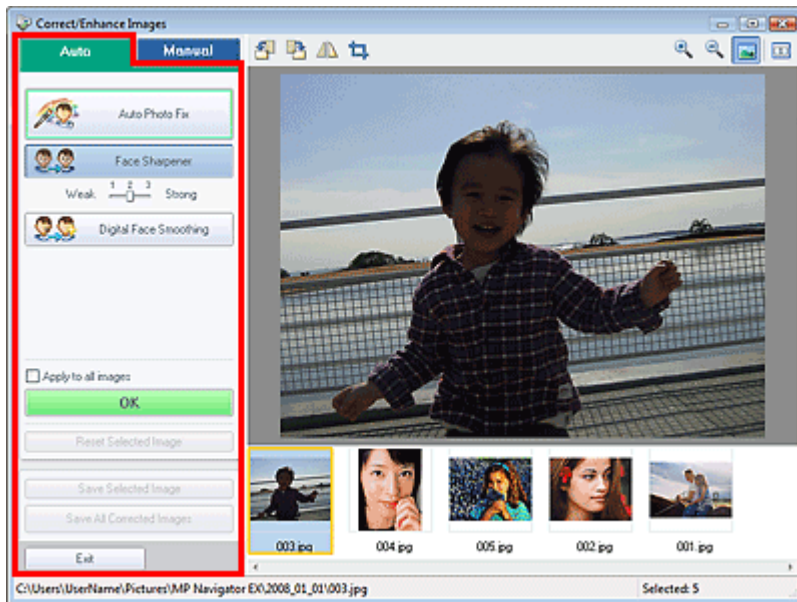

- **Auto Photo Fix**
Applies automatic corrections suitable for photos.
- **Face Sharpener**
Sharpens out-of-focus faces. You can adjust the effect level using the slider.
- **Digital Face Smoothing**
Enhances skin beautifully by removing blemishes and wrinkles. You can adjust the effect level using the slider.
- **Apply to all images**
Applies the correction to all images.
- **OK**
Applies the selected effect to the selected image or all images.
- **Reset Selected Image**
Cancels all corrections and enhancements applied to the selected image.
- **Save Selected Image**
Saves the selected image.
- **Save All Corrected Images**
Saves all the corrected images displayed in the thumbnail list.
- **Exit**
Click to close the Correct/Enhance Images window.

Manual Tab

Use Adjust to adjust brightness and contrast, or to sharpen the entire image.

Use Correct/Enhance to correct/enhance specific areas.

See "[Correcting/Enhancing Images Manually](#)" for details.

Adjustment

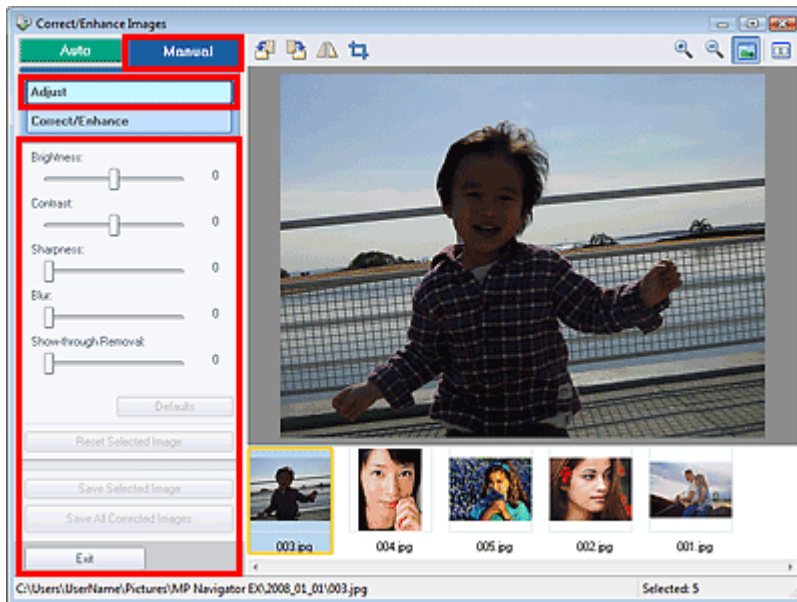



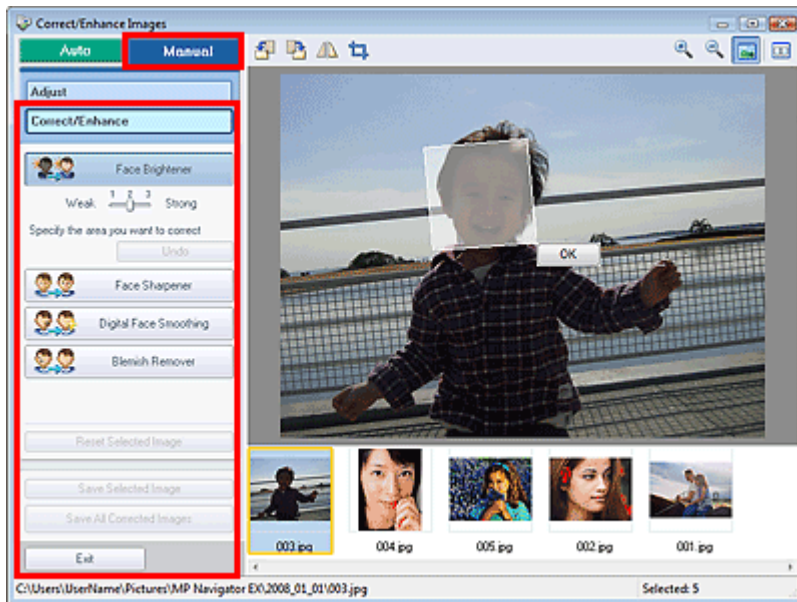

- **Brightness**
Adjusts the overall image brightness.
Move the slider to the left to darken and right to brighten the image.
- **Contrast**
Adjusts the contrast of the image. Adjust the contrast when the image is flat due to lack of contrast.
Move the slider to the left to decrease and right to increase the contrast of the image.
- **Sharpness**
Emphasizes the outline of the subjects to sharpen the image. Adjust the sharpness when the photo is out of focus or text is blurred.
Move the slider to the right to sharpen the image.
- **Blur**
Blurs the outline of the subjects to soften the image.
Move the slider to the right to soften the image.
- **Show-through Removal**
Removes show-through of text from the reverse side or removes the base color. Adjust the show-through level to prevent text on the reverse side of thin document or the base color of the document from appearing on the image.
Move the slider to the right to increase the show-through removal effect.
- **Defaults**
Resets all adjustments (brightness, contrast, sharpness, blur, and show-through removal).
- **Reset Selected Image**
Cancels all corrections, enhancements and adjustments applied to the selected image.
- **Save Selected Image**
Saves the selected image.
- **Save All Corrected Images**
Saves all the corrected images displayed in the thumbnail list.
- **Exit**
Click to close the Correct/Enhance Images window.

Correction/Enhancement



- **Face Brightener**
Corrects the entire image so that the selected facial area is brightened. You can adjust the effect level using the slider.
- **Undo**
Cancels the latest correction.
- **Face Sharpener**
Corrects the entire image to sharpen the face. You can specify the area you want to apply the effect to. You can adjust the effect level using the slider.
- **Digital Face Smoothing**
Enhances skin beautifully by removing blemishes and wrinkles. You can specify the area you want to apply the effect to. You can adjust the effect level using the slider.
- **Blemish Remover**
Removes moles. You can specify the area you want to apply the effect to.
- **Reset Selected Image**
Cancels all corrections, enhancements and adjustments applied to the selected image.
- **Save Selected Image**
Saves the selected image.
- **Save All Corrected Images**
Saves all the corrected images displayed in the thumbnail list.
- **Exit**
Click to close the Correct/Enhance Images window.
- **OK**
Applies the selected effect to the specified area.

Toolbar



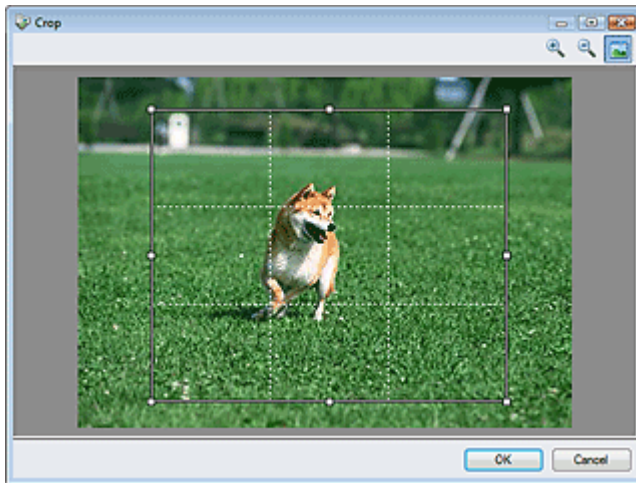

- **Toolbar**
 -  **(Rotate Left)**
Rotates the image 90 degrees counter-clockwise.
 -  **(Rotate Right)**
Rotates the image 90 degrees clockwise.
 -  **(Invert)**
Inverts the image horizontally.
 -  **(Trimming)**
Trimming is the act of selecting the area you want to keep in a photo and discarding the rest. In

the displayed window, drag the white frame to specify the trimming area. Move the mouse pointer inside the white frame and drag to move the trimming area.



Note

- Place the main subjects along the broken white lines or at the intersections to create a balanced image.

-  **(Enlarge)**
Enlarges the displayed image.
-  **(Reduce)**
Reduces the displayed image.
-  **(Full-screen)**
Enlarges/reduces the image to display it full-screen.
-  **(Compare)**
Opens the source image for comparison.
The source image appears on the left and the corrected image appears on the right.

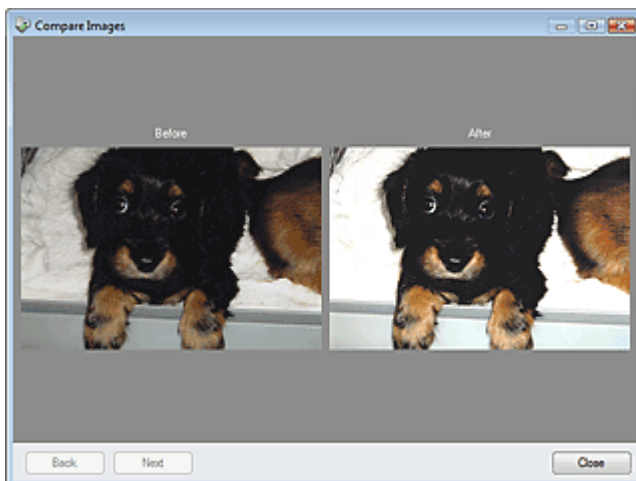

[Top of Page](#)

Advanced Guide

Advanced Guide > Scanning > Scanning with the Bundled Application Software > MP Navigator EX Screens > One-click Mode Screen

One-click Mode Screen

Click  (Switch Mode) at the bottom left of the Navigation Mode screen to display the One-click Mode screen.

You can complete from scanning to saving at one time by simply clicking the corresponding icon.

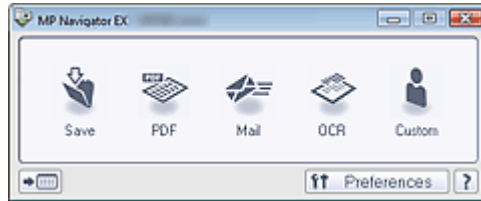

- **Save**

Scan and save documents. Document type is automatically detected. File format is automatically set. Files are saved to a computer.

When you click this icon, the Save dialog box opens and you can specify the scan/save settings.

➔ [Save Dialog Box \(One-Click Mode Screen\)](#)

- **PDF**

Scan documents and save them as PDF files.

When you click this icon, the PDF dialog box opens and you can specify the scan/save and application settings.

➔ [PDF Dialog Box](#)

- **Mail**

Scan documents or photos and attach them to e-mail.

When you click this icon, the Mail dialog box opens and you can specify the scan/save and e-mail software program settings.

➔ [Mail Dialog Box](#)

- **OCR**

Scan text documents then extract and display text in the image on NotePad.

When you click this icon, the OCR dialog box opens and you can specify the scan/save and application settings.

➔ [OCR Dialog Box](#)



Important

- For further procedures, refer to the application's manual.

- **Custom**

Scan documents and open them in a specified application. Document type is automatically detected.

When you click this icon, the Custom dialog box opens and you can specify the scan/save and application settings.

➔ [Custom Dialog Box](#)



Important

- For further procedures, refer to the application's manual.

-  **(Switch Mode)**

Switch to Navigation Mode and the Navigation Mode screen opens.

➔ [Custom Scan with One-click Tab](#)

-  **Preferences**

The Preferences dialog box opens. In the Preferences dialog box, you can make advanced settings to MP Navigator EX functions.

➔ [Preferences Dialog Box](#)

-  **(Guide)**

Click to open this guide.

 **Important**

- The following restrictions apply when you scan with Document Type set to Auto Mode in the Save or Custom dialog box.
Specify Document Type (other than Auto Mode) to extract the text in the image and convert to editable text after scanning.

Related Topic

- ▶ [Easy Scanning with One-click](#)

[Top of Page](#)↑

Advanced Guide

Advanced Guide > Scanning > Scanning with the Bundled Application Software > MP Navigator EX Screens > Save Dialog Box (One-click Mode Screen)

Save Dialog Box (One-click Mode Screen)

Click Save to PC on the Custom Scan with One-click tab or click Save in the One-click Mode screen to open the Save dialog box.

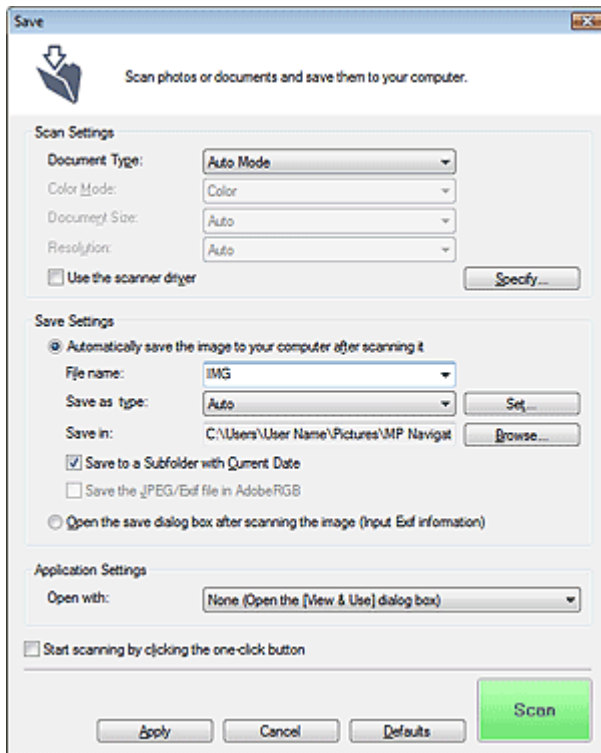

Scan Settings

- **Document Type**

Select the type of document to be scanned. When Auto Mode is selected, the document type is automatically detected. In that case, Color Mode, Document Size and Resolution are automatically set as well.

Important

- To scan correctly, select a document type that matches the document to be scanned.
- The following types of documents cannot be scanned correctly with Auto Mode. In that case, specify Document Type.
 - Documents other than photos, Hagaki, business cards, magazines, newspapers, text documents and CD/DVD.
 - A4 photos.
 - Text documents smaller than 2L (5 inches x 7 inches) (127 mm x 178 mm), such as paperback pages with the spine cut off.
 - Documents printed on thin white paper.
 - Wide documents such as panoramic photos.
- Place documents correctly according to the type of document to be scanned. Otherwise, documents may not be scanned correctly. See "[Placing Documents](#)" for details on how to place documents.
- To reduce moire, set Document Type to Magazine.

- **Color Mode**

Select how to scan the document.

- **Document Size**

Select the size of the document to be scanned.

When you select Custom, a dialog box in which you can specify the document size opens. Select a Units, then enter the Width and Height and click OK.

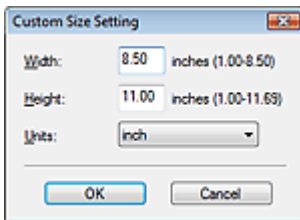

Important

- When you select Auto Detect, the image may not be scanned at the correct position and size. In that case, change the size to the actual document size (A4, Letter, etc.) and align a corner of the document with the corner at the arrow of the Platen.
See "[Placing Documents](#)" for details on how to place documents.

● Resolution

Select the resolution at which to scan documents.

➔ [Resolution](#)

● Use the scanner driver

Select this checkbox to display the ScanGear (scanner driver) screen and make advanced scan settings.

Color Mode, Document Size, Resolution and other settings in the Save dialog box will be disabled. Specify these settings in the ScanGear (scanner driver) screen.

● Specify...

For Document Type, Color Mode, Document Size and Scanning Resolution, the settings specified in the Save dialog box are displayed.

For Descreen, Unsharp Mask, etc., see the corresponding descriptions in "[Scan Settings Dialog Box](#)."

Save Settings

● Automatically save the image to your computer after scanning it

Select this to save the images to your computer as specified after scanning them.

The File name, Save as type and Save in settings will be displayed.

Important

- If you select this function, you will not be able to set passwords for PDF files.

● File name

Enter the file name of the image to be saved (up to 32 characters). When saving multiple files, 4 digits are appended to each file name.

● Save as type

Select a file type to save the scanned images.

Select Auto, JPEG/Exif, TIFF or BMP. Auto is displayed and selected by default when Document Type is Auto Mode. When saving as PDF files, select PDF, PDF(Multiple Pages) or PDF(Add Page).

Important

- When Auto is selected, files are saved in the following formats according to the document type.
Photos, Hagaki, business cards and CD/DVD: JPEG
Magazines, newspapers and text documents: PDF
You can change the file format from Set....
Images saved as PDF files may not open depending on the application. In that case, select an option other than PDF in Save as type.
- When Document Type is Auto Mode and Save as type is Auto, the file format may differ depending on how you place the document.
See "[Placing Documents](#)" for details on how to place documents.
- Large documents (such as A4 photos) that cannot be placed away from the edges/arrow of the Platen may not be saved in the correct file format when Save as type is Auto. In that case, select a file format suitable for the document to be scanned.

● Set...

When Save as type is Auto

You can specify the file format in which to save images. Select a file format for Document and Photo each.

When Save as type is JPEG/Exif

You can specify a compression type for JPEG files. Select High(Low Compression), Standard or Low(High Compression).

When Save as type is PDF, PDF(Multiple Pages) or PDF(Add Page)

Make advanced settings for creating PDF files. See " [PDF Settings Dialog Box](#) " for details.

- **Save in**

Displays the folder in which to save the scanned images. To change the folder, click Browse... to specify another one.

The following folders are specified by default.

Windows Vista: MP Navigator EX folder in Picture folder

Windows XP: MP Navigator EX folder in My Pictures folder

Windows 2000: MP Navigator EX folder in My Pictures folder

- **Save to a Subfolder with Current Date**

Select this checkbox to create a subfolder in the folder specified in Save in with the current date and save imported files in it. A subfolder with a name such as "2008_01_01" (Year_Month_Date) will be created.

If this checkbox is not selected, files are saved directly in the folder specified in Save in.

- **Save the JPEG/Exif file in AdobeRGB**

Select this checkbox to save the images in colors that correspond to Adobe RGB.



Important

- This function is available only when Save as type is JPEG/Exif.
- This function is not available if the Adobe RGB profile is not installed.



Note

- You cannot select this setting if the Use the scanner driver checkbox is selected.
- If you save an image with the Save the JPEG/Exif file in AdobeRGB checkbox selected, an underscore is added to the beginning of the file name. (Example: _Image0001.jpg)

- **Open the save dialog box after scanning the image (Input Exif information)**

Select this to open the Save dialog box after scanning the images and specify the save settings such as destination folder, file name and Exif information.

➔ [Save Dialog Box](#)



Note

- To set passwords for PDF files, select Open the save dialog box after scanning the image. After scanning, you can set the passwords in the Save dialog box.

➔ [Setting Passwords for PDF Files](#)

Application Settings

- **Open with**

You can select whether to open the View & Use window or Explorer after saving the images.

- **Start scanning by clicking the one-click button**

Select this checkbox to start scanning when you click an icon.

- **Apply**

Saves and applies the specified settings.

Click Cancel instead of Apply to cancel the specified settings.

- **Cancel**

Cancels the specified settings. The current dialog box closes.

- **Defaults**

Returns all settings in the dialog box to their defaults.

- **Scan**

Click to scan and save documents with the specified settings.

When Save as type is Auto, a confirmation appears. Click Open Manual to open this guide (if it is installed).

[Top of Page](#)↑

Advanced Guide

Advanced Guide > Scanning > Scanning with the Bundled Application Software > MP Navigator EX Screens > Scan Settings Dialog Box

Scan Settings Dialog Box

The Scan Settings dialog box opens when you click Specify... in the dialog box that opens when scanning from the One-click Mode screen or the Custom Scan with One-click tab.

In the Scan Settings dialog box, you can make advanced scan settings.

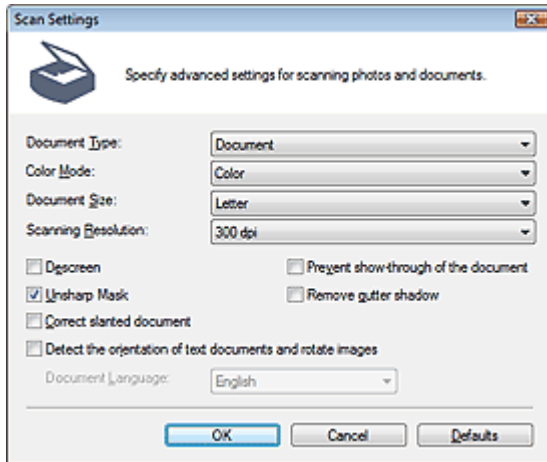

Important

- The displayed items vary by document type and how the screen was opened.

Note

- The Scan Settings dialog box can also be opened by clicking Specify... on the Scanner Button Settings tab of the Preferences dialog box.

• Document Type

Select the type of document to be scanned. When Auto Mode is selected, the document type is automatically detected.

In that case, Color Mode, Document Size, etc. are automatically set as well.

Important

- To scan correctly, select a document type that matches the document to be scanned.
- When opened from the Scanner Button Settings tab, the Document Type specified in the Scanner Button Settings tab is displayed and cannot be changed in this dialog box.

• Color Mode

Select how to scan the document.

• Color

This mode renders the image in 256 levels (8 bit) of R(ed), G(reen), and B(lue).

• Grayscale

This mode renders the image in 256 levels (8 bit) of black and white.

• Black and White

This mode renders the image in black and white. The contrast in the image is divided at certain levels (threshold level) into black and white and is rendered in two colors.

Note

- Color Mode is not displayed in the Scan Settings dialog box opened from the Scanner Button Settings tab.

• Document Size

Select the size of the document to be scanned.

When you select Custom, a dialog box in which you can specify the document size opens. Select a Units, then enter the Width and Height and click OK.

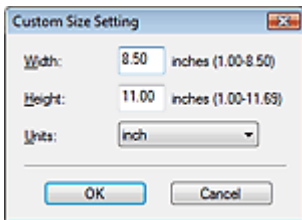

Important

- When you select Auto Detect, the image may not be scanned at the correct position and size. In that case, change the size to the actual document size (A4, Letter, etc.) and align a corner of the document with the corner at the arrow of the Platen.
See "[Placing Documents](#)" for details on how to place documents.

● Scanning Resolution

Select the resolution at which to scan documents.

➔ [Resolution](#)

● Descreen

Select this checkbox to reduce moire patterns.

Printed photos and pictures are displayed as a collection of fine dots. Moire is a phenomenon where dots may interfere with each other and cause uneven gradation and a stripe pattern in the image. Descreen is the function for reducing this moire effect.

Note

- Scanning takes longer than usual when you enable Descreen.

● Unsharp Mask

Select this checkbox to emphasize the outline of the subjects and sharpen the image.

● Prevent show-through of the document

Select this checkbox to sharpen text in a document or reduce show-through in newspapers.

Important

- Select this checkbox when Document Type is text document and show-through is apparent in the scanned image.

● Remove gutter shadow

Select this checkbox to correct shadows that appear between pages when scanning open booklets.

Important

- Align the document correctly with the marks on the Platen.
- Gutter shadows can be corrected only when Document Size is set to a standard size.
- You cannot select this checkbox when Document Size is Auto Detect, Auto Detect (Multiple Documents) or Stitch Assist.

Note

- Use ScanGear's Advanced Mode tab to correct gutter shadows when scanning non-standard size documents or when custom cropping frames are set.
For details, see Gutter Shadow Correction in "[Image Settings](#)" (ScanGear's Advanced Mode tab).

● Correct slanted document

Select this checkbox to detect the scanned text and correct the angle (within -0.1 to -10 degrees or +0.1 to +10 degrees) of the document.

Important

- You cannot select this checkbox when Document Size is Stitch Assist.
- The inclination of the following types of documents may not be corrected, as the text cannot be detected correctly.
 - Documents in which the text lines are inclined more than 10 degrees or the angles vary by line.
 - Documents containing both vertical and horizontal text.
 - Documents with extremely large or small fonts.
 - Documents with small amount of text.
 - Documents containing figures/images or hand-written text.
 - Documents containing both vertical and horizontal lines (tables).

 **Note**

- Scanning takes longer than usual when you enable Correct slanted document.

• Detect the orientation of text documents and rotate images

Select this checkbox to detect the orientation of the document from the scanned text and rotate the scanned image to the correct orientation. Select the language of the document to be scanned in Document Language.

 **Important**

- You cannot select this checkbox when Document Size is Stitch Assist.
- This function may not work properly depending on the document language. Only text documents written in languages that can be selected from Document Language are supported.
- The orientation of the following types of documents may not be corrected, as the text cannot be detected correctly.
 - Resolution is outside the range of 300 dpi to 600 dpi.
 - Font size is outside the range of 8 points to 48 points.
 - Documents containing special fonts, effects, italics, or hand-written text.
 - Documents with patterned backgrounds.

 **Note**

- Scanning takes longer than usual when you enable Detect the orientation of text documents and rotate images.

• Document Language

Select the language of the document to be scanned.

 **Important**

- You cannot select this checkbox when Document Size is Stitch Assist.

• Defaults

Click to restore the default settings.

[Top of Page](#)↑

Advanced Guide

Advanced Guide > Scanning > Scanning with the Bundled Application Software > MP Navigator EX Screens > Save Dialog Box

Save Dialog Box

The Save dialog box for specifying the image's file name and destination opens after you scan with Open the save dialog box after scanning the image (Input Exif information) selected in the Save dialog box that opens when you click Save to PC on the Custom Scan with One-click tab or Save in the One-click Mode screen. You can specify the file type and destination while viewing the thumbnails.

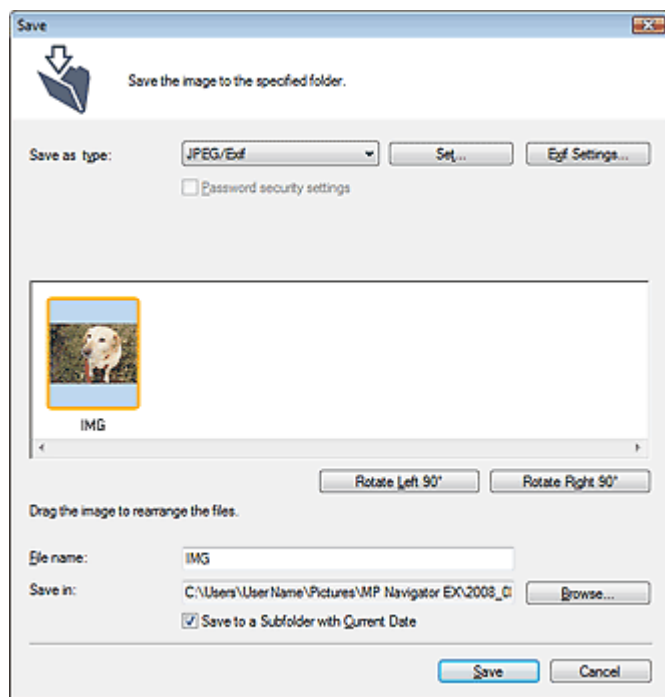

- **Save as type**

Select a file type to save the scanned images.

Select JPEG/Exif, TIFF, BMP, PDF, PDF(Multiple Pages) or PDF(Add Page).

- **PDF**

Save each of the selected images as a separate PDF file.

- **PDF(Multiple Pages)**

Save multiple images in one PDF file.

 **Important**

- PDF(Multiple Pages) is displayed when multiple images are scanned.

- **PDF(Add Page)**

Add the scanned images to a PDF file. The images are added to the end of the PDF file. You cannot rearrange the pages of the PDF file to which the images are added.

 **Important**

- Images can only be added to PDF files created with MP Navigator EX. You cannot specify PDF files created with other applications. PDF files edited in other applications cannot be specified as well.
- If a password-protected PDF file is edited, the passwords will be deleted. Reset the passwords.
 - ➔ [Setting Passwords for PDF Files](#)

 **Important**

- PDF(Multiple Pages) and PDF(Add Page) cannot be selected for images scanned using the Operation Panel of the machine.

- **Set...**

When Save as type is JPEG/Exif

You can specify a compression type for JPEG files. Select High(Low Compression), Standard or Low(High Compression).

When Save as type is PDF, PDF(Multiple Pages) or PDF(Add Page)

Make advanced settings for creating PDF files. See " [PDF Settings Dialog Box](#) " for details.

- **Add to**

This is displayed when you select PDF(Add Page) for Save as type and specify the PDF file to which images are added. To change the file, click Browse... to specify another one.

Important

- Images can only be added to PDF files created with MP Navigator EX. You cannot specify PDF files created with other applications. PDF files edited in other applications cannot be specified as well.

- **Exif Settings...**

When Save as type is JPEG/Exif, you can input Exif information into the file to be saved.

➔ [Exif Settings Dialog Box](#)

- **Password security settings**

Select this checkbox to open the Password Security -Settings dialog box in which you can set passwords for opening, editing and printing created PDF files.

➔ [Setting Passwords for PDF Files](#)

Note

- This function is available only when Save as type is PDF, PDF(Multiple Pages) or PDF(Add Page).

- **Rotate Left 90°/Rotate Right 90°**

Rotates scanned images 90 degrees counter-clockwise or clockwise.

Select the image you want to rotate and click Rotate Left 90° or Rotate Right 90°.

- **File name**

Enter the file name of the image to be saved (up to 32 characters). When saving multiple files, 4 digits are appended to each file name.

- **Save in**

Displays the folder in which to save the scanned images. To change the folder, click Browse... to specify another one.

The following folders are specified by default.

Windows Vista: MP Navigator EX folder in Picture folder

Windows XP: MP Navigator EX folder in My Pictures folder

Windows 2000: MP Navigator EX folder in My Pictures folder

- **Save to a Subfolder with Current Date**

Select this checkbox to create a subfolder in the folder specified in Save in with the current date and save imported files in it. A subfolder with a name such as "2008_01_01" (Year_Month_Date) will be created.

If this checkbox is not selected, files are saved directly in the folder specified in Save in.

[Top of Page](#)↑

Advanced Guide

Advanced Guide > Scanning > Scanning with the Bundled Application Software > MP Navigator EX Screens > Exif Settings Dialog Box

Exif Settings Dialog Box

You can input Exif information into a file to be saved. Exif is a standard format for embedding various shooting data in digital camera images (JPEG). Embedding Exif information into scanned images allows you to organize and print them along with digital camera images.

The Exif Settings dialog box can be opened when Save as type is JPEG/Exif.

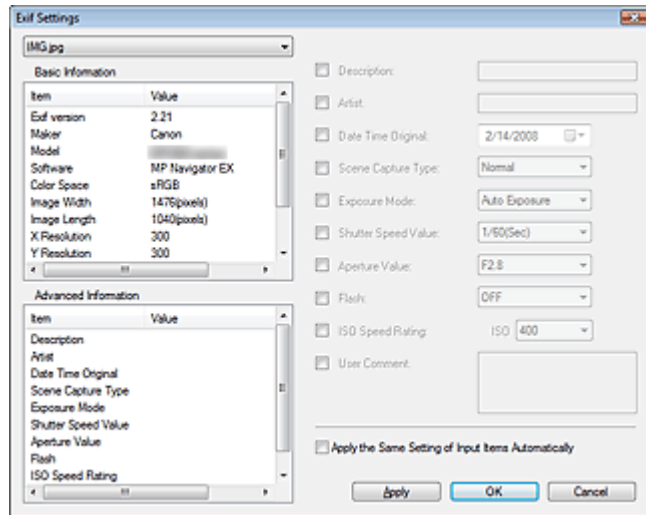

- **Basic Information**

Displays the information obtained automatically from the machine or software.

- **Advanced Information**

Displays the information specified on the right side of the window.

- **Advanced Information Settings Area**

You can input Exif information such as the title and shooting data. Select the checkbox of the items you want to specify, and select or enter information.

- **Apply the Same Setting of Input Items Automatically**

Select this checkbox to automatically display the information you specified for the previous image.

- **Apply**

After specifying all the information you need, click Apply to embed it into the image. The information appears in Advanced Information.

- **OK**

Embeds the specified information into the image and closes the window. The specified information is saved.

- **Cancel**

Cancels the settings and closes the window. Information is embedded when Cancel is clicked after clicking Apply.

[Top of Page](#) ↑

Advanced Guide

Advanced Guide > Scanning > Scanning with the Bundled Application Software > MP Navigator EX Screens > PDF Dialog Box

PDF Dialog Box

Click Save as PDF file on the Custom Scan with One-click tab or click PDF in the One-click Mode screen to open the PDF dialog box.

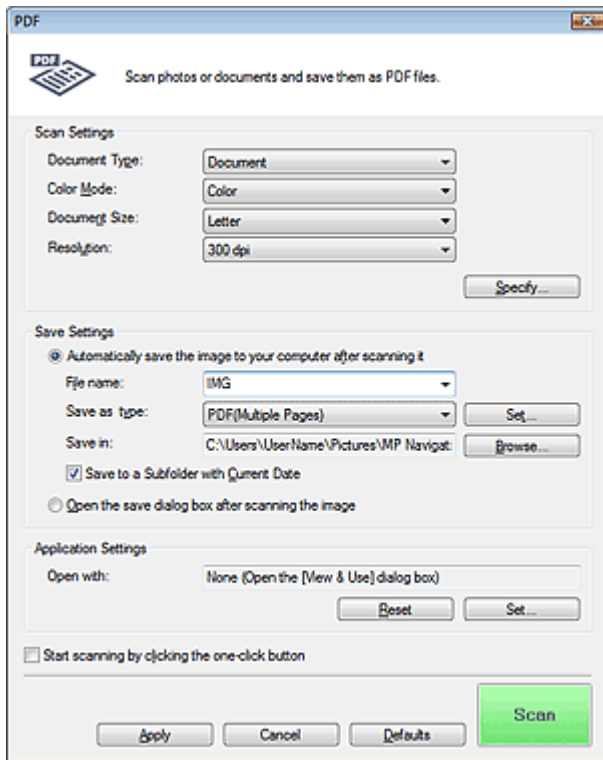

Scan Settings

- **Document Type**

Select the type of document to be scanned.

Important

- To scan correctly, select a document type that matches the document to be scanned.

- **Color Mode**

Select how to scan the document.

- **Document Size**

Select the size of the document to be scanned.

When you select Custom, a dialog box in which you can specify the document size opens. Select a Units, then enter the Width and Height and click OK.

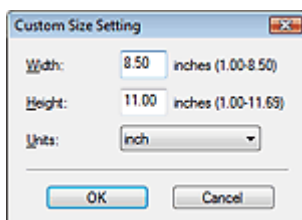

- **Resolution**

Select the resolution at which to scan documents.

➔ Resolution

- **Specify...**

For Document Type, Color Mode, Document Size and Scanning Resolution, the settings specified in the PDF dialog box are displayed.

For Descreen, Unsharp Mask, etc., see the corresponding descriptions in " [Scan Settings Dialog Box](#)."

Save Settings

- **Automatically save the image to your computer after scanning it**

Select this to save the images to your computer as specified after scanning them.



Important

- If you select this function, you will not be able to set passwords for PDF files.

- **File name**

Enter the file name of the image to be saved (up to 32 characters). When saving multiple files, 4 digits are appended to each file name.

- **Save as type**

Select a file type to save the scanned images.

Select PDF, PDF(Multiple Pages) or PDF(Add Page).

- **PDF**

Save each of the selected images as a separate PDF file.

- **PDF(Multiple Pages)**

Save multiple images in one PDF file.

- **PDF(Add Page)**

Add the scanned images to a PDF file. The images are added to the end of the PDF file. You cannot rearrange the pages of the PDF file to which the images are added.



Important

- Images cannot be added to password-protected PDF files.



Important

- Click Set... to open the PDF Settings dialog box in which you can specify the PDF compression type and other advanced settings for creating PDF files.

➔ [PDF Settings Dialog Box](#)



Note

- See "[Creating/Editing PDF Files](#)" to delete or rearrange the pages of saved PDF files.

- **Save in**

Displays the folder in which to save the scanned images. To change the folder, click Browse... to specify another one.

The following folders are specified by default.

Windows Vista: MP Navigator EX folder in Picture folder

Windows XP: MP Navigator EX folder in My Pictures folder

Windows 2000: MP Navigator EX folder in My Pictures folder

- **Save to a Subfolder with Current Date**

Select this checkbox to create a subfolder in the folder specified in Save in with the current date and save imported files in it. A subfolder with a name such as "2008_01_01" (Year_Month_Date) will be created.

If this checkbox is not selected, files are saved directly in the folder specified in Save in.

- **Open the save dialog box after scanning the image**

Select this to open the Save as PDF file dialog box after scanning the images and specify the save settings such as destination folder and file name.

➔ [Save as PDF file Dialog Box](#)



Note

- To set passwords for PDF files, select Open the save dialog box after scanning the image. After scanning, you can set the passwords in the Save as PDF file dialog box.

➔ [Setting Passwords for PDF Files](#)

Application Settings

- **Open with**

Specify an application with which to open scanned images. Drag and drop the icon of an application that supports the file format displayed in Save as type. The specified application starts after images are scanned.

**Important**

- Depending on the specified application, the images may not appear correctly or the application may not start.

- **Reset**

Click to cancel the application setting.

- **Set...**

Allows you to select an application to start.

- **Start scanning by clicking the one-click button**

Select this checkbox to start scanning when you click an icon.

- **Apply**

Saves and applies the specified settings.

Click Cancel instead of Apply to cancel the specified settings.

- **Cancel**

Cancels the specified settings. The current dialog box closes.

- **Defaults**

Returns all settings in the dialog box to their defaults.

- **Scan**

Click to scan and save documents as PDF files with the specified settings.

[Top of Page](#)↑

Advanced Guide

Advanced Guide > Scanning > Scanning with the Bundled Application Software > MP Navigator EX Screens > Save as PDF file Dialog Box

Save as PDF file Dialog Box

The Save as PDF file dialog box opens when you scan from Save as PDF file on the Custom Scan with One-click tab or from PDF in the One-click Mode screen after selecting Open the save dialog box after scanning the image.

In the Save as PDF file dialog box, you can make settings for saving images to a computer.

Important

- You cannot save images scanned at 10501 pixels or more in the vertical and horizontal directions.

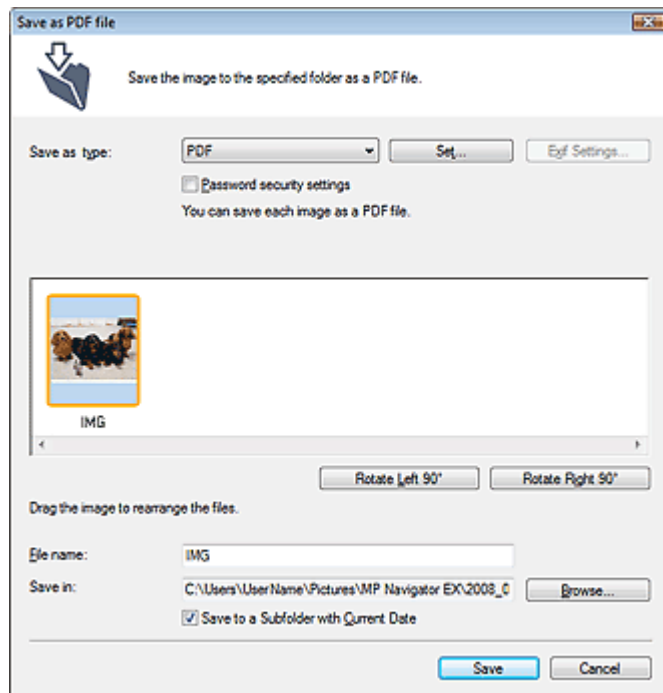

• Save as type

Select a PDF file type to save the scanned images.

- **PDF**
Save each of the selected images as a separate PDF file.
- **PDF(Multiple Pages)**
Save multiple images in one PDF file.

Important

- PDF(Multiple Pages) is displayed when multiple images are scanned.

• PDF(Add Page)

Add the scanned images to a PDF file. The images are added to the end of the PDF file. You cannot rearrange the pages of the PDF file to which the images are added.

Important

- Images can only be added to PDF files created with MP Navigator EX. You cannot specify PDF files created with other applications. PDF files edited in other applications cannot be specified as well.
- If a password-protected PDF file is edited, the passwords will be deleted. Reset the passwords.

Important

- You can set passwords for PDF files.
➔ [Setting Passwords for PDF Files](#)

- **Set...**

Make advanced settings for creating PDF files.
See "[PDF Settings Dialog Box](#)" for details.

- **Password security settings**

Select this checkbox to open the Password Security -Settings dialog box in which you can set passwords for opening, editing and printing created PDF files.

➡ [Setting Passwords for PDF Files](#)

- **Rotate Left 90°/Rotate Right 90°**

Rotates scanned images 90 degrees counter-clockwise or clockwise.
Select the image you want to rotate and click Rotate Left 90° or Rotate Right 90°.

- **File name**

Enter the file name of the image to be saved (up to 32 characters). When saving multiple files, 4 digits are appended to each file name.

- **Save in**

Displays the folder in which to save the PDF files. To change the folder, click Browse... to specify another one.

The following folders are specified by default.

Windows Vista: MP Navigator EX folder in Picture folder

Windows XP: MP Navigator EX folder in My Pictures folder

Windows 2000: MP Navigator EX folder in My Pictures folder

- **Save to a Subfolder with Current Date**

Select this checkbox to create a subfolder in the folder specified in Save in with the current date and save imported files in it. A subfolder with a name such as "2008_01_01" (Year_Month_Date) will be created.

If this checkbox is not selected, files are saved directly in the folder specified in Save in.

[Top of Page](#)↑

Advanced Guide

Advanced Guide > Scanning > Scanning with the Bundled Application Software > MP Navigator EX Screens > Mail Dialog Box

Mail Dialog Box

Click Attach to E-mail on the Custom Scan with One-click tab or click Mail in the One-click Mode screen to open the Mail dialog box.

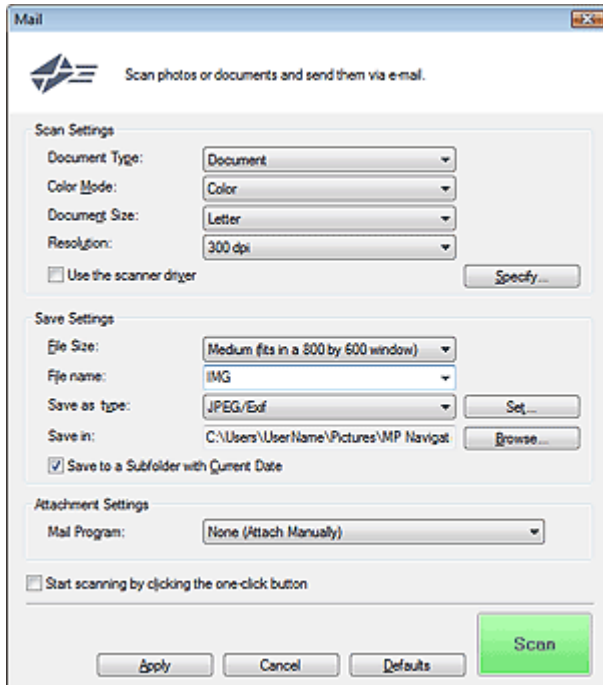

Scan Settings

- **Document Type**

Select the type of document to be scanned.

Important

- To scan correctly, select a document type that matches the document to be scanned.

- **Color Mode**

Select how to scan the document.

- **Document Size**

Select the size of the document to be scanned.

When you select Custom, a dialog box in which you can specify the document size opens. Select a Units, then enter the Width and Height and click OK.

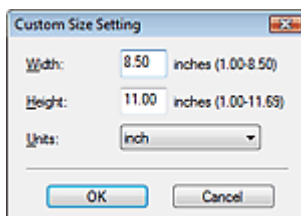

- **Resolution**

Select the resolution at which to scan documents.

➔ Resolution

- **Use the scanner driver**

Select this checkbox to display the ScanGear (scanner driver) screen and make advanced scan settings.

- **Specify...**

For Document Type, Color Mode, Document Size and Scanning Resolution, the settings specified in the Mail dialog box are displayed.

For Descreen, Unsharp Mask, etc., see the corresponding descriptions in " [Scan Settings Dialog Box](#)."

Save Settings

- **File Size**

Select a size from Small (fits in a 640 by 480 window), Medium (fits in a 800 by 600 window), Large (fits in a 1024 by 768 window) and Original.

- **File name**

Enter the file name of the image to be saved (up to 32 characters). When saving multiple files, 4 digits are appended to each file name.

- **Save as type**

Select a file type to save the scanned images.
Select JPEG/Exif, PDF or PDF(Multiple Pages).



Important

- For JPEG/Exif images, click Set... to open a dialog box in which you can select a compression type from High(Low Compression), Standard and Low(High Compression).
- You cannot set passwords for PDF files.

- **Save in**

Displays the folder in which to save the scanned images. To change the folder, click Browse... to specify another one.

The following folders are specified by default.

Windows Vista: MP Navigator EX folder in Picture folder

Windows XP: MP Navigator EX folder in My Pictures folder

Windows 2000: MP Navigator EX folder in My Pictures folder

- **Save to a Subfolder with Current Date**

Select this checkbox to create a subfolder in the folder specified in Save in with the current date and save imported files in it. A subfolder with a name such as "2008_01_01" (Year_Month_Date) will be created.

If this checkbox is not selected, files are saved directly in the folder specified in Save in.

Attachment Settings

- **Mail Program**

Specify an e-mail software program.



Note

- Select Add... to open the Select Mail Program dialog box in which you can select an e-mail software program. If the e-mail software program you want to use is not listed, click Add to List and select it.

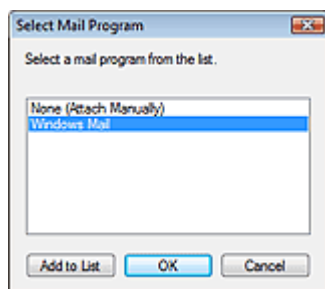

- **Start scanning by clicking the one-click button**

Select this checkbox to start scanning when you click an icon.

- **Apply**

Saves and applies the specified settings.

Click Cancel instead of Apply to cancel the specified settings.

- **Cancel**

Cancels the specified settings. The current dialog box closes.

- **Defaults**

Returns all settings in the dialog box to their defaults.

- **Scan**

Click to scan documents with the specified settings.

When scanning is completed, the e-mail software program starts automatically and a new message window opens with the image attached.

[Top of Page](#)↑

Advanced Guide

Advanced Guide > Scanning > Scanning with the Bundled Application Software > MP Navigator EX Screens > OCR Dialog Box

OCR Dialog Box

Click OCR on the Custom Scan with One-click tab or in the One-click Mode screen to open the OCR dialog box.

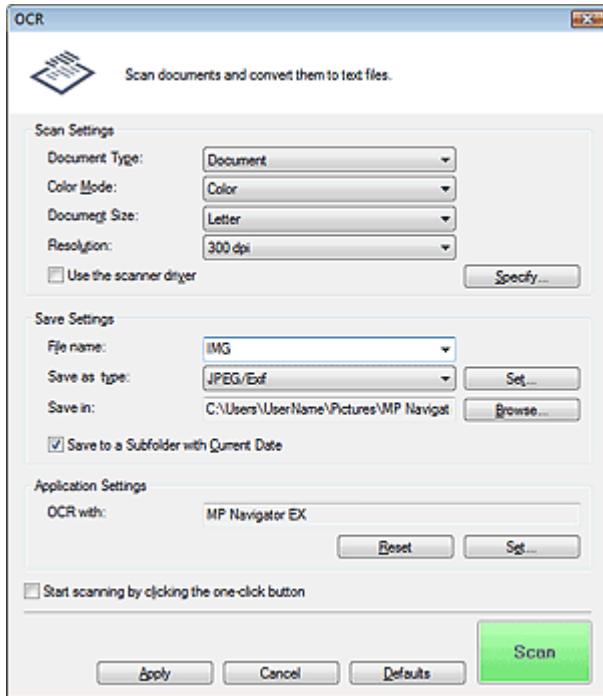

Scan Settings

- **Document Type**

Select the type of document to be scanned.

Important

- To scan correctly, select a document type that matches the document to be scanned.

- **Color Mode**

Select how to scan the document.

- **Document Size**

Select the size of the document to be scanned.

When you select Custom, a dialog box in which you can specify the document size opens. Select a Units, then enter the Width and Height and click OK.

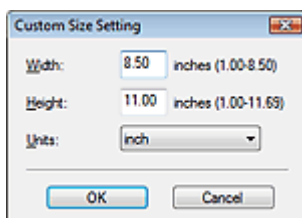

- **Resolution**

Select the resolution at which to scan documents.

➔ Resolution

- **Use the scanner driver**

Select this checkbox to display the ScanGear (scanner driver) screen and make advanced scan settings.

- **Specify...**

For Document Type, Color Mode, Document Size and Scanning Resolution, the settings specified in the OCR dialog box are displayed.

For Descreen, Unsharp Mask, etc., see the corresponding descriptions in "[Scan Settings Dialog Box](#)."

Save Settings

- **File name**

Enter the file name of the image to be saved (up to 32 characters). When saving multiple files, 4 digits are appended to each file name.

- **Save as type**

Select a file type to save the scanned images.
Select JPEG/Exif, TIFF or BMP.



Important

- For JPEG/Exif images, click Set... to open a dialog box in which you can select a compression type from High(Low Compression), Standard and Low(High Compression).

- **Save in**

Displays the folder in which to save the scanned images. To change the folder, click Browse... to specify another one.

The following folders are specified by default.

Windows Vista: MP Navigator EX folder in Picture folder

Windows XP: MP Navigator EX folder in My Pictures folder

Windows 2000: MP Navigator EX folder in My Pictures folder

- **Save to a Subfolder with Current Date**

Select this checkbox to create a subfolder in the folder specified in Save in with the current date and save imported files in it. A subfolder with a name such as "2008_01_01" (Year_Month_Date) will be created.

If this checkbox is not selected, files are saved directly in the folder specified in Save in.

Application Settings

- **OCR with**

Specify an application with which to open scanned images. By default, the text in the image is extracted and appears in NotePad.

Drag and drop the icon of an application that supports the file format displayed in Save as type. The specified application starts after images are scanned.



Important

- To extract text using MP Navigator EX, set Document Type according to the document.
- Depending on the specified application, the images may not appear correctly or the application may not start.



Note

- Text displayed in NotePad is for guidance only and may not be as accurate as text converted with commercial OCR software.

Text in the image of the following types of documents may not be detected correctly.

- Documents containing text with font size outside the range of 8 points to 40 points (at 300 dpi).

- Slanted documents.

- Documents placed in the wrong orientation.

- Documents containing special fonts, effects, italics, or hand-written text.

- Documents with narrow line spacing.

- Documents with colors in the background of text.

- When OCR with is MP Navigator EX, click Set... on the General tab and specify the language.

➔ [Preferences Dialog Box](#)

- **Reset**

Click to cancel the application setting.

- **Set...**

Allows you to select an application to start.

 **Important**

- You cannot specify a text editor other than NotePad.

- **Start scanning by clicking the one-click button**

Select this checkbox to start scanning when you click an icon.

- **Apply**

Saves and applies the specified settings.

Click Cancel instead of Apply to cancel the specified settings.

- **Cancel**

Cancels the specified settings. The current dialog box closes.

- **Defaults**

Returns all settings in the dialog box to their defaults.

- **Scan**

Click to scan documents with the specified settings.

When scanning is completed, the text in the image is extracted and appears in NotePad.

[Top of Page](#)↑

Advanced Guide

Advanced Guide > Scanning > Scanning with the Bundled Application Software > MP Navigator EX Screens > Custom Dialog Box

Custom Dialog Box

Click Custom on the Custom Scan with One-click tab or in the One-click Mode screen to open the Custom dialog box.

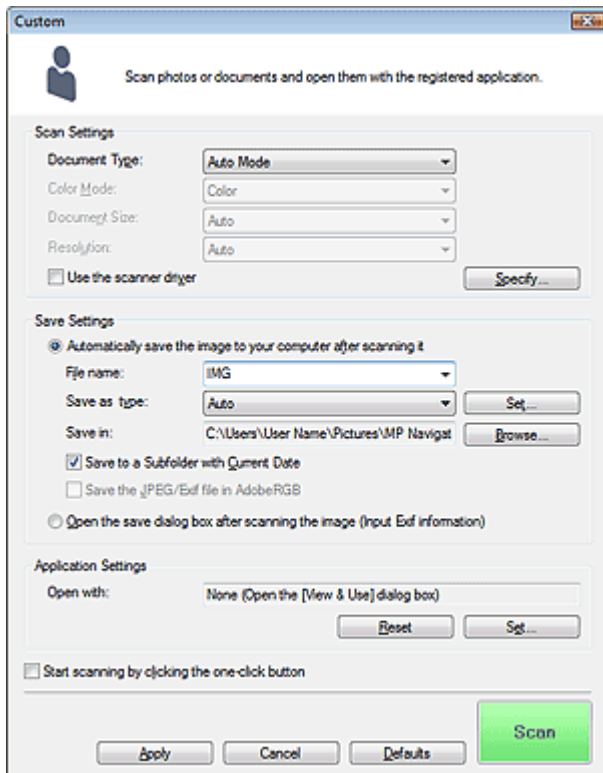

Scan Settings

- **Document Type**

Select the type of document to be scanned. When Auto Mode is selected, the document type is automatically detected. In that case, Color Mode, Document Size and Resolution are automatically set as well.

Important

- To scan correctly, select a document type that matches the document to be scanned.
- The following types of documents cannot be scanned correctly with Auto Mode. In that case, specify Document Type.
 - Documents other than photos, Hagaki, business cards, magazines, newspapers, text documents and CD/DVD.
 - A4 photos.
 - Text documents smaller than 2L (5 inches x 7 inches) (127 mm x 178 mm), such as paperback pages with the spine cut off.
 - Documents printed on thin white paper.
 - Wide documents such as panoramic photos.
- Place documents correctly according to the type of document to be scanned. Otherwise, documents may not be scanned correctly. See "[Placing Documents](#)" for details on how to place documents.
- To reduce moire, set Document Type to Magazine.

- **Color Mode**

Select how to scan the document.

- **Document Size**

Select the size of the document to be scanned.

When you select Custom, a dialog box in which you can specify the document size opens. Select a Units, then enter the Width and Height and click OK.

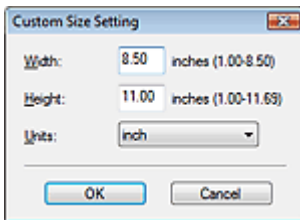

- **Resolution**

Select the resolution at which to scan documents.

➔ [Resolution](#)

- **Use the scanner driver**

Select this checkbox to display the ScanGear (scanner driver) screen and make advanced scan settings.

- **Specify...**

For Document Type, Color Mode, Document Size and Scanning Resolution, the settings specified in the Custom dialog box are displayed.

For Descreen, Unsharp Mask, etc., see the corresponding descriptions in " [Scan Settings Dialog Box](#)."

Save Settings

- **Automatically save the image to your computer after scanning it**

Select this to save the images to your computer as specified after scanning them.



Note

- If an application to start is specified in Application Settings, the scanned image opens in the specified application.

- **File name**

Enter the file name of the image to be saved (up to 32 characters). When saving multiple files, 4 digits are appended to each file name.

- **Save as type**

Select a file type to save the scanned images.

Select Auto, JPEG/Exif, TIFF or BMP. Auto is displayed and selected by default when Document Type is Auto Mode.



Important

- When Auto is selected, files are saved in the following formats according to the document type.
Photos, Hagaki, business cards and CD/DVD: JPEG
Magazines, newspapers and text documents: PDF
You can change the file format from Set....
Images saved as PDF files may not open depending on the application. In that case, select an option other than PDF in Save as type.
- When Document Type is Auto Mode and Save as type is Auto, the file format may differ depending on how you place the document.
See "[Placing Documents](#)" for details on how to place documents.
- Large documents (such as A4 photos) that cannot be placed away from the edges/arrow of the Platen may not be saved in the correct file format when Save as type is Auto. In that case, select a file format suitable for the document to be scanned.

- **Set...**

When Save as type is Auto

You can specify the file format in which to save images. Select a file format for Document and Photo each.

When Save as type is JPEG/Exif

You can specify a compression type for JPEG files. Select High(Low Compression), Standard or Low(High Compression).

- **Save in**

Displays the folder in which to save the scanned images. To change the folder, click Browse... to specify another one.

The following folders are specified by default.

Windows Vista: MP Navigator EX folder in Picture folder

Windows XP: MP Navigator EX folder in My Pictures folder

Windows 2000: MP Navigator EX folder in My Pictures folder

- **Save to a Subfolder with Current Date**

Select this checkbox to create a subfolder in the folder specified in Save in with the current date and save imported files in it. A subfolder with a name such as "2008_01_01" (Year_Month_Date) will be created.

If this checkbox is not selected, files are saved directly in the folder specified in Save in.

- **Save the JPEG/Exif file in AdobeRGB**

Select this checkbox to save the images in colors that correspond to Adobe RGB.



Important

- This function is available only when Save as type is JPEG/Exif.
- This function is not available if the Adobe RGB profile is not installed.



Note

- You cannot select this setting if the Use the scanner driver checkbox is selected.
- If you save an image with the Save the JPEG/Exif file in AdobeRGB checkbox selected, an underscore is added to the beginning of the file name. (Example: _Image0001.jpg)

- **Open the save dialog box after scanning the image (Input Exif information)**

Select this to open the Save dialog box after scanning the images and specify the destination folder, file name and Exif information.



Note

- See "[Save Dialog Box](#)" for details on the Save dialog box.

Application Settings

- **Open with**

Specify an application with which to open scanned images. Drag and drop the icon of an application that supports the file format displayed in Save as type. The specified application starts after images are scanned.



Important

- Depending on the specified application, the images may not appear correctly or the application may not start.

- **Reset**

Click to cancel the application setting.

- **Set...**

Allows you to select an application to start.

- **Start scanning by clicking the one-click button**

Select this checkbox to start scanning when you click an icon.

- **Apply**

Saves and applies the specified settings.

Click Cancel instead of Apply to cancel the specified settings.

- **Cancel**

Cancels the specified settings. The current dialog box closes.

- **Defaults**

Returns all settings in the dialog box to their defaults.

- **Scan**

Click to scan and save documents with the specified settings.

When Save as type is Auto, a confirmation appears. Click Open Manual to open this guide (if it is

installed).

[Top of Page](#)↑

Advanced Guide

Advanced Guide > Scanning > Scanning with the Bundled Application Software > MP Navigator EX Screens > Preferences Dialog Box

Preferences Dialog Box

Click Preferences in the Navigation Mode screen to open the Preferences dialog box.

In the Preferences dialog box, you can make advanced settings to MP Navigator EX functions via the General and Scanner Button Settings tabs.

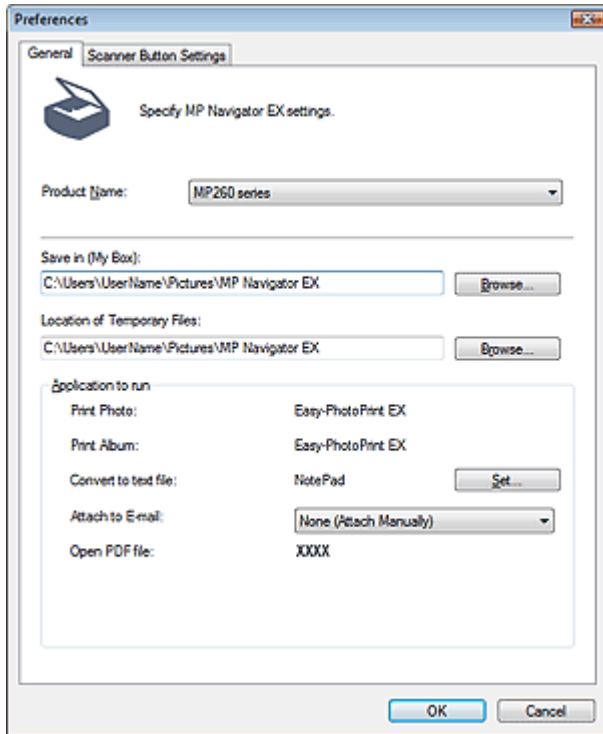

General Tab

On the General tab, you can specify general MP Navigator EX settings.

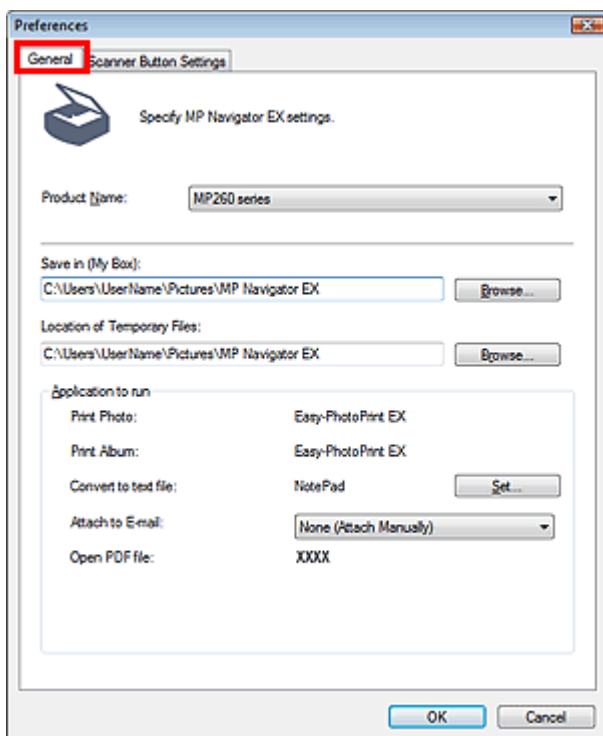

- **Product Name**

Displays the product name of the machine that MP Navigator EX is currently configured to use.

If the displayed product is not the one you want to use, select the desired product from the list.

- **Save in (My Box)**

Displays the folder in which to save scanned documents. To change the folder, click Browse... to specify another one.

The following folders are specified by default.

Windows Vista: MP Navigator EX folder in Picture folder

Windows XP: MP Navigator EX folder in My Pictures folder

Windows 2000: MP Navigator EX folder in My Pictures folder

- **Location of Temporary Files**

Displays the folder in which to save images temporarily. To change the folder, click Browse... to specify another one.

 **Important**

- An error may occur if you set the destination to the root directory of the drive on which the operating system is installed. Be sure to specify a folder.

- **Application to run**

Displays the applications that can be started via MP Navigator EX. Install the applications from the Setup CD-ROM that accompanies the machine.

For Attach to E-mail, you can select an e-mail software program to start.

For Convert to text file, the NotePad is displayed. In that case, click Set... to open the Language Setting dialog box and specify the language.

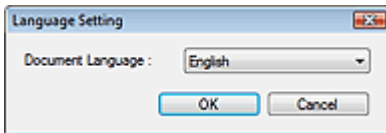

 **Important**

- You can change which items are installed during installation from the Setup CD-ROM by selecting Custom Install. If you choose not to install some applications with Custom Install, the corresponding MP Navigator EX functions will be unavailable. To use those functions, install the corresponding applications.
- For Open PDF file, the application associated with the .pdf file extension by the operating system is displayed.

Scanner Button Settings Tab

In Scanner Button Settings tab, you can specify the scan/save settings, application to start, etc. for scanning using the Operation Panel of the machine.

Related Topic

- ▶ [Scanner Button Settings Tab \(Save\)](#)

[Top of Page](#)↑

Advanced Guide

Advanced Guide > Scanning > Scanning with the Bundled Application Software > MP Navigator EX Screens > Scanner Button Settings Tab (Save)

Scanner Button Settings Tab (Save)

On the Scanner Button Settings tab, you can specify the following settings.

You can specify how to respond when scanning using the Operation Panel of the machine.

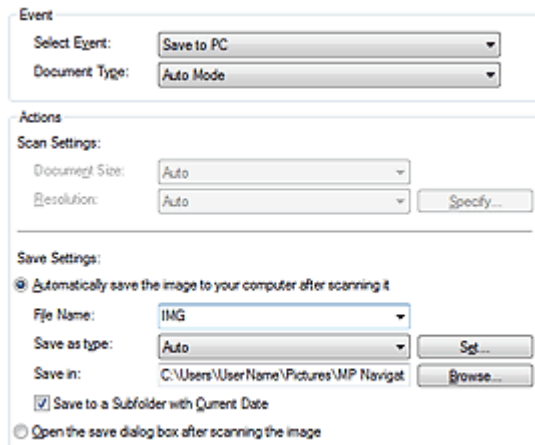

Event

- **Select Event**

Save to PC is set.

- **Document Type**

Auto Mode is set. The document type is automatically detected.

Important

- The following types of documents cannot be scanned correctly with Auto Mode. In that case, specify Document Type in MP Navigator EX. See "[Scanning Photos and Documents](#)" to scan images using MP Navigator EX.
 - Documents other than photos, Hagaki, business cards, magazines, newspapers, text documents and CD/DVD.
 - A4 photos.
 - Text documents smaller than 2L (5 inches x 7 inches) (127 mm x 178 mm), such as paperback pages with the spine cut off.
 - Documents printed on thin white paper.
 - Wide documents such as panoramic photos.
- Place documents correctly according to the type of document to be scanned. Otherwise, documents may not be scanned correctly. See "[Placing Documents](#)" for details on how to place documents.

Actions

Scan Settings

- **Document Size**

This setting is automatically set.

- **Resolution**

This setting is automatically set.

- **Specify...**

This setting is not available for this machine.

Save Settings

- **Automatically save the image to your computer after scanning it**

Select this to save the images to your computer as specified after scanning them.
The File Name, Save as type and Save in settings will be displayed.

Important

- If you select this function, you will not be able to set passwords for PDF files.

- **File Name**

Enter the file name of the image to be saved (up to 32 characters).

- **Save as type**

Select a file type to save the scanned images.
Select Auto, JPEG/Exif, TIFF or BMP. Auto is displayed by default.

Important

- When Auto is selected, files are saved in the following formats according to the document type.
Photos, Hagaki, business cards and CD/DVD: JPEG
Magazines, newspapers and text documents: PDF
You can change the file format from Set....
Images saved as PDF files may not open depending on the application. In that case, select an option other than PDF in Save as type.
- When Document Type is Auto Mode and Save as type is Auto, the file format may differ depending on how you place the document.
See "[Placing Documents](#)" for details on how to place documents.
- Large documents (such as A4 photos) that cannot be placed away from the edges/arrow of the Platen may not be saved in the correct file format when Save as type is Auto. In that case, select a file format suitable for the document to be scanned.

- **Set...**

When Save as type is Auto

You can specify the file format in which to save images. Select a file format for saving Document and Photo each.

When Save as type is JPEG/Exif

You can specify a compression type for JPEG files. Select High(Low Compression), Standard or Low(High Compression).

- **Save in**

Displays the folder in which to save the scanned images. To change the folder, click Browse... to specify another one.

The following folders are specified by default.

Windows Vista: MP Navigator EX folder in Picture folder

Windows XP: MP Navigator EX folder in My Pictures folder

Windows 2000: MP Navigator EX folder in My Pictures folder

- **Save to a Subfolder with Current Date**

Select this checkbox to create a subfolder in the folder specified in Save in with the current date and save imported files in it. A subfolder with a name such as "2008_01_01" (Year_Month_Date) will be created.

If this checkbox is not selected, files are saved directly in the folder specified in Save in.

- **Open the save dialog box after scanning the image**

Select this to open the Save dialog box after scanning the images and specify the save settings such as destination folder, file name and Exif information.

Note

- See "[Save Dialog Box](#)" for details.

[Top of Page](#)↑

Advanced Guide

[Advanced Guide](#) > [Scanning](#) > [Scanning with the Bundled Application Software](#) > [Appendix: Opening Files Other than Scanned Images](#)

Appendix: Opening Files Other than Scanned Images

You can save or print data other than scanned images using MP Navigator EX.

- **Using images saved on a memory card**
 - ➔ [Importing Images Saved on a Memory Card](#)
- **Using images saved on a computer**
 - ➔ [Opening Images Saved on a Computer](#)

[Top of Page](#)↑

Advanced Guide

Advanced Guide > Scanning > Scanning with the Bundled Application Software > Appendix: Opening Files Other than Scanned Images > Importing Images Saved on a Memory Card

Importing Images Saved on a Memory Card

You can import images (including PDF files scanned with the operation panel) saved on a memory card, and save them to a computer or print them using MP Navigator EX. You can also attach them to e-mail, or edit them using an application that accompanies the machine.

When saving PDF files, you can select whether to enable keyword search, and also specify the compression type and other advanced settings.

Important

- Do not remove or insert memory cards while they are being accessed or the Access Lamp of the machine is flashing.
- The machine can only detect one memory card at a time. Do not simultaneously insert multiple memory cards.
- When switching to another memory card of the same type or inserting another memory card in a different Card Slot, make sure that the Access Lamp of the machine is not flashing, then remove the memory card. Then, insert another memory card.
- The machine's Card Slot (memory card) may become inaccessible. In that case, restart the machine or turn it off and reconnect the USB cable.

1. Insert a memory card containing image/PDF files into the machine's Card Slot.

For details on how to insert a memory card into the machine, refer to the on-screen manual: Basic Guide.

2. Start MP Navigator EX as follows.

• Windows Vista and Windows XP:

The program selection dialog box opens. Click MP Navigator EX Ver2.0.

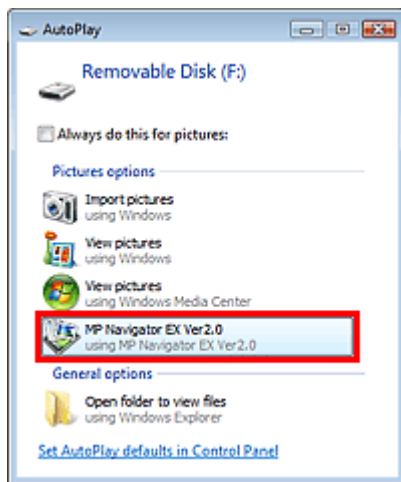

Note

- If you want to start MP Navigator EX every time a memory card is inserted into the machine, follow these steps.
Windows Vista:
Select the Always do this for pictures checkbox and click MP Navigator EX Ver2.0.
Windows XP:
Select MP Navigator EX Ver2.0, then select the Always do the selected action. checkbox and click OK.

The Memory Card screen of the Scan/Import window appears, and the images and PDF files saved on the memory card appear in the Thumbnail window.

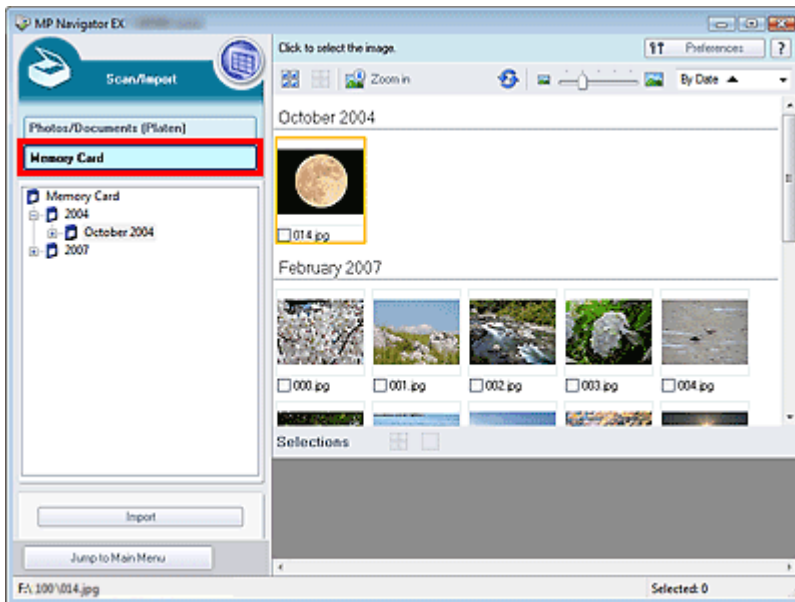

Note

- See "Memory Card Screen (Scan/Import Window)" for details on the Memory Card screen (Scan/Import window).

Windows 2000:

Start MP Navigator EX and open the Navigation Mode screen.

➔ Starting MP Navigator EX

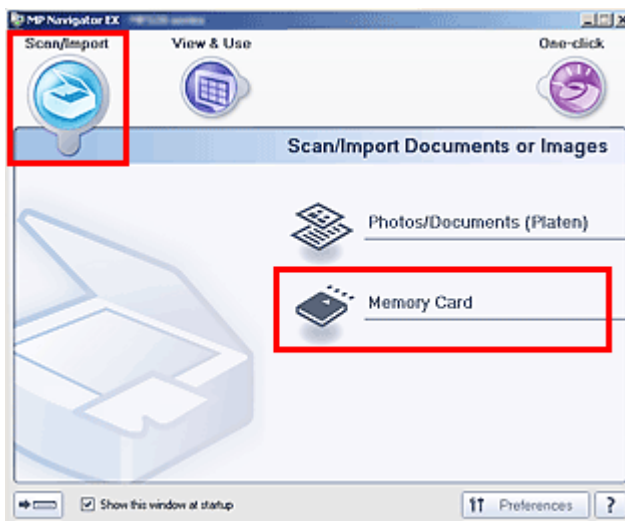

Point to Scan/Import and click Memory Card. The Memory Card screen of the Scan/Import window appears, and the images and PDF files saved on the memory card appear in the Thumbnail window.

3. Select the checkboxes of the images and PDF files you want to import, then click Import.

The Import dialog box opens. Specify the folder in which to save the imported files.

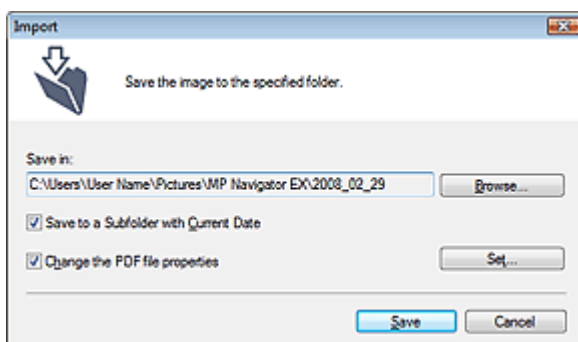

• Save in

Displays the folder in which to save the imported images and PDF files. To change the folder, click Browse... to specify another one.

The following folders are specified by default.

Windows Vista: MP Navigator EX folder in Picture folder

Windows XP: MP Navigator EX folder in My Pictures folder

Windows 2000: MP Navigator EX folder in My Pictures folder

- **Save to a Subfolder with Current Date**

Select this checkbox to create a subfolder in the folder specified in Save in with the current date and save imported files in it. A subfolder with a name such as "2008_01_01" (Year_Month_Date) will be created.

If this checkbox is not selected, files are saved directly in the folder specified in Save in.

- **Change the PDF file properties**

This option is displayed when the memory card contains a PDF file.

Select this checkbox to specify advanced settings for saving PDF files. Click Set... to open a dialog box in which you can specify advanced settings. See " [PDF Settings Dialog Box](#) " for details.

4. Click Save.

The imported images and PDF files appear in the View & Use window.

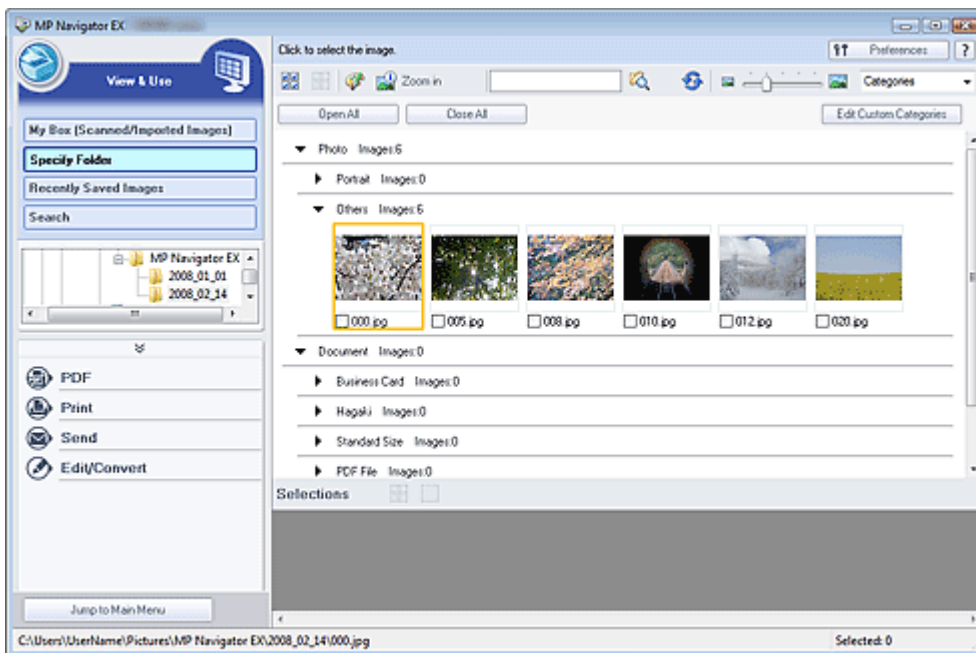

See the corresponding sections below for details on using the imported images and PDF files.

- ➔ [Creating/Editing PDF Files](#)
- ➔ [Printing Documents](#)
- ➔ [Printing Photos](#)
- ➔ [Sending via E-mail](#)
- ➔ [Editing Files](#)

[Top of Page](#)↑

Advanced Guide

Advanced Guide > Scanning > Scanning with the Bundled Application Software > Appendix: Opening Files Other than Scanned Images > Opening Images Saved on a Computer

Opening Images Saved on a Computer

You can open images saved on a computer and print them or attach them to e-mail using MP Navigator EX. You can also edit them using an application that accompanies the machine.

1. Start MP Navigator EX and open the Navigation Mode screen.

➔ Starting MP Navigator EX

2. In the Navigation Mode screen, point to View & Use and click My Box (Scanned/Imported Images), Specify Folder or Recently Saved Images.

Click My Box (Scanned/Imported Images) to open images saved in My Box (Scanned/Imported Images), click Specify Folder to open images saved in a specific folder, or click Recently Saved Images to open recently saved images.

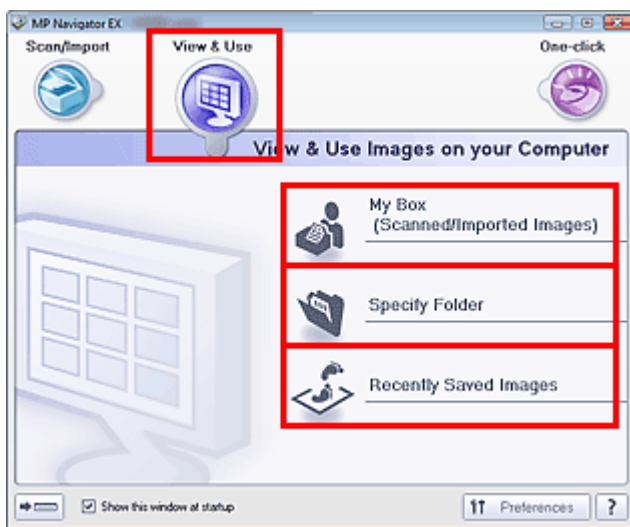

Note

- If the Show this window at startup checkbox is not selected, the last used screen appears. If the Scan/Import window is displayed, click  (View & Use) on the upper left of the screen. The View & Use window opens.
- See "[View & Use Images on your Computer Tab](#)" for details on the View & Use Images on your Computer tab.

3. Click the folder containing the images you want to open.

Images saved in the folder appear in the Thumbnail window.

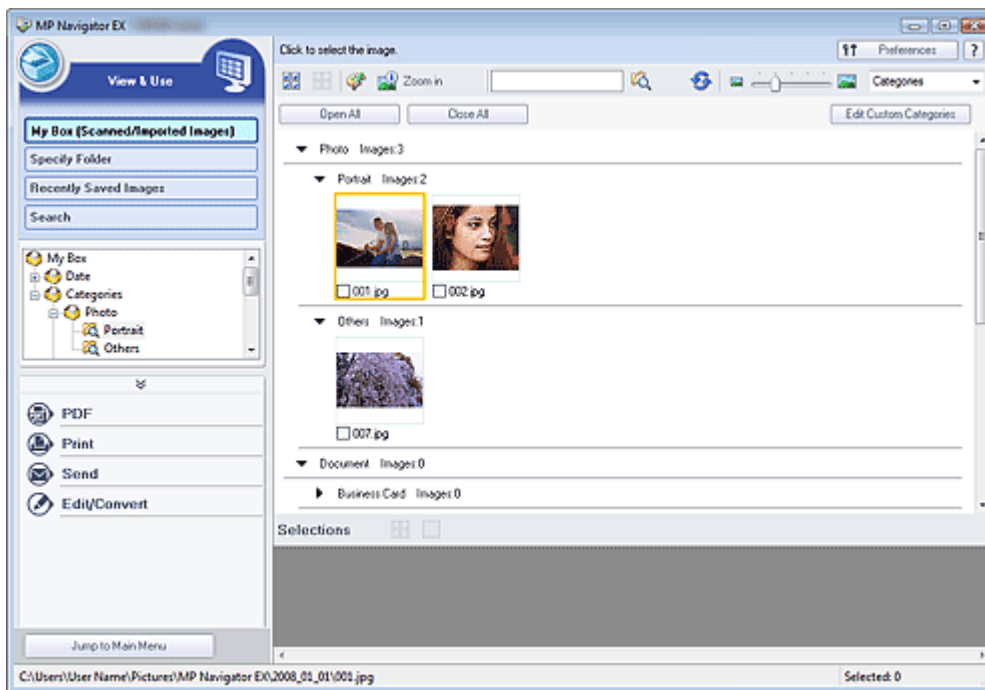

4. Select the images you want to use, then select what you want to do with them.

See the corresponding sections below for details on using images.

➔ [Creating/Editing PDF Files](#)

➔ [Printing Documents](#)

➔ [Printing Photos](#)

➔ [Sending via E-mail](#)

➔ [Editing Files](#)

[Top of Page](#)↑

Advanced Guide

[Advanced Guide](#) > [Scanning](#) > [Scanning with Other Application Software](#)

Scanning with Other Application Software

- ➔ [What Is ScanGear \(Scanner Driver\)?](#)
- ➔ [Scanning with Advanced Settings Using ScanGear \(Scanner Driver\)](#)
- ➔ [Correcting Images and Adjusting Colors](#)
- ➔ [ScanGear \(Scanner Driver\) Screens](#)
- ➔ [Appendix: Useful Information on Scanning](#)

[Page top](#) ↕

Advanced Guide

Advanced Guide > Scanning > Scanning with Other Application Software > What Is ScanGear (Scanner Driver)?

What Is ScanGear (Scanner Driver)?

ScanGear (scanner driver) is software required for scanning documents. It enables you to specify the output size and make image corrections when scanning documents.

ScanGear can be started from MP Navigator EX or from other applications that are compatible with a standard interface called TWAIN. (ScanGear (scanner driver) is a TWAIN-compatible driver.)

What You Can Do with this Software

This software enables you to preview scan results or set document type and output size, etc. when scanning documents. It is useful when you want to scan in a specific color tone, as it allows you to make various corrections and adjust brightness, contrast, etc.

Screens

There are three modes: Basic Mode, Advanced Mode and Auto Scan Mode.

Switch modes by clicking a tab on the upper right of the screen.

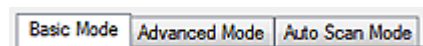

Note

- ScanGear (scanner driver) starts in the last used mode.
- Settings are not retained when you switch between modes.

Basic Mode

Use Basic Mode to scan easily by following three simple on-screen steps (1 , 2 , 3)

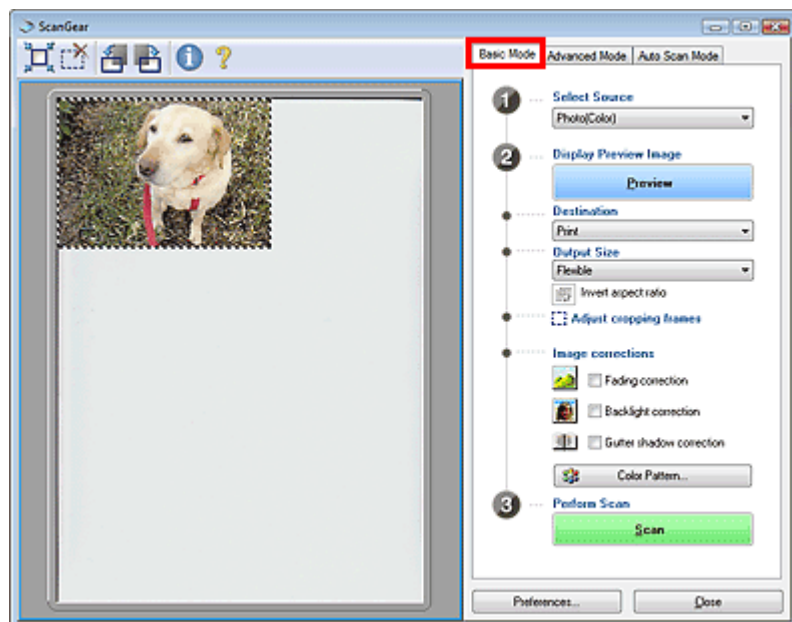

Advanced Mode

Use Advanced Mode to select color mode, specify resolution, correct images, adjust colors, etc. when scanning documents.

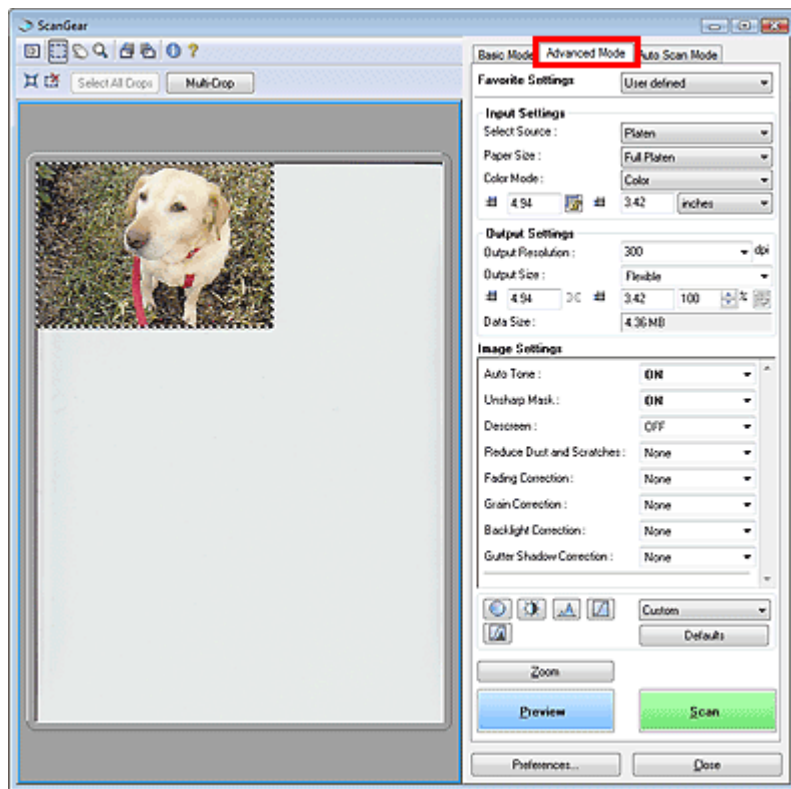

Auto Scan Mode

Use Auto Scan Mode to scan easily by simply placing the document on the Platen and clicking Scan.

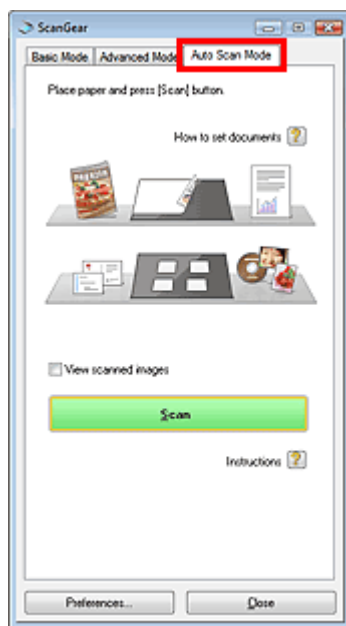

[Top of Page](#)

Advanced Guide

[Advanced Guide](#) > [Scanning](#) > [Scanning with Other Application Software](#) > [Scanning with Advanced Settings Using ScanGear \(Scanner Driver\)](#)

Scanning with Advanced Settings Using ScanGear (Scanner Driver)

- **Starting ScanGear (scanner driver)**
 - ➔ [Starting ScanGear \(Scanner Driver\)](#)
- **Scanning documents after making simple image corrections**
 - ➔ [Scanning in Basic Mode](#)
- **Scanning documents after making advanced image corrections and brightness/color adjustments**
 - ➔ [Scanning in Advanced Mode](#)
- **Scanning with a simple operation**
 - ➔ [Scanning in Auto Scan Mode](#)
- **Scanning multiple documents at one time after making image corrections and color adjustments**
 - ➔ [Scanning Multiple Documents at One Time in Advanced Mode](#)

[Top of Page](#)↑

Advanced Guide

Advanced Guide > Scanning > Scanning with Other Application Software > Scanning with Advanced Settings Using ScanGear (Scanner Driver) > Starting ScanGear (Scanner Driver)

Starting ScanGear (Scanner Driver)

Use ScanGear (scanner driver) to make image corrections and color adjustments when scanning documents. ScanGear (scanner driver) can be started from MP Navigator EX or an application.

Follow these steps to start ScanGear (scanner driver).

Starting from MP Navigator EX

Navigation Mode Screen

Follow these steps to start ScanGear (scanner driver) from the Navigation Mode screen of MP Navigator EX.

1. Start MP Navigator EX and open the Navigation Mode screen.
➔ Starting MP Navigator EX
2. Point to Scan/Import and click Photos/Documents (Platen).
The Scan/Import window opens.
3. Select the Use the scanner driver checkbox, then click Open Scanner Driver.

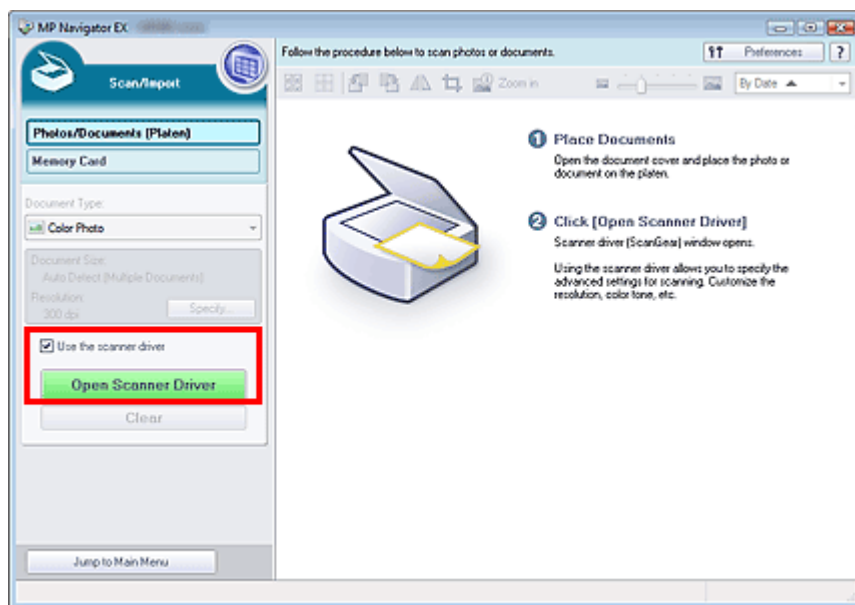

The ScanGear (scanner driver) screen appears.

One-click Mode Screen

Follow these steps to start ScanGear (scanner driver) from the One-click Mode screen of MP Navigator EX.

1. Start MP Navigator EX and open the One-click Mode screen.
➔ Starting MP Navigator EX
2. Click the corresponding icon.
The corresponding dialog box opens.
3. Select the Use the scanner driver checkbox in Scan Settings, then click Scan.

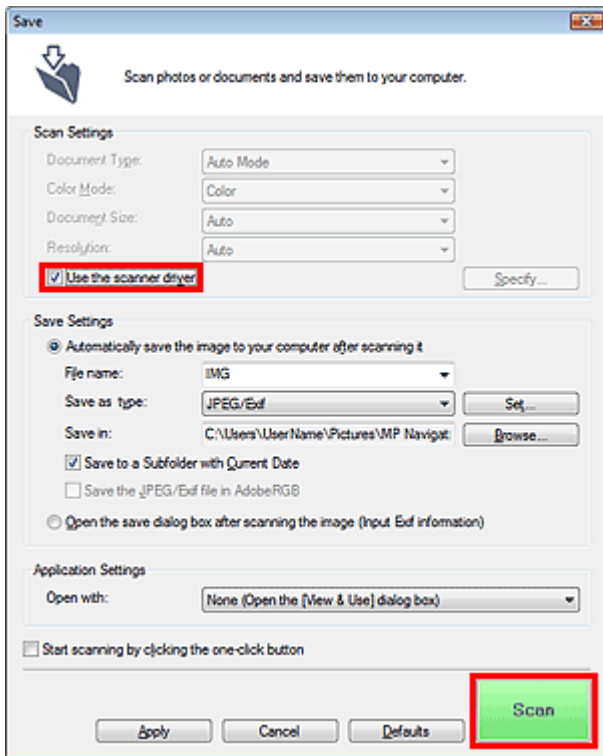

The ScanGear (scanner driver) screen appears.

Important

- Use the scanner driver is not displayed in the PDF dialog box.

Starting from an Application

Follow these steps (example) to start ScanGear (scanner driver) from an application.

The procedure varies depending on the application. For details, refer to the application's manual.

1. Start the application.
2. On the File menu of the application, select Select Source and select the machine.
3. Select the command to scan a document (Scan/Import, Acquire image, etc.).

The ScanGear (scanner driver) screen appears.

[Top of Page↑](#)

Advanced Guide

Advanced Guide > Scanning > Scanning with Other Application Software > Scanning with Advanced Settings Using ScanGear (Scanner Driver) > Scanning in Basic Mode

Scanning in Basic Mode

In Basic Mode, you can scan easily by following the on-screen steps.

1. Place the document on the Platen, then start ScanGear (scanner driver).

➔ Starting ScanGear (Scanner Driver)

Important

- Place the the document face-down and align correctly with the arrow/marks on the Platen.

2. Set Select Source according to the document placed on the Platen.

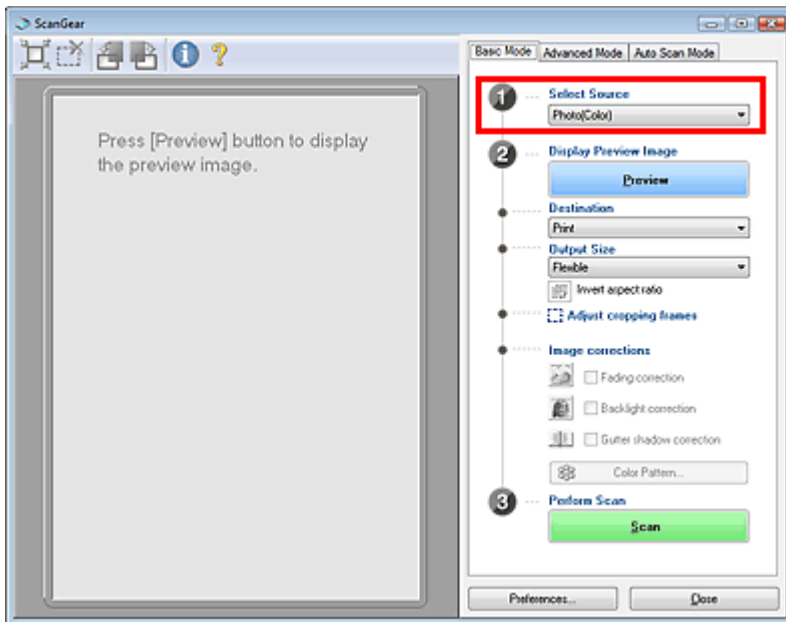

Note

- To scan magazines containing many color photos, scan in Advanced Mode with Color Mode set to Color and Descreen set to ON.
➔ Scanning in Advanced Mode

3. Click Preview.

Preview image appears in the Preview area.

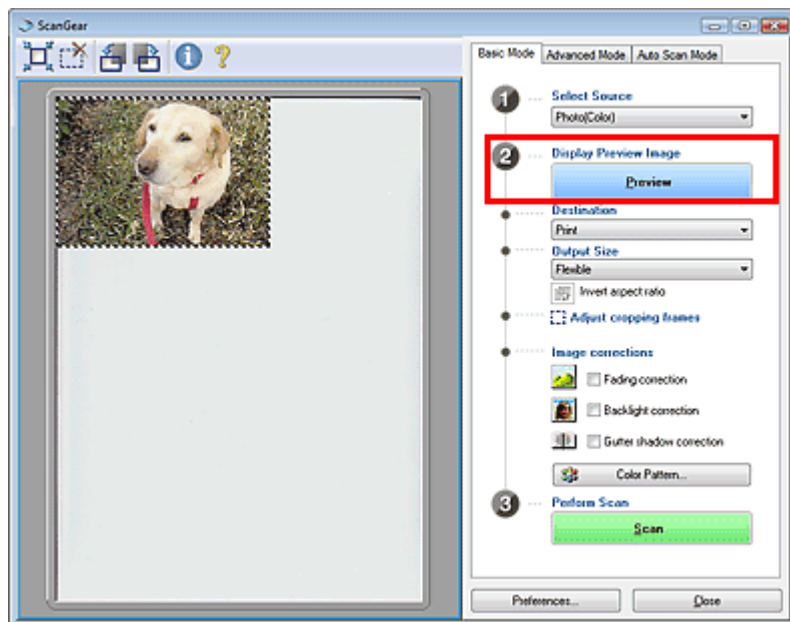

Note

- If you scan without preview, colors are adjusted based on the document type selected in Select Source.

4. Set Destination.

Note

- To scan at 301 dpi or higher, scan in Advanced Mode.
➔ [Scanning in Advanced Mode](#)

5. Set Output Size.

Output size options vary by the items selected in Select Source and Destination.

6. Adjust the scan area (cropping frame) as required.

Adjust the size and position of the scan area (cropping frame) on the preview image. You can also create two or more cropping frames.

If an area is not specified, the document will be scanned at the document size (Auto Crop). If an area is specified, only the portion in the specified area will be scanned.

➔ [Adjusting Cropping Frames](#)

7. Set Image corrections as required.

- **Color Pattern...**

Click Color Pattern... to open the Color Adjustment dialog box in which you can adjust the overall image color. You can correct colors that have faded due to colorcast, etc. and reproduce natural colors.

➔ [Adjusting Colors Using a Color Pattern](#)

8. Click Scan.

Scanning starts.

Note

- ScanGear's response after scanning can be specified in Status of ScanGear dialog after scanning on the Scan tab of the Preferences dialog box.
➔ [Scan Tab](#)

Note

- See "[Basic Mode Tab](#)" for details on the Basic Mode Tab.

Advanced Guide

Advanced Guide > Scanning > Scanning with Other Application Software > Scanning with Advanced Settings Using ScanGear (Scanner Driver) > Scanning in Advanced Mode

Scanning in Advanced Mode

In Advanced Mode, you can specify the color mode, output resolution, image brightness, color tone, etc. when scanning documents.

1. Place the document on the Platen, then start ScanGear (scanner driver).

➔ Starting ScanGear (Scanner Driver)

Important

- Place the the document face-down and align correctly with the arrow/marks on the Platen.

2. Click Advanced Mode.

The Advanced Mode tab appears.

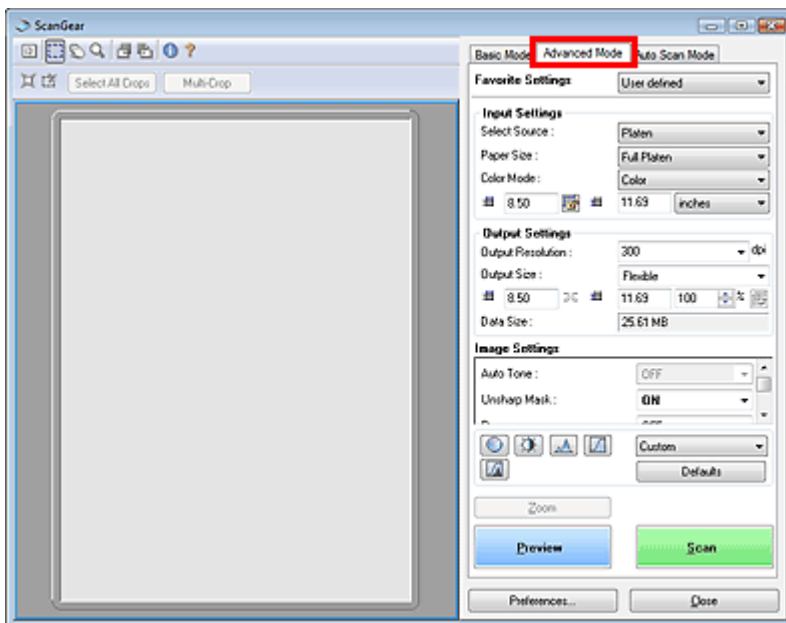

Note

- Settings are not retained when you switch between modes.

3. Set Paper Size and Color Mode.

Note

- See "Input Settings" for details on Paper Size and Color Mode.

4. Click Preview.

Preview image appears in the Preview area.

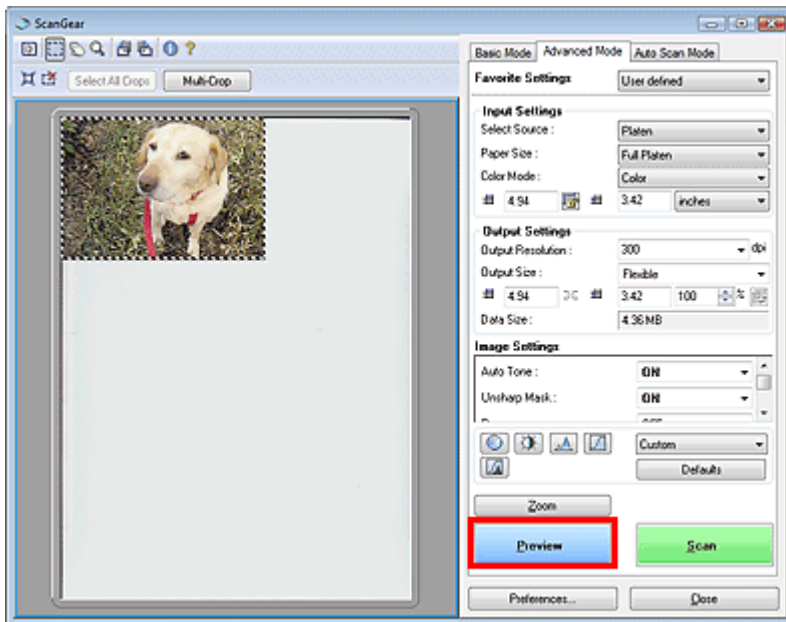

Note

- If you scan without preview, the show-through prevention function will be active. This function is useful when scanning magazines. However, when scanning photos, the color tone of the scanned image may differ from the source due to the show-through prevention function. In that case, use preview first.

5. Set Output Settings.

➔ [Output Settings](#)

6. Adjust the cropping frame, correct images and adjust colors as required.

Note

- See the corresponding sections below for details on Image Settings and the Color Adjustment Buttons.
 - ➔ [Image Settings](#)
 - ➔ [Color Adjustment Buttons](#)
- See "[Adjusting Cropping Frames](#)" for details on cropping frames.

7. Click Scan.

Scanning starts.

Note

- ScanGear's response after scanning can be specified in Status of ScanGear dialog after scanning on the Scan tab of the Preferences dialog box.
 - ➔ [Scan Tab](#)

Note

- See "[Advanced Mode Tab](#)" for details on the Advanced Mode Tab.

[Top of Page](#)↑

Advanced Guide

Advanced Guide > Scanning > Scanning with Other Application Software > Scanning with Advanced Settings Using ScanGear (Scanner Driver) > Scanning in Auto Scan Mode

Scanning in Auto Scan Mode

You can scan easily in Auto Scan Mode of ScanGear (scanner driver) by letting it automatically determine the type of document placed on the Platen.

Note

- Supported document types are photos, Hagaki, business cards, magazines, newspapers, text documents and CD/DVD. To scan other documents, specify the document type on the Basic Mode tab or the Advanced Mode tab.
 - ➔ Scanning in Basic Mode
 - ➔ Scanning in Advanced Mode
- See "Auto Scan Mode Tab" for details on the Auto Scan Mode Tab.

1. Place the document on the Platen, then start ScanGear (scanner driver).

- ➔ Placing Documents
- ➔ Starting ScanGear (Scanner Driver)

2. Click Auto Scan Mode.

The Auto Scan Mode tab appears.



3. Click Scan.

Scanning starts.

Note

- ScanGear's response after scanning can be specified in Status of ScanGear dialog after scanning on the Scan tab of the Preferences dialog box.
 - ➔ Scan Tab

[Top of Page](#)↑

Advanced Guide

Advanced Guide > Scanning > Scanning with Other Application Software > Scanning with Advanced Settings Using ScanGear (Scanner Driver) > Scanning Multiple Documents at One Time in Advanced Mode

Scanning Multiple Documents at One Time in Advanced Mode

You can scan two or more photos (small documents) on the Platen at one time by using Multi-Crop in Advanced Mode of ScanGear (scanner driver).

Important

- The following types of documents cannot be cropped correctly.
 - Documents smaller than 1.18 inches (3 cm) square.
 - Photos that have been cut to various shapes.
 - The following types of documents may not be cropped correctly. In that case, start ScanGear (scanner driver), then adjust the cropping frame in Advanced Mode tab and scan again.
 - Photos that have a whitish border.
 - Documents printed on white paper, hand-written text, business cards, etc.
 - Thin documents
 - Thick documents
- ➔ [Scanning in Advanced Mode](#)

1. Place the document on the Platen, then start ScanGear (scanner driver).

- ➔ [Placing Documents](#)
- ➔ [Starting ScanGear \(Scanner Driver\)](#)

2. Click Advanced Mode.

The Advanced Mode tab appears.

3. Click Preview.

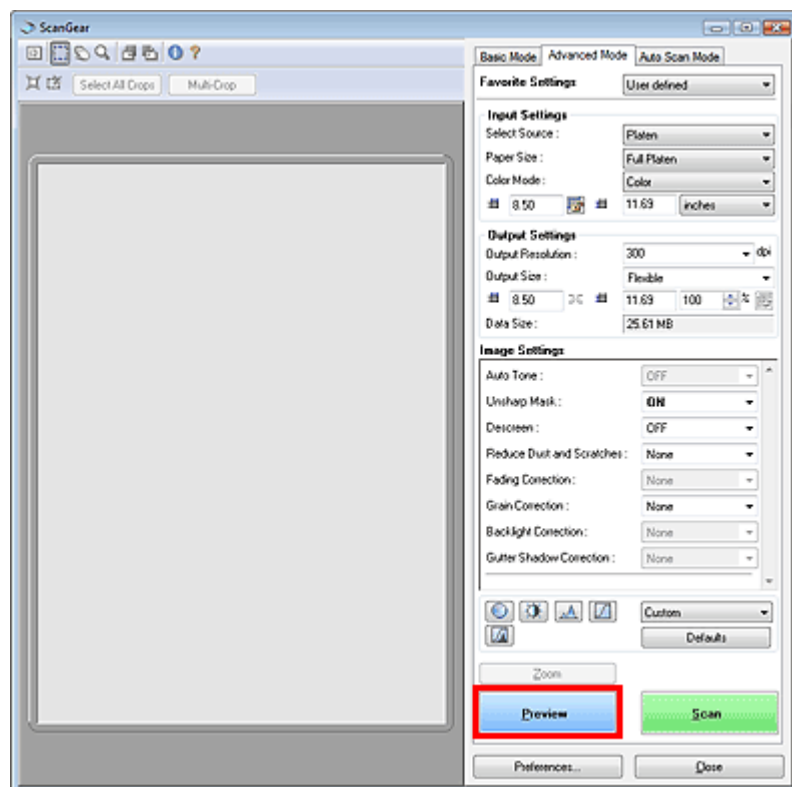

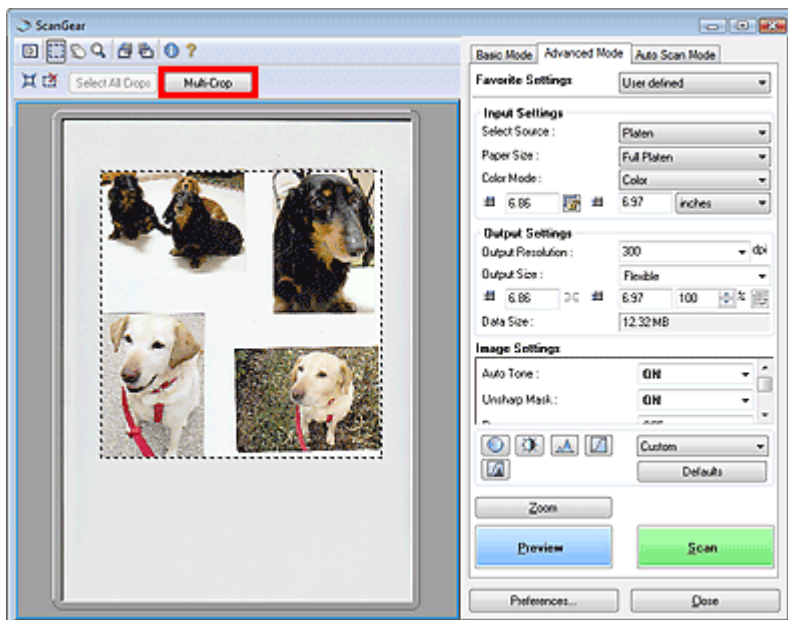

Preview image appears in the Preview area.

4. Click Multi-Crop above the Preview area.

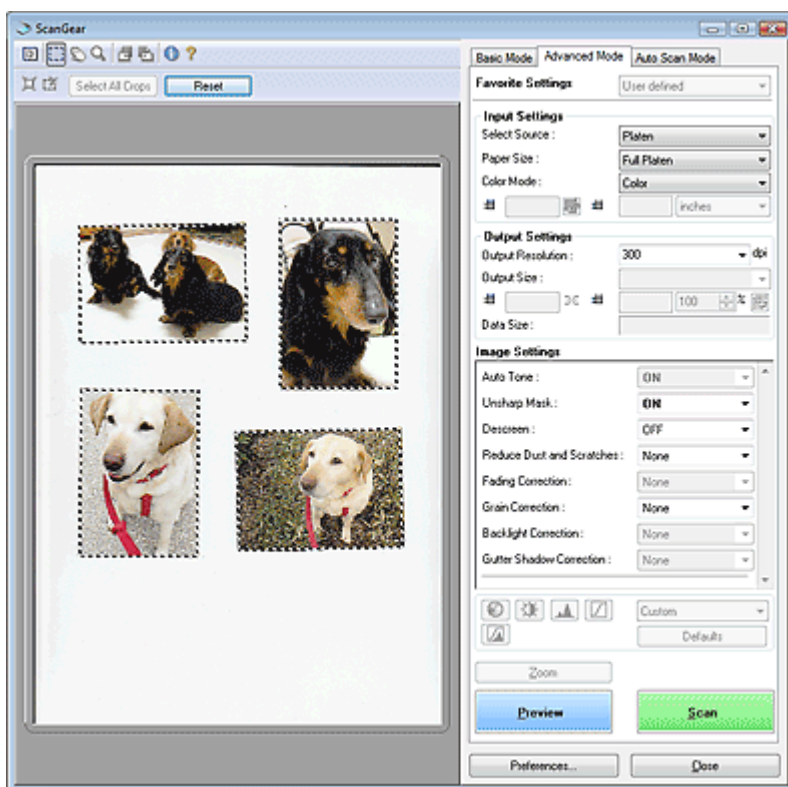

Each image is cropped (scan area is specified) automatically according to the document size.



If you do not want to scan one, select the image and press the Delete key. Alternatively, select the image and click  (Remove Cropping Frame) on the Toolbar.

Note

- When you click Multi-Crop, Multi-Crop changes to Reset. Click Reset to cancel Multi Crop.
- Cancel Multi Crop to create custom cropping frames.
 - ➔ [Adjusting Cropping Frames](#)

5. Set Color Mode, Output Resolution, etc. as required.

Note

- See "[Input Settings](#)" for details on the Color Mode.
- See "[Output Settings](#)" for details on the Output Resolution.
- The settings are applied to all cropping frames.

6. Make image corrections as required.

 **Note**

-
- See "[Image Settings](#)" for details on each function.
 - The settings are applied to all cropping frames.
-

7. Click Scan.

Each cropping frame is scanned as an individual image.

 **Note**

-
- ScanGear's response after scanning can be specified in Status of ScanGear dialog after scanning on the Scan tab of the Preferences dialog box.
➔ [Scan Tab](#)
-

[Top of Page](#)↑

Advanced Guide

[Advanced Guide](#) > [Scanning](#) > [Scanning with Other Application Software](#) > [Correcting Images and Adjusting Colors](#)

Correcting Images and Adjusting Colors

The following sections provide you with tips and know-how on advanced scanning techniques involving color/brightness adjustment, etc.

- **Sharpening out-of-focus photos, reducing dust and scratches, and correcting faded colors**
 - ➔ [Correcting Images \(Unsharp Mask, Reduce Dust and Scratches, Fading Correction, etc.\)](#)
- **Previewing and changing the color tone of the entire image to scan**
 - ➔ [Adjusting Colors Using a Color Pattern](#)
- **Brightening colors that have faded with time or due to colorcast**
 - ➔ [Adjusting Saturation and Color Balance](#)
- **Adjusting images that are too dark or bright, or too flat due to lack of contrast**
 - ➔ [Adjusting Brightness and Contrast](#)
- **Adjusting the color tone using histogram (a graph showing brightness distribution)**
 - ➔ [Adjusting Histogram](#)
- **Adjusting the image brightness using tone curve (a graph of brightness balance)**
 - ➔ [Adjusting Tone Curve](#)
- **Sharpening characters in text documents or reducing show-through effects**
 - ➔ [Setting Threshold](#)

[Top of Page](#)↑

Advanced Guide

Advanced Guide > Scanning > Scanning with Other Application Software > Correcting Images and Adjusting Colors > Correcting Images (Unsharp Mask, Reduce Dust and Scratches, Fading Correction, etc.)

Correcting Images (Unsharp Mask, Reduce Dust and Scratches, Fading Correction, etc.)

The Image Settings functions in Advanced Mode of ScanGear (scanner driver) allow you to enhance the outline of the subjects, reduce dust/scratches and correct faded colors when scanning images.

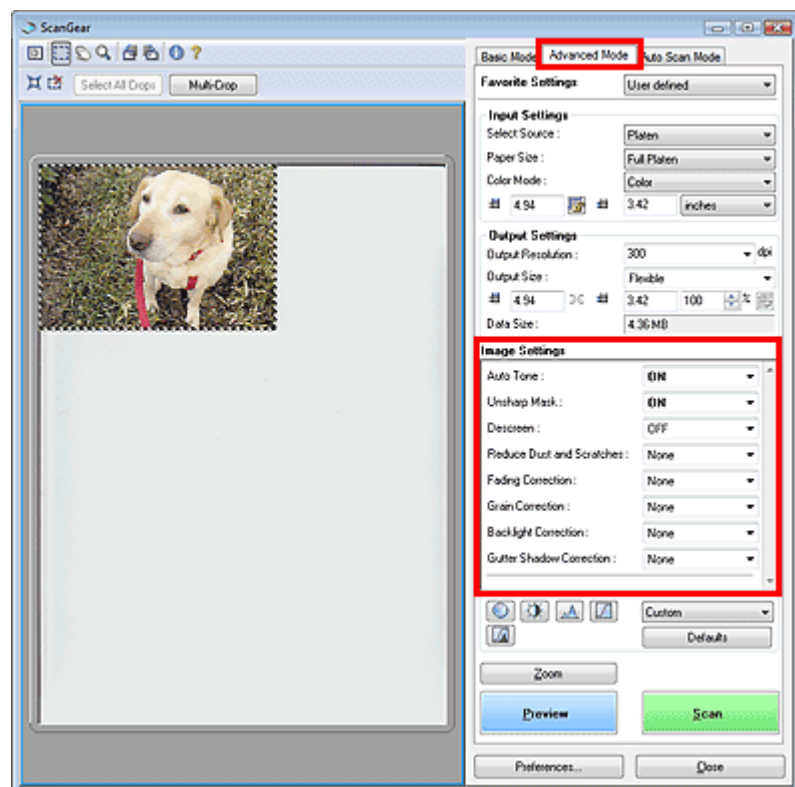

Setting Items

Click  of a function and select an item from the pull-down menu.



Important

- Do not apply these functions to images without moire, dust/scratches or faded colors. The color tone may be adversely affected.
- See the section below for details and precautions on each function.
 - [Image Settings](#)

Note

- See the section below to start ScanGear (scanner driver) in Advanced Mode and scan.
 - [Scanning in Advanced Mode](#)

Adjusting the image brightness

Set Auto Tone to ON.

Sharpening slightly out-of-focus images

Set Unsharp Mask to ON.

OFF	ON
-----	----



Reducing gradations and stripe patterns

Set Descreen to ON.

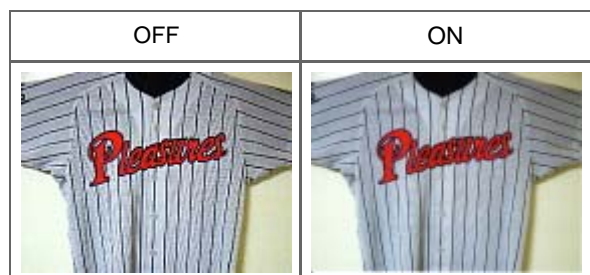

Note

- Moire is an uneven gradation or stripe pattern that appears in parts of a scanned image where the dots have interfered with each other. Descreen is the function for reducing this moire effect.

Reducing dust and scratches

Set Reduce Dust and Scratches to Low, Medium or High according to the degree of dust and scratches.

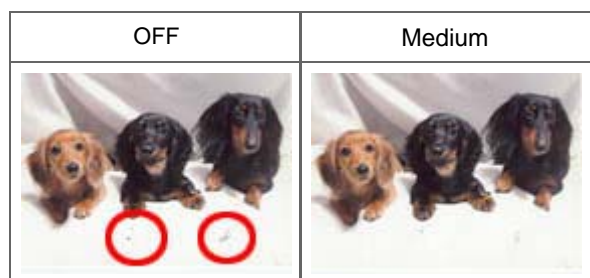

Correcting photos that have faded with time or due to colorcast

Set Fading Correction to Low, Medium or High according to the degree of fading or colorcast.

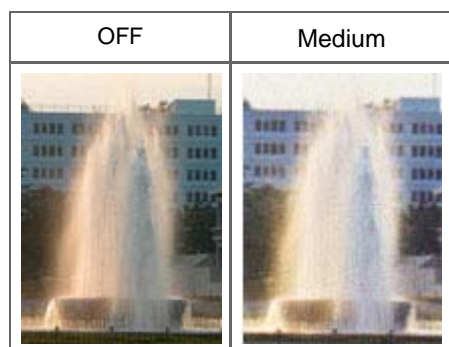

Reducing graininess

Set Grain Correction to Low, Medium or High according to the degree of graininess.



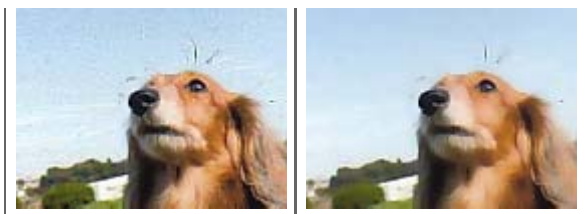

Correcting backlit images

Set Backlight Correction to Low, Medium or High according to the degree of backlight.

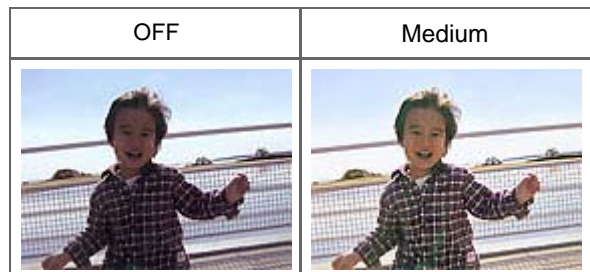

Correcting shadows that appear between pages when scanning open booklets

Set Gutter Shadow Correction to Low, Medium or High according to the degree of shadows.

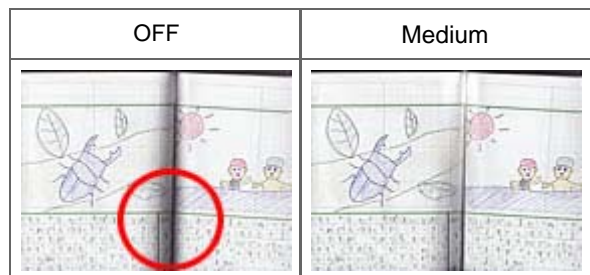

[Top of Page](#)↑

Advanced Guide

Advanced Guide > Scanning > Scanning with Other Application Software > Correcting Images and Adjusting Colors > Adjusting Colors Using a Color Pattern

Adjusting Colors Using a Color Pattern

You can preview color changes and reproduce natural colors by using the Color Pattern function in ScanGear's Basic Mode.

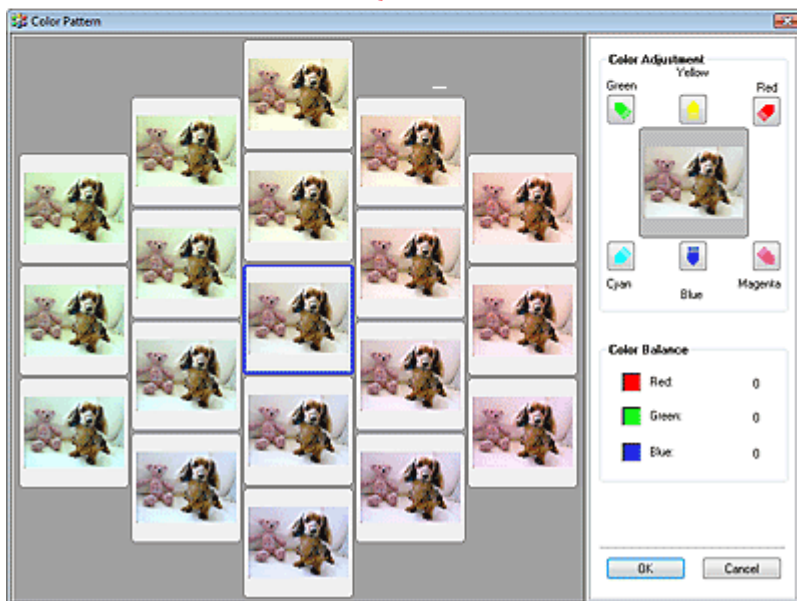
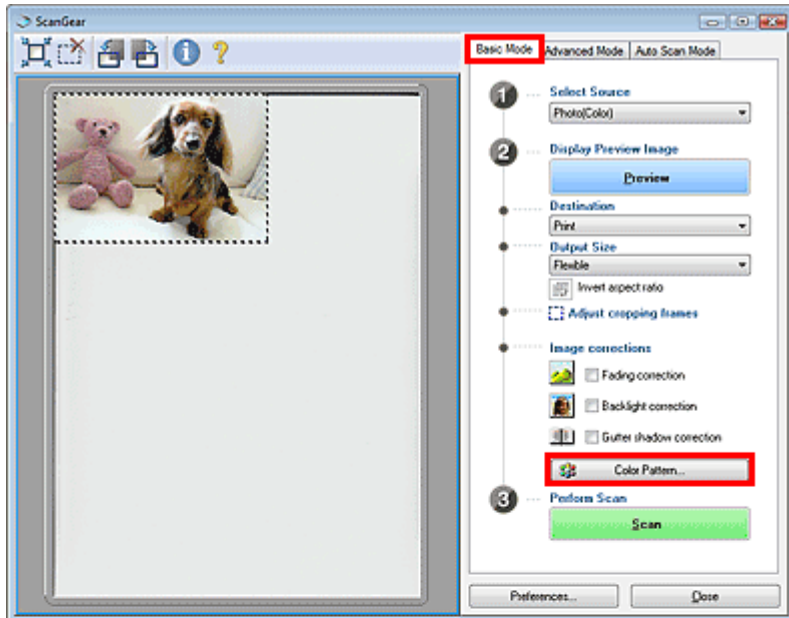

Color Adjustment

Correct colors that have faded with time or due to colorcast. Colorcast is a phenomenon where a specific color affects the entire picture due to the weather or ambient strong colors.

Click an arrow in Color Adjustment to emphasize the corresponding color.

Cyan & red, magenta & green and yellow & blue are complementary color pairs (each pair produces a shade of gray when mixed). You can reproduce the natural colors of the scene by reducing the cast color and increasing the complementary color.

It is recommended that you find a portion in the image where it should be white, and adjust the colors so that the portion turns white.

Preview image appears in the center. Preview image colors change as you adjust them.

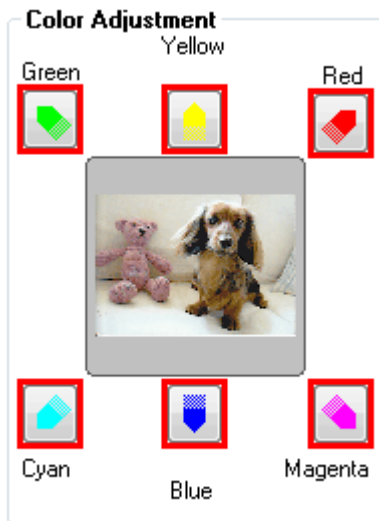

Below is an example of correcting a bluish image.

Since Blue and Green are too strong, click the Yellow and Magenta arrows to correct.



Note

- Color adjustments are applied only to the scan area (cropping frame) specified in the Preview area.
- You can also select a color tone from the color pattern displayed on the left of the Color Pattern screen.
- You can also use this function to add a specific tint to an image. Increase the magenta to add a warm tint, and increase the blue to add a cool tint.

[Top of Page↑](#)

Advanced Guide

Advanced Guide > Scanning > Scanning with Other Application Software > Correcting Images and Adjusting Colors > Adjusting Saturation and Color Balance

Adjusting Saturation and Color Balance

In ScanGear's Advanced Mode, click  (Saturation/Color Balance).

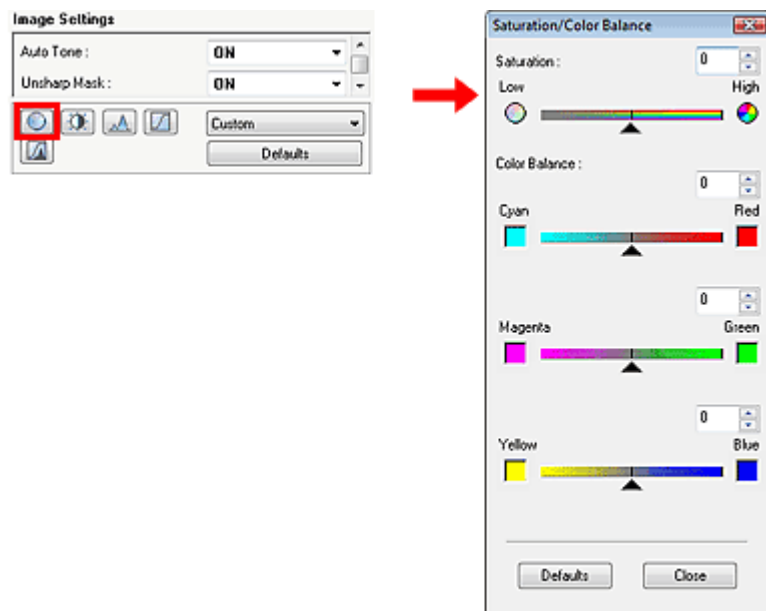

Saturation

Adjust the image's saturation (vividness). You can brighten colors that have faded with time, etc.

Move ▲ (slider) under Saturation to the left to reduce the saturation (darken the image), and to the right to increase the saturation (brighten the image). You can also enter a value (-127 to 127).



Note

- The natural color tone of the original image may be lost if you increase saturation too much.

Color Balance

Adjust images that have a colorcast. Colorcast is a phenomenon where a specific color affects the entire picture due to the weather or ambient strong colors.

Move ▲ (slider) under each color pair to the left or right to emphasize the corresponding color.

Cyan & Red

Magenta & Green

Yellow & Blue

These are complementary color pairs (each pair produces a shade of gray when mixed). You can reproduce the natural colors of the scene by reducing the cast color and increasing the complementary color.

It is usually difficult to correct the image completely by adjusting only one color pair. It is recommended that you find a portion in the image where it should be white, and adjust all three color pairs so that the portion turns white.

You can also enter a value (-127 to 127).

Below is an example of an image in which the Cyan & Red pair has been adjusted.

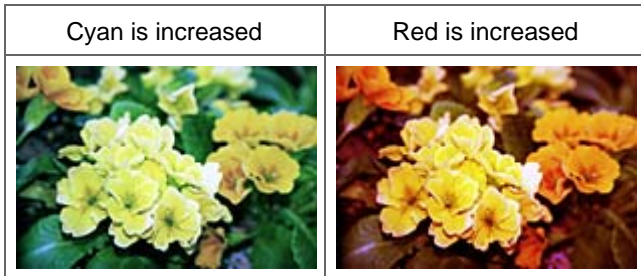

Note

- Click Defaults to reset all adjustments in the current window.

[Top of Page](#)↑

Advanced Guide



Advanced Guide > Scanning > Scanning with Other Application Software > Correcting Images and Adjusting Colors > Adjusting Brightness and Contrast

Adjusting Brightness and Contrast

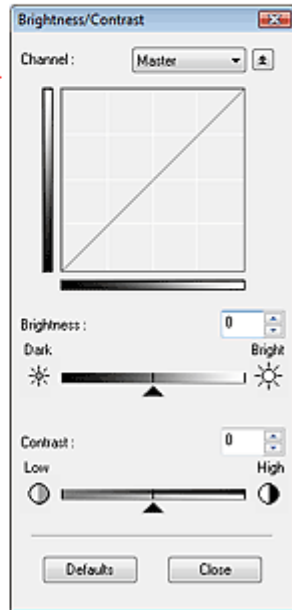
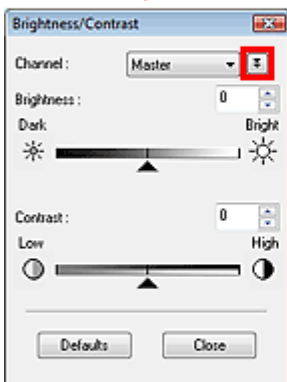
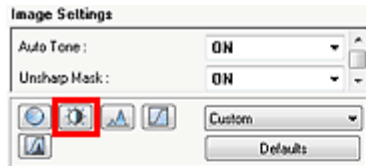
In ScanGear's Advanced Mode, click  (Brightness/Contrast).



Note

- Click  to switch to detailed view. Click  to return to the previous view.

Channel

Each dot of an image is a mixture of Red, Green and Blue in various proportions (gradation). These colors can be adjusted individually as a "channel."

- **Master**
Adjust the Red, Green and Blue combined.
- **Red**
Adjust the Red channel.
- **Green**
Adjust the Green channel.
- **Blue**
Adjust the Blue channel.

Note

- Only Grayscale will be displayed in Channel when Color Mode is Grayscale.

Brightness

Adjust the image brightness. Move  (slider) under Brightness to the left to darken and right to brighten the image. You can also enter a value (-127 to 127).



Note

- Highlights may be lost if you brighten the image too much, and shadows may be lost if you darken the image too much.

Contrast

Contrast is the degree of difference between the brighter and darker parts of an image. Increasing contrast will increase the difference, thus sharpening the image. Decreasing contrast will decrease the difference, thus softening the image.

Move ▲ (slider) under Contrast to the left to decrease and right to increase the contrast of the image. You can also enter a value (-127 to 127).

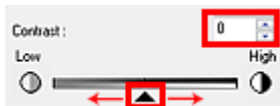

Note

- Increasing the contrast is effective in adding a three-dimensional feel to soft images. However, shadows and highlights may be lost if you increase the contrast too much.

Note

- Click Defaults to reset all adjustments in the current window.

[Top of Page](#)

Advanced Guide

Advanced Guide > Scanning > Scanning with Other Application Software > Correcting Images and Adjusting Colors > Adjusting Histogram

Adjusting Histogram

In ScanGear's Advanced Mode, click  (Histogram).

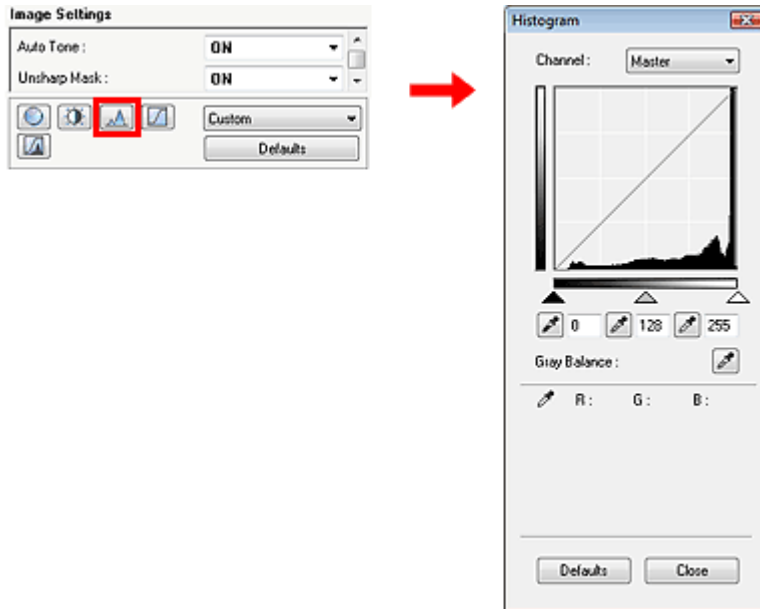

Channel

Each dot of an image is a mixture of Red, Green and Blue in various proportions (gradation). These colors can be adjusted individually as a "channel."

- **Master**
Adjust the Red, Green and Blue combined.
- **Red**
Adjust the Red channel.
- **Green**
Adjust the Green channel.
- **Blue**
Adjust the Blue channel.

Note

- Only Grayscale will be displayed in Channel when Color Mode is Grayscale.

Reading Histograms

You can open Histogram of a specified area for each Channel. The higher the Histogram peak, the more data is distributed to that level.

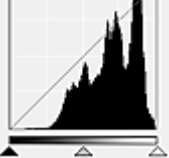
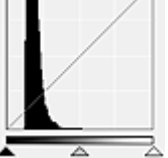
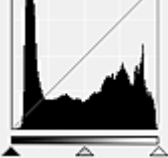

(1) Bright area	(2) Dark area	(3) Whole image

		
More data is distributed to the highlight side.	More data is distributed to the shadow side.	Data is widely distributed between the highlight and shadow.

Adjusting Histograms (Using the Slider)

Select a Channel, then move ▲ (Black-point Slider) or △ (White-point Slider) to specify the level to be set as the shadow or highlight.

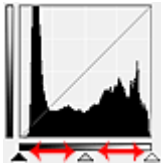

- All parts to the left of ▲ (Black-point Slider) will be black (level 0).
- The parts at △ (Mid-point Slider) will turn to the color exactly between the black-point and white-point.
- All parts to the right of △ (White-point Slider) will turn white (level 255).

Auto Tone is set to ON by default. Adjustments shown below are automatically performed.

Moving the Black-point and White-point Sliders

Move the Black-point Slider or White-point Slider to adjust brightness.

Images with more data distributed to the highlight side

Move the Black-point Slider toward the highlight side.

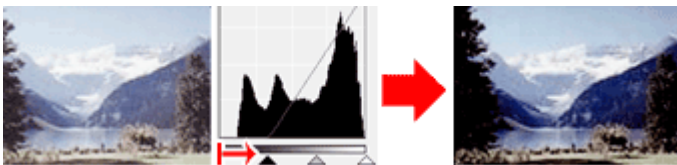

Images with more data distributed to the shadow side

Move the White-point Slider toward the shadow side.

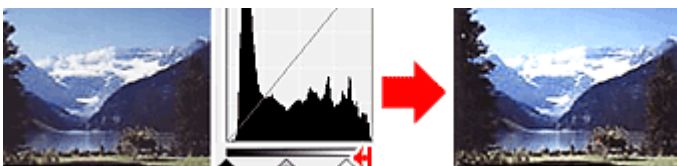

Images with widely distributed data

Move the Black-point Slider toward the highlight side, and White-point Slider toward the shadow side.

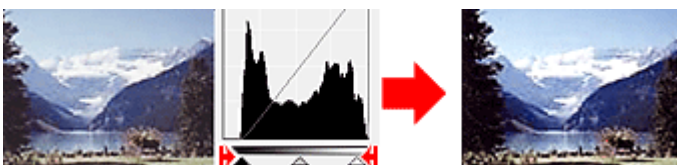

Moving the Mid-point Slider

Move the Mid-point Slider to specify the level to be set as the middle of the tonal range.

Images with more data distributed to the highlight side

Move the Mid-point Slider toward the highlight side.

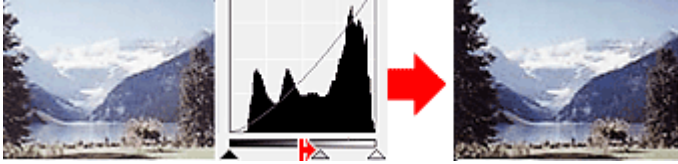

Images with more data distributed to the shadow side



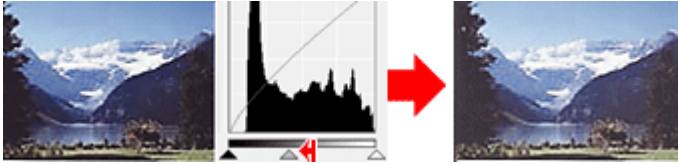

Move the Mid-point Slider toward the shadow side.

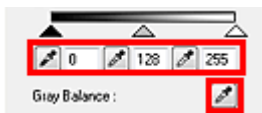

Adjusting Histograms (Using the Droppers)

When you select a Channel and click the Black-point, Mid-point or White-point Dropper, the mouse pointer on the preview image changes to a dropper. Click a Dropper displayed below the histogram to change the setting.



- The point clicked with  (Black-point Dropper) will be the darkest point. You can also enter a value (0 to 245).
- The point clicked with  (Mid-point Dropper) will be the middle of the tonal range. You can also enter a value (5 to 250).
- The point clicked with  (White-point Dropper) will be the brightest point. You can also enter a value (10 to 255).
- Click  for Gray Balance and click the area you want to adjust the color in the preview image.

The clicked point will be set as the achromatic color reference, and the rest of the image is adjusted accordingly. For instance, if snow in a photo appears bluish, click the bluish part to adjust the whole image and reproduce natural colors.

Note

- Click Defaults to reset all adjustments in the current window.

[Top of Page](#)↑

Advanced Guide

Advanced Guide > Scanning > Scanning with Other Application Software > Correcting Images and Adjusting Colors > Adjusting Tone Curve

Adjusting Tone Curve

In ScanGear's Advanced Mode, click  (Tone Curve Settings).

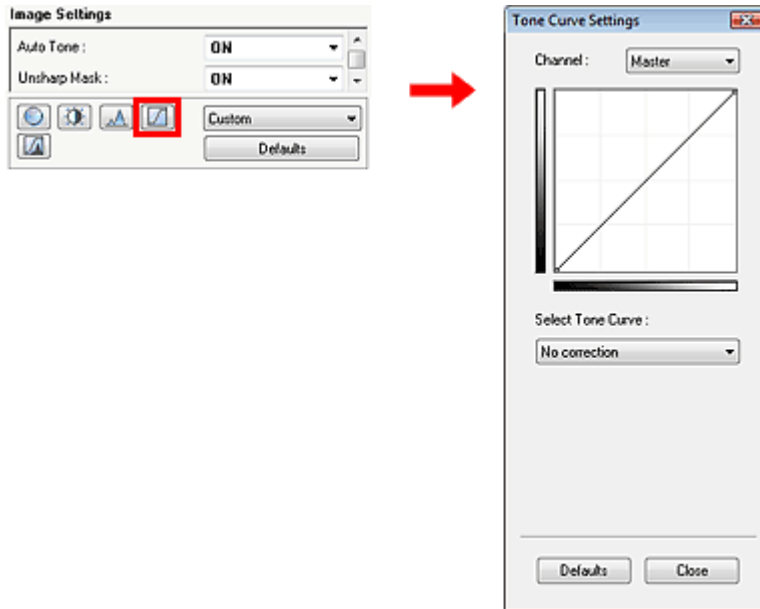

Channel

Each dot of an image is a mixture of Red, Green and Blue in various proportions (gradation). These colors can be adjusted individually as a "channel."

- **Master**
Adjust the Red, Green and Blue combined.
- **Red**
Adjust the Red channel.
- **Green**
Adjust the Green channel.
- **Blue**
Adjust the Blue channel.

Note

- Only Grayscale will be displayed in Channel when Color Mode is Grayscale.

Reading Tone Curves

With ScanGear (scanner driver), scanning images via a scanner is the input, and displaying to a monitor is the output. Tone Curve shows the balance of tone input and output for each Channel.

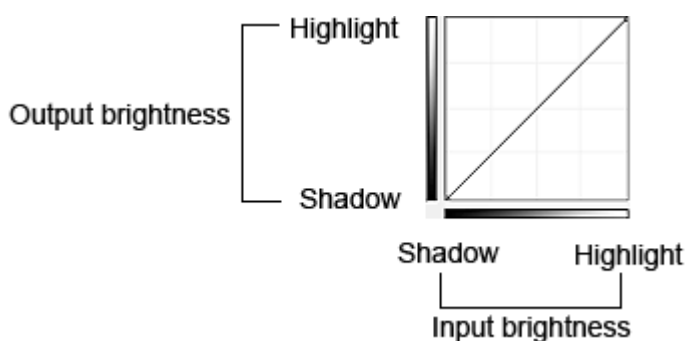

Adjusting Tone Curve

In Select Tone Curve, select a tone curve from No correction, Overexposure, Underexposure, High contrast, Reverse the negative/positive image and Edit custom curve.

No correction (No adjustment)

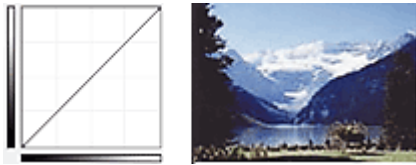

Overexposure (Convex curve)

The midtone data of the input side is stretched toward the highlight of the output side, resulting in a bright-toned image when viewed on a monitor.

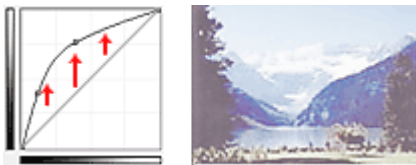

Underexposure (Convex curve)

The midtone data of the input side is stretched toward the shadow of the output side, resulting in a dark-toned image when viewed on a monitor.

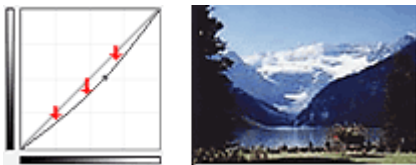

High contrast (S curve)

The highlight and shadow of the input side are enhanced, resulting in a high-contrast image.

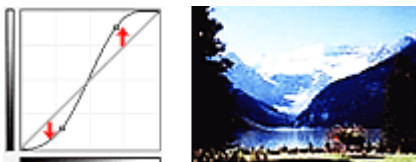

Reverse the negative/positive image (Downward-sloping line)

The input and output sides are reversed, resulting in a negative-positive inverted image.

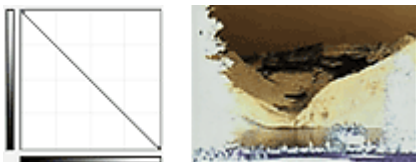

Edit custom curve

You can drag specific points on the Tone Curve to freely adjust the brightness of the corresponding areas.

Note

- Click Defaults to reset all adjustments in the current window.

Advanced Guide

Advanced Guide > Scanning > Scanning with Other Application Software > Correcting Images and Adjusting Colors > Setting Threshold

Setting Threshold

The brightness of color and grayscale images is expressed in a value between 0 and 255. However, in creating black and white images, all colors are mapped to either black (0) or white (255). Threshold is the borderline value that determines a color as black or white. By adjusting the threshold level, you can sharpen text in a document or reduce show-through in newspapers.

This function is available when Color Mode is Black and White.

In ScanGear's Advanced Mode, click  (Threshold).

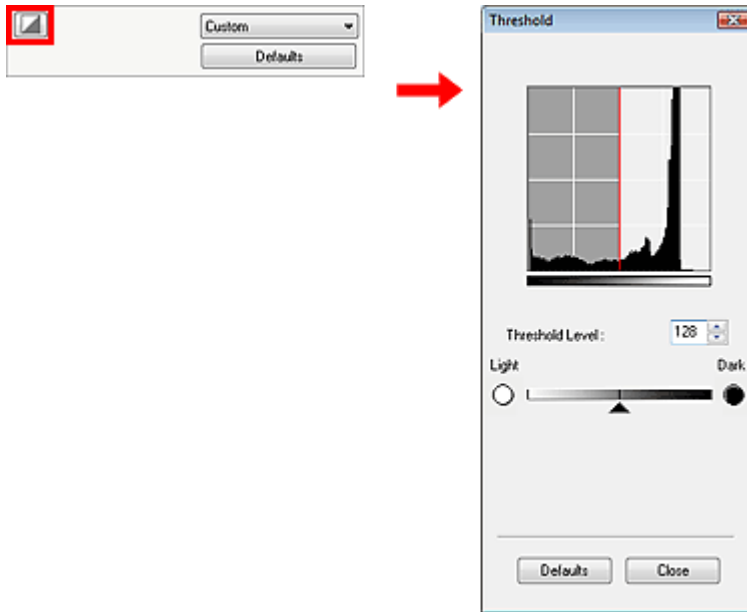

Adjusting Threshold

Move  (slider) to the right to increase the threshold value and thus increase the black areas. Move the slider to the left to decrease the value and thus increase the white areas. You can also enter a value (0 to 255).



Note

- Click Defaults to reset all adjustments in the current window.

[Top of Page](#)

Advanced Guide

[Advanced Guide](#) > [Scanning](#) > [Scanning with Other Application Software](#) > [ScanGear \(Scanner Driver\) Screens](#)

ScanGear (Scanner Driver) Screens

The following sections describe ScanGear's screens and functions, and how to use ScanGear (scanner driver).

- ➔ Basic Mode Tab
- ➔ Advanced Mode Tab
 - Input Settings
 - Output Settings
 - Image Settings
 - Color Adjustment Buttons
- ➔ Auto Scan Mode Tab
- ➔ Preferences Dialog Box
 - Scanner Tab
 - Preview Tab
 - Scan Tab
 - Color Settings Tab

[Top of Page](#)↑

Advanced Guide

Advanced Guide > Scanning > Scanning with Other Application Software > ScanGear (Scanner Driver) Screens > Basic Mode Tab

Basic Mode Tab

This mode allows you to scan easily by following the on-screen steps.

This section describes the settings and functions available in Basic Mode.

The displayed items vary by document type and how the screen was opened.

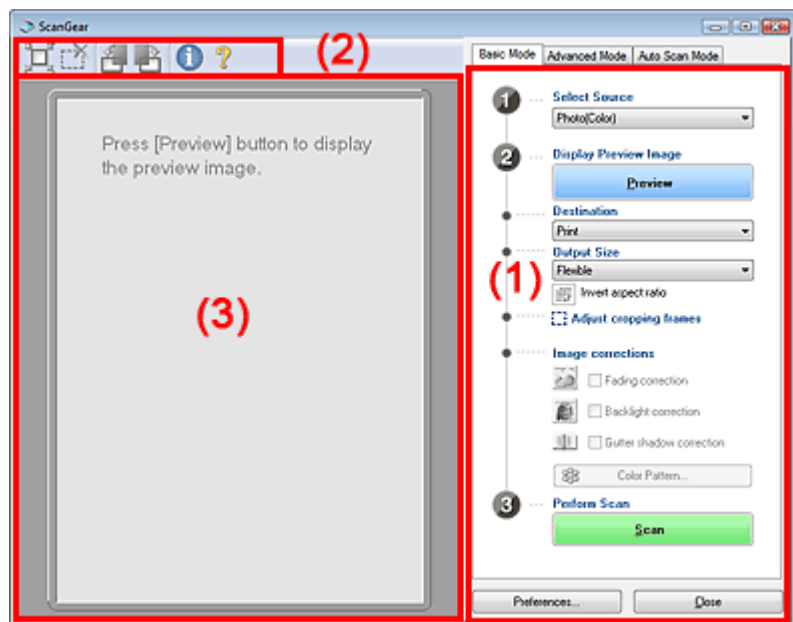

- (1) Settings and Operation Buttons
- (2) Toolbar
- (3) Preview Area

Settings and Operation Buttons

- **Select Source**
 - **Photo(Color)**
Scan color photos.
 - **Magazine(Color)**
Scan color magazines.
 - **Newspaper(Grayscale)**
Scan text and line drawings in black and white.
 - **Document(Grayscale)**
Scan photos and documents in black and white.
Select this mode to create high-resolution black and white images.

Note

- If you select an option other than Newspaper(Grayscale), the Unsharp Mask function will be active.
- If you select Photo(Color), Magazine(Color) or Document(Grayscale), the Auto Tone function will be active. However, if you disable Always Execute the Auto Tone on the Color Settings tab of the Preferences dialog box, the Auto Tone function will be disabled.
- If you select Magazine(Color), the Descreen function will be active.

- **Display Preview Image**

Click Preview to perform a trial scan. The scanned document appears in the Preview area. A cropping frame (scan area) is displayed according to the document size.

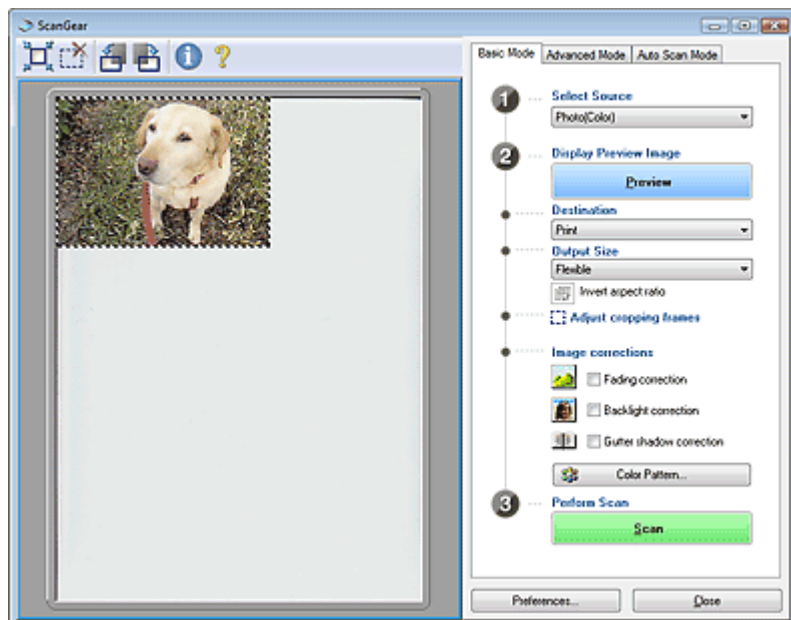

Note

- If you scan without preview, colors are adjusted based on the document type selected in Select Source.
- When using the machine for the first time, scanner calibration starts automatically. Wait a while until the preview image appears.

• Destination

Select what you want to do with the scanned image.

- **Print (300 dpi)**
Select this to print the scanned image on a printer.
- **Image display (150 dpi)**
Select this to view the scanned image on a monitor.
- **OCR (300 dpi)**
Select this to use the scanned image with OCR software.
OCR software is software that converts text scanned as an image into text data that can be edited in word processors and other programs.

Note

- To scan at 301 dpi or higher, scan in Advanced Mode after setting the Output Resolution. See "[Scanning in Advanced Mode](#)" to scan in Advanced Mode.

• Output Size

Select an output size.

Output size options vary by the item selected in Destination.

- **Flexible**
When a cropping frame is displayed, the portion within the cropping frame will be scanned at 100%. When no cropping frame is displayed, the entire Preview area will be scanned.
- **Paper Size (L, A4, etc.)**
Select an output paper size. The portion within the cropping frame will be scanned at the size of the selected paper size. You can drag the cropping frame to enlarge/reduce it while maintaining the aspect ratio.
- **Monitor Size (1024 x 768 pixels, etc.)**
Select an output size in pixels.
A cropping frame of the selected monitor size will be displayed and the portion within the cropping frame will be scanned. You can drag the cropping frame to enlarge/reduce it while maintaining the aspect ratio.
- **Add/Delete...**
Click to open the Add/Delete the Output Size dialog box, in which you can save custom output sizes. You can select this option when Destination is Print (300 dpi) or Image display (150 dpi).

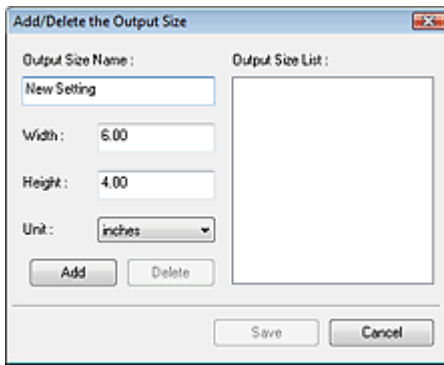

In the Add/Delete the Output Size dialog box, you can specify multiple output sizes and save them at one time. Saved items appear in the Output Size list along with the predefined items.

Add

To add a size, enter Output Size Name, Width and Height, then click Add. For Unit, you can select mm or inches when Destination is Print (300 dpi) but you can only select pixels when Destination is Image display (150 dpi). The name of the added size appears in Output Size List. Click Save to save the items listed in Output Size List.

Delete

To delete an item, select it in Output Size List and click Delete. Click Save to save the items listed in Output Size List.



Note

- Save up to 10 output sizes to Output Size List.
- You cannot delete predefined output sizes such as A4 and 1024 x 768 pixels.
- An error message appears when you enter a value outside the setting range. Enter a value within the setting range.



Note

- Whether or how the cropping frame is initially displayed on a preview image can be specified on the Preview tab of the Preferences dialog box. See Cropping Frame on Previewed Images in "Preview Tab."

● Invert aspect ratio

This button is available when Output Size is set to anything but Flexible.

Click this button to rotate the cropping frame. Click again to return it to the original orientation.

● Adjust cropping frames

You can adjust the scan area within the Preview area.

If an area is not specified, the document will be scanned at the document size (Auto Crop). If an area is specified, only the portion in the cropping frame will be scanned.

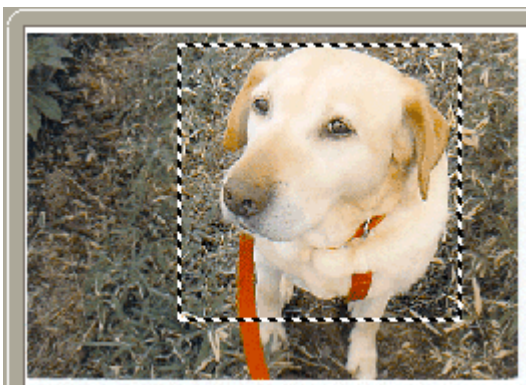

Note

- See "Adjusting Cropping Frames" for details on cropping frames.

● Image corrections

● Fading correction

Corrects and scans photos that have faded with time or have a colorcast.

● Backlight correction

Corrects photos that have been shot against light.

- **Gutter shadow correction**

Corrects shadows that appear between pages when scanning open booklets.

 **Important**

- For precautions on using this function, see Gutter Shadow Correction in " [Image Settings](#) " (Advanced Mode tab).

- **Color Pattern...**

Allows you to adjust the image's overall color. You can correct colors that have faded due to colorcast, etc. and reproduce natural colors while previewing color changes.

 **Note**

- See "[Adjusting Colors Using a Color Pattern](#)" for details.

- **Perform Scan**

Click Scan to start scanning.

 **Note**

- When scanning starts, the progress will be displayed. Click Cancel to cancel the scan.

- **Preferences...**

The Preferences dialog box opens and you can make scan/preview settings. See "[Preferences Dialog Box](#)" for details.

- **Close**

Click to close ScanGear (scanner driver).

Toolbar

- **Toolbar**

You can rotate preview images using the Toolbar.



-  **(Auto Crop)**

Displays and adjusts the cropping frame automatically to the size of the document displayed in the Preview area. The scan area is reduced every time you click this button if there are cropping area within the cropping frame.

-  **(Remove Cropping Frame)**

Removes the selected cropping frame.

-  **(Rotate Left)**

Rotates the preview image 90 degrees counter-clockwise.

- The result will be reflected in the scanned image.
- The image returns to its original state when you preview again.

-  **(Rotate Right)**

Rotates the preview image 90 degrees clockwise.

- The result will be reflected in the scanned image.
- The image returns to its original state when you preview again.

-  **(Information)**

Displays the version of ScanGear (scanner driver) and the current settings.

-  **(Open Guide)**

Click to open this guide.

Preview Area

- **Preview Area**

This is where a trial image is displayed after you click Preview.

You can specify the scan area (cropping frame) on the displayed image.

You can also create two or more cropping frames.

**Note**

- See "[Adjusting Cropping Frames](#)" for details on cropping frames.
-

Related Topic

- ▶ [Scanning in Basic Mode](#)

[Top of Page](#)↑

Advanced Guide

Advanced Guide > Scanning > Scanning with Other Application Software > ScanGear (Scanner Driver) Screens > Advanced Mode Tab

Advanced Mode Tab

This mode allows you to make advanced scan settings such as the color mode, resolution, image brightness and color tone.

This section describes the settings and functions available in Advanced Mode.

The displayed items vary by document type and how the screen was opened.

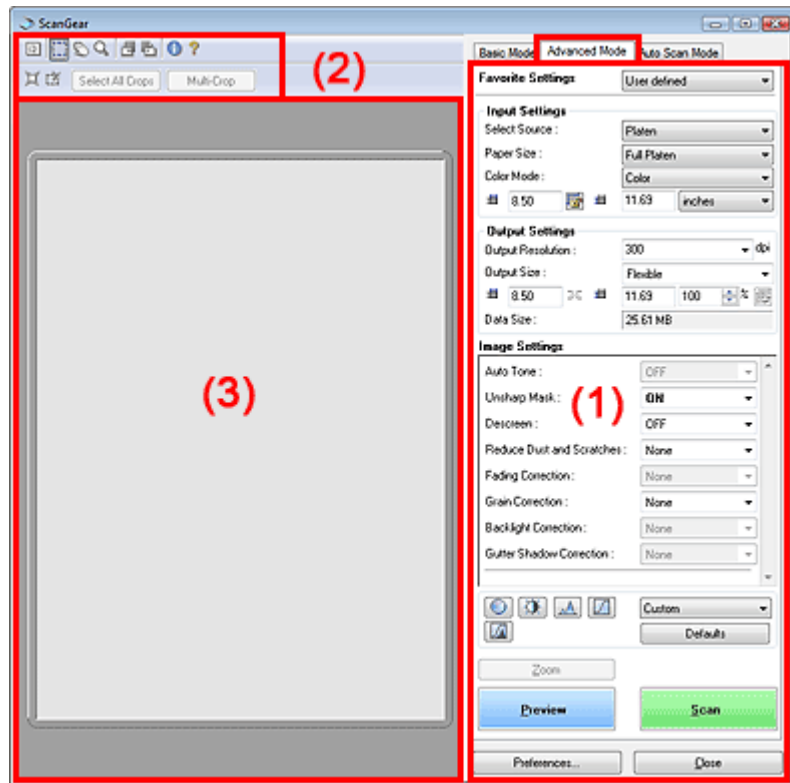

- (1) Settings and Operation Buttons
- (2) Toolbar
- (3) Preview Area

Settings and Operation Buttons

- **Favorite Settings**

You can name and save a group of settings (Input Settings, Output Settings, Image Settings and Color Adjustment Buttons), and load it as required. It is convenient to save a group of settings if you will be using it repeatedly. You can also use this to reload the default settings.

Select Add/Delete... from the pull-down menu and the Add/Delete Favorite Settings dialog box opens.

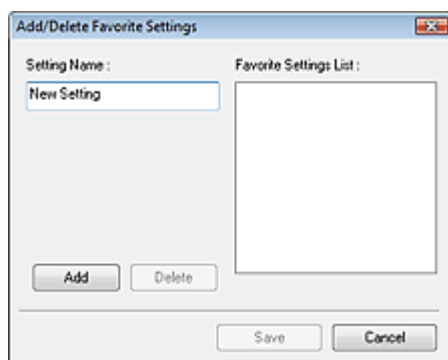

Enter Setting Name and click Add. The name appears in Favorite Settings List.

When you click Save, the item appears in the Favorite Settings list along with the predefined items.

Important

- You can set Add/Delete... in Favorite Settings after preview.

Note

- Save up to 10 items to Favorite Settings List. To delete an item, select it in Favorite Settings List and click Delete. Click Save to save settings displayed in Favorite Settings List.

• Input Settings

Specify the input settings such as the document type and size.

➔ [Input Settings](#)

• Output Settings

Specify the output settings such as the output resolution and size.

➔ [Output Settings](#)

• Image Settings

Enable/disable various image correction functions.

➔ [Image Settings](#)

• Color Adjustment Buttons

These buttons can be used to make fine corrections to the image brightness and color tones. You can adjust the image's overall brightness or contrast, and adjust its highlight and shadow values (histogram) or balance (tone curve).

➔ [Color Adjustment Buttons](#)

• Zoom

Rescans the portion within the cropping frame at higher magnification. When the image is zoomed in, Zoom changes to Undo. Click Undo to return the display to its non-magnified state.

Note

- Zoom rescans the image and displays high-resolution image in Preview.
-  (Zoom) on the Toolbar zooms in on the preview image quickly. However, the resolution of the displayed image will be low.

• Preview

Click to perform a trial scan.

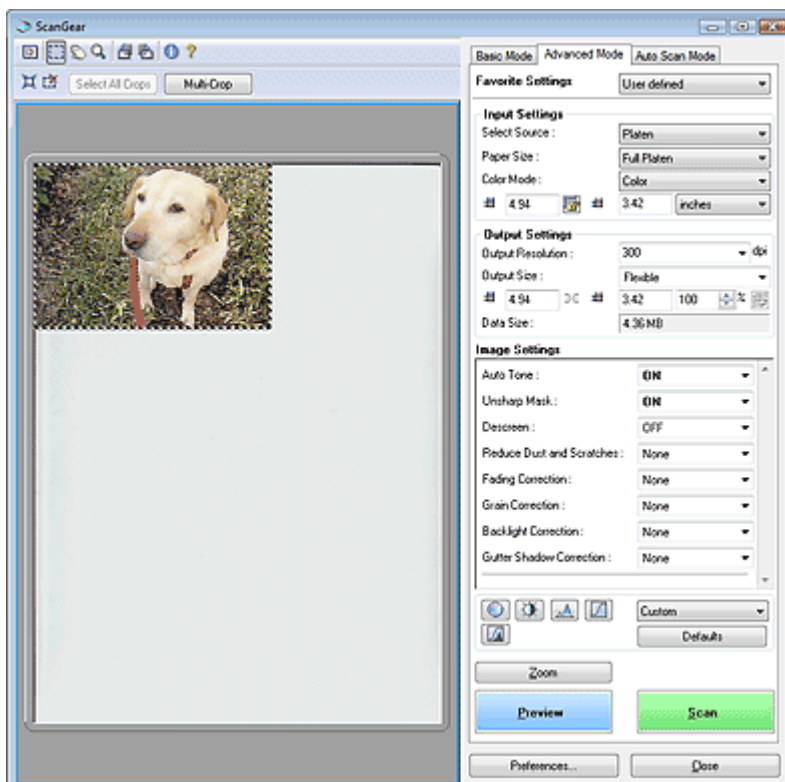

• Scan

Click to start scanning.

 **Note**

- When scanning starts, the progress will be displayed. Click Cancel to cancel the scan.
- When scanning is completed, a dialog box prompting you to select the next action may open. Follow the prompt to complete. For details, see Status of ScanGear dialog after scanning in "Scan Tab" (Preferences dialog box).
- If the total size of the images to be scanned exceeds 100 MB, a message appears warning you that scanning may take time. Click OK to continue, or Cancel to cancel the scan.

- **Preferences...**

The Preferences dialog box opens and you can make scan/preview settings. See "Preferences Dialog Box" for details.

- **Close**











Click to close ScanGear (scanner driver).

Toolbar

- **Toolbar**

With the Advanced Mode Toolbar, you can make adjustments to the preview image and also select a part of the displayed image.



-  **(Clear)**
Click this button to delete the preview image. It also resets the Toolbar and color adjustment settings.
-  **(Crop)**
Allows you to specify the scan area by dragging the mouse.
-  **(Move Image)**
If an enlarged image is too large to fit in the Preview area, you can click this button and drag the image across the screen until the part you want to see is displayed. You can also move the image using the scroll bars.
-  **(Zoom)**
Click this button then click on the image to enlarge it (zoom in). Right-click on the image to reduce it (zoom out).
-  **(Rotate Left)**
Rotates the preview image 90 degrees counter-clockwise.
 - The result will be reflected in the scanned image.
 - The image returns to its original state when you preview again.
-  **(Rotate Right)**
Rotates the preview image 90 degrees clockwise.
 - The result will be reflected in the scanned image.
 - The image returns to its original state when you preview again.
-  **(Information)**
Displays the version of ScanGear (scanner driver) and the current settings.
-  **(Open Guide)**
Click to open this guide.
-  **(Auto Crop)**
Displays and adjusts the cropping frame automatically to the size of the document displayed in the Preview area. The scan area is reduced every time you click this button if there are cropping area within the cropping frame.
-  **(Remove Cropping Frame)**
Removes the selected cropping frame.

- **Select All Crops**

This button is available when there are two or more cropping frames. All cropping frames will be displayed in thick broken lines. The settings will be applied to all the cropping frames.

- **Multi-Crop**

Automatically detects and crops multiple documents placed on the Platen. You can remove the cropping frames of the images you do not want to scan.

**Note**

- See "[Scanning Multiple Documents at One Time in Advanced Mode](#)" to scan multiple documents at one time.

Preview Area

- **Preview Area**

This is where a trial image is displayed after you click Preview. You can specify the scan area (cropping frame) on the displayed image. You can also create two or more cropping frames.

**Note**

- See "[Adjusting Cropping Frames](#)" for details on cropping frames.

Related Topic

- ▶ [Scanning in Advanced Mode](#)

[Top of Page](#)↑

Advanced Guide

Advanced Guide > Scanning > Scanning with Other Application Software > ScanGear (Scanner Driver) Screens > Input Settings

Input Settings

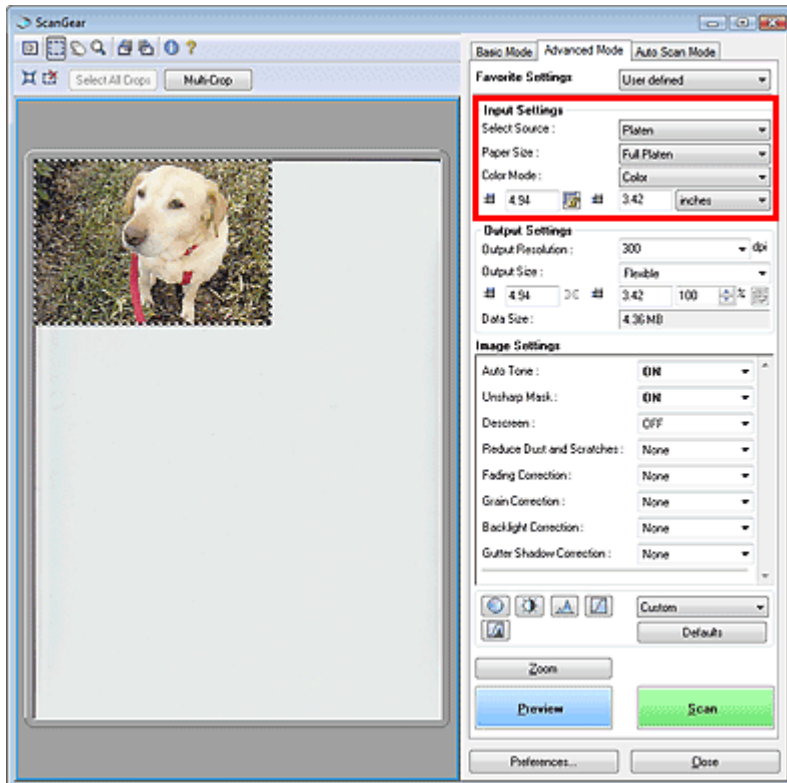

Input Settings allows you to set the following items:

- **Select Source**

The type of document to be scanned is displayed.

- **Paper Size**

Select the size of the document to be scanned.

When you select a size, the Preview area size changes accordingly.





Important

- Some applications have a limit to the amount of scan data they can receive. ScanGear (scanner driver) can scan data that is of:
 - 21000 pixels x 30000 pixels or less
- If you change Paper Size after previewing, the preview image will be deleted.



Note

- If you are not sure which size you should select for Paper Size, set Paper Size to Full Platen, then measure the size of the document and enter the values into  (Width) and  (Height).

- **Color Mode**

Select how to scan the document.

- **Color**

Select this mode to scan color documents or to create color images. This mode renders the image in 256 levels (8 bit) of R(ed), G(reen), and B(lue).

- **Grayscale**

Select this mode to scan black and white photos, or to create black and white images. This mode renders the image in 256 levels (8 bit) of black and white.



- **Black and White**



Select this mode to scan photos and other documents in black and white. This mode renders the image in black and white. The contrast in the image is divided at certain levels (threshold level)

into black and white and is rendered in two colors. The threshold level can be set with  (Threshold).

- **Input Size**

The Paper Size is displayed before preview. After preview, the cropping frame size is displayed.

You can adjust the cropping frame (scan area) size by entering the values into  (Width) and  (Height).

Click  (Keep Aspect Ratio) and change it to  (Locked) to maintain the aspect ratio when you specify the cropping frame size.

Important

- Input size settings are available only when Output Size in Output Settings is Flexible. If you select a size other than Flexible, a cropping frame calculated from Output Size and Output Resolution is displayed, and its aspect ratio is fixed.

Note

- The values you can enter will be within the range of the selected document size. The minimum size is 96 pixels x 96 pixels when Output Resolution is 600 dpi and Enlarge/Reduce is 100%.
- When Auto Crop is performed, the aspect ratio will not be maintained since the size will be prioritized.
- See "[Adjusting Cropping Frames](#)" for details on cropping frames.

[Top of Page](#) 

Advanced Guide

Advanced Guide > Scanning > Scanning with Other Application Software > ScanGear (Scanner Driver) Screens > Output Settings

Output Settings

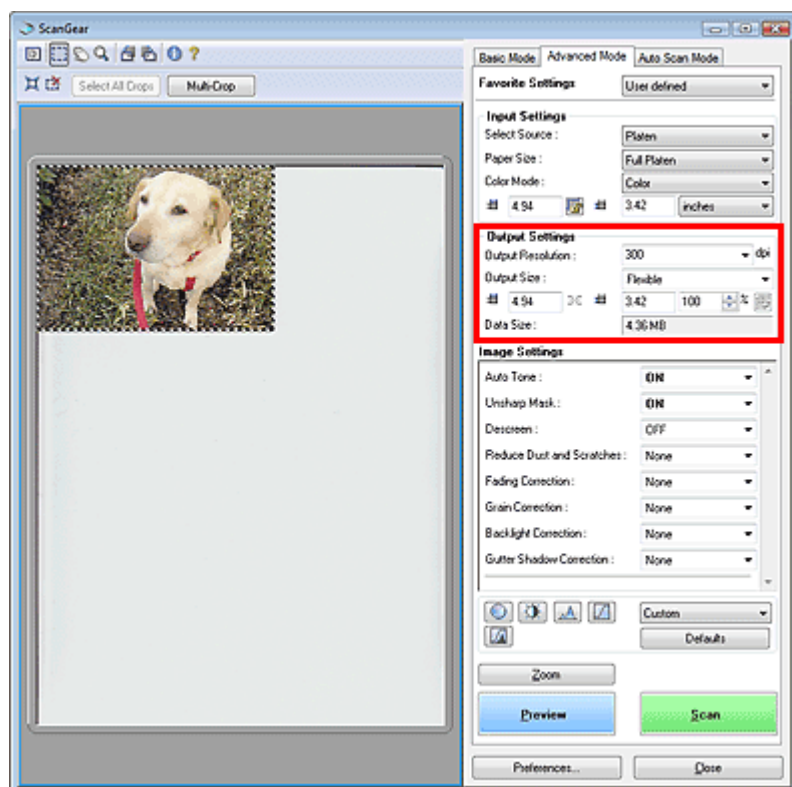

Output Settings allows you to set the following items:

- **Output Resolution**

Select the resolution to scan at.

The higher the resolution (value), the more detail in your image.

Select a resolution from the options displayed by clicking the button, or enter a value within the range of 25 dpi to 19200 dpi (in 1 dpi increments).

Note

- See "[Resolution](#)" for details.



- **Output Size**

Select an output size.

Select Flexible to set custom sizes or select a size for printing or displaying. Select Add/Delete... to set custom size and save it as a new output size option.

- **Flexible**

You can specify the output resolution and scale, and adjust the cropping frame. When no cropping frame is displayed, the entire Preview area will be scanned. When a cropping frame is displayed, the portion within the cropping frame will be scanned.

To enlarge/reduce the scanned image, enter values into  (Width) and  (Height) in Output Settings or specify a value (by 1%) for %. The maximum value available for % depends on the Output Resolution. % can be specified for up to 19200 dpi (the maximum available output resolution).

- **Paper Size (L, etc.) & Monitor Size (1024 x 768 pixels, etc.)**

Width, height and scale cannot be specified. The preview image will be cropped according to the selected output size and resolution. The portion within the cropping frame will be scanned at the size of the selected paper/monitor size. You can drag the cropping frame to enlarge, reduce or move it while maintaining the aspect ratio.

- **Add/Delete...**

Click to open the Add/Delete the Output Size dialog box, in which you can save/delete custom output sizes.

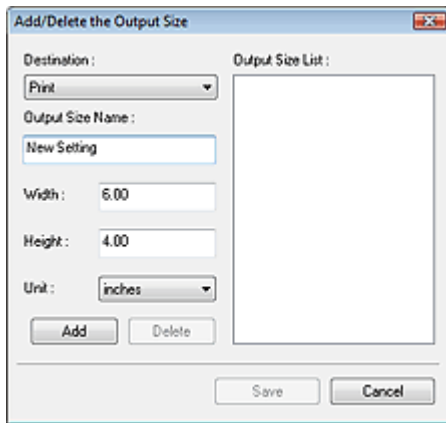

In the Add/Delete the Output Size dialog box, you can specify multiple output sizes and save them at one time. Saved items appear in the Output Size list along with the predefined items.

Add

To add a size, select Print or Image display for Destination, then enter Output Size Name, Width, and Height then click Add. The name of the added size appears in Output Size List. Click Save to save all the added items. Click Cancel to cancel all items that were added after you opened the Add/Delete the Output Size dialog box.

Delete

To delete an item, select it in Output Size List and click Delete. The deleted items will disappear from Output Size List.

When you click Save, the items that disappeared from Output Size List will be deleted. When you click Cancel, they will not be deleted.



Important

- You cannot delete predefined output sizes such as A4 and 1024 x 768 pixels.



Note

- Save up to 10 output sizes to Output Size List for each destination.
- An error message appears when you enter a value outside the setting range. Enter a value within the range displayed in the message.
- Unit varies by Destination. For Print, select mm or inches. For Image display, the unit is pixels.



Note

- See "[Adjusting Cropping Frames](#)" for details on cropping frames.
- Whether or how the cropping frame is initially displayed on a preview image can be specified on the Preview tab of the Preferences dialog box. See [Cropping Frame on Previewed Images in "Preview Tab."](#)

• (Switch Aspect Ratio)

Rotate the cropping frame 90 degrees. Click again to return it to the original orientation.

• Data Size

An image file is created when the preview image is scanned. Its size when saved in BMP format is displayed.

When the file size is 100 MB or more, the value appears in red. In that case, a warning message appears when you click Scan.

[Top of Page](#)↑

Advanced Guide

Advanced Guide > Scanning > Scanning with Other Application Software > ScanGear (Scanner Driver) Screens > Image Settings

Image Settings

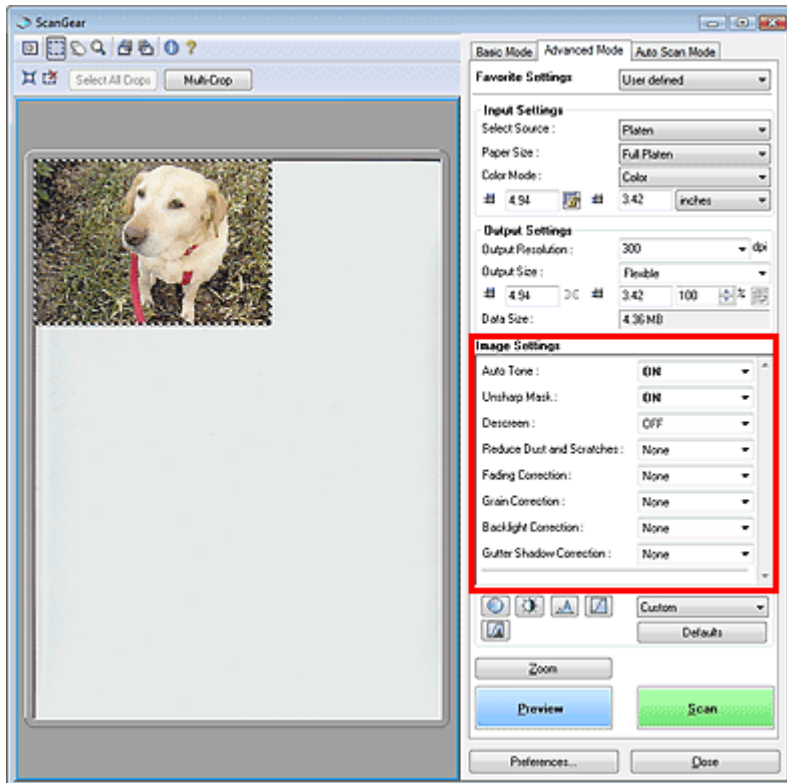

Important

- Do not apply these functions to images without moire, dust/scratches or faded colors. The color tone may be adversely affected.
- Selectable settings depend on color mode settings.
- Scanning may take longer when you use Image Settings.

Image Settings allows you to set the following items:

• Auto Tone

When this is set to ON, the brightness of the specified portion of the image is automatically optimized. The result of the color adjustment will be reflected in the entire image. This setting is ON by default.

Important

- You can set Auto Tone after preview.
- You can set this setting when Recommended is selected on the Color Settings tab of the Preferences dialog box.
- When you click Multi-Crop, this setting turns to ON and you cannot change it.

Note

- When previewing or scanning images with consistent color tone (such as the sky), the color tone may change from the source image due to the Auto Tone function. In that case, set Auto Tone to OFF.

• Unsharp Mask

When this is set to ON, the outline of the subjects is emphasized to sharpen the image. This setting is ON by default.

• Descreen

Printed photos and pictures are displayed as a collection of fine dots. Moire is a phenomenon where dots may interfere with each other and cause uneven gradation and a stripe pattern in the image. Descreen is the function for reducing this moire effect. This setting is OFF by default.

Note

- Even if Descreen is set to ON, some moire effects may remain if Unsharp Mask is set to ON. In that case, set Unsharp Mask to OFF.
- Selecting Magazine(Color) in Select Source in Basic Mode has the same effect as setting Descreen to ON in Advanced Mode.

• Reduce Dust and Scratches

Scanned photos may contain white dots caused by dust or scratches. Use this function to reduce such noise. This setting is OFF by default.

- **OFF**

Dust and scratches will not be reduced.

- **Low**

Select this to reduce small dust particles and scratches. Large ones may remain.

- **Medium**

It is recommended that you normally select this setting.

- **High**

Select this to reduce small/large dust particles and scratches. Evidence of the reduction process may remain and may also remove delicate parts of the image.



Important

- This function may not be effective for some types of photos.



Note

- It is recommended that you select OFF when scanning printed materials.

• Fading Correction

Use this function to correct photos that have faded with time or have a colorcast. Colorcast is a phenomenon where a specific color affects the entire picture due to the weather or ambient strong colors. This setting is OFF by default.

- **OFF**

Fading correction will not be applied.

- **Low**

Select this to correct a small amount of fading and colorcast.

- **Medium**

It is recommended that you normally select this setting.

- **High**

Select this to correct a large amount of fading and colorcast. This can affect the tone of the image.



Important

- You can set Fading Correction after preview.
- Fading Correction may not be effective if the scan area is too small.
- You can set this setting when Recommended is selected on the Color Settings tab of the Preferences dialog box.
- When you click Multi-Crop, this setting turns to OFF and you cannot change it.

• Grain Correction

Use this function to reduce graininess (roughness) in photos taken with high-speed or sensitized film. This setting is OFF by default.

- **OFF**

Graininess will not be reduced.

- **Low**

Select this when the photo is slightly grainy.

- **Medium**

It is recommended that you normally select this setting.

- **High**

Select this when the photo is very grainy. This can affect the gradation and sharpness of the

image.



Important

- Grain Correction may not be effective if the scan area is too small.
- The result will not be reflected in the preview image.

● Backlight Correction

Use this function to correct photos that have been shot against light.

When you change the Backlight Correction setting, the result will be reflected in the preview image.

● OFF

Backlight correction will not be applied.

● Low

Select this to correct slightly backlit photos. This will not affect the image contrast.

● Medium

It is recommended that you normally select this setting.

● High

Select this to correct strongly backlit photos. This can affect the image contrast.



Important

- You can set Backlight Correction after preview.
- You can set this setting when Recommended is selected on the Color Settings tab of the Preferences dialog box.
- Backlight Correction may not be effective if the scan area is too small.
- When you click Multi-Crop, you cannot change this setting.



Note

- Noise patterns may appear when Backlight Correction is applied. Applying Grain Correction and setting Unsharp Mask to OFF may reduce the noise patterns.

● Gutter Shadow Correction

Use this function to correct shadows that appear between pages when scanning open booklets.

When you set the Gutter Shadow Correction setting in the preview image, the result will be reflected.

Preview the effects before scanning, as results vary depending on the type of document and how it is pressed.

Unclear or blurred text/lines caused by curved pages are not corrected.

● OFF

Gutter shadow will not be corrected.

● Low

Select this when the effect level is too strong with the medium setting.

● Medium

It is recommended that you normally select this setting.

● High

Select this when the effect level is too weak with the medium setting.



Important

- Do not place items that weigh 4.4 lbs (2.0 kg) or more on the Platen. Also, do not press on the document with a force exceeding 4.4 lbs (2.0 kg). If you press heavily, the scanner may not work correctly or you might break the glass.
- When you click Multi-Crop, this setting is not available. Click Reset then change the setting.
- Align the document with the edge of the Platen. If not, the shadow will not be corrected properly.



- Shadows may not be corrected properly depending on the document. If the page background is not white, shadows may not be detected correctly or may not be detected at all.
- While scanning, press down on the spine with the same amount of pressure you used to preview the scan. If the binding part is not even, the shadow will not be corrected properly.



How to place the document depends on your model and the document to be scanned.

Note

- Cover the document with black cloth if white spots, streaks, or colored patterns appear in scan results due to ambient light entering between the document and the Platen.
- If the shadow is not corrected properly, adjust the cropping frame on the preview image.
➔ [Adjusting Cropping Frames](#)

[Top of Page](#)↑

Advanced Guide

Advanced Guide > Scanning > Scanning with Other Application Software > ScanGear (Scanner Driver) Screens > Color Adjustment Buttons

Color Adjustment Buttons

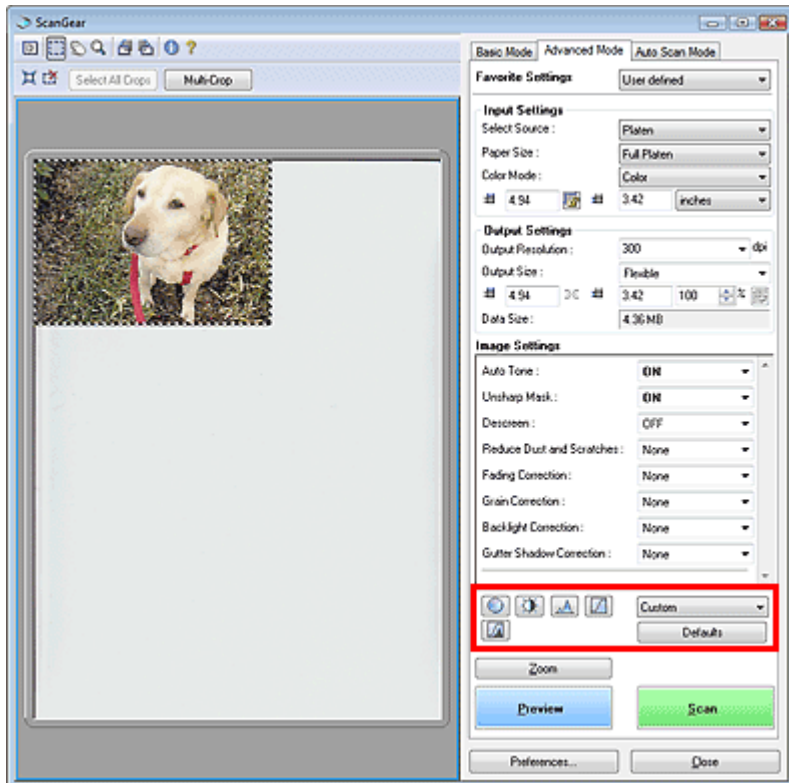

The Color Adjustment Buttons allow you to make fine corrections to the image brightness and color tones. You can adjust the image's overall brightness or contrast, and adjust its highlight and shadow values (histogram) or balance (tone curve).

Important

- The Color Adjustment Buttons are not available when you apply Multi-Crop or when you select Color Matching on the Color Settings tab of the Preferences dialog box.
- Selectable settings depend on color mode settings.

Note

- When you adjust the image via the Color Adjustment Buttons, the results will be reflected in the preview image.

Click a Color Adjustment Button to set the following items:

(Saturation/Color Balance)

Adjust the vividness and color tone of the image. Use this function to brighten colors that have faded with time or due to colorcast. Colorcast is a phenomenon where a specific color affects the entire picture due to the weather or ambient strong colors.

➔ [Adjusting Saturation and Color Balance](#)

(Brightness/Contrast)

Adjust the brightness and contrast of the image. If the image is too dark or too bright, or if the image quality is flat due to lack of contrast, you can adjust the levels of brightness and contrast.

➔ [Adjusting Brightness and Contrast](#)

(Histogram)

A histogram allows you to see the data concentration at each brightness level of an image. You can specify the darkest level (shadow) and brightest level (highlight) within an image, cut the levels and expand the middle of the tonal range of the image.

➔ [Adjusting Histogram](#)

(Tone Curve Settings)

Adjust the brightness of an image by selecting the type of graph (tone curve) showing the balance of tone input and output. You can make fine adjustments to the brightness of a specific area.

➔ [Adjusting Tone Curve](#)



(Final Review)

Make a final check of color adjustments. The final synthesized tone curve and the histogram derived from the subsequent image processing will be displayed. There are no settings to make in this screen.

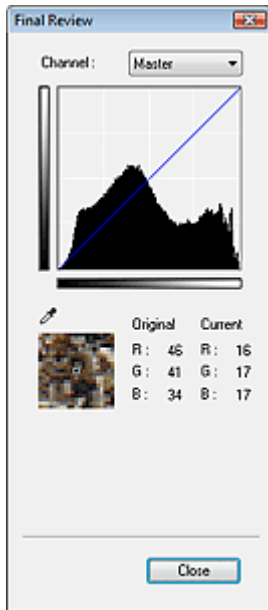

- For a color image, select a color in Channel to check either Red, Green or Blue, or select Master to check three colors together.
- If you place the cursor on the preview image, the portion will be enlarged and its RGB values (only K when Color Mode is Grayscale) before and after the adjustments will be displayed.



(Threshold)

Set the boundary (threshold) at which black and white are divided. By adjusting the threshold level, you can sharpen text in a document or reduce show-through in newspapers.

➔ [Setting Threshold](#)

• Custom

You can name and save a set of tone curve and threshold settings created with the Color Adjustment Buttons.

Select Add/Delete... from the pull-down menu. When Color Mode is set to anything but Black and White, the Add/Delete Tone Curve Settings dialog box opens. When Color Mode is Black and White, the Add/Delete Threshold Settings dialog box opens.

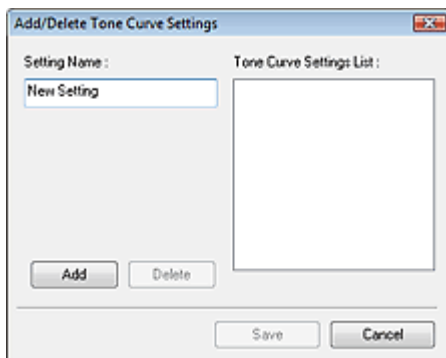

Enter Setting Name and click Add. The name appears in Tone Curve Settings List or Threshold Settings List.

Click Save to save.

You can load and apply the saved tone curve/threshold settings to a preview image. To load the settings, select the saved item from the pull-down menu.

To delete an item, select it in Tone Curve Settings List or Threshold Settings List and click Delete.



Note

- Save up to 20 items.
-

- **Defaults**

Reset all adjustments (saturation/color balance, brightness/contrast, histogram and tone curve).

[Top of Page](#)↑

Advanced Guide

Advanced Guide > Scanning > Scanning with Other Application Software > ScanGear (Scanner Driver) Screens > Auto Scan Mode Tab

Auto Scan Mode Tab

This mode allows you to scan easily by simply placing documents on the Platen and clicking a button.

In Auto Scan Mode, documents are automatically detected. You do not need to specify cropping frames or make image corrections.



- **Supported Documents**

Photos, Hagaki, business cards, magazines, newspapers, text documents and CD/DVD.



Important

- The following types of documents cannot be scanned correctly. In that case, specify the document type on the Basic Mode tab or the Advanced Mode tab and scan again.
 - Documents other than photos, Hagaki, business cards, magazines, newspapers, text documents and CD/DVD.
 - Text documents smaller than 2L (5 inches x 7 inches) (127 mm x 178 mm), such as paperback pages with the spine cut off.
 - Documents printed on thin white paper.
 - Wide documents such as panoramic photos.
- ➔ [Scanning in Basic Mode](#)
- ➔ [Scanning in Advanced Mode](#)
- Place documents correctly according to the type of document to be scanned. Otherwise, documents may not be scanned correctly. See "[Placing Documents](#)" for details on how to place documents.
- Scan from the [Basic Mode tab](#) or [Advanced Mode tab](#) to reduce moire.

- **How to set documents** 

[Placing Documents](#) appears.

- **View scanned images**

Select this checkbox to display the thumbnails of scanned images in a different window.

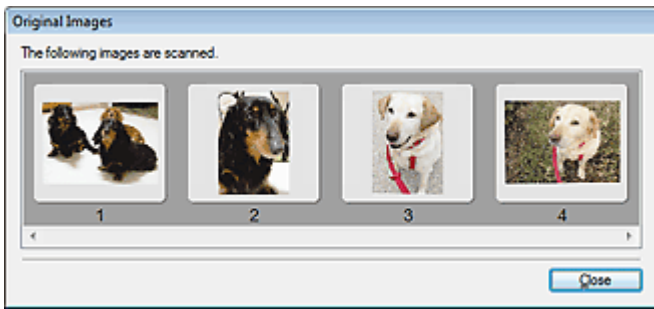

- **Scan**

Scanning starts.

**Note**

- When scanning starts, the progress will be displayed. Click Cancel to cancel the scan.
- When scanning is completed, a dialog box prompting you to select the next action may open. Follow the prompt to complete. For details, see Status of ScanGear dialog after scanning in "[Scan Tab](#)" (Preferences dialog box).

- **Instructions** 

This page appears.

- **Preferences...**

The Preferences dialog box opens and you can make scan/preview settings.

[➔ Preferences Dialog Box](#)

- **Close**

Click to close ScanGear (scanner driver).

Related Topic

[▶ Scanning in Auto Scan Mode](#)

[Top of Page](#) 

Advanced Guide

Advanced Guide > Scanning > Scanning with Other Application Software > ScanGear (Scanner Driver) Screens > Preferences Dialog Box

Preferences Dialog Box

Click Specify... in the ScanGear (scanner driver) screen to open Preferences dialog box.

In the Preferences dialog box, you can make advanced settings to ScanGear (scanner driver) functions via the Scanner, Preview, Scan and Color Settings tabs.

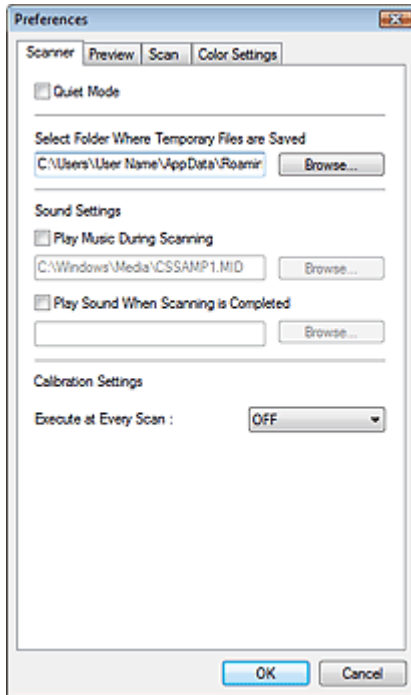

Scanner Tab

Allows you to specify a folder to save images temporarily and a music file to play during or at the end of a scan.

➡ [Scanner Tab](#)

Preview Tab

Allows you to select what to do with Preview when ScanGear (scanner driver) is started and how to display cropping frames after previewing images.

➡ [Preview Tab](#)

Scan Tab

Allows you to select what to do with ScanGear (scanner driver) after scanning images.

➡ [Scan Tab](#)

Color Settings Tab

Allows you to select how to adjust color, enable/disable Auto Tone, and specify the monitor gamma value.

➡ [Color Settings Tab](#)

[Top of Page](#)↑

Advanced Guide

Advanced Guide > Scanning > Scanning with Other Application Software > ScanGear (Scanner Driver) Screens > Scanner Tab

Scanner Tab

On the Scanner tab, you can specify the following settings.

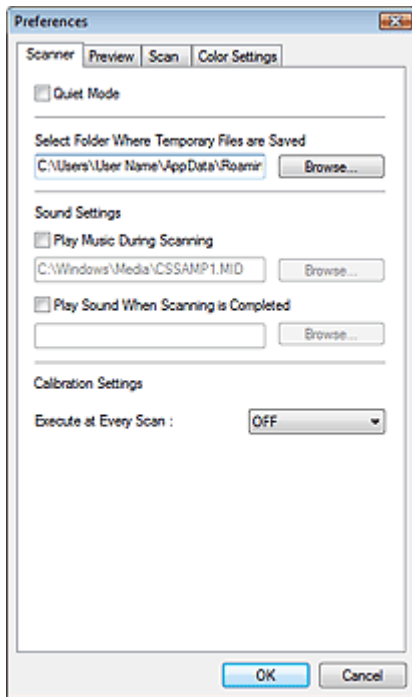

- **Quiet Mode**

Select this checkbox to reduce scanner sound by slowing down the scanner head when previewing or scanning documents. This checkbox is not selected by default.

Note

- Scanning takes longer than usual when you enable this function.

- **Select Folder Where Temporary Files are Saved**

Displays the folder in which to save images temporarily. To change the folder, click Browse... to specify another one.

- **Sound Settings**

You can set the machine to play music during/at the end of a scan.

Select the Play Music During Scanning or Play Sound When Scanning is Completed checkbox, then click Browse... and specify a sound file.

You can specify the following files.

MIDI file (*.mid, *.rmi, *.midi)

Audio file (*.wav, *.aif, *.aiff)

MP3 file (*.mp3)

- **Calibration Settings**

When you set Execute at Every Scan to ON, the scanner will be calibrated every time before previewing and scanning, to reproduce correct color tones in scanned images.

Note

- Even when Execute at Every Scan is set to OFF, the scanner may be calibrated automatically in some cases (such as immediately after you turn the machine on).

[Top of Page](#) 

Advanced Guide

Advanced Guide > Scanning > Scanning with Other Application Software > ScanGear (Scanner Driver) Screens > PreviewTab

Preview Tab

On the Preview tab, you can specify the following settings.

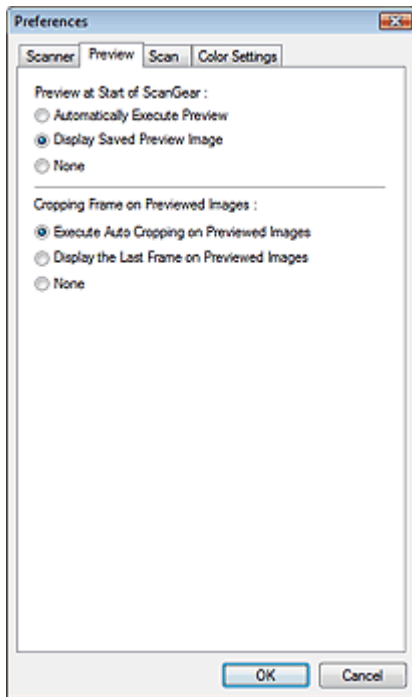

- **Preview at Start of ScanGear**

Select what to do with Preview when ScanGear (scanner driver) is started. Display Saved Preview Image is selected by default.

- **Automatically Execute Preview**

ScanGear (scanner driver) will automatically start previewing at startup.

- **Display Saved Preview Image**

The previously previewed image will be displayed.

The Color Adjustment Button settings, the Toolbar settings, and the Advanced Mode settings are also saved.

- **None**

No preview image will be displayed at startup.

- **Cropping Frame on Previewed Images**

Select how to display cropping frames after previewing images. Execute Auto Cropping on Previewed Images is selected by default.

- **Execute Auto Cropping on Previewed Images**

The cropping frame will automatically be displayed in the document size after previewing.

- **Display the Last Frame on Previewed Images**

A cropping frame of the same size as the last used cropping frame will be displayed after previewing.

- **None**

No cropping frame will be displayed after previewing.

[Top of Page](#)↑

Advanced Guide

Advanced Guide > Scanning > Scanning with Other Application Software > ScanGear (Scanner Driver) Screens > Scan Tab

Scan Tab

On the Scan tab, you can specify the following settings.

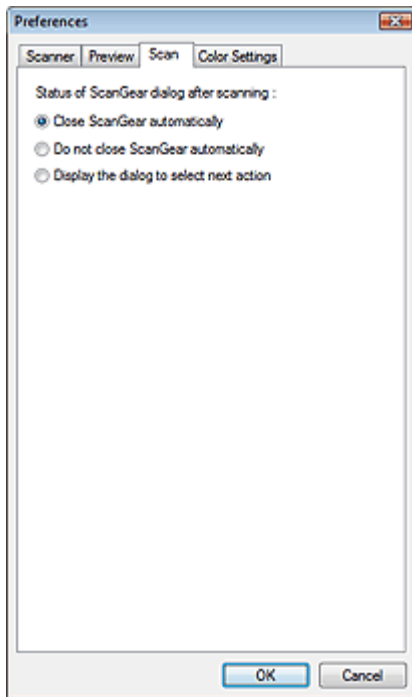

- **Status of ScanGear dialog after scanning**

Select what to do with ScanGear (scanner driver) after scanning images. Close ScanGear automatically is selected by default.

- **Close ScanGear automatically**

Select this to return to the original application when scanning is completed.

- **Do not close ScanGear automatically**

Select this to return to the ScanGear (scanner driver) screen for another scan when scanning is completed.

- **Display the dialog to select next action**

Select this to open a dialog box and select what to do when scanning is completed.

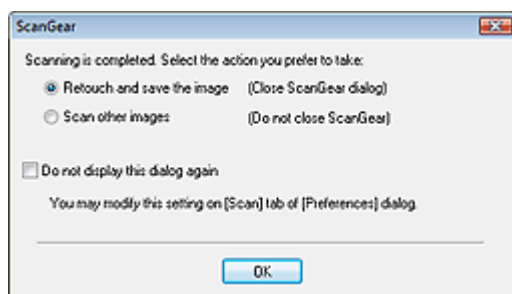

Note

- Even if Do not close ScanGear automatically or Display the dialog to select next action is set, some applications may not support it.

[Top of Page](#) ↑

Advanced Guide

Advanced Guide > Scanning > Scanning with Other Application Software > ScanGear (Scanner Driver) Screens > Color Settings Tab

Color Settings Tab

On the Color Settings tab, you can specify the following settings.

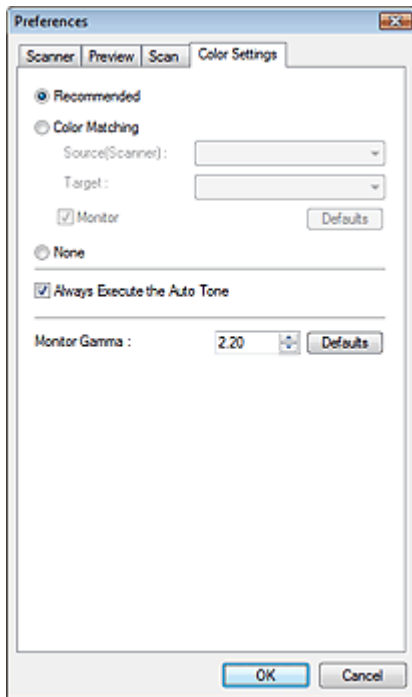

• Color Adjustment

Select either of the following. Recommended is selected by default. This function is available when Color Mode is Color or Grayscale.

• Recommended

Select this to vividly reproduce the tone of a document on the screen. It is recommended that you normally select this setting.

• Color Matching

Select this to automatically match the scanner, monitor and color printer colors, thus reducing time and trouble to manually match the monitor and printer colors.

Color Adjustment Buttons will be disabled.

This function is available when Color Mode is Color.

- Source(Scanner): Select scanner profile.
- Target: Select target profile.
- Monitor: Select this to display preview image with optimum correction for monitor.
- Defaults: Returns to the default Color Matching settings.

• None

Select this to disable color correction provided by ScanGear (scanner driver).



Note

- Color Matching is available when ScanGear (scanner driver), monitor, color management-compliant application (such as Photoshop) and printer are set up correctly. Refer to the corresponding manual for the monitor, printer and application settings.

• Always Execute the Auto Tone

Select this checkbox to always apply Auto Tone to scanned images. This checkbox is selected by default.



Important

- This function is available when Color Mode is Color or Grayscale.
- You cannot select this setting when None is selected on the Color Settings tab.

**Note**

-
- When previewing or scanning images with plain backgrounds, the color tone may change from the source image due to the Auto Tone function. In that case, deselect the Always Execute the Auto Tone checkbox.
-

● Monitor Gamma

By setting the gamma value of a monitor (display), you can adjust the input data to the brightness characteristics of the monitor. Adjust the value if your monitor's gamma value does not match the default value set in ScanGear (scanner driver), and the colors of the original image are not accurately reflected in the monitor.

Click Defaults to return to the default Monitor Gamma value (2.20).

**Note**

-
- Refer to the manual of your monitor to check its gamma value. If it is not written in the manual, contact the manufacturer.
-

[Top of Page](#)↑

Advanced Guide

[Advanced Guide](#) > [Scanning](#) > [Scanning with Other Application Software](#) > [Appendix: Useful Information on Scanning](#)

Appendix: Useful Information on Scanning

- **Adjusting the cropping frame (scan area)**
 - ➔ [Adjusting Cropping Frames](#)
- **Selecting the best resolution**
 - ➔ [Resolution](#)
- **Learning about file formats**
 - ➔ [File Formats](#)
- **Learning about Color Matching**
 - ➔ [Color Matching](#)
- **Matching the colors between the document and monitor**

See Monitor Gamma in the following section.

 - ➔ [Color Settings Tab](#)

[Top of Page](#)↑

Advanced Guide

Advanced Guide > Scanning > Scanning with Other Application Software > Appendix: Useful Information on Scanning > Adjusting Cropping Frames

Adjusting Cropping Frames

You can specify the scan area by creating a cropping frame on the image displayed in the Preview area. When you click Scan, only the portion within the cropping frame will be scanned and passed to the application.

You can create two or more cropping frames. When you click Scan, all cropping frames will be scanned. (Scan is repeated for each cropping frame.)

Important

- You cannot create additional cropping frames when you used Multi-Crop in ScanGear's Advanced Mode.

Cropping frame types



(1) Focus Cropping Frame (rotating thick broken lines)

The settings in Basic Mode or Advanced Mode will be applied.

(2) Selected Cropping Frame (stationary thick broken lines)

The settings will be applied to the Focus Cropping Frame and Selected Cropping Frames simultaneously. You can select multiple cropping frames by clicking them while pressing the Ctrl key.

(3) Unselected Cropping Frame (stationary thin broken lines)

The settings will not be applied.



Initial cropping frame

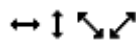

A cropping frame (Focus Cropping Frame) is displayed automatically around the preview image according to the document size. You can also create a cropping frame by dragging the mouse in the Preview area.

Adjusting a cropping frame

The cursor will change into  when it is positioned over a cropping frame. If you click and drag the mouse in the direction of the arrow, the cropping frame will expand or contract accordingly.

The cursor will change into  when it is positioned within a cropping frame. Click and drag the mouse to move the entire cropping frame.

You can rotate a cropping frame 90 degrees by clicking  (Switch Aspect Ratio). However,  (Switch Aspect Ratio) is not available when Output Size is Flexible.

In Advanced Mode, you can specify the cropping frame size by entering the values into  (Width) and  (Height) in Input Settings.

Note

- Cropping frames are set according to the document size (Auto Crop) by default. For details, see Cropping Frame on Previewed Images in " [Preview Tab](#)" (Preferences dialog box).

Creating multiple cropping frames

Click and drag the mouse in a space outside the existing cropping frame to create a new cropping frame in the Preview area. The new cropping frame will be the Focus Cropping Frame, and the old cropping frame will be the Unselected Cropping Frame.

You can create multiple cropping frames and apply different scan settings to each cropping frame.

You can select multiple cropping frames by clicking them while pressing the Ctrl key.

If you select multiple cropping frames and change the settings on a tab at the right of ScanGear (scanner driver), the settings will be applied to all the selected cropping frames.

When you create a new cropping frame, it retains the settings of the latest cropping frame.

Note

- Create up to 10 cropping frames.
- Scanning takes longer than usual when multiple cropping frames are selected.

Deleting cropping frames

To delete a cropping frame, select it and click  (Remove Cropping Frame) on the Toolbar. Alternatively, press the Delete key.

When there are multiple cropping frames, all the selected cropping frames (Focus Cropping Frame and Selected Cropping Frames) are deleted simultaneously.

[Top of Page](#)↑

Advanced Guide

Advanced Guide > Scanning > Scanning with Other Application Software > Appendix: Useful Information on Scanning > Resolution

Resolution

What is Resolution?

The data in the image you have scanned is a collection of dots carrying information about brightness and color. The density of these dots is called "resolution", and resolution will determine the amount of detail your image contains. The unit of resolution is dots per inch (dpi). Dpi is the number of dots per square inch (2.54 cm square).

The higher the resolution (value), the more detail in your image; the lower the resolution (value), the less detail.



Setting the Resolution in MP Navigator EX

In MP Navigator EX, you can specify the resolution with Scanning Resolution in the Scan Settings dialog box.

Images for Printing

Images to be printed should be scanned at a resolution that corresponds to the resolution of the printer.



For example, if you want to print using a 600 dpi black and white printer, you should set the resolution to 600dpi.

With a color printer, specifying the resolution at half the resolution of the printer should be fine. For example, if you want to print scanned paper/photos using a 600 dpi color printer, you should set the resolution to 300dpi. However, with a high-resolution printer, printing takes longer than usual if you set the resolution to half the resolution of the printer.

Example of Appropriate Resolution when Printing to Scale

If you print a document at twice the size both vertically and horizontally, the resolution of the document will be reduced by half. If the resolution of the original document is 300 dpi, the resolution of the enlarged document will be 150 dpi. If you print the document with a 600 dpi color printer, the lack of detail in the image may be obvious. In that case, if you scan at the Scanning Resolution of 600 dpi, the resolution will be 300 dpi even if you double the size of document and you can print the document with sufficient quality. Conversely, if you print a document at half scale, it should be sufficient to scan at half the resolution.

When Printing Color Photos at Twice the Size

		
<p>Document resolution: 300 dpi Scanning resolution: 600 dpi Scale: 200%</p>	<p>Print at twice the size Scanning resolution/actual scanning resolution: 600 dpi</p>	<p>Printing resolution: 300 dpi</p>



Setting the Resolution in ScanGear (Scanner Driver)

In ScanGear, you can specify the resolution with Output Resolution in Output Settings on the Advanced Mode tab.

Example of Appropriate Resolution when Printing to Scale

The scanning resolution is automatically set so that the value set in Output Resolution will be the resolution of the scanned image. If you set Output Resolution to 300 dpi and scan at twice the size, the document will be automatically scanned at 600 dpi, and the resolution of the scanned image will be 300 dpi. You can print the document with sufficient quality using a 600 dpi color printer.

When Printing L Size (8.9 cm x 12.7 cm) Photos at Twice the Size

		
Document resolution: 300 dpi Output resolution: 300 dpi Scale: 200%	Scan at twice the size Actual scanning resolution: 600 dpi	Image resolution/printing resolution: 300 dpi

Appropriate Resolution Settings

Set the resolution according to the use of the scanned image.

For displaying on a monitor: 150 dpi

For printing: 300 dpi

When Output Size is set to Flexible in ScanGear's Advanced Mode (Select Source is Platen and the scale is 100%):

Document	Use	Color Mode	Output Resolution
Color photo	Copying (Printing)	Color	300 dpi
	Creating a postcard	Color	300 dpi
	Saving to a computer	Color	75 dpi - 300 dpi
	Using on a website or attaching to e-mail	Color	75 dpi - 150 dpi
Black and white photo	Saving to a computer	Grayscale	75 dpi - 300 dpi
	Using on a website or attaching to e-mail	Grayscale	75 dpi - 300 dpi
Text document	Copying	Color, Grayscale or Black and White	300 dpi
	Attaching to e-mail	Color, Grayscale or Black and White	300 dpi



Note

- Although you can change Output Resolution in ScanGear (scanner driver), it is recommended that you scan at the default value.
- If you double the resolution, the file size quadruples. If the file is too large, the processing speed will slow down significantly, and you will experience inconvenience such as lack of memory. Set the minimum required resolution according to the use of the image.

[Top of Page](#) ↑

Advanced Guide

Advanced Guide > Scanning > Scanning with Other Application Software > Appendix: Useful Information on Scanning > File Formats

File Formats

You can select a file format when saving scanned images. You should specify the most suitable format according to how you want to use the image on which application.

Available file formats vary by application and computer (Windows or Macintosh).

See below for the characteristics of each image file format.

BMP (Standard File Extension: .bmp)

A standard file format for Windows.

BMP is often selected for images that are used only on Windows.

JPEG (Standard File Extension: .jpg)

A file format often used on websites and for digital camera images.

JPEG features high compression rates. JPEG images slightly degrade every time they are saved, and cannot be returned to their original state.

JPEG is not available for black and white images.

Exif (Standard File Extension: .jpeg)

A file format supported by many digital cameras.

It adds information such as the date of image capture, camera model, shutter speed, shooting mode and comments to JPEG files.

The file format version must be Exif 2.2 or later in order to print on a Direct Print compatible printer.

TIFF (Standard File Extension: .tif)

A file format featuring a relatively high compatibility between various computers and applications. (Some TIFF files are incompatible.) TIFF is suitable for editing saved images.



Note

- MP Navigator EX supports the following TIFF file formats.
 - Uncompressed, black and white binary
 - Uncompressed, RGB (8 bits per channel)
 - Uncompressed, YCC (8 bits per component)
 - Grayscale

PDF (Standard File Extension: .pdf)

A file format developed by Adobe Systems. It can be used on various computers and operating systems. Therefore, PDF files can be exchanged between people who use different operating systems, fonts, etc. regardless of the differences.



Note

- Only PDF files created with MP Navigator EX are supported. PDF files created or edited in other applications are not supported.

[Top of Page](#)↑

Advanced Guide

Advanced Guide > Scanning > Scanning with Other Application Software > Appendix: Useful Information on Scanning > Color Matching

Color Matching

Color Matching adjusts devices as shown below to match the colors of an image displayed on a monitor or a printed image with the colors of the original document.

Example: When sRGB is selected as the output profile (target)

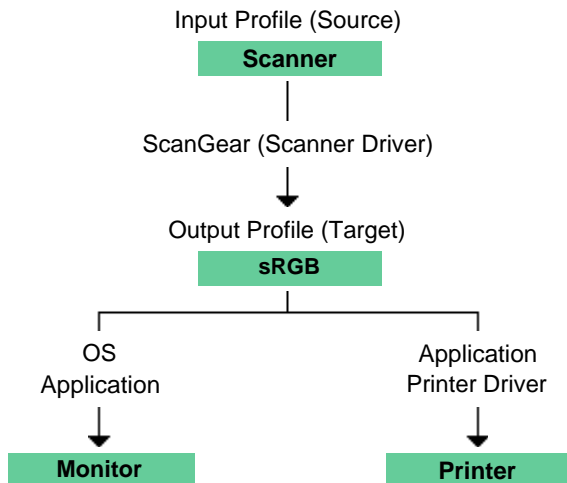

ScanGear (scanner driver) converts the image's color space from the scanner's color space to sRGB. When displaying on a monitor, the image's color space is converted from sRGB to the monitor's color space based on the operation system's monitor settings and the application's working space settings. When printing, the image's color space is converted from sRGB to the printer's color space based on the application's print settings and the printer driver's settings.

[Top of Page](#)↑

Advanced Guide

[Advanced Guide](#) > [Scanning](#) > [Other Scanning Methods](#)

Other Scanning Methods

- ➔ [Scanning with WIA Driver](#)
- ➔ [Scanning using the Control Panel \(Windows XP Only\)](#)

[Page top](#) ↑

Advanced Guide

Advanced Guide > Scanning > Other Scanning Methods > Scanning with WIA Driver

Scanning with WIA Driver

You can scan an image from a WIA-compliant application and use the image in that application. The procedure varies depending on the application. The following procedures are examples only. For details, refer to the application's manual.

Important

- In Windows 2000, you cannot scan using the WIA driver.
- In Windows XP, you cannot scan using the WIA driver 2.0.

Scanning with WIA Driver 1.0

The following is an example of scanning using Paint.

1. Place the document on the Platen.
 - ➔ Placing Documents
2. In File, click From Scanner or Camera.... (Select the command to scan a document in the application.)
3. Select an image type according to the document to be scanned.

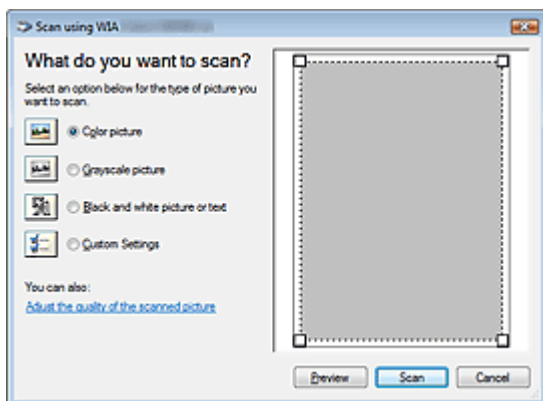

Note

- To scan with the values previously set in Adjust the quality of the scanned picture, select Custom Settings.

4. Click Adjust the quality of the scanned picture and set the preferences as required.

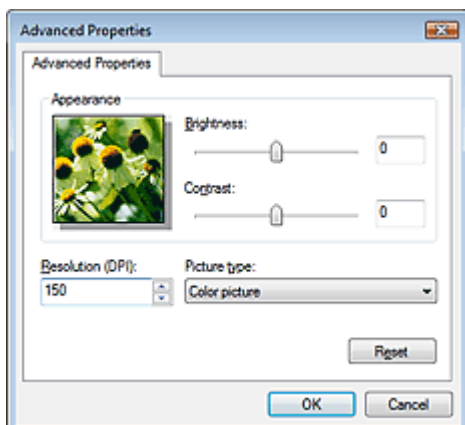

● Brightness

Move the slider to adjust the brightness. Move it to the left to darken and right to brighten the

image. You can also enter a value (-127 to 127).

- **Contrast**

Move the slider to adjust the contrast. Moving it to the left will decrease the contrast of the image, thus softening the image. Moving it to the right will increase the contrast of the image, thus sharpening the image. You can also enter a value (-127 to 127).

- **Resolution**

Enter the resolution. Specify a value between 50 dpi and 600 dpi.

➔ [Resolution](#)

- **Picture type**

Select the type of scan you want for your document.

- **Reset**

Click to restore the original settings.

5. Click Scan.

When scanning is completed, the scanned image appears in the application.

Scanning with WIA Driver 2.0

The following is an example of scanning using Windows Photo Gallery.

1. Place the document on the Platen.

➔ [Placing Documents](#)

2. In File, click From Scanner or Camera..., then double-click WIA Canon (model name).

The scan setting screen appears.

3. Specify the settings.

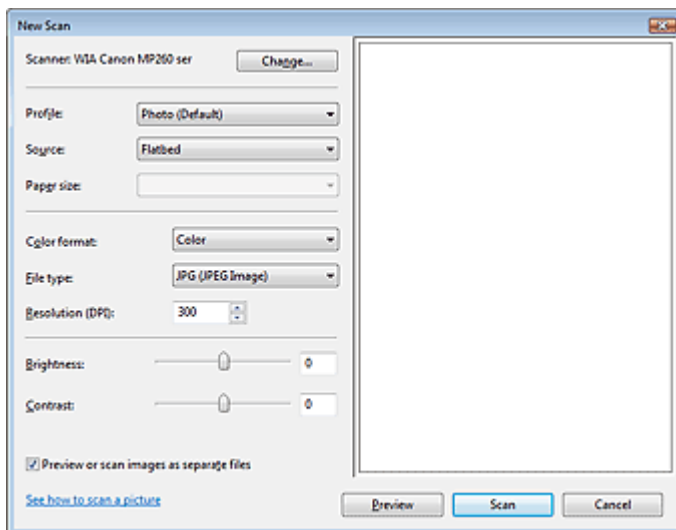

- **Scanner**

The currently set product name is displayed. To change the scanner, click Change... and select the product you want to use.

- **Profile**

Select Photo (Default) or Documents according to the document to be scanned. To save a new Profile, select Add profile.... You can specify the details in the Add New Profile dialog box.

- **Source**

Select a scanner type.

- **Paper Size**

This setting is not available for this machine.

- **Color format Tab**

Select how to scan the document.

- **Save as type**

Select a file format from JPEG, BMP, PNG and TIFF.

- **Resolution**

Enter the resolution. Specify a value between 50 dpi and 600 dpi. 300 dpi is set by default.

➔ Resolution

- **Brightness**

Move the slider to adjust the brightness. Move it to the left to darken and right to brighten the image. You can also enter a value (-100 to 100).

- **Contrast**

Move the slider to adjust the contrast. Moving it to the left will decrease the contrast of the image, thus softening the image. Moving it to the right will increase the contrast of the image, thus sharpening the image. You can also enter a value (-100 to 100).

- **Preview or scan images as separate files**

Select this checkbox to preview or scan multiple images as separate files.

- **See how to scan a picture**

Click to open Windows Help and Support.

4. Click Preview to preview the image.

The preview image appears on the right.

5. Click Scan.

When scanning is completed, the scanned image appears in the application.

[Top of Page](#)↑

Advanced Guide

Advanced Guide > Scanning > Other Scanning Methods > Scanning using the Control Panel (Windows XP Only)

Scanning using the Control Panel (Windows XP Only)

You can scan images via the Control Panel of Windows XP using the WIA driver.

Windows Image Acquisition (WIA) is a driver model implemented in Windows XP. It allows you to scan documents without using an application. Scan documents from a TWAIN-compliant application to specify advanced settings for scanning.

1. From the Start menu, select Control Panel.
2. Click Printers and Other Hardware > Scanners and Cameras, then double-click WIA Canon (model name).

The Scanner and Camera Wizard dialog box opens.

3. Click Next.
4. Select Picture type according to the document to be scanned.

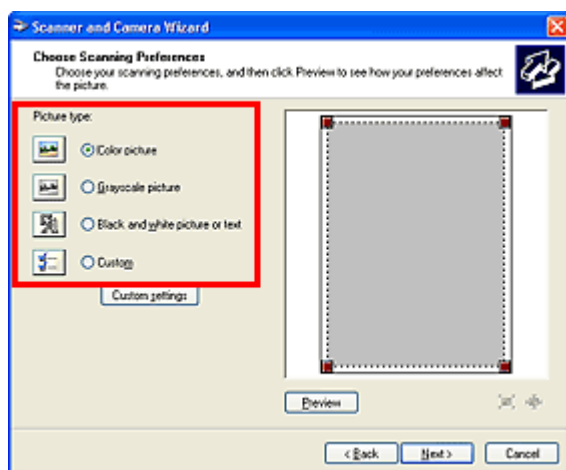

Note

- To scan with the values previously set in Custom Settings, select Custom.

5. Click Custom Settings to set the preferences as required.

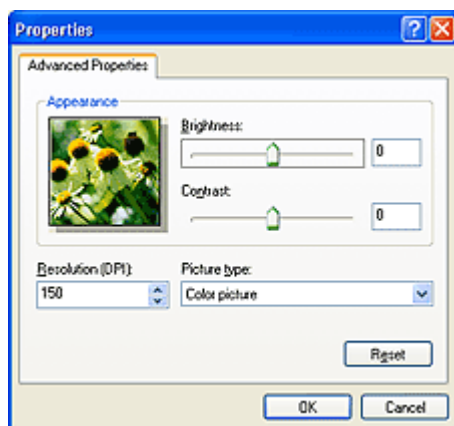

- **Brightness**

Move the slider to adjust the brightness. Move it to the left to darken and right to brighten the image. You can also enter a value (-127 to 127).

- **Contrast**

Move the slider to adjust the contrast. Moving it to the left will decrease the contrast of the image, thus softening the image. Moving it to the right will increase the contrast of the image, thus sharpening the image. You can also enter a value (-127 to 127).

- **Resolution**

Enter the resolution. Specify a value between 50 dpi and 600 dpi.

➔ [Resolution](#)

- **Picture type**

Select the type of scan you want for your document.

- **Reset**

Click to restore the original settings.

6. Click Preview to preview the image.

The preview image appears on the right. Drag  to specify the scan area.

7. Click Next and follow the instructions.

[Top of Page](#)↑

Advanced Guide

[Advanced Guide](#) > [Printing Photographs Directly from a Compliant Device \(MP240 series\)](#)

Printing Photographs Directly from a Compliant Device (MP240 series)

➔ [Printing Photographs Directly from a Compliant Device](#)

[Page top](#) ↕

Advanced Guide

Advanced Guide > Printing Photographs Directly from a Compliant Device (MP240 series) > Printing Photographs Directly from a Compliant Device

Printing Photographs Directly from a Compliant Device

- ➔ [Printing Photographs Directly from a Compliant Device](#)
- ➔ [About PictBridge Print Settings](#)

[Page top](#) ↕

Advanced Guide

Advanced Guide > Printing Photographs Directly from a Compliant Device (MP240 series) > Printing Photographs Directly from a Compliant Device > Printing Photographs Directly from a Compliant Device

Printing Photographs Directly from a Compliant Device

You can connect a PictBridge compliant device such as a digital camera, camcorder, or mobile phone using a USB cable recommended by the device's manufacturer, and print recorded images directly without using a computer.



Note

- When printing photos with the PictBridge compliant device connected to the machine, we recommend the use of the AC adapter supplied with the device. If you are using the device battery, be sure to charge it fully.
- Depending on the model or brand of your device, you may have to select a print mode compliant with PictBridge before connecting the device. You may also have to turn on the device or select Play mode manually after connecting the device to the machine.
Perform necessary operations on the PictBridge compliant device before connecting it to this machine according to instructions given in the device's instruction manual.

1. Make sure that the machine is turned on.
2. Load paper on the Rear Tray.
3. Make sure that the PictBridge compliant device is turned off.
4. Connect the PictBridge compliant device to the machine using a USB cable (A) recommended by the manufacturer of the device.

The PictBridge compliant device turns on automatically.

If your device does not turn on automatically, turn it on manually.

c will appear on the LED and  will appear on the LCD of the device when the machine is correctly connected.

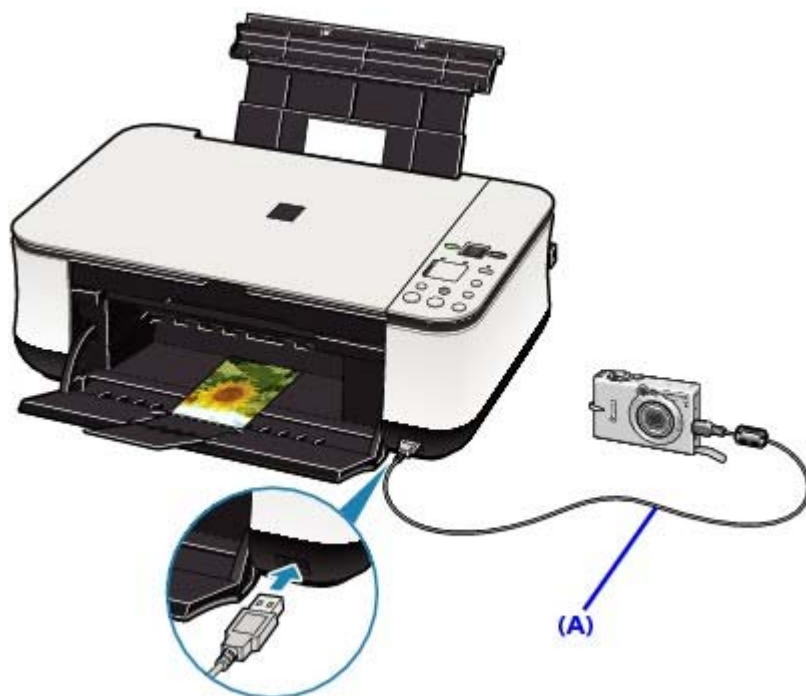

5. Specify the print settings such as paper type and layout.

You can perform settings using the menu on the LCD of your PictBridge compliant device. Select the size and type of paper that you loaded in the machine.

➔ [Settings on a PictBridge Compliant Device](#)

6. Start printing from your PictBridge compliant device.

Important

- Never disconnect the USB cable during printing unless when explicitly allowed to by the PictBridge compliant device. When disconnecting the USB cable between the PictBridge compliant device and machine, follow the instructions given in the device's instruction manual.

[Page top](#) 

Advanced Guide

Advanced Guide > Printing Photographs Directly from a Compliant Device (MP240 series) > Printing Photographs Directly from a Compliant Device > About PictBridge Print Settings

About PictBridge Print Settings

Settings on a PictBridge Compliant Device

This section describes the PictBridge function of the machine. For the print settings on a PictBridge compliant device, refer to the instructions given in the device's instruction manual.



Note

- In the following description, names of setting items are given according to those used in Canon-brand PictBridge compliant devices. Setting item names may be different depending on the brand or model of your device.
- Some setting items explained below may not be available on some devices. When you cannot change print settings on a device, the machine prints images as follows:
 Paper size: 4" x 6" / 101.6 x 152.4 mm
 Paper type: Photo
 Bordered/Borderless: Follow camera's setting
 Layout: 1-up
 Print quality: Standard
 Image Optimize: On (the shooting information will be used for optimized printing)

This section describes the print settings on a PictBridge compliant device. When operating the device, be sure to follow the instructions given in the device's instruction manual.

Paper size	4" x 6"/10 x 15 cm, 5" x 7"*1, 8" x 10"/ 20 x 25 cm, A4, 8.5" x 11"(Letter), 4" x 7.1"/ 10.1 x 18 cm*2 *1 Can be selected only on certain Canon-brand PictBridge compliant devices. (May not be selected depending on the device.) *2 Hi Vision may appear on a non-Canon brand PictBridge compliant device.
Paper type	<ul style="list-style-type: none"> ● Default: Photo Paper Plus Glossy II PP-201 ● Photo: Photo Paper Plus Glossy II PP-201/Glossy Photo Paper "Everyday Use" GP-501/Photo Paper Glossy GP-502/Photo Paper Plus Semi-gloss SG-201 ● Fast Photo: Photo Paper Pro PR-201 ● Plain: A4 When Paper type is set to Plain, borderless printing will be disabled even when Layout is set to Borderless.
Layout	Default (Borderless), Index, Bordered, Borderless, 4-up * * Layout compatible with A4 sized paper
Print date & file no.	Default (Off: No printing), Date, File No., Both, Off
Image optimize	Default (Exif Print), On*1, Off, Face*2, Red-Eye*2 *1 Photos are optimized for printing using the Photo optimizer pro function. *2 Can be selected only on certain Canon-brand PictBridge compliant devices. (May not be selected depending on the device.)
Trimming	Default (Off: No trimming), On (follow camera's setting), Off

[Page top](#) ↕

Advanced Guide

Advanced Guide > Maintenance

Maintenance

- ➔ [Cleaning Your Machine](#)
- ➔ [Performing Maintenance from a Computer](#)

[Page top](#) ↑

Advanced Guide

[Advanced Guide](#) > [Maintenance](#) > [Cleaning Your Machine](#)

Cleaning Your Machine

- ➔ [Cleaning](#)
- ➔ [Cleaning the Exterior of the Machine](#)
- ➔ [Cleaning the Platen Glass and Document Cover](#)

[Page top](#) ↕

Advanced Guide

[Advanced Guide](#) > [Maintenance](#) > [Cleaning Your Machine](#) > [Cleaning](#)

Cleaning

This section describes the cleaning procedure that is needed to maintain your machine.

Caution

- Do not use tissue paper, paper towels, rough-textured cloth, or similar materials for cleaning so as not to scratch the surface. Paper tissue powder or fine threads may remain inside the machine and cause problems such as Print Head blockage and poor printing results. Be sure to use a soft cloth.
 - Never use volatile liquids such as thinners, benzene, acetone, or any other chemical cleaner to clean the machine, as this may cause a malfunction or damage the machine's surface.
-

➔ [Cleaning the Exterior of the Machine](#)

➔ [Cleaning the Platen Glass and Document Cover](#)

[Page top](#) ↑

Advanced Guide

[Advanced Guide](#) > [Maintenance](#) > [Cleaning Your Machine](#) > [Cleaning the Exterior of the Machine](#)

Cleaning the Exterior of the Machine

Be sure to use a soft cloth such as eyeglasses cleaning cloth and wipe off dirt on the surface gently. Smooth out wrinkles on the cloth if necessary before cleaning.

Caution

- Be sure to turn off the power and disconnect the power plug before cleaning the machine.
 - Do not use tissue paper, paper towels, rough-textured cloth, or similar materials, as this may scratch the surface.
-

[Page top](#) ↕

Advanced Guide

Advanced Guide > Maintenance > Cleaning Your Machine > Cleaning the Platen Glass and Document Cover

Cleaning the Platen Glass and Document Cover

Caution

- Be sure to turn off the power and disconnect the power plug before cleaning the machine.

With a clean, soft, lint-free cloth, wipe the Platen Glass (A) and the inner side of the Document Cover (white sheet) (B) gently. Be sure not to leave any residue, especially on the Platen Glass.



Important

- The inner side of the Document Cover (white sheet) (B) is easily damaged, so wipe it gently.

[Page top](#) 

Advanced Guide

[Advanced Guide](#) > [Maintenance](#) > [Performing Maintenance from a Computer](#)

Performing Maintenance from a Computer

- ➔ [Cleaning the Print Heads](#)
- ➔ [Cleaning the Paper Feed Rollers](#)
- ➔ [Aligning the Print Head Position](#)
- ➔ [Checking the Print Head Nozzles](#)
- ➔ [Cleaning Inside the Machine](#)

[Page top](#) ↕

Advanced Guide

Advanced Guide > Maintenance > Performing Maintenance from a Computer > Cleaning the Print Heads

Cleaning the Print Heads

The print head cleaning function allows you to remove any blockages in the print head nozzles. Perform print head cleaning if printing is faint or a specific color fails to print, even though there is enough ink.

The procedure for cleaning the print heads is as follows:



Cleaning

1. Open the [printer driver setup window](#)

2. Click Cleaning on the Maintenance tab

The Print Head Cleaning dialog box opens. Follow the instruction shown in the dialog box. Click Initial Check Items to display the items you need to check before performing Cleaning.

3. Execute cleaning

Make sure that the machine is on and then click Execute.
Print head cleaning starts.

4. Complete cleaning

Click OK when the confirmation message appears.
Next, the Nozzle Check dialog box opens.

5. Check the results

To check whether the print quality has improved, click Print Check Pattern. To cancel the check process, click Cancel.

If cleaning the head once does not resolve the print head problem, clean it once more.



Deep Cleaning

Deep Cleaning is more thorough than Cleaning. Perform deep cleaning when two cleaning attempts do not resolve the print head problem.

1. Open the [printer driver setup window](#)

2. Click Deep Cleaning on the Maintenance tab

The Deep Cleaning dialog box opens. Follow the instruction shown in the dialog box. Click Initial Check Items to display the items you need to check before performing Deep Cleaning.

3. Make sure that the machine is on and then click Execute.

Click OK when the confirmation message appears.
Print head deep cleaning starts.



Important

- Cleaning consumes a small amount of ink. Deep Cleaning consumes a larger amount of ink than Cleaning. Cleaning the print heads frequently will rapidly deplete your printer's ink supply. Consequently, perform cleaning only when necessary.



Note

- If there is no sign of improvement after Deep Cleaning, switch off the machine and perform again. If there is still no sign of improvement, the ink may have run out or the print head may be worn. For details on the remedial action to be taken, see "Machine Moves But Ink Is Not Ejected."
-

Related Topic

➡ [Checking the Print Head Nozzles](#)

[Page top](#) ↑

Advanced Guide

Advanced Guide > Maintenance > Performing Maintenance from a Computer > Cleaning the Paper Feed Rollers

Cleaning the Paper Feed Rollers

The feed roller cleaning function allows you to clean the paper feed roller. Perform feed roller cleaning when there are paper particles sticking to the paper feed roller and paper is not fed properly.

The procedure for cleaning the feed rollers is as follows:



Roller cleaning

1. Prepare the machine

Remove all sheets of paper from the rear tray.

2. Open the [printer driver setup window](#)

3. Click Roller Cleaning on the Maintenance tab

The confirmation message appears.

4. Execute paper feed roller cleaning

Make sure that the machine is on and click OK.

Paper feed roller cleaning starts.

5. Complete paper feed roller cleaning

After the rollers have stopped, follow the instruction in the message, load three sheets of plain paper into the rear tray, and click OK.

Paper will be ejected and feed roller cleaning will be completed.

[Page top](#) ↑

Advanced Guide

Advanced Guide > Maintenance > Performing Maintenance from a Computer > Aligning the Print Head Position

Aligning the Print Head Position

Print head alignment corrects the installation positions of the print head and improves deviated colors and lines.

The procedure for performing print head alignment is as follows:



Print Head Alignment

1. Open the [printer driver setup window](#)
2. Click Print Head Alignment on the Maintenance tab

The Start Print Head Alignment dialog box opens.

3. Load paper in the machine

Load two sheets of A4 size or Letter size plain paper into the rear tray.

4. Execute head alignment

Make sure that the machine is on and click Print Head Alignment.
Follow the instruction in the message.



Note

- To check the current setting before you adjust the print head position, click Print Alignment Value.

5. Check the printed pattern

Enter the numbers of the patterns with the least amount of streaks in the associated boxes.
Clicking the patterns with the least amount of streaks in the preview window, will automatically set their numbers in the associated boxes.

When you have entered all the necessary values, click OK.



Note

- If you look at the print results and still cannot determine which pattern is the one with the least amount of streaks, see your machine manual.

6. Check the second sheet of the printed pattern.

Next, second sheet of head alignment pattern will be printed.
Follow the instruction in the message.

[Page top](#) ↑

Advanced Guide

Advanced Guide > Maintenance > Performing Maintenance from a Computer > Checking the Print Head Nozzles

Checking the Print Head Nozzles

The nozzle check function allows you to check whether the print heads are working properly by printing a nozzle check pattern. Print the pattern if printing becomes faint, or if a specific color fails to print.

The procedure for printing a nozzle check pattern is as follows:



Nozzle Check

1. Open the printer driver setup window

2. Click Nozzle Check on the Maintenance tab

The Nozzle Check dialog box opens.

To display a list of items that you should check before printing the check pattern, click Initial Check Items.

3. Load paper in the machine

Load a sheet of A4 size or Letter size plain paper into the rear tray.

4. Print a nozzle check pattern

Make sure that the machine is on and click Print Check Pattern.

The nozzle check pattern is printed.

Click OK when the confirmation message appears.

The Pattern Check dialog box opens.

5. Check the print result

Check the print result. If the print result is normal, click Exit.

If the print result is smudged or if there are any unprinted sections, click Cleaning to clean the print head.

Related Topic

➔ [Cleaning the Print Heads](#)

[Page top](#) ↑

Advanced Guide

[Advanced Guide](#) > [Maintenance](#) > [Performing Maintenance from a Computer](#) > [Cleaning Inside the Machine](#)

Cleaning Inside the Machine

The bottom plate cleaning function allows you to prevent smudges on the reverse side of a sheet of paper. Perform bottom plate cleaning before you perform duplex printing. Also perform bottom plate cleaning if ink smudges caused by something other than print data appear on the printed page.

The procedure for performing bottom plate cleaning is as follows:



Bottom Plate Cleaning

1. Open the [printer driver setup window](#)
2. Click Bottom Plate Cleaning on the Maintenance tab

The Bottom Plate Cleaning dialog box opens.

3. Load paper in the machine

As instructed in the dialog box, fold the A4 size or Letter size plain paper in half horizontally, and then unfold the sheet.

Load the paper into the rear tray in the portrait orientation with the crest of the crease facing down.

4. Perform the bottom plate cleaning

Make sure that the machine is on and click Execute.
Bottom plate cleaning starts.

[Page top](#) ↑

Advanced Guide

Advanced Guide > Changing the Machine Settings

Changing the Machine Settings

➔ [Changing Machine Settings from Your Computer](#)

[Page top](#) ↕

Advanced Guide

[Advanced Guide](#) > [Changing the Machine Settings](#) > [Changing Machine Settings from Your Computer](#)

Changing Machine Settings from Your Computer

- ➔ [Changing the Print Options](#)
- ➔ [Saving a Changed Printing Profile](#)
- ➔ [Setting the Ink Cartridge](#)
- ➔ [Managing the Machine Power](#)
- ➔ [Reducing the Machine Noise](#)
- ➔ [Changing the Machine Operation Mode](#)

[Page top](#) ↑

Advanced Guide

Advanced Guide > Changing the Printer Settings > Changing Printer Settings from Your Computer > Changing the Print Options

Changing the Print Options

You change detailed print driver settings for print data that is sent from an application software. Specify this option if you encounter print failures such as part of an image data being cut off.

The procedure for changing the print options is as follows:

1. Open the [printer driver setup window](#)
2. Click Print Options... on the Page Setup tab

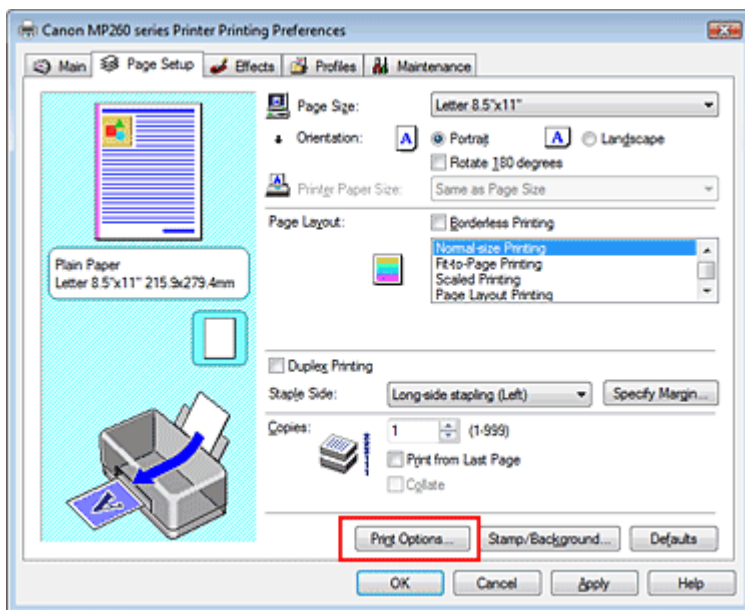

The Print Options dialog box opens.

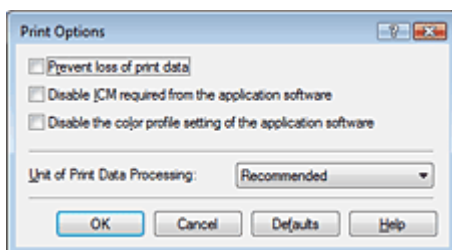

3. Change the individual settings

If necessary, change the setting of each item, and then click OK.

The Page Setup tab is displayed again.

[Page top](#) ↑

Advanced Guide

Advanced Guide > Changing the Printer Settings > Changing Printer Settings from Your Computer > Saving a Changed Printing Profile

Saving a Changed Printing Profile

You can assign a name to the settings made on the Main, Page Setup, and Effects tabs and save them as a printing profile. The saved printing profile can be retrieved and used from the Profiles tab at any time. Unnecessary printing profiles can be deleted at any time.

The procedure for registering a printing profile is as follows:

Registering a printing profile

1. Open the printer driver setup window

2. Set the necessary items

Make your desired settings on the Main, Page Setup, and Effects tabs.

3. On the Profiles tab, click Add to Profiles...

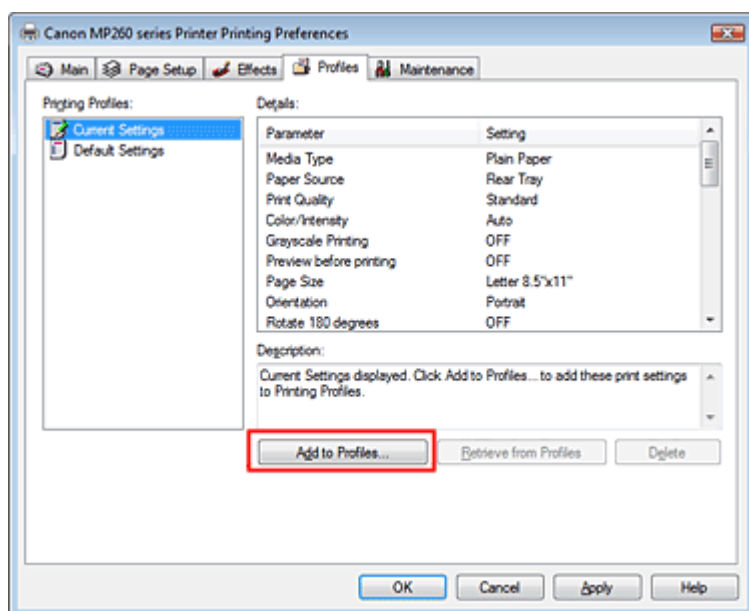

The Add to Profiles dialog box opens.

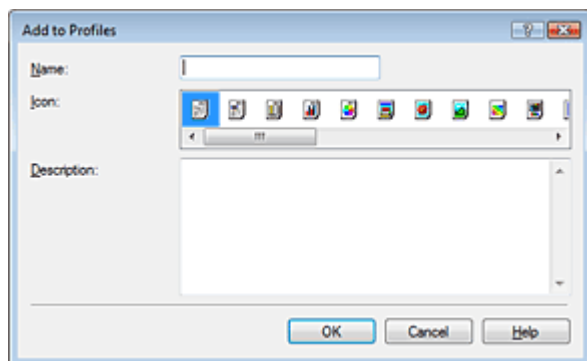

4. Save the settings

Set Name, Icon, and Description, then click OK.

The profile is saved and the Profiles tab is displayed again.

The name and icon are added to the Printing Profiles list.

Note

- If you install the printer driver again or upgrade the version of the printer driver, the print settings you

registered will be deleted from Printing Profiles.

Registered print settings cannot be saved and preserved. In this case, register the print settings again.

Using registered print settings

1. Select the print settings to be used

Select a printing profile in the Printing Profiles list on the Profiles tab.

The parameters and settings of the profile are displayed in the Details box.

2. Retrieve from Profiles

Click Retrieve from Profiles.

Click OK when a message appears.

Settings of the selected profile are applied to the Main, Page Setup, and Effects tabs.



Note

- If you want to revert a profile to the default settings, select Default Settings in the Printing Profiles list and click Retrieve from Profiles.
-

Deleting unnecessary printing profile

1. Select the printing profile to be deleted

Select the printing profile you want to delete from the Printing Profiles list on the Profiles tab.

2. Delete the printing profile

Click Delete. When the confirmation message appears, click OK.

The selected printing profile is deleted from the Printing Profiles list.



Note

- Current Settings and Default Settings cannot be deleted.
-

[Page top](#) ↑

Advanced Guide

Advanced Guide > Changing the Printer Settings > Changing Printer Settings from Your Computer > Setting the Ink Cartridge

Setting the Ink Cartridge

When printing, you can specify the ink cartridge you use.

If one of the ink cartridges becomes empty, you can continue printing by specifying the ink cartridge that still has ink.

The procedure for specifying the ink cartridge is as follows:



Ink Cartridge Settings

1. Open the [printer driver setup window](#)
2. Click Ink Cartridge Settings on the Maintenance tab
The Ink Cartridge Settings dialog box appears.
3. Select the ink cartridge to be used
Select the ink cartridge to be used for printing and click OK.
The specified ink cartridge will be used from the next printing.

Important

- When the following settings are configured, Black Only is disabled. The color ink cartridge is also used to print.
 - A media type other than Plain Paper, Hagaki, or Envelope is selected for Media Type on the Main tab.
 - Borderless Printing is checked on the Page Setup tab.
- Canon recommends that you use the ink cartridges installed in the machine and not remove them until the ink runs out.

[Page top](#) ↑

Advanced Guide

[Advanced Guide](#) > [Changing the Printer Settings](#) > [Changing Printer Settings from Your Computer](#) > [Managing the Machine Power](#)

Managing the Machine Power

This function allows you to manage the machine power from the printer driver.

The procedure for managing the printer power is as follows:



Power Off

The Power Off function turns off the machine. If you use this function, you will not be able to turn the machine on from the printer driver.

1. Open the [printer driver setup window](#)
2. Execute power off

Click Power Off on the Maintenance tab. When the confirmation message appears, click OK.

The machine power switches off, and the Maintenance tab is displayed again.

[Page top](#) ↑

Advanced Guide

Advanced Guide > Changing the Printer Settings > Changing Printer Settings from Your Computer > Reducing the Machine Noise

Reducing the Machine Noise

This function allows you to reduce the operating noise of the machine. Select if you wish to reduce the operating noise of the printer at night, etc.
Using this function may lower the print speed.

The procedure for changing the quiet mode settings is as follows:



Quiet Mode

1. Open the [printer driver setup window](#)
2. Click Quiet Mode on the Maintenance tab

The Quiet Mode dialog box opens.

3. Set the silent function

If necessary, specify one of the following items:

Do not use quiet mode

The operating noise of the machine is at normal volume.

Always use quiet mode

Select this option when you wish to reduce the operating noise of the machine.

Use quiet mode within specified time

The operating noise of the machine can be reduced during a specified period of time.
Set the Start time and End time when you wish the quiet mode to be activated.



Important

- The time specified in Start time and in End time must be different.

4. Transmit the settings

Make sure that the machine is on and click Send.
Click OK when the confirmation message appears.
The selected settings are enabled hereafter.



Note

- Depending on print quality settings, effects of the quiet mode may be less.

[Page top](#) ↑

Advanced Guide

Advanced Guide > Changing the Printer Settings > Changing Printer Settings from Your Computer > Changing the Machine Operation Mode

Changing the Machine Operation Mode

This function allows you to switch between various modes of machine operation.

The procedure for changing the printer settings is as follows:



Custom Settings

1. Open the [printer driver setup window](#)
2. Make sure that the machine is on, and then click Custom Settings on the Maintenance tab

The Custom Settings dialog box opens.



Note

- If the machine is off or bi-directional communication is disabled, a message may appear because the computer cannot collect the machine status.
If this happens, click OK to display the most recent settings specified on your computer.

3. If necessary, complete the following settings:

Prevent paper abrasion

The printer can increase the gap between the print head and the paper during high-density printing to prevent paper abrasion.

Check this check box to use this function.

Ink Drying Wait Time

You can set the length of the machine rest time until printing of the next page begins. Moving the slider to the right increases the pause time and moving the slider to the left decreases the time.

If the paper gets stained because the next page is ejected before the ink on the printed page dries, increase the ink drying wait time.

Reducing the ink drying wait time speeds up printing.

4. Transmit the settings

Click Send. When the confirmation message appears, click OK.

The machine runs in the changed mode hereafter.

[Page top](#) ↑

Advanced Guide

Advanced Guide > Troubleshooting

Troubleshooting

- ➔ If an Error Occurs
- ➔ The Machine Can Not Be Powered On
- ➔ LED Cannot Be Seen At All
- ➔ An Error Code Is Displayed on the LED
- ➔ Cannot Install the MP Drivers
- ➔ Cannot Connect to Computer Properly
- ➔ Print Results Not Satisfactory
- ➔ Printing Does Not Start
- ➔ Copying/Printing Stops Before It Is Completed
- ➔ Machine Moves But Ink Is Not Ejected
- ➔ Printing Speed Not as Fast as Expected
- ➔ FINE Cartridge Holder Does Not Move to the Position for Replacing
- ➔ Paper Does Not Feed Properly
- ➔ Paper Jams
- ➔ Message Appears on the Computer Screen
- ➔ For Windows Users
- ➔ Error Message Appears on a PictBridge Compliant Device (MP240 series)
- ➔ Cannot Print Properly from a Photo Index Sheet (MP260 series)
- ➔ Cannot Remove a Memory Card (MP260 series)
- ➔ Problems with Scanning
- ➔ Software Problems
- ➔ MP Navigator EX Problems
- ➔ FAQs
- ➔ If You Cannot Resolve the Problem
- ➔ Instructions for Use (Printer Driver)
- ➔ General Notes (Scanner Driver)

[Page top](#) ↕

Advanced Guide

Advanced Guide > Troubleshooting > If an Error Occurs

If an Error Occurs

When an error occurs in printing such as the machine is out of paper or paper is jammed, a troubleshooting message is displayed automatically. Take the appropriate action described in the message. The message may vary depending on the version of your operating system.

Windows

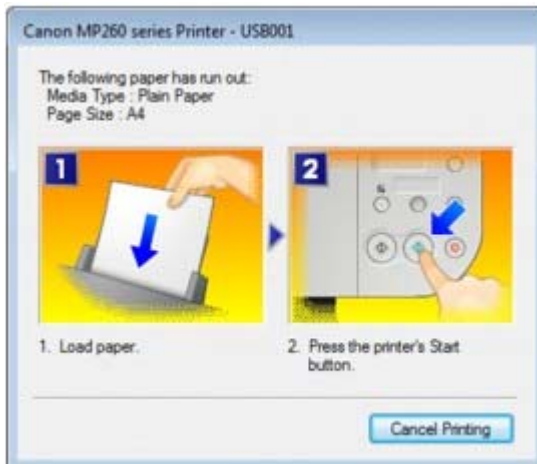

Macintosh

- In Mac OS X v.10.5.x:

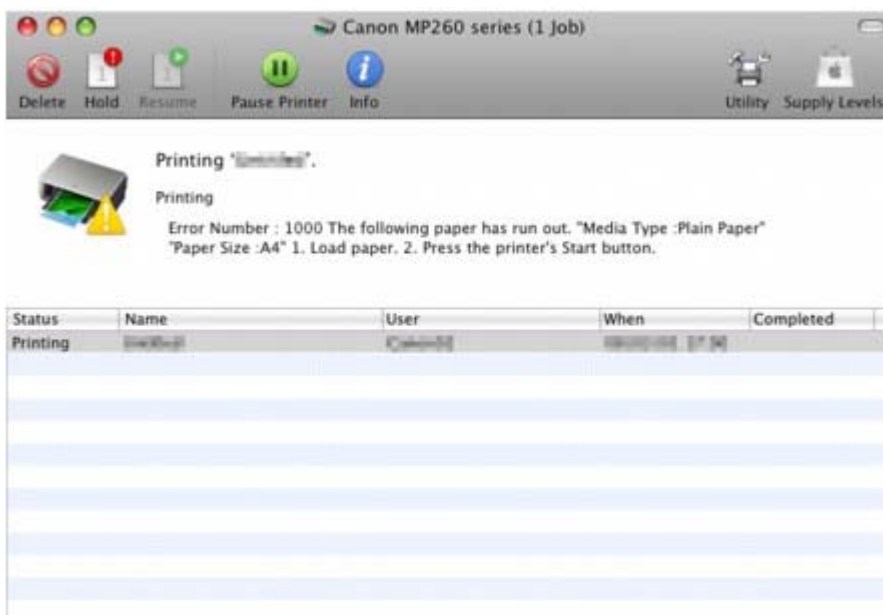

- In Mac OS X v.10.4.x or Mac OS X v.10.3.9:



Advanced Guide

[Advanced Guide](#) > [Troubleshooting](#) > [The Machine Cannot Be Powered On](#)

The Machine Cannot Be Powered On

- **Check 1: Press the ON button.**
- **Check 2: Make sure that the power plug is securely plugged into the Power Cord Connector of the machine, then turn it back on.**
- **Check 3: Unplug the machine from the power supply, then plug the machine back in and turn the machine back on after leaving it for at least 1 minute.**

If the problem is not resolved, contact your Canon service representative.

[Page top](#) ↕

Advanced Guide

[Advanced Guide](#) > [Troubleshooting](#) > LED Cannot Be Seen At All

LED Cannot Be Seen At All

- **If the Power lamp is off:**

The machine is not powered on. Connect the power cord and press the **ON** button.

- **If the Power lamp is lit:**

The LED may be in the screen-saver mode. On the Operation Panel, press a button other than the **ON** button.

[Page top](#) ↑

Advanced Guide

Advanced Guide > Troubleshooting > An Error Code Is Displayed on the LED

An Error Code Is Displayed on the LED

- **Alarm Lamp Flashes Orange**



When a machine error occurs, the **Alarm** lamp is lit orange and E and number (error code) are alternately displayed on the LED. Check the error code displayed on the LED and take the appropriate action to correct the error.

* Depending on the error occurred, the **Alarm** lamp is not lit.

Error Code	Cause	Action
E, 2	The machine is out of paper. / Paper does not feed.	Reload the paper on the Rear Tray correctly and press the Black or Color button.
E, 3	Paper jam.	If paper has jammed in the machine, clear the jam, reload the paper in the machine correctly and then press the Black or Color button. ➔ Paper Jams
E, 4 E, 5	The FINE Cartridge cannot be recognized.	The FINE Cartridge may not be installed properly, or the Cartridge may not be compatible with this machine. Open the Scanning Unit (Cover) and install the appropriate FINE Cartridge. If the error is not resolved, the FINE Cartridge may be damaged. Contact your Canon service representative.
E, 7	FINE Cartridge is not installed in the correct position.	Make sure that each FINE Cartridge is installed in the correct position. ➔ Routine Maintenance
E, 8	Ink absorber is almost full.	The ink absorber is becoming full. The machine has a built-in ink absorber to hold the ink used during Print Head Cleaning. Press the Black or Color button to cancel the error so you can continue printing. Before the ink absorber becomes completely full, contact a Canon service representative. (You will need to replace a particular part of the machine.)
E, 9 (MP240 series)	The machine has not received a response from the digital camera. The digital camera or digital video camcorder connected is not compatible with this machine.	<ul style="list-style-type: none"> • A communication time out occurs if an operation takes too long or if it takes too much time to send data. This may cancel printing. In such cases, disconnect and reconnect the USB cable. When printing from a PictBridge compliant device, depending on the model or brand of your device, you may have to select a PictBridge compliant print mode on the device before connecting it to the machine. You may also have to turn on your device or select Play mode manually after connecting the device to the machine. Perform necessary operations before connecting

		<p>your device referring to its instruction manual.</p> <p>If the error is still not resolved, check if you can print another photograph.</p> <ul style="list-style-type: none"> • Check the device connected to the machine. Printing photos directly is possible only with a PictBridge compliant device.
E, 1, 3	Ink level cannot be detected.	<p>Ink may have run out.</p> <p>The function for detecting the remaining ink level will be disabled since the ink level cannot be correctly detected.</p> <p>If you want to continue printing without this function, press the Stop/Reset button for at least 5 seconds.</p> <p>Canon recommends to use new genuine Canon cartridges in order to obtain optimum qualities.</p> <p>Please be advised that Canon shall not be liable for any malfunction or trouble caused by continuation of printing under the ink out condition.</p>
E, 1, 4	The FINE Cartridge cannot be recognized.	<p>The FINE Cartridge may not be compatible with this machine.</p> <p>Install the appropriate FINE Cartridge.</p> <p>➔ Routine Maintenance</p>
E, 1, 5	The FINE Cartridge cannot be recognized.	<p>The FINE Cartridge may not be installed properly.</p> <p>Open the Scanning Unit (Cover) and install the FINE Cartridge properly.</p> <p>➔ Routine Maintenance</p>
E, 1, 6	Ink has run out.	<p>Ink has run out.</p> <p>Replace the ink cartridge and close the Scanning Unit (Cover).</p> <p>If printing is in progress and you want to continue printing, press the Stop/Reset button for at least 5 seconds with the ink cartridge installed. Then printing can continue under the ink out condition.</p> <p>The function for detecting the remaining ink level will be disabled.</p> <p>Replace the empty ink cartridge immediately after the printing. The resulting print quality is not satisfactory, if printing is continued under the ink out condition.</p>
E, 1, 9 (MP240 series)	PictBridge compliant device is connected via a USB hub.	If a PictBridge compliant device is connected via a USB hub, remove the hub and connect it directly to the machine.
E, 3, 0	The size of the original cannot be correctly detected or the document is too small when the Fit-to-Page copying is selected.	<ul style="list-style-type: none"> • Make sure that the original meets the requirements and is correctly loaded on the Platen Glass. • Check the position and direction of the original loaded on the Platen Glass.
E, 3, 1	The machine is not connected with the computer.	Connect the machine and the computer with a USB cable.
E, 3, 2 E, 3, 3 (MP260 series)	Scanning the Photo Index Sheet has failed.	<ul style="list-style-type: none"> • Make sure that the Photo Index Sheet is set in the correct position and orientation on the Platen Glass. • Make sure that all required circles on the Photo Index Sheet are filled in.
E, 3, 4 E, 3, 6	No DPOF information./ Unable to scan images on	<ul style="list-style-type: none"> • There is no image data saved on the memory card that can be read by this

(MP260 series)	the Photo Index Sheet correctly./No images on the Photo Index Sheet.	<p>machine.</p> <ul style="list-style-type: none"> • The machine may not recognize the file if the file name or the folder path contains certain characters. Use only alphanumeric characters. • Photo data edited or processed on a computer must be printed from the computer.
E, 4, 0 (MP260 series)	Unable to recognize the memory card when saving the scanned data on the memory card.	The format of the memory card is not compatible with this machine. Use the memory card formatted by the FAT form.
E, 4, 1 E, 4, 2 E, 4, 3 E, 4, 4 E, 4, 5 (MP260 series)	Unable to save the scanned images on the memory card.	<ul style="list-style-type: none"> • You cannot save the scanned images on the memory card if the read-only mode is enabled. Press the Maintenance button repeatedly until c appears on the LED, and then press the Black button to enable the read/write mode. <ul style="list-style-type: none"> • Unlock the memory card when you save the scanned images. • The memory card is full. <p>After carrying out the above measures, if the problem continues, turn the machine back on. If the error is not resolved, the memory card may be damaged.</p>
E, 4, 6 (MP260 series)	The memory card is removed while saving is in progress.	Do not remove the memory card while saving is in progress.
E, 4, 7 (MP260 series)	The read/write mode is enabled in the read/write attribute.	You cannot print images if the read/write mode is enabled. Press the Maintenance button repeatedly until c appears on the LED, and then press the Color button to enable the read-only mode.
E, 4, 8 (MP260 series)	The memory card is not inserted in the Card Slot.	Insert the memory card in the Card Slot. For details on how to insert the memory card, refer to Printing from a Memory Card (MP260 series) .
E, 5, 0 E, 5, 1	Scanning the Print Head Alignment Sheet has failed.	<ul style="list-style-type: none"> • Make sure that all required boxes on the head alignment sheet are filled in, and that the sheet is set in the correct position and orientation on the Platen Glass. • Make sure the Platen Glass and the Print Head Alignment Sheet are not dirty. <p>If the error is not resolved, connect the machine to the computer and align the Print Head on the printer driver.</p> <p>➡ Aligning the Print Head Position</p>
E, 5, 2 E, 5, 3 (MP260 series)	Scanning the Language Selection Sheet has failed.	<ul style="list-style-type: none"> • Make sure that all required boxes on the Language Selection Sheet are filled in, and that the sheet is set in the correct position and orientation on the Platen Glass. • Make sure the Platen Glass and the Language Selection Sheet are not dirty.
E, 5, 4 (MP260 series)	The memory card is inserted in the Card Slot when you change the read/write attribute setting.	When the memory card is inserted in the Card Slot, you cannot change the read/write attribute setting. Remove the memory card from the Card Slot and press the Black or Color button.

• Power Lamp Flashes Green and Alarm Lamp Flashes Orange

Alternately

When the **Power** and **Alarm** lamps flash alternately as shown below, and P and number (error

code) are alternately displayed on the LED, an error requiring servicing might have occurred.

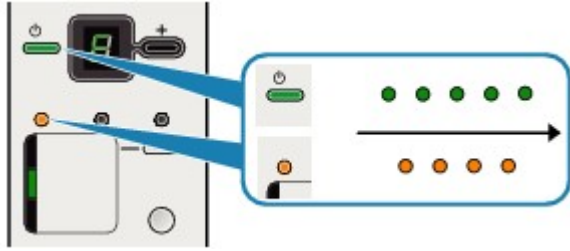

Turn off the machine, and unplug the power cord of the machine from the power supply.

Plug the power cord of the machine back in, and then turn on the machine.

If the problem is not resolved, contact your Canon service representative.

[Page top](#) ↕

Advanced Guide

Advanced Guide > Troubleshooting > Cannot Install the MP Drivers

Cannot Install the MP Drivers

- If the installation does not start even after the *Setup CD-ROM* is inserted into your computer's disc drive:

Windows

Start the installation following the procedure below.

1. Click Start then Computer.

In Windows XP, click Start then My Computer.

In Windows 2000, double-click the  My Computer icon on the desktop.

2. Double-click the  CD-ROM icon on the displayed window.

If the contents of the CD-ROM are displayed, double-click MSETUP4.EXE.

Macintosh

Double-click the  CD-ROM icon on your desktop to start installation.

Note

- If the CD-ROM icon is not displayed, try the following:
 - Remove the CD-ROM from your computer, then insert it again.
 - Restart your computer.
- If the icon is still not displayed, try different discs and see if they are displayed. If other discs are displayed, there is a problem with the *Setup CD-ROM*. In this case, contact your Canon service representative.

- If you are unable to proceed beyond the Printer Connection screen:

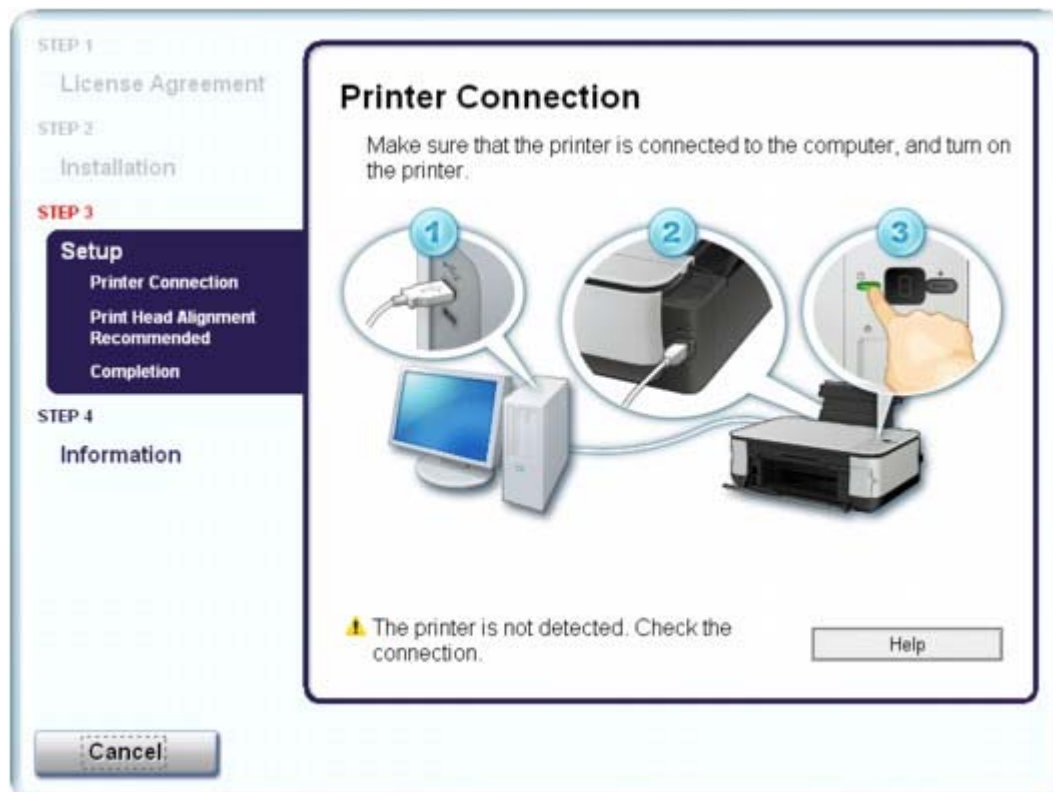

If you are unable to proceed beyond the Printer Connection screen, make sure that the USB cable is securely plugged into the USB port of the machine and is connected to the computer, and then follow the procedure below to reinstall the MP Drivers.

 **Note**

-
- In Windows Vista, "The printer is not detected. Check the connection." may be displayed depending on the computer you use. In this case, wait for a while. If you still cannot proceed to the next step, follow the procedure below to reinstall the MP Drivers.
-

1. Click Cancel on the Printer Connection screen.
 2. Click Start Over on the Installation Failure screen.
 3. Click Back on the screen that appears next.
 4. Click Exit on the PIXMA XXX screen, then remove the CD-ROM.
 5. Turn the machine off.
 6. Restart the computer.
 7. Make sure that you have no application software running.
 8. Follow the procedure described in your setup manual to reinstall the MP Drivers.
- **In other cases:**

Follow the procedure described in your setup manual to reinstall the MP Drivers.

If the MP Drivers were not installed correctly, uninstall the MP Drivers, restart your computer, and then reinstall the MP Drivers.

➔ [Uninstalling the MP Drivers](#)

If you reinstall the MP Drivers, select Custom Install on the *Setup CD-ROM*.

 **Note**

-
- If the installer was forced to be terminated due to a Windows error, the system may be in an unstable condition and you may not be able to install the drivers. Restart your computer before reinstalling.
-

[Page top](#) ↕

Advanced Guide

Advanced Guide > Troubleshooting > Cannot Connect to Computer Properly

Cannot Connect to Computer Properly

Printing or Scanning Speed Is Slow/Hi-Speed USB Connection Does Not Work/

"This device can perform faster" Message Is Displayed

If your system environment is not fully compatible with Hi-Speed USB, the machine will operate at a lower speed provided under USB 1.1. In this case, the machine operates properly but printing speed may slow down due to communication speed.

- **Check: Check the following to make sure that your system environment supports Hi-Speed USB connection.**
 - Does the USB port on your computer support Hi-Speed USB connection?
 - Do the USB cable, and the USB hub if you are using one, support Hi-Speed USB connection?
Be sure to use a certified Hi-Speed USB cable. We recommend that the cable is no longer than around 10 feet / 3 meters.
 - Does the operating system of your computer support Hi-Speed USB connection?
Obtain and install the latest update for your computer.
 - Does the Hi-Speed USB driver operate properly?
Obtain the latest version of the Hi-Speed USB driver compatible with your hardware and reinstall it on your computer.



Important

- For details on Hi-Speed USB of your system environment, contact the manufacturer of your computer, USB cable, or USB hub.

[Page top](#) 

Advanced Guide

Advanced Guide > Troubleshooting > Print Results Not Satisfactory

Print Results Not Satisfactory

If the print result is not satisfactory due to white streaks, misaligned lines, or uneven colors, confirm the paper and print quality settings first.

- **Check 1: Do the page size and media type settings match the size and type of the loaded paper?**

When these settings are incorrect, you cannot obtain a proper print result.

If you are printing a photograph or an illustration, incorrect paper type setting may reduce the quality of printout color.

Also, if you print with an incorrect paper type setting, the printed surface may be scratched.

In borderless printing, uneven coloring may occur depending on the combination of the paper type setting and the loaded paper.

- **MP240 series**

To copy by operating the machine	Confirm by using the Operation Panel on the machine. ➔ Copying
To print from a PictBridge compliant device	Confirm by using your PictBridge compliant device. ➔ Printing Photographs Directly from a Compliant Device
To print from a computer	Confirm by using the printer driver. ➔ Printing with Easy Setup

- **MP260 series**

To copy by operating the machine	Confirm by using the Operation Panel on the machine. ➔ Copying
To print from your memory card by operating the machine	Confirm by using the Photo Index Sheet. ➔ Printing from a Memory Card (MP260 series)
To print from a computer	Confirm by using the printer driver. ➔ Printing with Easy Setup

- **Check 2: Make sure that the appropriate print quality is selected**

according to the media type and printing data using the MP Drivers.

Select a print quality option suitable to the paper and image for printing. If you notice blurs or uneven colors, increase the print quality setting and try printing again.

Confirm the print quality setting using the printer driver.

➔ [Changing the Print Quality and Correcting Image Data](#)

- **Check 3: If the problem is not resolved, there may be other causes.**

See also the sections below:

➔ [Cannot Print to End of Job](#)

➔ [No Printing Results/Printing Is Blurred/Colors Are Wrong/White Streaks](#)

➔ [Colors Are Unclear](#)

➔ [Lines Are Misaligned](#)

➔ [Printed Paper Curls or Has Ink Blots](#)

➔ [Paper Is Smudged/Printed Surface Is Scratched](#)

➔ [Back of the Paper Is Smudged](#)

➔ [Vertical Lines Are Printed on the Sides of the Printout](#)

➔ [Colors Are Uneven or Streaked](#)

Advanced Guide

[Advanced Guide](#) > [Troubleshooting](#) > [Print Results Not Satisfactory](#) > [Cannot Print to End of Job](#)

Cannot Print to End of Job

- **Check 1: Is the size of the print data extremely large?**



Click Print Options on the Page Setup sheet. Then, select the Prevent loss of print data check box in the displayed dialog.

- **Check 2: Is the space of your computer's hard disk sufficient?**

Delete unnecessary files to free disk space.

[Page top](#) ↕

Advanced Guide

Advanced Guide > Troubleshooting > Print Results Not Satisfactory > No Printing Results/Printing Is Blurred/Colors Are Wrong/White Streaks

No Printing Results/Printing Is Blurred/Colors Are Wrong/White Streaks

❖ No Printing Results



❖ Printing Is Blurred

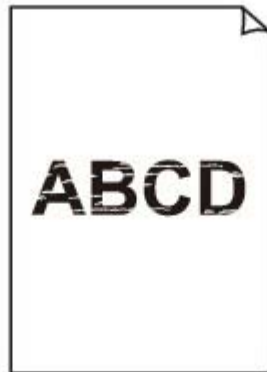

❖ Colors Are Wrong



❖ White Streaks

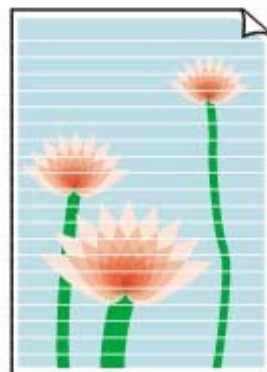

- **Check 1: Did you confirm the paper and print quality settings?**

➔ [Print Results Not Satisfactory](#)

- **Check 2: Is the FINE Cartridge installed properly?**

If the Ink Cartridge Locking Cover is not closed securely, ink may not be ejected correctly.

Open the Scanning Unit (Cover), open the Ink Cartridge Locking Cover, then close the Ink Cartridge Locking Cover.

When you close the Ink Cartridge Locking Cover, push the Ink Cartridge Locking Cover until it clicks into place.

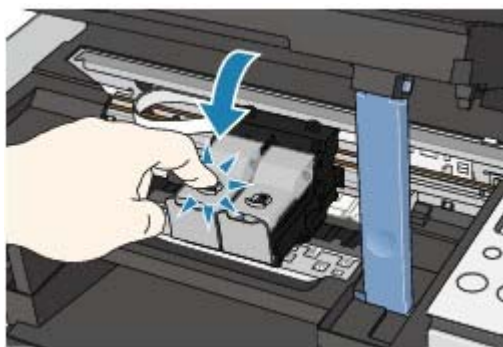

- **Check 3: Print the Nozzle Check Pattern and perform any necessary maintenance operations such as Print Head Cleaning.**

Print the Nozzle Check Pattern to determine whether the ink ejects properly from the print head nozzles.

Refer to [Routine Maintenance](#) for the Nozzle Check Pattern printing, Print Head Cleaning, and Print Head Deep Cleaning.

- If the Nozzle Check Pattern is not printed correctly:
After performing the Print Head Cleaning, print the Nozzle Check Pattern and examine the pattern.
- If the problem is not resolved after performing the Print Head Cleaning twice:
Perform the Print Head Deep Cleaning.
If the problem is not resolved after performing the Print Head Deep Cleaning, try it again.
- If the problem is not resolved after performing the Print Head Deep Cleaning twice:
Ink may have run out. Replace the FINE Cartridge.

- **Check 4: When a FINE Cartridge runs out of ink, replace it with a new one.**

- **Check 5: When using paper with one printable surface, make sure that the paper is loaded with the printable side facing up.**

Printing on the wrong side of such paper may cause unclear prints or prints with reduced quality.

Refer to the paper's instruction manual for detailed information on the printable side.

- **When copying, see also the sections below:**

- **Check6: Make sure that the original is properly loaded on the Platen Glass.**

➡ [Loading Paper / Originals](#)

- **Check7: Is the original loaded with the side to be copied facing down on the Platen Glass?**

- **Check8: Did you copy a printout done by this machine?**

Print from the memory card or from the digital camera directly, or reprint from the computer.

If you copy a printout done by this machine, print quality may be reduced.

[Page top](#) ↕

Advanced Guide

Advanced Guide > Troubleshooting > Print Results Not Satisfactory > Colors Are Unclear

Colors Are Unclear

• Check 1: Enable color correction.

When printing photographs or other graphics, enabling color correction in the printer driver may improve color.



Select Vivid Photo in the Effects sheet in the printer properties dialog box.



Select Color Options in the pop-up menu in the Print dialog box, and then select Vivid Photo on the Color Mode.

In Mac OS X v 10.4.x or Mac OS X v 10.3.9, select Special Effects in the Print dialog box, and then select Vivid Photo.

• Check 2: Is the FINE Cartridge installed properly?

If the Ink Cartridge Locking Cover is not closed securely, ink may not be ejected correctly.

Open the Scanning Unit (Cover), open the Ink Cartridge Locking Cover, then close the Ink Cartridge Locking Cover.

When you close the Ink Cartridge Locking Cover, push the Ink Cartridge Locking Cover until it clicks into place.

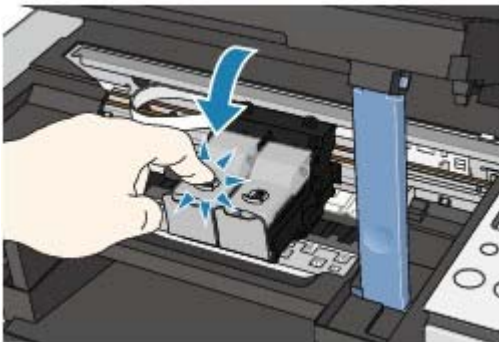

• Check 3: When a FINE Cartridge runs out of ink, replace it with a new one.

• Check 4: Is the Nozzle Check Pattern printed properly?

Print the Nozzle Check Pattern to determine whether the ink ejects properly from the print head nozzles.

Refer to [Routine Maintenance](#) for the Nozzle Check Pattern printing, Print Head Cleaning, and Print Head Deep Cleaning.

- If the Nozzle Check Pattern is not printed correctly:
After performing the Print Head Cleaning, print the Nozzle Check Pattern and examine the pattern.
- If the problem is not resolved after performing the Print Head Cleaning twice:
Perform the Print Head Deep Cleaning.
If the problem is not resolved after performing the Print Head Deep Cleaning, try it again.
- If the problem is not resolved after performing the Print Head Deep Cleaning twice:
Ink may have run out. Replace the FINE Cartridge.

Note

- Printed colors may not match screen colors due to basic differences in the methods used to produce colors. Color control settings and environmental differences can also affect how colors appear on the screen.

Advanced Guide

Advanced Guide > Troubleshooting > Print Results Not Satisfactory > Lines Are Misaligned

Lines Are Misaligned



- **Check 1: Did you confirm the paper and print quality settings?**

➔ [Print Results Not Satisfactory](#)

- **Check 2: Perform Print Head Alignment**

If you did not align the Print Head after installation, straight lines may be printed misaligned.

➔ [Routine Maintenance](#)



- **Check 3: Is the size of the print data extremely large?**

Click Print Options on the Page Setup sheet. Then, select the Prevent loss of print data check box in the displayed dialog.

- **Check 4: Is the Printing layout printing or Binding margin function being used?**

When the Printing layout printing or Binding margin function is being used, thin lines may not be printed. Try thickening the lines in the document.

[Page top](#) ↑

Advanced Guide

[Advanced Guide](#) > [Troubleshooting](#) > [Print Results Not Satisfactory](#) > [Printed Paper Curls or Has Ink Blots](#)

Printed Paper Curls or Has Ink Blots

Printed Paper Curls



Printed Paper Has Ink Blots



- **Check 1: Did you confirm the paper and print quality settings?**

➔ [Print Results Not Satisfactory](#)

- **Check 2: If the intensity is set high, reduce the Intensity setting in the printer driver and try printing again.**

If you are using plain paper to print images with high intensity, the paper may absorb too much ink and become wavy, causing paper abrasion.

Confirm the intensity using the printer driver.

➔ [Adjusting Intensity](#)

- **Check 3: Is Photo Paper being used for printing photographs?**

When printing data with high color saturation such as photographs or images in deep color, we recommend using Photo Paper Plus Glossy II or other Canon speciality paper.

➔ [Loading Paper / Originals](#)

[Page top](#) ↕

Advanced Guide

Advanced Guide > Troubleshooting > Print Results Not Satisfactory > Paper Is Smudged/Printed Surface Is Scratched

Paper Is Smudged/Printed Surface Is Scratched

✦ Paper Is Smudged

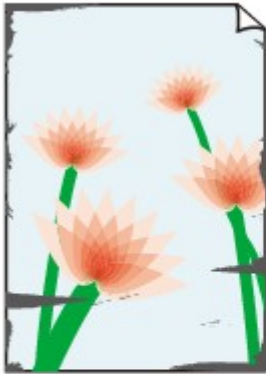

The Edges of Paper Are Smudged

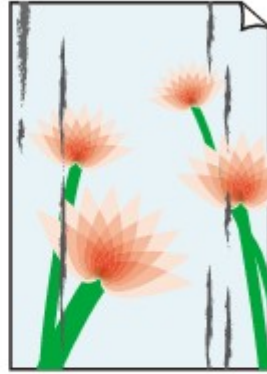

Printed Surface Is Smudged



✦ Printed Surface Is Scratched

- **Check 1: Did you confirm the paper and print quality settings?**

➔ [Print Results Not Satisfactory](#)

- **Check 2: Is the appropriate type of paper being used? Check the**

following:

- Check to see if the paper you are printing on is suitable for your printing purpose.
 - ➔ [Loading Paper / Originals](#)
- When performing Borderless Printing, make sure that the paper you are using is suitable for Borderless Printing. If the paper you are using is not suitable for Borderless Printing, the print quality may be reduced at the top and bottom edges of the paper.
 - ➔ [Printing Area](#)

- **Check 3: Load the paper after correcting its curl.**

- **For Plain Paper**

Turn the paper over and reload it to print on the other side.

Leaving the paper loaded on the Rear Tray for a long time may cause the paper to curl. In this case, load the paper with the other side facing up. It may resolve the problem.

We recommend putting unused paper back into the package and keeping it on a level surface.

- **For Other Paper**

1. With the printing side (A) facing up, cover the paper with a fresh sheet of plain paper to avoid staining or scratching the surface.
2. Roll up the paper in the opposite direction to the paper curl as seen below.

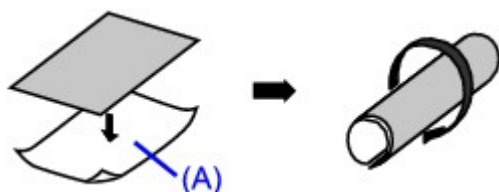

3. Check to see that the paper curl is within approximately 0.08 to 0.2 inches / 2 to 5 mm (B) in height.

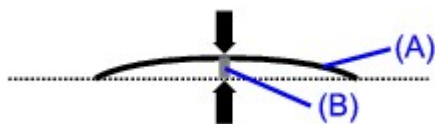

We recommend printing curl-corrected paper one sheet at a time.



Note

- Depending on the media type, the paper may be smudged or may not be fed properly even if it is not curled. In such cases, follow the procedure described above to curl the paper before printing. This may improve the print result.

• Check 4: If you are printing on thick paper, select the Prevent paper abrasion setting.

Selecting the Prevent paper abrasion setting will widen the clearance between the Print Head and the loaded paper. If you notice abrasion even with the media type set correctly to match the loaded paper, set the machine to prevent paper abrasion by using the Operation Panel or the printer driver.

Print speed is reduced if you are selecting the Prevent paper abrasion setting.

* Deactivate the Prevent paper abrasion setting once printing is complete. If not, this setting remains enabled for all subsequent print jobs.

• To set by using the Operation Panel

Press the **Maintenance** button repeatedly until **r** appears on the LED, then press the **Black** button to enable the Prevent paper abrasion function.

To disable the Prevent paper abrasion function, press the **Maintenance** button repeatedly until **r** appears on the LED, then press the **Color** button.

• To set by using the printer driver

Windows

Open the printer properties dialog box, and in Custom Settings in the Maintenance sheet, select the Prevent paper abrasion check box, and then click Send.

To open the printer properties dialog box, see [Opening the Printer Properties Dialog Box \(Windows\)](#).

Macintosh

In the Canon IJ Printer Utility, select Custom Settings in the pop-up menu, select the Prevent paper abrasion check box, and then click Send.

To open the Canon IJ Printer Utility, see [Opening the Canon IJ Printer Utility \(Macintosh\)](#).

• Check 5: If the intensity is set high, reduce the Intensity setting in the printer driver and try printing again.

If you are using plain paper to print images with high intensity, the paper may absorb too much ink and become wavy, causing paper abrasion.

Reduce the Intensity setting in the printer driver and try printing again.

Windows

1. Open the printer properties dialog box.

➔ [Opening the Printer Properties Dialog Box \(Windows\)](#)

2. On the Main sheet, select Manual for Color/Intensity, and then click Set.

3. Drag the Intensity slide bar on the Color Adjustment sheet to adjust the intensity.

Macintosh

1. Open the Print dialog box.

➔ [Opening the Page Setup and Print Dialog Box \(Macintosh\)](#)

2. Select Color Options in the pop-up menu.

3. Drag the Intensity slide bar to set the intensity.

- **Check 6: Is printing performed beyond the recommended printing area?**

If you are printing beyond the recommended printing area of your printing paper, the lower edge of the paper may become stained with ink.

Resize your original document in your application software.

➔ [Printing Area](#)

- **Check 7: Is the Platen Glass dirty?**

Clean the Platen Glass.

➔ [Cleaning the Platen Glass and Document Cover](#)

- **Check 8: Is the Paper Feed Roller dirty?**

Clean the Paper Feed Roller.

➔ [Routine Maintenance](#)



Note

- Cleaning the Paper Feed Roller will wear the roller, so perform this procedure only when necessary.

- **Check 9: Is inside of the machine dirty?**

When performing duplex printing, the inside of the machine may become stained with ink, causing the printout to become smudged.

Perform the Bottom Plate Cleaning to clean the inside of the machine.

➔ [Routine Maintenance](#)



Note

- To prevent the inside of the machine from stains, set the paper size correctly.

- **Check 10: Set Ink Drying Wait Time longer.**

Doing so gives the printed surface enough time to dry so that paper smudged and scratched are prevented.



1. Make sure that the machine is turned on.
2. Open the printer properties dialog box.
➔ [Opening the Printer Properties Dialog Box \(Windows\)](#)
3. Click the Maintenance tab and then Custom Settings.
4. Drag the Ink Drying Wait Time slide bar to set the wait time, and then click Send.
5. Confirm the message and click OK.



1. Make sure that the machine is turned on.
2. Open the Canon IJ Printer Utility.
➔ [Opening the Canon IJ Printer Utility \(Macintosh\)](#)
3. Select Custom Settings in the pop-up menu.
4. Drag the Ink Drying Wait Time slide bar to set the wait time, and then click Send.

5. Confirm the message and click OK.

- **Check 11: Is the paper scratched by other loaded paper?**

Depending on the media type, the paper may be scratched with other loaded paper when feeding from the Rear Tray. In this case, load one sheet at a time.

[Page top](#) ↑

Advanced Guide

Advanced Guide > Troubleshooting > Print Results Not Satisfactory > Back of the Paper Is Smudged

Back of the Paper Is Smudged

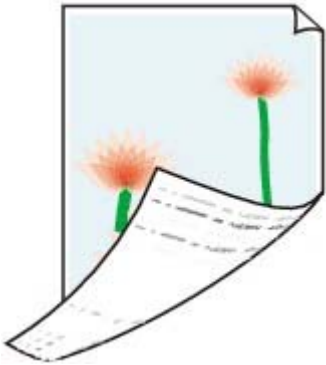

- **Check 1: Did you confirm the paper and print quality settings?**
 - ➔ [Print Results Not Satisfactory](#)
- **Check 2: Perform the Bottom Plate Cleaning to clean the inside of the machine.**
 - ➔ [Routine Maintenance](#)



Note

- When performing duplex printing or too much printing, the inside may become stained with ink.

[Page top](#) ↕

Advanced Guide

Advanced Guide > Troubleshooting > Print Results Not Satisfactory > Vertical Lines Are Printed on the Sides of the Printout

Vertical Lines Are Printed on the Sides of the Printout



- **Check 1: Did you confirm the paper type and print quality settings?**

➔ [Print Results Not Satisfactory](#)

- **Check 2: Is the size of the loaded paper correct?**

The margin may be smudged if the size of the loaded paper is larger than that specified in the printer driver.

Set the paper size correctly according to the paper you loaded.

➔ [Print Results Not Satisfactory](#)



Note

- This machine performs automatic cleaning when necessary to keep printouts clean. A small amount of ink is ejected for cleaning. Although ink is usually ejected on the ink absorber, it may be ejected on the paper if you load paper larger than that specified with the printer driver.

[Page top](#) ↕

Advanced Guide

Advanced Guide > Troubleshooting > Print Results Not Satisfactory > Colors Are Uneven or Streaked

Colors Are Uneven or Streaked

▣ Colors Are Uneven



▣ Colors Are Streaked



- **Check 1: Did you confirm the paper and print quality settings?**

➔ [Print Results Not Satisfactory](#)

- **Check 2: Print the Nozzle Check Pattern and perform any necessary maintenance operations such as Print Head Cleaning.**

Print the Nozzle Check Pattern to determine whether the ink ejects properly from the print head nozzles.

Refer to [Routine Maintenance](#) for the Nozzle Check Pattern printing, Print Head Cleaning, and Print Head Deep Cleaning.

- If the Nozzle Check Pattern is not printed correctly:
After performing the Print Head Cleaning, print the Nozzle Check Pattern and examine the pattern.
- If the problem is not resolved after performing the Print Head Cleaning twice:
Perform the Print Head Deep Cleaning.
If the problem is not resolved after performing the Print Head Deep Cleaning, try it again.
- If the problem is not resolved after performing the Print Head Deep Cleaning twice:
Ink may have run out. Replace the FINE Cartridge.

- **Check 3: Perform Print Head Alignment.**

➔ [Routine Maintenance](#)

[Page top](#) ↑

Advanced Guide

Advanced Guide > Troubleshooting > Printing Does Not Start

Printing Does Not Start

- **Check 1: Make sure that the power plug is securely plugged in, then turn the machine on.**

While the **Power** lamp is flashing green, the machine is initializing. Wait until the **Power** lamp stops flashing and remains lit green.



- When printing large data such as a photo or graphics, it may take longer to start printing. While the **Power** lamp is flashing green, the computer is processing data and sending it to the machine. Wait until printing starts.

- **Check 2: Make sure that the USB cable is securely plugged in to the machine and the computer, then check the following:**

- If you are using a relay device such as a USB hub, disconnect it, connect the machine directly to the computer, and try printing again. If printing starts normally, there is a problem with the relay device. Consult the reseller of the relay device for details.
- There could also be a problem with the USB cable. Replace the USB cable and try printing again.

- **Check 3: Restart your computer if you are printing from the computer.**

If there are any unnecessary print jobs, delete them.

➔ [Deleting the Undesired Print Jobs](#)

- **Check 4: Make sure that your machine's name is selected in the Print dialog box.**

The machine will not print properly if you are using a driver for a different printer.

In Windows, make sure that your machine's name is selected in the Print dialog box.

On a Macintosh, make sure that your machine's name is selected in Printer in the Print dialog box.



- To make the machine the one selected by default, select Set as Default Printer (Windows), Default Printer or Make Default (Macintosh).



- **Check 5: Configure the printer port appropriately.**

Configure "USBn" (where "n" is a number) as the printer port.

1. Log on as a user account with administrator privilege.
2. Click Control Panel, then Printer under Hardware and Sound.
In Windows XP, click Control Panel, Printers and Other Hardware, then Printers and Faxes.
In Windows 2000, click Control Panel then Printers.
3. Right-click the Canon XXX icon, then select Properties.
4. Click the Ports tab to confirm the port settings.

Make sure that a port named USBn (where "n" is a number) with Canon XXX Printer appearing in the Printer column is selected for Print to the following port(s).

If the setting is incorrect, reinstall the MP Drivers or change the printer port to the correct one.

[Page top](#) ↕

Advanced Guide

Advanced Guide > Troubleshooting > Copying/Printing Stops Before It Is Completed

Copying/Printing Stops Before It Is Completed

- **Check 1: Has the machine been printing continuously for a long period?**

If the machine has been printing continuously for a long time, the Print Head may overheat. To protect the Print Head, the machine may stop printing at a line break for a period of time and then resume printing.

In this case, interrupt your print session at a convenient time and turn the machine off for at least 15 minutes.

Additionally, if the machine has been printing graphics or photos with intense colors continuously over a period of time, the machine may stop printing to protect the Print Head. In this case, printing will not resume automatically. Turn the machine off for at least 15 minutes.

Caution

- The Print Head and the surrounding area can become extremely hot inside the machine. Never touch the Print Head or nearby components.

- **Check 2: Is the paper loaded?**

Make sure that paper is loaded on the Rear Tray.

If the machine has run out of paper, load paper.

- **Check 3: Do the printing documents have lots of photographs or illustrations?**

Printing large data such as photos or graphics takes time for the machine and the computer to process, during which the machine may appear to have stopped operating.

In addition, when printing data that uses a large amount of ink continuously on plain paper, the machine may pause temporarily. In either case, wait until the process is complete.

Note

- If you are printing a document with a large printing area or printing multiple copies of a document, printing may pause to allow the ink to dry.

- **Check 4: If copying stops before it is completed, try to copy again.**

If a certain time passes after some errors occurred while copying, the machine stops the operation.

[Page top](#) ↕

Advanced Guide

Advanced Guide > Troubleshooting > Machine Moves But Ink Is Not Ejected

Machine Moves But Ink Is Not Ejected

• Check 1: Are the Print Head nozzles clogged?

Print the Nozzle Check Pattern to determine whether the ink ejects properly from the print head nozzles.

Refer to [Routine Maintenance](#) for the Nozzle Check Pattern printing, Print Head Cleaning, and Print Head Deep Cleaning.

- If the Nozzle Check Pattern is not printed correctly:
After performing the Print Head Cleaning, print the Nozzle Check Pattern and examine the pattern.
- If the problem is not resolved after performing the Print Head Cleaning twice:
Perform the Print Head Deep Cleaning.
If the problem is not resolved after performing the Print Head Deep Cleaning, try it again.
- If the problem is not resolved after performing the Print Head Deep Cleaning twice:
Ink may have run out. Replace the FINE Cartridge.

• Check 2: Is the FINE Cartridge installed properly?

If the Ink Cartridge Locking Cover is not closed securely, ink may not be ejected correctly.

Open the Scanning Unit (Cover), open the Ink Cartridge Locking Cover, then close the Ink Cartridge Locking Cover.

When you close the Ink Cartridge Locking Cover, push the Ink Cartridge Locking Cover until it clicks into place.

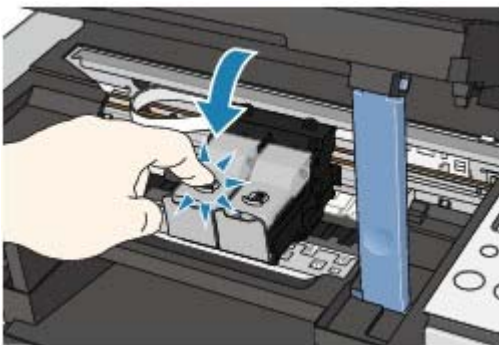

• Check 3: When a FINE Cartridge runs out of ink, replace it with a new one.

[Page top](#) ↑

Advanced Guide

Advanced Guide > Troubleshooting > Printing Speed Not as Fast as Expected

Printing Speed Not as Fast as Expected

• Check 1: Is printing performed in Quiet Mode?

Print speed is reduced if you specified to print in Quiet Mode in the printer driver. For faster printing, do not print in Quiet Mode.

➔ [Reducing the Machine Noise](#)

• Check 2: Is the print quality set too high?

Increase the printing speed setting in the printer driver. Setting to prioritize speed makes printing faster.



1. Open the printer properties dialog box.

➔ [Opening the Printer Properties Dialog Box \(Windows\)](#)

2. On the Main sheet, select Fast for the Print Quality setting.

Depending on the media type, the Fast option may not be available.



1. Open the Print dialog box.

➔ [Opening the Page Setup and Print Dialog Box \(Macintosh\)](#)

2. Select Quality & Media in the pop-up menu and then select Fast for the Print Quality setting.

Depending on the media type, the Fast option may not be available.



Note

- Printing speed may not improve noticeably by following the instructions above, depending on your system environment.

[Page top](#) ↕

Advanced Guide

Advanced Guide > Troubleshooting > FINE Cartridge Holder Does Not Move to the Position for Replacing

FINE Cartridge Holder Does Not Move to the Position for Replacing

- **Check 1: Is the Power lamp off?**

Check if the **Power** lamp is lit green.

The FINE Cartridge Holder will not move unless the power is on. If the **Power** lamp is off, close the Scanning Unit (Cover) and turn the machine on.

While the **Power** lamp is flashing green, the machine is initializing. Wait until the **Power** lamp stops flashing and remains lit green, and then open the Scanning Unit (Cover) again.

- **Check 2: Is an error code displayed on the LED?**

Close the Scanning Unit (Cover), confirm the number of times the **Alarm** lamp is flashing, take the appropriate action to resolve the error, and then reopen it. For details on how to resolve the error, see [Alarm Lamp Flashes Orange](#).

- **Check 3: Has the Scanning Unit (Cover) been left open for 10 minutes or longer?**

If the Scanning Unit (Cover) is left open for more than 10 minutes, the FINE Cartridge Holder moves to the right to prevent the Print Head from drying out. Close and reopen the Scanning Unit (Cover) to return the FINE Cartridge Holder to the left.

- **Check 4: Has the machine been printing continuously for a long period?**

Close the Scanning Unit (Cover), wait a while, then reopen it.

If the machine has been printing continuously for a long time, the Print Head will overheat, and the machine stops printing temporarily to protect the Print Head.

Note

- Opening the Scanning Unit (Cover) while printing moves the FINE Cartridge Holder to the right. Close the Scanning Unit (Cover), and reopen it after printing is complete.

[Page top](#) ↕

Advanced Guide

Advanced Guide > Troubleshooting > Paper Does Not Feed Properly

Paper Does Not Feed Properly

• Check 1: Make sure of the following when you load paper.

- When loading two or more sheets of paper, align the edges of the sheets before loading.
- When loading two or more sheets of paper, make sure that the paper stack does not exceed the paper support load limit.
However, proper feeding of paper may not be possible at this maximum capacity depending on the type of paper or environmental conditions (either very high or low temperature and humidity). In such cases, reduce the sheets of paper you load at a time to less than half of the paper support load limit.
- Always load the paper in portrait orientation, regardless of the printing orientation.
- When you load the paper on the Rear Tray, load the paper with the print side facing UP and slide the Paper Guides to align with the both side of the paper.

➔ [Loading Paper / Originals](#)

• Check 2: Check to see if the paper you are printing on is not too thick or curled.

➔ [Loading Paper / Originals](#)

• Check 3: Make sure of the following when you load envelopes.

- When printing on envelopes, refer to [Loading Paper / Originals](#), and prepare the envelopes before printing.
Once you have prepared the envelopes, load them in portrait orientation. If the envelopes are placed in landscape orientation, they will not feed properly.

• Check 4: Remove the foreign object in the Rear Tray.

• Check 5: Clean the Paper Feed Roller.

➔ [Routine Maintenance](#)



Note

- Cleaning the Paper Feed Roller will wear the roller, so perform this procedure only when necessary.

[Page top](#) ↕

Advanced Guide

Advanced Guide > Troubleshooting > Paper Jams

Paper Jams

Note

- If you need to turn off the machine to remove jammed paper during printing, press the **Stop/Reset** button to cancel print jobs before turning off the machine.

If the paper is jammed in the Paper Output Slot or the Rear Tray:

Remove the paper following the procedure below.

1. Slowly pull the paper out, either from the Rear Tray or from the Paper Output Slot, whichever is easier.



Note

- If the paper tears and a piece remains inside the machine, turn the machine off, open the Scanning Unit (Cover), and remove the paper. Be careful not to touch the components inside the machine. After removing all paper, close the Scanning Unit (Cover), and turn the machine back on.
- If you cannot pull the paper out, turn the machine off and turn it back on. The paper may be ejected automatically.

2. Reload the paper, and press the **Stop/Reset** button on the machine.

If you turned off the machine in step (1), all print jobs in the queue are canceled. Reprint if necessary.

Note

- When reloading the paper, confirm that you are using the correct paper and are loading it correctly.
➡ [Loading Paper / Originals](#)
- A5-sized paper is suited to printing documents consisting mainly of text. We do not recommend using such paper to print documents with photos or graphics, since the printout may curl and cause paper exit jams.

If you cannot remove the paper or the paper tears inside the machine, or if the paper jam error continues after removing the paper, contact your Canon service representative.

In other cases:

Make sure of the following:

- **Check 1: Are there any foreign objects in the Rear Tray or around the Paper Output Slot?**
- **Check 2: Is the paper curled?**
➡ [Check 3: Load the paper after correcting its curl.](#)

Advanced Guide

Advanced Guide > Troubleshooting > Message Appears on the Computer Screen

Message Appears on the Computer Screen

- ➔ Service Error 5100 Is Displayed
- ➔  Writing Error/Output Error/Communication Error
- ➔  Error Number: 300 Is Displayed
- ➔  Error Number: 1700 Is Displayed
- ➔  Ink Info Number: 1688 Is Displayed
- ➔  Ink Info Number: 1686 Is Displayed
- ➔  Error Number: 2001 Is Displayed (MP240 series)
- ➔  Error Number: 2002 Is Displayed (MP240 series)
- ➔  Other Error Messages

Service Error 5100 Is Displayed

- **Check: Is the movement of the FINE Cartridge Holder blocked?**

Cancel printing from your computer, turn off the machine. Then clear the jammed paper or protective material that is preventing the FINE Cartridge Holder from moving.



Important

- Be careful not to touch the components inside the machine. The machine may not print out properly if you touch it.

Turn the machine back on.

If the problem is not resolved, contact your Canon service representative.

Writing Error/Output Error/Communication Error

- **Check 1: If the Power lamp is off, make sure that the power cord is plugged in, then turn the machine on.**
While the **Power** lamp is flashing green, the machine is initializing. Wait until the **Power** lamp stops flashing and remains lit green.
- **Check 2: Make sure that the printer port is configured appropriately in the MP Drivers.**

* In the following instructions, "XXX" signifies your machine's name.

1. Log on as a user account with administrator privilege.

2. Click Control Panel, then Printer under Hardware and Sound.

In Windows XP, click Control Panel, Printers and Other Hardware, then Printers and Faxes.

In Windows 2000, click Control Panel then Printers.

3. Right-click the Canon XXX icon, then select Properties.

4. Click the Ports tab to confirm the port settings.

Make sure that a port named USBnnn (where "n" is a number) with Canon XXX Printer appearing in the Printer column is selected for Print to the following port(s).

If the port setting is not correct, reinstall the MP Drivers or change the port setting according to the interface you are using.

- **Check 3: Make sure that the USB cable is securely plugged in to the machine**

and the computer.

- If you are using a relay device such as a USB hub, disconnect it, connect the machine directly to the computer, and try printing again. If printing starts normally, there is a problem with the relay device. Consult the reseller of the relay device for details.
- There could also be a problem with the USB cable. Replace the USB cable and try printing again.

• Check 4: Make sure that the MP Drivers are installed correctly.

Uninstall the MP Drivers following the procedure described in [Uninstalling the MP Drivers](#) and reinstall them following the procedure described in your setup manual.

• Check 5: Check the status of the device on your computer.

Follow the procedure below to check the status of the device.

1. Click Control Panel, Hardware and Sound, then Device Manager.

If the User Account Control screen is displayed, follow the on-screen instructions.

In Windows XP, click Control Panel, Performance and Maintenance, System, then click Device Manager on the Hardware sheet.

In Windows 2000, click Control Panel, System, then Device Manager on the Hardware sheet.

2. Double-click Universal Serial Bus controllers then USB Printing Support.

If USB Printing Support is not displayed, make sure that the machine is securely connected to the computer.

➔ [Check 3: Make sure that the USB cable is securely plugged in to the machine and the computer.](#)

3. Click the General tab and make sure that there is no indication of a problem with the device.

If a device error is displayed, refer to Windows help to resolve the error.

Macintosh Error Number: 300 Is Displayed**• Check 1: If the Power lamp is off, make sure that the power plug is plugged in, then turn the machine on.**

While the **Power** lamp is flashing green, the machine is initializing. Wait until the **Power** lamp stops flashing and remains lit green.

• Check 2: Make sure that the USB cable is securely plugged in to the machine and the computer.

- If you are using a relay device such as a USB hub, disconnect it, connect the machine directly to the computer, and try printing again. If printing starts normally, there is a problem with the relay device. Consult the reseller of the relay device for details.
- There could also be a problem with the USB cable. Replace the USB cable and try printing again.

• Check 3: Make sure that your machine's name is selected in the Print dialog box.

➔ [Opening the Page Setup and Print Dialog Box \(Macintosh\)](#)

Macintosh Error Number: 1700 Is Displayed**• See E, 8 in Alarm Lamp Flashes Orange and take the appropriate action.****Macintosh Ink Info Number: 1688 Is Displayed****• See E, 1, 6 in Alarm Lamp Flashes Orange and take the appropriate action.**

Macintosh Ink Info Number: 1686 Is Displayed

- See **E, 1, 3** in **Alarm Lamp Flashes Orange** and take the appropriate action.

Macintosh Error Number: 2001 Is Displayed (MP240 series)

- See **E, 9** in **Alarm Lamp Flashes Orange** and take the appropriate action.

Macintosh Error Number: 2002 Is Displayed (MP240 series)

- See **E, 1, 9** in **Alarm Lamp Flashes Orange** and take the appropriate action.

Windows Other Error Messages

- **Check: If an error message is displayed outside the printer status monitor, check the following:**
 - "Could not spool successfully due to insufficient disk space"
Delete any unnecessary files to increase the amount of free space on the disk.
 - "Could not spool successfully due to insufficient memory"
Quit other running applications to increase available memory.
If you still cannot print, restart your computer and retry printing.
 - "Printer driver could not be found"
Uninstall the printer driver according to the procedure described in [Uninstalling the MP Drivers](#), and then reinstall it.
 - "Could not print Application name - File name"
Try printing again once the current job is complete.

Page top 

Advanced Guide

Advanced Guide > Troubleshooting > For Windows Users

For Windows Users

Printer Status Monitor Is Not Displayed

- **Check: Is the printer status monitor enabled?**

Make sure that Enable Status Monitor is selected on the Option menu of the printer status monitor.

1. **Open the printer properties dialog box.**
 - ➔ [Opening the Printer Properties Dialog Box \(Windows\)](#)
2. **On the Maintenance sheet, click View Printer Status.**
3. **Select Enable Status Monitor on the Option menu if it is not selected.**

The Inkjet Printer/Scanner Extended Survey Program Screen Is Displayed

If the Inkjet Printer/Scanner Extended Survey Program is installed, the confirmation screen asking to send the printer usage information will be displayed three months and then six months after the installation. After that, it will be displayed every half a year for about four years.

Read the instructions on the screen and follow the procedure below.

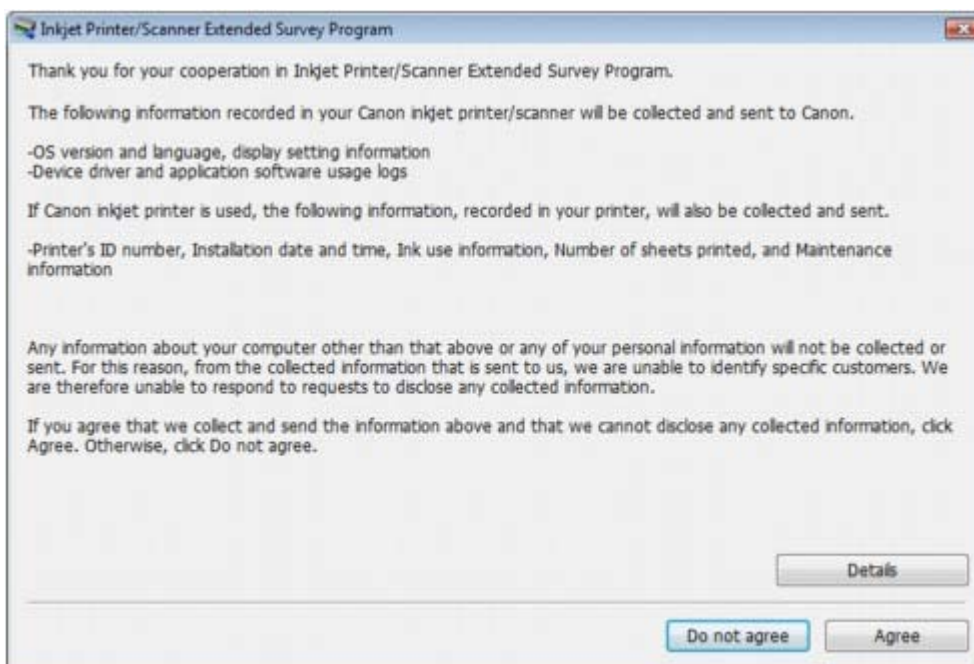

- **If you agree to participate in the survey program:**

Click Agree, then follow the on-screen instructions. The printer usage information will be sent to Canon via the Internet.

 **Note**

- When sending the information, the caution screen such as an Internet security may be displayed. In this case, confirm the program name is "IJPLMUI.exe", then allow it.

- **If you do not agree to participate in the survey program:**

Click Do not agree. The confirmation screen will be closed, and the survey at that time is skipped. The confirmation screen will be displayed again three months later.

- **To uninstall the Inkjet Printer/Scanner Extended Survey Program:**

To uninstall the Inkjet Printer/Scanner Extended Survey Program, click Details, then click Uninstall on the detail description screen. Once the program has been uninstalled, neither the survey nor the transmission of the printer usage information will be performed.



[Page top ↕](#)

Advanced Guide

Advanced Guide > Troubleshooting > Error Message Appears on a PictBridge Compliant Device (MP240 series)

Error Message Appears on a PictBridge Compliant Device (MP240 series)

The following are the possible errors that may occur when printing directly from a PictBridge compliant device and the countermeasures to clear them.

Note

- This section describes errors that are indicated on Canon-brand PictBridge compliant devices. The error messages and operations may vary depending on the device you are using. For errors on non-Canon PictBridge compliant devices, check the error code on the LED and take the appropriate action to clear the error. For details, see [An Error Code Is Displayed on the LED](#).
- For the errors indicated on the PictBridge compliant device and their solution, also refer to the instruction manual of the device. For other troubles on the device, contact the manufacturer.

Error Message On PictBridge Compliant Device	Action
"Printer in use"	If the machine is printing from the computer or warming up, wait until the job ends. When it is ready, the machine starts printing automatically.
"No paper"	Load paper on the Rear Tray, and select Continue* in the display on your PictBridge compliant device. * To resume printing, you can also press the Black or Color button on the machine instead of selecting Continue on the device.
"Paper jam"	Select Stop in the display on your PictBridge compliant device to stop printing. Remove the jammed paper, load new paper, press the Black or Color button on the machine, and try printing again.
"Printer cover open"	Close the Scanning Unit (Cover) on the machine.
"No print head"	The FINE Cartridge is not installed or the Cartridge may not be compatible with this machine. See E, 4 / E, 5 in Alarm Lamp Flashes Orange and take the appropriate action.
"Waste tank full"/"Ink absorber full"	The ink absorber is nearly full. See E, 8 in Alarm Lamp Flashes Orange and take the appropriate action.
"No ink"/ "Ink cassette error"	<ul style="list-style-type: none"> • The FINE Cartridge has or may have run out of ink. • The FINE Cartridge may not be installed properly or may not be compatible with this machine. Check the error code on the LED and take the appropriate action to resolve the error. ➔ An Error Code Is Displayed on the LED
"Hardware Error"	FINE Cartridge errors have occurred. Replace the FINE Cartridge. ➔ Routine Maintenance
"Printer error"	An error requiring servicing may have occurred. (The Power lamp flashes green and Alarm lamp flashes orange alternately.) ➔ Power Lamp Flashes Green and Alarm Lamp Flashes Orange Alternately Disconnect the USB cable between the machine and the PictBridge compliant device, turn off the machine, and unplug the power cord of the machine from the power supply. Plug the power cord of the machine back in, turn on the machine, and then reconnect the PictBridge compliant

device to the machine.
If the same error occurs, contact your Canon service representative.

[Page top](#) ↕

Advanced Guide

Advanced Guide > Troubleshooting > Cannot Print Properly from Photo Index Sheet (MP260 series)

Cannot Print Properly from a Photo Index Sheet (MP260 series)

• Check 1: Check the following when you cannot print from the Photo

Index Sheet.

- Is the Photo Index Sheet set in the correct position and orientation on the Platen Glass?
- Are the Platen Glass and the Photo Index Sheet dirty?
- Are all required circles on the Photo Index Sheet filled in?
- Is the circle for the number of copies to print for each photograph filled when you print with DPOF print?

Also check the error code on the LED and take the appropriate action.

➔ [An Error Code Is Displayed on the LED](#)



Note

- If the filled circles on the Photo Index Sheet are not dark or vast enough, the machine may not scan the settings.

• Check 2: The Photo Index Sheet is printed in an unintended language.

If the Photo Index Sheet is printed in an unintended language, reprint the sheet following the procedure below, then specify the language setting again.

1. Make sure that the machine is turned on, then load one sheet of A4 or letter sized plain paper.
2. Press the **Maintenance** button repeatedly until h appears on the LED.
3. Press the **Black** or **Color** button.
The Language Selection Sheet will be printed.
4. Mark your intended language on the Language Selection Sheet.
5. Load the Language Selection Sheet on the Platen Glass.
6. Press the **Maintenance** button repeatedly until n appears on the LED.
7. Press the **Black** or **Color** button.
Scanning the Language Selection Sheet starts.

[Page top](#) ↕

Advanced Guide

Advanced Guide > Troubleshooting > Cannot Remove a Memory Card (MP260 series)

Cannot Remove a Memory Card (MP260 series)

Contact your Canon service representative.

Important

- Never attempt to remove a memory card using a thin stick or tweezers. Doing so may damage the machine.

Note

- Exclusive adapters are required for the following memory cards. Insert these cards in the machine with adapters attached.
miniSD Card/miniSDHC Card/microSD Card/microSDHC Card/xD-Picture Card/xD-Picture Card Type M/xD-Picture Card Type H/Memory Stick Micro/RS-MMC (ver.4.1)

[Page top](#) 

Advanced Guide

Advanced Guide > Troubleshooting > Problems with Scanning

Problems with Scanning

- Scanner Does Not Work
- ScanGear (Scanner Driver) Does Not Start
- Error Message Appears and the ScanGear (Scanner Driver) Screen Does Not Appear
- Scan Quality (Image Displayed on the Monitor) Is Poor
- Scanned Image Is Surrounded by Extra White Areas
- Cannot Scan Properly with Multi Crop
- Slow Scanning Speed
- "There is not enough memory." Message Is Displayed
- Computer Stops Operating during Scanning
- Scanner Does Not Work After Upgrading Windows

[Top of Page↑](#)

Advanced Guide

[Advanced Guide](#) > [Troubleshooting](#) > [Problems with Scanning](#) > [Scanner Does Not Work](#)

Scanner Does Not Work

Check: Restart the computer.

[Top of Page](#)↑

Advanced Guide

[Advanced Guide](#) > [Troubleshooting](#) > [Problems with Scanning](#) > [ScanGear \(Scanner Driver\) Does Not Start](#)

ScanGear (Scanner Driver) Does Not Start

Check 1: Make sure that the MP Drivers are installed.

Insert the Setup CD-ROM into the computer's disc drive, then select Custom Install and install MP Drivers.

Check 2: On the File menu of the application, select **Select Source** and select the machine.



Important

- Do not select the model name that includes WIA in it.



Note

- The operation may differ depending on the application.

Check 3: Start from a TWAIN-compliant application.

[Top of Page](#)↑

Advanced Guide

Advanced Guide > Troubleshooting > Problems with Scanning > Error Message Appears and the ScanGear (Scanner Driver) Screen Does Not Appear

Error Message Appears and the ScanGear (Scanner Driver) Screen Does Not Appear

Check 1: Make sure that the machine is turned on.

Check 2: Connect the USB cable to a different USB port on the computer.

Check 3: If the USB cable is connected to a hub, remove it from the hub and connect it to a USB port on the computer.

Check 4: Make sure that the MP Drivers are installed.

If it is not installed, insert the "Setup CD-ROM" into the computer's disc drive, then select Custom Install and install MP Drivers.

Check 5: On the File menu of the application, select Select Source and select the machine.



Note

- The operation may differ depending on the application.

Check 6: Make sure that the application is TWAIN-compliant.

You cannot open ScanGear (scanner driver) from applications not supporting TWAIN.

Check 7: Exit ScanGear (scanner driver) if it is running on another application.

[Top of Page](#)↑

Advanced Guide

Advanced Guide > Troubleshooting > Problems with Scanning > Scan Quality (Image Displayed on the Monitor) Is Poor

Scan Quality (Image Displayed on the Monitor) Is Poor

Check 1: Increase the scanning resolution.

➔ [Resolution](#)

Check 2: Set the scale to 100%.

Some applications do not display images clearly if the image is too small.

Check 3: If moire (stripe pattern) appears, take the following measures and scan again.

- On the Basic Mode tab of ScanGear (scanner driver), select Magazine(Color) in Select Source.
- On the Advanced Mode tab of ScanGear (scanner driver), set Descreen in Image Settings to ON.
➔ [Image Settings](#)

Important

- If moire appears when you scan a digital print photo, take the above measures and scan again.

- If you use MP Navigator EX, set Document Type to Magazine(Color) or enable Descreen in the Scan Settings dialog box and scan again.
➔ [Scan Settings Dialog Box \(Photos/Documents\)](#)

Check 4: Check the monitor's color depth.

From the Start menu, select Control Panel > Appearance and Personalization > Adjust screen resolution to open the Display Settings dialog box. Set the color depth to Medium (16 bit) or Highest (32 bit).

• Windows XP:

From the Start menu, select Control Panel > Display to open the Display Properties dialog box. On the Settings tab, set the color depth to Medium (16 bit) or Highest (32 bit).

• Windows 2000:

From the Start menu, select Settings > Control Panel > Display to open the Display Properties dialog box. On the Settings tab, set Colors to High Color (16 bit) or True Color (32 bit).

Check 5: The Platen or Document Cover may be dirty.

Clean the parts by following the procedures in "[Cleaning the Exterior of the Machine.](#)"

Check 6: If the document is in poor condition (dirty, faded, etc.), use Reduce Dust and Scratches, Fading Correction, Grain Correction, etc. in Image Settings on the Advanced Mode tab of ScanGear (scanner driver).

➔ [Image Settings](#)

Check 7: If the color tone of images with consistent color tone (such as the sky) is different from the original document, take the following measures and scan again.

- On the Advanced Mode tab of ScanGear (scanner driver), set Auto Tone in Image Settings to OFF.
➔ [Image Settings](#)
- Open the Preferences dialog box from the Advanced Mode tab of ScanGear (scanner driver) and set Color Matching on the Color Settings tab.
➔ [Color Settings Tab](#)

[Top of Page](#)↑

Advanced Guide

[Advanced Guide](#) > [Troubleshooting](#) > [Problems with Scanning](#) > [Scanned Image Is Surrounded by Extra White Areas](#)

Scanned Image Is Surrounded by Extra White Areas

Check: Specify the scan area.

Click  (Auto Crop) in ScanGear (scanner driver) to automatically set the scan area for your document. You can also manually specify the scan area, for example when there are white margins along the document.

➔ [Adjusting Cropping Frames](#)

[Top of Page](#)↑

Advanced Guide

[Advanced Guide](#) > [Troubleshooting](#) > [Problems with Scanning](#) > [Cannot Scan Properly with Multi Crop](#)

Cannot Scan Properly with Multi Crop

Check 1: Make sure that the documents are placed correctly on the Platen.

➔ [Placing Documents](#)

Check 2: Scan each item individually without using Multi Crop.

Some applications do not support multiple image scanning.

[Top of Page](#)↑

Advanced Guide

[Advanced Guide](#) > [Troubleshooting](#) > [Problems with Scanning](#) > [Slow Scanning Speed](#)

Slow Scanning Speed

Check 1: To view the image on a monitor, set the output resolution to around 150 dpi. To print, set it to around 300 dpi.

➔ [Resolution](#)

Check 2: Disable Fading Correction, Grain Correction, etc.

➔ [Image Settings](#)

Check 3: In MP Navigator EX, deselect the Correct slanted document checkbox and scan again.

➔ [Scan Settings Dialog Box](#)

Check 4: In MP Navigator EX, deselect the Detect the orientation of text documents and rotate images checkbox and scan again.

➔ [Scan Settings Dialog Box](#)

[Top of Page](#)↑

Advanced Guide

[Advanced Guide](#) > [Troubleshooting](#) > [Problems with Scanning](#) > "There is not enough memory." Message Is Displayed

"There is not enough memory." Message Is Displayed

Check 1: Exit other applications and try again.

Check 2: Reduce the resolution or output size and scan again.

[Top of Page](#)↑

Advanced Guide

[Advanced Guide](#) > [Troubleshooting](#) > [Problems with Scanning](#) > [Computer Stops Operating during Scanning](#)

Computer Stops Operating during Scanning

Check 1: Restart the computer, reduce the output resolution in ScanGear (scanner driver) and scan again.

Check 2: Delete unnecessary files to obtain sufficient free hard disk space, then scan again.

Error message may appear when scanning a large document at high resolution.

Check 3: For Location of Temporary Files in MP Navigator EX, specify a folder on a drive with sufficient free space.

See "[Preferences Dialog Box](#)" for details.

Check 4: Multiple devices may be connected to USB ports.

Disconnect other devices.

[Top of Page](#)↑

Advanced Guide

[Advanced Guide](#) > [Troubleshooting](#) > [Problems with Scanning](#) > [Scanner Does Not Work After Upgrading Windows](#)

Scanner Does Not Work After Upgrading Windows

Check: Disconnect the machine from the computer, then uninstall and reinstall the MP Drivers and MP Navigator EX.

- **Step 1: Uninstall the MP Drivers.**

See "[Uninstalling the MP Drivers](#)" for details.

- **Step 2: Uninstall MP Navigator.**

1. From the Start menu, select (All) Programs > Canon Utilities > MP Navigator EX 2.0 > MP Navigator EX Uninstall.
2. When a confirmation appears, click Yes.
3. When uninstallation is complete, click OK.
MP Navigator EX is uninstalled.

- **Step 3: Reinstall the MP Drivers and MP Navigator EX.**

Insert the Setup CD-ROM into the computer's disc drive, then select Custom Install and reinstall the MP Drivers and MP Navigator EX.

[Top of Page](#)↑

Advanced Guide

Advanced Guide > Troubleshooting > Software Problems

Software Problems

- E-mail Software Program You Want to Use Does Not Appear in the Screen for Selecting an E-mail Software Program
- Scanned Image Is Printed Enlarged (Reduced)
- Scanned Image Is Enlarged (Reduced) on the Computer Monitor
- Scanned Image Does Not Open

[Top of Page↑](#)

Advanced Guide

[Advanced Guide](#) > [Troubleshooting](#) > [Software Problems](#) > E-mail Software Program You Want to Use Does Not Appear in the Screen for Selecting an E-mail Software Program

E-mail Software Program You Want to Use Does Not Appear in the Screen for Selecting an E-mail Software Program

Check 1: MP Navigator EX may not support the e-mail software program.

The following e-mail software programs are supported. (Image are attached to the mail message automatically.)

- Windows Mail (Windows Vista)
- Outlook Express (Windows 2000/XP)
- Microsoft Outlook
- EUDORA
- Netscape Mail

Check 2: If an e-mail software program does not operate properly, check that the program's MAPI is enabled.

To enable MAPI, refer to the manual of the e-mail software program.

Check 3: If using an e-mail software program other than the ones listed above, select None (Attach Manually) when prompted to select a program and attach the scanned image manually.

[Top of Page](#)↑

Advanced Guide

[Advanced Guide](#) > [Troubleshooting](#) > [Software Problems](#) > [Scanned Image Is Printed Enlarged \(Reduced\)](#)

Scanned Image Is Printed Enlarged (Reduced)

Check: Set the printing size in the application.

[Top of Page](#)↑

Advanced Guide

[Advanced Guide](#) > [Troubleshooting](#) > [Software Problems](#) > [Scanned Image Is Enlarged \(Reduced\) on the Computer Monitor](#)

Scanned Image Is Enlarged (Reduced) on the Computer Monitor

Check 1: Change the display setting in the application.

You cannot reduce the display size in Paint. To reduce the display size, open the images in an application that accompanies the machine.

For details, refer to the application's manual. If you have any questions, contact the manufacturer of the application.

Check 2: Change the resolution setting in ScanGear (scanner driver) and scan again.

The higher the resolution, the larger the resulting image will be.

➔ [Resolution](#)

[Top of Page](#)↑

Advanced Guide

[Advanced Guide](#) > [Troubleshooting](#) > [Software Problems](#) > [Scanned Image Does Not Open](#)

Scanned Image Does Not Open

Check: If the file format is not supported by the application, scan the image again and save it in a popular file format such as JPEG.

For details, refer to the application's manual. If you have any questions, contact the manufacturer of the application.

[Top of Page](#)↑

Advanced Guide

Advanced Guide > Troubleshooting > MP Navigator EX Problems

MP Navigator EX Problems

- Cannot Scan at the Correct Size
- Position or Size of the Image Cannot Be Detected Correctly When Scanning Using the Operation Panel
- Document Is Placed Correctly, but the Scanned Image Is Slanted
- Document Is Placed Correctly, but the Orientation Changes in the Scanned Image

[Top of Page↑](#)

Advanced Guide

[Advanced Guide](#) > [Troubleshooting](#) > [MP Navigator EX Problems](#) > [Cannot Scan at the Correct Size](#)

Cannot Scan at the Correct Size

Check 1: Make sure that the documents are placed correctly on the Platen.

➔ [Placing Documents](#)

Check 2: Set Document Size to the actual document size and scan again.

If the matching size is not found, scan at a larger size and trim the image.

See the Toolbar (Trimming) in "[Correct/Enhance Images Window](#)" for details.

[Top of Page](#)↑

Advanced Guide

[Advanced Guide](#) > [Troubleshooting](#) > [MP Navigator EX Problems](#) > [Position or Size of the Image Cannot Be Detected Correctly When Scanning Using the Operation Panel](#)

Position or Size of the Image Cannot Be Detected Correctly When Scanning Using the Operation Panel

Check 1: Make sure that the documents are placed correctly on the Platen.

➡ [Placing Documents](#)

Check 2: Check that the MP Navigator EX settings are correctly set according to the document.

➡ [Scanning Photos and Documents](#)

[Top of Page](#)↑

Advanced Guide

[Advanced Guide](#) > [Troubleshooting](#) > [MP Navigator EX Problems](#) > [Document Is Placed Correctly, but the Scanned Image Is Slanted](#)

Document Is Placed Correctly, but the Scanned Image Is Slanted

Check: In MP Navigator EX, deselect the Correct slanted document checkbox and scan again.

➔ [Scan Settings Dialog Box \(Photos/Documents\)](#)

[Top of Page](#)↑

Advanced Guide

[Advanced Guide](#) > [Troubleshooting](#) > [MP Navigator EX Problems](#) > Document Is Placed Correctly, but the Orientation Changes in the Scanned Image

Document Is Placed Correctly, but the Orientation Changes in the Scanned Image

Check: In MP Navigator EX, deselect the Detect the orientation of text documents and rotate images checkbox and scan again.

➔ [Scan Settings Dialog Box \(Photos/Documents\)](#)

[Top of Page](#)↑

Advanced Guide

Advanced Guide > Troubleshooting > FAQs

FAQs

- ➔ No Printing Results/Printing Is Blurred/Colors Are Wrong/White Streaks
- ➔ Machine Moves But Ink Is Not Ejected
- ➔ Cannot Install the MP Drivers
- ➔ Printing Does Not Start
- ➔ Copying/Printing Stops Before It Is Completed
- ➔  Writing Error/Output Error/Communication Error
- ➔ Print Results Not Satisfactory
- ➔ Paper Jams
- ➔ Paper Does Not Feed Properly

[Page top](#) ↑

Advanced Guide

Advanced Guide > Troubleshooting > If You Cannot Resolve the Problem

If You Cannot Resolve the Problem

If you cannot resolve the problem with any of the workarounds in this chapter, please contact the seller of the machine or a Canon service representative.

Canon support staff are trained to be able to provide technical support to satisfy customers.

Caution

- If the machine emits any unusual sound, smoke, or odor, turn it off immediately. Unplug the power cord from the outlet and contact the seller or your Canon service representative. Never attempt to repair or disassemble the machine yourself.
 - Attempts by customers to repair or take apart the machine will invalidate any warranty regardless of whether the warranty has expired.
-

Before contacting your Canon service representative, confirm the following:

- Product name:
 - * Your machine's name is located on the front cover of the setup manual.
- Serial number: please refer to the setup manual
- Details of the problem
- What you tried to solve the problem, and what happened

[Page top](#) ↕

Advanced Guide

Advanced Guide > Troubleshooting > Instructions for Use (Printer Driver)

Instructions for Use (Printer Driver)

This printer driver is subject to the following restrictions. Keep the following points in mind when using the printer driver.

Restrictions on the Printer Driver

- With some applications, the Copies setting in the Page Setup tab of the printer driver may not be enabled.
In this case, use the copies setting in the Print dialog box of the application software.
- If the selected Language in the About dialog box does not match the operating system interface language, the driver screen may not be displayed properly.
- Do not change the Advanced tab items of the printer properties. If you change any of the items, you will not be able to use the following functions correctly.
Also, if Print to file is selected in the Print dialog box of the application software and with applications that prohibit EMF spooling, such as Adobe Photoshop LE and MS Photo Editor, the following functions will not operate.
 - Preview before printing on the Main tab
 - Prevent loss of print data in the Print Options dialog box
 - Page Layout Printing, Poster Printing, Booklet Printing, Duplex Printing, Specify Margin..., Print from Last Page, Collate, and Stamp/Background... on the Page Setup tab
- Since the resolution in the preview display differs from the printing resolution, text and lines in the preview display may appear different from the actual print result.
- With some applications, the printing is divided into multiple print jobs.
To cancel printing, delete all divided print jobs.
- If image data is not printed correctly, display the Print Options dialog box from the Page Setup tab and change the setting of Disable ICM required from the application software. This may solve the problem.
- Software windows may not appear correctly on Windows Vista when fonts are set to Larger scale. If you want to display the windows with Larger scale fonts, set the desktop theme to Windows Classic as follows:
 1. Select Control Panel from the Start menu.
 2. Select Appearance and Personalization -> Personalization -> Theme.
The Theme Settings dialog box opens.
 3. At the Theme Settings dialog box, click the Themes tab, and select Windows Classic from Theme.
 4. Click OK.
Desktop changes to Windows Classic display.
- The card slot (memory card) of the machine may become inaccessible. In such cases, restart the machine or turn it off and reconnect the USB cable.

Points to Note with Applications

- There are following restrictions in Microsoft Word (Microsoft Corporation).
 - If Microsoft Word has the same printing functions as the printer driver, use Word to specify them.
 - When selecting Scaled Printing, Fit-to-Page Printing, or Page Layout Printing from the Page Layout list on the Page Setup tab, the selected printing function may not be effective, depending on the version of Word.
If this happens, follow the procedure below.
 1. Open Word's Print dialog box.
 2. Open the printer driver setup window, specify Page Layout on the Page Setup tab, and click OK.
 3. Without starting printing, close the Print dialog box.
 4. Open Word's Print dialog box again.
 5. Open the printer driver setup window again and click OK.
 6. Start printing.
- Illustrator/Adobe Systems Inc.
If Bitmap Printing takes effect, printing may take time or some data may not be printed. Print after

clearing the Bitmap Printing check box in the Print dialog box.

[Page top ↑](#)

Advanced Guide

Advanced Guide > Troubleshooting > General Notes (Scanner Driver)

General Notes (Scanner Driver)

ScanGear (scanner driver) is subject to the following restrictions. Keep these points in mind when using it.

Scanner Driver Restrictions

- When using the NTFS file system, the TWAIN data source may not be invoked. This is because the TWAIN module cannot be written to the winnt directory for security reasons. Contact the computer's administrator for help.
- Some computers (including laptops) connected to the machine may not resume correctly from standby mode. In that case, restart the computer.
- Do not connect two or more machine or multifunction printers with scanner function to the same computer simultaneously. If multiple scanning devices are connected, you cannot scan from the Operation Panel of the machine and also may experience errors while accessing the devices.
- Software screens may not appear correctly on Windows Vista when font size is set to Larger scale. If you want to display the screens with Larger scale fonts, change the theme in Appearance and Personalization to Windows Classic as follows:
 1. From the Start menu, select Control Panel.
 2. Select Appearance and Personalization > Personalization > Theme.
The Theme Settings dialog box opens.
 3. On the Theme tab of the Theme Settings dialog box, select Windows Classic under Theme.
 4. Click OK.
Desktop changes to Windows Classic view.
- Use the default display font size of the OS. Otherwise, software screens may not appear correctly.
- Scanning may fail if the computer has resumed from sleep or log-off state with ScanGear (scanner driver) active. In that case, follow these steps and scan again.
 1. Turn off the machine.
 2. Exit ScanGear (scanner driver), then disconnect the USB cable from the computer and reconnect it.
 3. Turn on the machine.
- ScanGear (scanner driver) cannot be opened in multiple applications at the same time. Within an application, ScanGear (scanner driver) cannot be opened for the second time when it is already open.
- Be sure to close the ScanGear (scanner driver) window before closing the application.
- Make sure that you have adequate disk space available when scanning large images at high resolutions. For example, at least 300 MB of free space is required to scan an A4 document at 600 dpi in full-color.

Applications with Restrictions on Use

- If you start Media Center included in Windows XP Media Center Edition 2005, you may not be able to scan using the Operation Panel of the machine. In that case, restart the computer.
- You cannot scan images with Media Center included in Windows Vista™ and Windows XP Media Center Edition 2005. Scan with other applications such as MP Navigator EX.
- In some applications, you may encounter a problem when you use Multi-Crop in the Advanced Mode tab of ScanGear (scanner driver). In that case, scan each document individually, changing Paper Size according to the document.
- In some applications, if you select the View scanned images checkbox in the Auto Scan Mode tab of ScanGear (scanner driver), the window displaying the thumbnails of the scanned images may close automatically.
- Some applications may not display the TWAIN user interface. In that case, refer to the application's manual and change the settings accordingly.
- Some applications do not support continuous scanning of multiple images. In some cases, only the

first scanned image is accepted, or multiple images are scanned as one image.

- When scanning platen size images into a Microsoft Office application (such as Word, Excel or PowerPoint), click Custom Insert in the Insert Picture from Scanner or Camera dialog box. Otherwise, images may not be scanned correctly.
- Images may not be scanned correctly in some applications. In that case, increase the operating system's virtual memory and retry.
- When image size is too large (such as when scanning large images at high resolution), your computer may not respond or the progress bar may remain at 0% depending on the application. In that case, cancel the action (for example by clicking Cancel on the progress bar), then increase the operating system's virtual memory or reduce the image size/resolution and retry. Alternatively, scan the image via MP Navigator EX first, then save and import it into the application.

[Top of Page](#)↑

Advanced Guide

Advanced Guide > Appendix

Appendix

- ➔ [Printing Area](#)
- ➔ [How to Detach/Attach the Document Cover](#)
- ➔ [Setting Up the Card Slot as the Memory Card Drive of the Computer \(MP260 series\)](#)
- ➔ [DPOF Print by Using the Photo Index Sheet \(MP260 series\)](#)
- ➔ [Deleting the Undesired Print Jobs](#)
- ➔ [Updating the MP Drivers](#)
- ➔ [Uninstalling the On-Screen Manuals](#)
- ➔ [Transporting and Storing the Machine](#)
- ➔ [Opening the Printer Properties Dialog Box \(Windows\)](#)
- ➔ [Opening the Page Setup and Print Dialog Box \(Macintosh\)](#)
- ➔ [Opening the Canon IJ Printer Utility \(Macintosh\)](#)
- ➔ [Connecting the Printer to the Network](#)

[Page top](#) ↕

Advanced Guide

Advanced Guide > Appendix > Printing Area

Printing Area

To ensure the best print quality, the machine allows a margin along each edge of media. The actual printable area will be the area inside these margins.

Recommended printing area : Canon recommends that you print within this area.

Printable area : The area where it is possible to print.

However, printing in this area can affect the print quality or the paper feed precision.

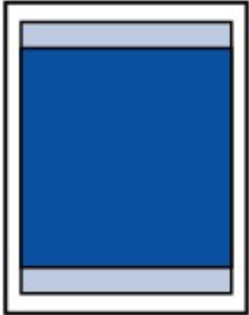

Note

■ Borderless Printing

- By selecting Borderless Printing option, you can make prints with no margins.
- When performing Borderless Printing, slight cropping may occur at the edges since the printed image is enlarged to fill the whole page.

For Borderless Printing, use the following paper.

- Glossy Photo Paper "Everyday Use" GP-501
- Photo Paper Glossy GP-502
- Photo Paper Plus Semi-Gloss SG-201
- Photo Paper Pro Platinum PT-101
- Photo Paper Plus Glossy II PP-201
- Photo Paper Pro II PR-201
- Matte Photo Paper MP-101

Performing Borderless Printing on any other type of paper may substantially reduce printing quality and/or result in printouts with altered color hues.

Borderless Printing on plain paper may result in printouts with reduced quality. Use them only for test printing.

- Depending on the type of paper, Borderless Printing may reduce the print quality at the top and bottom edges of the paper or cause these parts to become smudged.

➔ Letter, Legal

➔ Envelopes

➔ Other Sizes than Letter, Legal, Envelopes

[Page top](#) ↕

Advanced Guide

Advanced Guide > Appendix > Printing Area > Other Sizes than Letter, Legal, Envelops

Other Sizes than Letter, Legal, Envelops

Size	Printable Area (width x height)
A5	5.56 x 7.95 inches / 141.2 x 202.0 mm
A4	8.00 x 11.38 inches / 203.2 x 289.0 mm
B5	6.90 x 9.80 inches / 175.2 x 249.0 mm
4" x 6" / 10 x 15 cm	3.73 x 5.69 inches / 94.8 x 144.4 mm
4" x 8" / 10 x 20 cm	3.73 x 7.69 inches / 94.8 x 195.2 mm
5" x 7" / 13 x 18 cm	4.73 x 6.69 inches / 120.2 x 169.8 mm
8" x 10" / 2 x 25 cm	7.73 x 9.69 inches / 196.4 x 246.0 mm
Wide	3.73 x 6.80 inches / 94.8 x 172.6 mm

* This page size can be used only when printing from your computer.

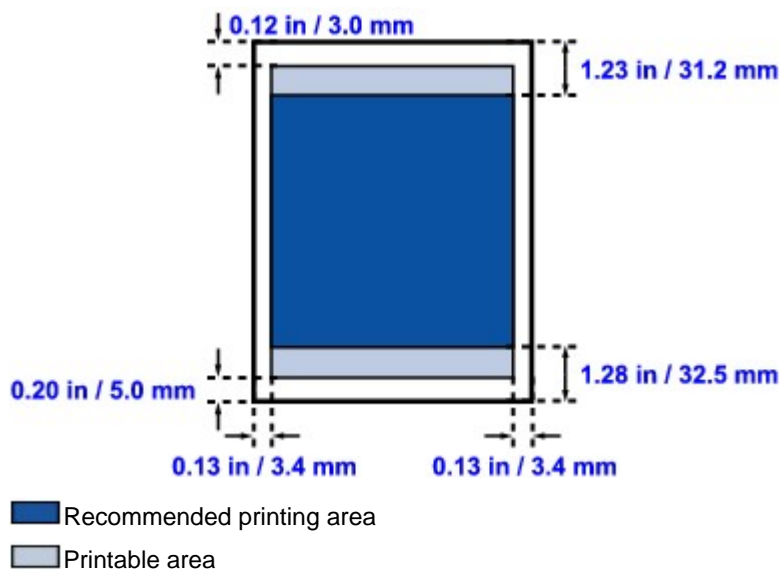

[Page top](#) ↕

Advanced Guide

Advanced Guide > Appendix > Printing Area > Letter, Legal

Letter, Legal

Size	Printable Area (width x height)
Letter	8.00 x 10.69 inches / 203.2 x 271.4 mm
Legal*	8.00 x 13.69 inches / 203.2 x 347.6 mm

* This page size can be used only when printing from your computer.

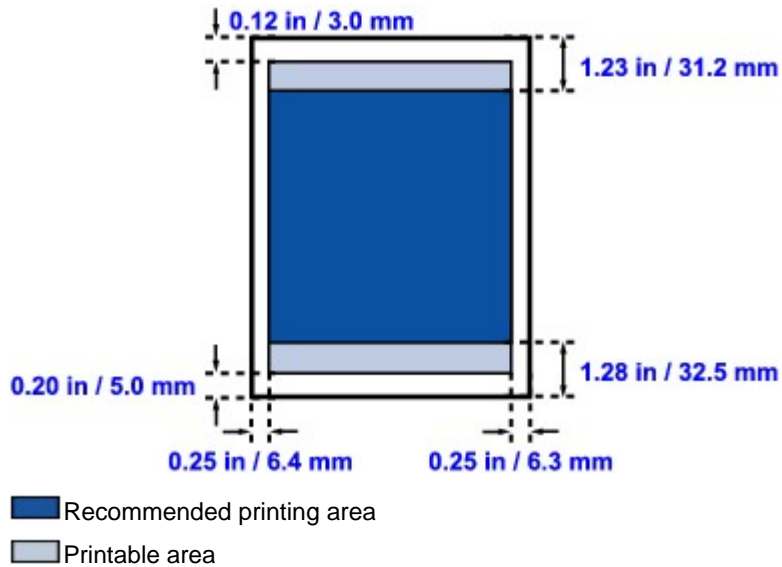

[Page top](#) ↕

Advanced Guide

Advanced Guide > Appendix > Printing Area > Envelopes

Envelopes

Size	Printable Area (width x height)
European DL*	4.06 x 7.12 inches / 103.2 x 180.8 mm
US Comm. Env. #10*	3.86 x 7.96 inches / 98.0 x 202.1 mm

* This page size can be used only when printing from your computer.

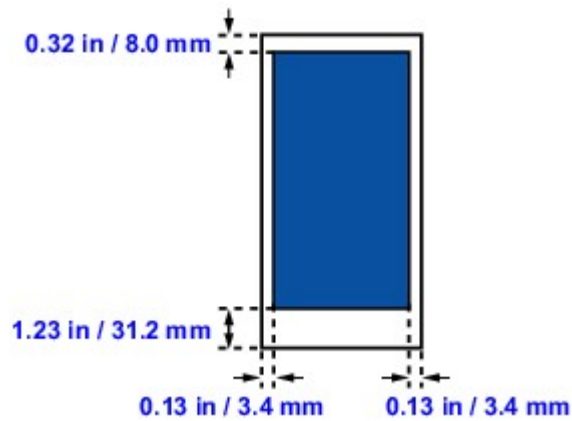

 Recommended printing area

[Page top](#) ↕

Advanced Guide

Advanced Guide > Appendix > How to Detach/Attach the Document Cover

How to Detach/Attach the Document Cover

- **Detaching the Document Cover:**

Hold up the Document Cover vertically.

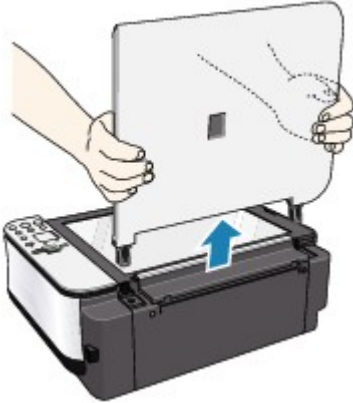

- **Attaching the Document Cover:**

Insert both hinges (A) of the Document Cover vertically into the holder (B) to attach the Document Cover as illustrated bellow.

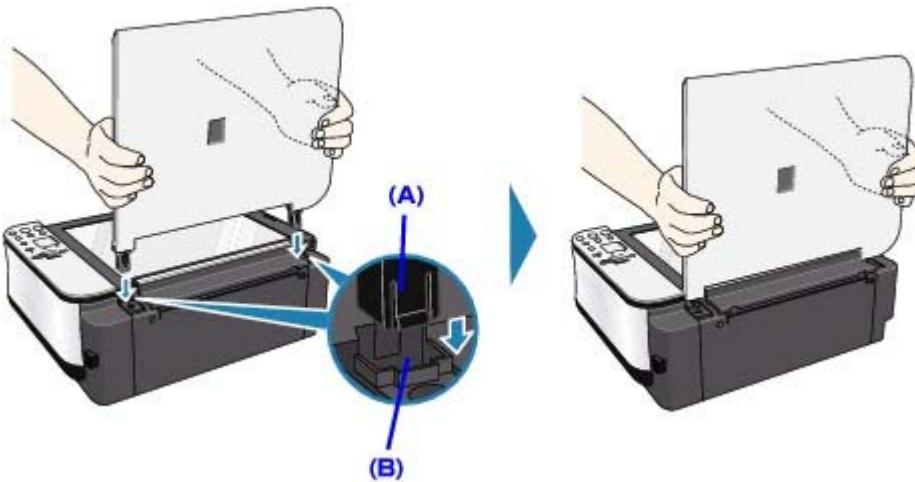

[Page top](#) ↕

Advanced Guide

Advanced Guide > Appendix > Setting Up the Card Slot as the Memory Card Drive of the Computer (MP260 series)

Setting Up the Card Slot as the Memory Card Drive of the Computer (MP260 series)

The Card Slot of the machine can also be used as the memory card drive of the computer.

Important

- When the read/write mode is selected by using the Operation Panel on the machine, card direct printing cannot be done. After using the Card Slot as the memory card drive of the computer, remove the memory card, and be sure to set the read/write attribute to the read-only mode. When you turned off the machine, the read/write mode will be canceled and the setting is returned to read-only mode when you turn on the machine next time.

1. Make sure that the memory card is not set.

If the memory card is set, remove it from the Card Slot. For details, refer to [Printing from a Memory Card \(MP260 series\)](#).

2. Press the **Maintenance** button repeatedly until c appears on the LED.

3. Specify the read/write attribute.

By pressing the **Color** button, the read-only mode is enabled.

The Card Slot is used only for reading. Be sure to select this mode when printing photos from a memory card.

By pressing the **Black** button and the read/write mode is enabled.

The Card Slot is used as the memory card drive of the computer. Photo data can be written into the memory card.

Important

- If you use the Card Slot as the memory card drive of the computer, you need to do a "safe removal" operation on your computer before physically removing the memory card from your machine.

- In Windows, right-click the  Removable Disk icon and click Eject. If Eject is not displayed on the screen, confirm that the **Access** lamp is not flashing and remove the memory card.

- On a Macintosh, drag the  Mount drive icon into the Trash.

[Page top](#) ↕

Advanced Guide

Advanced Guide > Appendix > DPOF Print by Using the Photo Index Sheet (MP260 series)

DPOF Print by Using the Photo Index Sheet (MP260 series)

Print out a Photo Index Sheet, select DPOF print, scan the sheet in, and you can print using DPOF settings stored in the memory card.

This section describes the DPOF Print function and the setting items of the Photo Index Sheet.

Note

- For information on how to print the Photo Index Sheet and to fill in the circle, refer to [Printing from a Memory Card \(MP260 series\)](#).

DPOF Print

If you have specified Digital Print Order Format (DPOF) settings on your digital camera, you can print using these settings. The machine supports the following DPOF functions.

Note

- DPOF is a standard format to record the specified information regarding images, such as which image or number of copies to print.
- If you scan the Photo Index Sheet with DPOF print though the photo saved on the memory card has no DPOF information, the error code E, 3, 4 is displayed on the LED.

Version:

Based on ver. 1.00

Supported image types:

CIFF, Exif (TIFF), and JFIF

Print Style Standard Print:

Prints photos that were specified as "Standard Print" with DPOF

Print Style Index Print:

Prints an index of photos that were specified as "Index Print" with DPOF using the machine's index printing layout

Print Style Multi-Image Print:

Prints a photo that was specified as "Multi-Image Print" with DPOF (with the specified number of copies and layout)

Print Photo Select:

Prints only photos specified with DPOF (cannot be specified from the Operation Panel)

Number of copies:

Prints the number of copies specified with DPOF (cannot be specified from the Operation Panel)

Setting Items of the Photo Index Sheet

You can select the following setting items on the Photo Index Sheet.

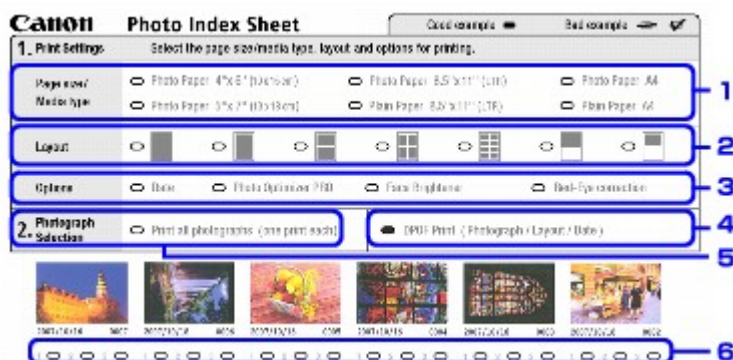

Important

- When you print with DPOF print, do not fill the circle to specify the number of copies or to print a copy of all photographs on the Photo Index Sheet.

If the circle is filled, the error E 3, 3 is displayed on the LED.

1. Select the page size and other printing formats.

When you select the paper type other than plain paper, the photo specified as Standard Print or Multi-Image Print with DPOF is printed in Borderless. When you select plain paper, the photo is printed in Bordered.

2. Even if you fill this circle, the layout setting is disregarded.

The photo is printed in the layout specified with DPOF.

3. Specify each advanced setting.

The date printing setting is specified with DPOF. If you print the index of photos that is specified as Index Print with DPOF, all advanced setting is disregarded.

4. Fill this circle to print with DPOF print.

5. If the circle is filled when you print with DPOF print, the error code E 3, 3 is displayed on the LED.

6. If the circle is filled when you print with DPOF print, the error code E 3, 3 is displayed on the LED.



Note

- Prints are automatically enlarged or reduced to match the page size. Edges of the photo may be clipped off depending on the page size.
- The shot date order setting by which photos are sorted follows that of DPOF.

[Page top](#)

Advanced Guide

Advanced Guide > Appendix > Deleting the Undesired Print Jobs

Deleting the Undesired Print Jobs

If the printer does not start printing, the print job data cancelled or failed may be remaining. Delete the undesired print job by using the Canon IJ Status Monitor.

1. Display the Canon IJ Status Monitor

Click the Status Monitor button displayed on the Task Bar.
The Canon IJ Status Monitor appears.

2. Display the print jobs

Click Display Print Queue....
The Print Queue window opens.

3. Delete the print jobs

Select Cancel All Documents from the Printer menu.
When the confirmation message appears, click Yes.

The print job is deleted.

Important

- Users who have not been granted access permission for printer management cannot delete the print job of another user.

[Page top](#) ↑

Advanced Guide

[Advanced Guide](#) > [Appendix](#) > [Updating the MP Drivers](#)

Updating the MP Drivers

- ➔ [Obtaining the Latest MP Drivers](#)
- ➔ [Uninstalling the MP Drivers](#)
- ➔ [Before Installing the MP Drivers](#)
- ➔ [Installing the MP Drivers](#)

[Page top](#) ↑

Advanced Guide

[Advanced Guide](#) > [Appendix](#) > [Updating the Printer Driver](#) > [Obtaining the Latest MP Drivers](#)

Obtaining the Latest MP Drivers

The MP Drivers include a printer driver and scanner driver (ScanGear).

By updating the MP Drivers to the latest version of the MP Drivers, unresolved problems may be solved.

Access our web site through the Internet and download the latest MP Drivers for your model.

Important

- You can download the MP Drivers for free, but any Internet access charges incurred are your responsibility.
- Before installing the latest MP Drivers, delete the previously installed version.
For information on how to delete the MP Drivers, refer to [Uninstalling the MP Drivers](#).

Related Topics

- [➔ Before Installing the MP Drivers](#)
- [➔ Installing the MP Drivers](#)

[Page top](#) ↑

Advanced Guide

Advanced Guide > Appendix > Updating the Printer Driver > Uninstalling the MP Drivers

Uninstalling the MP Drivers

The MP drivers you no longer use can be deleted.
When deleting the MP drivers, first exit all programs that are running.

The procedure to delete the unnecessary MP drivers is as follows:

If there is an uninstaller

1. Start the uninstaller

- In Windows Vista or Windows XP, select the Start menu -> All Programs -> "Your model name" -> MP Drivers Uninstaller.
- In Windows 2000, select the Start menu -> Programs -> "Your model name" -> MP Drivers Uninstaller.

The MP Drivers Uninstaller dialog box is displayed.

Important

- In Windows Vista, a confirmation/warning dialog box may appear when installing, uninstalling or starting software.
This dialog box appears when administrative rights are required to perform a task.
If you are logged on to an administrator account, click Continue or Allow to continue.
Some applications require an administrator account to continue. If you are logged on to a standard account, switch to an administrator account, and restart the operation from the beginning.

2. Execute the uninstaller

Click Execute. When the confirmation message appears, click Yes.
When all the files have been deleted, click Complete.
The deletion of the MP Drivers is completed.

Important

- Printer driver and scanner driver (ScanGear) will be deleted if you uninstall the MP Drivers.

If there is no uninstaller

If there is no uninstaller in the Start menu of Windows Vista, follow these steps:

1. Select the printer to be deleted

Select the Start menu -> Control Panel -> Hardware and Sound -> Printers.
Click the model to delete, then press the Alt key on your keyboard. On the File menu, click Delete.

2. Delete the printer

If the User Account Control dialog box appears, click Continue. Then when the confirmation message appears, click Yes.
The icon is deleted.

3. Select the printer driver to be deleted

Press the Alt key. On the File menu, select Run as administrator, and then click Sever Properties....
If the User Account Control dialog box appears, click Continue.
Click the Drivers tab. In the Installed printer drivers list, click the printer to delete.

4. Delete the printer driver

When you click Remove..., Remove Driver And Package dialog box is displayed.
Select Remove driver and driver package, and then click OK.
In the confirmation dialog box, click Yes.

When data collection is completed in the Remove Driver Package dialog box, click Delete.

5. Click OK.

The deletion of the printer driver is complete.

Important

- You may not be able to delete the printer driver properly from the Installed printer drivers list. If this happens, restart your computer, and try again.

[Page top](#) ↑

Advanced Guide

[Advanced Guide](#) > [Appendix](#) > [Updating the Printer Driver](#) > [Before Installing the MP Drivers](#)

Before Installing the MP Drivers

This section describes the items that you should check before installing the MP Drivers. You should also refer to this section if the MP Drivers cannot be installed.

Check the machine status

- Properly connect the personal computer and the machine. For details on connection instructions, refer to the "Install the Software" in the manual: Getting Started.
- Turn off the machine.

Check the Personal Computer Settings

- Terminate all running applications.
- In Windows Vista, log on as a user who has the administrator rights.
In Windows XP, log on as the computer administrator.
In Windows 2000, log on as a member of the Administrators group.



Note

- If an old version of the MP Drivers is already installed, first delete (uninstall) that version. For instructions on deleting the MP Drivers, see [Uninstalling the MP Drivers](#).
-

Related Topics

- ➔ [Obtaining the Latest MP Drivers](#)
- ➔ [Installing the MP Drivers](#)

[Page top](#) ↑

Advanced Guide

Advanced Guide > Appendix > Updating the Printer Driver > Installing the MP Drivers

Installing the MP Drivers

You can access our web site through the Internet and download the latest MP Drivers for your model.

The procedure for installing the downloaded MP Drivers is as follows:

1. Turn off the machine

Important

- If you turn on the computer while the machine is on, the Windows Plug and Play function is executed automatically, and the Found New Hardware window (Windows Vista) or Found New Hardware Wizard window (Windows XP, Windows 2000) is displayed. In this case, click Cancel.

2. Start the installer

Double-click the icon of the downloaded file.
The installation program starts.

Important

- In Windows Vista, a confirmation/warning dialog box may appear when installing, uninstalling or starting software.
This dialog box appears when administrative rights are required to perform a task.
If you are logged on to an administrator account, click Continue or Allow to continue.
Some applications require an administrator account to continue. If you are logged on to a standard account, switch to an administrator account, and restart the operation from the beginning.

3. Install the driver

At the Welcome window, click Next.
Read the contents of the License Agreement window. After checking the contents, click Yes.
Installation of the MP Drivers begins.

After the Installation Complete window is displayed, check that the machine and the computer are connected through a cable.

To select the connection port for your machine manually, check the Select printer port check box, and click Manual selection. At the Select printer port window, select the connection destination, and then click OK.

4. Complete the installation

Click Complete.
Turn on the machine, and wait awhile until the connection is recognized.

This procedure installs the MP Drivers.

Depending on the environment you are using, a message prompting you to restart the computer may be displayed. To complete the installation properly, restart the computer.

Important

- When you expand the downloaded compressed file, save the file to a folder such as "temp". Do not use the characters other than English in the folder name. Otherwise, the MP Drivers may not be installed correctly.
- You can download the MP Drivers for free, but any Internet access charges incurred are your responsibility.

Related Topics

➔ [Obtaining the Latest MP Drivers](#)

➔ [Before Installing the MP Drivers](#)

[Page top](#) ↑

Advanced Guide

Advanced Guide > Appendix > Uninstalling the On-Screen Manuals

Uninstalling the On-Screen Manuals

Follow the procedure below to uninstall all of the installed on-screen manuals from your computer.



All of the installed on-screen manuals will be deleted at the same time.

1. Click Start > All Programs (Programs in Windows 2000) > Canon XXX Manual (where "XXX" is your machine's name) > Uninstall.
2. Click OK when the confirmation message appears.



Note

- When the message prompting you to restart your computer is displayed, click OK to restart your computer.
-

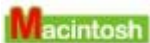

On-screen manuals other than printer driver's help and scanner driver's help are uninstalled at a time.

1. Select Applications on the Go menu.
2. Double-click the Canon Utilities folder, and then the IJ Manual folder.
3. Drag the folder of your machine's name into the trash.
4. Drag the  XXX On-screen Manual icon (where "XXX" is your machine name) on your desktop into the trash.

[Page top](#) 

Advanced Guide

Advanced Guide > Appendix > Transporting and Storing the Machine

Transporting and Storing the Machine

When relocating the machine or storing it for a long period of time, pack the machine using the original packing materials.

If you do not have the original packing materials, pack the machine carefully using protective material and place it inside a sturdy box.

Caution

- Do not transport or store the machine slanted, vertically, or upside-down, as the ink may leak and damage the machine.

1. Turn the machine off.
2. Confirm that the **Power** lamp is off and unplug the machine.

Important

- Do not unplug the machine while the **Power** lamp is lit or flashing green, as it may cause malfunction or damage to the machine, making the machine unable to print.

3. Retract the Paper Support and the Output Tray Extension, then close the Paper Output Tray.
4. Disconnect the printer cable from the computer and from the machine, and then disconnect the power plug from the machine.
5. Use adhesive tape to secure all the covers on the machine to keep them from opening during transportation. Then pack the machine in the plastic bag.
6. Attach the protective material to the machine when packing the machine.

Important

- Pack the machine with the FINE Cartridges left installed in the machine.

Note

- Clearly label the box as "FRAGILE" or "HANDLE WITH CARE".

[Page top](#) ↕

Advanced Guide

Advanced Guide > Appendix > Opening the Printer Properties Dialog Box (Windows)

Opening the Printer Properties Dialog Box (Windows)

The printer driver setup window can be displayed through the application software in use or the Start menu of the Windows.

Open the Printer Properties Dialog Box through the Application Software

Follow the procedure below to configure print settings when printing.

1. Select the command you perform printing on the application software in use.

In general, select Print on the File menu to open the Print dialog box.

2. Select your model name and click Preferences (or Properties).

The printer properties dialog box opens.



Note

- Opening the printer properties dialog box through Properties displays such tabs regarding the Windows functions as the Ports (or Advanced) tab. Those tabs do not appear when opening through Printing Preferences or application software. About tabs regarding Windows functions, refer to the user's manual for the Windows.

Open the Printer Properties Dialog Box through the Start Menu

Follow the procedure below to perform maintenance operations such as print head cleaning, or to configure print settings that are common for all application software.

1. Select items from the Start menu as shown below.

- In Windows Vista, select the Start menu > Control Panel > Hardware and Sound > Printers.
- In Windows XP, select the Start menu > Control Panel > Printers and Other Hardware > Printers and Faxes.
- In Windows 2000, select the Start menu > Settings > Printers.

2. Right-click your model name icon, and then select Printing Preferences from the displayed menu.

The printer properties dialog box opens.



Important

- Depending on application software you use, command names or menu names may vary and there may be more steps. For details, refer to the user's manual of your application software.

[Page top](#) ↕

Advanced Guide

Advanced Guide > Appendix > Opening the Page Setup and Print Dialog Box (Macintosh)

Opening the Page Setup and Print Dialog Box (Macintosh)

You can open the Page Setup dialog box and the Print dialog box from the application program you are using.

Opening the Page Setup Dialog Box

Open the Page Setup dialog box to specify page (paper) settings before printing.

- 1. Select Page Setup... on the File menu in your application program.**

The Page Setup dialog box opens.

Opening the Print Dialog Box

Open the Print dialog box to specify print settings before printing.

- 1. Select Print... on the File menu in your application program.**

The Print dialog box opens.

[Page top](#) ↕

Advanced Guide

Advanced Guide > Appendix > Opening the Canon IJ Printer Utility (Macintosh)

Opening the Canon IJ Printer Utility (Macintosh)

To open the Canon IJ Printer Utility, follow the procedure below.

In Mac OS X v.10.5.x

1. Select System Preferences on the Apple menu.
2. Click Print & Fax.
3. Select your machine's name in the Printers and click Open Print Queue....
The job list of your machine is displayed.
4. Click Utility.

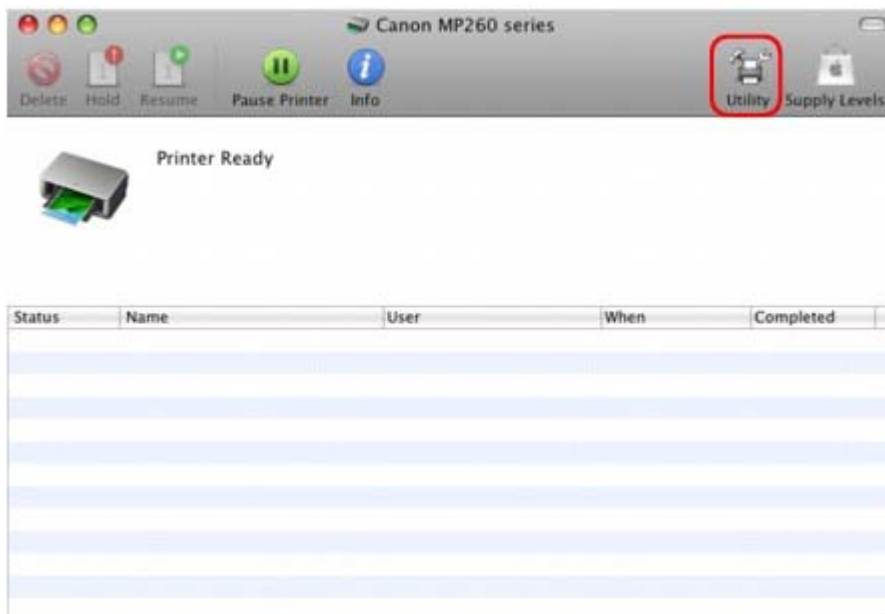

The **Printer List** opens.

5. Select your machine's name in the Product list and click Maintenance.

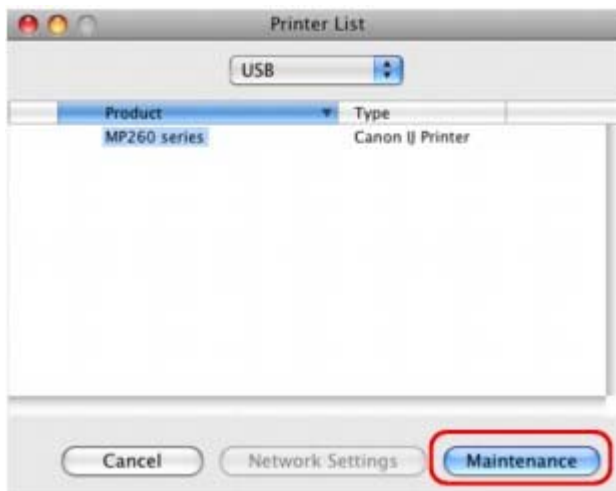

The Canon IJ Printer Utility starts up.

In Mac OS X v.10.4.x or Mac OS X v 10.3.9

1. Select Applications on the Go menu.
2. Double-click the Utilities folder, and then double-click the Printer Setup Utility icon.
The Printer List opens.
3. Select your machine's name in the Name list and click Utility.

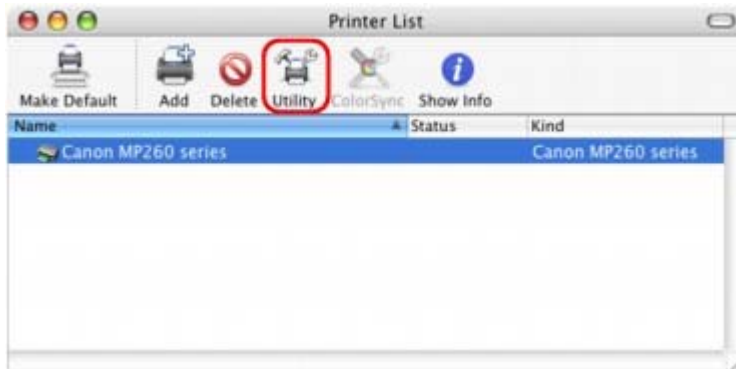

4. Select your machine's name in the Product list and click Maintenance.

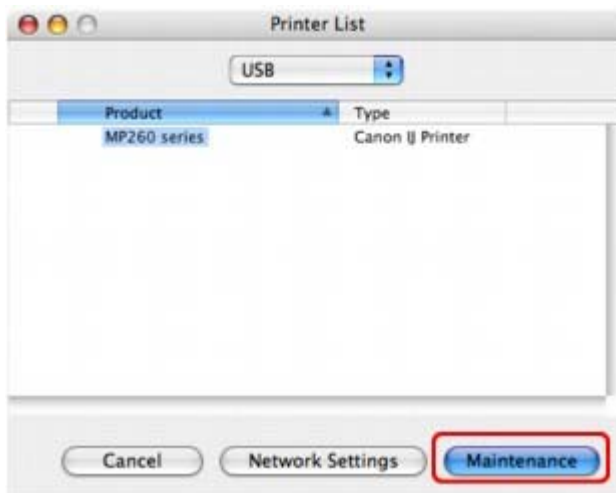

The Canon IJ Printer Utility starts up.

[Page top](#) ↕

Advanced Guide

Advanced Guide > Appendix > Connecting the Printer to the Network

Connecting the Printer to the Network

If multiple computers are being used in the network environment, you can share the printer connected to one computer with other computers.

The Windows versions of the computers connected to the network do not necessarily have to be the same.

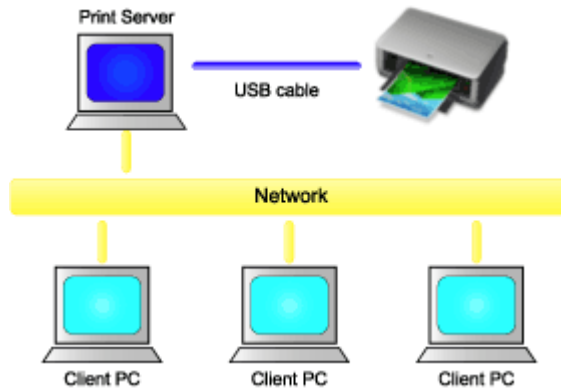

- **Settings on Print Server**

Describes the procedure for setting up a computer directly connected to a printer with a USB cable.

- **Settings on Client PC**

Describes the procedure for setting up those computers that will use this printer through the network.

When you execute print, the data is sent through the print server system to the printer.

Important

- In case an error occurred when a document is printed by the client system to a shared printer, the error message of Canon IJ Status Monitor will be displayed both on the client system and the print server system. For regular printing, Canon IJ Status Monitor will be displayed only on the client system.

Note

- Install the printer driver from the Setup CD-ROM that accompanies the machine on the print server system and each of the client systems according to the OS of each system.

Related Topic

➔ [Restrictions on Network Printing](#)



[Page top](#) ↑

Advanced Guide

Advanced Guide > Appendix > Connecting the Printer to the Network > Settings on Print Server

Settings on Print Server

To use a printer in a network, set printer sharing on the print server system.

The procedure for setting up the print server systems is as follows:

1. Install the printer driver on the print server system

For installation instructions, see the user's manual.

2. Select items from the Start menu as shown below:

- In Windows Vista, select the Start menu -> Control Panel -> Hardware and Sound -> Printers.
- In Windows XP, select the Start menu -> Control Panel -> Printers and Other Hardware -> Printers and Faxes.
- In Windows 2000, select the Start menu -> Settings -> Printers.

The Printers window (Windows Vista, Windows 2000) or Printers and Faxes window (Windows XP) is displayed.

3. Click the icon for the model name of printer to be shared

- In Windows Vista, press the Alt key on your keyboard and then select Run as administrator -> Sharing... from the displayed File menu.
- In Windows XP or Windows 2000, select Sharing... from the File menu.



Note

- Windows XP may display a message recommending the user to use the Network Setup Wizard to set up sharing. When this message appears, choose not to use the wizard and then set up sharing.

4. Set sharing

Select Share this printer (Windows Vista, Windows XP) or Shared as (Windows 2000) on the Sharing tab to set a shared name as desired, and click OK.



Important

- In Windows Vista, a confirmation/warning dialog box may appear when installing, uninstalling, or starting software. This dialog box appears when administrative rights are required to perform a task. If you are logged on to an administrator account, click Continue or Allow to continue. Some applications require an administrator account to continue. If you are logged on to a standard account, switch to an administrator account, and restart the operation from the beginning.

This completes the setup on the print server system. Next, set up the client systems.



[Page top](#) ↑

Advanced Guide

Advanced Guide > Appendix > Connecting the Printer to the Network > Settings on Client PC

Settings on Client PC

After setting up the print server system, set up the client system.

The procedure for setting up the client systems is as follows:

In Windows Vista

1. Install the printer driver on the client systems

Select Custom Install for the installation method.

For details on connection instructions, refer to the "Install the Software" in the manual: Getting Started.



Note

- During the installation, a screen prompting you to turn the printer on appears. Click Manual Selection and then select an appropriate port to complete your installation.

2. Start the wizard

Select the Start menu -> Network -> Add a printer.

The Add Printer window appears.

3. Add a printer

Select Add a network, wireless or Bluetooth printer, and click the icon for the printer that you have configured on the print server system to be shared, and then click Next.



Note

- If the icon for the printer is not displayed, check that the printer is actually connected to the print server.
- It may take some time for the icon for the printer to appear.

4. Complete the setup

Take the appropriate action as described on the screen and then click Finish.

The icon for the shared printer will be created in the Printers window.

This completes the setup on the client systems. You can now share the printer in the network.

In Windows XP/Windows 2000

1. Install the printer driver on the client systems

Select Custom Install for the installation method.

For details on connection instructions, refer to the "Install the Software" in the manual: Getting Started.



Note

- During the installation, a screen prompting you to turn the printer on appears. Click Manual Selection and then select an appropriate port to complete your installation.

2. Start the wizard

- In Windows XP, select the Start menu -> Control Panel -> Printers and Other Hardware -> Printers and Faxes -> Add a printer.

- In Windows 2000, select the Start menu -> Settings -> Printers -> Add a printer.

When Welcome to the Add Printer Wizard screen appears, click Next.

3. Add a printer

Select A network printer, or a printer attached to another computer (Windows XP) or Network printer (Windows 2000), then click Next.

On the Specify a Printer window (Windows XP) or Locate Your Printer window (Windows 2000), click Next and then search for the print server system.

Click the icon for the printer that you have configured on the print server system to be shared, and then click Next.

**Note**

- If the icon for the printer is not displayed, check that the printer is actually connected to the print server.

4. Complete the setup

Take the appropriate action as described on the screen and then click Finish.

The icon for the shared printer will be created in the Printers and Faxes window (Windows XP) or Printers window (Windows 2000).

This completes the setup on the client systems. You can now share the printer in the network.



[Page top](#) ↑

Advanced Guide

Advanced Guide > Appendix > Connecting the Printer to the Network > Restrictions on Network Printing

Restrictions on Network Printing

These are restrictions that apply if you are using a printer in a network environment. Check the restrictions for the environment you are using.

If you are sharing a printer in a network

- A print completion message may be displayed. To disable the message display, follow the procedure below.
 - **In Windows Vista:**
Press the Alt key from the Printers window on the client system. Open Run as administrator -> Server Properties... from the displayed File menu.
Uncheck Show informational notifications for network printers on the Advanced tab, and then restart the computer.
 - **In Windows XP or Windows 2000:**
Open Server Properties from the File menu of the Printer and Faxes window (Windows XP) or the Printers window (Windows 2000) on the print server system.
Uncheck Notify when remote documents are printed on the Advanced tab, and then restart the computer.
- The bi-directional communication function is disabled so that the correct printer status may not be recognized.
If a client user opens the printer driver properties and then clicks OK with the Enable bidirectional support check box on the Ports tab unchecked, the bi-directional function of the printer server system may also be disabled.
In this case, check Enable bidirectional support check box on both the print server system and the client system.
- When you print from a client system, you cannot use Canon IJ Preview.
- If the functions on the Maintenance tab cannot be set properly from a client system, they may be grayed out. In this case, change the settings from the print server.
When you change the settings of the print server, you should delete the icon of the shared printer from the client system, and then specify the shared settings again in the client system.

If the same printer driver is installed in the print server system and the client system as the local printer

- The net crawl function may automatically create a network printer icon on the client system.



[Page top](#) ↑

Advanced Guide

Advanced Guide > Using Easy-PhotoPrint EX

Using Easy-PhotoPrint EX

--- Transforming Your Photos into Creative Works of Art ---

Easy-PhotoPrint EX allows you to create albums, calendars and stickers easily using photos taken with digital cameras.

You can also print borderless photos easily.

Start Easy-PhotoPrint EX



Click Here: [Easy-PhotoPrint EX](#)



Note

- See the section below for details on how to use Easy-PhotoPrint EX.
 ➔ [Printing with the Bundled Application Software](#)

Create a Personalized Photo Album

Creating a personalized photo album is an easy task if you use Easy-PhotoPrint EX!

All you need to do is select which photos to use, select a layout, then load paper into your printer and print. After you bind the printed sheets, you'll have the one and only album of your memories!



You can change the layout and background, and attach comments to photos.



You can also select the size and orientation.

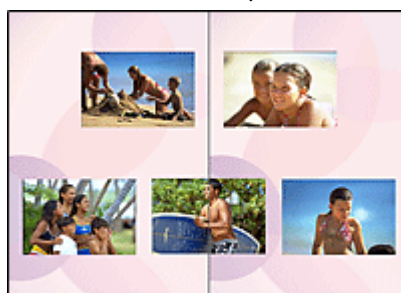

You can arrange a photo across the left and right pages.

CHECK!

Select a theme (background design) to create a single-themed album.

Decorate Items with Text and Frames

You can add text and frames to photos. Attach a description of the photo in an album, and add a frame to enhance the photo's atmosphere.



CHECK!

Select Album to add text and frames. You cannot decorate photos with Photo Print.

Create a Calendar Using Your Favorite Photos

Create calendars easily with Easy-PhotoPrint EX. Create your own calendar using your favorite photos! It'll be exciting to turn the calendar pages.



You can use all kinds of photos.

You can also create 2-month, 6-month and 12-month calendars.

Create Stickers

Create stickers easily with Easy-PhotoPrint EX!

Create stickers of your favorite photos and share them with your friends!



CHECK!

You can add text to photos.

[Page top](#)

Advanced Guide

Advanced Guide > Using MP Navigator EX

Using MP Navigator EX

MP Navigator EX is an application that enables you to easily scan photos and documents. It is suitable even for beginners.

Start MP Navigator EX



Click Here: [MP Navigator EX](#)

Scan Photos and Documents

You can scan easily by navigating through MP Navigator EX screens. You can also save/print scanned images using MP Navigator EX.



Scan Small Documents at One Time

You can scan multiple small documents (photos, cards, etc.) at one time. It is useful as you do not need to scan multiple times.

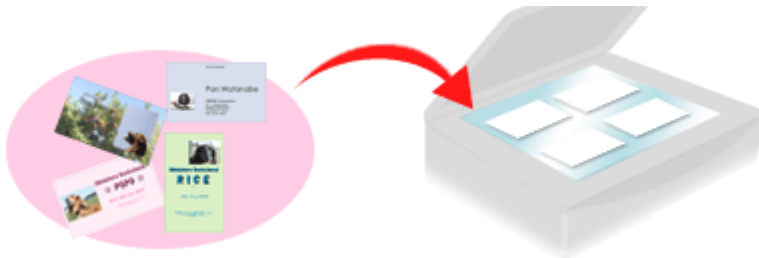

Scan Large Documents

You can easily scan documents that are larger than the Platen using MP Navigator EX. It allows you to scan the left and right halves of a document separately and combine them back into one image.



Scan with One-click

In One-click Mode, MP Navigator EX completes from scanning to saving, with a click of an icon. One-click Mode also allows you to scan and save images as PDF files or attach them to e-mail automatically.

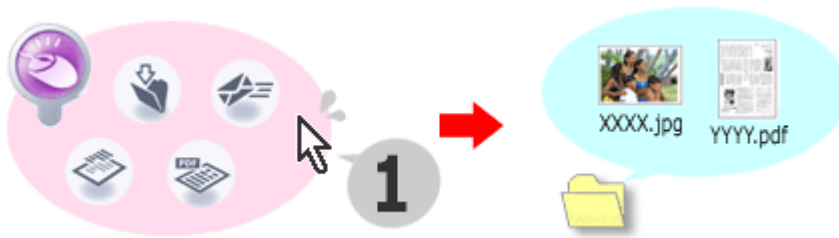

Scan and Correct/Enhance Photos

You can easily correct/enhance scanned photos using MP Navigator EX. You do not need to use other applications.

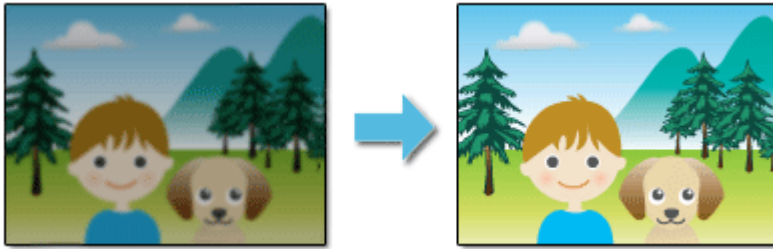

For details on how to use MP Navigator EX, refer to " Scanning with the Bundled Application Software ."

[Top of Page](#)

Advanced Guide

Advanced Guide > About Solution Menu

About Solution Menu

Quick Shortcut!! Solution Menu

Solution Menu is a menu window that provides quick access from your desktop to Canon applications, manuals, and online product information.

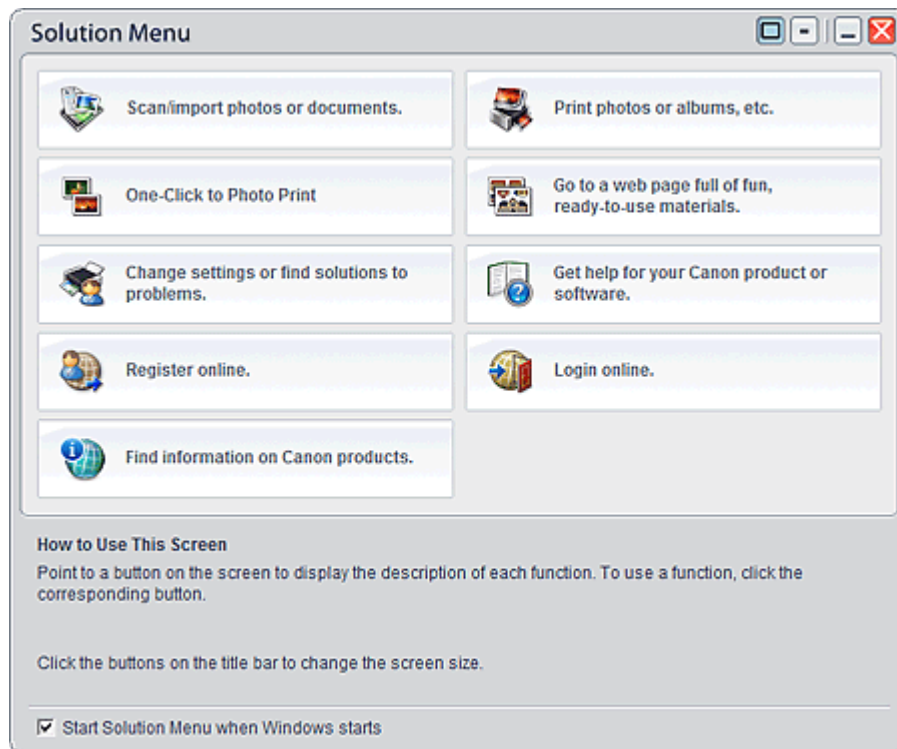

Important

- The number and types of buttons displayed in the window may vary depending on your printer and region.

Starting Solution Menu

 Click Here: [Solution Menu](#)

To start from desktop, see below.

Double-click the Solution Menu icon on the desktop. Alternatively, from the Start menu, select (All) Programs > Canon Utilities > Solution Menu > Solution Menu.



From the next time, Solution Menu starts when Windows starts.

If the Start Solution Menu when Windows starts checkbox at the bottom left of the window is not selected, Solution Menu does not start when Windows starts.

Important

- Solution Menu will start automatically when you install it using the Setup CD-ROM that accompanies the printer.

Changing the Window Size

Click  (window size: large) or  (window size: small) on the title bar to change the window size (large or small).

Solution Menu opens with the last used window size next time it is started.

- When screen size is small

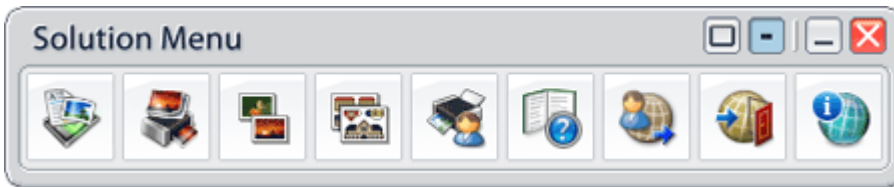

Starting an Application

1. Point to a button on the window to display the description of each application.
2. By clicking each button, the introduced application starts.
Follow the same steps to view the manuals or online product information.

Important

- Internet connection is required to access the online information. Internet connection fees apply.

Exiting Solution Menu

Click  (Close) on the title bar.

Restriction on Use of Solution Menu

This software is subject to the following restriction. Keep this point in mind when using it.

- All icons of the installed applications that support Solution Menu are displayed in the window. After the installation, you cannot rearrange the icons or delete only the icons.

[Page top](#) 

Free Manuals Download Website

<http://myh66.com>

<http://usermanuals.us>

<http://www.somanuals.com>

<http://www.4manuals.cc>

<http://www.manual-lib.com>

<http://www.404manual.com>

<http://www.luxmanual.com>

<http://aubethermostatmanual.com>

Golf course search by state

<http://golfingnear.com>

Email search by domain

<http://emailbydomain.com>

Auto manuals search

<http://auto.somanuals.com>

TV manuals search

<http://tv.somanuals.com>