



Controls, Operation, and Troubleshooting

with Microprocessor Controls and Electronic Expansion Valves

CONTENTS

	Page		Page
SAFETY CONSIDERATIONS	2	Unit Shutoff	48
GENERAL	2	Complete Unit Stoppage	48
MAJOR SYSTEM COMPONENTS	2-5	Single Circuit Stoppage	48
Processor Module	2	Lag Compressor Stoppage	48
Low-Voltage Relay Module	4	Restart Procedure	48
Electronic Expansion Valve Module	4	• POWER FAILURE EXTERNAL TO THE UNIT	
Options Module	4	Alarms and Alerts	48
Keypad and Display Module (Also Called HSIO or LID)	4	Compressor Alarm/Alert Circuit	50
Control Switch	4	Electronic Expansion Valve (EXV)	55
Electronic Expansion Valve (EXV)	4	• EXV OPERATION	
Thermostatic Expansion Valves (TXV)	4	• CHECKOUT PROCEDURE	
Sensors	5	Thermostatic Expansion Valve (TXV)	57
Compressor Protection Control Module (CPCS)	5	Thermistors	57
OPERATION DATA	5-46	• LOCATION	
Capacity Control	5	• THERMISTOR REPLACEMENT (T1, T2, T7, T8)	
Head Pressure Control	24	Pressure Transducers	60
• EXV UNITS		• TROUBLESHOOTING	
• TXV UNITS		• TRANSDUCER REPLACEMENT	
Pumpout	24	Control Modules	63
• EXV UNITS		• PROCESSOR MODULE (PSIO), 4IN/4OUT	
• TXV UNITS		MODULE (SIO), LOW-VOLTAGE RELAY	
Keypad and Display Module (Also Called HSIO or LID)	24	MODULE (DSIO-LV), AND EXV DRIVER	
• ACCESSING FUNCTIONS AND SUBFUNCTIONS		MODULE (DSIO-EXV)	
• AUTOMATIC DEFAULT DISPLAY		• RED LED	
• AUTOMATIC DISPLAY OPERATION/DEFAULT		• GREEN LED	
DISPLAY		• PROCESSOR MODULE (PSIO)	
• KEYPAD OPERATING INSTRUCTIONS		• LOW-VOLTAGE RELAY MODULE (DSIO)	
• STATUS FUNCTION		• 4IN/4OUT MODULE (SIO)	
• TEST FUNCTION		ACCESSORY UNLOADER INSTALLATION ...	64-68
• HISTORY FUNCTION		Installation	65
• SET POINT FUNCTION		• 040-110, 130 (60 Hz) UNITS	
• SERVICE FUNCTION		(And Associated Modular Units)	
• SCHEDULE FUNCTION		• 130 (50 Hz), 150-210 UNITS	
TROUBLESHOOTING	47-64	(And Associated Modular Units)	
Checking Display Codes	47	FIELD WIRING	69,70
		REPLACING DEFECTIVE PROCESSOR MODULE (PSIO)	70
		Installation	70

SAFETY CONSIDERATIONS

Installing, starting up, and servicing this equipment can be hazardous due to system pressures, electrical components, and equipment location (roof, elevated structures, etc.). Only trained, qualified installers and service mechanics should install, start up, and service this equipment.

When working on this equipment, observe precautions in the literature, and on tags, stickers, and labels attached to the equipment, and any other safety precautions that apply. Follow all safety codes. Wear safety glasses and work gloves. Use care in handling, rigging, and setting this equipment, and in handling all electrical components.

⚠ WARNING

Electrical shock can cause personal injury and death. Shut off all power to this equipment during installation and service. There may be more than one disconnect switch. Tag all disconnect locations to alert others not to restore power until work is completed.

⚠ WARNING

This unit uses a microprocessor-based electronic control system. *Do not* use jumpers or other tools to short out components, or to bypass or otherwise depart from recommended procedures. Any short-to-ground of the control board or accompanying wiring may destroy the electronic modules or electrical components.

GENERAL

IMPORTANT: This publication contains controls, operation and troubleshooting data for 30GN040-420 Flotronic™ II chillers.

Circuits are identified as circuits A and B, and compressors are identified as A1, A2, etc. in circuit A, and B1, B2, etc. in circuit B.

Use this guide in conjunction with separate Installation Instructions booklet packaged with the unit.

The 30G Series standard Flotronic II chillers feature microprocessor-based electronic controls and an electronic expansion valve (EXV) in *each* refrigeration circuit.

NOTE: The 30GN040 and 045 chillers with a factory-installed brine option have thermal expansion valves (TXV) instead of the EXV.

Unit sizes 230-420 are modular units which are shipped as separate sections (modules A and B). Installation instructions specific to these units are shipped inside the individual modules. See Table 1 for a listing of unit sizes and modular combinations. For modules 230B-315B, follow all general instructions as noted for unit sizes 080-110. For all remaining modules, follow instructions for unit sizes 130-210.

Table 1 — Unit Sizes and Modular Combinations

UNIT MODEL 30GN	NOMINAL TONS	SECTION A UNIT 30GN	SECTION B UNIT 30GN
040	40	—	—
045	45	—	—
050	50	—	—
060	60	—	—
070	70	—	—
080	80	—	—
090	90	—	—
100	100	—	—
110	110	—	—
130	125	—	—
150	145	—	—
170	160	—	—
190	180	—	—
210	200	—	—
230	220	150	080
245	230	150	090
255	240	150	100
270	260	170	100
290	280	190	110
315	300	210	110
330	325	170	170
360	350	190	190/170*
390	380	210	190
420	400	210	210

*60 Hz units/50 Hz units.

The Flotronic II control system cycles compressor unloaders and/or compressors to maintain the selected leaving fluid temperature set point. It automatically positions the EXV to maintain the specified refrigerant superheat entering the compressor cylinders. It also cycles condenser fans on and off to maintain suitable head pressure for each circuit. Safeties are continuously monitored to prevent the unit from operating under unsafe conditions. A scheduling function, programmed by the user, controls the unit occupied/unoccupied schedule. The control also operates a test program that allows the operator to check output signals and ensure components are operable.

The control system consists of a processor module (PSIO), a low-voltage relay module (DSIO-LV), 2 EXVs, an EXV driver module (DSIO-EXV), a 6-pack relay board, a keypad and display module (also called HSIO or LID), thermistors, and transducers to provide inputs to the microprocessor. A standard options module (SIO) is used to provide additional functions. See Fig. 1 for a typical 30GN Control Panel.

MAJOR SYSTEM COMPONENTS

Processor Module — This module contains the operating software and controls the operation of the machine. It continuously monitors information received from the various transducers and thermistors and communicates with the relay modules and 6-pack relay board to increase or decrease the active stages of capacity. The processor module

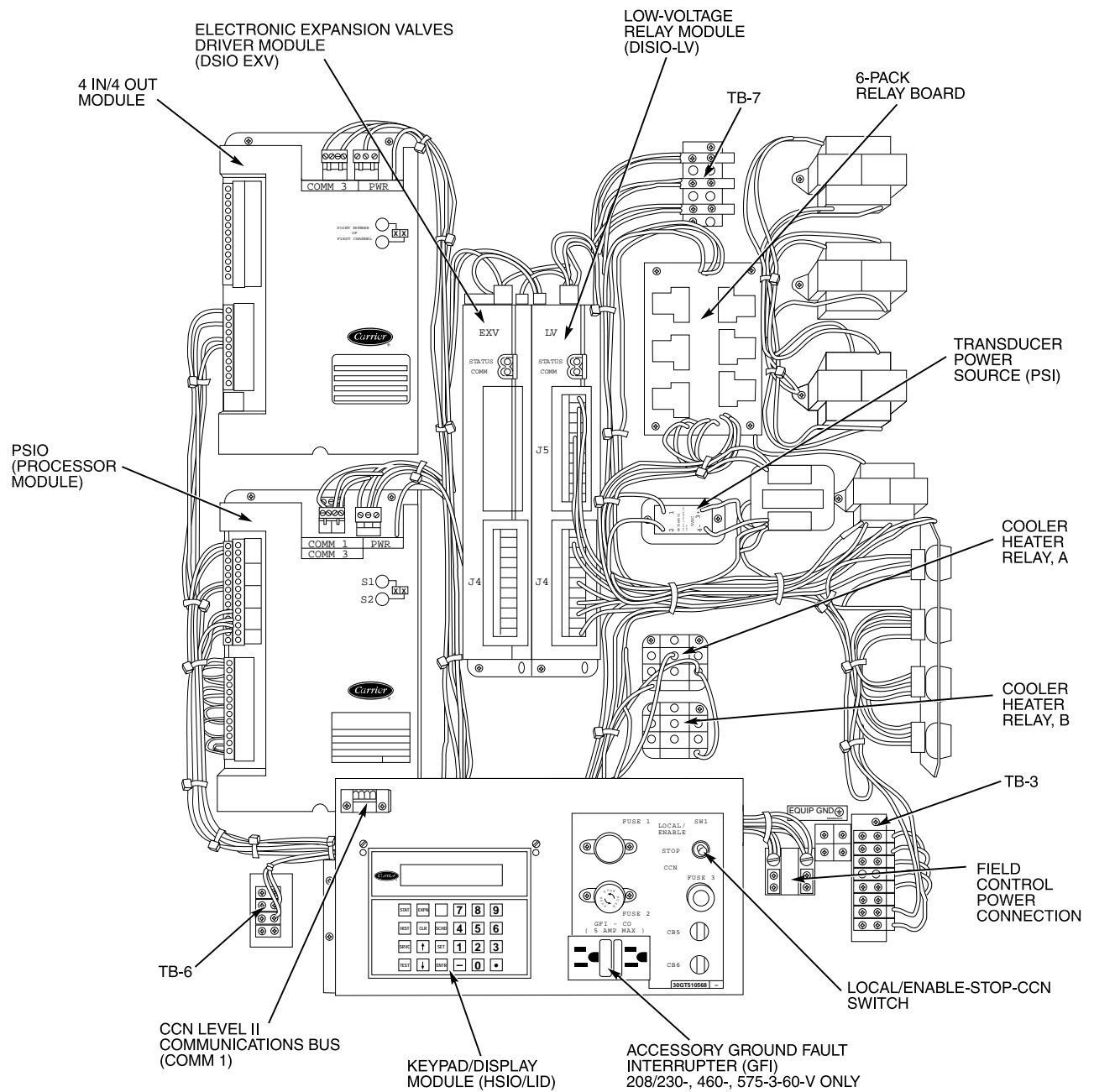

LEGEND

- CCN** — Carrier Comfort Network
- TB** — Terminal Block

Fig. 1 — 30GN Control Panel (040-110 Unit Shown)

Table 2 — LOCAL/ENABLE-STOP-CCN Switch Positions and Operation

SWITCH POSITION	UNIT OPERATION	CONFIGURATION AND SET POINT CONTROL	
		Keypad Control	CCN Control
STOP	Unit Cannot Run	Read/Write	Read Only
LOCAL/ENABLE	Unit Can Run	Read/Limited Write	Read Only
CCN Stop —	Unit Cannot Run	Read Only	Read/Write
Run —	Unit Can Run	Read Only	Read/Limited Write

In the CCN position, the chiller is under remote control and responds only to CCN network commands. The occupied/unoccupied conditions are defined by the network. All keypad and display functions can be read at the chiller regardless of position of the switch.

CCN run or stop condition is established by a command from the CCN network. It is not possible to force outputs from the CCN network, except that an emergency stop command shuts down the chiller immediately and causes “ALARM 52” to be displayed.

Electronic Expansion Valve (EXV) — The microprocessor controls the EXV (if so equipped) through the EXV driver module. Inside the expansion valve is a linear actuator stepper motor.

The lead compressor in each circuit has a thermistor and a pressure transducer located in the suction manifold after the compressor motor. The thermistor measures the temperature of the superheated gas entering the compressor cylinders. The pressure transducer measures the refrigerant pressure in the suction manifold. The microprocessor converts the pressure reading to a saturated temperature. The difference between the temperature of the superheated gas and the saturation temperature is the superheat. The microprocessor controls the position of the electronic expansion valve stepper motor to maintain 30 F (17 C) superheat.

At initial unit start-up, the EXV position is at zero. After that, the microprocessor keeps accurate track of the valve position in order to use this information as input for the other control functions. The control monitors the superheat and the rate of change of superheat to control the position of the valve. The valve stroke is very large, which results in very accurate control of the superheat.

Thermostatic Expansion Valves (TXV) — Model 30GN040 and 045 units with factory-installed brine option are equipped with conventional thermostatic expansion valves with liquid line solenoids. The liquid line solenoid valves are not intended to be a mechanical shut-off. When service is required, use the liquid line service valve to pump down the system.

also controls the EXV driver module (as appropriate), commanding it to open or close each EXV in order to maintain the proper superheat entering the cylinders of each lead compressor. Information is transmitted between the processor module and relay module, the EXV driver module, and the keypad and display module through a 3-wire communications bus. The options module is also connected to the communications bus.

For the Flotronic™ II chillers, the processor monitors system pressure by means of 6 transducers, 3 in each lead compressor. Compressor suction pressure, discharge pressure, and oil pressure are sensed. If the processor senses high discharge pressure or low suction pressure, it immediately shuts down all compressors in the affected circuit. During operation, if low oil pressure is sensed for longer than one minute, all compressors in the affected circuit are shut down. At start-up, the oil pressure signal is ignored for 2 minutes. If shut-down occurs due to any of these pressure faults, the circuit is locked out and the appropriate fault code is displayed.

Low-Voltage Relay Module — This module closes contacts to energize compressor unloaders and/or compressors. It also senses the status of the safeties for all compressors and transmits this information to the processor.

Electronic Expansion Valve Module (If So Equipped) — This module receives signals from the processor and operates the electronic expansion valves.

Options Module — This module allows the use of Flotronic II features such as dual set point, remote reset, demand limit, hot gas bypass, and accessory unloaders. The options module also allows for reset and demand limit to be activated from a remote 4-20 mA signal. The options module is installed at the factory.

Keypad and Display Module (Also Called HSI0 or LID) — This device consists of a keypad with 6 function keys, 5 operative keys, 12 numeric keys, and an alphanumeric 8-character LCD (liquid crystal display). Key usage is explained in Accessing Functions and Subfunctions section on page 24.

Control Switch — Control of the chiller is defined by the position of the LOCAL/ENABLE-STOP-CCN switch. This is a 3-position manual switch that allows the chiller to be put under the control of its own Flotronic II controls, manually stopped, or put under the control of a Carrier Comfort Network (CCN). Switch allows unit operation as shown in Table 2.

In the LOCAL/ENABLE position, the chiller is under local control and responds to the scheduling configuration and set point data input at its own local interface device (keypad and display module).

The TXV is set at the factory to maintain approximately 8 to 12° F (4.4 to 6.7° C) suction superheat leaving the cooler by monitoring the proper amount of refrigerant into the cooler. All TXVs are adjustable, *but should not be adjusted unless absolutely necessary*. When TXV is used, thermistors T7 and T8 are not required.

The TXV is designed to limit the cooler saturated suction temperature to 55 F (12.8 C). This makes it possible for unit to start at high cooler fluid temperatures without overloading the compressor.

Sensors — The Flotronic™ II chiller control system gathers information from sensors to control the operation of the chiller. The units use 6 standard pressure transducers and 4 standard thermistors to monitor system pressures and temperatures at various points within the chiller. Sensors are listed in Table 3.

Table 3 — Thermistor and Transducer Locations

THERMISTORS	
Sensor	Location
T1	Cooler Leaving Fluid Temp
T2	Cooler Entering Fluid Temp
T7	Compressor Suction Gas Temp Circuit A
T8	Compressor Suction Gas Temp Circuit B
T10	Remote Temperature Sensor (Accessory)
PRESSURE TRANSDUCERS	
Sensor	Location
DPT-A	Compressor A1 Discharge Pressure
SPT-A	Compressor A1 Suction Pressure
OPT-A	Compressor A1 Oil Pressure
DPT-B	Compressor B1 Discharge Pressure
SPT-B	Compressor B1 Suction Pressure
OPT-B	Compressor B1 Oil Pressure

Compressor Protection Control Module (CPCS)

— Each compressor on models 30GN070 (50 Hz), 080-110, and 230B-315B, has its own CPCS as standard equipment. See Fig. 2. All 30GN040-060 and 070 (60 Hz) units feature the CPCS as an accessory, and CR (control relay) as standard equipment. The 30GN130-210 and associated modular units have a CR as standard equipment. The CPCS or CR is used to control and protect the compressors and crankcase heaters. The CPCS provides the following functions:

- compressor contactor control
- crankcase heater control
- compressor ground current protection
- status communication to processor board
- high-pressure protection

The CR provides all of the same functions as the CPCS with the exception of compressor ground current protection. Ground current protection is accomplished by using a CGF (compressor ground fault module) in conjunction with the CR. The CGF (See Fig. 3) provides the same ground fault function as the CPCS for units where the CPCS is not utilized.

One large relay is located on the CPCS board. This relay (or CR) controls the crankcase heater and compressor contactor. The CPCS also provides a set of signal contacts that the microprocessor monitors to determine the operating status of the compressor. If the processor board determines that the compressor is not operating properly through the signal contacts, it will lock the compressor off by deenergizing the proper 24-v control relay on the relay board. The CPCS board contains logic that can detect if the current-to-

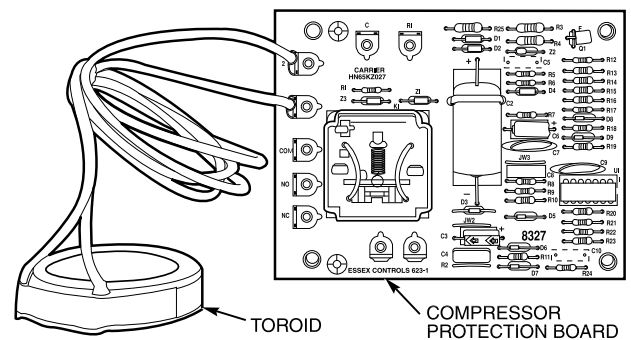

Fig. 2 — Compressor Protection Control Module

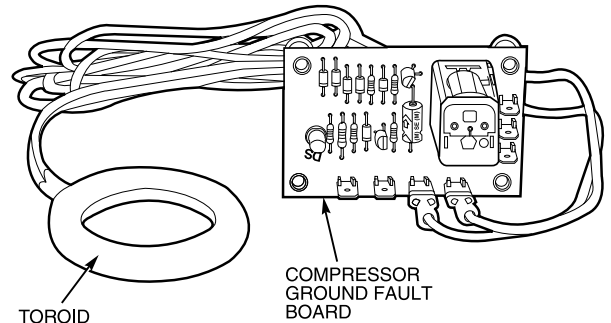

Fig. 3 — Compressor Ground Fault Module

ground of any compressor winding exceeds 2.5 amps. If this condition occurs, the CPCS module shuts down the compressor.

A high-pressure switch with a trip pressure of 426 ± 7 psig (2936 ± 48 kPa), is wired in series with the CPCS. If this switch opens during operation, the compressor stops and the failure is detected by the processor when the signal contacts open. The compressor is locked off. If the lead compressor in either circuit is shut down by the high-pressure switch or ground current protector, *all* compressors in the circuit are locked off.

OPERATION DATA

Capacity Control — The control system cycles compressor to give capacity control steps as shown in Tables 4A-4C. The unit controls leaving chilled fluid temperature. Entering fluid temperature is used by the microprocessor in determining the optimum time to add or subtract steps of capacity, but is not a control set point.

The chilled fluid temperature set point can be automatically reset by the return temperature reset or space and outdoor-air temperature reset features. It can also be reset from an external 4 to 20 mA signal, or from a network signal.

The operating sequences shown are some of many possible loading sequences for the control of the leaving fluid temperature. If a circuit has more unloaders than another, that circuit will always be the lead circuit.

Table 4A — Capacity Control Steps, 040-070

UNIT 30GN	CONTROL STEPS	LOADING SEQUENCE A		LOADING SEQUENCE B	
		% Displacement (Approx)	Compressors	% Displacement (Approx)	Compressors
040 (60 Hz) A1†,B1	1	25	A1*	—	—
	2	50	A1	—	—
	3	75	A1*, B1	—	—
	4	100	A1,B1	—	—
040 (60 Hz) A1†,B1**	1	25	A1*	25	B1*
	2	50	A1	50	B1
	3	75	A1*,B1	75	A1,B1*
	4	100	A1,B1	100	A1,B1
040 (50 Hz) 045 (60 Hz) A1†,B1	1	24	A1*	—	—
	2	47	A1	—	—
	3	76	A1*,B1	—	—
	4	100	A1,B1	—	—
040 (50 Hz) 045 (60 Hz) A1†,B1**	1	24	A1*	37	B1*
	2	47	A1	53	B1
	3	61	A1*,B1*	61	A1*,B1*
	4	76	A1*,B1	84	A1,B1*
	5	100	A1,B1	100	A1,B1
040 (50 Hz) 045 (60 Hz) A1†,B1**	1	—	—	21	B1††
	2	—	—	37	B1*
	3	—	—	53	B1
	4	—	—	68	A1,B1††
	5	—	—	84	A1,B1*
	6	—	—	100	A1,B1
045 (50 Hz) 050 (60 Hz) A1†,B1	1	31	A1*	—	—
	2	44	A1	—	—
	3	87	A1*,B1	—	—
	4	100	A1,B1	—	—
045 (50 Hz) 050 (60 Hz) A1†,B1**	1	31	A1*	38	B1*
	2	44	A1	56	B1
	3	69	A1*,B1*	69	A1*,B1*
	4	87	A1*,B1	82	A1,B1*
	5	100	A1,B1	100	A1,B1
045 (50 Hz) 050 (60 Hz) A1†**,B1	1	18	A1††	—	—
	2	31	A1*	—	—
	3	73	A1††,B1	—	—
	4	87	A1*,B1	—	—
	5	100	A1,B1	—	—
045 (50 Hz) 050 (60 Hz) A1†**,B1**	1	18	A1††	—	—
	2	31	A1*	—	—
	3	44	A1	—	—
	4	56	A1††,B1*	—	—
	5	73	A1††,B1	—	—
	6	87	A1*,B1	—	—
	7	100	A1,B1	—	—
045 (50 Hz) 050 (60 Hz) A1†,B1**	1	—	—	20	B1††
	2	—	—	38	B1*
	3	—	—	56	B1
	4	—	—	51	A1*,B1††
	5	—	—	64	A1,B1††
	6	—	—	82	A1,B1*
	7	—	—	100	A1,B1

*Unloaded compressor.

†Compressor unloader, standard.

**Compressor unloader(s), accessory.

††Two unloaders, both unloaded.

Table 4A — Capacity Control Steps, 040-070 (cont)

UNIT 30GN	CONTROL STEPS	LOADING SEQUENCE A		LOADING SEQUENCE B	
		% Displacement (Approx)	Compressors	% Displacement (Approx)	Compressors
045 (50 Hz) 050 (60 Hz) A1†**,B1**	1	18	A1††	20	B1††
	2	31	A1*	38	B1*
	3	44	A1	56	B1
	4	56	A1††,B1*	64	A1,B1††
	5	73	A1††,B1	82	A1,B1*
	6	87	A1*,B1	100	A1,B1
	7	100	A1,B1	—	—
050 (50 Hz) 060 (60 Hz) A1†,B1	1	28	A1*	—	—
	2	42	A1	—	—
	3	87	A1*,B1	—	—
	4	100	A1,B1	—	—
050 (50 Hz) 060 (60 Hz) A1†,B1**	1	28	A1*	38	B1*
	2	42	A1	58	B1
	3	67	A1*,B1*	67	A1*,B1*
	4	87	A1*,B1	80	A1,B1*
	5	100	A1,B1	100	A1,B1
050 (50 Hz) 060 (60 Hz) A1†**,B1	1	15	A1††	—	—
	2	28	A1*	—	—
	3	73	A1††,B1	—	—
	4	87	A1*,B1	—	—
	5	100	A1,B1	—	—
050 (50 Hz) 060 (60 Hz) A1†**,B1**	1	15	A1††	—	—
	2	28	A1*	—	—
	3	42	A1	—	—
	4	53	A1,B1*	—	—
	5	73	A1††,B1	—	—
	6	87	A1*,B1	—	—
	7	100	A1,B1	—	—
050 (50 Hz) 060 (60 Hz) A1†,B1**	1	—	—	18	B1††
	2	—	—	38	B1*
	3	—	—	58	B1
	4	—	—	60	A1,B1††
	5	—	—	80	A1,B1*
	6	—	—	100	A1,B1
050 (50 Hz) 060 (60 Hz) A1†**,B1**	1	15	A1††	18	B1††
	2	28	A1*	38	B1*
	3	42	A1	58	B1
	4	53	A1††,B1*	60	A1,B1††
	5	73	A1††,B1	80	A1,B1*
	6	87	A1*,B1	100	A1,B1
	7	100	A1,B1	—	—
060 (50 Hz) 070 (60 Hz) A1†,B1	1	33	A1*	—	—
	2	50	A1	—	—
	3	83	A1*,B1	—	—
	4	100	A1,B1	—	—
060 (50 Hz) 070 (60 Hz) A1†,B1**	1	33	A1*	33	B1*
	2	50	A1	50	B1
	3	67	A1*,B1*	66	A1*,B1*
	4	83	A1*,B1	83	A1,B1*
	5	100	A1,B1	100	A1,B1
060 (50 Hz) 070 (60 Hz) A1†**,B1	1	16	A1††	—	—
	2	33	A1*	—	—
	3	66	A1††,B1	—	—
	4	83	A1*	—	—
	5	100	A1,B1	—	—
060 (50 Hz) 070 (60 Hz) A1†**,B1**	1	16	A1††	—	—
	2	33	A1*	—	—
	3	50	A1	—	—
	4	66	A1††,B1	—	—
	5	83	A1*,B1	—	—
	6	100	A1,B1	—	—
060 (50 Hz) 070 (60 Hz) A1†,B1**	1	—	—	16	B1††
	2	—	—	33	B1*
	3	—	—	50	B1
	4	—	—	66	A1,B1††
	5	—	—	83	A1,B1*
	6	—	—	100	A1,B1

*Unloaded compressor.

†Compressor unloader, standard.

**Compressor unloader(s), accessory.

††Two unloaders, both unloaded.

Table 4A — Capacity Control Steps, 040-070 (cont)

UNIT 30GN	CONTROL STEPS	LOADING SEQUENCE A		LOADING SEQUENCE B	
		% Displacement (Approx)	Compressors	% Displacement (Approx)	Compressors
060 (50 Hz) 070 (60 Hz) A1†**,B1	1	16	A1††	16	B1††
	2	33	A1*	33	B1*
	3	50	A1	50	B1
	4	66	A1††,B1	66	A1,B1††
	5	83	A1*,B1	83	A1,B1*
	6	100	A1,B1	100	A1,B1
070 (50 Hz) A1†,B1	1	19	A1*	—	—
	2	27	A1	—	—
	3	65	A1*,B1	—	—
	4	73	A1,B1	—	—
	5	92	A1*,A2,B1	—	—
	6	100	A1,A2,B1	—	—
070 (50 Hz) A1†,B1**	1	19	A1*	31	B1*
	2	27	A1	47	B1
	3	49	A1*,B1*	49	A1*,B1*
	4	65	A1*,B1	57	A1,B1*
	5	73	A1,B1	73	A1,B1
	6	76	A1*,A2,B1*	76	A1*,A2,B1*
	7	92	A1*,A2,B1	84	A1,A2,B1*
	8	100	A1,A2,B1	100	A1,A2,B1
070 (50 Hz) A1†**,B1	1	11	A1††	—	—
	2	19	A1*	—	—
	3	57	A1††,B1	—	—
	4	65	A1*,B1	—	—
	5	73	A1,B1	—	—
	6	84	A1††,A2,B1	—	—
	7	92	A1*,A2,B1	—	—
	8	100	A1,A2,B1	—	—
070 (50 Hz) A1†**,B1**	1	11	A1††	—	—
	2	19	A1*	—	—
	3	27	A1	—	—
	4	41	A1††,B1*	—	—
	5	57	A1††,B1	—	—
	6	65	A1*,B1	—	—
	7	73	A1,B1	—	—
	8	84	A1††,A2,B1	—	—
	9	92	A1*,A2,B1	—	—
	10	100	A1,A2,B1	—	—
070 (50 Hz) A1†,B1	1	—	—	15	B1††
	2	—	—	31	B1*
	3	—	—	47	B1
	4	—	—	57	A1*,B1*
	5	—	—	73	A1,B1
	6	—	—	84	A1,A2,B1*
	7	—	—	100	A1,A2,B1
070 (50 Hz) A1†**,B1	1	11	A1††	15	B1††
	2	19	A1*	31	B1*
	3	27	A1	47	B1
	4	41	A1††,B1*	54	A1*,B1*
	5	57	A1††,B1	73	A1,B1
	6	65	A1*,B1	84	A1,A2,B1*
	7	73	A1,B1	100	A1,A2,B1
	8	84	A1††,A2,B1	—	—
	9	92	A1*,A2,B1	—	—
	10	100	A1,A2,B1	—	—

*Unloaded compressor.
†Compressor unloader, standard.
**One compressor unloader, accessory.
††Two unloaders, both unloaded.
|| Two compressor unloaders, accessory.

Table 4B — Capacity Control Steps, 080-110 and Associated Modular Units

UNIT 30GN	CONTROL STEPS	LOADING SEQUENCE A		LOADING SEQUENCE B	
		% Displacement (Approx)	Compressors	% Displacement (Approx)	Compressors
080, 230B (60 Hz) A1†,B1†	1	22	A1*	30	B1*
	2	34	A1	44	B1
	3	52	A1*,B1*	52	A1*,B1*
	4	67	A1*,B1	63	A1,B1*
	5	78	A1,B1	78	A1,B1
	6	89	A1*,A2,B1	85	A1,A2,B1*
	7	100	A1,A2,B1	100	A1,A2,B1
080, 230B (60 Hz) A1††, B1†	1	11	A1††	—	—
	2	22	A1*	—	—
	3	34	A1	—	—
	4	41	A1††,B1*	—	—
	5	55	A1††,B1	—	—
	6	67	A1*,B1	—	—
	7	78	A1,B1	—	—
	8	89	A1*,A2,B1	—	—
	9	100	A1,A2,B1	—	—
080, 230B (60 Hz) A1†,B1††	1	—	—	15	B1††
	2	—	—	30	B1*
	3	—	—	44	B1
	4	—	—	48	A1,B1††
	5	—	—	63	A1,B1*
	6	—	—	78	A1,B1
	7	—	—	85	A1,A2,B1*
	8	—	—	100	A1,A2,B1
080, 230B (60 Hz) A1††,B1††	1	11	A1††	15	B1††
	2	22	A1*	30	B1*
	3	34	A1	44	B1
	4	41	A1††,B1*	48	A1,B1††
	5	55	A1††,B1	63	A1,B1*
	6	67	A1*,B1	78	A1,B1
	7	78	A1,B1	85	A1,A2,B1*
	8	89	A1*,A2,B1	100	A1,A2,B1
	9	100	A1,A2,B1	—	—
080, 230B (50 Hz) A1†,B1†	1	17	A1*	25	B1*
	2	25	A1	38	B1
	3	42	A1*,B1*	42	A1*,B1*
	4	54	A1*,B1	50	A1, B1*
	5	62	A1,B1	62	A1,B1
	6	79	A1*,A2,B1*	79	A1*,A2,B1*
	7	92	A1*,A2,B1	88	A1,A2,B1*
	8	100	A1,A2,B1	100	A1,A2,B1
080, 230B (50 Hz) A1††,B1†	1	8	A1††	—	—
	2	17	A1*	—	—
	3	25	A1	—	—
	4	33	A1††,B1*	—	—
	5	46	A1††,B1	—	—
	6	54	A1*,B1	—	—
	7	62	A1,B1	—	—
	8	71	A1††,A2,B1*	—	—
	9	84	A1††,A2,B1	—	—
	10	92	A1*,A2,B1	—	—
	11	100	A1,A2,B1	—	—
080, 230B (50 Hz) A1†,B1††	1	—	—	13	B1††
	2	—	—	25	B1*
	3	—	—	38	B1
	4	—	—	50	A1,B1*
	5	—	—	62	A1,B1
	6	—	—	67	A1*,A2,B1††
	7	—	—	75	A1,A2,B1††
	8	—	—	88	A1,A2,B1*
	9	—	—	100	A1,A2,B1
080, 230B (50 Hz) A1††,B1††	1	8	A1††	13	B1††
	2	17	A1*	25	B1*
	3	25	A1	38	B1
	4	33	A1††,B1*	50	A1,B1*
	5	46	A1††,B1	62	A1,B1
	6	54	A1*,B1	67	A1*,A2,B1††
	7	62	A1,B1	75	A1,A2,B1††
	8	71	A1††,A2,B1*	88	A1,A2,B1*
	9	84	A1††,A2,B1	100	A1,A2,B1
	10	92	A1*,A2,B1	—	—
	11	100	A1,A2,B1	—	—

*Unloaded compressor.
†Compressor unloader, standard.
**Compressor unloader, accessory.
††Two unloaders, both unloaded.

NOTE: These capacity control steps may vary due to lag compressor sequencing.

Table 4B — Capacity Control Steps, 080-110 and Associated Modular Units (cont)

UNIT 30GN	CONTROL STEPS	LOADING SEQUENCE A		LOADING SEQUENCE B	
		% Displacement (Approx)	Compressors	% Displacement (Approx)	Compressors
090, 245B (60 Hz) A1†,B1†	1	18	A1*	18	B1*
	2	27	A1	27	B1
	3	35	A1*,B1*	35	A1*,B1*
	4	44	A1*,B1	44	A1,B1*
	5	53	A1,B1	53	A1,B1
	6	56	A1*,A2,B1*	62	A1*,B1*,B2
	7	65	A1*,A2,B1	71	A1,B1*,B2
	8	74	A1,A2,B1	80	A1,B1,B2
	9	82	A1*,A2,B1*,B2	82	A1*,A2,B1*,B2
	10	91	A1*,A2,B1,B2	91	A1,A2,B1*,B2
	11	100	A1,A2,B1,B2	100	A1,A2,B1,B2
090, 245B (60 Hz) A1††,B1†	1	9	A1††	—	—
	2	18	A1*	—	—
	3	27	A1	—	—
	4	35	A1††,B1	—	—
	5	44	A1*,B1	—	—
	6	53	A1,B1	—	—
	7	56	A1††,A2,B1	—	—
	8	65	A1*,A2,B1	—	—
	9	74	A1,A2,B1	—	—
	10	82	A1††,A2,B1,B2	—	—
	11	91	A1*,A2,B1,B2	—	—
	12	100	A1,A2,B1,B2	—	—
090, 245B (60 Hz) A1†,B1††	1	—	—	9	B1††
	2	—	—	18	B1*
	3	—	—	27	B1
	4	—	—	35	A1,B1††
	5	—	—	44	A1,B1*
	6	—	—	53	A1,B1
	7	—	—	62	A1,B1††,B2
	8	—	—	71	A1,B1*,B2
	9	—	—	80	A1,B1,B2
	10	—	—	82	A1,A2,B1††,B2
	11	—	—	91	A1,A2,B1*,B2
	12	—	—	100	A1,A2,B1,B2
090, 245B (60 Hz) A1††,B1††	1	9	A1††	9	B1††
	2	18	A1*	18	B1*
	3	27	A1	27	B1
	4	35	A1††,B1	35	A1,B1††
	5	44	A1*,B1	44	A1,B1*
	6	53	A1,B1	53	A1,B1
	7	56	A1††,A2,B1	62	A1,B1††,B2
	8	65	A1*,A2,B1	71	A1,B1*,B2
	9	74	A1,A2,B1	80	A1,B1,B2
	10	82	A1††,A2,B1,B2	82	A1,A2,B1††,B2
	11	91	A1*,A2,B1,B2	91	A1,A2,B1*,B2
	12	100	A1,A2,B1,B2	100	A1,A2,B1,B2
090, 245B (50 Hz) A1†,B1†	1	14	A1*	14	B1*
	2	21	A1	21	B1
	3	29	A1*,B1*	29	A1*,B1*
	4	36	A1*,B1	36	A1,B1*
	5	43	A1,B1	43	A1,B1
	6	61	A1*,A2,B1*	53	A1*,B1*,B2
	7	68	A1*,A2,B1	60	A1,B1*,B2
	8	75	A1,A2,B1	67	A1,B1,B2
	9	86	A1*,A2,B1*,B2	86	A1*,A2,B1*,B2
	10	93	A1*,A2,B1,B2	93	A1,A2,B1*,B2
	11	100	A1,A2,B1,B2	100	A1,A2,B1,B2
090, 245B (50 Hz) A1††,B1†	1	7	A1††	—	—
	2	14	A1*	—	—
	3	21	A1	—	—
	4	29	A1††,B1	—	—
	5	36	A1*,B1	—	—
	6	43	A1,B1	—	—
	7	54	A1††,A2,B1*	—	—
	8	61	A1††,A2,B1	—	—
	9	68	A1*,A2,B1	—	—
	10	75	A1,A2,B1	—	—
	11	79	A1††,A2,B1*,B2	—	—
	12	86	A1††,A2,B1,B2	—	—
	13	93	A1*,A2,B1,B2	—	—
	14	100	A1,A2,B1,B2	—	—

*Unloaded compressor.
†Compressor unloader, standard.
**Compressor unloader, accessory.
††Two unloaders, both unloaded.

NOTE: These capacity control steps may vary due to lag compressor sequencing.

Table 4B — Capacity Control Steps, 080-110 and Associated Modular Units (cont)

UNIT 30GN	CONTROL STEPS	LOADING SEQUENCE A		LOADING SEQUENCE B	
		% Displacement (Approx)	Compressors	% Displacement (Approx)	Compressors
090, 245B (50 Hz) A1†,B1†**	1	—	—	7	B1††
	2	—	—	14	B1*
	3	—	—	21	B1
	4	—	—	29	A1,B1††
	5	—	—	36	A1,B1*
	6	—	—	43	A1,B1
	7	—	—	46	A1*,B1††,B2
	8	—	—	53	A1,B1††,B2
	9	—	—	60	A1,B1*,B2
	10	—	—	67	A1,B1,B2
	11	—	—	79	A1*,A2,B1††,B1
	12	—	—	86	A1,A2,B1††,B1
	13	—	—	93	A1,A2,B1*,B2
	14	—	—	100	A1,2,B1,B2
090, 245B (50 Hz) A1†**,B1†**	1	7	A1††	7	B1††
	2	14	A1*	14	B1*
	3	21	A1	21	B1
	4	29	A1††,B1	29	A1,B1††
	5	36	A1*,B1	36	A1,B1*
	6	43	A1,B1	43	A1,B1
	7	49	A1††,A2,B1††	46	A1*,B1††,B2
	8	54	A1††,A2,B1*	53	A1,B1††,B2
	9	61	A1††,A2,B1	60	A1,B1*,B2
	10	68	A1*,A2,B1	67	A1,B1,B2
	11	75	A1,A2,B1	72	A1††,A2,B1††,B2
	12	79	A1††,A2,B1*,B2	79	A1*,A2,B1††,B2
	13	86	A1††,A2,B1,B2	86	A1,A2,B1††,B2
	14	93	A1*,A2,B1,B2	93	A1,A2,B1*,B2
	15	100	A1,A2,B1,B2	100	A1,A2,B1,B2
100, 255B, 270B (60 Hz) A1†,B1†	1	16	A1*	16	A1*
	2	23	A1	23	A1
	3	31	A1*,B1*	31	A1*,B1*
	4	39	A1*,B1	39	A1*,B1
	5	46	A1,B1	46	A1,B1
	6	58	A1*,A2,B1*	58	A1*,A2,B1*
	7	66	A1*,A2,B1	66	A1*,A2,B1
	8	73	A1,A2,B1	73	A1,A2,B1
	9	85	A1*,A2,B1*,B2	85	A1*,A2,B1*,B2
	10	92	A1*,A2,B1,B2	92	A1*,A2,B1,B2
	11	100	A1,A2,B1,B2	100	A1,A2,B1,B2
100, 255B, 270B (60 Hz) A1†**,B1†	1	8	A1††	—	—
	2	16	A1*	—	—
	3	23	A1	—	—
	4	31	A1††,B1	—	—
	5	39	A1*,B1	—	—
	6	46	A1,B1	—	—
	7	50	A1††,A2,B1*	—	—
	8	58	A1††,A2,B1	—	—
	9	66	A1*,A2,B1	—	—
	10	73	A1,A2,B1	—	—
	11	77	A1††,A2,B1*,B2	—	—
	12	85	A1††,A2,B1,B2	—	—
	13	92	A1*,A2,B1,B2	—	—
	14	100	A1,A2,B1,B2	—	—
100, 255B, 270B (60 Hz) A1†,B1†**	1	—	—	8	B1††
	2	—	—	16	B1*
	3	—	—	23	B1
	4	—	—	31	A1,B1††
	5	—	—	39	A1,B1*
	6	—	—	46	A1,B1
	7	—	—	50	A1*,B1††,B2
	8	—	—	58	A1,B1††,B2
	9	—	—	66	A1,B1*,B2
	10	—	—	73	A1,B1,B2
	11	—	—	77	A1*,A2,B1††,B2
	12	—	—	85	A1,A2,B1††,B2
	13	—	—	92	A1,A2,B1*,B2
	14	—	—	100	A1,A2,B1,B2

*Unloaded compressor.
†Compressor unloader, standard.
**Compressor unloader, accessory.
††Two unloaders, both unloaded.

NOTE: These capacity control steps may vary due to lag compressor sequencing.

Table 4B — Capacity Control Steps, 080-110 and Associated Modular Units (cont)

UNIT 30GN	CONTROL STEPS	LOADING SEQUENCE A		LOADING SEQUENCE B	
		% Displacement (Approx)	Compressors	% Displacement (Approx)	Compressors
100, 255B, 270B (60 Hz) A1††,B1††	1	8	A1††	8	B1††
	2	16	A1*	16	B1*
	3	23	A1	23	B1
	4	31	A1††,B1	31	A1,B1††
	5	39	A1*,B1	39	A1,B1*
	6	46	A1,B1	46	A1,B1
	7	50	A1††,A2,B1*	50	A1*,B1††,B2
	8	58	A1††,A2,B1	58	A1,B1††,B2
	9	66	A1*,A2,B1	66	A1,B1*,B2
	10	73	A1,A2,B1	73	A1,B1,B2
	11	77	A1††,A2,B1*,B2	77	A1*,A2,B1††,B2
	12	85	A1††,A2,B1,B2	85	A1,A2,B1††,B2
	13	92	A1*,A2,B1,B2	92	A1,A2,B1*,B2
	14	100	A1,A2,B1,B2	100	A1,A2,B1,B2
100, 255B, 270B (50 Hz) A1†,B1†	1	13	A1*	13	B1*
	2	20	A1	20	B1
	3	26	A1*,B1*	26	A1*,B1*
	4	33	A1,B1	33	A1,B1*
	5	40	A1,B1	40	A1,B1
	6	57	A1*,A2,B1*	57	A1*,B1*,B2
	7	63	A1*,A2,B1	63	A1,B1*,B2
	8	70	A1,A2,B1	70	A1,B1,B2
	9	87	A1*,A2,B1*,B2	87	A1*,A2,B1*,B2
	10	93	A1*,A2,B1,B2	93	A1,A2,B1*,B2
	11	100	A1,A2,B1,B2	100	A1,A2,B1,B2
100, 255B, 270B (50 Hz) A1††,B1†	1	7	A1††	—	—
	2	13	A1*	—	—
	3	20	A1	—	—
	4	26	A1††,B1	—	—
	5	33	A1*,B1	—	—
	6	40	A1,B1	—	—
	7	50	A1††,A2,B1*	—	—
	8	57	A1††,A2,B1	—	—
	9	63	A1*,A2,B1	—	—
	10	70	A1,A2,B1	—	—
	11	80	A1††,A2,B1*,B2	—	—
	12	87	A1††,A2,B1,B2	—	—
	13	93	A1*,A2,B1,B2	—	—
	14	100	A1,A2,B1,B2	—	—
100, 255B, 270B (50 Hz) A1†,B1††	1	—	—	7	B1††
	2	—	—	13	B1*
	3	—	—	20	B1
	4	—	—	26	A1,B1††
	5	—	—	33	A1,B1*
	6	—	—	40	A1,B1
	7	—	—	50	A1*,B1††,B2
	8	—	—	57	A1,B1††,B2
	9	—	—	63	A1,B1*,B2
	10	—	—	70	A1,B1,B2
	11	—	—	80	A1*,A2,B1††,B2
	12	—	—	87	A1,A2,B1††,B2
	13	—	—	93	A1,A2,B1*,B2
	14	—	—	100	A1,A2,B1,B2
100, 255B, 270B (50 Hz) A1††,B1††	1	7	A1††	7	B1††
	2	13	A1*	13	B1*
	3	20	A1	20	B1
	4	26	A1††,B1	26	A1,B1††
	5	33	A1*,B1	33	A1,B1*
	6	40	A1,B1	40	A1,B1
	7	43	A1††,A2,B1††	43	A1††,B1††,B2
	8	50	A1††,A2,B1*	50	A1*,B1††,B2
	9	57	A1††,A2,B1	57	A1,B1††,B2
	10	63	A1*,A2,B1	63	A1,B1*,B2
	11	70	A1,A2,B1	70	A1,B1,B2
	12	74	A1††,A2,B1††,B2	74	A1††,A2,B1††,B2
	13	80	A1††,A2,B1*,B2	80	A1*,A2,B1††,B2
	14	89	A1††,A2,B1,B2	87	A1,A2,B1††,B2
	15	93	A1*,A2,B1,B2	93	A1,A2,B1*,B2
	16	100	A1,A2,B1,B2	100	A1,A2,B1,B2

*Unloaded compressor.
†Compressor unloader, standard.
**Compressor unloader, accessory.
††Two unloaders, both unloaded.

NOTE: These capacity control steps may vary due to lag compressor sequencing.

Table 4B — Capacity Control Steps, 080-110 and Associated Modular Units (cont)

UNIT 30GN	CONTROL STEPS	LOADING SEQUENCE A		LOADING SEQUENCE B	
		% Displacement (Approx)	Compressors	% Displacement (Approx)	Compressors
110, 290B, 315B (60 Hz) A1†,B1†	1	14	A1*	14	B1*
	2	21	A1	21	B1
	3	29	A1*,B1*	29	A1*,B1*
	4	36	A1*,B1	36	A1,B1*
	5	43	A1,B1	43	A1,B1
	6	61	A1*,A2,B1*	53	A1*,B1*,B2
	7	68	A1*,A2,B1	60	A1,B1*,B2
	8	75	A1,A2,B1	67	A1,B1,B2
	9	86	A1*,A2,B1*,B2	86	A1*,A2,B1*,B2
	10	93	A1*,A2,B1,B2	93	A1,A2,B1*,B2
	11	100	A1,A2,B1,B2	100	A1,A2,B1,B2
110, 290B, 315B (60 Hz) A1†**,B1†	1	7	A1††	—	—
	2	14	A1*	—	—
	3	21	A1	—	—
	4	29	A1††,B1	—	—
	5	36	A1*,B1	—	—
	6	43	A1,B1	—	—
	7	54	A1††,A2,B1*	—	—
	8	61	A1††,A2,B1	—	—
	9	68	A1*,A2,B1	—	—
	10	75	A1,A2,B1	—	—
	11	79	A1††,A2,B1*,B2	—	—
	12	86	A1††,A2,B1,B2	—	—
	13	93	A1*,A2,B1,B2	—	—
	14	100	A1,A2,B1,B2	—	—
110, 290B, 315B (60 Hz) A1†,B1†**	1	—	—	7	B1††
	2	—	—	14	B1*
	3	—	—	21	B1
	4	—	—	29	A1,B1††
	5	—	—	36	A1,B1*
	6	—	—	43	A1,B1
	7	—	—	46	A1*,B1††,B2
	8	—	—	53	A1,B1††,B2
	9	—	—	60	A1,B1*,B2
	10	—	—	67	A1,B1,B2
	11	—	—	79	A1*,A2,B1††,B2
	12	—	—	86	A1,A2,B1††,B2
	13	—	—	93	A1,A2,B1*,B2
	14	—	—	100	A1,A2,B1,B2
110, 290B, 315B (60 Hz) A1†**,B1†**	1	7	A1††	7	B1††
	2	14	A1*	14	B1*
	3	21	A1	21	B1
	4	29	A1††,B1	29	A1,B1††
	5	36	A1*,B1	36	A1,B1*
	6	43	A1,B1	43	A1,B1
	7	47	A1††,A2,B1††	46	A1*,B1††,B2
	8	54	A1††,A2,B1*	53	A1,B1††,B2
	9	61	A1††,A2,B1	60	A1,B1*,B2
	10	68	A1*,A2,B1	67	A1,B1,B2
	11	75	A1,A2,B1	72	A1††,A2,B1††,B2
	12	79	A1††,A2,B1*,B2	79	A1*,A2,B1††,B2
	13	86	A1††,A2,B1,B2	86	A1,A2,B1††,B2
	14	93	A1*,A2,B1,B2	93	A1,A2,B1*,B2
	15	100	A1,A2,B1,B2	100	A1,A2,B1,B2
110, 290B, 315B (50 Hz) A1†,B1†	1	17	A1*	17	B1*
	2	25	A1	25	B1
	3	33	A1*,B1*	33	A1*,B1*
	4	42	A1*,B1	42	A1,B1*
	5	50	A1,B1	50	A1,B1
	6	58	A1*,A2,B1*	58	A1*,B1*,B2
	7	67	A1*,A2,B1	67	A1,B1*,B2
	8	75	A1,A2,B1	75	A1,B1,B2
	9	83	A1*,A2,B1*,B2	83	A1*,A2,B1*,B2
	10	92	A1*,A2,B1,B2	92	A1,A2,B1*,B2
	11	100	A1,A2,B1,B2	100	A1,A2,B1,B2

*Unloaded compressor.
 †Compressor unloader, standard.
 **Compressor unloader, accessory.
 ††Two unloaders, both unloaded.

NOTE: These capacity control steps may vary due to lag compressor sequencing.

Table 4B — Capacity Control Steps, 080-110 and Associated Modular Units (cont)

UNIT 30GN	CONTROL STEPS	LOADING SEQUENCE A		LOADING SEQUENCE B	
		% Displacement (Approx)	Compressors	% Displacement (Approx)	Compressors
110, 290B, 315B (50 Hz) A1††*,B1†	1	8	A1††	—	—
	2	17	A1*	—	—
	3	25	A1	—	—
	4	33	A1††,B1	—	—
	5	42	A1*,B1	—	—
	6	50	A1,B1	—	—
	7	58	A1††,A2,B1	—	—
	8	67	A1*,A2,B1	—	—
	9	75	A1,A2,B1	—	—
	10	83	A1††,A2,B1,B2	—	—
	11	92	A1*,A2,B1,B2	—	—
	12	100	A1,A2,B1,B2	—	—
110, 290B, 315B (50 Hz) A1†,B1†**	1	—	—	8	B1††
	2	—	—	17	B1*
	3	—	—	25	B1
	4	—	—	33	A1,B1††
	5	—	—	42	A1,B1*
	6	—	—	50	A1,B1
	7	—	—	58	A1,B1††,B2
	8	—	—	67	A1,B1*,B2
	9	—	—	75	A1,B1,B2
	10	—	—	83	A1,A2,B1††,B2
	11	—	—	92	A1,A2,B1*,B2
	12	—	—	100	A1,A2,B1,B2
110, 290B, 315B (50 Hz) A1††*,B1†**	1	8	A1††	8	B1††
	2	17	A1*	17	B1*
	3	25	A1	25	B1
	4	33	A1††,B1	33	A1,B1††
	5	42	A1*,B1	42	A1,B1*
	6	50	A1,B1	50	A1,B1
	7	58	A1††,A2,B1	58	A1,B1††,B2
	8	67	A1*,A2,B1	67	A1,B1*,B2
	9	75	A1,A2,B1	75	A1,B1,B2
	10	83	A1††,A2,B1,B2	83	A1,A2,B1††,B2
	11	92	A1*,A2,B1,B2	92	A1,A2,B1*,B2
	12	100	A1,A2,B1,B2	100	A1,A2,B1,B2

*Unloaded compressor.
 †Compressor unloader, standard.
 **Compressor unloader, accessory.
 ††Two unloaders, both unloaded.

NOTE: These capacity control steps may vary due to lag compressor sequencing.

Table 4C — Capacity Control Steps, 130-210 and Associated Modular Units

UNIT 30GN	CONTROL STEPS	LOADING SEQUENCE A		LOADING SEQUENCE B	
		% Displacement (Approx)	Compressors	% Displacement (Approx)	Compressors
130 (60 Hz) A1†,B1†	1	14	A1*	14	B1*
	2	21	A1	21	B1
	3	28	A1*,B1*	28	A1*,B1*
	4	35	A1*,B1	35	A1,B1*
	5	42	A1,B1	42	A1,B1
	6	58	A1*,A2,B1*	58	A1*,B1*,B2
	7	64	A1*,A2,B1	64	A1,B1*,B2
	8	71	A1,A2,B1	71	A1,B1,B2
	9	87	A1*,A2,B1*,B2	87	A1*,A2,B1*,B2
	10	93	A1*,A2,B1,B2	93	A1,A2,B1*,B2
	11	100	A1,A2,B1,B2	100	A1,A2,B1,B2
130 (60 Hz) A1††,B1†	1	8	A1††	—	—
	2	14	A1*	—	—
	3	21	A1	—	—
	4	22	A1††,B1*	—	—
	5	28	A1††,B1	—	—
	6	35	A1*,B1	—	—
	7	42	A1,B1	—	—
	8	51	A1††,A2,B1*	—	—
	9	58	A1††,A2,B1	—	—
	10	64	A1*,A2,B1	—	—
	11	71	A1,A2,B1	—	—
	12	80	A1††,A2,B1*,B2	—	—
	13	87	A1††,A2,B1,B2	—	—
	14	93	A1*,A2,B1,B2	—	—
	15	100	A1,A2,B1,B2	—	—
130 (60 Hz) A1†,B1††	1	—	—	8	B1††
	2	—	—	14	B1*
	3	—	—	21	B1
	4	—	—	22	A1*,B1††
	5	—	—	28	A1,B1††
	6	—	—	35	A1,B1*
	7	—	—	42	A1,B1
	8	—	—	51	A1*,B1††,B2
	9	—	—	58	A1,B1††,B2
	10	—	—	64	A1,B1*,B2
	11	—	—	71	A1,B1,B2
	12	—	—	80	A1*,A2,B1††,B2
	13	—	—	87	A1,A2,B1††,B2
	14	—	—	93	A1,A2,B1*,B2
	15	—	—	100	A1,A2,B1,B2
130 (60 Hz) A1††,B1††	1	8	A1††	8	B1††
	2	14	A1*	14	B1*
	3	21	A1	21	B1
	4	22	A1††,B1*	22	A1*,B1††
	5	28	A1††,B1	28	A1,B1††
	6	35	A1*,B1	35	A1,B1*
	7	42	A1,B1	42	A1,B1
	8	44	A1††,A2,B1††	44	A1††,B1††,B2
	9	51	A1††,A2,B1*	51	A1*,B1††,B2
	10	58	A1††,A2,B1	58	A1,B1††,B2
	11	64	A1*,A2,B1	64	A1,B1*,B2
	12	71	A1,A2,B1	71	A1,B1,B2
	13	73	A1††,A2,B1††,B2	73	A1††,A2,B1††,B2
	14	80	A1††,A2,B1*,B2	80	A1*,A2,B1††,B2
	15	87	A1††,A2,B1,B2	87	A1,A2,B1††,B2
	16	93	A1*,A2,B1,B2	93	A1,A2,B1*,B2
	17	100	A1,A2,B1,B2	100	A1,A2,B1,B2
130 (50 Hz) A1†,B1†	1	10	A1*	16	B1*
	2	14	A1	25	B1
	3	26	A1*,B1*	26	A1*,B1*
	4	35	A1*,B1	31	A1,B1*
	5	39	A1,B1	39	A1,B1
	6	44	A1*,A2,B1*	51	A1*,B1*,B2
	7	53	A1*,A2,B1	56	A1,B1*,B2
	8	57	A1,A2,B1	64	A1,B1,B2
	9	69	A1*,A2,B1*,B2	69	A1*,A2,B1*,B2
	10	78	A1*,A2,B1,B2	74	A1,A2,B1*,B2
	11	82	A1,A2,B1,B2	82	A1,A2,B1,B2
	12	87	A1*,A2,A3,B1*,B2	87	A1*,A2,A3,B1*,B2
	13	96	A1*,A2,A3,B1,B2	91	A1,A2,A3,B1*,B2
	14	100	A1,A2,A3,B1,B2	100	A1,A2,A3,B1,B2

*Unloaded compressor.

†Compressor unloader, standard.

**Compressor unloader, accessory.

††Two unloaders, both unloaded.

NOTE: These capacity control steps may vary due to lag compressor sequencing.

Table 4C — Capacity Control Steps, 130-210 and Associated Modular Units (cont)

UNIT 30GN	CONTROL STEPS	LOADING SEQUENCE A		LOADING SEQUENCE B	
		% Displacement (Approx)	Compressors	% Displacement (Approx)	Compressors
130 (50 Hz) A1††,B1†	1	6	A1††	—	—
	2	10	A1*	—	—
	3	14	A1	—	—
	4	22	A1††,B1*	—	—
	5	31	A1††,B1	—	—
	6	35	A1*,B1	—	—
	7	39	A1,B1	—	—
	8	40	A1††,A2,B1*	—	—
	9	49	A1††,A2,B1	—	—
	10	53	A1*,A2,B1	—	—
	11	57	A1,A2,B1	—	—
	12	65	A1††,A2,B1*,B2	—	—
	13	74	A1††,A2,B1,B2	—	—
	14	78	A1*,A2,B1,B2	—	—
	15	82	A1,A2,B1,B2	—	—
	16	83	A1††,A2,A3,B1*,B2	—	—
	17	91	A1††,A2,A3,B1,B2	—	—
	18	96	A1*,A2,A3,B1,B2	—	—
	19	100	A1,A2,A3,B1,B2	—	—
130 (50 Hz) A1†,B1††	1	—	—	8	B1††
	2	—	—	16	B1*
	3	—	—	25	B1
	4	—	—	31	A1,B1*
	5	—	—	39	A1,B1
	6	—	—	43	A1*,B1††,B2
	7	—	—	47	A1,B1††,B2
	8	—	—	56	A1,B1*,B2
	9	—	—	64	A1,B1,B2
	10	—	—	65	A1,A2,B1††,B2
	11	—	—	74	A1,A2,B1*,B2
	12	—	—	82	A1,A2,B1,B2
	13	—	—	83	A1,A2,A3,B1††,B2,B3
	14	—	—	91	A1,A2,A3,B1*,B2,B3
	15	—	—	100	A1,A2,A3,B1,B2,B3
130 (50 Hz) A1††,B1††	1	6	A1††	8	B1††
	2	10	A1*	16	B1*
	3	14	A1	25	B1
	4	22	A1††,B1*	31	A1,B1*
	5	31	A1††,B1	39	A1,B1
	6	35	A1*,B1	43	A1*,B1††,B2
	7	39	A1,B1	47	A1,B1††,B2
	8	40	A1††,A2,B1*	56	A1,B1*,B2
	9	49	A1††,A2,B1	64	A1,B1,B2
	10	53	A1*,A2,B1	65	A1,A2,B1††,B2
	11	57	A1,A2,B1	74	A1,A2,B1*,B2
	12	65	A1††,A2,B1*,B2	82	A1,A2,B1,B2
	13	74	A1††,A2,B1,B2	83	A1,A2,A3,B1††,B2
	14	78	A1*,A2,B1,B2	91	A1,A2,A3,B1*,B2
	15	82	A1,A2,B1,B2	100	A1,A2,A3,B1,B2
	16	83	A1††,A2,A3,B1*,B2	—	—
	17	91	A1††,A2,A3,B1,B2	—	—
	18	96	A1*,A2,A3,B1,B2	—	—
	19	100	A1,A2,A3,B1,B2	—	—
150, 230A, 245A, 255A (60 Hz) A1†,B1†	1	11	A1*	18	B1*
	2	15	A1	27	B1
	3	29	A1*,B1*	29	A1*,B1*
	4	38	A1*,B1	33	A1,B1*
	5	42	A1,B1	42	A1,B1
	6	44	A1*,A2,B1*	55	A1*,B1*,B2
	7	53	A1*,A2,B1	60	A1,B1*,B2
	8	58	A1,A2,B1	69	A1,B1,B2
	9	71	A1*,A2,B1*,B2	71	A1*,A2,B1*,B2
	10	80	A1*,A2,B1,B2	75	A1,A2,B1*,B2
	11	85	A1,A2,B1,B2	85	A1,A2,B1,B2
	12	86	A1*,A2,A3,B1*,B2	86	A1*,A2,A3,B1*,B2
	13	95	A1*,A2,A3,B1,B2	91	A1,A2,A3,B1*,B2
	14	100	A1,A2,A3,B1,B2	100	A1,A2,A3,B1,B2

*Unloaded compressor.
†Compressor unloader, standard.
**Compressor unloader, accessory.
††Two unloaders, both unloaded.

NOTE: These capacity control steps may vary due to lag compressor sequencing.

Table 4C — Capacity Control Steps, 130-210 and Associated Modular Units (cont)

UNIT 30GN	CONTROL STEPS	LOADING SEQUENCE A		LOADING SEQUENCE B	
		% Displacement (Approx)	Compressors	% Displacement (Approx)	Compressors
150, 230A, 245A, 255A (60 Hz) A1††,B1†	1	6	A1††	—	—
	2	11	A1*	—	—
	3	15	A1	—	—
	4	24	A1††,B1*	—	—
	5	33	A1††,B1	—	—
	6	38	A1*,B1	—	—
	7	42	A1,B1	—	—
	8	49	A1††,A2,B1	—	—
	9	53	A1*,A2,B1	—	—
	10	58	A1,A2,B1	—	—
	11	66	A1††,A2,B1*,B2	—	—
	12	75	A1††,A2,B1,B2	—	—
	13	80	A1*,A2,B1,B2	—	—
	14	85	A1,A2,B1,B2	—	—
	15	91	A1††,A2,A3,B1,B2	—	—
	16	95	A1*,A2,A3,B1,B2	—	—
	17	100	A1,A2,A3,B1,B2	—	—
150, 230A, 245A, 255A (60 Hz) A1†,B1†**	1	—	—	9	B1††
	2	—	—	18	B1*
	3	—	—	27	B1
	4	—	—	33	A1,B1*
	5	—	—	42	A1,B1
	6	—	—	46	A1*,B1††,B2
	7	—	—	51	A1,B1††,B2
	8	—	—	60	A1,B1*,B2
	9	—	—	69	A1,B1,B2
	10	—	—	75	A1,A2,B1*,B2
	11	—	—	85	A1,A2,B1,B2
	12	—	—	91	A1,A2,A3,B1*,B2
	13	—	—	100	A1,A2,A3,B1,B2
150, 230A, 245A, 255A (60 Hz) A1††,B1†**	1	6	A1††	9	B1††
	2	11	A1*	18	B1*
	3	15	A1	27	B1
	4	24	A1††,B1*	33	A1,B1*
	5	33	A1††,B1	42	A1,kB1
	6	38	A1*,B1	46	A1*,B1††,B2
	7	42	A1,B1	51	A1,B1††,B2
	8	49	A1††,A2,B1	60	A1,B1*,B2
	9	53	A1*,A2,B1	69	A1,B1,B2
	10	58	A1,A2,B1	75	A1,A2,B1*,B2
	11	66	A1††,A2,B1*,B2	86	A1,A2,B1,B2
	12	75	A1††,A2,B1,B2	91	A1,A2,A3,B1*,B2
	13	80	A1*,A2,B1,B2	100	A1,A2,A3,B1,B2
	14	85	A1,A2,B1,B2	—	—
	15	91	A1††,A2,A3,B1,B2	—	—
	16	95	A1*,A2,A3,B1,B2	—	—
	17	100	A1,A2,A3,B1,B2	—	—
150, 230A, 245A, 255A (50 Hz) A1†,B1†	1	13	A1*	13	B1*
	2	20	A1	20	B1
	3	26	A1*,B1*	26	A1*,B1*
	4	33	A1*,B1	33	A1,B1*
	5	40	A1,B1	40	A1,B1
	6	46	A1*,A2,B1*	46	A1*,B1*,B2
	7	53	A1*,A2,B1	53	A1,B1*,B2
	8	60	A1,A2,B1	60	A1,B1,B2
	9	66	A1*,A2,B1*,B2	66	A1*,A2,B1*,B2
	10	73	A1*,A2,B1,B2	73	A1,A2,B1*,B2
	11	80	A1,A2,B1,B2	80	A1,A2,B1,B2
	12	86	A1*,A2,A3,B1*,B2	86	A1*,A2,A3,B1*,B2
	13	93	A1*,A2,A3,B1,B2	93	A1,A2,A3,B1*,B2
	14	100	A1,A2,A3,B1,B2	100	A1,A2,A3,B1,B2
150, 230A, 245A, 255A (50 Hz) A1††,B1†	1	6	A1††	—	—
	2	13	A1*	—	—
	3	20	A1	—	—
	4	26	A1††,B1	—	—
	5	33	A1*,B1	—	—
	6	40	A1,B1	—	—
	7	46	A1††,A2,B1	—	—
	8	53	A1*,A2,B1	—	—
	9	60	A1,A2,B1	—	—
	10	66	A1††,A2,B1,B2	—	—
	11	73	A1*,A2,B1,B2	—	—
	12	80	A1,A2,B1,B2	—	—
	13	86	A1††,A2,A3,B1,B2	—	—
	14	93	A1*,A2,A3,B1,B2	—	—
	15	100	A1,A2,A3,B1,B2	—	—

*Unloaded compressor.
 †Compressor unloader, standard.
 **Compressor unloader, accessory.
 ††Two unloaders, both unloaded.

NOTE: These capacity control steps may vary due to lag compressor sequencing.

Table 4C — Capacity Control Steps, 130-210 and Associated Modular Units (cont)

UNIT SIZE	CONTROL STEPS	LOADING SEQUENCE A		LOADING SEQUENCE B	
		% Displacement (Approx)	Compressors	% Displacement (Approx)	Compressors
150, 230A, 245A, 255A (50 Hz) A1†,B1†**	1	—	—	6	B1††
	2	—	—	13	B1*
	3	—	—	20	B1
	4	—	—	26	A1,B1††
	5	—	—	33	A1,B1*
	6	—	—	40	A1,B1
	7	—	—	46	A1,B1††,B2
	8	—	—	53	A1,B1*,B2
	9	—	—	60	A1,B1,B2
	10	—	—	66	A1,A2,B1††,B2
	11	—	—	73	A1,A2,B1*,B2
	12	—	—	80	A1,A2,B1,B2
	13	—	—	86	A1,A2,A3,B1††,B2
	14	—	—	93	A1,A2,A3,B1*,B2
	15	—	—	100	A1,A2,A3,B1,B2
150, 230A, 245A, 255A (50 Hz) A1†**,B1†**	1	6	A1††	6	B1††
	2	13	A1*	13	B1*
	3	20	A1	20	B1
	4	26	A1††,B1	26	A1,B1††
	5	33	A1*,B1	33	A1,B1*
	6	40	A1,B1	40	A1,B1
	7	46	A1††,A2,B1	46	A1,B1††,B2
	8	53	A1*,A2,B1	53	A1,B1*,B2
	9	60	A1,A2,B1	60	A1,B1,B2
	10	66	A1††,A2,B1,B2	66	A1,A2,B1††,B2
	11	73	A1*,A2,B1,B2	73	A1,A2,B1*,B2
	12	80	A1,A2,B1,B2	80	A1,A2,B1,B2
	13	86	A1††,A2,A3,B1,B2	86	A1,A2,A3,B1††,B2
	14	93	A1*,A2,A3,B1,B2	93	A1,A2,A3,B1*,B2
	15	100	A1,A2,A3,B1,B2	100	A1,A2,A3,B1,B2
170, 270A, 330A/B (60 Hz) A1†,B1†	1	11	A1*	11	B1*
	2	17	A1	17	B1
	3	23	A1*,B1*	23	A1*,B1*
	4	28	A1*,B1	28	A1,B1*
	5	33	A1,B1	33	A1,B1
	6	39	A1*,A2,B1*	39	A1*,B1*,B2
	7	45	A1*,A2,B1	45	A1,B1*,B2
	8	50	A1,A2,B1	50	A1,B1,B2
	9	56	A1*,A2,B1*,B2	56	A1*,A2,B1*,B2,B3
	10	61	A1*,A2,B1,B2	61	A1,A2,B1*,B2
	11	67	A1,A2,B1,B2	67	A1,A2,B1,B2
	12	73	A1*,A2,A3,B1*,B2	73	A1*,A2,B1*,B2,B3
	13	78	A1*,A2,A3,B1,B2	78	A1,A2,B1*,B2,B3
	14	83	A1,A2,A3,B1,B2	83	A1,A2,B1,B2,B3
	15	89	A1*,A2,A3,B1*,B2,B3	89	A1*,A2,A3,B1*,B2,B3
	16	95	A1*,A2,A3,B1,B2,B3	95	A1,A2,A3,B1*,B2,B3
	17	100	A1,A2,A3,B1,B2,B3	100	A1,A2,A3,B1,B2,B3
170, 270A, 330A/B (60 Hz) A1†**,B1†	1	6	A1††	—	—
	2	11	A1*	—	—
	3	17	A1	—	—
	4	17	A1††,B1*	—	—
	5	23	A1††,B1	—	—
	6	28	A1*,B1	—	—
	7	33	A1,B1	—	—
	8	34	A1††,A2,B1*	—	—
	9	39	A1††,A2,B1	—	—
	10	45	A1*,A2,B1	—	—
	11	50	A1,A2,B1	—	—
	12	51	A1††,A2,B1*,B2	—	—
	13	56	A1††,A2,B1,B2	—	—
	14	61	A1*,A2,B1,B2	—	—
	15	67	A1,A2,B1,B2	—	—
	16	67	A1††,A2,A3,B1*,B2	—	—
	17	73	A1††,A2,A3,B1,B2	—	—
	18	78	A1*,A2,A3,B1,B2	—	—
	19	83	A1,A2,A3,B1,B2	—	—
	20	84	A1††,A2,A3,B1*,B2,B3	—	—
	21	89	A1††,A2,A3,B1,B2,B3	—	—
	22	95	A1*,A2,A3,B1,B2,B3	—	—
	23	100	A1,A2,A3,B1,B2,B3	—	—

*Unloaded compressor.
†Compressor unloader, standard.
**Compressor unloader, accessory.
††Two unloaders, both unloaded.

NOTE: These capacity control steps may vary due to lag compressor sequencing.

Table 4C — Capacity Control Steps, 130-210 and Associated Modular Units (cont)

UNIT SIZE	CONTROL STEPS	LOADING SEQUENCE A		LOADING SEQUENCE B	
		% Displacement (Approx)	Compressors	% Displacement (Approx)	Compressors
170, 270A, 330A/B (60 Hz) A1†,B1†**	1	—	—	6	B1††
	2	—	—	11	B1*
	3	—	—	17	B1
	4	—	—	17	A1*,B1††
	5	—	—	23	A1,B1††
	6	—	—	28	A1,B1*
	7	—	—	33	A1,B1
	8	—	—	34	A1*,B1††,B2
	9	—	—	39	A1,B1††,B2
	10	—	—	45	A1,B1*,B2
	11	—	—	50	A1,B1,B2
	12	—	—	51	A1*,A2,B1††,B2
	13	—	—	56	A1,A2,B1††,B2
	14	—	—	61	A1,A2,B1*,B2
	15	—	—	67	A1,A2,B1,B2
	16	—	—	67	A1*,A2,B1††,B2,B3
	17	—	—	73	A1,A2,B1††,B2,B3
	18	—	—	78	A1,A2,B1*,B2,B3
	19	—	—	83	A1,A2,B1,B2,B3
	20	—	—	84	A1*,A2,A3,B1††,B2,B3
	21	—	—	89	A1,A2,A3,B1††,B2,B3
	22	—	—	95	A1,A2,A3,B1*,B2,B3
	23	—	—	100	A1,A2,A3,B1,B2,B3
170, 270A, 330A/B (60 Hz) A1†**,B1†**	1	6	A1††	6	B1††
	2	11	A1*	11	B1*
	3	17	A1	17	B1
	4	17	A1††,B1*	17	A1*,B1††
	5	23	A1††,B1	23	A1,B1††
	6	28	A1*,B1	28	A1,B1*
	7	33	A1,B1	33	A1,B1
	8	34	A1††,A2,B1*	34	A1*,B1††,B2
	9	39	A1††,A2,B1	39	A1,B1††,B2
	10	45	A1*,A2,B1	45	A1,B1*,B2
	11	50	A1,A2,B1	50	A1,B1,B2
	12	51	A1††,A2,B1*,B2	51	A1*,A2,B1††,B2
	13	56	A1††,A2,B1,B2	56	A1,A2,B1††,B2
	14	61	A1*,A2,B1,B2	61	A1,A2,B1*,B2
	15	67	A1,A2,B1,B2	67	A1,A2,B1,B2
	16	67	A1††,A2,A3,B1*,B2	67	A1*,A2,B1††,B2,B3
	17	73	A1††,A2,A3,B1,B2	73	A1,A2,B1††,B2,B3
	18	78	A1*,A2,A3,B1,B2	78	A1,A2,B1*,B2,B3
	19	83	A1,A2,A3,B1,B2	83	A1,A2,B1,B2,B3
	20	84	A1††,A2,A3,B1*,B2,B3	84	A1*,A2,A3,B1††,B2,B3
	21	89	A1††,A2,A3,B1,B2,B3	89	A1,A2,A3,B1††,B2,B3
	22	95	A1*,A2,A3,B1,B2,B3	95	A1,A2,A3,B1*,B2,B3
	23	100	A1,A2,A3,B1,B2,B3	100	A1,A2,A3,B1,B2,B3
170, 270A, 330A/B,360B (50 Hz) A1†,B1†	1	9	A1*	9	B1*
	2	14	A1	14	B1
	3	19	A1*,B1*	19	A1*,B1*
	4	23	A1*,B1	23	A1,B1*
	5	28	A1,B1	28	A1,B1
	6	33	A1*,A2,B1*	38	A1*,B1*,B2
	7	37	A1*,A2,B1	43	A1,B1*,B2
	8	42	A1,A2,B1	47	A1,B1,B2
	9	52	A1*,A2,B1*,B2	52	A1*,A2,B1*,B2
	10	57	A1*,A2,B1,B2	57	A1,A2,B1*,B2
	11	61	A1,A2,B1,B2	61	A1,A2,B1,B2
	12	72	A1*,A2,A3,B1*,B2	72	A1*,A2,B1*,B2,B3
	13	76	A1*,A2,A3,B1,B2	76	A1,A2,B1*,B2,B3
	14	81	A1,A2,A3,B1,B2	81	A1,A2,B1,B2,B3
	15	91	A1*,A2,A3,B1*,B2,B3	91	A1*,A2,A3,B1*,B2,B3
	16	96	A1*,A2,A3,B1,B2,B3	96	A1,A2,A3,B1*,B2,B3
	17	100	A1,A2,A3,B1,B2,B3	100	A1,A2,A3,B1,B2,B3

*Unloaded compressor.
†Compressor unloader, standard.
**Compressor unloader, accessory.
††Two unloaders, both unloaded.

NOTE: These capacity control steps may vary due to lag compressor sequencing.

Table 4C — Capacity Control Steps, 130-210 and Associated Modular Units (cont)

UNIT SIZE	CONTROL STEPS	LOADING SEQUENCE A		LOADING SEQUENCE B	
		% Displacement (Approx)	Compressors	% Displacement (Approx)	Compressors
170, 270A, 330A/B, 360B (50 Hz) A1††,B1†	1	5	A1††	—	—
	2	9	A1*	—	—
	3	14	A1	—	—
	4	14	A1††,B1*	—	—
	5	19	A1††,B1	—	—
	6	23	A1*,B1	—	—
	7	28	A1,B1	—	—
	8	28	A1††,A2,B1*	—	—
	9	33	A1††,A2,B1	—	—
	10	37	A1*,A2,B1	—	—
	11	42	A1,A2,B1	—	—
	12	48	A1††,A2,B1*,B2	—	—
	13	52	A1††,A2,B1,B2	—	—
	14	57	A1*,A2,B1,B2	—	—
	15	61	A1,A2,B1,B2	—	—
	16	67	A1††,A2,A3,B1*,B2	—	—
	17	72	A1††,A2,A3,B1,B2	—	—
	18	76	A1*,A2,A3,B1,B2	—	—
	19	81	A1,A2,A3,B1,B2	—	—
	20	87	A1††,A2,A3,B1*,B2,B3	—	—
	21	91	A1††,A2,A3,B1,B2,B3	—	—
	22	96	A1*,A2,A3,B1,B2,B3	—	—
	23	100	A1,A2,A3,B1,B2,B3	—	—
170, 270A, 330A/B, 360B (50 Hz) A1†,B1††	1	—	—	5	B1††
	2	—	—	9	B1*
	3	—	—	14	B1
	4	—	—	14	A1*,B1††
	5	—	—	19	A1,B1††
	6	—	—	23	A1,B1*
	7	—	—	28	A1,B1
	8	—	—	34	A1*,B1††,B2
	9	—	—	38	A1,B1††,B2
	10	—	—	43	A1,B1*,B2
	11	—	—	47	A1,B1,B2
	12	—	—	48	A1*,A2,B1††,B2
	13	—	—	52	A1,A2,B1††,B2
	14	—	—	57	A1,A2,B1*,B2
	15	—	—	61	A1,A2,B1,B2
	16	—	—	67	A1*,A2,B1††,B2,B3
	17	—	—	72	A1,A2,B1††,B2,B3
	18	—	—	76	A1,A2,B1*,B2,B3
	19	—	—	81	A1,A2,B1,B2,B3
	20	—	—	87	A1*,A2,A3,B1††,B2,B3
	21	—	—	91	A1,A2,A3,B1††,B2,B3
	22	—	—	96	A1,A2,A3,B1*,B2,B3
	23	—	—	100	A1,A2,A3,B1,B2,B3
170, 270A, 330A/B, 360B (50 Hz) A1††,B1††	1	5	A1††	5	B1††
	2	9	A1*	9	B1*
	3	14	A1	14	B1
	4	14	A1††,B1*	14	A1*,B1††
	5	19	A1††,B1	19	A1,B1††
	6	23	A1*,B1	23	A1,B1*
	7	28	A1,B1	28	A1,B1
	8	28	A1††,A2,B1*	29	A1††,B1††,B2
	9	33	A1††,A2,B1	34	A1*,B1††,B2
	10	37	A1*,A2,B1	38	A1,B1††,B2
	11	42	A1,A2,B1	43	A1,B1*,B2
	12	43	A1††,A2,B1††,B2	47	A1,B1,B2
	13	48	A1††,A2,B1*,B2	48	A1*,A2,B1††,B2
	14	52	A1††,A2,B1,B2	52	A1,A2,B1††,B2
	15	57	A1*,A2,B1,B2	57	A1,A2,B1*,B2
	16	61	A1,A2,B1,B2	61	A1,A2,B1,B2
	17	63	A1††,A2,A3,B1††,B2	63	A1††,A2,B1††,B2,B3
	18	67	A1††,A2,A3,B1*,B2	67	A1*,A2,B1††,B2,B3
	19	72	A1††,A2,A3,B1,B2	72	A1,A2,B1††,B2,B3
	20	76	A1*,A2,A3,B1,B2	76	A1,A2,B1*,B2,B3
	21	81	A1,A2,A3,B1,B2	81	A1,A2,B1,B2,B3
	22	82	A1††,A2,A3,B1††,B2,B3	82	A1††,A2,A3,B1††,B2,B3
	23	87	A1††,A2,A3,B1*,B2,B3	87	A1*,A2,A3,B1††,B2,B3
	24	91	A1††,A2,A3,B1,B2,B3	91	A1,A2,A3,B1††,B2,B3
	25	96	A1*,A2,A3,B1,B2,B3	96	A1,A2,A3,B1*,B2,B3
	26	100	A1,A2,A3,B1,B2,B3	100	A1,A2,A3,B1,B3,B3

*Unloaded compressor.
†Compressor unloader, standard.
**Compressor unloader, accessory.
††Two unloaders, both unloaded.

NOTE: These capacity control steps may vary due to lag compressor sequencing.

Table 4C — Capacity Control Steps, 130-210 and Associated Modular Units (cont)

UNIT SIZE	CONTROL STEPS	LOADING SEQUENCE A		LOADING SEQUENCE B	
		% Displacement (Approx)	Compressors	% Displacement (Approx)	Compressors
190, 290A, 360A/B, 390B (60 Hz) A1,B1	1	13	A1	13	B1
	2	25	A1,B1	25	A1,B1
	3	41	A1,A2,B1	41	A1,B1,B2
	4	56	A1,A2,B1,B2	56	A1,A2,B1,B2
	5	78	A1,A2,A3,B1,B2	78	A1,A2,B1,B2,B3
	6	100	A1,A2,A3,B1,B2,B3	100	A1,A2,A3,B1,B2,B3
190, 290A, 360A/B, 390B (60 Hz) A1**,B1	1	9	A1*	—	—
	2	13	A1	—	—
	3	21	A1*,B1	—	—
	4	25	A1,B1	—	—
	5	37	A1*,A2,B1	—	—
	6	41	A1,A2,B1	—	—
	7	53	A1*,A2,B1,B2	—	—
	8	56	A1,A2,B1,B2	—	—
	9	74	A1*,A2,A3,B1,B2	—	—
	10	78	A1,A2,A3,B1,B2	—	—
	11	96	A1*,A2,A3,B1,B2,B3	—	—
	12	100	A1,A2,A3,B1,B2,B3	—	—
190, 290A, 360A/B, 390B (60 Hz) A1,B1**	1	—	—	9	B1*
	2	—	—	13	B1
	3	—	—	21	A1,B1*
	4	—	—	25	A1,B1
	5	—	—	37	A1,B1*,B2
	6	—	—	41	A1,B1,B2
	7	—	—	53	A1,A2,B1*,B2
	8	—	—	56	A1,A2,B1,B2
	9	—	—	74	A1,A2,B1*,B2,B3
	10	—	—	78	A1,A2,B1,B2,B3
	11	—	—	96	A1,A2,A3,B1*,B2,B3
	12	—	—	100	A1,A2,A3,B1,B2,B3
190, 290A, 360A/B, 390B (60 Hz) A1**,B1**	1	9	A1*	9	B1*
	2	13	A1	13	B1
	3	18	A1*,B1*	18	A1*,B1*
	4	21	A1*,B1	21	A1,B1*
	5	25	A1,B1	25	A1,B1
	6	33	A1*,A2,B1*	33	A1*,B1*,B2
	7	37	A1*,A2,B1	37	A1,B1*,B2
	8	41	A1,A2,B1	41	A1,B1,B2
	9	49	A1*,A2,B1*,B2	49	A1*,A2,B1*,B2
	10	53	A1*,A2,B1,B2	53	A1,A2,B1*,B2
	11	56	A1,A2,B1,B2	56	A1,A2,B1,B2
	12	71	A1*,A2,A3,B1*,B2	71	A1*,A2,B1*,B2,B3
	13	74	A1*,A2,A3,B1,B2	74	A1,A2,B1*,B2,B3
	14	78	A1,A2,A3,B1,B2	78	A1,A2,B1,B2,B3
	15	93	A1*,A2,A3,B1*,B2,B3	93	A1*,A2,A3,B1*,B2,B3
	16	96	A1*,A2,A3,B1,B2,B3	96	A1,A2,A3,B1*,B2,B3
	17	100	A1,A2,A3,B1,B2,B3	100	A1,A2,A3,B1,B2,B3
190, 290A, 360A, 390B (50 Hz) A1,B1	1	17	A1	17	B1
	2	33	A1,B1	33	A1,B1
	3	50	A1,A2,B1	50	A1,B1,B2
	4	67	A1,A2,B1,B2	67	A1,A2,B1,B2
	5	83	A1,A2,A3,B1,B2	83	A1,A2,B1,B2,B3
	6	100	A1,A2,A3,B1,B2,B3	100	A1,A2,A3,B1,B2,B3
190, 290A, 360A, 390B (50 Hz) A1**,B1	1	11	A1*	—	—
	2	17	A1	—	—
	3	28	A1*,B1	—	—
	4	33	A1,B1	—	—
	5	44	A1*,A2,B1	—	—
	6	50	A1,A2,B1	—	—
	7	61	A1*,A2,B1,B2	—	—
	8	67	A1,A2,B1,B2	—	—
	9	78	A1*,A2,A3,B1,B2	—	—
	10	83	A1,A2,A3,B1,B2	—	—
	11	94	A1*,A2,A3,B1,B2,B3	—	—
	12	100	A1,A2,A3,B1,B2,B3	—	—

*Unloaded compressor.
 †Compressor unloader, standard.
 **Compressor unloader, accessory.
 ††Two unloaders, both unloaded.

NOTE: These capacity control steps may vary due to lag compressor sequencing.

Table 4C — Capacity Control Steps, 130-210 and Associated Modular Units (cont)

UNIT SIZE	CONTROL STEPS	LOADING SEQUENCE A		LOADING SEQUENCE B	
		% Displacement (Approx)	Compressors	% Displacement (Approx)	Compressors
190, 290A, 360A, 390B (50 Hz) A1,B1**	1	—	—	11	B1*
	2	—	—	17	B1
	3	—	—	28	A1,B1*
	4	—	—	33	A1,B1
	5	—	—	44	A1,B1*,B2
	6	—	—	50	A1,B1,B2
	7	—	—	61	A1,A2,B1*,B2
	8	—	—	67	A1,A2,B1,B2
	9	—	—	78	A1,A2,B1*,B2,B3
	10	—	—	83	A1,A2,B1,B2,B3
	11	—	—	94	A1,A2,A3,B1*,B2,B3
	12	—	—	100	A1,A2,A3,B1,B2,B3
190, 290A, 360A, 390B (50 Hz) A1**,B1**	1	11	A1*	11	B1*
	2	17	A1	17	B1
	3	22	A1*,B1*	22	A1*,B1*
	4	28	A1*,B1	28	A1,B1*
	5	33	A1,B1	33	A1,B1
	6	39	A1*,A2,B1*	39	A1*,B1*,B2
	7	44	A1*,A2,B1	44	A1,B1*,B2
	8	50	A1,A2,B1	50	A1,B1,B2
	9	55	A1*,A2,B1*,B2	55	A1*,A2,B1*,B2
	10	61	A1*,A2,B1,B2	61	A1,A2,B1*,B2
	11	67	A1,A2,B1,B2	67	A1,A2,B1,B2
	12	72	A1*,A2,A3,B1*,B2	72	A1*,A2,B1*,B2,B3
	13	78	A1*,A2,A3,B1,B2	78	A1,A2,B1*,B2,B3
	14	83	A1,A2,A3,B1,B2	83	A1,A2,B1,B2,B3
	15	89	A1*,A2,A3,B1*,B2,B3	89	A1*,A2,A3,B1*,B2,B3
	16	94	A1*,A2,A3,B1,B2,B3	94	A1,A2,A3,B1*,B2,B3
	17	100	A1,A2,A3,B1,B2,B3	100	A1,A2,A3,B1,B2,B3
210, 315A, 390A, 420A/B (60 Hz) A1,B1	1	11	A1	14	B1
	2	25	A1,B1	25	A1,B1
	3	36	A1,A2,B1	44	A1,B1,B2
	4	56	A1,A2,B1,B2	56	A1,A2,B1,B2
	5	67	A1,A2,A3,B1,B2	75	A1,A2,B1,B2,B3
	6	86	A1,A2,A3,B1,B2,B3	86	A1,A2,A3,B1,B2,B3
	7	100	A1,A2,A3,A4,B1,B2,B3	100	A1,A2,A3,A4,B1,B2,B3
210, 315A, 390A, 420A/B (60 Hz) A1**,B1	1	8	A1*	—	—
	2	11	A1	—	—
	3	22	A1*,B1	—	—
	4	25	A1,B1	—	—
	5	33	A1*,A2,B1	—	—
	6	36	A1,A2,B1	—	—
	7	52	A1*,A2,B1,B2	—	—
	8	56	A1,A2,B1,B2	—	—
	9	63	A1*,A2,A3,B1,B2	—	—
	10	67	A1,A2,A3,B1,B2	—	—
	11	83	A1*,A2,A3,B1,B2,B3	—	—
	12	86	A1,A2,A3,B1,B2,B3	—	—
	13	97	A1*,A2,A3,A4,B1,B2,B3	—	—
	14	100	A1,A2,A3,A4,B1,B2,B3	—	—
210, 315A, 390A, 420A/B (60 Hz) A1,B1**	1	—	—	9	B1*
	2	—	—	14	B1
	3	—	—	21	A1,B1*
	4	—	—	25	A1,B1
	5	—	—	40	A1,B1*,B2
	6	—	—	44	A1,B1,B2
	7	—	—	51	A1,A2,B1*,B2
	8	—	—	56	A1,A2,B1,B2
	9	—	—	71	A1,A2,B1*,B2,B3
	10	—	—	75	A1,A2,B1,B2,B3
	11	—	—	82	A1,A2,A3,B1*,B2,B3
	12	—	—	86	A1,A2,A3,B1,B2,B3
	13	—	—	96	A1,A2,A3,A4,B1*,B2,B3
	14	—	—	100	A1,A2,A3,A4,B1,B2,B3

NOTE: These capacity control steps may vary due to lag compressor sequencing.

*Unloaded compressor.
 †Compressor unloader, standard.
 **Compressor unloader, accessory.
 ††Two unloaders, both unloaded.

Table 4C — Capacity Control Steps, 130-210 and Associated Modular Units (cont)

UNIT SIZE	CONTROL STEPS	LOADING SEQUENCE A		LOADING SEQUENCE B	
		% Displacement (Approx)	Compressors	% Displacement (Approx)	Compressors
210, 315A, 390A, 420A/B (60 Hz) A1**,B1**	1	8	A1*	9	B1*
	2	11	A1	14	B1
	3	17	A1*,B1*	17	A1*,B1*
	4	22	A1*,B1	21	A1,B1*
	5	25	A1,B1	25	A1,B1
	6	28	A1*,A2,B1*	37	A1*,B1*,B2
	7	33	A1*,A2,B1	40	A1,B1*,B2
	8	36	A1,A2,B1	44	A1,B1,B2
	9	48	A1*,A2,B1*,B2	48	A1*,A2,B1*,B2
	10	52	A1*,A2,B1,B2	51	A1,A2,B1*,B2
	11	56	A1,A2,B1,B2	56	A1,A2,B1,B2
	12	59	A1*,A2,A3,B1*,B2	67	A1*,A2,B1*,B2,B3
	13	63	A1*,A2,A3,B1,B2	71	A1,A2,B1*,B2,B3
	14	67	A1,A2,A3,B1,B2	75	A1,A2,B1,B2,B3
	15	78	A1*,A2,A3,B1*,B2,B3	78	A1*,A2,A3,B1*,B2,B3
	16	83	A1*,A2,A3,B1,B2,B3	82	A1,A2,A3,B1*,B2,B3
	17	86	A1,A2,A3,B1,B2,B3	86	A1,A2,A3,B1,B2,B3
	18	92	A1*,A2,A3,A4,B1*,B2,B3	92	A1*,A2,A3,A4,B1*,B2,B3
	19	97	A1*,A2,A3,A4,B1,B2,B3	96	A1,A2,A3,A4,B1*,B2,B3
	20	100	A1,A2,A3,A4,B1,B2,B3	100	A1,A2,A3,A4,B1,B2,B3
210, 315A, 390A, 420A/B (50 Hz) A1,B1	1	9	A1	16	B1
	2	26	A1,B1	26	A1,B1
	3	35	A1,A2,B1	42	A1,B1,B2
	4	51	A1,A2,B1,B2	51	A1,A2,B1,B2
	5	67	A1,A2,A3,B1,B2	67	A1,A2,B1,B2,B3
	6	84	A1,A2,A3,B1,B2,B3	84	A1,A2,A3,B1,B2,B3
	7	100	A1,A2,A3,A4,B1,B2,B3	100	A1,A2,A3,A4,B1,B2,B3
210, 315A, 390A, 420A/B (50 Hz) A1**,B1	1	6	A1*	—	—
	2	9	A1	—	—
	3	23	A1*,B1	—	—
	4	26	A1,B1	—	—
	5	32	A1*,A2,B1	—	—
	6	35	A1,A2,B1	—	—
	7	48	A1*,A2,B1,B2	—	—
	8	51	A1,A2,B1,B2	—	—
	9	65	A1*,A2,A3,B1,B2	—	—
	10	67	A1,A2,A3,B1,B2	—	—
	11	81	A1*,A2,A3,B1,B2,B3	—	—
	12	84	A1,A2,A3,B1,B2,B3	—	—
	13	97	A1*,A2,A3,A4,B1,B2,B3	—	—
	14	100	A1,A2,A3,A4,B1,B2,B3	—	—
210, 315A, 390A, 420A/B (50 Hz) A1,B1**	1	—	—	11	B1*
	2	—	—	16	B1
	3	—	—	20	A1,B1*
	4	—	—	26	A1,B1
	5	—	—	36	A1,B1*,B2
	6	—	—	42	A1,B1,B2
	7	—	—	46	A1,A2,B1*,B2
	8	—	—	51	A1,A2,B1,B2
	9	—	—	62	A1,A2,B1*,B2,B3
	10	—	—	67	A1,A2,B1,B2,B3
	11	—	—	78	A1,A2,A3,B1*,B2,B3
	12	—	—	84	A1,A2,A3,B1,B2,B3
	13	—	—	94	A1,A2,A3,A4,B1*,B2,B3
	14	—	—	100	A1,A2,A3,A4,B1,B2,B3
210, 315A, 390A, 420A/B (50 Hz) A1**,B1**	1	7	A1*	11	B1*
	2	9	A1	16	B1
	3	17	A1*,B1*	17	A1*,B1*
	4	23	A1*,B1	20	A1,B1*
	5	26	A1,B1	26	A1,B1
	6	27	A1*,A2,B1*	34	A1*,B1*,B2
	7	32	A1*,A2,B1	36	A1,B1*,B2
	8	35	A1,A2,B1	42	A1,B1,B2
	9	43	A1*,A2,B1*,B2	43	A1*,A2,B1*,B2
	10	48	A1*,A2,B1,B2	46	A1,A2,B1*,B2
	11	51	A1,A2,B1,B2	51	A1,A2,B1,B2
	12	59	A1*,A2,A3,B1*,B2	59	A1*,A2,B1*,B2,B3
	13	65	A1*,A2,A3,B1,B2	62	A1,A2,B1*,B2,B3
	14	67	A1,A2,A3,B1,B2	67	A1,A2,B1,B2,B3
	15	75	A1*,A2,A3,B1*,B2,B3	75	A1*,A2,A3,B1*,B2,B3
	16	81	A1*,A2,A3,B1,B2,B3	78	A1,A2,A3,B1*,B2,B3
	17	84	A1,A2,A3,B1,B2,B3	84	A1,A2,A3,B1,B2,B3
	18	92	A1*,A2,A3,A4,B1*,B2,B3	92	A1*,A2,A3,A4,B1*,B2,B3
	19	97	A1*,A2,A3,A4,B1,B2,B3	94	A1,A2,A3,A4,B1*,B2,B3
	20	100	A1,A2,A3,A4,B1,B2,B3	100	A1,A2,A3,A4,B1,B2,B3

*Unloaded compressor.
 †Compressor unloader, standard.
 **Compressor unloader, accessory.
 ††Two unloaders, both unloaded.

NOTE: These capacity control steps may vary due to lag compressor sequencing.

Head Pressure Control

EXV UNITS (All 30GN units except 040 and 045 with optional brine) — The microprocessor controls the condenser fans in order to maintain the lowest condensing temperature possible, thus the highest unit efficiency. Instead of using the conventional head pressure control methods, the fans are controlled by the position of the EXV and suction superheat.

As the condensing temperature drops, the EXV opens to maintain the proper suction superheat. Once the EXV is fully open, if the condensing temperature continues to drop, the suction superheat begins to rise. Once the suction superheat is greater than 40 F (22.2 C), a fan stage is removed after 2 minutes.

As the condensing temperature rises, the EXV closes to maintain the proper suction superheat. Once the EXV has closed to 39.5% open (600 steps open), a fan stage is added after 2 minutes.

During start-up, all the condenser fans are started when the condensing temperature reaches 95 F (35 C) to prevent excessive discharge pressure during pull-down. See Table 5 for condenser fan sequence of operation.

For low-ambient operation, the lead fan in each circuit can be equipped with the optional or accessory Motormaster® III head pressure controller. This control has its own sensor which is mounted on a return bend in the liquid portion of the condenser. It will vary the fan speed to maintain a saturated condensing temperature of 100 F. The controls automatically default to condensing temperature control during this first stage of condenser-fan operation. When subsequent fan stages start, the controls revert to EXV fan control.

TXV UNITS (30GN040,045 with optional brine only) — Head pressure control is based on set point control. The microprocessor stages the condenser fans to maintain the set point temperature specified by the controller.

Pumpout

EXV UNITS — When the lead compressor in each circuit is started or stopped, that circuit goes through a pumpout cycle to purge the cooler and refrigerant suction lines of refrigerant.

The pumpout cycle starts immediately upon starting the lead compressor and continues until the saturated suction temperature is 10° F (5.6° C) below the saturated suction temperature at start-up, is 10° F (5.6° C) below the cooler leaving fluid temperature, or reaches a saturated suction temperature of -15 F (-26 C). No pumpout is necessary if the saturated suction temperature is below -15 F (-26 C). At this point, the EXV starts to open and continues to open gradually to provide a controlled start-up to prevent liquid flood-back to the compressor.

At shutdown, the pumpout cycle continues until the saturated suction temperature for that circuit is 10° F (5.5° C) below the saturated suction temperature when pumpout is initiated, or saturated suction temperature reaches -15 F (-26 C). At that point, the compressor shuts down and the EXV continues to move until fully closed.

TXV UNITS — Pumpout is based on timed pumpout. On a command for start-up, the lead compressor starts. After 10 seconds, the liquid line solenoid opens. At shutdown, the liquid line solenoid closes, and the lead compressor continues to run for 10 seconds before stopping.

Keypad and Display Module (Also Called HSI0 or LID) — The only function of this module is to allow the operator to communicate with the processor. It is used to enter configurations and set points and to read data, perform tests, and set schedules. This device consists of a keypad with 6 function keys, 5 operative keys, 12 numeric keys (0 to 9, *, and -), and an alphanumeric, 8-character LCD. See Fig. 4. See Table 6 for key usage.

IMPORTANT: When entering multiple character inputs beginning with a zero, a decimal point must be entered in place of the first zero. When entering an input of zero, only the decimal point need be entered.

ACCESSING FUNCTIONS AND SUBFUNCTIONS — See Tables 6 - 8. Table 7 shows the 6 functions (identified by name) and the subfunctions (identified by number).

AUTOMATIC DEFAULT DISPLAY — When keypad has not been used for 10 minutes, display automatically switches to the rotating automatic default display. This display has 7 parts, listed below, which appear in continuous rotating sequence.

DISPLAY	EXPANSION
TUE 15:45	TODAY IS TUE, TIME IS 15:45 (3:45 PM)
LOCAL ON	UNIT IN LOCAL MODE
CLOCK ON	UNIT IS ON VIA CLOCK SCHEDULE
8 MODE	TEMPERATURE RESET IN EFFECT
COOL 1	NUMBER OF STAGES IS 1
2 ALARMS	THERE ARE 2 ALARMS
3 MINS	3 MINUTES REMAINING IN THE OFF-TO-ON TIME DELAY

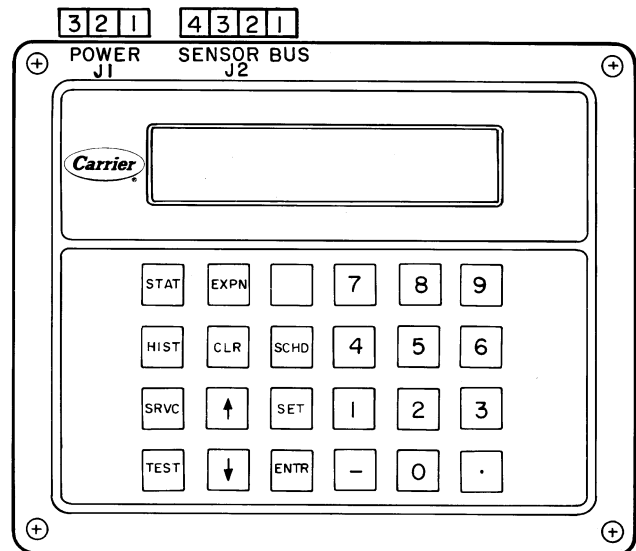
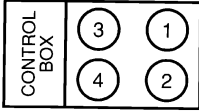
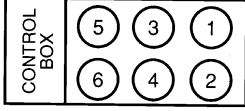
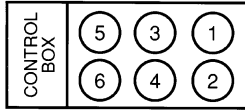
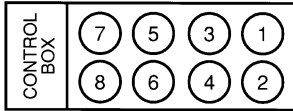
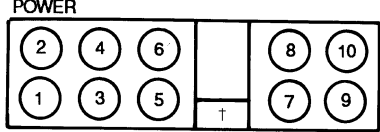
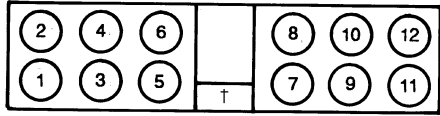

Fig. 4 — Keypad and Display Module

Table 5 — Condenser Fan Sequence

FAN ARRANGEMENT 30GN	FAN NUMBER(S)	FAN CONTACTOR (FC)	CONTROLLED BY	
040-050 	1	FC-A1	Compressor A1	
	2	FC-B1	Compressor B1	
	3	FC-A2	First Stage Microprocessor	
	4	FC-B2	Second Stage Microprocessor	
060,070 	1	FC-A1	Compressor A1	
	2	FC-B1	Compressor B1	
	3, 4	FC-A2	First Stage Microprocessor	
080,090 (and associated modular units*) 	1	FC-A1	Compressor A1	
	2	FC-B1	Compressor B1	
	3	FC-A2	First Stage Microprocessor	
	4	FC-B2		
	3, 4, 5, 6	FC-A2, FC-B2, FC-A3, FC-B3	Second Stage Microprocessor	
100,110 (and associated modular units*) 	1	FC-A1	Compressor A1	
	2	FC-B1	Compressor B1	
	3	FC-A2	First Stage Microprocessor	
	4	FC-B2		
	5, 7, 6, 8	FC-A3, FC-B3	Second Stage Microprocessor	
	3, 4, 5, 6, 7, 8	FC-A2, FC-A3, FC-B2, FC-B3	Third Stage Microprocessor	
130-170 (and associated modular units*) 	5, 7	FC-A1	Compressor A1	
	6, 8	FC-B1	Compressor B1	
	3, 9	FC-A2	First Stage Microprocessor	
	4, 10	FC-B2		
	1, 3, 9	FC-A2, FC-A3	Second Stage Microprocessor	
	2, 4, 10	FC-B2, FC-B3		
	190,210 (and associated modular units*) 	5, 7	FC-A1	Compressor A1
		6, 8	FC-B1	Compressor B1
3, 9		FC-A2	First Stage Microprocessor	
4, 10		FC-B2		
1, 3, 9, 11		FC-A2, FC-A3	Second Stage Microprocessor	
2, 4, 10, 12		FC-B2, FC-B3		

*See Table 1.
†Control box.

AUTOMATIC DISPLAY OPERATION/DEFAULT DISPLAY — This display automatically rotates as follows:

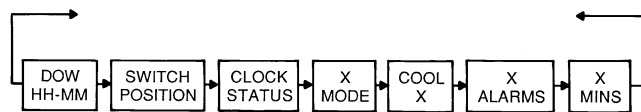

DOW — Day of Week
HH — Hour(s)
MM — Minute(s)

The default rotating display is displayed every 2 seconds if there has been no manual input from the keypad for 10 minutes.

To return to automatic display, enter at any time.

KEYPAD OPERATING INSTRUCTIONS (Refer to Table 9.)

- White keys on left side of keypad are shown and operated in these instructions according to the following example: keypad entry means press the , then the white key marked .
- The standard display uses abbreviations. Expanded information scrolls through the display whenever key is pressed.

Table 6 — Keypad and Display Module Usage

FUNCTION KEYS	USE
	STATUS — For displaying diagnostic codes and current operating information about the machine. HISTORY — For displaying run time, cycles and previous alarms. SERVICE — For entering specific unit configuration information. TEST — For checking inputs and outputs for proper operation. SCHEDULE — For entering occupied/unoccupied schedules for unit operation. SET POINT — For entering operating set points and day/time information.
OPERATIVE KEYS	USE
	EXPAND — For displaying a non-abbreviated expansion of the display.
	CLEAR — For clearing the screen of all displays.
	UP ARROW — For returning to previous display position.
	DOWN ARROW — For advancing to next display position.
	ENTER — For entering data.

- All functions are made up of a group of subfunctions. To enter a subfunction, first press subfunction number desired. Then press the function key in which the subfunction resides. To move within that subfunction, press the or arrow. For example, a enters the Temperature Information subfunction.
- At any time, another subfunction may be entered by pressing the subfunction number, then the function key.
- Prior to starting unit, check leaving fluid set point for correct setting. Refer to Set Point Function section on page 38.
- Depending on system configuration, all displays may not be shown. All displays are shown unless marked with the following symbol:
‡Must be configured.

For additional unit start-up procedures, see separate Installation, Start-Up, and Service Instructions supplied with unit.

Table 7 — Functions and Subfunctions

SUBFUNCTION NO.	FUNCTIONS					
	Status 	Test 	Schedule 	Service 	History 	Set Point
1	Automatic Display	Outputs	Override	Log On and Log Off	Run Time	Set Points (Chiller Fluid)
2	Alarm Display	Compressors and Unloaders	Clock Select	Version (Software)	Starts	Reset Set Points
3	Mode (Operating) Display	Calibrate Transducers	Period 1	Factory Configuration	Alarm History	Demand Limit Set Points
4	Capacity Stages	—	Period 2	Field Configuration	—	Date and Time
5	Set Points (Current Operating)	—	Period 3	Service Configuration	—	Leaving Chiller Fluid Alert Limit
6	Temperatures	—	Period 4	—	—	—
7	Pressures	—	Period 5	—	—	—
8	Analog Inputs	—	Period 6	—	—	—
9	Discrete Inputs	—	Period 7	—	—	—
10	Outputs	—	Period 8	—	—	—
11	—	—	HOLIDAYS	—	—	—

Table 8 — Accessing Functions and Subfunctions

OPERATION	KEYPAD ENTRY	DISPLAY RESPONSE	EXPANSION
To access a function, press subfunction no. and function name key. Display shows subfunction group.	<input type="button" value="2"/> <input type="button" value="SET"/>	RESET	RESET SETPOINTS
To move to other elements, scroll up or down using arrow keys. NOTE: These displays do not show if control is not configured for reset.	<input type="button" value="↓"/> <input type="button" value="↓"/> <input type="button" value="↓"/> <input type="button" value="↓"/>	CRT1 x CRT2N x CRT2F x CRT2D x	COOL RESET AT 20 MA COOL RTEMP (NO RESET) COOL RTEMP (FULL RESET) COOL DEGREES RESET
When the last element in a subfunction has been displayed, the first element is repeated.	<input type="button" value="↓"/> <input type="button" value="↓"/>	RESET CRT1 x	RESET SETPOINTS COOL RESET AT 20 MA
To move to next subfunction it is not necessary to use subfunction number. Press function name key to advance display through all subfunctions within a function and then back to the first.	<input type="button" value="SET"/> <input type="button" value="SET"/> <input type="button" value="SET"/>	DEMAND TIME SETPOINT	DEMAND LIMIT SETPOINTS CURRENT TIME AND DAY OF WEEK UNIT SETPOINTS
To move to another function, either depress function name key for desired function (display shows the first subfunction), or Access a specific subfunction by using the subfunction number and the function name key.	<input type="button" value="STAT"/> <input type="button" value="4"/> <input type="button" value="STAT"/>	X ALARMS STAGE	THERE ARE n ALARMS CAPACITY STAGING INFORMATION

Table 9 — Keypad Directory

STATUS			
SUBFUNCTION	KEYPAD ENTRY	DISPLAY	COMMENT
1 AUTOMATIC DISPLAY	<input type="button" value="1"/> <input type="button" value="STAT"/>	Refer to Automatic Display Operation/Default Display section on page 25.	
2 ALARMS/ALERTS	<input type="button" value="2"/> <input type="button" value="STAT"/> <input type="button" value="↓"/> <input type="button" value="↓"/> <input type="button" value="↓"/> <input type="button" value="↓"/> <input type="button" value="↓"/> <input type="button" value="↓"/>	X ALARMS R S AL ALARM* X ALARM* X ALARM* X ALARM* X ALARM* X	Number of Tripped Alarms/Alerts Reset all Alarms/Alerts } Displays Tripped Alarms/Alerts
To toggle between inputs (Yes/No) Press: <input type="button" value="."/> <input type="button" value="ENTR"/> (no) or <input type="button" value="1"/> <input type="button" value="ENTR"/> (yes)			
3 MODES	<input type="button" value="3"/> <input type="button" value="STAT"/> <input type="button" value="↓"/> <input type="button" value="↓"/> <input type="button" value="↓"/> <input type="button" value="↓"/>	X MODES X MODE X MODE X MODE X MODE	Number of Modes in Effect } Displays Mode in Effect

Table 9 — Keypad Directory (cont)

STATUS (cont)			
SUBFUNCTION	KEYPAD ENTRY	DISPLAY	COMMENT
4 STAGE	4 STAT	STAGE	Capacity Staging Information
	↓	COOL X	Number of Requested Stages
	↓	CAPT X	Percent of Total Capacity
	↓	CAPA X	Percent Circuit A Total Capacity
	↓	CAPB X	Percent Circuit B Total Capacity
	↓	AVAIL X	Percent Available Capacity
	↓	AV A X	Percent Circuit A Available Capacity
	↓	AV B X	Percent Circuit B Available Capacity
	↓	LMT X†	Demand Limit Set Point (percent)
	↓	CIRA X	Circuit A Compressor Relay Status
	↓	CIRB X	Circuit B Compressor Relay Status
	↓	SMZ X	Load/Unload Factor for Compressors Factor = 1 Unloader Factor = 0.6
	5 SET POINT	5 STAT	SETPOINT
↓		SET X	Set Point (F)
↓		MSP X	Modified Set Point = Set Point + Reset (F)
↓		TW X	Actual Control Temperature (F)
6 TEMPERATURE	6 STAT	TEMPS	Temperature Information (F)
	↓	EWT X	Cooler Entering Fluid Temperature (F)
	↓	LWT X	Cooler Leaving Fluid Temperature (F)
	↓	SCTA X	Circuit A Saturated Condenser Temperature (F)
	↓	SSTA X	Circuit A Saturated Suction Temperature (F)
	↓	CTA X	Compressor A1 Suction Temperature (F)
	↓	SHA X	Circuit A Suction Superheat (F)
	↓	SCTB X	Circuit B Saturated Condenser Temperature (F)
	↓	SSTB X	Circuit B Saturated Suction Temperature (F)
	↓	CTB X	Compressor B1 Suction Temperature (F)
	↓	SHB X	Circuit B Suction Superheat (F)
	↓	SPC X	Space Temperature (F)
	↓	OAT X	Outdoor-Air Temperature (F)

LEGEND

- CCN** — Carrier Comfort Network
- EXV** — Electronic Expansion Valve
- MOP** — Maximum Operating Pressure

*Will read ALARM or ALERT as appropriate.

†Must be configured.

**If applicable.

††Not manually resettable.

NOTE: If metric option is selected under 4 SRVC, temperature expressed as Celsius and pressure will be expressed as kPa.

Table 9 — Keypad Directory (cont)

STATUS (cont)			
SUBFUNCTION	KEYPAD ENTRY	DISPLAY	COMMENT
7 PRESSURE	7 <input type="button" value="STAT"/>	PRESSURE	Refrigerant System Pressure (psig)
	<input type="button" value="↓"/>	MM DD YY	Date of Last Calibration
	<input type="button" value="↓"/>	DPA X	Circuit A Discharge Pressure (psig)
	<input type="button" value="↓"/>	SPA X	Circuit A Suction Pressure (psig)
	<input type="button" value="↓"/>	XXXX XXX	Circuit A Discharge/Suction (psig)
	<input type="button" value="↓"/>	OPA X	Circuit A Oil Pressure Differential (psig)
	<input type="button" value="↓"/>	DPB X	Circuit B Discharge Pressure (psig)
	<input type="button" value="↓"/>	SPB X	Circuit B Suction Pressure (psig)
	<input type="button" value="↓"/>	XXXX XXX	Circuit B Discharge/Suction (psig)
<input type="button" value="↓"/>	OPB X	Circuit B Oil Pressure Differential (psig)	
8 ANALOG	8 <input type="button" value="STAT"/>	ANALOG	Status of Analog Inputs
	<input type="button" value="↓"/>	REF X	Transducer Supply Voltage (volts)
	<input type="button" value="↓"/>	LMT X†	Demand 4-20 mA Signal (mA)
	<input type="button" value="↓"/>	RST X†	Reset 4-20 mA Signal (mA)
9 INPUTS	9 <input type="button" value="STAT"/>	SW INPUT	Status of Switch Inputs
	<input type="button" value="↓"/>	SPW X†	Dual Set Point Switch (open/closed)
	<input type="button" value="↓"/>	DL1 X†	Demand Limit Switch 1 (open/closed)
<input type="button" value="↓"/>	DL2 X†	Demand Limit Switch 2 (open/closed)	
10 OUTPUTS	10 <input type="button" value="STAT"/>	OUTPUTS	Status of Outputs
	<input type="button" value="↓"/>	ALMR X	Alarm Relay K3 (on/off)
	<input type="button" value="↓"/>	FRA1 X	Fan Relay K1 (on/off)
	<input type="button" value="↓"/>	FRA2 X	Fan Relay K2 (on/off)
	<input type="button" value="↓"/>	FRB1 X	Fan Relay K4 (on/off)
	<input type="button" value="↓"/>	FRB2 X	Fan Relay K5 (on/off)
	<input type="button" value="↓"/>	CHWP X†	Cooler Water Pump Relay K6 (on/off)
	<input type="button" value="↓"/>	ULA1 X	Unloader A1 (on/off)**
	<input type="button" value="↓"/>	ULA2 X†	Unloader A2 (on/off)**
	<input type="button" value="↓"/>	ULB1 X	Unloader B1 (on/off)**
	<input type="button" value="↓"/>	ULB2 X†	Unloader B2 (on/off)**
	<input type="button" value="↓"/>	LLSA X	Liquid Line Solenoid A
	<input type="button" value="↓"/>	LLSB X	Liquid Line Solenoid B
<input type="button" value="↓"/>	EXVA X	EXVA Percent Open†	

LEGEND

- CCN** — Carrier Comfort Network
- EXV** — Electronic Expansion Valve
- MOP** — Maximum Operating Pressure

*Will read ALARM or ALERT as appropriate.

†Must be configured.

**If applicable.

††Not manually resettable.

NOTE: If metric option is selected under , temperature expressed as Celsius and pressure will be expressed as kPa.

Table 9 — Keypad Directory (cont)

STATUS (cont)

SUBFUNCTION	KEYPAD ENTRY	DISPLAY	COMMENT
10 OUTPUTS (cont)		EXVB X	EXVB Percent Open**
		HGBA X†	Hot Gas Bypass Relay Circuit A (on/off)**
		HGBB X†	Hot Gas Bypass Relay Circuit B (on/off)**
		MMA X†	Motormaster® A Output Percent**
		MMB X†	Motormaster B Output Percent**

TEST

To use Test function, LOCAL/ENABLE-STOP-CCN switch must be in STOP position. To operate a test, scroll to desired test. Then, press to start test. Press to stop test.

SUBFUNCTION	KEYPAD ENTRY	DISPLAY	COMMENT
1 OUTPUTS		OUTPUTS	Test Outputs
		8.8.8.8.8.8.8.8	Display Check
		ALMR X	Energize Alarm Relay K3 (on/off)
		FRA1 X	Energize Fan Relay A1 K1 (on/off)
		FRA2 X	Energize Fan Relay A2 K2 (on/off)
		FRB1 X	Energize Fan Relay B1 K4 (on/off)
		FRB2 X	Energize Fan Relay B2 K5 (on/off)
		CHWP X†	Energize Cooler Water Pump K6 (on/off)
		LSVA X	Energize Liquid Line Solenoid A (on/off)**
		LSVB X	Energize Liquid Line Solenoid B (on/off)**
		EXVA X	Enter Desired EXVA Position (percent)**
		EXVB X	Enter Desired EXVB Position (percent)**
		HGBA X†	Energize Hot Gas Bypass Relay A (on/off)**
		HGBB X†	Energize Hot Gas Bypass Relay B (on/off)**
		MMA X†	Enter Desired Motormaster A Output Signal (percent)**
	MMB X†	Enter Desired Motormaster B Output Signal (percent)**	

To toggle between inputs (Yes/No) Press: (no) or (yes)

⚠ WARNING

During compressor test, compressors start and run for 10 seconds. Compressor service valves and liquid line valves must be open. Energize crankcase heaters 24 hours prior to performing compressor tests.

SUBFUNCTION	KEYPAD ENTRY	DISPLAY	COMMENT
2 COMPRESSORS AND UNLOADERS		COMP	Compressor and Unloader Test
		CPA1 X	Test Compressor A1 (on/off)
		CPA2 X†	Test Compressor A2 (on/off)**

Table 9 — Keypad Directory (cont)

TEST (cont)			
SUBFUNCTION	KEYPAD ENTRY	DISPLAY	COMMENT
2 COMPRESSORS AND UNLOADERS (cont)	↓	CPA3 X†	Test Compressor A3 (on/off)**
	↓	CPA4 X†	Test Compressor A4 (on/off)**
	↓	CPB1 X	Test Compressor B1 (on/off)
	↓	CPB2 X†	Test Compressor B2 (on/off)**
	↓	CPB3 X†	Test Compressor B3 (on/off)**
	↓	CPB4 X†	Test Compressor B4 (on/off)**
	↓	UNA1 X	Energize Unloader A1 (on/off)**
	↓	UNA2 X†	Energize Unloader A2 (on/off)**
	↓	UNB1 X	Energize Unloader B1 (on/off)**
	↓	UNB2 X†	Energize Unloader B2 (on/off)**
3 CALIBRATE TRANSDUCERS	3 TEST	XDR CAL	Transducer Calibration
	↓	CDPA X	Circuit A Discharge Pressure (psig)
	↓	CSPA X	Circuit A Suction Pressure (psig)
	↓	COPA X	Circuit A Oil Pressure (psig)
	↓	CDPB X	Circuit B Discharge Pressure (psig)
	↓	CSPB X	Circuit B Suction Pressure (psig)
	↓	COPB X	Circuit B Oil Pressure (psig)

SCHEDULE

The Schedule function key is used to configure the occupancy schedule. The clock select subfunction can be used for unoccupied shutdown or unoccupied setback depending on the cooling set point control configuration. The Schedule function described is for clock 1, which is the internal clock. Password required for all subfunctions except override.

SUBFUNCTION	KEYPAD ENTRY	DISPLAY	COMMENT
1 OVERRIDE For example, to extend current occupied mode for 3 hrs, press:	1 <input type="button" value="SCHD"/>	OVRD X	Number of Override Hrs (0 - 4 Hrs)
	3 <input type="button" value="ENTR"/>	OVRD 3	Extended Occupied Time
2 CLOCK SELECT	2 <input type="button" value="SCHD"/>	CLOCK XX	Type of Clock Control 0 = No Clock, 1 = Clock 1 (Internal)
3 PERIOD 1 Yes = Schedule Operational for that day	3 <input type="button" value="SCHD"/>	PERIOD 1	Period 1 Time Schedule
	↓	OCC HH.MM	Occupied Time
	↓	UNO HH.MM	Unoccupied Time
	↓	MON X	Monday Flag (yes/no)
	↓	TUE X	Tuesday Flag (yes/no)
	↓	WED X	Wednesday Flag (yes/no)
↓	THU X	Thursday Flag (yes/no)	

LEGEND

CCN — Carrier Comfort Network
EXV — Electronic Expansion Valve
MOP — Maximum Operating Pressure

*Will read ALARM or ALERT as appropriate.

†Must be configured.

**If applicable.

††Not manually resettable.

NOTE: If metric option is selected under , temperature expressed as Celsius and pressure will be expressed as kPa.

Table 9 — Keypad Directory (cont)

SCHEDULE (cont)

SUBFUNCTION	KEYPAD ENTRY	DISPLAY	COMMENT
3 PERIOD 1 (cont)	↓	FRI X	Friday Flag (yes/no)
	↓	SAT X	Saturday Flag (yes/no)
	↓	SUN X	Sunday Flag (yes/no)
	↓	HOL X	Holiday Flag (yes/no)
To toggle between inputs (Yes/No) Press: <input type="checkbox"/> ENTR (no) or <input type="checkbox"/> 1 ENTR (yes)			
4 PERIOD 2	<input type="checkbox"/> 4 <input type="checkbox"/> SCHD	PERIOD 2	Period 2 Time Schedule
5 PERIOD 3 ... 9 PERIOD 7	<input type="checkbox"/> 5 <input type="checkbox"/> SCHD ... <input type="checkbox"/> 9 <input type="checkbox"/> SCHD	PERIOD 3 ... PERIOD 7	Period 3 ... Period 7 Time Schedule
10 PERIOD 8	<input type="checkbox"/> 10 <input type="checkbox"/> SCHD	PERIOD 8	Period 8 Time Schedule
11 HOLIDAYS New = Unassigned Holiday Date	<input type="checkbox"/> 11 <input type="checkbox"/> SCHD	HOLIDAYS	Define Calendar Holidays
	↓	DAT MM.DD	Holiday Date 1
	↓		
	↓	DAT MM.DD.NN	Holiday Date 30

For example: To enter July 4th holiday press: 07.04.01 **ENTR** . Display shows Jul 04. For further information on the Schedule function and its operation, refer to Schedule Function section on page 44.

SERVICE

To view and modify configurations, the password must be entered under the log on subfunction.

SUBFUNCTION	KEYPAD ENTRY	DISPLAY	COMMENT
1 LOG ON AND LOG OFF	<input type="checkbox"/> 1 <input type="checkbox"/> SRVC	PASSWORD	Enter Password/Disable Password Protection
	<input type="checkbox"/> 1 <input type="checkbox"/> 1 <input type="checkbox"/> 1 <input type="checkbox"/> 1 <input type="checkbox"/> ENTR	LOGGEDON	Logged On
	At this time, configurations may be modified. When finished viewing and/or modifying configurations, log out as follows:		
	<input type="checkbox"/> 1 <input type="checkbox"/> SRVC	LOGGEDON	—
	↓	LOG OFF	Disable Password Protection
	<input type="checkbox"/> ENTR	EXIT LOG	Logged Off/Enable Password Protection
2 VERSION	<input type="checkbox"/> 2 <input type="checkbox"/> SRVC	VERSION	Software Information
	↓	XXXXXXXX	Version No. of Software (CESRXX)

The next 3 subfunctions provide the ability to modify configurations. Refer to separate Installation, Start-Up, and Service Instructions supplied with unit for further information on changing configurations.

To change a configuration, enter the new configuration and press **ENTR** while on the correct configuration.

3 FACTORY CONFIGURATION	<input type="checkbox"/> 3 <input type="checkbox"/> SRVC	FACT CFG	Factory Configuration Codes
	↓	XXXXXXXX	Configuration Code 1
	↓	XXXXXXXX	Configuration Code 2
	↓	XXXXXXXX	Configuration Code 3
	↓	XXXXXXXX	Configuration Code 4

Table 9 — Keypad Directory (cont)

SERVICE (cont)			
SUBFUNCTION	KEYPAD ENTRY	DISPLAY	COMMENT
3 FACTORY CONFIGURATION (cont)	↓	XXXXXXXX	Configuration Code 5
	↓	XXXXXXXX	Configuration Code 6
	↓	XXXXXXXX	Configuration Code 7
4 FIELD CONFIGURATION	4 <input type="checkbox"/> SRVC	FLD CFG	Adjustable Field Configuration
	↓	ENO X	CCN Element Address
	↓	BUS X	CCN Bus Number
	↓	BAUD X	CCN Baud Rate
	↓	FLUID X	Cooler Fluid Select (water/medium brine)
	↓	UNITS X	Display Unit Select (English/Metric)
	↓	DELAY X	Delay at Power Up (minutes)
	↓	NULA X	No. Circuit A Unloaders
	↓	NULB X	No. Circuit B Unloaders
	↓	HGB X	Hot Gas Bypass Select (used, not used)
	↓	SEQT X	Loading Sequence Select (equal circuit, staged circuit)
	↓	LEADT X	Lead/Lag Sequence Type
	↓	OPS X	Oil Pressure Switch Select (enable/disable)
	↓	HEADT X	Head Pressure Control Type (none, air cooled, water cooled)
	↓	MM X	Motormaster® Select
	↓	CSPTYP X	Cooling Set Point Control Select
	↓	CRTYP X	Cooling Reset Control Select
	↓	ERTYP X	External Reset Sensor Select
	↓	OATSEL X	Outdoor-Air Sensor Select
	↓	LSTYP X	Demand Limit Control Select
	↓	RAMP X	Ramp Load Select (enable, disable)
↓	LOCK X	Cooler Pump Interlock Select	
↓	CPC X	Cooler Pump Control Select	
↓	REMA X	Remote Alarm Option Select (yes/no)	
↓	ALRST X	Allow Local/Stop/CCN Reset of Alarms (yes/no)	

To toggle between inputs (Yes/No) Press: ENTR (no) or 1 ENTR (yes)

5 SERVICE CONFIGURATION	5 <input type="checkbox"/> SRVC	SRV CFG	Service Configurations
	↓	XXXXXXXX	Configuration Code 8
	↓	XXXXXXXX	Configuration Code 9
	↓	REFRIG X	Refrigerant
	↓	TDTYP X	Pressure Transducer Select
	↓	OPS X	Oil Transducer Set Point (psig)
	↓	LPS X	Low Pressure Set Point (psig)
	↓	FANTYP X	Fan Staging Select
	↓	SH X	EXV Superheat Set Point (F)
	↓	MOP X	EXV MOP Set Point (F)
	↓	ZM X	Z Multiplier

LEGEND
CCN — Carrier Comfort Network
EXV — Electronic Expansion Valve
MOP — Maximum Operating Pressure
 *Will read ALARM or ALERT as appropriate.
 †Must be configured.

**If applicable.
 ††Not manually resettable.
 NOTE: If metric option is selected under 4 SRVC, temperature expressed as Celsius and pressure will be expressed as kPa.

Table 9 — Keypad Directory (cont)

HISTORY

SUBFUNCTION	KEYPAD ENTRY	DISPLAY	COMMENT
1 RUN TIME	1 HIST	RUN TIME	Run Time Information
	↓	HR X	Total Hrs Unit Has a Comp Operating
	↓	HRA X	Circuit A Run Time
	↓	HRB X	Circuit B Run Time
	↓	HA1 X	Circuit A, Comp A1 Operating Hours
	↓	HA2 X	Circuit A, Comp A2 Operating Hours**
	↓	HA3 X	Circuit A, Comp A3 Operating Hours**
	↓	HA4 X	Circuit A, Comp A4 Operating Hours**
	↓	HB1 X	Circuit B, Comp B1 Operating Hours
	↓	HB2 X	Circuit B, Comp B2 Operating Hours**
	↓	HB3 X	Circuit B, Comp B3 Operating Hours**
	↓	HB4 X	Circuit B, Comp B4 Operating Hours**
2 STARTS	2 HIST	STARTS	Starts Information
	↓	CY X	Cycles from Stage 0 to Stage 1
	↓	CYA X	Circuit A Starts
	↓	CYB X	Circuit B Starts
	↓	CA1 X	Circuit A, Comp A1 Starts
	↓	CA2 X	Circuit A, Comp A2 Starts**
	↓	CA3 X	Circuit A, Comp A3 Starts**
	↓	CA4 X	Circuit A, Comp A4 Starts**
	↓	CB1 X	Circuit B, Comp B1 Starts
	↓	CB2 X	Circuit B, Comp B2 Starts**
	↓	CB3 X	Circuit B, Comp B3 Starts**
	↓	CB4 X	Circuit B, Comp B4 Starts**
3 ALARM/ALERT HISTORY††	3 HIST	ALRMHIST	Last 10 Alarms/Alerts
	↓	ALARM X	} Alarm/Alert Description
	↓	ALARM X	
	↓	ALARM X	
	↓	ALARM X	
	↓	ALARM X	
	↓	ALARM X	
	↓	ALARM X	
	↓	ALARM X	
	↓	ALARM X	
	↓	ALARM X	

LEGEND

- CCN** — Carrier Comfort Network
- EXV** — Electronic Expansion Valve
- MOP** — Maximum Operating Pressure

*Will read ALARM or ALERT as appropriate.

†Must be configured.

**If applicable.































††Not manually resettable.

NOTE: If metric option is selected under **4** **SRVC**, temperature expressed as Celsius and pressure will be expressed as kPa.

Table 9 — Keypad Directory (cont)

SET POINT

To read a set point, go to proper subfunction and read desired set point. To change a set point, enter new set point value, then press . LOCAL/ENABLE-STOP-CCN switch must be in LOCAL/ENABLE or STOP position.

SUBFUNCTION	KEYPAD ENTRY	DISPLAY	COMMENT
1 SET POINTS	 	SET POINT	Unit Set Point
		CSP1 X	Chiller Fluid Set Point 1 (F)
		CSP2 X	Chiller Fluid Set Point 2 (F)
		HSPA X	Head Pressure Set Point Circuit A (F)
		HSPB X	Head Pressure Set Point Circuit B (F)
		CRAMP X	Cooling Ramp Loading Rate (F)
2 RESET SET POINTS	 	RESET	Reset Set Points
		CRT1 X	Cooling reset at 20 mA (F)
		CRT2N X	Reference Temperature at No Reset (F)
		CRT2F X	Reference Temperature at Full Reset (F)
		CRT2D X	Total Degrees of Reset (F)
		CRT3N X	Chiller Fluid ΔT at No Reset (F)
		CRT3F X	Chiller Fluid ΔT at Full Reset (F)
		CRT3D X	Total Degrees of Reset (F)
3 DEMAND SET POINTS	 	DEMAND	Demand Set Points
		DLS1 X†	Demand Switch 1 Set Point (percent)
		DLS2 X†	Demand Switch 2 Set Point (percent)
		DL20 X	Demand Limit at 20 mA (percent)
		DLGN X	Loadshed Group Number
		LSDD X	Loadshed Demand (percent)
		TIME X	Minimum Loadshed Time (minutes)
4 DATE AND TIME	 	DATE.TIME	Date, Time and Day of Week
		DOW.HR.MIN	Day 1 = Mon, 2 = Tues. . .7 = Sun Hours are displayed in 24-hr time. Decimal point serves as colon.
		MM.DD.YR	Month.Day.Year. When entering date, enter a decimal point between entries. Each entry must be two numbers.
5 LEAVING CHILLER FLUID ALERT LIMIT	 	LMT X	Leaving Chiller Fluid Alert Limit (F)

LEGEND



- CCN** — Carrier Comfort Network
- EXV** — Electronic Expansion Valve
- MOP** — Maximum Operating Pressure

*Will read ALARM or ALERT as appropriate.

†Must be configured.

**If applicable.

††Not manually resettable.

NOTE: If metric option is selected under  , temperature expressed as Celsius and pressure will be expressed as kPa.

STATUS FUNCTION — This function shows the rotating display, current status of alarm and alert (diagnostic) codes, capacity stages, operating modes, chilled water set point, all measured system temperatures and pressures, superheat values, pressure switch positions, analog inputs, and switch inputs. These subfunctions are defined on pages 36 and 37.

1 **STAT** (Rotating Display)

2 **STAT** (Alarms/Alerts) — Alarms and alerts are messages that one or more faults have been detected. Each fault is assigned a code number which is reported with the alarm or alert. See Table 10 for code definitions. The codes indicate failures that cause the unit to shut down, terminate an option (such as reset) or result in the use of a default value as set point.

Up to 10 codes can be stored at once. To view them in sequence, press **2** **STAT** to enter the alarm/alert displays and then press **↓** to move to the individual displays. Press **EXPN** after a code has been displayed. The meaning of the code scrolls across the screen. See Example 1.

Example 1 — Reading Alarm Codes

KEYPAD ENTRY	DISPLAY RESPONSE	COMMENTS
	TUE 12:45 LOCAL ON CLOCK ON 13 MODE 8 MODE COOL 1 2 ALARMS 3 MINS	Keypad has not been used for at least 10 minutes. Alternating summary display appears on screen
2 STAT	2 ALARMS	2 alarms/alerts detected
↓	RSAL DSB	Reset all alarms/alerts
↓	ALARM 9	First alarm/alert code
EXPN	COOLER LEAVING FLUID THERMISTOR FAILURE	Explanation of alarm/alert code
↓	ALARM 42	Second alarm/alert code. Cooler freeze protection
EXPN	COOLER FREEZE PROTECTION	Explanation of alarm/alert code

When a diagnostic (alarm or alert) code is stored in the display and the machine automatically resets, the code is deleted. Codes for safeties which do not automatically reset are not deleted until the problem is corrected and either the machine is switched to STOP position, then back to LOCAL/ENABLE or CCN position, or by using the keypad and display module.

To reset alarms/alerts using keypad and display module:

KEYPAD ENTRY	DISPLAY RESPONSE	COMMENTS
2 STAT ↓	RSAL DSB	Reset all alarms/alerts function disabled
1 ENTR	RSAL ENB	Reset all alarms/alerts function enabled

3 **STAT** (Modes) — The operating mode codes are displayed to indicate the operating status of the unit at a given time. See Table 10.

To enter the MODES subfunction, press **3** **STAT** and press the **↓** key to determine if more than one mode applies. See Example 2 to read current mode with expansion.

Example 2 — Reading Current Operating Modes

KEYPAD ENTRY	DISPLAY RESPONSE	COMMENTS
	TUE 15:45 LOCAL ON CLOCK ON 8 MODE COOL 1 0 ALARMS 3 MINS	Keypad has not been used for at least 10 minutes. Rotating summary display appears on screen
3 STAT	2 MODES	There are 2 modes currently in effect
↓	LOCAL ON	Unit is on by chiller on/off switch
↓	8 MODE	Temperature reset is in effect

4 **STAT** (Stage) — This subfunction displays the capacity stage number. See Tables 4A-4C for compressor loading sequence. To enter the STAGE subfunction, press **4** **STAT** and press the **↓** to display the stage number. Continue pressing **↓** for the following information:

- Number of requested stages.
- Percent of total unit capacity being utilized.
- Percent of each circuit capacity being utilized.
- Percent of total capacity available.
- Percent of capacity available in each circuit.
- Demand limit set point in effect (can be any value between 0% and 100%).
- Status of each compressor relay. When a compressor is on, the number of that compressor is displayed. If a compressor is off, a 0 is displayed. For example: In a given circuit, if compressors 1 and 3 are running, and 2 and 4 are not running, 0301 is displayed for that circuit.
- Load/Unload factor for compressors. This factor is an indication of when a step of capacity is added or subtracted. Its value can range from slightly less than -1.0 to slightly more than +1.0. When load/unload factor reaches +1.0, a compressor is added. When the load/unload factor reaches -1.0, a compressor is subtracted. If compressor unloaders are used, at -0.6 a compressor is unloaded and at +0.6, a compressor is loaded up.

Table 10 — Operational and Mode Display Codes

The operating modes are displayed by name or code number, to indicate the operating status of the unit at a given time. The modes are:

CODE	DESCRIPTION
LOCAL OFF	Unit is off. LOCAL/ENABLE-STOP-CCN switch is in OFF position, or LOCAL/ENABLE-STOP-CCN switch may be in LOCAL position with external ON/OFF switch in OFF position.
CCN OFF	Unit is off due to CCN network command. LOCAL/ENABLE-STOP-CCN switch is in CCN position.
CLOCK OFF	Unit is off due to internal clock schedule. LOCAL/ENABLE-STOP-CCN switch is in LOCAL position.
LOCAL ON	Unit is on. LOCAL/ENABLE-STOP-CCN switch is in LOCAL position. If external ON/OFF switch is used, it will be in ON position.
CCN ON	Unit is on due to CCN command. LOCAL/ENABLE-STOP-CCN switch is in CCN position.
CLOCK ON	Unit is on due to internal clock schedule or occupied override function. LOCAL/ENABLE-STOP-CCN switch is in LOCAL/ENABLE position.
MODE 7	Dual set point is in effect. In this mode, unit continues to run in unoccupied condition, but leaving fluid set point is automatically increased to a higher level (CSP2 set point is in SET function).
MODE 8	Temperature reset is in effect. In this mode, unit is using temperature reset to adjust leaving fluid set point upward, and unit is currently controlling to the modified set point. The set point can be modified based on return fluid, outdoor-air temperature, or space temperature.
MODE 9	Demand limit is in effect. This indicates that capacity of unit is being limited by demand limit control option. Because of this limitation, unit may not be able to produce the desired leaving fluid temperature.
MODE 10	Flotronic™ System Manager (FSM) is controlling the chiller.
MODE 11	Not applicable.
MODE 12	Ramp load (pulldown) limiting is in effect. In this mode, the rate at which leaving fluid temperature is dropped is limited to a predetermined value to prevent compressor overloading. See CRAMP set point in the SET function in Table 9. The pulldown limit can be modified, if desired, to any rate from .2 F to 2 F (.1° to 1° C)/minute.
MODE 13	Timed override is in effect. This is a 1 to 4 hour temporary override of the programmed schedule, forcing unit to occupied mode. Override can be implemented with unit under LOCAL/ENABLE or CCN control. Override expires after each use.
MODE 14	Low cooler suction protection is in effect. In this mode, circuit capacity is not allowed to increase if cooler saturated suction temperature is 20° F (11° C) for fluid or 30° F (16° C) for brine or more below leaving fluid temperature, and saturated suction temperature is less than 32 F (0° C). If these conditions persist beyond 10 minutes, circuit is shut down and fault code 44 or 45 is displayed.
MODE 15	Water System Manager is controlling the chiller.
MODE 16	Slow change override is in effect.
MODE 17	X minute off-to-on delay is in effect.
MODE 18	Low suction superheat protection is in effect.

CCN — Carrier Comfort Network

5 **STAT** (Set Point) — This subfunction displays leaving fluid temperature and leaving chilled fluid set point. If unit is programmed for dual set point, the chilled fluid set point currently in effect (either occupied or unoccupied) is displayed. If reset is in effect, the unit operates to the modified chilled fluid set point. This means the leaving fluid temperature may not equal the chilled fluid set point. The modified chilled fluid set point can also be displayed in the Status function. To enter the set point subfunction, press **5** **STAT** and press **↓** to display the set point followed by the modified leaving chilled fluid set point and actual control temperature.

6 **STAT** (Temperature) — The temperature subfunction displays the readings at temperature sensing thermistors. To read a temperature, enter **6** **STAT**, then scroll to desired temperature using the **↓** key. See Table 9 for the order of readouts. This subfunction also displays the saturated refrigerant temperatures corresponding to the suction and discharge pressures measured by the compressor transducers.

7 **STAT** (Pressure) — This subfunction displays suction, discharge, and net oil pressure at lead compressor of each circuit of unit.

8 **STAT** (Analog Inputs) — This subfunction displays analog inputs, if any. Press **8** **STAT**, then press **↓**. The transducer supply voltage, 4-20 mA reset signal can be displayed. This is useful for problem diagnosis prior to using the test function.

9 **STAT** (Discrete Inputs) — This subfunction displays status (open/closed) of discrete input switch where applicable. Status of dual set point switch and demand limit switches 1 and 2 can be displayed. This is useful for problem diagnosis prior to using the test function.

10 **STAT** (Outputs) — This function displays on/off status of alarm relay, all fan relays, and chilled water pump relay. It also displays on/off status of compressor unloaders (if used). The position of each EXV (in percent open) can be displayed.

TEST FUNCTION — The test function operates the diagnostic program. To initiate test function, the LOCAL/ENABLE-STOP-CCN switch must be in STOP position.

To reach a particular test, press its subfunction number, then scroll to desired test by pressing **↓**. Press **ENTR** to start a test. Press **↓** or **↑** or **ENTR** to terminate or exit a test. Pressing the **↓** key after a test has started advances system to next test, whether current test is operating or has timed out. Once in the next step, you may start test by pressing **ENTR** or advance past it by pressing **↓**.

While the unit is in test, you may leave test function and access another display or function by pressing appropriate keys. However, a component that is operating when another function is accessed remains operating. You must re-enter test function and press **↓** to shut down the component. Components with a timed operating limit time out normally even if another function is accessed.

Keypad entry **1** **TEST** allows the operator to make the following checks by using **↓** :

- LID display check. Proper display is 8.8.8.8.8.8.8.
- Operation of alarm relay.
- Operation of condenser fans.
- Operation of chilled fluid pump.
- Operation of liquid line solenoids.
- Operation of the hot gas bypass relays.
- Operation of EXVs. To drive EXV fully open, enter **1** **0** **0** (100% open). To drive EXV fully closed, enter **0** (0% open).
- Operation of each remote alarm.
- Operation of Motormaster® signals.

Keypad entry **2** **TEST** accesses the compressor and compressor unloader operational tests.

⚠ WARNING

During compressor operational tests, compressor starts and runs for 10 seconds. Compressor service valves must be open. Energize crankcase heaters 24 hours prior to performing compressor tests.

Since test function checks only certain outputs, it is good practice to also check all inputs and outputs accessible through the status function. These are located at **8** **STAT** , **9** **STAT** , and **10** **STAT** (see Table 9). If keypad is not used for 10 minutes, unit automatically leaves test function and resumes rotating display. See Example 3.

Example 3 — Using Test Function

KEYPAD ENTRY	DISPLAY RESPONSE	COMMENTS
2 TEST	COMP	Factory/field test of compressors subfunction of test function
↓	CPA 1 OFF	Circuit A, Compressor 1A test
ENTR	CPA 1 ON	Pressing ENTR starts the test: when the compressor should be running the display shows CPA1 on
↓	CPA 1 OFF	If the test is allowed to time out (10 seconds) the display will show CPA1 off
↓	CPA 2 OFF	Pressing the down arrow key advances the system to Circuit A, compressor 2 test

NOTE: Once a compressor has been run using the **TEST** function, it is not allowed to run again for 30 seconds.

3 **TEST** accesses the transducer calibration subfunction. All transducers must be calibrated in order for the unit to operate. Refer to Pressure Transducers section on page 60 for calibration procedure.

HISTORY FUNCTION — Pressing **1** **HIST** and **↓** displays total unit run time, total run time for each circuit, and total run time for each compressor.

Pressing **2** **HIST** and **↓** displays total unit starts, the total starts for each circuit, and total starts for each compressor. Pressing **3** **HIST** and **↓** displays the last 10 alarms along with a description of each alarm.

SET POINT FUNCTION — Set points are entered through the keypad. Set points can be changed within the upper and lower limits, which are fixed. The ranges are listed below.

Chilled Fluid Set Point

- Water: 38 to 86 F (3.3 to 30 C)
- Medium Brine: 14 to 86 F (-10 to 30 C)

Pulldown Set Point

0.2 to 2.0 F (0.11 to 1.1 C)/min.

Reset Set Points

- Maximum Reset Range: -30° to 30° F (-17° to 17° C)
- External Temperature Reset -40 to 240 F (-40 to 118 C)
- Chiller Fluid ΔT: 0° to 15° F (0° to 8° C)
- External Signal Reset 4 to 20 mA

Demand Limit Set Points

- Switch Input:
 - Step 1 — 0 to 100% Capacity Reduction
 - Step 2 — 0 to 100% Capacity Reduction
- External Signal:
 - Maximum Demand Limit 4 to 20 mA
 - Minimum Demand Limit 4 to 20 mA
 - Loadshed Demand Delta: 0 to 60%
 - Maximum Loadshed Time: 0 to 120 min.

Set points are grouped in subfunctions as follows:

- 1** **SET** Subfunction displays chiller fluid set points.
 - The first value shown is the occupied chilled fluid set point.
 - The next value displayed depends on how the schedule function has been programmed. (See pages 44-47.) If dual set point has been selected, the next set point after **↓** has been pressed is the second chilled fluid set point. If single set point or inactive schedule has been selected in the schedule function, then when **↓** is pressed, the display shows the head pressure set points, one for each circuit. These are utilized only if the set point controlled method of head pressure control is selected in **4** **SRVC** .
 - The final value displayed when the **↓** is pressed is the cooling ramp loading rate. This is the maximum rate at which the leaving chilled fluid is allowed to drop, and can be field set from 0.2 to 2.0 F (.11° to 1.1° C)/minute. This value is not displayed unless the function is enabled (see Adjustable Field Configurations on page 44).

Reading and Changing Set Points — Example 4 shows how to read and change the chilled fluid set point. Other set points can be changed by following the same procedure. Refer to Table 9 for the sequence of display of set points in each subfunction.

Example 4 — Reading and Changing Chilled Fluid Set Point

KEYPAD ENTRY	DISPLAY RESPONSE	COMMENTS
1 SET	SET POINT	System set points
↓	CSP1 44.0	Present occupied chilled fluid set point is 44.0 F
4 2 ENTR	CSP1 42.0	Press the 4 2 ENTR. Display shows new occupied chilled fluid set point is 42.0 F
↓	CSP2 44.0	Present unoccupied chilled fluid set point is 44.0 F
5 0 ENTR	CSP2 50.0	Press the 5 0 ENTR. Display shows new unoccupied chilled fluid set point is 50.0 F
2 SET	RESET	Displays the maximum reset set point. The minimum and maximum reference reset set points can also be displayed. These set points are not accessible when reset type has been configured for NONE in the service function.

2 SET Subfunction displays temperature reset set points.

Temperature Reset Based on Return Fluid Temperature —

The control system is capable of providing leaving fluid temperature reset based on return fluid temperature. Because the temperature difference between leaving and return temperature is a measure of the building load, return fluid temperature reset is essentially an average building load reset method.

Under normal operation, the chiller maintains a constant leaving fluid temperature approximately equal to chilled fluid set point. As building load drops from 100% down to 0%, entering cooler fluid temperature drops in proportion to load. Thus, temperature drop across the cooler drops from a typical 10 F (5.5 C) at full load to a theoretical 0° F (0° C) at no load. See Fig. 5.

At partial load, leaving chilled fluid temperature may be lower than required. If this is allowed to increase (reset), the efficiency of the chiller increases. Amount of reset can be defined as a function of cooler temperature drop, as shown in Fig. 5. This is a simple linear function that requires 3 pieces of input data for the set function that will vary depending on measurement method used as follows (see Table 11):

NOTE: Reset set points are not accessible unless the reset function is enabled first. This is done as a field

configuration. Select one of the 4 choices for type of reset: Return Fluid Reset, External Temperature Reset, 4-20 mA External Signal Reset, or 4-20 mA Internal Signal Reset.

If dual set point control is enabled (see Field Wiring section on page 69), the amount of reset is applied to whichever set point is in effect at the time.

Examples 5A-5C demonstrate how to activate reset. Example 6 demonstrates how to change the type of reset. Assume that reset is to be based on return fluid temperature, the desired reset range is to be 0° to 10° F (0° to 5.5° C) and full load is a 10° F (5.5° C) drop across the cooler. See Fig. 5.

Activating reset based on external temperature or 4-20 mA signal is done the same way, except the reference set point range is -40° to 240° F (-40° to 115° C), or 4 to 20 mA depending on which method was selected at the field configuration step.

Example 5A — External Reset

In this example, the unit set point is reset from full load at 90 F (32 C) to a maximum reset value of 10 F (5.5 C) at 20 F (-6.7 C) outdoor ambient.

NOTE: All temperatures given in this example are in F.

KEYPAD ENTRY	DISPLAY RESPONSE	COMMENTS
4 SRVC	FLD CFG	
↓	CRTYP 0	Scroll past to reset type
2 ENTR	CRTYP 2	External reset selected
↓	ERTYP 0	Scroll past to space thermistor sensor selected
1 ENTR	ERTYP 1	OAT selected
2 SET	RESET	
↓	CRT2N 0	Temperature for no reset is 0
9 0 ENTR	CRT2N 90	Temperature for no reset is 90
↓	CRT2F 0	Temperature for maximum reset is 0
2 0 ENTR	CRT2F 20	Temperature for maximum reset is 20
↓	CRT2D 0	Maximum reset is 0
1 0 ENTR	CRT2D 10	Maximum reset is 10

Table 11 — Reset Amounts

INPUT DATA DESCRIPTION	MEASUREMENT METHOD					
	4-20 mA		OAT/Occupied Space or Internal/External		Return Water	
	Variable	Limits (F)	Variable	Limits (F)	Variable	Limits (F)
Maximum Reset Amount — Allowable range for maximum amount which LWT is to be reset.	CRT1	-30 to 30	CRT2D	-30 to 30	CRT3D	-30 to 30
Maximum Reset Reference — Temperature at which maximum reset occurs.	—	—	CRT2F	-40 to 240	CRT3F	0 to 15
Minimum Reset Reference — Temperature at which no reset occurs.	—	—	CRT2N	-40 to 240	CRT3N	0 to 15

LEGEND

OAT — Outdoor-Air Temperature
LWT — Leaving Fluid Temperature

Example 5B — 4 to 20 mA and Internally or Externally Powered Reset

In this example, the unit set point is reset from full load at 4 mA to a maximum reset value of 10 F (5.5 C) at 20 mA. Internally powered 4 to 20 mA option is used in this example.

NOTE: To use externally powered reset, when CRTYP appears, press **4** **ENTR** so CRTYP 4 appears in the display. The remainder of the information in the following example applies to either type of reset.

KEYPAD ENTRY	DISPLAY RESPONSE	COMMENTS
4 SRVC	FLD CFG	
↓	CRTYP 0	Scroll past to reset type
1 ENTR	CRTYP 1	Internally powered reset selected
2 SET	RESET	
↓	CRT1 0	Reset at 20 mA is 0
1 0 ENTR	CRT1 10	Reset at 20 mA is 10

Example 5C — Using Return Fluid Temperature Reset

KEYPAD ENTRY	DISPLAY RESPONSE	COMMENTS
4 SRVC	FLD CFG	Field configuration subfunction of service function
↓	CSPTYP X	Scroll past single/dual
↓	CRTYP 0	Display shows no reset type has been selected
3 ENTR	CRTYP 3	Return fluid temperature is selected and activated
2 SET	RESET	Reset set points

Temperature Reset Based on External Temperature — If desired, temperature reset can be based on an external temperature, such as space or outdoor-air temperature. This requires a thermistor (T10, Part No. 30GB660002) located in the space or outdoor air and wired to terminals as follows (also see Field Wiring section on page 69 and Fig. 6):

4 in/4 out Module — J7-15 and J7-16.

At the field configuration step, enter set points as described in Examples 5A-5C on pages 39 and 40. Then select external temperature reset by entering **2** when CRTYP 0 appears. See Fig. 7.

Temperature Reset Based on 4-20 mA Signal — If desired, temperature reset can be based on a 4-20 mA signal. For proper connections, refer to Field Wiring section on page 69 and Fig. 8.

At the field configuration step, select 4-20 mA reset by entering **1** (internally powered) or **4** (externally powered) when CRTYP 0 appears. Then enter set points as described previously in Examples 5A-C. See Fig. 8.

3 **SET** Subfunction displays demand limit set points.

Demand Limit, 2-Stage Switch Control — This control has been designed to accept demand limit signals from a building load shedding control. The demand limit function provides for 2 capacity steps. The keypad is used to set the 2 demand limit set points, which range from 100 to 0% of capacity. Capacity steps are controlled by 2 field-supplied relay contacts connected to the designated chiller terminals. (See Field Wiring section on page 69 and Fig. 7.)

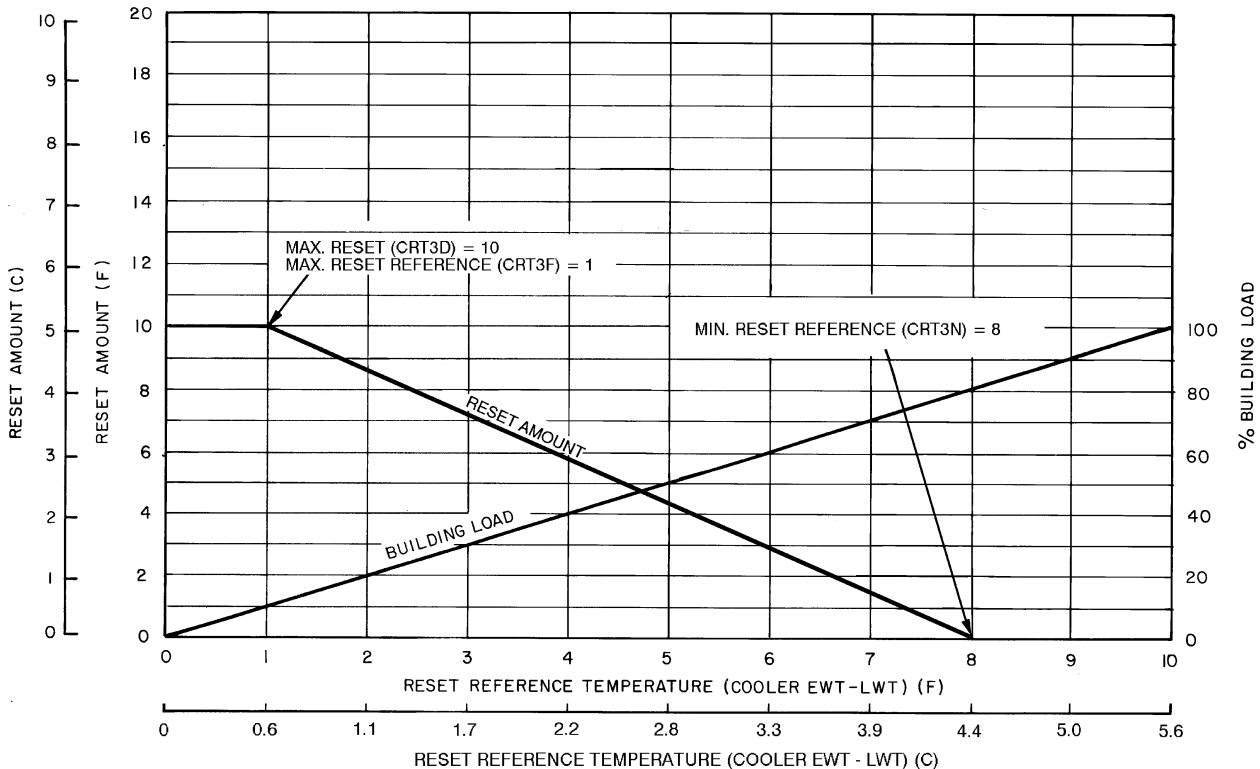

Fig. 5 — Cooling Return Fluid Reset

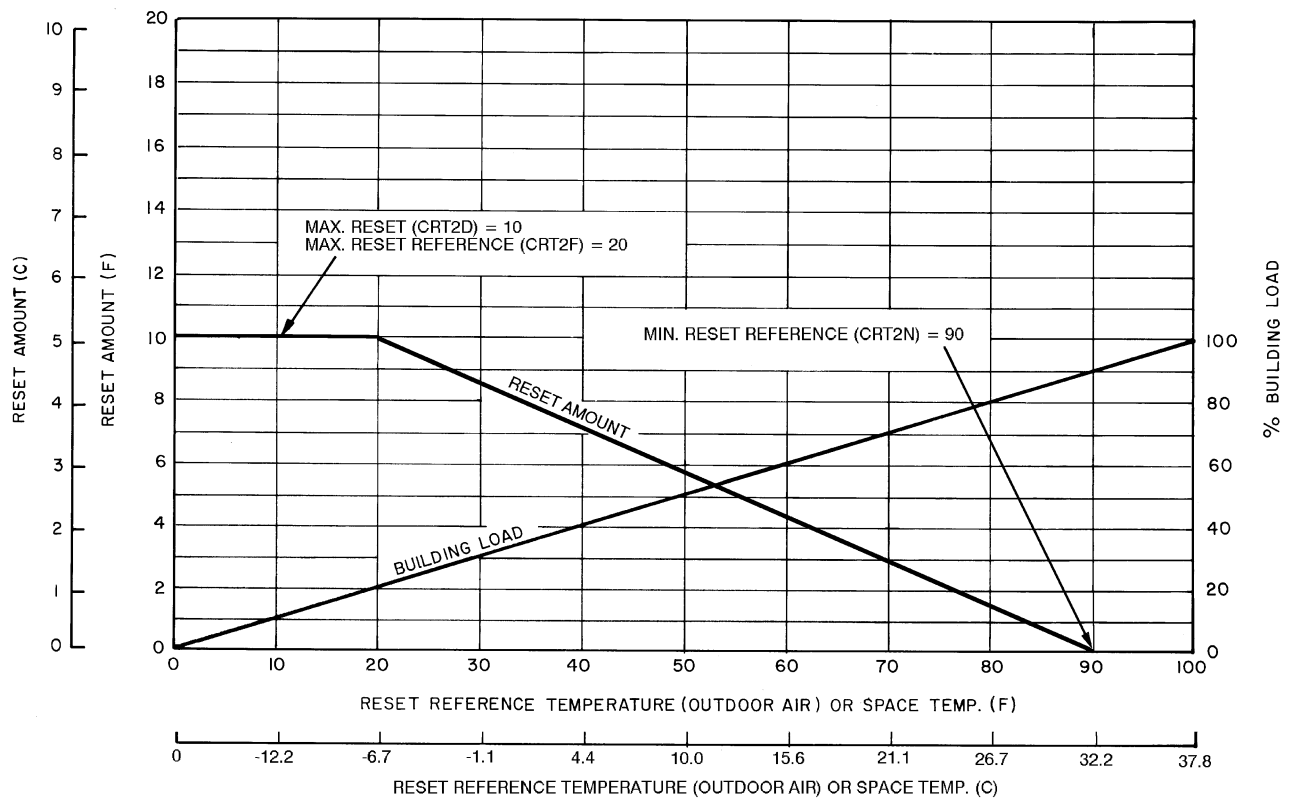

Fig. 6 — Cooling External Temperature Reset

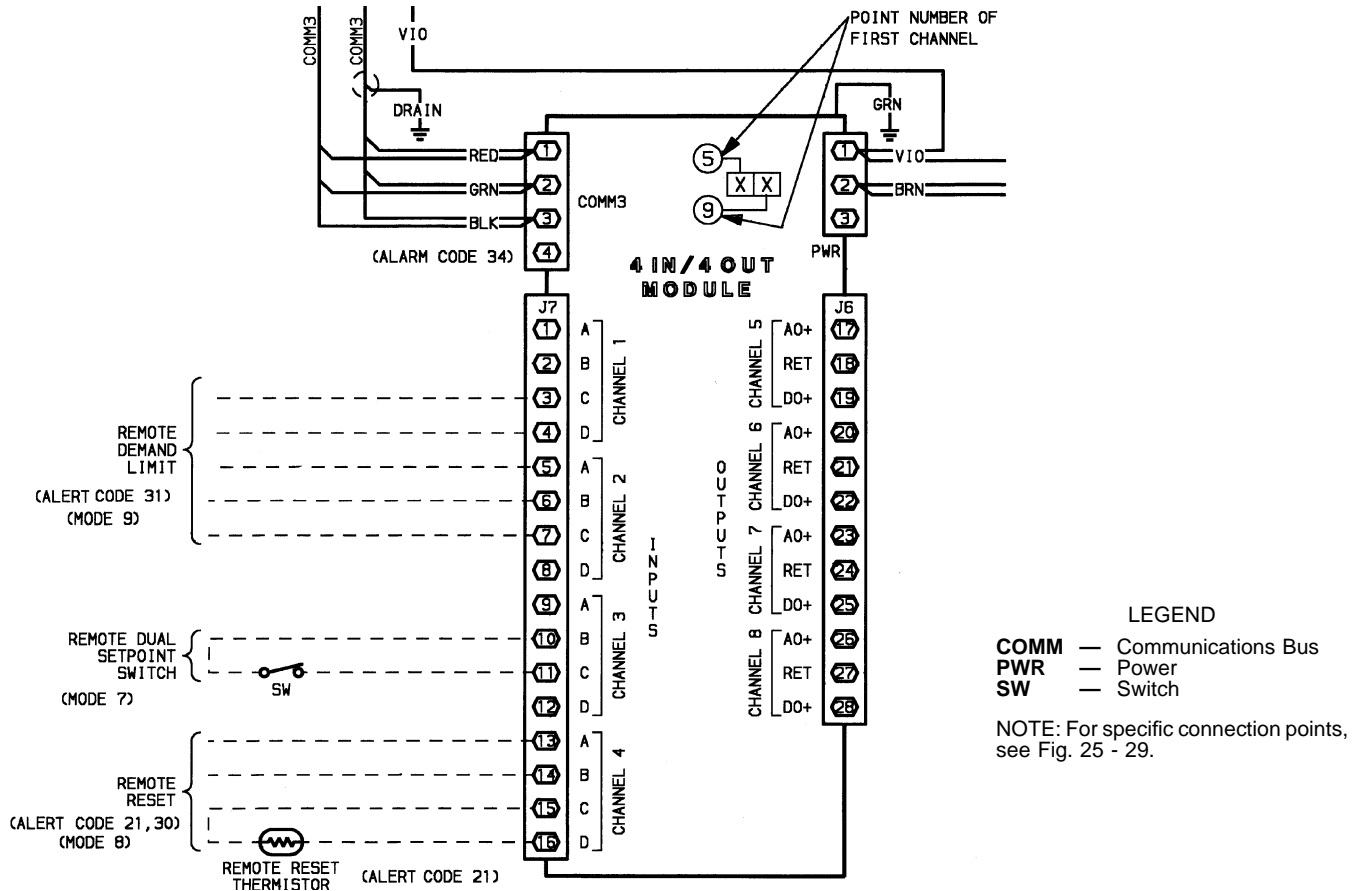

Fig. 7 — 4 IN/4 OUT Options Module Wiring for Reset, Demand Limit, and Dual Set Point

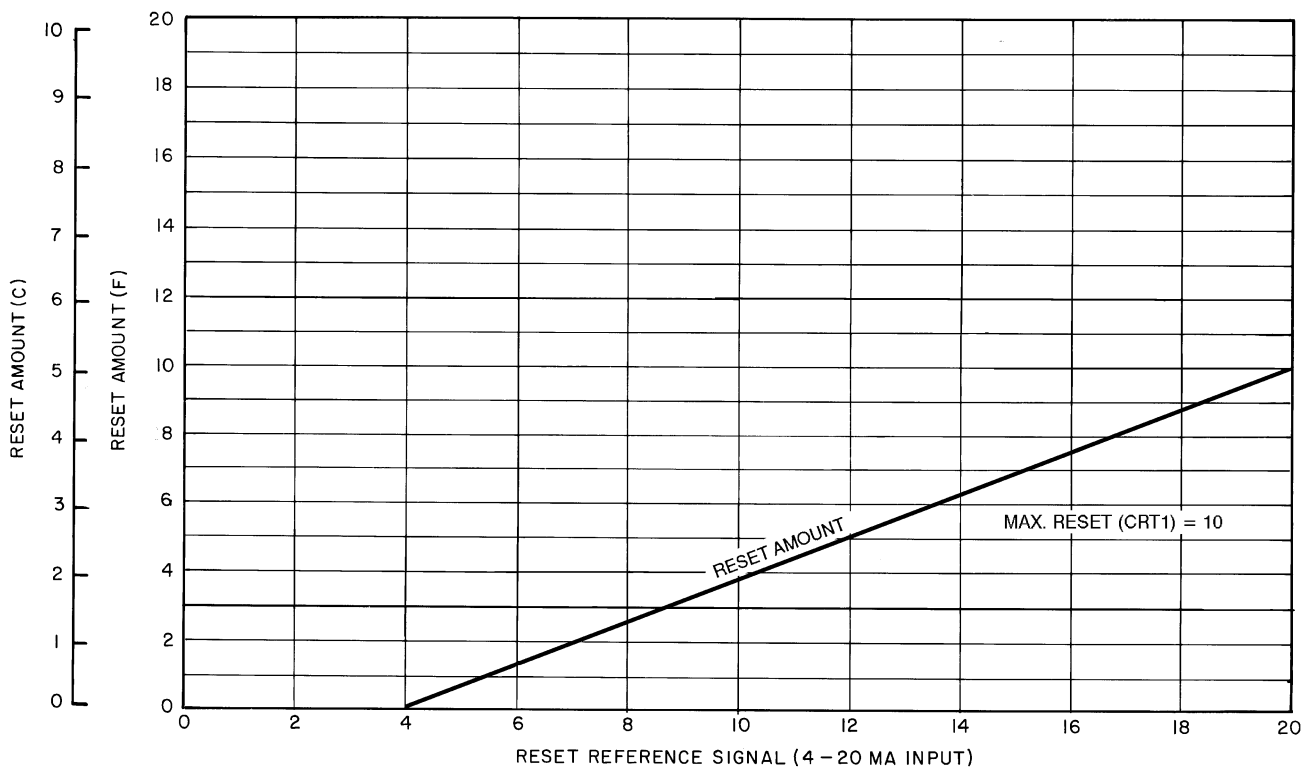

Fig. 8 — 4-20 mA Cooling Temperature Reset

Example 6 — Changing Reset Type

To change type of reset, first log on as shown in Table 12. Also refer to Set Point Function section, page 38, for information on entering reset set points using reset feature.

KEYPAD ENTRY	DISPLAY RESPONSE	COMMENTS
<input type="button" value="4"/> <input type="button" value="SRVC"/>	FLD CFG	Field configuration subfunction of service function
<input type="button" value="↓"/>	CSPTYP 0	Scroll past single cooling set point
<input type="button" value="↓"/>	CRTYP 0	No reset has been selected
<input type="button" value="1"/> <input type="button" value="ENTR"/>	CRTYP 1	Internally powered 4-20 mA signal reset is selected
<input type="button" value="2"/> <input type="button" value="ENTR"/>	CRTYP 2	Space or outdoor-air temperature reset is selected
<input type="button" value="3"/> <input type="button" value="ENTR"/>	CRTYP 3	Return fluid temperature reset is selected
<input type="button" value="4"/> <input type="button" value="ENTR"/>	CRTYP 4	Externally powered 4-20 mA signal reset is selected
<input type="button" value="."/> <input type="button" value="ENTR"/>	CRTYP 0	Reset is deactivated

To use Demand Limit, first enable loadshed, then enter demand limit set points. See Example 7A. Closing the first stage demand limit contact puts unit on the first demand limit level, that is, the unit does not exceed the percentage of capacity entered as demand limit stage 1. Closing contacts on second-stage demand limit relay prevents unit from exceeding capacity entered as demand limit stage 2. The demand limit stage that is set to the lowest demand takes priority if both demand limit inputs are closed.

The demand limit function must be enabled in order to function and may be turned off when its operation is not desired. The demand limit relays can, in off condition, remain connected without affecting machine operation.

Table 12 — Service Functions

To view and modify configurations, the password must be entered under the log on subfunction.

SUB-FUNCTION	KEYPAD ENTRY	DISPLAY	COMMENT
1 Log On	<input type="button" value="1"/> <input type="button" value="SRVC"/>	PASSWORD	Enter Password/Disable Password
	<input type="button" value="1"/> <input type="button" value="1"/> <input type="button" value="1"/> <input type="button" value="1"/> <input type="button" value="ENTR"/>	LOGGEDON	Logged On

NOTE: Configurations may be modified at this time. When finished viewing and/or modifying configurations, log out as follows:

	<input type="button" value="1"/> <input type="button" value="SRVC"/>	LOGGEDON	—
	<input type="button" value="↓"/>	LOG OFF	Disable Password Protection
	<input type="button" value="ENTR"/>	EXIT LOG	Logged Off/Enable Password Protection
2 Version	<input type="button" value="2"/> <input type="button" value="SRVC"/>	VERSION	Software Information
	<input type="button" value="↓"/>	XXXXXXXX	Version No. of Software

Demand Limit, 4 to 20 mA Signal — The controls can also accept a 4 to 20 mA signal for load shedding. Input for the signal are terminals shown below:

Externally powered

Positive lead to J7-5 - 4 In/4 Out Module

Negative lead to J7-6 - 4 In/4 Out Module

Internally powered

Positive lead to J7-6 - 4 In/4 Out Module

Negative lead to J7-7 - 4 In/4 Out Module

See Field Wiring section on page 69 and Fig. 7.

At field configuration step, select 4 to 20 mA loadshed by entering **2** (internally powered) or **4** (externally powered) when the LSTYP 0 display appears. See Example 7B. Then enter set points as follows. In this example, set points are coordinates of the demand limit curve shown in Fig. 9.

Example 7A — Using Demand Limit (First Log On as Shown in Table 12)

KEYPAD ENTRY	DISPLAY RESPONSE	COMMENTS
4 SRVC	FLD CFG	Field configuration subfunction of service function
↓	LSTYP 0	Loadshed is not enabled
1 ENTR	LSTYP 1	Loadshed is now enabled for 2-stage switch control
3 SET	DEMAND	Demand Limit set points subfunction of set point function
↓	DLS1 80	Loadshed 1 currently set at 80%
6 0 ENTR	DLS1 60	Loadshed reset to 60%
↓	DLS2 50	Loadshed 2 currently set at 50%
4 0 ENTR	DLS2 40	Loadshed 2 reset to 40%

To Disable Demand Limit:

KEYPAD ENTRY	DISPLAY RESPONSE	COMMENTS
4 SRVC	FLD CFG	Field configuration subfunction of service function
↓	ERTYP 0	Scroll past other elements in the subfunction
↓	LSTYP 1	Loadshed is enabled for 2-stage switch control
. ENTR	LSTYP 0	Loadshed is now disabled

NOTES:

1. Select 2 for internally powered 4 to 20 mA signal load limiting.
2. Select 3 for Carrier Comfort Network loadshed.
3. Select 4 for externally powered 4 to 20 mA signal load limiting.

Example 7B — Using Demand Limit (4-20 mA) (First Log On As Shown in Table 12)

KEYPAD ENTRY	DISPLAY RESPONSE	COMMENTS
4 SRVC	FLD CFG	Field configuration subfunction of service function
↓	ERTYP 0	Scroll past other elements in the subfunction
↓	LSTYP 0	Loadshed is not enabled
2 ENTR	LSTYP 2	Loadshed is now enabled for 4-20 mA internally-powered signal control
3 SET	DEMAND	Demand Limit set points
↓	DL20 100	Maximum demand limit is 100%
9 0 ENTR	DL20 90	Maximum demand limit is 90%

Scrolling past the 4 to 20 mA demand limit set point brings up the loadshed set points. The loadshed feature is activated by a redline alert and loadshed commands from the CCN loadshed option. The first set point is the group number, established by the CCN system designer. The second option is

the loadshed demand delta, which defines the percent of the load to be removed when a loadshed command is in effect. The third set point is maximum loadshed time, which defines the maximum length of time that a loadshed condition is allowed to exist. The allowable range for this entry is zero to 120 minutes.

4 **SET** Subfunction displays date, time, and day of the week.

Reading and Changing Time Display — Time is entered and displayed in 24-hour time. The day of the week is entered as a number.

1 = Mon, 2 = Tue, 7 = Sun, etc.

. Key is used as the colon when entering time. See Example 8.

5 **SET** subfunction accesses the leaving chiller fluid alert limit (LMT) option. The value to be entered here is the number of degrees above the control set point at which an alert should be generated. For example, if the control set point is 44 F, and an alert is desired (alert 70) if the fluid temperature reaches 50 F, then enter 6 for this set point. The allowable range for this entry is between 2 and 30 (F).

SERVICE FUNCTION — This function allows the technician to view and input configuration data. Factory configuration data, field configuration data, and service configuration data may be viewed or entered through the keypad and display module. See Table 9 for a complete listing of configurable items. Whenever a processor module is replaced in the field, the complete list of configuration codes must be entered.

Logging On/Logging Off — The service function is password protected. Therefore, to gain entry to this function, this password must be entered. Pressing **1 1 1 1** **ENTR** allows the technician to view, change, or enter configuration codes. To log off, perform the following keystrokes:

1 **SRVC** **↓** **ENTR**. The service function is once again password protected.

Software Information — **2** **SRVC** **↓** displays the version number of the software that resides in the processor module. The **1** **SRVC** and **2** **SRVC** subfunctions are summarized in Table 12.

Example 8 — Setting Time of Day and Day of Week

KEYPAD ENTRY	DISPLAY RESPONSE	COMMENTS
4 SET	TIME	Time display subfunction of set point function
↓	MON 16.00	Current setting is Monday, 4:00 p.m.
2 . 1 3 . 0 5	TUE 13.05	New setting of Tuesday, 1:05 p.m. is entered and displayed
ENTR	JAN 01 90	Current date is Jan. 1, 1990
↓	JAN 01 90	Current date is Jan. 1, 1990
4 . 1 5 . 9 0	APR 15 90	New setting April 15, 1990 is entered and displayed
ENTR	APR 15 90	New setting April 15, 1990 is entered and displayed

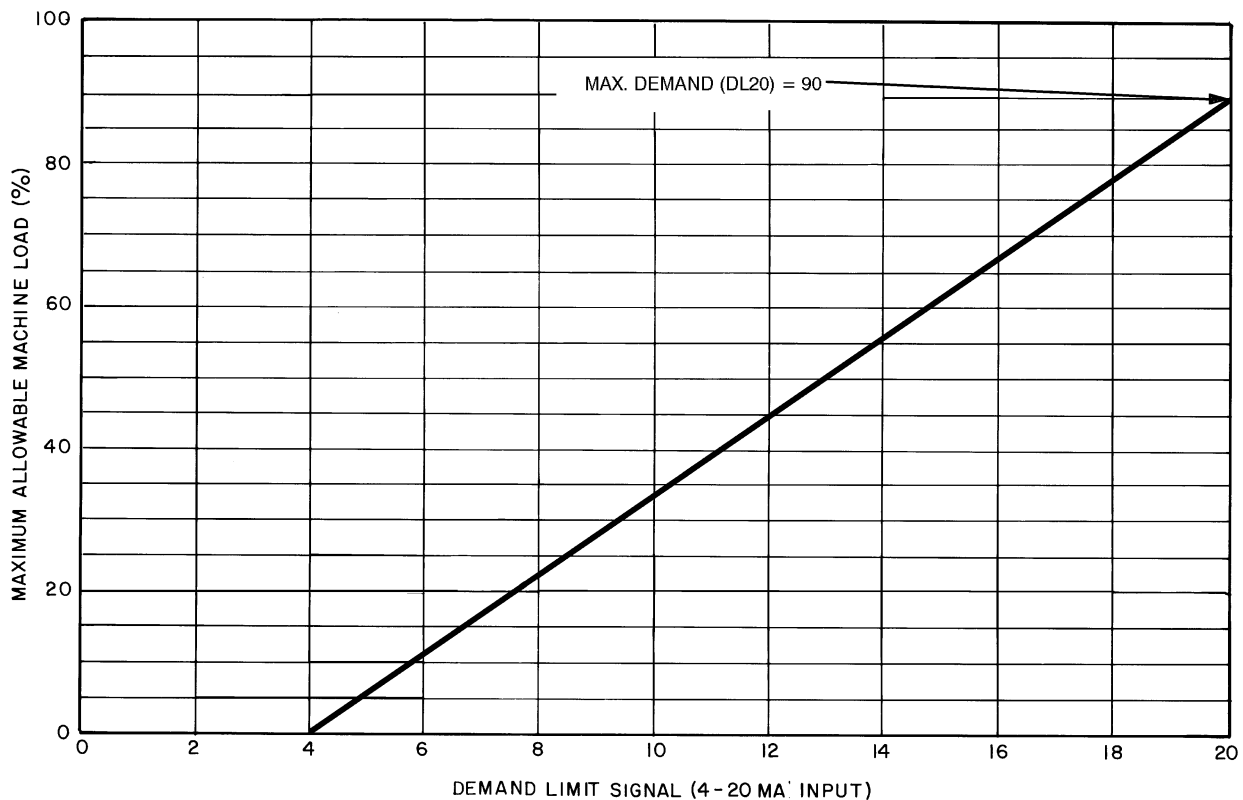

Fig. 9 — 4-20 mA Demand Limiting

Factory Configuration Codes — allows entry into the factory configuration subfunction. Under this subfunction, there are 7 groups of configuration codes that are downloaded at the factory. Each group is made up of 8 digits. If processor module is replaced in the field, these 7 groups of configuration codes must be entered through the keypad and display module. Factory configuration codes (groups 1 through 7) that apply to the particular Flotronic™ II chiller being serviced are found on a label diagram located inside the control box cover. See Table 13 for a summary of factory configuration subfunction keystrokes.

Adjustable Field Configurations — After logging on, press to enter subfunction. The subfunction allows operation of the chiller to be customized to meet the particular needs of the application. The chiller comes from the factory preconfigured to meet the needs of most applications. Each item should be checked to determine which configuration alternative best meets the needs of a particular application. See Table 14 for factory loaded configuration codes and alternative configurations.

If processor module is replaced, the replacement module is preloaded with factory default configuration codes. Each configuration code must be checked and, if necessary, reconfigured to meet needs of the application. See Table 14 for pre-loaded service replacement configuration codes.

Service Configuration Codes — Press to enter the service configuration subfunction. The first 2 items under this subfunction are 2 groups (8 digits each) of configuration codes that are downloaded at the factory. If processor module is

replaced in the field, the 2 groups of configuration codes must be entered through the keypad and display module. The 2 groups of configuration codes (groups 8 and 9) that apply to the unit being serviced can be found on a label diagram inside the control box cover. See Table 13 for keystroke information to enter configuration codes 8 and 9. The remaining items in this subfunction are read-only data provided to assist in service evaluations.

SCHEDULE FUNCTION — This function provides a means to automatically switch chiller from an occupied mode to an unoccupied mode. When using schedule function, chilled fluid pump relay must be used to switch chilled fluid pump on and off. Connections for chilled fluid pump relay are: TB3-3 and TB3-4. The chilled fluid pump relay starts chilled fluid pump but compressors do not run until remote chilled fluid pump interlock contacts are between TB6-1 and TB6-2 are closed and leaving chilled fluid temperature is above set point. If a remote chilled fluid pump interlock is not used, the first compressor starts (upon a call for cooling) approximately one minute after chilled fluid pump is turned on.

The unit can be programmed for inactive, single set point, or dual set point operation.

When unit is configured for inactive, chilled fluid pump relay remains energized continuously but is not used since chiller is usually controlled by remote chilled fluid pump interlock contacts.

When unit is configured for single set point operation, chilled fluid pump relay is energized whenever chiller is in occupied mode regardless of whether chiller is running. When chiller is in unoccupied mode, chilled fluid pump relay is not energized.

Table 13 — Factory Configuration Keystrokes

To change a configuration enter the new configuration and press **ENTR** while on the correct configuration.

SUB-FUNCTION	KEYPAD ENTRY	DISPLAY	COMMENTS
3 FACTORY CFG	3 SRVC	FACT CFG	FACTORY CONFIGURATION CODES
	↓	XXXXXXXX	Configuration Code 1
	↓	XXXXXXXX	Configuration Code 2
	↓	XXXXXXXX	Configuration Code 3
	↓	XXXXXXXX	Configuration Code 4
	↓	XXXXXXXX	Configuration Code 5
	↓	XXXXXXXX	Configuration Code 6
	↓	XXXXXXXX	Configuration Code 7
5 SERVICE CFG	5 SRVC	SRV CFG	SERVICE CONFIGURATION CODES
	↓	XXXXXXXX	Configuration Code 8
	↓	XXXXXXXX	Configuration Code 9
	↓	REFRIG X	Refrigerant Type
	↓	TDTYPE X	Pressure Transducer Select
	↓	OPS X	Oil Pressure Set Point
	↓	LPS X	Low Pressure Set Point
	↓	FANTYP X	Fan Staging Select
	↓	SH X	EXV Superheat Set Point
	↓	MOP X	EXV MOP Superheat
↓	ZM X	Z Multiplier	

LEGEND

MOP — Maximum Operating Pressure
EXV — Electronic Expansion Valve

When unit is configured for dual set point, chilled liquid pump relay is energized continuously, in both occupied and unoccupied modes. Occupied mode places occupied chilled water set point into effect; unoccupied mode places unoccupied chilled water set point into effect.

Scheduling — **1** **SCHD** is used to override any current schedule in effect (for 0-4 hours). **2** **SCHD** is used to activate a clock for the scheduling function. **3** **SCHD** - **11** **SCHD** are used to program schedules for specific occupied and unoccupied periods.

The schedule consists of from one to 8 occupied time periods, set by the operator. These time periods can be flagged to be in effect or not in effect on each day of the week. The day begins at 00.00 and ends at 24.00. The machine is in unoccupied mode unless a scheduled time period is in effect. If an occupied period is to extend past midnight, it must be programmed in the following manner: occupied period must end at 24:00 hours (midnight); a new occupied period must be programmed to begin at 00:00 hours.

Table 14 — Adjustable Field Configurations

FIELD CONFIGURATION ITEM AND CODES	FACTORY CONFIGURATION CODE	SERVICE REPLACEMENT CODE
CCN element address (Entered by CCN Technician)	001	001
CCN Bus Number (Entered by CCN Technician)	000	000
CCN Baud Rate (Entered by CCN Technician)	9600	9600
Cooler Fluid Select 1 = Water (38 to 70 F [3.3 to 21 C] Set Point) 2 = Medium Brine (15 to 70 F [-9 to 21 C] Set Point)	1 = Standard Models 2 = Brine Models	1
Display Unit Select 0 = English 1 = Metric SI	0	0
Delay at Power Up	0	0
No. Circuit A Unloaders 0 = No Unloaders 1 = One Unloader 2 = Two Unloaders	0 = 30GN190-210* 1 = 30GN040-170*	0
No. Circuit B Unloaders 0 = No Unloaders 1 = One Unloader 2 = Two Unloaders	0 = 30GN040-070, 190-210* 1 = 30GN080-170*	0
Hot Gas Bypass Select 0 = No Valve	0	0
Loading Sequence Select 1 = Equal Circuit Loading 2 = Staged Circuit Loading	1	1
Lead/Lag Sequence Select 1 = Automatic 2 = Manual, Circuit A Leads 3 = Manual, Circuit B Leads	1	1
Oil Pressure Switch Select 0 = Not Used 1 = Air Cooled	0	0
Head Pressure Control Type 0 = Not Used 1 = Air Cooled	1	0
Head Pressure Control Method 1 = EXV Controlled 2 = Set Point Control for Both Circuits 3 = Set Point Control for Circuit A; EXV Control for Circuit B 4 = Set Point Control for Circuit B; EXV Control for Circuit A	1 2 = 040,045 Brine Units	1
Motormaster® Select 0 = None 2 = Indirect Control	0	0
Cooling Set Point Control Select 0 = Single Set Point Control 1 = External Switch Controlled Set Point 2 = Clock Controlled Set Point	0	0
Cooling Reset Control Select 0 = No Reset 1 = 4-20 mA, Internally Powered 2 = External Temperature Reset 3 = Return Fluid Reset 4 = 4-20 mA, Externally Powered	0	0
External Reset Sensor Select 0 = Thermistor Connected to Options Module 1 = Obtained Through CCN	0	0
Outdoor-Air Sensor Select 0 = Not Selected 1 = Selected	0	0
Demand Limit Control Select 0 = No Demand Limiting 1 = Two External Switch Inputs 2 = Internal 4-20 mA Input 3 = CCN Loadshed 4 = External 4-20 mA Input	0	0
Ramp Load Select (Pulldown Control) 0 = Disabled 1 = Enabled	1	0
Cooler Pump Interlock Select 0 = No Interlock 1 = With Interlock	1	0
Cooler Pump Control Select 0 = Not Controlled 1 = ON/OFF Controlled	1	0
Remote Alarm Option Select 0 = Not Selected 1 = Selected	0	0
Local/Enable-Stop-CCN Switch Usage† 0 = Not Allowed 1 = Allowed	1	1

LEGEND

CCN — Carrier Comfort Network *And associated modular units.
EXV — Electronic Expansion Valve †For reset of alarms.

NOTE: This is true only if the occupied period starts at 00:00 (midnight). If the occupied period starts at a time other than midnight, then the occupied period must end at 00:00 hours (midnight) and new occupied period must be programmed to start at 00:00 in order for the chiller to stay in the occupied mode past midnight.

The time schedule can be overridden to keep unit in occupied mode for one, 2, 3, or 4 hours on a one-time basis. See Example 9.

All subfunctions of schedule function are password protected except the override subfunction, **1** **SCHD**. Password entry into subfunctions **2** **SCHD** through **1** **1** **SCHD**, is done through service function. See page 43, logging on/ logging off.

Figure 10 shows a schedule for an office building with the chiller operating on a single set point schedule. The schedule is based on building occupancy with a 3-hour off-peak cool-down period from midnight to 3 a.m. following the weekend shutdown. To learn how this sample schedule would be programmed, see Example 9.

NOTE: This schedule was designed to illustrate the programming of the schedule function and is not intended as a recommended schedule for chiller operation.

Example 9 — Using the Schedule Function

KEYPAD ENTRY	DISPLAY	COMMENT
1 SCHD	OVRD 0	No scheduled override in effect
3 ENTR	OVRD 3	3 hours override in effect
. 0 ENTR	OVRD 0	Override cancelled
2 SCHD	CLOCK 0	Schedule function is inactive
1 ENTR	CLOCK 1	Schedule function is enabled through local unit clock
PROGRAMMING PERIOD 1:		
3 SCHD	PERIOD 1	Define schedule period 1. Start of occupied time
↓	OCC 00.00	For this example, first period should start here (at midnight) so no entry is needed
↓	UNO 00.00	Start of unoccupied time (end of period). For this example, period 1 should end at 3:00 a.m.
3 . 0 0 ENTR	UNO 3.00	Period 1 ends at 3:00 a.m.
↓	MON NO	Monday is now flagged no for period 1. To put period 1 into effect on Monday, Monday must be flagged yes
1 ENTR	MON YES	Monday is now flagged for period 1 to be in effect
↓	TUE YES	For this example, period 1 is to be in effect on Monday only. All other days must be checked to be sure that they are flagged no. If any day is flagged yes, change to no
. ENTR	TUE NO	Tuesday is now flagged no for period 1

Example 9 — Using the Schedule Function (cont)

KEYPAD ENTRY	DISPLAY	COMMENT
PROGRAMMING PERIOD 2:		
4 SCHD	PERIOD 2	Define schedule period 2
↓	OCC 00.00	Start of occupied time
7 . 0 0 ENTR	OCC 7.00	Occupied time will start at 7:00 a.m.
↓	UNO 00.00	Start of unoccupied time (end of period). For this example, period 2 should end at 18:00 (6:00 p.m.)
1 8 . 0 0 ENTR	UNO 18.00	Period 2 ends at 18:00 (6:00 p.m.)
↓	MON NO	Monday is now flagged no for period 2. To put period 2 into effect on Monday, Monday must be flagged yes
1 ENTR	MON YES	Monday is now flagged for period 2 to be in effect
↓	TUE NO	Tuesday is now flagged no for period 2. To put period 2 into effect on Tuesday, Tuesday must be flagged yes
1 ENTR	TUE YES	Tuesday is now flagged for period 2 to be in effect
↓	WED YES	For this example, period 2 is to be in effect only on Monday and Tuesday. All other days must be checked to be sure that they are flagged no. If a day is flagged yes, change to no
. ENTR	WED NO	Wednesday is now flagged no for period 2
PROGRAMMING PERIOD 3:		
5 SCHD	PERIOD 3	Define schedule period 3
↓	OCC 00.00	Start of occupied time
7 . 0 0 ENTR	OCC 7.00	Occupied time will start at 7:00 a.m.
↓	UNO 00.00	Start of unoccupied time (end of period 3). For this example, period 3 should end at 21:30 (9:30 p.m.)
2 1 . 3 0 ENTR	UNO 21.30	Period 3 ends at 21:30 (9:30 p.m.)
↓	MON NO	Check to be sure that Monday and Tuesday are flagged no for period 3
↓	TUE NO	
↓	WED NO	Wednesday is flagged no, change to yes
1 ENTR	WED YES	Wednesday is now flagged yes for period 3
↓	THUR NO	Check to be sure that all other days are flagged no
↓	FRI NO	
↓	SAT NO	
↓	SUN NO	

CCN — Carrier Comfort Network

Periods 4 and 5 can be programmed in the same manner, flagging Thursday and Friday yes for period 4 and Saturday yes for period 5. For this example, periods 6, 7, and 8 are not used: they should be programmed OCC 00.00, UNO 00.00.

NOTE: When a day is flagged yes for 2 overlapping periods, occupied time will take precedence over unoccupied time. Occupied times can overlap in the schedule with no consequence.

To extend an occupied mode beyond its normal termination for a one-time schedule override, program as shown below:

<input type="text" value="1"/> <input type="text" value="SCHD"/>	OVRD 0	Override is set for 0. Enter the number of hours of override desired
<input type="text" value="3"/> <input type="text" value="ENTR"/>	OVRD 3	Unit will now remain in occupied mode for an additional 3 hours

Holiday Schedule — Press to schedule up to 30 holiday periods. All holidays are entered with numerical values. First, the month (01 to 12), then the day (01 to 31), then the duration of the holiday period in days.

Examples: July 04 is 07.04.01.
Dec 25 - 26 is 12.25.02

If any of the 30 holiday periods are not used, the display shows NEW.

See Example 10.

Example 10 — Holiday Schedule Function

ENTER	DISPLAY
<input type="text" value="11"/> <input type="text" value="SCHD"/>	HOLIDAY
<input type="text" value="↓"/>	JAN01 02 (Includes Jan 1st and 2nd)
<input type="text" value="↓"/>	APR17 01 (Includes April 17th)
<input type="text" value="↓"/>	MAY21 01 (Includes May 21st)
<input type="text" value="↓"/>	JUL03 01 (Includes July 3rd)
<input type="text" value="7"/> <input type="text" value="."/> <input type="text" value="0"/> <input type="text" value="4"/> <input type="text" value="."/> <input type="text" value="0"/> <input type="text" value="1"/> <input type="text" value="ENTR"/>	JUL04 01 (Includes July 4th)
<input type="text" value="↓"/>	SEP07 01 (Includes Sep. 7th)
<input type="text" value="↓"/>	NOV26 02 (Includes Nov. 26th and 27th)
<input type="text" value="↓"/>	DEC24 02 (Includes Dec. 24th and 25th)
<input type="text" value="↓"/>	DEC30 02 (Includes Dec. 30th and 31st)
<input type="text" value="↓"/>	NEW
<input type="text" value="5"/> <input type="text" value="."/> <input type="text" value="2"/> <input type="text" value="5"/> <input type="text" value="."/> <input type="text" value="0"/> <input type="text" value="1"/> <input type="text" value="ENTR"/>	MAY25 01 (Includes May 25th)
<input type="text" value="↓"/>	NEW
<input type="text" value="↓"/>	NEW
<input type="text" value="↓"/>	NEW
<input type="text" value="↓"/>	NEW
<input type="text" value="↓"/>	NEW (30TH HOLIDAY)

NEW indicates a holiday that has not been assigned yet.

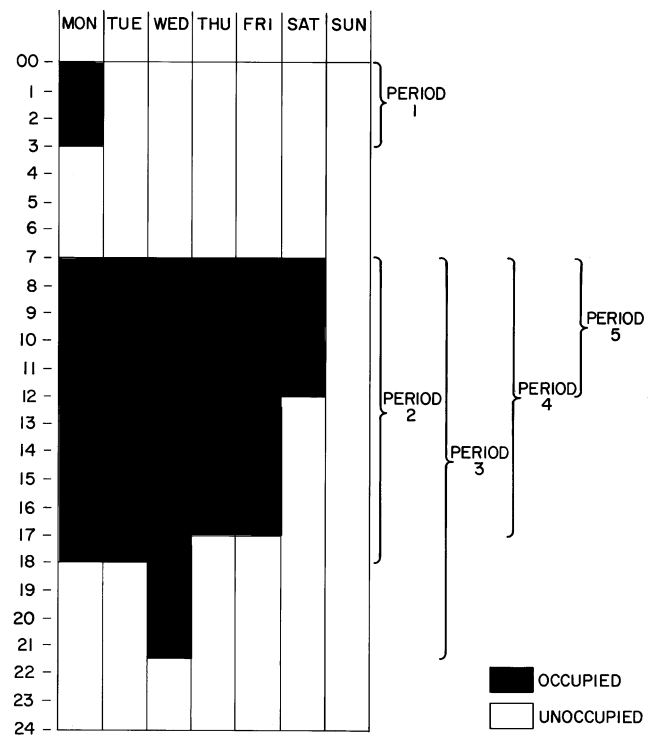

Fig. 10 — Sample Time Schedule

TROUBLESHOOTING

The Flotronic™ II control has many features to aid the technicians in troubleshooting a Flotronic II Chiller. By using the keypad and display module and the status function, actual operating conditions of the chiller are displayed while unit is running. Test function allows proper operation of compressors, compressor unloaders, fans, EXVs and other components to be checked while chiller is stopped. Service function displays how configurable items are configured. If an operating fault is detected, an alarm is generated and an alarm code(s) is displayed under the subfunction , along with an explanation of the fault. Up to 10 current alarm codes are stored under this subfunction. For checking specific items, see Table 9.

Checking Display Codes — To determine how machine has been programmed to operate, check diagnostic information () and operating mode displays (). If no display appears, follow procedures in Control Modules section on page 63. If display is working, continue as follows:

1. Note all alarm codes displayed, .
2. Note all operating mode codes displayed, .
3. Note leaving chilled water temperature set point in effect and current leaving water temperature, .

If machine is running, compare the “in effect” leaving water temperature set point with current water temperature. Remember, if reset is in effect, the values may be different because machine is operating to the modified chilled water set point. If current temperature is equal to set point, but set point is not the one desired, remember that if dual set point has been selected in the schedule function, there are 2 set points to which the machine can be operating. Check the programming of schedule function to see if occupied or unoccupied set point should be in effect.

Unit Shutoff — To shut unit off, move LOCAL/ENABLE-STOP-CCN switch to STOP position. Any refrigeration circuit operating at this time continues to complete the pumpout cycle. Lag compressors stop immediately, and lead compressors run to complete pumpout.

Complete Unit Stoppage — Complete unit stoppage can be caused by any of the following conditions:

1. Cooling load satisfied
2. Remote on/off contacts open
3. Programmed schedule
4. Emergency stop command from CCN
5. General power failure
6. Blown fuse in control power feed disconnect
7. Open control circuit fuse
8. LOCAL/ENABLE-STOP-CCN switch moved to STOP position
9. Freeze protection trip
10. Low flow protection trip
11. Open contacts in chilled water flow switch (optional)
12. Open contacts in any auxiliary interlock. Terminals that are jumpered from factory are in series with control switch. Opening the circuit between these terminals places unit in stop mode, similar to moving the control switch to STOP position. Unit cannot start if these contacts are open. If they open while unit is running, unit pumps down and stops.
13. Cooler entering or leaving fluid thermistor failure
14. Low transducer supply voltage
15. Loss of communications between processor module and other control modules
16. Low refrigerant pressure
17. Off-to-on delay is in effect.

Single Circuit Stoppage — Single circuit stoppage can be caused by the following:

1. Low oil pressure in lead compressor
2. Open contacts in lead compressor high-pressure switch
3. Low refrigerant pressure
4. Thermistor failure
5. Transducer failure
6. Ground fault in lead compressor indicator (indicator is field-supplied on 040-060, 070 [60 Hz], and 080-110 and associated modular units)
7. High suction superheat
8. Low suction superheat
9. Lead compressor circuit breaker trip. Stoppage of one circuit by a safety device action does not affect other circuit. When a safety device trips on a lead compressor, circuit is shut down immediately and EXV closes.
10. Ground fault for any circuit compressor (130-210 and associated modular units).

Lag Compressor Stoppage — Lag compressor stoppage can be caused by the following:

1. Open contacts in high-pressure switch
2. Compressor ground fault (indicator is field-supplied on 040-060, 070 [60 Hz], and 080-110 and associated modular units)
3. Compressor circuit breaker trip
4. Not required to run to meet cooling load requirement

▲ CAUTION

If stoppage occurs more than once as a result of any of the above safety devices, determine and correct the cause before attempting another restart.

Restart Procedure — After cause for stoppage has been corrected, restart is either automatic or manual, depending on fault. Manual reset requires that LOCAL/ENABLE-STOP-CCN switch be moved to STOP position, then back to original operating position. Some typical fault conditions are described in Table 15. For a complete list of fault conditions, codes, and reset type, see Table 16.

Table 15 — Typical Stoppage Faults and Reset Types

Chilled Fluid, Low Flow	Manual reset
Chilled Fluid, Low Temperature	Auto reset first time, manual if repeated in same day
Chilled Fluid Pump Interlock	Manual reset
Control Circuit Fuse Blown	Unit restarts automatically when power is restored
High-Pressure Switch Open	Manual reset
Low Refrigerant Pressure	Auto reset first time, then manual if within same day
Low Oil Pressure	Manual reset
Discharge Gas Thermostat Open	Manual reset

POWER FAILURE EXTERNAL TO THE UNIT — Unit restarts automatically when power is restored.

Alarms and Alerts — These are warnings of abnormal or fault conditions, and may cause either one circuit or the whole unit to shut down. They are assigned code numbers as described below. These code numbers are displayed on the HSIO when the 2 STAT subfunction is entered. A fault that affects one one circuit of the chiller will generate an alert, and a fault that affects the entire unit will generate an alarm.

Following is a detailed description of each alarm and alert code error and possible cause. Manual reset is accomplished by moving LOCAL/ENABLE-STOP-CCN Switch to STOP position, then back to LOCAL or CCN position. See Table 16 for listing of each alarm and alert code.

Code 0 No alarms or alerts exist

Codes 1 - 8 Compressor failure

If DSIO-LV or -EXV relay module control relay feedback switch or signal is sensed as open during operation of a compressor, microprocessor detects this and stops compressor, energizes alert light, and displays a code of 1, 2, 3, 4, 5, 6, 7, or 8 depending on the compressor. Compressor locks off; to reset, use manual reset method.

If lead compressor in a circuit shuts down, the other compressors in the circuit stop and lock off. Only the alert mode for lead compressor is displayed.

The microprocessor is also programmed to indicate compressor failure if feedback terminal on DSIO-LV or -EXV J3 terminal strip receives voltage when compressor is not supposed to be on.

NOTE: It takes 5 seconds for the control to generate the alarm code and lock out the compressor(s) on compressor failure code(s) 1 through 8.

Table 16 — Alarm and Alert Codes

DISPLAY	ALARM OR ALERT	DESCRIPTION	ACTION TAKEN BY CONTROL	CIRCUIT PUMPDOWN	RESET METHOD	PROBABLE CAUSE
0	—	No Alarms or Alerts Exist	—	—	—	—
1	Alert	Compressor A1 failure	Circuit A shut down	No	Manual	High-pressure switch trip, or wiring error.
2, 3, 4		Compressor A2, A3, A4 failure	Compressor shut down	Yes	Manual	CPCS Ground Fault Protection
5		Compressor B1 failure	Circuit B shut down	No	Manual	
6, 7, 8		Compressor B2, B3, B4 failure	Compressor shut down	Yes	Manual	
9	Alarm	Leaving fluid thermistor failure	Unit shut down	Yes	Auto.	Thermistor or transducer failure or wiring error.
10		Entering fluid thermistor failure	Unit shut down	Yes	Auto.	
19	Alert	Compressor A1 sensor failure	Circuit A shut down	Yes	Auto.	
20		Compressor B1 sensor failure	Circuit B shut down	Yes	Auto.	
21		Reset thermistor failure	Normal set point used	No	Auto.	
22	Alert	Discharge pressure transducer failure, circuit A	Circuit A shut down	Yes	Auto.	
23		Discharge pressure transducer failure, circuit B	Circuit B shut down	Yes	Auto.	
24		Suction pressure transducer failure, circuit A	Circuit A shut down	No	Auto.	
25		Suction pressure transducer failure, circuit B	Circuit B shut down	No	Auto.	
26		Oil pressure transducer failure, circuit A	Circuit A shut down	No	Auto.	
27		Oil pressure transducer failure, circuit B	Circuit B shut down	No	Auto.	
28	Alarm	Transducer supply voltage low	Unit shut down	No	Auto.	Unit voltage low or PS1 faulty. Switch failure or wiring error.
29		LOCAL/ENABLE-STOP-CCN	Unit shut down	No	Manual	
30	Alert	4-20 mA reset input failure	Normal set point used	No	Auto.	Wiring error or faulty module or improper address code.
31		4-20 mA demand limit failure	Demand limit ignored	No	Auto.	
32	Alarm	Loss of communication with DSIO-LV	Unit shut down	No	Auto.	
33		Loss of communication with DSIO-EXV	Unit shut down	No	Auto.	
34		Loss of communication with 4 In/4 Out module	Unit shut down	Yes	Auto.	
35	—	Not used	—	—	—	
36	Alert	Low refrigerant pressure circuit A	Circuit A shut down	No	*	Low refrigerant charge, plugged filter drier, faulty expansion valve.
37		Low refrigerant pressure circuit B	Circuit B shut down	No	*	Low refrigerant charge, plugged filter drier, faulty expansion valve.
38	Alert	Failure to pump out circuit A	Circuit A shut down	No	Manual	Faulty expansion valve, transducer, or thermistor.
39		Failure to pump out circuit B	Circuit B shut down	No	Manual	Faulty expansion valve, transducer, or thermistor.
40	Alert	Low oil pressure circuit A	Circuit A shut down	No	Manual	Low oil level, circuit breaker trip, faulty expansion valve, crankcase heater, or pressure transducer.
41		Low oil pressure circuit B	Circuit B shut down	No	Manual	Low oil level, circuit breaker trip, faulty expansion valve, crankcase heater, or pressure transducer.
42	Alarm	Cooler freeze protection	Unit shut down	No	*	Low fluid flow or faulty thermistor.
43		Low cooler fluid flow	Unit shut down	No	Manual	Chilled fluid pump failure or faulty thermistor.
44	Alert	Low suction temperature circuit A	Circuit A shut down after 10 minutes	No	Manual	Faulty expansion valve or thermistor.
45		Low suction temperature circuit B	Circuit B shut down after 10 minutes	No	Manual	Faulty expansion valve or thermistor.
46	Alert	High suction superheat circuit A	Circuit A shut down	Yes	Manual	Low charge, faulty expansion valve or thermistor, or plugged filter drier.
47		High suction superheat circuit B	Circuit B shut down	Yes	Manual	Low charge, faulty expansion valve or thermistor, or plugged filter drier.
48	Alert	Low suction superheat circuit A	Circuit A shut down	Yes	Manual	Faulty EXV or thermistor.
49		Low suction superheat circuit B	Circuit B shut down	Yes	Manual	Faulty EXV or thermistor.
50	Alarm	Illegal configuration	Unit cannot start	—	Manual	Configuration error.
51		Initial configuration required	Unit cannot start	—	Manual	Configuration omitted.
52		Emergency stop by CCN command	Unit shut down	Yes	CCN	Network command.
53	Alarm	Cooler pump interlock failure	Unit shut down	No	Manual	Failure of cooler pump or controls
54		Cooler pump interlock failure	Unit shut down	No	Manual	Failure of cooler pump or controls
55		Cooler pump interlock failure	Cooler pump shut down	—	Manual	Failure of cooler pump relay or interlock
56	Alert	WSM communication failure	WSM forces removed	—	Auto.	Wiring fault or module failure
57	Alert	Calibration required for discharge pressure transducer, circuit A	Circuit cannot start	—	Auto.	Transducer not calibrated
58		Calibration required for discharge pressure transducer, circuit B	Circuit cannot start	—	Auto.	
59		Calibration required for suction pressure transducer, circuit A	Circuit cannot start	—	Auto.	
60		Calibration required for suction pressure transducer, circuit B	Circuit cannot start	—	Auto.	
61		Calibration required for oil pressure transducer, circuit A	Circuit cannot start	—	Auto.	
62		Calibration required for oil pressure transducer, circuit B	Circuit cannot start	—	Auto.	

Table 16 — Alarm and Alert Codes (cont)

DISPLAY	ALARM OR ALERT	DESCRIPTION	ACTION TAKEN BY CONTROL	CIRCUIT PUMPDOWN	RESET METHOD	PROBABLE CAUSE
63	Alarm	Complete unit shutdown	Alarm only	—	Auto.	Check individual alarms
64 65	Alert	Loss of charge, circuit A Loss of charge, circuit B	Circuit cannot start Circuit cannot start	— —	Auto. Auto.	Refrigerant leak or transducer failure
66	Alarm	FSM communication loss	FSM forces removed	—	Auto.	Wiring faulty or module failure
67	Alarm	Transducer calibration date code failure	Unit cannot start	—	Auto.	Incorrect date code entered
68,69	—	Not used	—	—	—	—
70	Alert	High leaving chilled fluid temperature	Alarm only	—	Auto.	Building load greater than unit capacity, low water/brine flow, or compressor fault. Check for other alarms or alerts.

LEGEND

- CPCS — Compressor Protection Control Module
- FSM — Flotronic™ System Manager
- PS — Power Supply
- WSM — Water System Manager

*Reset automatic first time, manual if repeated same day.

Possible causes of failure:

1. High-Pressure Switch Open — High-pressure switch for each compressor is wired in series with 24-v power that energizes compressor control relay. If high-pressure switch opens during operation, compressor stops. This is detected by microprocessor through the feedback terminals.
2. DSIO-LV or DSIO-EXV Module Failure — If a DSIO-LV relay module relay fails open or closed, microprocessor detects this, locks compressor off, and indicates an error.
3. Wiring Errors — If a wiring error exists causing CPCS, CR, or feedback switch to not function properly, microprocessor indicates an error.
4. Processor (PSIO) Failure — If hardware that monitors feedback switch fails, or processor fails to energize relay module relay to on, an error may be indicated.

NOTE: The control does not detect circuit breaker failures. If a circuit breaker trips on lead compressor in a circuit, a low oil pressure failure is indicated. On the other compressors, no failure is indicated.

5. Ground Fault Module on 130-210 and associated modular units (CGFA or CGFB) Open — Module contacts are in lead compressor circuits, but ground fault could be in any compressor in affected circuit.

Ground fault of any 040-110 and associated modular unit compressor (field-supplied accessory on 040-060 and 070, 60 Hz units; standard on 070, 50 Hz and 80-110 and associated modular units) will cause a trip.

6. Checkout Procedure — Shut off main power to unit. Turn on control power, then step through subfunction

2

_{RESET} to proper compressor number (i.e., failure code 5 is compressor B1). Next, energize the step. If step works correctly, then failure code is caused by:

- HPS (high-pressure switch) open
- Misplaced feedback wire from J4 and J5 terminals
- Ground wire and 24-v feeds reversed on one or more points on J3

Compressor Alarm/Alert Circuit — For compressor A1 circuit, processor closes contacts between J4 terminals 2 and 3 to start compressor. See Fig. 11A-11C. Safeties shown to left of J4 must be closed in order for power to reach compressor control relay, and the feedback input terminals on J3.

Failure of power to terminal 1 on J3, when contacts between 2 and 3 on J4 should be closed, causes a code 1 alert.

Terminal 2 on J3 is the other leg of the compressor A1 feedback channel. It is connected to the 24-v common.

NOTE: Similar connections for each compressor can be followed on the unit wiring diagrams located on the unit.

Code 9 Leaving fluid thermistor failure (alarm)

Code 10 Entering fluid thermistor failure (alarm)

If temperature measured by these thermistors is outside range of -40 to 240 F (-40 to 116 C), unit shuts down after going through a normal pumpout. Reset is automatic if temperature returns to the acceptable range, and unit start-up follows normal sequence. The cause of the fault is usually a bad thermistor, wiring error, or loose connection.

Code 19 Compressor A1 suction sensor failure (alert)

Code 20 Compressor B1 suction sensor failure (alert)

On units with thermistors, if temperature measured by these thermistors is outside the range of -40 to 240 F (-40 to 116 C), affected circuit shuts down after going through a normal pumpout. Other circuit continues to run. Reset is automatic if temperature returns to the acceptable range, and circuit start-up follows normal sequence. The cause of this fault is usually a bad thermistor, wiring error, or loose connection.

On units with transducers, if the saturated suction temperature is greater than the leaving fluid temperature plus 10° F (5.5 C) for more than 5 minutes, the affected circuit shuts down (after going through normal pumpout). The reset is automatic if the saturated suction temperature returns to the acceptable range and start-up follows the normal sequence. The cause of this fault is usually a bad transducer, a wiring error, or a loose connection.

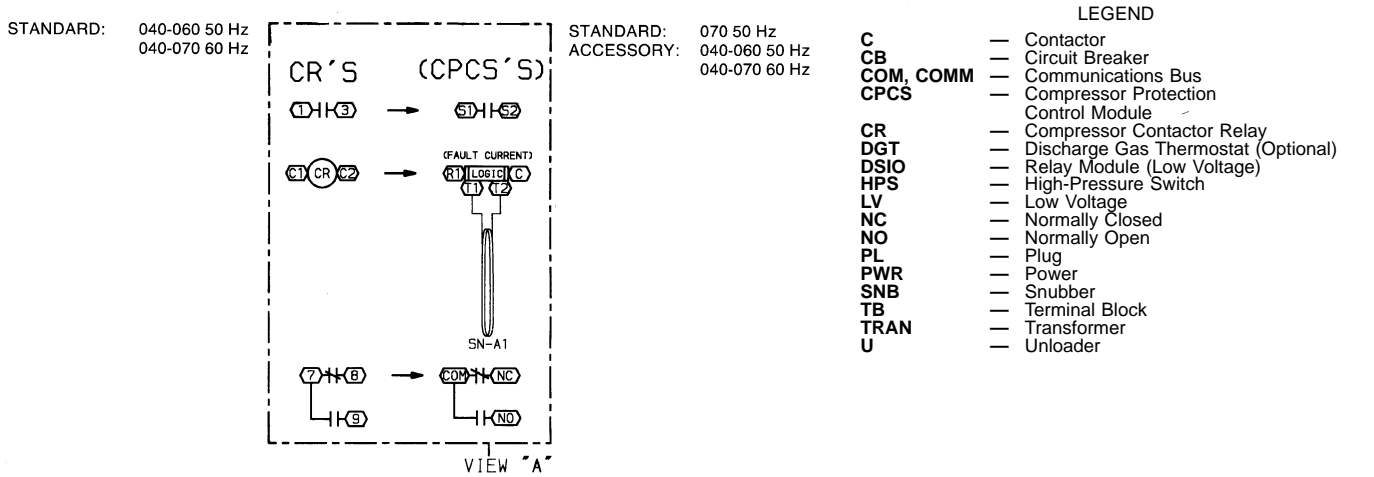
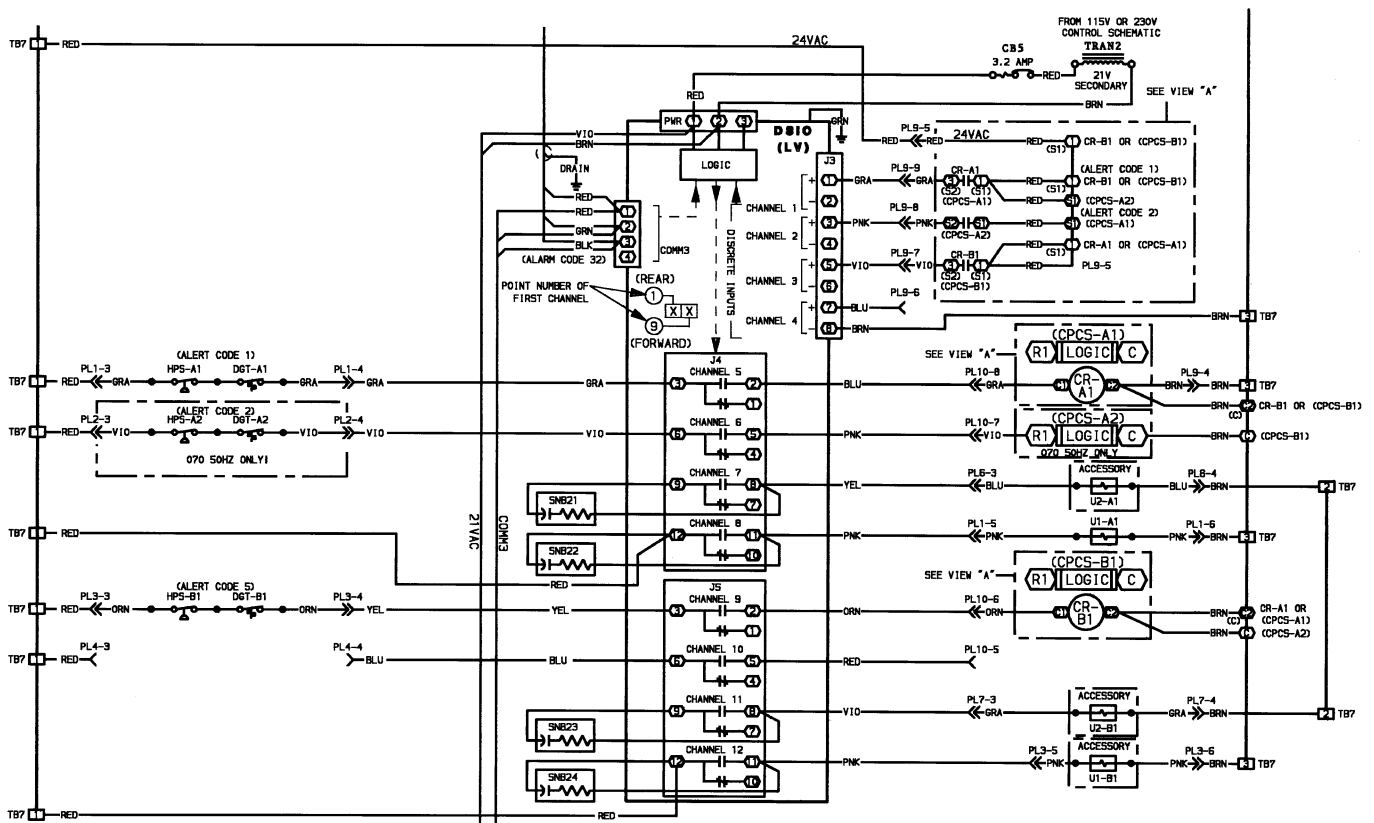
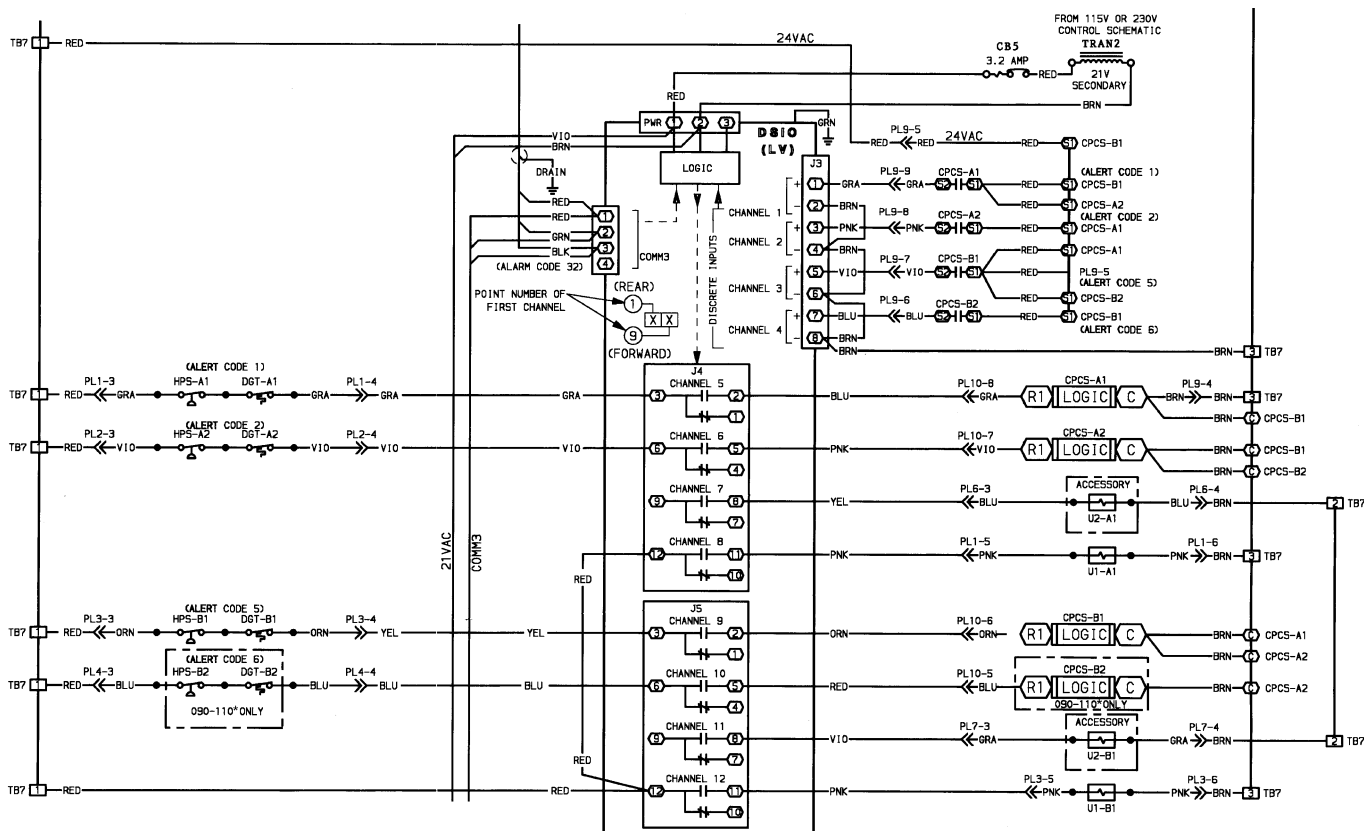

Fig. 11A — 24-V Safety Circuit Wiring (040-070)

- Code 21** Reset thermistor failure (applies only to installations having external temperature reset) (alert)
If temperature measured by this thermistor is outside range of -40 to 240 F (-40 to 116 C), reset function is disabled and unit controls to normal set point. If temperature returns to the acceptable range, reset function is automatically enabled. The cause of this fault is usually a bad thermistor, wiring error, or loose connection.
- Code 22** Compressor A1 discharge pressure transducer failure (alert)
- Code 23** Compressor B1 discharge pressure transducer failure (alert)
- Code 24** Compressor A1 suction pressure transducer failure (alert)
- Code 25** Compressor B1 suction pressure transducer failure (alert)
- Code 26** Compressor A1 oil pressure transducer failure (alert)

- Code 27** Compressor B1 oil pressure transducer failure (alert)
If output voltage of any of these transducers is greater than 5 v, affected circuit shuts down without going through pumpout process (Alerts 24-27). Other circuit continues to run. Reset is automatic if output voltage returns to the acceptable range, and circuit start-up follows normal sequence. The cause of this fault is usually a bad transducer or a wiring error.
- Code 28** Low transducer supply voltage (alarm)
If transducer supply voltage is less than 4.5 v or greater than 5.5 v, unit shuts down without going through pumpout process. Reset is automatic if supply voltage returns to the acceptable range, and circuit start-up follows normal sequence. The cause of this fault is usually a faulty transformer or primary voltage is out of range.



LEGEND

- C** — Contactor
- CB** — Circuit Breaker
- COMM** — Communications Bus
- CPCS** — Compressor Protection Control Module
- DGT** — Discharge Gas Thermostat (Optional)
- DSIO** — Relay Module (Low Voltage)
- HPS** — High-Pressure Switch
- LV** — Low Voltage
- PL** — Plug
- PWR** — Power
- TB** — Terminal Block
- TRAN** — Transformer
- U** — Unloader

*And associated modular units.

Fig. 11B — 24-V Safety Circuit Wiring (080-110 and Associated Modular Units)

The voltage supplied to the processor is polarized. When checking for proper voltage supply, be sure to consider this polarity. If voltage appears to be within acceptable tolerance, check to be sure the transformer supplying PS1 is not grounded. *Grounding the supply transformer can result in serious damage to the control system.*

Code 29 LOCAL/ENABLE-STOP-CCN Switch Failure (switch resistances out of range) (alarm)

This fault occurs due to the failure of the switch or due to a wiring error.

Code 30 Reset input failure (4 to 20 mA) (alert)
Code 31 Demand limit input failure (4 to 20 mA) (alert)

These codes apply only if unit is configured for these functions. If 4 to 20 mA signal is less than 4 or more than 20 mA, reset or demand limit function is disabled and unit functions normally. If mA signal returns to the acceptable range, function is automatically enabled.

Code 32 Loss of communication with compressor relay module (DISO-LV) (alarm)

Code 33 Loss of communication with EXV relay module (DSIO-EXV) (alarm)

If communication is lost with either of these modules, unit shuts down without pumpout. This alarm resets automatically when communication is restored. The unit starts up normally after alarm condition is reset. Probable cause of condition is a faulty or improperly connected plug, wiring error, or faulty module.

Loss of communication can be attributed to a grounded transformer with a secondary voltage of 21 vac supplying the PSIO, DSIO-LV, or 4 IN/4 OUT modules; the 12.5-vac transformer supplying the DSIO-EXV module; or the 24-vac transformer supplying PS1 for the transformers. *These transformers should not be grounded, or serious damage to controls can result.* Check to be sure the transformers are not grounded.

NOTE: If a blank PSIO module is downloaded without being connected to the modules DSIO, this alarm is energized.

Code 34 Loss of communication with 4 In/4 Out module (alarm)

This applies only if one or more of the following options are used:

- external temperature reset
- 4 to 20 mA temperature reset
- external switch controlled dual set point
- switch controlled demand limit
- 4 to 20 mA demand limit
- hot gas bypass

If communication is lost with 4 IN/4 OUT module, the unit shuts off automatically, after finishing pumpout. Reset of alarm is automatic when communication is restored. Start-up after alarm is remedied follows a normal sequence. Probable cause of condition is a faulty or improperly connected plug, wiring error, or faulty module.

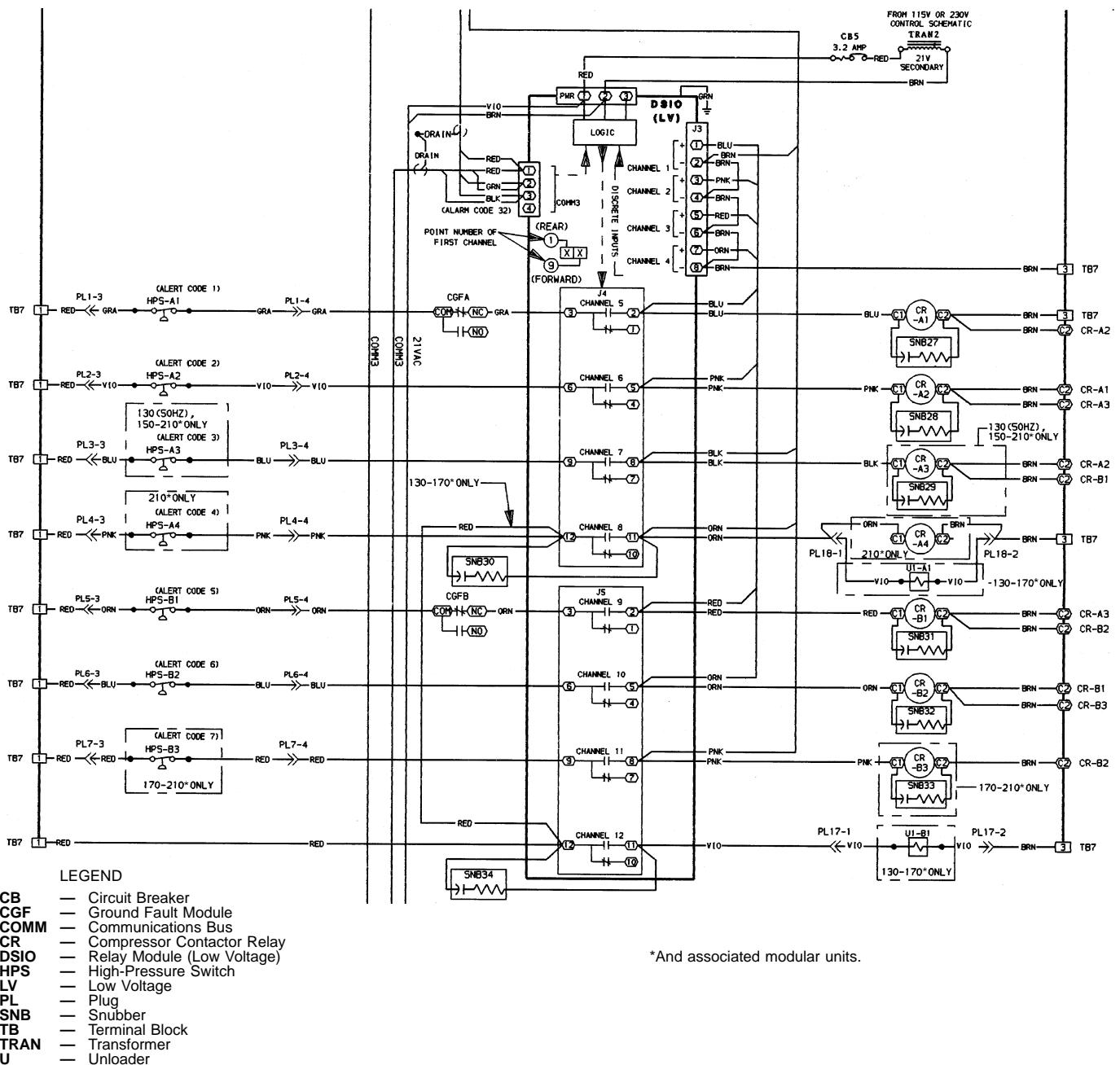

Fig. 11C — 24-V Safety Circuit Wiring (130-210 and Associated Modular Units)

Loss of communication can be attributed to a grounded transformer with a secondary voltage of 21 vac supplying the PSIO, DSIO-LV, or 4 IN/4 OUT; the 12.5-vac transformer supplying the DSIO-EXV module, or the 24-vac transformer supplying PS1 for the transformers. *These transformers should not be grounded, or serious damage to controls can result.* Check to be sure the transformers are not grounded.

Code 36 Low refrigerant pressure, Circuit A (alert)

Code 37 Low refrigerant pressure, Circuit B (alert)

If suction pressure transducer senses a pressure below set point for more than 5 minutes at start-up or more than 2 minutes during normal operation, affected circuit shuts down without going through the pumpout process. Reset is automatic when pressure reaches 10 psig above set point if there have been no previous occurrences of this fault on the same day. If this is a repeat occurrence on same day, then reset is manual, with LOCAL/ENABLE-STOP-CCN switch. Factory configured set point is 27 psig for standard chillers and 12 psig for brine chillers.

Possible causes of fault are low refrigerant charge, faulty EXV, plugged filter drier, or faulty transducer.

Code 38 Failure to pump out, Circuit A (alert)

Code 39 Failure to pump out, Circuit B (alert)

The pumpout process is terminated when saturated suction temperature is 10° F (5.6° C) below temperature at beginning of pumpout, or 10° F (5.6° C) below leaving water temperature or reaches a saturated suction temperature of -15 F (-26 C). If appropriate saturated suction temperature is not met within 3 minutes (on 2 consecutive tries), circuit shuts down without pumpout. Reset is manual with LOCAL/ENABLE-STOP-CCN switch, and start-up follows normal sequence.

Possible causes for this alarm are a bad thermistor or transducer or a faulty expansion valve.

Code 40 Low oil pressure, Circuit A (alert)

Code 41 Low oil pressure, Circuit B (alert)

If oil pressure differential is less than set point for more than 2 minutes at start-up, or more than one minute during normal operation, affected circuit shuts down without going through pumpout process. Reset is manual with LOCAL/ENABLE-STOP-CCN switch, and start-up follows normal sequence. Factory configured differential oil pressure is 6 psig.

Possible causes of fault are faulty compressor, expansion valve, crankcase heater or transducer, refrigerant overcharge, insufficient oil charge, or tripped circuit breaker.

Code 42 Cooler freeze protection (alarm)

If cooler entering or leaving water temperature is below 34° F (1.1° C) for water or more than 8° F (4.4° C) below set point for brine, unit shuts down without pumpout. Chilled water pump continues to run if controlled by chiller controls. Reset is automatic when leaving fluid temperature reaches 6° F (3° C) above set point, providing there has been no prior occurrence of this fault the same day. If fault has occurred previously the same day, reset is manual with LOCAL/ENABLE-STOP-CCN switch.

Possible causes of fault are low fluid flow or faulty thermistor.

Code 43 Low fluid flow (alarm)

If any compressors are operating and entering fluid temperature is 3° F (1.7° C) or more below leaving fluid temperature for more than one minute, unit shuts down without pumpout. Chilled fluid pump also shuts down. Reset is manual with LOCAL/ENABLE-STOP-CCN switch, and start-up follows normal sequence.

This is a suitable method for sensing low fluid flow because entering fluid thermistor is in the cooler shell and responds more quickly to compressor operation than the leaving fluid thermistor in the leaving water nozzle. Possible causes of fault are faulty chilled fluid pump, control or thermistor.

Code 44 Low cooler suction temperature, Circuit A (alert)

Code 45 Low cooler suction temperature, Circuit B (alert)

If saturated suction temperature is less than 32 F (0° C) and is 20° F (11° C) for water or 30° F (16° C) for brine or more below leaving fluid temperature, mode 14 is displayed. Unit continues to run, but additional compressors are not allowed to start. If condition persists for more than 10 minutes, fault code is displayed, and unit shuts down without pumpout. Reset is manual with LOCAL/ENABLE-STOP-CCN switch, and start-up follows normal sequence.

Possible causes of fault are low refrigerant charge, plugged filter drier, or a faulty expansion valve or thermistor.

Code 46 High suction superheat, Circuit A (alert)

Code 47 High suction superheat, Circuit B (alert)

If expansion valve is fully open, suction superheat is greater than 75 F (42 C), and saturated evaporator temperature is less than MOP (maximum operating pressure) for more than 5 minutes, unit shuts down after normal pumpout process. Reset is manual with LOCAL/ENABLE-STOP-CCN switch, and start-up follows normal sequence.

Possible causes of fault are low refrigerant charge, plugged filter drier, or a faulty expansion valve or thermistor.

Code 48 Low suction superheat, Circuit A (alert)

Code 49 Low suction superheat, Circuit B (alert)

If EXV is at minimum position, suction superheat is less than 10° F (5.5° C) or saturated evaporator temperature is greater than MOP (maximum operating pressure) for more than 5 minutes, affected circuit shuts down after going through pumpout process. Reset is manual with LOCAL/ENABLE-STOP-CCN switch, and start-up follows normal sequence.

Possible causes of fault are faulty expansion valve or thermistor.

Code 50 Illegal configuration (alarm)

This fault indicates a configuration error. Unit is not allowed to start. Check all configuration data and set points and correct any errors.

Code 51 Initial configuration required (alarm)

This fault indicates factory configuration has not been done, and unit is not allowed to start. Refer to unit wiring label diagrams for factory configuration codes. There are 9 groups of 8-digit numbers that must be entered. The first 7 groups must be entered under

3	SHVC
---	------

 subfunction. Groups 8 and 9 must be entered under

5	SHVC
---	------

 subfunction.

Enter each group, then press the

ENTR

 key. Press the down arrow

↓

 after each group to bring up the next empty screen. Unit should start after factory and field configurations are correctly entered.

The usual cause of this fault is replacement of the processor module. Refer to instructions accompanying the replacement module.

Code 52 Emergency stop by CCN command (alarm).

Unit shuts down immediately without pumpout when this command is received, and goes through normal start-up when command is cancelled.

Code 53 Cooler pump interlock failure — Contacts fail to close at start-up (alarm)

If the unit is configured for cooler pump control and cooler pump interlock, and the interlock fails to close within one minute of starting the cooler pump, the unit is shut down without pumpout. The cooler pump is also shut down. Reset is manual with the LOCAL/ENABLE-STOP-CCN switch, and start-up follows the normal sequence.

Possible causes are:

1. Interlock switch fails to close within one minute after chilled water pump starts
2. Interlock switch opens during unit operation
3. Interlock voltage is detected, but unit is not configured for interlock
4. Interlock voltage is outside its valid range

If any of these conditions occur, all compressors are disabled and, if running, shutdown occurs without pumpout. Chilled fluid pump also shuts down. Reset is manual, with LOCAL/ENABLE-STOP-CCN switch. Most probable cause of this fault is shutdown or failure of chilled fluid pump to start. Other possibilities are improper configuration or wiring errors.

Code 54 Cooler pump interlock failure — Contacts open during normal operation (alarm)

If the unit is configured for cooler pump control and cooler pump interlock, and the interlock opens during normal operation, the unit is shut down without pumpout. The cooler pump is also shut down. Reset is manual with the LOCAL/ENABLE-STOP-CCN switch, and startup follows the normal sequence.

Possible causes are:

1. Interlock switch fails to close within one minute after chilled water pump starts
2. Interlock switch opens during unit operation
3. Interlock voltage is detected, but unit is not configured for interlock
4. Interlock voltage is outside its valid range

If any of these conditions occur, all compressors are disabled and, if running, shutdown occurs without pumpout. Chilled fluid pump also shuts down. Reset is manual, with

LOCAL/ENABLE-STOP-CCN switch. Most probable cause of this fault is shutdown or failure of chilled fluid pump to start. Other possibilities are improper configuration or wiring errors.

Code 55 Cooler pump interlock failure — Contacts closed when pump is off (alarm)

If the unit is configured for cooler pump control and cooler pump interlock, and the interlock is closed when the cooler pump relay is off, the cooler pump shall be shut down and the unit prevented from starting. Reset is manual with the LOCAL/ENABLE-STOP-CCN switch.

Possible causes are:

1. Interlock switch fails to close within one minute after chilled water pump starts
2. Interlock switch opens during unit operation
3. Interlock voltage is detected, but unit is not configured for interlock
4. Interlock voltage is outside its valid range

If any of these conditions occur, all compressors are disabled and, if running, shutdown occurs without pumpout. Chilled fluid pump also shuts down. Reset is manual, with LOCAL/ENABLE-STOP-CCN switch. Most probable cause of this fault is shutdown or failure of chilled fluid pump to start. Other possibilities are improper configuration or wiring errors.

Code 56 Water System Manager (WSM) communication failure (alert)

If the WSM has previously established communications with the control and the WSM is not disabled and has not communicated with the control within the last 5 minutes, the control will remove all WSM forces from the chillers variables. The chiller will continue to operate on a stand-alone basis. Reset is automatic when the WSM re-establishes communication with the unit.

Code 57 Calibration required for discharge pressure transducer, circuit A (alert)

Code 58 Calibration required for discharge pressure transducer, circuit B (alert)

If the discharge pressure transducer has not been successfully calibrated, the circuit will not start. Reset is automatic upon successful calibration of the transducer.

Code 59 Calibration required for suction pressure transducer, circuit A (alert)

Code 60 Calibration required for suction pressure transducer, circuit B (alert)

If the suction pressure transducer has not been successfully calibrated, the circuit will not start. Reset is automatic upon successful calibration of the transducer.

Code 61 Calibration required for oil pressure transducer, circuit A (alert)

Code 62 Calibration required for oil pressure transducer, circuit B (alert)

If the oil pressure transducer has not been successfully calibrated, the circuit will not start. Reset is automatic upon successful calibration of the transducer.

Code 63 Complete unit shutdown due to failure (alarm)

This alarm alerts the user that the unit is totally shut down due to one or more fault conditions. Reset is automatic when all alarms causing complete unit shutdown are reset.

Code 64 Loss of charge, circuit A (alert)

Code 65 Loss of charge, circuit B (alert)

If the unit uses suction and discharge transducers with the same part number, and the discharge pressure is below 10 psig when the unit is shut down, the circuit will not start. Reset is automatic when the discharge pressure rises above

15 psig. This alarm does not function in units using different part number transducers for suction and discharge pressure, since the discharge transducer in that application does not function below 20 psig.

Code 66 Flotronic™ System Manager loss of communications (alarm)

If the FSM has established communication with the control, and the communication is subsequently lost for more than 20 seconds, the control will remove all forces on the chiller variables. Control of the unit will revert to stand-alone basis, and reset is automatic upon re-establishment of communication.

Code 67 Transducer calibration failure due to incorrect date code (alarm)

This applies to units having pressure transducers with the same part number for both suction and discharge pressures. If the transducer calibration is attempted and the factory default date code (Jan. 1, 1980) is in the date variable, then the unit will not start. Reset is automatic when the proper date code is entered upon calibration.

Code 70 High leaving chilled fluid temperature (alert)

If the leaving chilled fluid temperature is rising and is higher than the limit established in the subfunction and the unit is at full capacity then alert 70 will be activated. The unit will continue to function normally, and reset will be automatic upon leaving chilled fluid temperature dropping to 5° F below the limit or less than control set point.

Electronic Expansion Valve (EXV)

NOTE: This applies to all units except 30GN040 and 045 with optional brine. The 040 and 045 units with optional brine have TXVs.

EXV OPERATION — These valves control the flow of liquid refrigerant into the cooler. They are operated by the processor to maintain a specified superheat at lead compressor entering gas thermistor (located between compressor motor and cylinders). There is one EXV per circuit. See Fig. 12.

High-pressure liquid refrigerant enters valve through bottom. A series of calibrated slots are located in side of orifice assembly. As refrigerant passes through orifice, pressure drops and refrigerant changes to a 2-phase condition (liquid and

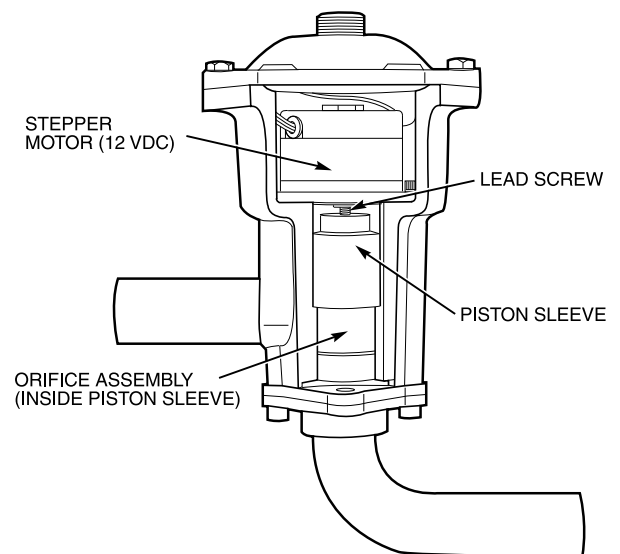

Fig. 12 — Electronic Expansion Valve (EXV)

vapor). To control refrigerant flow for different operating conditions, sleeve moves up and down over orifice, thereby changing orifice size. Sleeve is moved by a linear stepper motor. Stepper motor moves in increments and is controlled directly by the processor module. As stepper motor rotates, motion is transferred into linear movement by lead screw. Through stepper motor and lead screws, 1500 discrete steps of motion are obtained. The large number of steps and long stroke result in very accurate control of refrigerant flow.

The subfunction shows EXV valve position as a percent of full open. Position should change constantly while unit operates. If a valve stops moving for any reason (mechanical or electrical) other than a processor or thermistor failure, the processor continues to attempt to open or close the valve to correct the superheat. Once the calculated valve position reaches 120 (fully closed) or 1500 (fully open), it remains there. If EXV position reading remains at 120 or 1500, and the thermistors and pressure transducers are reading correctly, the EXV is not moving. Follow EXV checkout procedure below to determine cause.

The EXV is also used to limit cooler suction temperature to 50 F (10 C). This makes it possible for chiller to start at higher cooler fluid temperatures without overloading compressor. This is commonly referred to as MOP (maximum operating pressure), and serves as a load limiting device to prevent compressor motor overloading. This MOP or load limiting feature enables the 30G Flotronic™ II chillers to operate with up to 95 F (35 C) entering fluid temperatures during start-up and subsequent pull-down.

CHECKOUT PROCEDURE — Follow steps below to diagnose and correct EXV problems.

1. Check EXV driver outputs. Check EXV output signals at appropriate terminals on EXV driver module (see Fig. 13) as follows:

Connect positive test lead to terminal 1 on EXV driver. Set meter for approximately 20 vdc. Enter outputs subfunction of test function by pressing , then

advance to EXVA test by pressing 10 times. Press

. The driver should drive the circuit A EXV fully open. During next several seconds connect negative test lead to pins 2, 3, 4, and 5 in succession. Voltage should rise and fall at each pin. If it remains constant at a voltage or at zero v, remove connector to valve and recheck.

Press to close circuit A EXV. If a problem still exists, replace EXV driver module. If voltage reading is correct, expansion valve should be checked. Next, test EXVB. Connect positive test lead to pin 7 and the negative test lead to pin 8, 9, 10, and 11 in succession during EXVB test.

2. Check EXV wiring. Check wiring to electronic expansion valves from terminal strip on EXV driver. See Fig. 13.

- a. Check color coding and wire connections. Make sure they are connected to correct terminals at driver and EXV plug connections.
- b. Check for continuity and tight connection at all pin terminals.
- c. Check plug connections at driver and at EXVs to be sure EXV cables are not crossed.

3. Check resistance of EXV motor windings. Remove plug at J4 terminal strip and check resistance between common lead (red wire, terminal D) and remaining leads, A, B, C, and E (see Fig. 13). Resistance should be 25 ohms ± 2 ohms.

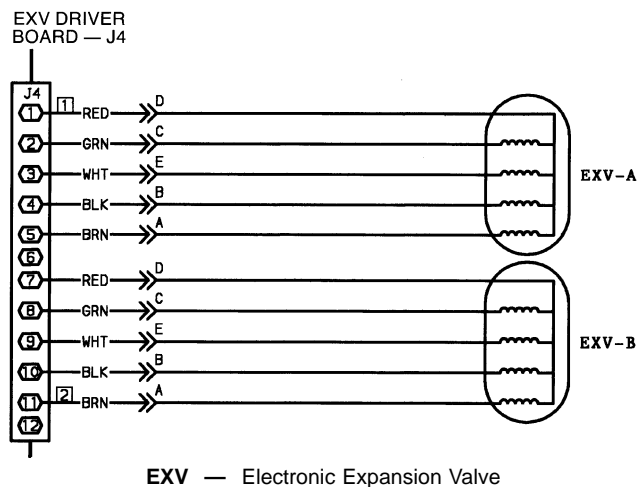

EXV — Electronic Expansion Valve

Fig. 13 — EXV Cable Connections to EXV Driver Module, DSIO (EXV)

Control of valve is by microprocessor. A thermistor and a pressure transducer located in lead compressor are used to determine superheat. The thermistor measures temperature of the superheated gas entering the compressor cylinders. The pressure transducer measures refrigerant pressure in the suction manifold. The microprocessor converts pressure reading to a saturation temperature. The difference between temperature of superheated gas and saturation temperature is the superheat.

Because the EXVs are controlled by the processor module, it is possible to track valve position. During initial start-up, EXV is fully closed. After start-up, valve position is tracked by processor by constantly observing amount of valve movement.

The processor keeps track of EXV position by counting the number of open and closed steps it has sent to each valve. It has no direct physical feedback of valve position. Whenever unit is switched from STOP to RUN position, both valves are initialized, allowing the processor to send enough closing pulses to the valve to move it from fully open to fully closed, then reset the position counter to zero.

4. The EXV test can be used to drive EXV to any desired position. When EXV opens, the metering slots begin to provide enough refrigerant for operation at step 120. This is fully closed position when circuit is operating. The fully open position is 1500 steps.
5. Check thermistors and pressure transducers that control EXV. Check thermistors and pressure transducers that control processor output voltage pulses to EXVs. See Fig. 14 for locations.

Circuit A — Thermistor T7, Suction Pressure Transducer SPTA

Circuit B — Thermistor T8, Suction Pressure Transducer SPTB

- a. Use temperature subfunction of the status function () to determine if thermistors are reading correctly.
- b. Check thermistor calibration at known temperature by measuring actual resistance and comparing value measured with values listed in Tables 17 and 18.
- c. Make sure thermistor leads are connected to proper pin terminals at J7 terminal strip on processor module and that thermistor probes are located in proper position in refrigerant circuit. See Fig. 15 and 16.
- d. Use the pressure subfunction of the Status function () to determine if pressure transducers are

reading correctly. Connect a calibrated gage to lead compressor suction or discharge pressure connection to check transducer reading.

- e. Make sure transducer leads are properly connected in junction box and at processor board. Check transformer 5 output. Check voltage transducer 5 vdc $\pm .2$ v.

When above checks have been completed, check actual operation of EXV by using procedures outlined in this step.

6. Check operation of EXV.

- a. Close liquid line service valve of circuit to be checked, and run through the test step (**2** **TEST**) for lead compressor in that circuit to pump down low side of system. Repeat test step 3 times to ensure all refrigerant has been pumped from low side.

NOTE: Be sure to allow compressors to run for the full pumpout period.

- b. Turn off compressor circuit breaker(s). Close compressor discharge service valves and remove any remaining refrigerant from low side of system.
- c. Remove screws holding top cover of EXV. Carefully remove top cover. If EXV plug was disconnected during this process, reconnect it after cover is removed.

▲ CAUTION

When removing top cover, be careful to avoid damaging motor leads.

- d. Enter appropriate EXV test step for EXVA or EXVB in the outputs subfunction of the test function (**1** **TEST**). Press **1** **0** **0** **ENTR** to initiate test. With cover lifted off EXV valve body, observe operation of valve motor and lead screw. The motor should turn counterclockwise, and the lead screw should move up out of motor hub until valve is fully open. Lead screw movement should be smooth and uniform from fully closed to fully open position. Press **.** **ENTR** to check open to closed operation.

If valve is properly connected to processor and receiving correct signals, yet does not operate as described above, valve should be replaced.

Operation of EXV valve can also be checked without removing top cover. This method depends on operator's skill in determining whether or not valve is moving. To use this method, initiate EXV test and open valve. Immediately grasp EXV valve body. As valve drives open, a soft, smooth pulse is felt for approximately 26 seconds as valve travels from fully closed to fully open. When valve reaches end of its opening stroke, a hard pulse is felt momentarily. Drive valve closed and a soft, smooth pulse is felt for the 52 seconds necessary for valve to travel from fully open to fully closed. When valve reaches end of its stroke, a hard pulse is again felt as valve overdrives by 50 steps. Valve should be driven through at least 2 complete cycles to be sure it is operating properly. If a hard pulse is felt for the 26-second duration, valve is not moving and should be replaced.

The EXV test can be repeated as required by entering any percentage from 0 (**.**) to 100 to initiate movement.

If operating problems persist after reassembly, they may be due to out-of-calibration thermistor(s) or intermittent connections between processor board terminals and EXV plug. Recheck all wiring connections and voltage signals.

Other possible causes of improper refrigerant flow control could be restrictions in liquid line. Check for plugged filter drier(s) or restricted metering slots in the EXV. Formation of ice or frost on lower body of electronic expansion valve is one symptom of restricted metering slots. However, frost or ice formation is normally expected when leaving fluid temperature from the cooler is below 40 F. Clean or replace valve if necessary.

NOTE: Frosting of valve is normal during compressor test steps and at initial start-up. Frost should dissipate after 5 to 10 minutes operation in a system that is operating properly. If valve is to be replaced, wrap valve with a wet cloth to prevent excessive heat from damaging internal components.

Thermostatic Expansion Valve (TXV) — Refer to base unit Installation Instructions for TXV information (30GN040,045 with optional brine only).

Thermistors — All thermistors are identical in their temperature vs. resistance performance. Resistance at various temperatures are listed in Tables 17 and 18.

LOCATION — General location of thermistor sensors are shown in Fig. 14.

Cooler Leaving Fluid Thermistor (T1) — T1 is located in leaving fluid nozzle. The probe is immersed directly in the fluid. All thermistor connections are made through a 1/4-in. coupling. See Fig. 16. Actual location is shown in Fig. 14 and 15.

Cooler Entering Fluid Thermistor (T2) — T2 is located in cooler shell in first baffle space near tube bundle. Thermistor connection is made through a 1/4-in. coupling. See Fig. 16. Actual location is shown in Fig. 14 and 15.

Compressor Suction Gas Temperature Thermistors (T7 and T8) — T7 and T8 are located in lead compressor in each circuit in suction passage between motor and cylinders, above oil pump. They are well-type thermistors. See Fig. 14 and 15.

THERMISTOR REPLACEMENT (T1, T2, T7, T8)

▲ CAUTION

Thermistors are installed directly in fluid. Relieve all pressure using standard practices or drain fluid before removing.

Proceed as follows (see Fig. 16):

To replace thermistor sensor T2:

1. Remove and discard original thermistor and coupling.

IMPORTANT: Do not disassemble new coupling. Install as received.

2. Apply pipe sealant to 1/4-in. NPT threads on replacement coupling and install in place of original. Do not use packing nut to tighten coupling. This damages ferrules (see Fig. 16).
3. Insert new thermistor in coupling body to its full depth. If thermistor bottoms out before full depth is reached, pull thermistor back out 1/8 in. before tightening packing nut. Hand tighten packing nut to position ferrules, then finish tightening 1 1/4 turns with a suitable tool. Ferrules are now attached to thermistor which can be withdrawn from coupling for unit servicing.

To replace thermistors T1, T7, and T8:

Add a small amount of thermal conductive grease to thermistor well. Thermistors are friction-fit thermistors, which must be slipped into well located in the compressor pump end.

Table 17 — Thermistor Temperature (°F) vs Resistance/Voltage Drop; Flotronic™ II

TEMPERATURE (F)	VOLTAGE DROP (V)	RESISTANCE (OHMS)	TEMPERATURE (F)	VOLTAGE DROP (V)	RESISTANCE (OHMS)	TEMPERATURE (F)	VOLTAGE DROP (V)	RESISTANCE (OHMS)
-25.0	4.821	98010	71	3.093	5781	167	0.838	719
-24.0	4.818	94707	72	3.064	5637	168	0.824	705
-23.0	4.814	91522	73	3.034	5497	169	0.810	690
-22.0	4.806	88449	74	3.005	5361	170	0.797	677
-21.0	4.800	85486	75	2.977	5229	171	0.783	663
-20.0	4.793	82627	76	2.947	5101	172	0.770	650
-19.0	4.786	79871	77	2.917	4976	173	0.758	638
-18.0	4.779	77212	78	2.884	4855	174	0.745	626
-17.0	4.772	74648	79	2.857	4737	175	0.734	614
-16.0	4.764	72175	80	2.827	4622	176	0.722	602
-15.0	4.757	69790	81	2.797	4511	177	0.710	591
-14.0	4.749	67490	82	2.766	4403	178	0.700	581
-13.0	4.740	65272	83	2.738	4298	179	0.689	570
-12.0	4.734	63133	84	2.708	4196	180	0.678	561
-11.0	4.724	61070	85	2.679	4096	181	0.668	551
-10.0	4.715	59081	86	2.650	4000	182	0.659	542
-9.0	4.705	57162	87	2.622	3906	183	0.649	533
-8.0	4.696	55311	88	2.593	3814	184	0.640	524
-7.0	4.688	53526	89	2.563	3726	185	0.632	516
-6.0	4.676	51804	90	2.533	3640	186	0.623	508
-5.0	4.666	50143	91	2.505	3556	187	0.615	501
-4.0	4.657	48541	92	2.476	3474	188	0.607	494
-3.0	4.648	46996	93	2.447	3395	189	0.600	487
-2.0	4.636	45505	94	2.417	3318	190	0.592	480
-1.0	4.624	44066	95	2.388	3243	191	0.585	473
0.0	4.613	42679	96	2.360	3170	192	0.579	467
1.0	4.602	41339	97	2.332	3099	193	0.572	461
2.0	4.592	40047	98	2.305	3031	194	0.566	456
3.0	4.579	38800	99	2.277	2964	195	0.560	450
4.0	4.567	37596	100	2.251	2898	196	0.554	445
5.0	4.554	36435	101	2.217	2835	197	0.548	439
6.0	4.540	35313	102	2.189	2773	198	0.542	434
7.0	4.527	34231	103	2.162	2713	199	0.537	429
8.0	4.514	33185	104	2.136	2655	200	0.531	424
9.0	4.501	32176	105	2.107	2597	201	0.526	419
10.0	4.487	31202	106	2.080	2542	202	0.520	415
11.0	4.472	30260	107	2.053	2488	203	0.515	410
12.0	4.457	29351	108	2.028	2436	204	0.510	405
13.0	4.442	28473	109	2.001	2385	205	0.505	401
14.0	4.427	27624	110	1.973	2335	206	0.499	396
15.0	4.413	26804	111	1.946	2286	207	0.494	391
16.0	4.397	26011	112	1.919	2239	208	0.488	386
17.0	4.381	25245	113	1.897	2192	209	0.483	382
18.0	4.366	24505	114	1.870	2147	210	0.477	377
19.0	4.348	23789	115	1.846	2103	211	0.471	372
20.0	4.330	23096	116	1.822	2060	212	0.465	367
21.0	4.313	22427	117	1.792	2018	213	0.459	361
22.0	4.295	21779	118	1.771	1977	214	0.453	356
23.0	4.278	21153	119	1.748	1937	215	0.446	350
24.0	4.258	20547	120	1.724	1898	216	0.439	344
25.0	4.241	19960	121	1.702	1860	217	0.432	338
26.0	4.223	19393	122	1.676	1822	218	0.425	332
27.0	4.202	18843	123	1.653	1786	219	0.417	325
28.0	4.184	18311	124	1.630	1750	220	0.409	318
29.0	4.165	17796	125	1.607	1715	221	0.401	311
30.0	4.145	17297	126	1.585	1680	222	0.393	304
31.0	4.125	16814	127	1.562	1647	223	0.384	297
32.0	4.103	16346	128	1.538	1614	224	0.375	289
33.0	4.082	15892	129	1.517	1582	225	0.366	282
34.0	4.059	15453	130	1.496	1550			
35.0	4.037	15027	131	1.474	1519			
36.0	4.017	14614	132	1.453	1489			
37.0	3.994	14214	133	1.431	1459			
38.0	3.968	13826	134	1.408	1430			
39.0	3.948	13449	135	1.389	1401			
40.0	3.927	13084	136	1.369	1373			
41.0	3.902	12730	137	1.348	1345			
42.0	3.878	12387	138	1.327	1318			
43.0	3.854	12053	139	1.308	1291			
44.0	3.828	11730	140	1.291	1265			
45.0	3.805	11416	141	1.289	1240			
46.0	3.781	11112	142	1.269	1214			
47.0	3.757	10816	143	1.250	1190			
48.0	3.729	10529	144	1.230	1165			
49.0	3.705	10250	145	1.211	1141			
50.0	3.679	9979	146	1.192	1118			
51.0	3.653	9717	147	1.173	1095			
52.0	3.627	9461	148	1.155	1072			
53.0	3.600	9213	149	1.136	1050			
54.0	3.575	8973	150	1.118	1029			
55.0	3.547	8739	151	1.100	1007			
56.0	3.520	8511	152	1.082	986			
57.0	3.493	8291	153	1.064	965			
58.0	3.464	8076	154	1.047	945			
59.0	3.437	7868	155	1.029	925			
60.0	3.409	7665	156	1.012	906			
61.0	3.382	7468	157	0.995	887			
62.0	3.353	7277	158	0.978	868			
63.0	3.323	7091	159	0.962	850			
64.0	3.295	6911	160	0.945	832			
65.0	3.267	6735	161	0.929	815			
66.0	3.238	6564	162	0.914	798			
67.0	3.210	6399	163	0.898	782			
68.0	3.181	6238	164	0.883	765			
69.0	3.152	6081	165	0.868	750			
70.0	3.123	5929	166	0.853	734			

Table 18 — Thermistor Temperature (°C) vs Resistance/Voltage Drop; Flotronic™ II

TEMPERATURE (C)	VOLTAGE DROP (V)	RESISTANCE (Ohms)	TEMPERATURE (C)	VOLTAGE DROP (V)	RESISTANCE (Ohms)
-40	4.896	168 230	44	1.944	2 272
-39	4.889	157 440	45	1.898	2 184
-38	4.882	147 410	46	1.852	2 101
-37	4.874	138 090	47	1.807	2 021
-36	4.866	129 410	48	1.763	1 944
-35	4.857	121 330	49	1.719	1 871
-34	4.848	113 810	50	1.677	1 801
-33	4.838	106 880	51	1.635	1 734
-32	4.828	100 260	52	1.594	1 670
-31	4.817	94 165	53	1.553	1 609
-30	4.806	88 480	54	1.513	1 550
-29	4.794	83 170	55	1.474	1 493
-28	4.782	78 125	56	1.436	1 439
-27	4.769	73 580	57	1.399	1 387
-26	4.755	69 250	58	1.363	1 337
-25	4.740	65 205	59	1.327	1 290
-24	4.725	61 420	60	1.291	1 244
-23	4.710	57 875	61	1.258	1 200
-22	4.693	54 555	62	1.225	1 158
-21	4.676	51 450	63	1.192	1 118
-20	4.657	48 536	64	1.160	1 079
-19	4.639	45 807	65	1.129	1 041
-18	4.619	43 247	66	1.099	1 006
-17	4.598	40 845	67	1.069	971
-16	4.577	38 592	68	1.040	938
-15	4.554	38 476	69	1.012	906
-14	4.531	34 489	70	0.984	876
-13	4.507	32 621	71	0.949	836
-12	4.482	30 866	72	0.920	805
-11	4.456	29 216	73	0.892	775
-10	4.428	27 633	74	0.865	747
-9	4.400	26 202	75	0.838	719
-8	4.371	24 827	76	0.813	693
-7	4.341	23 532	77	0.789	669
-6	4.310	22 313	78	0.765	645
-5	4.278	21 163	79	0.743	623
-4	4.245	20 079	80	0.722	602
-3	4.211	19 058	81	0.702	583
-2	4.176	18 094	82	0.683	564
-1	4.140	17 184	83	0.665	547
0	4.103	16 325	84	0.648	531
1	4.065	15 515	85	0.632	516
2	4.026	14 749	86	0.617	502
3	3.986	14 026	87	0.603	489
4	3.945	13 342	88	0.590	477
5	3.903	12 696	89	0.577	466
6	3.860	12 085	90	0.566	456
7	3.816	11 506	91	0.555	446
8	3.771	10 959	92	0.545	436
9	3.726	10 441	93	0.535	427
10	3.680	9 949	94	0.525	419
11	3.633	9 485	95	0.515	410
12	3.585	9 044	96	0.506	402
13	3.537	8 627	97	0.496	393
14	3.487	8 231	98	0.486	385
15	3.438	7 855	99	0.476	376
16	3.387	7 499	100	0.466	367
17	3.337	7 161	101	0.454	357
18	3.285	6 840	102	0.442	346
19	3.234	6 536	103	0.429	335
20	3.181	6 246	104	0.416	324
21	3.129	5 971	105	0.401	312
22	3.076	5 710	106	0.386	299
23	3.023	5 461	107	0.370	285
24	2.970	5 225			
25	2.917	5 000			
26	2.864	4 786			
27	2.810	4 583			
28	2.757	4 389			
29	2.704	4 204			
30	2.651	4 028			
31	2.598	3 861			
32	2.545	3 701			
33	2.493	3 549			
34	2.441	3 404			
35	2.389	3 266			
36	2.337	3 134			
37	2.286	3 008			
38	2.236	2 888			
39	2.186	2 773			
40	2.137	2 663			
41	2.087	2 559			
42	2.039	2 459			
43	1.991	2 363			

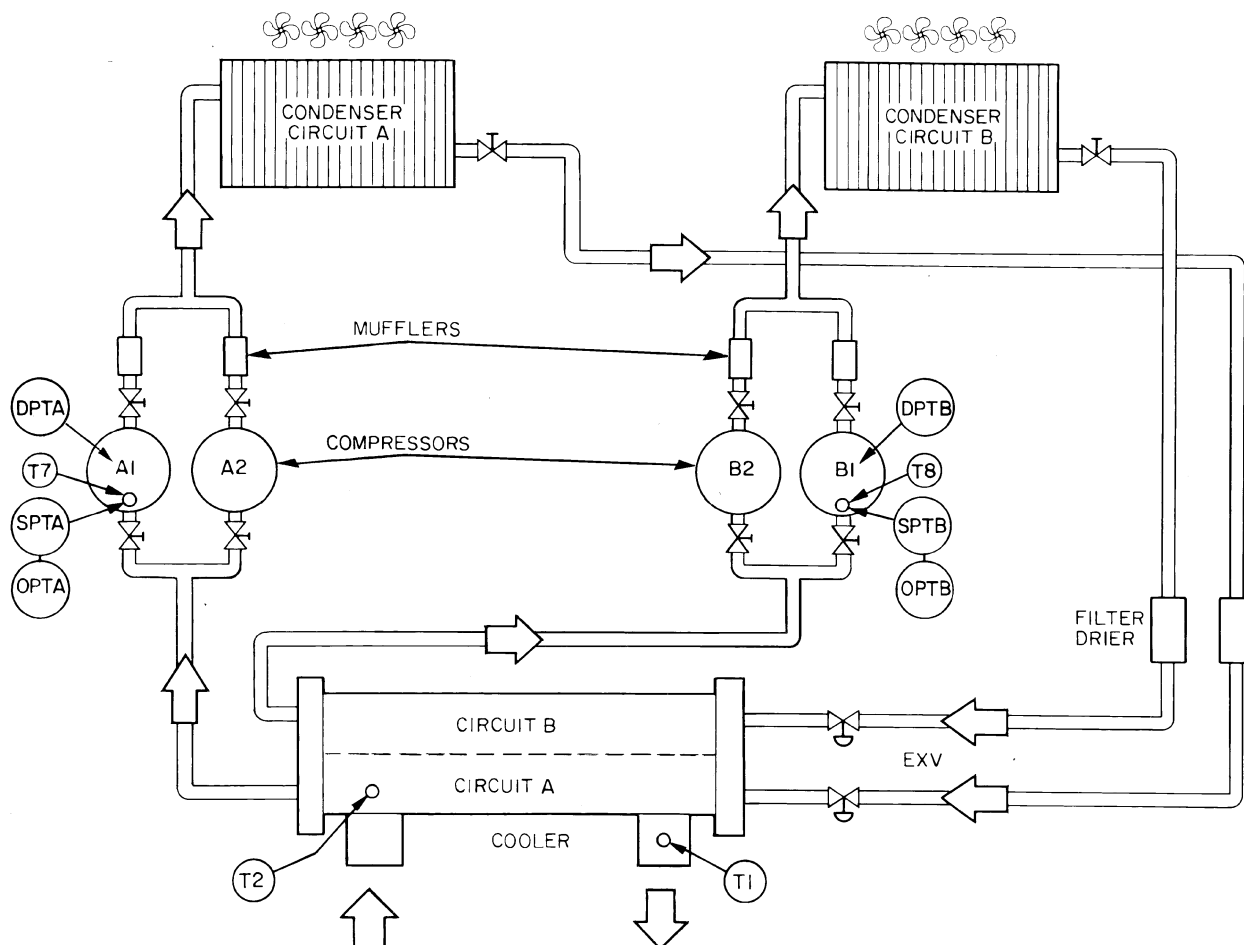

LEGEND

DPT	— Discharge Pressure Transducer
EXV	— Electronic Expansion Valve
OPT	— Oil Pressure Transducer
SPT	— Suction Pressure Transducer
T	— Thermistor Number

Fig. 14 — Thermistor and Pressure Transducer Locations

Pressure Transducers — A single style of pressure transducer is used for both high- and low-pressure sensing on Flotronic™ II chillers. However, this transducer must be calibrated before the unit will operate. On new units, this will have been done at the factory in order to test run the unit. If a transducer or PSIO is replaced in the field, however, the transducer will have to be field calibrated as follows:

1. Disconnect transducer from the system.
2. Hang the transducer in the atmosphere.
3. Press **3** **TEST** on the HSIO keypad, and Read the pressure. Pressures before calibration must be within the range of ± 5 psig. If the pressure is outside the range of ± 5 psig, the HSIO display will read ---. If this is the case, replace the transducer or PSIO or check for a wiring error. If the value of the atmospheric pressure is greater than 5 psig or less than -5 psig, the transducer will be considered out of range and will not calibrate.

4. Press **ENTR** on the HSIO keypad. This automatically applies the proper correction factor to all future inputs from the transducer.

Three pressure transducers are mounted on each lead compressor: 2 low-pressure transducers to monitor compressor suction pressure and oil pressure, and a high-pressure transducer to monitor compressor discharge pressure (see Fig. 17 for exact locations on compressor). Each transducer is supplied with 5 vdc power from a rectifier which changes 24 vac to 5 vdc.

TROUBLESHOOTING — If transducer is suspected of being faulty, first check supply voltage to transducer. Supply voltage should be 5 vdc $\pm .2$ v. If supply voltage is correct, compare pressure reading displayed on keypad and display module against pressure shown on a calibrated pressure gage. If the 2 pressure readings are not reasonably close, replace pressure transducer.

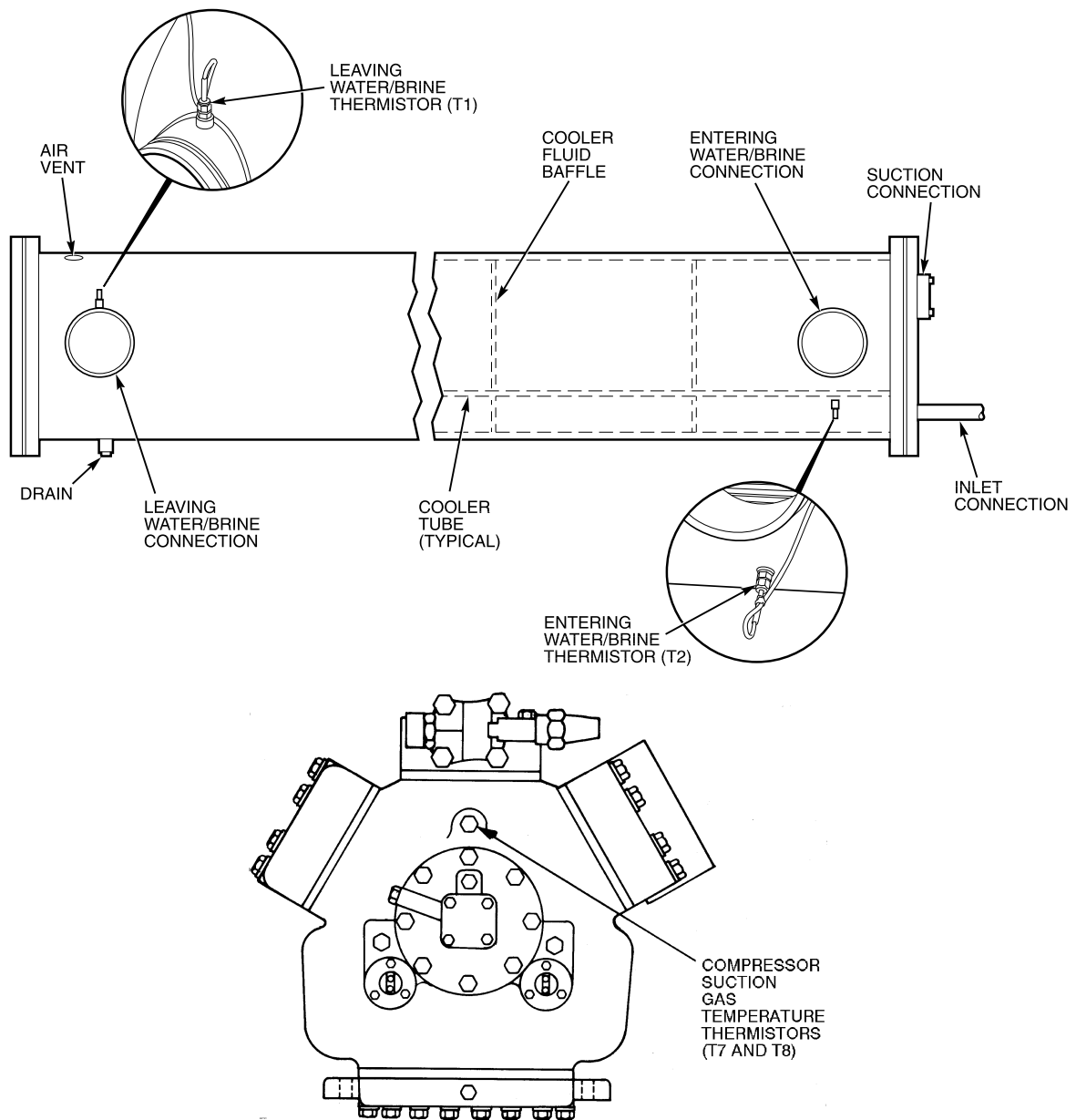

**Fig. 15 — Thermistor Locations
(Circuits A and B, Lead Compressor Only)**

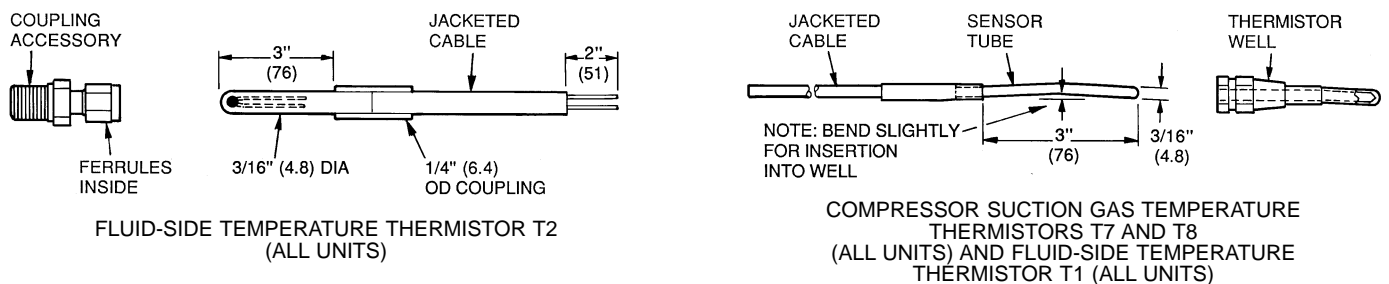

Fig. 16 — Thermistors

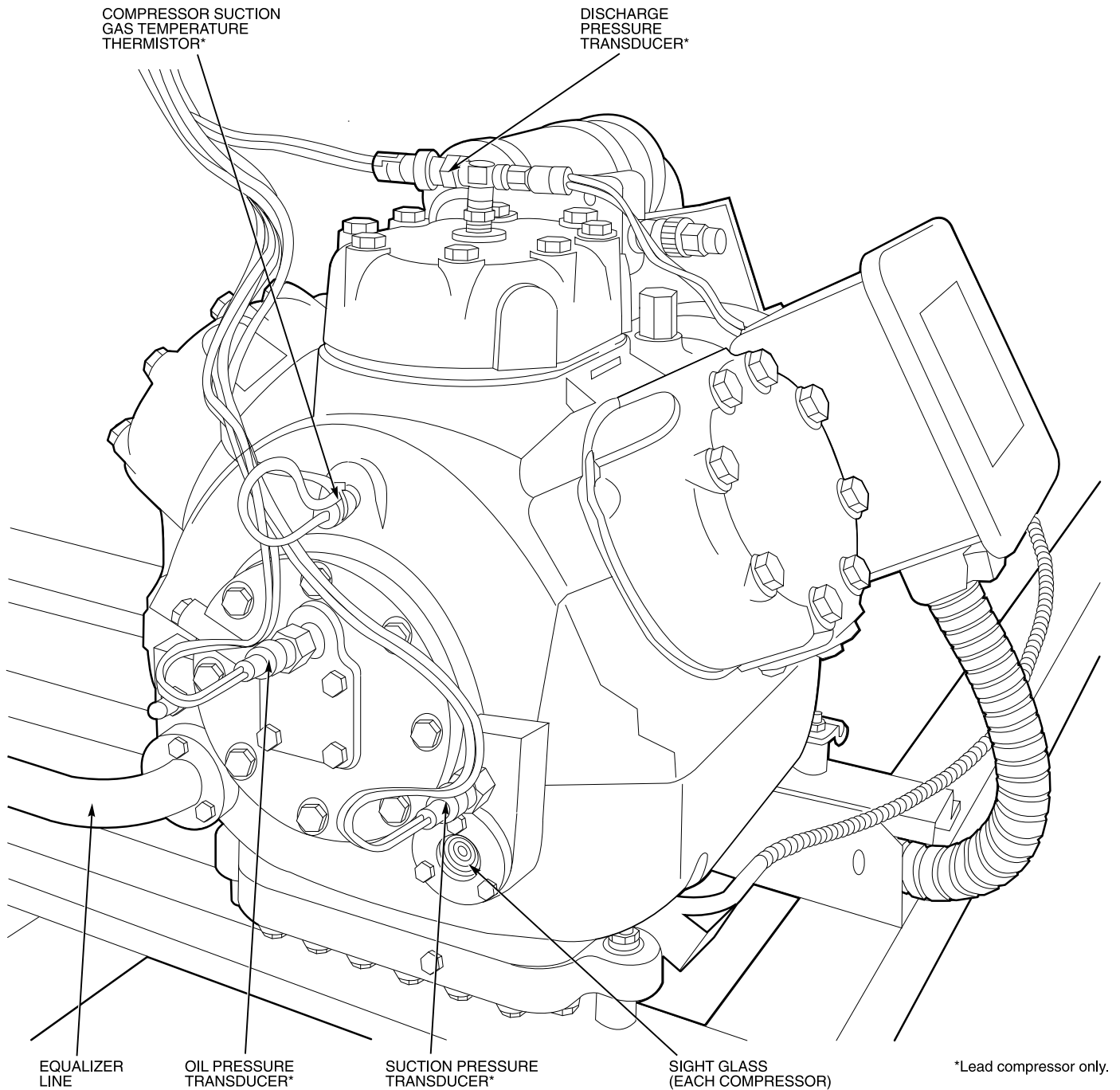

Fig. 17 — Lead Compressor Transducer and Thermistor Locations

TRANSDUCER REPLACEMENT

⚠ CAUTION

Transducers are installed directly in the refrigerant circuit. Relieve all refrigerant pressure using standard refrigeration practices before removing.

1. Relieve refrigerant pressure using standard refrigeration practices.
2. Disconnect transducer wiring at transducer by pulling up on locking tab while pulling weathertight connection plug from end of transducer. **Do not pull on transducer wires.**

3. Unscrew transducer from 1/4-in. male flare fitting. When installing new pressure transducer, do not use thread sealer. Thread sealer can plug transducer and render it inoperative.
4. Insert weathertight wiring plug into end of transducer until locking tab snaps in place.
5. Check for refrigerant leaks.

Control Modules

⚠ CAUTION

Turn controller power off before servicing controls. This ensures safety and prevents damage to controller.

PROCESSOR MODULE (PSIO), 4 IN/4 OUT MODULE (SIO), LOW-VOLTAGE RELAY MODULE (DSIO-LV), AND EXV DRIVER MODULE (DSIO-EXV) — The PSIO, DSIO and SIO modules all perform continuous diagnostic evaluations of the condition of the hardware. Proper operation of these modules is indicated by LEDs (light-emitting diodes) on the front surface of the DSIOs, and on the top horizontal surface of the PSIO and SIO.

RED LED — Blinking continuously at a 3- to 5-second rate indicates proper operation. Lighted continuously indicates a problem requiring replacement of module. Off continuously indicates power should be checked. If there is no input power, check fuses. If fuse is bad, check for shorted secondary of transformer or for bad module. On the PSIO module, if the light is blinking at a rate of twice per second, the module should be replaced.

GREEN LED — On a PSIO and an SIO, this is the green LED closest to COMM connectors. The other green LED on module indicates external communications, when used. Green LED should always be blinking when power is on. It indicates modules are communicating properly. If green LED is not blinking, check red LED. If red LED is normal, check module address switches. See Fig. 18. Proper addresses are:

PSIO (Processor Module) — 01 (different when CCN connected)

DSIO (Relay Module) — 19

DSIO (EXV Driver Module) — 31

SIO (4 In/4 Out Module) — 59

If *all* modules indicate communication failure, check COMM plug on PSIO module for proper seating. If a good connection is assured and condition persists, replace PSIO module.

If only DSIO or SIO module indicates communication failure, check COMM plug on that mode for proper seating. If a good connection is assured and condition persists, replace DSIO or SIO module.

All system operating intelligence rests in PSIO module, the module that controls unit. This module monitors conditions through input and output ports and through DSIO modules (low-voltage relay module and EXV driver module).

The machine operator communicates with microprocessor through keypad and display module. Communication between PSIO and other modules is accomplished by a 3-wire sensor bus. These 3 wires run in parallel from module to module.

On sensor bus terminal strips, terminal 1 of PSIO module is connected to terminal 1 of each of the other modules. Terminals 2 and 3 are connected in the same manner. See Fig. 19. If a terminal 2 wire is connected to terminal 1, system does not work.

In Flotronic™ II chillers, processor module, low-voltage relay module, and keypad and display module are all powered from a common 21-vac power source which connects to terminals 1 and 2 of power input strip on each module. A separate source of 21-vac power is used to power options module through terminals 1 and 2 on power input strip. A separate source of 12.5 vac power is used to power EXV driver module through terminals 1 and 2 on power input strip.

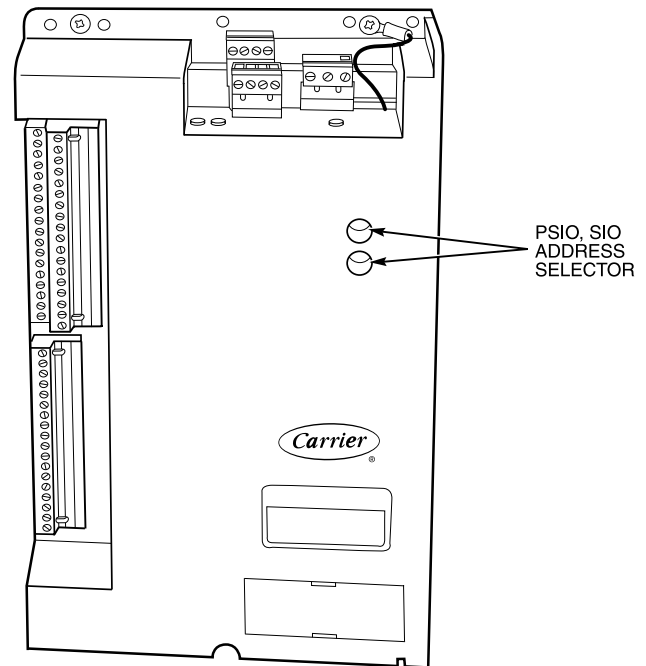
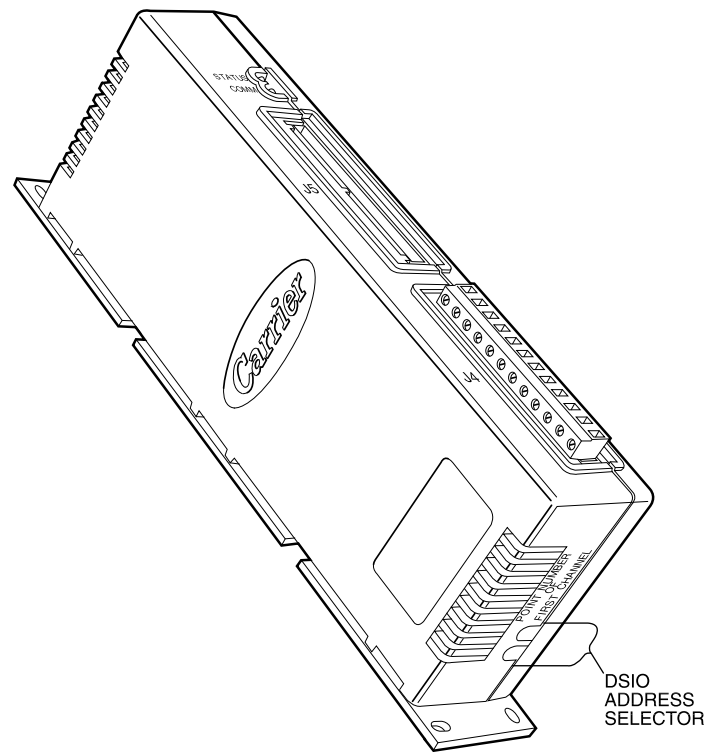

Fig. 18 — Module Address Selector Switch Locations

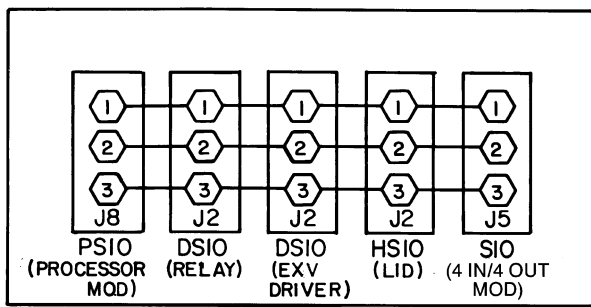

Fig. 19 — Sensor Bus Wiring (Communications)

PROCESSOR MODULE (PSIO) (Fig. 20)

Inputs — Each input channel has 3 terminals; only 2 of the terminals are used. Application of machine determines which terminals are used. Always refer to individual unit wiring for terminal numbers.

Outputs — Output is 24 vdc. There are 3 terminals, only 2 of which are used, depending on application. Refer to unit wiring diagram.

NOTE: Address switches (see Fig. 20) must be set at 01 (different when CCN connected).

LOW VOLTAGE RELAY MODULE (DSIO-LV) (Fig. 21)

Inputs — Inputs on strip J3 are discrete inputs (ON/OFF). When 24-vac power is applied across the 2 terminals in a channel it reads as on signal. Zero v reads as an off signal.

Outputs — Terminal strips J4 and J5 are internal relays whose coils are powered-up and powered-off by a signal from microprocessor. The relays switch the circuit to which they are connected. No power is supplied to these connections by DSIO module.

4 IN/4 OUT MODULE (SIO) (Fig. 22) — 4 In/4 Out module allows the following features to be utilized:

1. **Temperature Reset** by outdoor air or space temperature. A remote thermistor (Part No. 30GB660002) is also required.
NOTE: This accessory is *not* required for return water temperature reset.
2. **Temperature Reset** by remote 4 to 20 mA signal.
3. **Demand Limit** by remote 2-stage switch.
4. **Demand Limit** by remote 4 to 20 mA signal
5. **Dual Set Point** by remote switch.

The options module is standard. Remember to reconfigure the chiller for each feature selected (see Table 14). For temperature reset, demand limit, and dual set point, desired set points must be entered through keypad and display module (see Set Point Function section on page 38).

See Table 19 for overall troubleshooting information.

ACCESSORY UNLOADER INSTALLATION

Some of the 30G Flotronic™ II units come standard with unloader(s), and many permit additional unloader(s) to be added if desired. See Table 20.

IMPORTANT: The following combinations ARE NOT permitted (combinations are per circuit):

1. Two unloaders and hot gas bypass
2. Four compressors and 2 unloaders.
3. Four compressors, 1 unloader, and hot gas bypass.

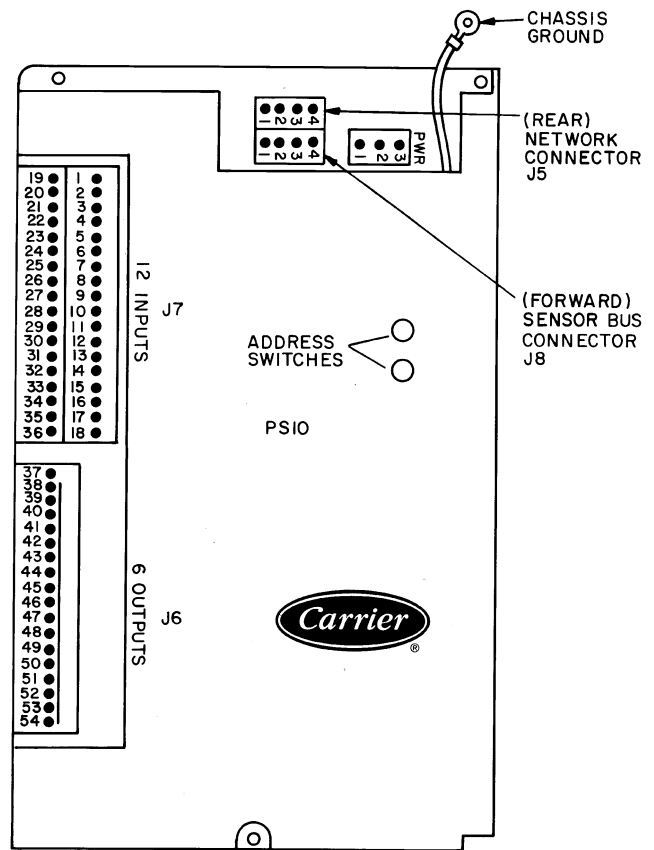

Fig. 20 — Processor Module (PSIO)

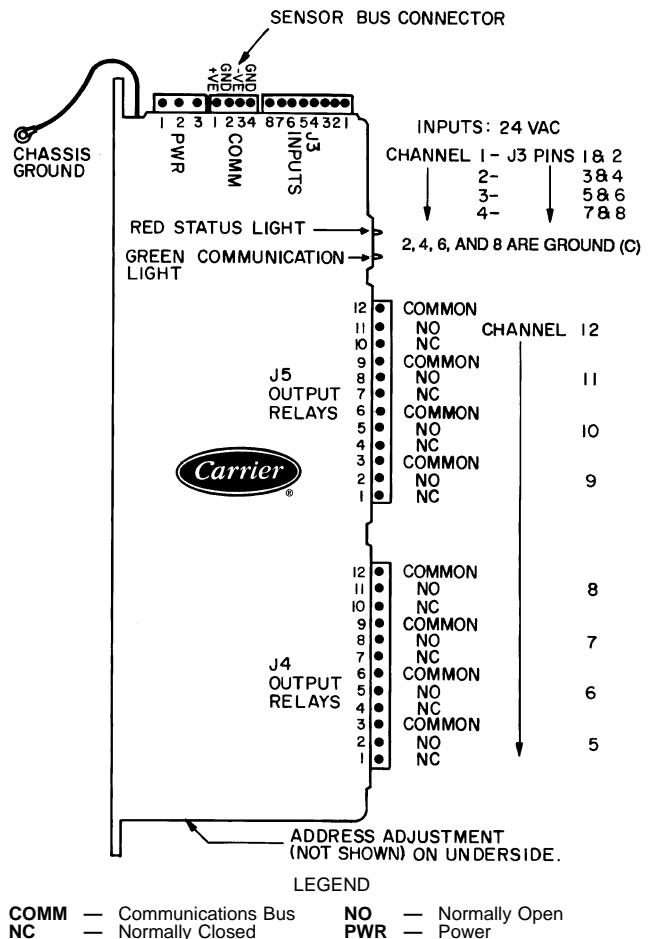
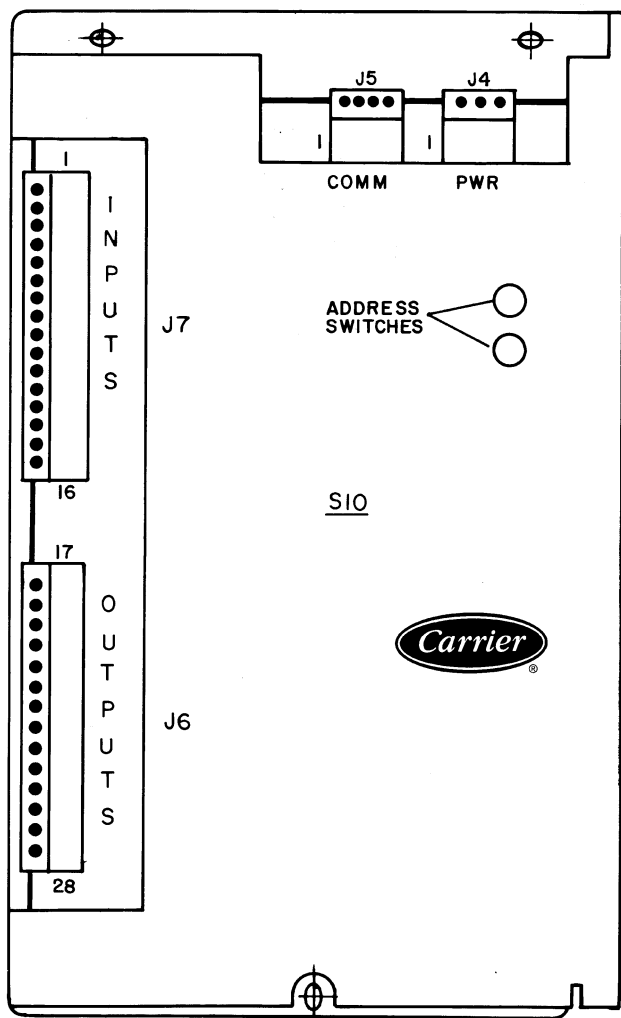

Fig. 21 — Low-Voltage Relay Module (DSIO)



LEGEND

COMM — Communications Bus
PWR — Power

Fig. 22 — 4 In/4 Out Module (SIO)

If accessory unloaders are desired, an accessory unloader package is used. Package includes a suction cutoff unloader head package. The 24-v coil in the package can be used for 040-110, 130 (60 Hz), and associated modular units (Table 1). A 115 v or 230 v coil must be used for 130 (50 Hz), 150-210, and associated modular units (Table 1). Coil voltage depends on control circuit voltage. Consult current Carrier price pages for appropriate part numbers.

NOTE: The accessory package will include all necessary components and wiring with the following exceptions: The field must provide screws, and on the 130-210, and associated modular units, the field must also supply a 20 vdc (part number HK35AB001) unloader relay and wire (90° C or equivalent).

Installation

1. Be sure all electrical disconnects are open and tagged before any work begins. Inspect the package contents for any damage during shipping. File a claim with the shipper if damage has occurred.
2. For ease of installation, factory-supplied wiring for the additional unloader is provided in the compressor harness.

3. Install the additional unloader cylinder head on the lead compressor, A1 or B1, according to instructions provided by the compressor manufacturer in the accessory package.
4. Continue installation per either 040-110, 130 (60 Hz) units or 130 (50 Hz), 150-210 units section as appropriate.

040-110, 130 (60 Hz) UNITS (And Associated Modular Units)

1. Wire the solenoid before any field wiring begins. Wiring between components and control box must be enclosed in conduit. All local electrical codes and National Electrical Code (NEC) must be followed. Factory wires are provided in the compressor harness to connect the solenoid. These wires are in the compressor control box.
2. Wire the control side. Open the left side control box door and remove inner panel. Using the holes provided and field-supplied screws, install field-supplied transformer above the DSIO-LV on the control panel.

Wire the primary side of the transformer in parallel with TRAN4. See Fig. 23. This supplies transformer with proper line voltage. Be sure to connect proper tap of the transformer to ensure supply of proper secondary voltage.

Wire the secondary side of transformer to DSIO-LV - J5-9, and a jumper from DSIO-LV - J5-9 to DSIO-LV - J4-9. Wire the secondary common to TB7-2. Connect the transformer ground to ground hole supplied near the transformer. These connections provide DSIO with necessary power to energize the solenoid coils.

3. When all connections are made, check for proper wiring and tight connections. Replace and secure inner panel. Restore power to unit.
4. Configure the processor. With the addition of extra unloaders, the unit configuration has changed. To change the configuration of the processor, enter the service function using the keypad and display module. Before any changes can be made, the LOCAL/ENABLE-STOP-CCN switch must be in the STOP position, and the servicer must log on to the processor.

- a. Press . Keypad LCD displays the word PASSWORD.
- b. Enter . Keypad LCD displays LOGGEDON.
- c. To change configuration, press . Keypad LCD displays FLD CFG.
- d. If an additional unloader was added to compressor A1, press until NULA 1 appears in keypad display. Press for the number of unloaders on circuit A. Keypad display now reads NULA 2.
- e. If an additional unloader was added to compressor B1, press until NULB 1 appears in keypad display. Press for the number of unloaders on circuit B. Keypad display now reads NULB 2.
- f. When configuration is complete, press . Keypad display reads LOGGEDON. Press until keypad display reads LOG OFF. Press . Keypad display reads EXIT LOG.

Table 19 — Troubleshooting

SYMPTOMS	CAUSE	REMEDY
COMPRESSOR DOES NOT RUN	Power line open Control fuse open High-Pressure Switch (HPS) tripped Tripped power breaker Loose terminal connection Improperly wired controls Low line voltage Compressor motor defective Seized compressor	Reset circuit breaker. Check control circuit for ground or short. Replace fuse. Move LOCAL/ENABLE-STOP-CCN switch to STOP position then back to RUN or CCN position. Check the controls. Find cause of trip and reset breaker. Check connections. Check wiring and rewire. Check line voltage. Determine location of voltage drop and remedy deficiency. Check motor winding for open or short. Replace compressor if necessary. Replace compressor.
COMPRESSOR CYCLES OFF ON LOW PRESSURE	Loss of charge Bad transducer Low refrigerant charge	Repair leak and recharge. Replace transducer. Add refrigerant.
COMPRESSOR SHUTS DOWN ON HIGH PRESSURE CONTROL	High-pressure control erratic in action Compressor discharge valve partially closed Condenser fan(s) not operating Condenser coil plugged or dirty	Replace control. Open valve or replace if defective. Check wiring. Repair or replace motor(s) if defective. Clean coil.
UNIT OPERATES LONG OR CONTINUOUSLY	Low refrigerant charge Control contacts fused Partially plugged or plugged expansion valve or filter driver Defective insulation Service load Inefficient compressor	Add refrigerant. Replace control. Clean or replace. Replace or repair. Keep doors and windows closed. Check valves. Replace if necessary.
SYSTEM NOISES	Piping vibration Expansion valve hissing Compressor noisy	Support piping as required. Add refrigerant. Check for plugged liquid line filter drier. Check valve plates for valve noise. Replace compressor (worn bearings). Check for loose compressor holddown bolts.
COMPRESSOR LOSES OIL	Leak in system Mechanical damage (blown piston or broken discharge valve) Crankcase heaters not energized during shutdown	Repair leak. Repair damage or replace compressor. Replace heaters, check wiring and crankcase heater relay contacts.
FROSTED SUCTION LINE	Expansion valve admitting either too much or too little refrigerant	Check cooler and compressor thermistors. Test EXV.
HOT LIQUID LINE	Shortage of refrigerant due to leak	Repair leak and recharge.
FROSTED LIQUID LINE	Shutoff valve partially closed or restricted	Open valve or remove restriction.
COMPRESSOR DOES NOT UNLOAD	Burned out coil Defective capacity control valve Miswired solenoid Weak, broken, or wrong valve body spring	Replace coil. Replace valve. Rewire correctly. Replace spring
COMPRESSOR DOES NOT LOAD	Miswired solenoid Defective capacity control valve Plugged strainer (high side) Stuck or damaged unloader piston or piston ring(s)	Rewire correctly. Replace valve. Clean or replace strainer. Clean or replace the necessary parts.

EXV — Electronic Expansion Valve

Table 20 — Standard and Accessory Unloaders

UNIT	NO. OF STANDARD UNLOADER(S)	NO. OF ACCESSORY UNLOADERS PERMITTED	
		Circuit A	Circuit B
30GN040-070	1	1	1 or 2
30GN080-170*	2	1	1
30GN190-210*	0	1	1

*And associated modular units.

5. Using test function, check unloaders. Press **2** **TEST**. Keypad display reads OUTPUTS. Press **↓** until display reads UNA2 OFF. Press **ENTR**. Relay energizes. Press **↓** and relay deenergizes. Press **↓** until display reads UNB2 OFF. Press **ENTR**. Relay energizes. Press **↓** and relay deenergizes.
 6. When unloader check has been performed, return LOCAL/ENABLE-STOP-CCN to proper position. Close and secure control box door.
- 130 (50 Hz), 150-210 UNITS (And Associated Modular Units)
1. Install control wiring. The minimum wire size for installation is 16 AWG (American Wire Gage). Refer to Fig. 23 and 24 for proper wiring. Open the control box door. Locate unloader relays A and B (UA, UB) in place of the hot gas bypass relays as shown on the component arrangement diagram on the unit. Mount the relays with the field-supplied screws. Be careful not to damage the components and wiring in the area when mounting the relays.
 2. Wire the control side. Wire the UA coil in series between J6-18 and J6-19 of the 4 IN/4 OUT module with the wires provided. Wire the UB coil in series between J6-21 and J6-22 of the same module with the wires provided.
Locate the black wire in the control harness originating from TRANS5 labeled HGBPR-A-COM. Connect this wire to the UA terminal COM. Connect the wire labeled HGBPR-A-NO to UA-NO. Connect the wire from UA-NO to TB3-5. For an extra unloader on circuit B, connect the wire labeled HGBPR-B-COM to UR-B-COM, and the wire labeled HGBPR-B-NO to UB-NO. Connect the wire from UB-NO to TB3-6.
 3. Wire in the solenoid valves.
NOTE: Wires external to the control box must be run in conduit.
Terminal blocks are provided for easy field wiring. Use one of the isolated 7/8-in. (22-mm) holes in the side of the compressor electrical box with a strain relief to run the wires to the solenoid coil. Connect UA between TB3-5 and TB3-8. Connect UB between TB3-6 and TB3-8. Check all of the electrical connections for proper location and tightness, and replace and secure the electrical box of the compressor.
 4. Configure the microprocessor. Once the relays are mounted in the control box, the microprocessor must be configured for the unloader option. To do so:
 - a. Be sure the LOCAL/ENABLE-STOP-CCN switch is in the STOP position.
- b. Log into the processor and enter the service function using the keypad and display module. Press **1** **SRVC**. The keypad LCD will display "PASSWORD." Enter **1** **1** **1** **1** **ENTR**, and the keypad LCD will display "LOGGEDON."
 - c. To change the configuration, press **4** **SRVC**, and the keypad LCD will display "FLD CFG." Press **↓** until either "NULA 0" or "NULA 1" is displayed (depending on the number of unloaders provided as standard). Then press **1** **ENTR** (for 1 unloader on A1) or **2** **ENTR** (for 2 unloaders on compressor A1). The display will now read either "NULA 1" or "NULA 2," as appropriate. Press **↓** to get to the NULB display, and change this setting in the same manner as with circuit A.
 - d. Once the configuration is complete, press **1** **SRVC**, and the keypad LCD will display "LOGGEDON," Press **↓** until the keypad LCD display reads "LOG OFF." Press **ENTR** and the keypad LCD will display "EXIT LOG."
5. Once the unloader heads are installed, the unit is checked for leaks, and the system is prepared for operation per the instructions for the compressor unloader head installation, check the output of the relays using the test function as follows:
 - a. Press **2** **TEST**, and the display will read "COMP."
 - b. Press the **↓** to scroll down until the display reads "CPA1 OFF."
 - c. Press **ENTR**, and the compressor should start.
 - d. Press **↓**, and the compressor should stop.
 - e. Press **↓** until the display reads "UNA1 OFF."
 - f. Press **ENTR**, and the solenoid should energize.
 - g. Press **↓** and the solenoid should deenergize.
 - h. Use the **↓** and **ENTR** keys to check the remainder of the unloader coils.
 6. Once the check has been performed, return the LOCAL/ENABLE-STOP-CCN switch to the proper position.
 7. Close and secure the control box door.
 8. Start the unit and confirm that the chiller operates properly.

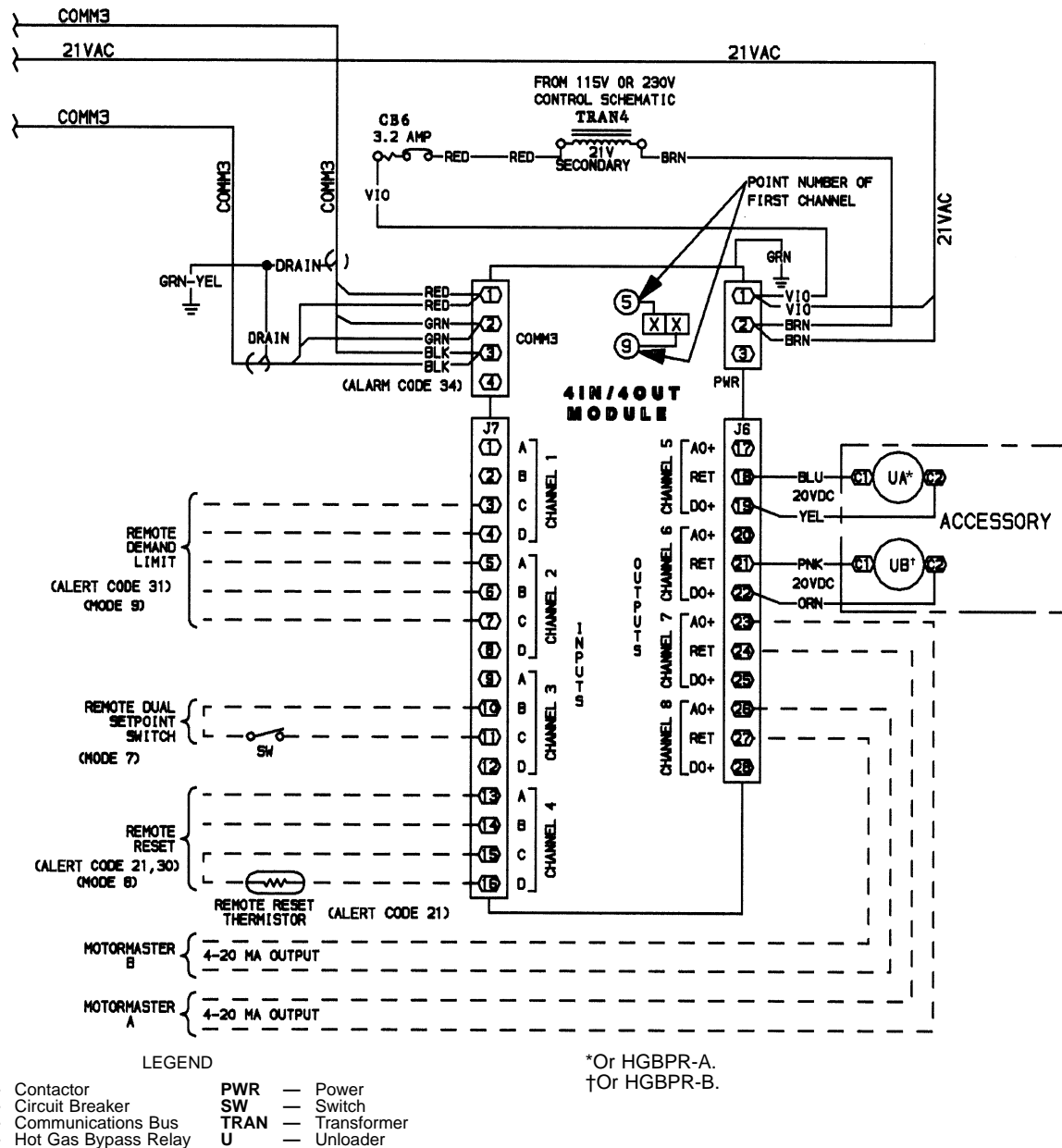

Fig. 23 — Accessory Unloader Control Wiring, All Units

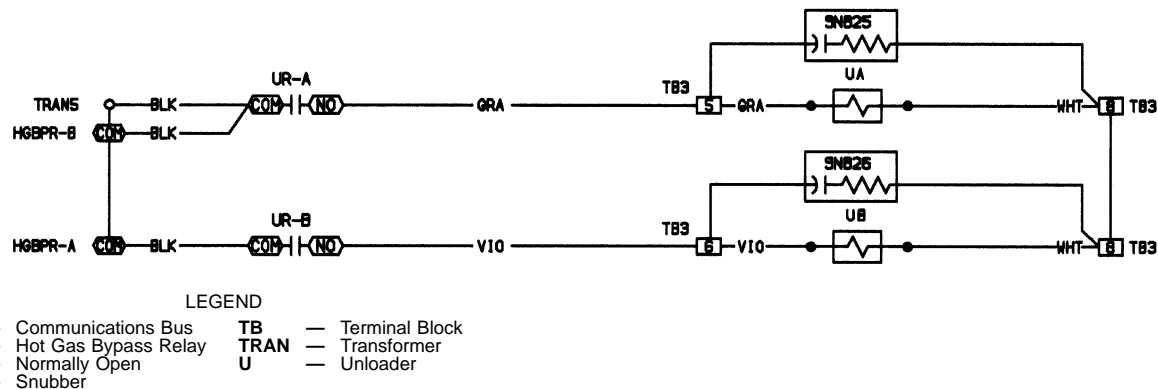
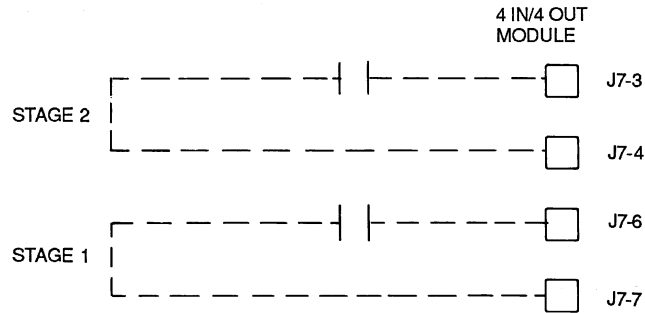

Fig. 24 — Flotronic™ II 115/230-V (Unloader Wiring, 130 (50 Hz), 150-210 and Associated Modular Units (See Table 1)

FIELD WIRING

Refer to Fig. 25-35 for field wiring.



NOTE: Contacts must be rated for dry circuit application, capable of reliably switching a 5 vdc, 1 mA to 20 mA load.

Fig. 25 — Demand Limit — Two External Switch Inputs

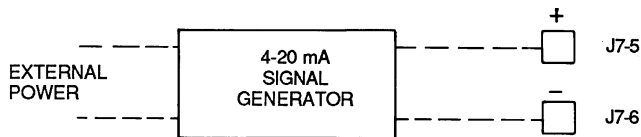

Fig. 26 — Demand Limit — 4-20 mA Signal (Externally Powered)

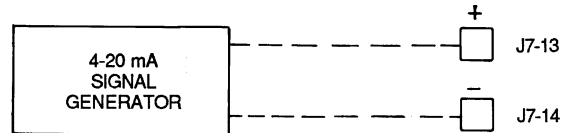

Fig. 30 — Remote Reset from 4-20 mA Signal (Internally Powered)

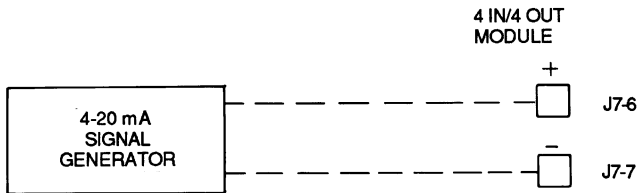
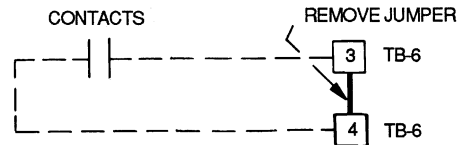

Fig. 27 — Demand Limit — 4-20 mA Signal (Internally Powered)



TB — Terminal Block

NOTE: Contacts must be rated for dry circuit application, capable of reliably switching a 5 vdc, 1 mA to 20 mA load.

Fig. 31 — Remote On/Off

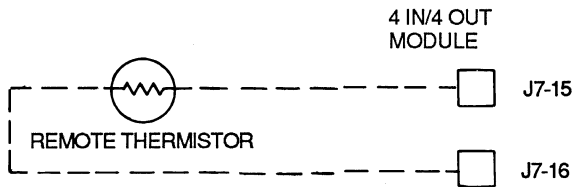

Fig. 28 — Remote Reset from Space or Outdoor-Air Temperature

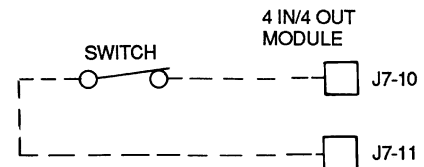

Fig. 32 — Remote Dual Set Point Control

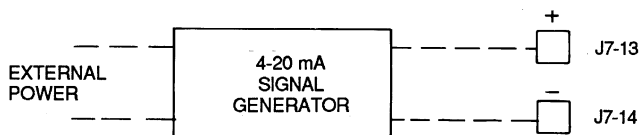
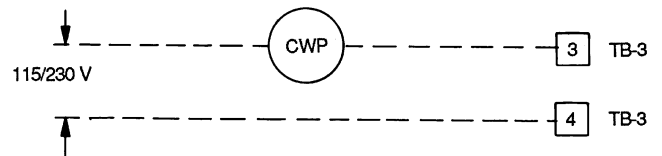
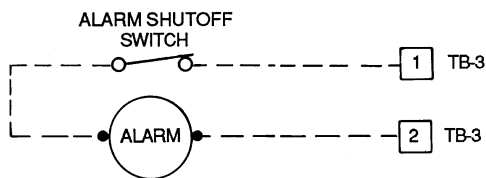

Fig. 29 — Remote Reset from 4-20 mA Signal (Externally Powered)



CWP — Chilled Water (Fluid) Pump
TB — Terminal Block

Fig. 33 — Chilled Fluid Pump



TB — Terminal Block

Fig. 34 — Remote Alarm

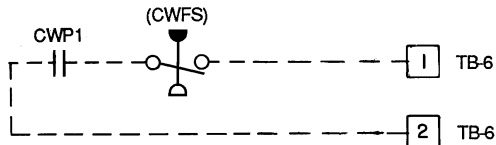

CWP1 — Chilled Water (Fluid) Pump Interlock
 CWFS — Chilled Water (Fluid) Flow Switch (not required — low flow protection is provided by Flotronic™ II controls)
 TB — Terminal Block

Fig. 35 — Interlocks

REPLACING DEFECTIVE PROCESSOR MODULE

The replacement part number is printed on a small label on the front of the PSIO module. The model and serial numbers are printed on the unit nameplate located on an exterior corner post. The proper software and unit configuration data is factory installed by Carrier in the replacement module. Therefore, when ordering a replacement processor module (PSIO), specify complete replacement part number, full unit model number, and serial number. If these numbers are not provided, the replacement module order is configured instead as a generic Flotronic II replacement module. This requires reconfiguration of the module by the installer.

⚠ CAUTION

Electrical shock can cause personal injury. Disconnect all electrical power before servicing.

Installation

1. Verify the existing PSIO module is defective by using the procedure described in the Control Modules section on page 63.
2. Refer to Start-Up Checklist for Flotronic II Chiller Systems (completed at time of original start-up) found in job folder. This information is needed later in this procedure. If checklist does not exist, fill out the **3** **SRVC** and **5** **SRVC** configuration code sections on a new checklist. Tailor the various options and configurations as needed for this particular installation.
3. Check that all power to unit is off. Carefully disconnect all wires from defective module by unplugging the 6 connectors. It is not necessary to remove any of the individual wires from the connectors. Remove the green ground wire.

4. Remove defective PSIO by removing its mounting screws with a Phillips screwdriver, and removing the module from the control box. Save the screws for later use.
5. Use a small screwdriver to set address switches S1 and S2 on the new PSIO module to exactly match the settings on the defective module.
6. Package the defective module in the carton of the new module for return to Carrier.
7. Mount the new module in the unit control box using a Phillips screwdriver and the screws saved in Step 4 above.
8. Reinstall all 6 wire connectors and the green ground wire.
9. Carefully check all wiring connections before restoring power.
10. Verify the LOCAL/ENABLE-STOP-CCN switch is in STOP position.
11. Restore control power. Verify the red and green lights on top of PSIO and front of each DSIO module respond as described in Control Modules section on page 63. The keypad and display module should also begin its rotating display.
12. Using the keypad and display module, press **2** **SRVC** to verify that the software version number matches the ER (engineering requirement) number shown on the PSIO label.
13. Press **3** **SRVC** to verify that the 7 factory configuration codes (CODE 1 through CODE 7) exactly match the codes listed for this unit model on the component arrangement label diagram on the control box door. If they are different or are all zeros, reenter the 7 codes. If any changes are required, the PSIO display becomes blank and reconfigures itself after pressing the **ENTR** key while displaying CODE 7. The display returns in approximately 15 seconds.
 NOTE: Codes with leading zeros in the configuration will be displayed starting with the first number greater than zero.
14. Press **4** **SRVC** to verify each item is configured as needed for this particular installation. Table 14 shows the factory configuration code default settings. Table 14 also shows the service replacement code default settings which are used if no model number was specified when ordering the replacement PSIO module. It is strongly suggested that the Start-Up Checklist for Flotronic II Chiller Systems (completed at time of original start-up) be used at this time to verify and/or reprogram the various options and configurations required for this job.
15. Press **5** **SRVC** to verify that the 2 field configuration codes (codes 8 and 9) match exactly the codes listed on the label diagram on the control box door. If they are different, or are all zeros, reenter the 2 codes.
16. After completing the configuration steps outlined above, restore main power and perform a unit test as described in **1** **TEST** and **2** **TEST** sections on page 38.
17. Complete this procedure and restore chiller to normal operation by returning the LOCAL/ENABLE-STOP-CCN switch to desired position.

Free Manuals Download Website

<http://myh66.com>

<http://usermanuals.us>

<http://www.somanuals.com>

<http://www.4manuals.cc>

<http://www.manual-lib.com>

<http://www.404manual.com>

<http://www.luxmanual.com>

<http://aubethermostatmanual.com>

Golf course search by state

<http://golfingnear.com>

Email search by domain

<http://emailbydomain.com>

Auto manuals search

<http://auto.somanuals.com>

TV manuals search

<http://tv.somanuals.com>