

# 19TH CENTURY™

OWNER'S MANUAL



**CASABLANCA®**  
FAN COMPANY

# CONTENTS

INTRODUCTION . . . . .	1
MOUNTING RECOMMENDATIONS . . . . .	2
PREPARATION INSTRUCTIONS . . . . .	3
FAN INSTALLATION . . . . .	5
CONTROL FEATURES:	
INTELI•TOUCH OPERATION . . . . .	12
TROUBLESHOOTING . . . . .	15

## READ AND SAVE THESE INSTRUCTIONS

## SAFETY FIRST

Safety and the proper operation of your Casablanca fan both require a thorough knowledge of the product and proper installation; therefore, before attempting to install and operate your Casablanca fan, read this owner's manual completely and carefully. Retain this manual for future reference.

**CAUTION:** To avoid possible electrical shock, make certain that electricity is turned off at the circuit breaker or fuse box before attempting any installation procedure.

## BEFORE YOU START

- All wiring must be in accordance with the National Electric Code ANSI/NFPA 70-1993 and the appropriate local electrical codes. The National Electric Code requires proper grounding as a precaution against electrical shock. A qualified electrician should be consulted if you are unsure.
- This fan is designed to be installed on an existing electrical outlet box. The outlet box must be UL Listed for ceiling fan installations, if it is not, a new box must be installed. Casablanca extension poles are available for sloped or high ceiling installations.
- This ceiling fan requires a grounded electrical supply of 120 VAC, 60 Hz and a minimum 15 amp circuit. The maximum current requirement for the fan with light fixture is 3.8 amps. The fan uses about 1 amp or 100 watts. Maximum light current is 2.8 amps or 340 watts of lighting.
- Where wire nuts are employed, be sure all bare wires are within the connectors. When installing the canopy hatch, make sure all wires are within the canopy and that no wires are being pinched.

For best performance and for your warranty to be valid, use only genuine Casablanca blades, light fixtures, and accessories.

## SAFE USE

- The blades in each pack are matched for equal weight to assure smooth fan operation. If more than one fan is being installed, be careful not to mix blades from different cartons.
- Inspect the contents of your carton for possible shipping or handling damage and report any such damage directly to your authorized Casablanca dealer.
- It is always a good idea to have an assistant to help with the installation.
- When cleaning, painting, or working near your fan, be very careful of the fan and blades. Always turn the power OFF to the ceiling fan before servicing it, working on it, or replacing light bulbs.
- Never insert anything into the path of the fan blades while the fan is in operation.
- Never install a fan over a pool or spa.
- Never operate a fan that has been damaged in any way. Contact Casablanca Fan Company by calling 1-888-227-2178, or contact your local authorized Casablanca dealer for assistance in obtaining service.

FUSE BOX  
(REMOVE FUSE FOR THE  
CIRCUIT YOU WILL BE  
WORKING ON)

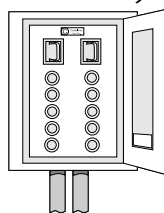

CIRCUIT BREAKER  
(TRIP BREAKER FOR THE  
CIRCUIT YOU WILL BE  
WORKING ON)

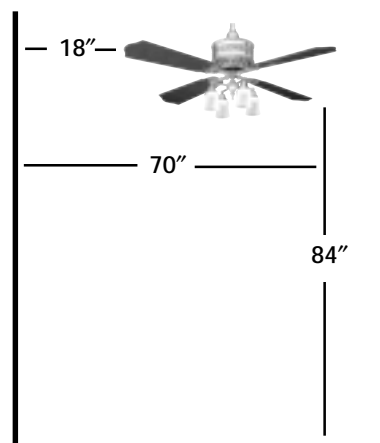
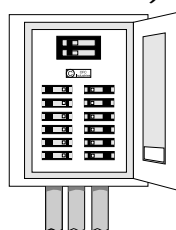

## MOUNTING RECOMMENDATIONS

Before mounting your Casablanca fan, read the following helpful recommendations. The location of the fan, air circulation, and fan size are all important factors to consider before installation.

### Location

Ceiling fans have practical uses in almost every room in your home. We suggest you follow these mounting recommendations as you decide where to install your Casablanca fan.

- For safety reasons, the fan blades must be a minimum of 7' above the floor.
- Do not locate the fan in a doorway or above a swinging door.
- In any installation, the tips of the blades must be at least 18" from the wall in order to provide sufficient clearance for the blades.
- In bedrooms, fans work best when mounted above the foot of the bed.
- Over pool tables, be sure to provide plenty of clearance to avoid damage from pool cues.
- In kitchens be sure to allow for open cupboard doors to clear the fan blades.
- Do not install a fan close to, or over, a pool or spa. High humidity combined with corrosive gases will destroy the finish and warp the blades.

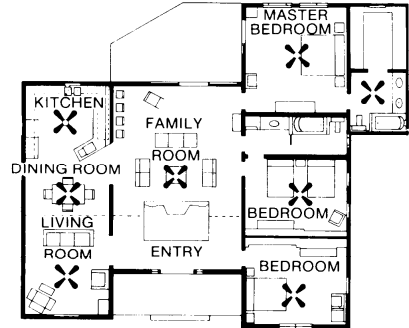

### Fan Size

Variable fan speed capability permits the use of a full-size 52" fan even in smaller rooms. For very large rooms, two fans may be needed.

## SLOPED CEILING INSTALLATIONS

Suggested Extension Pole Lengths	
Ceiling Height	Pole Length
10'	Standard
11'	18"
12'	24"
13'	36"
14'	48"

### When to Use Extension Poles

For best performance and best appearance, an extension pole should be used with your Casablanca fan when installing on high (cathedral) ceilings or sloped ceilings. Casablanca offers standard poles in increments of 6" up to 5'. Custom poles are available in lengths up to 10'. See your Authorized Casablanca Dealer for details.

*Note: Fan may wobble or vibrate if pole length is not long enough and inside blade is too close to downslope or side wall. Extending pole length will usually solve problem.*

### Calculation of 32°

Use the tear-off *Ceiling Angle Template* card inserted in the back of this manual, it provides you with a simple 'go' or 'no-go' for installing your fan on a sloped ceiling.

*Note: The canopy cover (Step 11) can NOT be used on a sloped ceiling.*

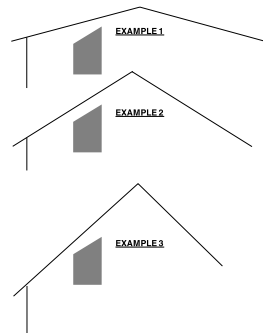
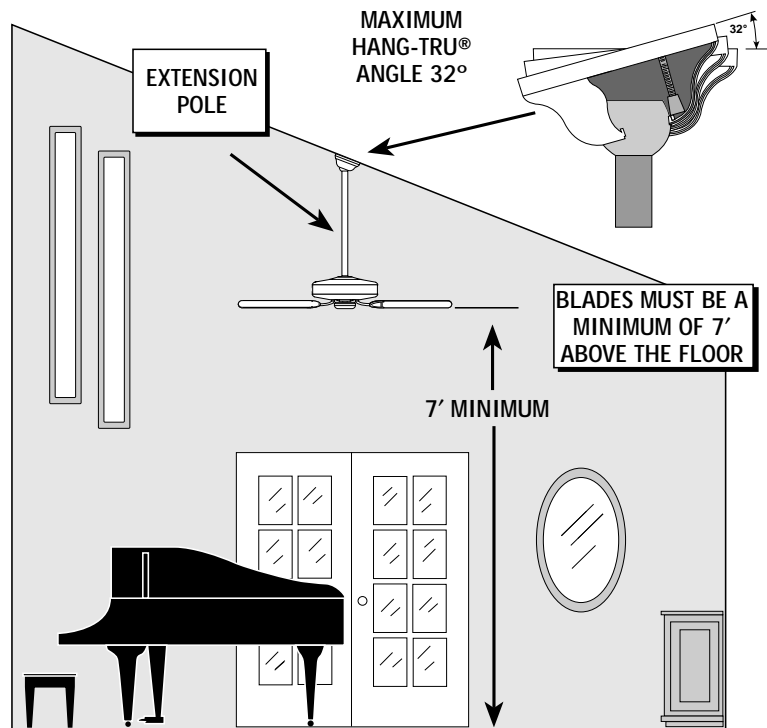

#### EXAMPLE 1

This slope is less than 32°. It is OK to install your fan.

#### EXAMPLE 2

This slope is 32°. This is the maximum slope that will allow the fan to hang straight down. It is OK to install your fan.

#### EXAMPLE 3

This slope is more than 32°. Your fan will not hang straight down, an adaptor is necessary. Contact your local Authorized Casablanca Dealer in regards to purchasing a "Slope Ceiling Adaptor."

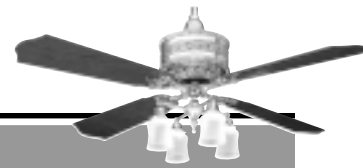

## PREPARATION INSTRUCTIONS

**Unpacking:** Before assembling and installing your ceiling fan, remove all parts from the shipping cartons and check them against the parts listed here. Before discarding packaging material, be certain that all parts have been removed.

## GETTING STARTED

### Carton Contents

The fan carton contains the fan body, warranty card, owner's manual, and all the parts necessary to assemble and install your Casablanca ceiling fan. These parts are shown at the start of each installation section. Before you start, go through this Owner's Manual and confirm that you have all the parts shown in each section.

Be sure to use only genuine Casablanca blades. The blade shrink wrap holds 4 blades of matched weight. If more than one fan is being installed, be sure not to mix blade sets.

**CAUTION:** When removing the shrink wrap, be careful not to scratch the blades.

## PERMA•LOCK™ HARDWARE

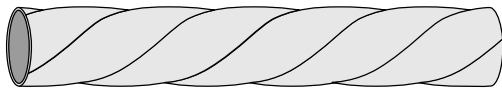

DOWNROD COVER

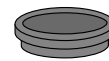

RUBBER DOWNROD GASKET



METAL DOWNROD GASKET

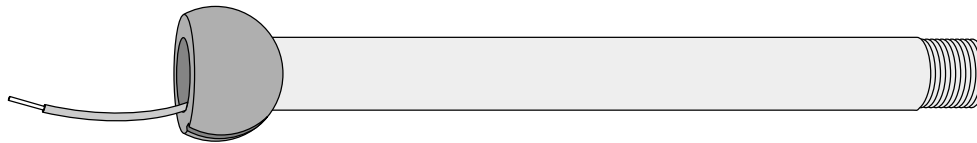

DOWNROD & BALL ASSEMBLY

## INSTALL RUBBER GASKET

Prepare the downrod as follows:

**Step A.** Insert the small lip of the rubber gasket into the downrod cover.

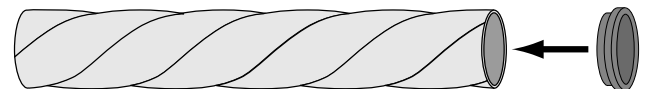

## ATTACH COVER TO DOWNROD

**Step B.** Slide the downrod cover, rubber gasket first, onto the downrod by using a twisting motion. Continue until the rubber gasket is flush with the downrod ball.

**CAUTION:** Do not attach the cover onto the downrod by pounding the downrod into the floor. This will damage the hanging mechanism and may cause the fan to fall.

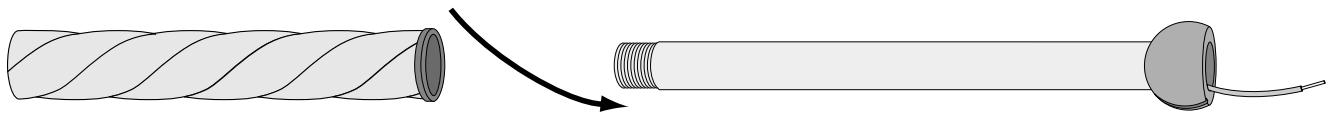

## INSTALL METAL GASKET

**Step C.** Attach the metal gasket onto the downrod assembly as shown. Using the provided screw, secure the metal gasket. Tighten the screw by hand only.

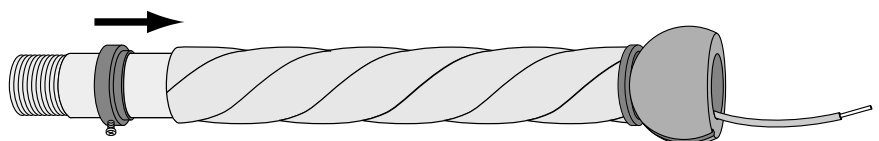

## FAN PREPARATION

### IMPORTANT SAFETY INFORMATION!

BEFORE STARTING THE INSTALLATION OF YOUR CEILING FAN, INSTALL THE THREADED DOWNROD INTO THE MOTOR COUPLING AND LOCK THE ASSEMBLY

Prepare for fan installation as follows:

**Step D.** Route the wires from the motor through the Perma•Lock™ downrod and ball assembly, keeping the wires to one side of the cross pin.

**NOTE:** The downrod has a tapered thread that is designed to lock completely when correctly installed.

**Step E.** Using the provided allen wrench, loosen the allen set screw. Thread the downrod into the motor coupling until it stops turning, this will take at least four and a half full turns.

**Step F.** Securely tighten the allen set screw with the provided allen wrench to ensure safe operation of your fan.

**CAUTION:** Failure to fully lock in the downrod before securely tightening the locking bolt may cause the fan to fall during normal operation!

 ALLEN SET SCREW  
1/4-20 x 1/4"  
(PRE-INSTALLED)

 3mm  
ALLEN WRENCH

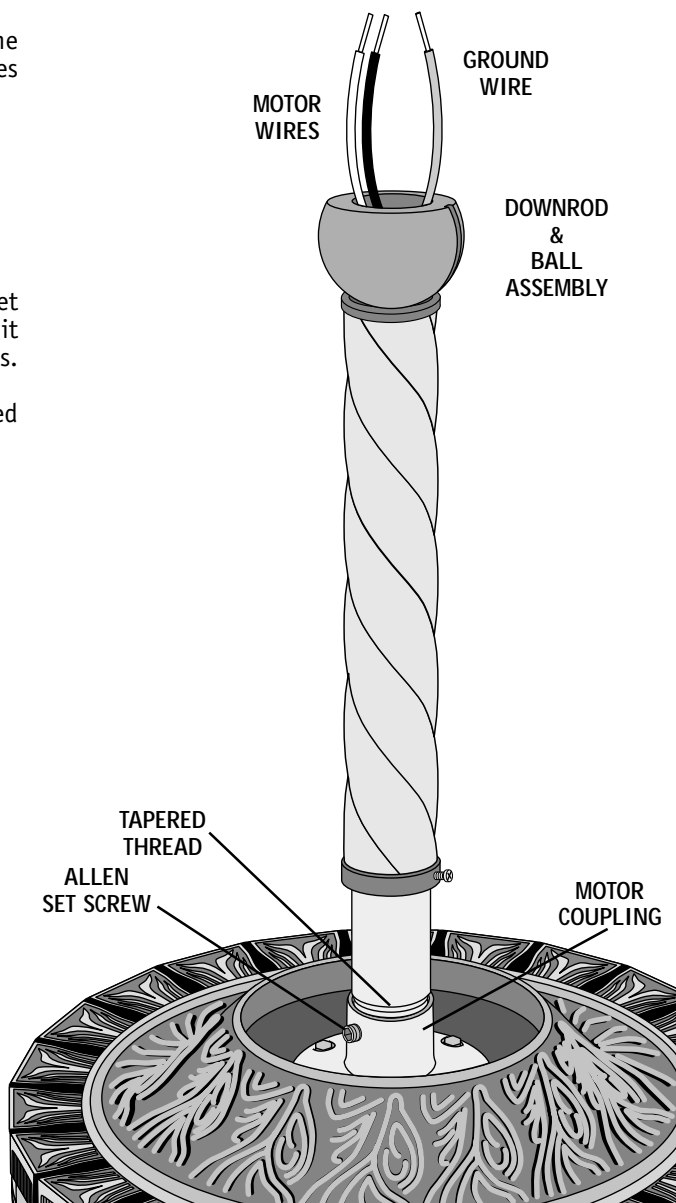

## GETTING STARTED

### Installing a New Ceiling Fixture Outlet Box

If you do not have an existing fixture located where you wish to place your Casablanca fan, an approved ceiling fixture outlet box must be installed and wired.

**Warning:** To reduce the risk of fire, electrical shock, or personal injury, mount to outlet box marked acceptable for ceiling fan support using the mounting hardware provided with the outlet box.

### Using Existing Ceiling Fixture Outlet Box

After turning the power OFF at its source (either circuit breaker or fuse box), lower the old fixture and disconnect the wiring. Check the ceiling fixture outlet box to be sure that it is marked 'Approved for ceiling fan mounting'. If it is not, a new box must be installed.

**NOTE:** The fan weight is 35 pounds.

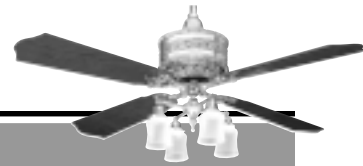

## CEILING HARDWARE

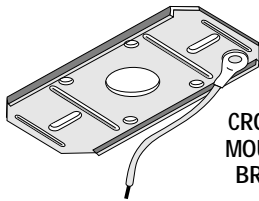

CROSSBAR  
MOUNTING  
BRACKET



WIRE NUT (4)

### ADDITIONAL HARDWARE

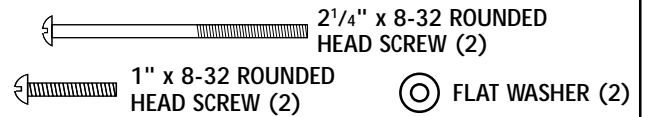

## SUPPORT INSTALLATION PARTS

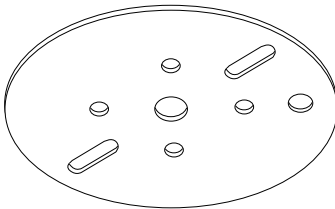

CANOPY  
ADAPTOR  
PLATE



LARGE  
FLAT WASHER  
3/8" (1)

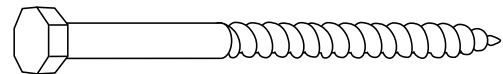

LAG SCREW  
3/8" #7 X 5" (1)

## ADAPTOR PLATE INSTALLATION

**Note:** After removing the old fixture, check the outlet box to insure that it is supported by a joist or beam across its upper surface. If not, a 2" x 4" stud must be installed.

**Step 1.** Remove the knockout plug in the center of the outlet box or drill a 1/2" hole for the lag screw to pass through. Then drill a 1/4" guide hole into the joist or beam to a depth of 3".

**CAUTION:** To reduce the risk of personal injury, use only the mounting hardware provided with the approved outlet box to install the crossbar mounting bracket.

**WARNING!**  
SUPPORT DIRECTLY TO  
BUILDING STRUCTURE ONLY.

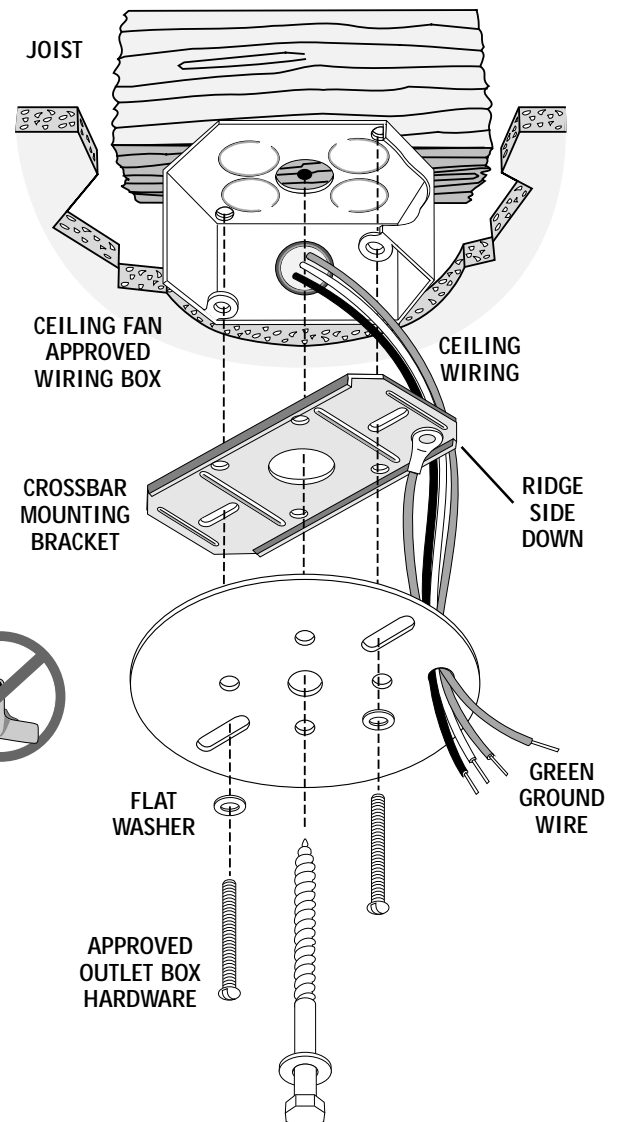

## LAG SCREW INSTALLATION

**Step 2.** Route the outlet box wires through the 1/2" diameter outer hole of the canopy adaptor plate. Attach the crossbar and canopy adaptor plate to outlet box with screws provided.

**Step 3.** With the large washer attached, pass the lag screw through the center hole of canopy adaptor plate and screw into guide hole. Tighten until outlet box is firmly mounted to beam. This box must be firmly secured to the ceiling. We recommend that the ceiling fixture outlet box be of sufficient capacity enabling it to support the weight of fan and light fixture under any conditions.

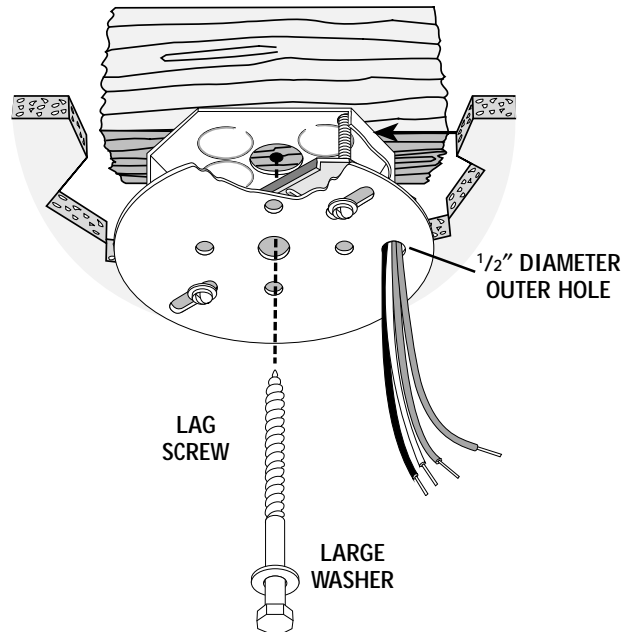

## CANOPY HARDWARE



CANOPY  
HATCH

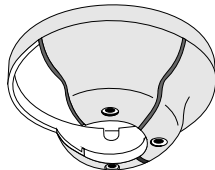

CANOPY



CANOPY SCREW (4)

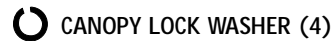

CANOPY LOCK WASHER (4)

## CANOPY INSTALLATION

**Step 4.** Attach the canopy to the crossbar mounting bracket behind the installed outlet adaptor plate with three of the 8-32 x 2 1/2" long canopy screws and lock washers provided with your Casablanca fan. Hand tighten until snug against the ceiling.

*Note: On sloped ceilings, align the canopy opening toward the top or peak of the room.*

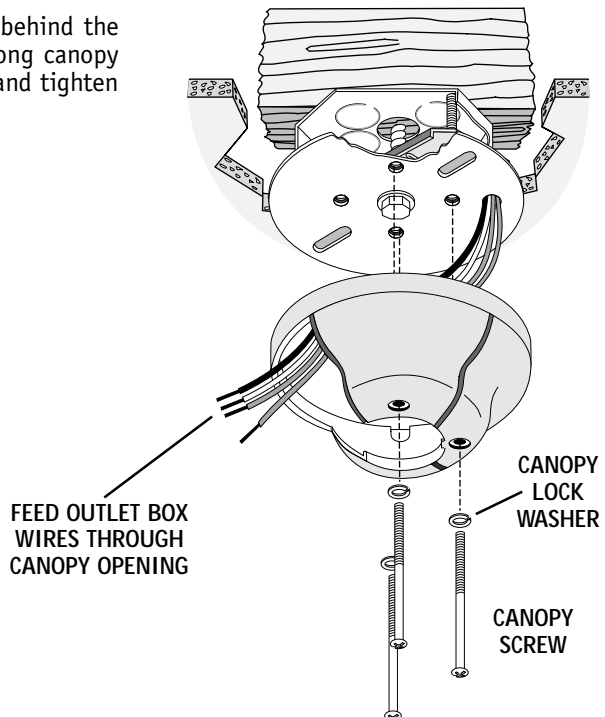

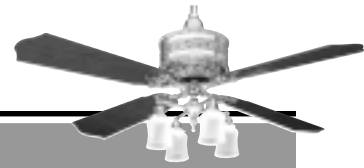

## HANGING THE FAN

**Step 5.** To hang the fan body in the canopy, hold the fan body firmly and insert the nylon ball into the canopy opening. Rotate fan body until slot on nylon ball fits into pin opposite canopy opening.

**NOTE:** The fan weight is 35 pounds.

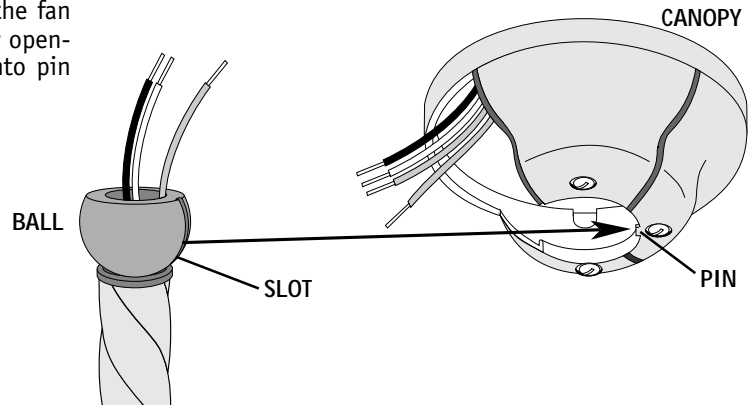

## CANOPY ELECTRICAL CONNECTIONS

**Step 6.** Connect the fan wires to the outlet box wiring by placing the bare ends of the wires together and then securing with a wire nut. Connect in this order:

- GREEN leads from mounting plate and fan to GROUND conductor of power source. Secure with wire nut.
- WHITE wire from fan to white NEUTRAL wire in ceiling fixture outlet box. Secure with wire nut.
- BLACK wire from fan to black POWER wire in ceiling fixture outlet box. Secure with wire nut.

Inspect each wire nut and ensure that no bare wire is visible; pull on each wire to test the connection is mechanically sound.

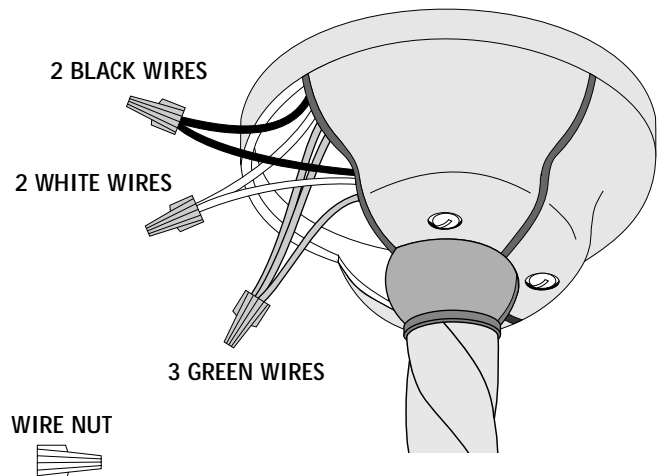

## CANOPY HATCH INSTALLATION

**Step 7.** Tuck the wires into the canopy with the wire nuts pointed upwards, so that the WHITE and BLACK wires are on opposite sides of the canopy and all wires are clear of the canopy opening.

**Step 8.** Install canopy hatch with the last canopy screw and lock washer. To do this, tilt the fan body away from the hatch opening. Tighten the screws firmly by hand only,

**Step 9.** Straighten the fan, then check to ensure that there is no movement between the canopy and ceiling or Hang-Tru ball and top support shaft.



**Note:** Write down the Serial Number and the model number for future reference.

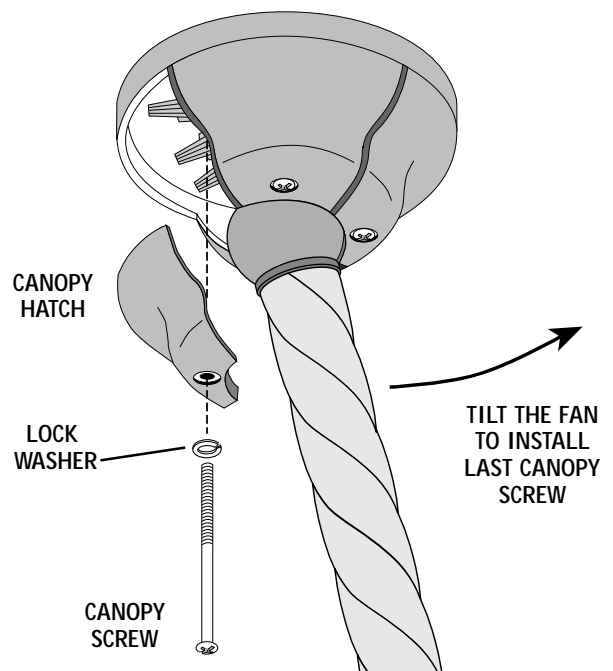



## DISASSEMBLE CANOPY AND MOTOR COVERS

**Step 10.** Remove the screws from the canopy cover and the motor cover and set aside for later use.

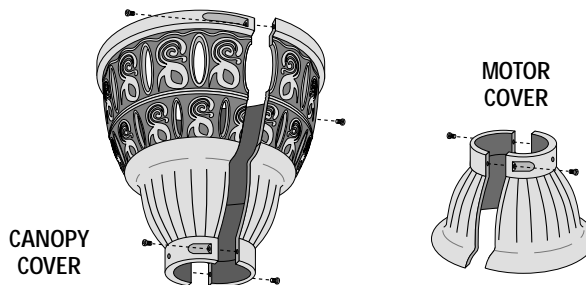

## INSTALL CANOPY COVER

**Step 11.** Take the two pieces of the canopy cover and assemble them around the downrod as shown. Using the four screws removed in Step 10, assemble the canopy cover.

Slide the canopy cover to the ceiling and secure to the downrod using the two provided screws. Tighten by hand only.

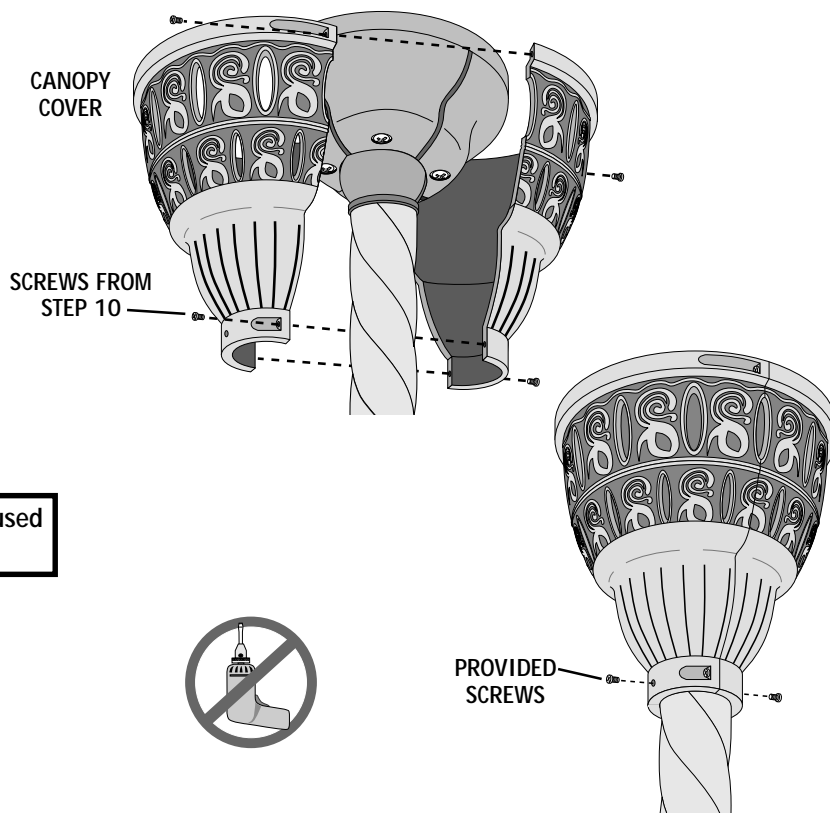

**CAUTION:** The canopy cover can NOT be used on sloped ceilings.



## INSTALL MOTOR COVER

**Step 12.** Take the two pieces of the motor cover and assemble them around the downrod as shown. Using the two screws removed in Step 10, assemble the motor cover.

Slide the motor cover down onto the top of the fan and secure to the downrod using the two provided screws.

Using the screwdriver, tighten securely by *hand* only.

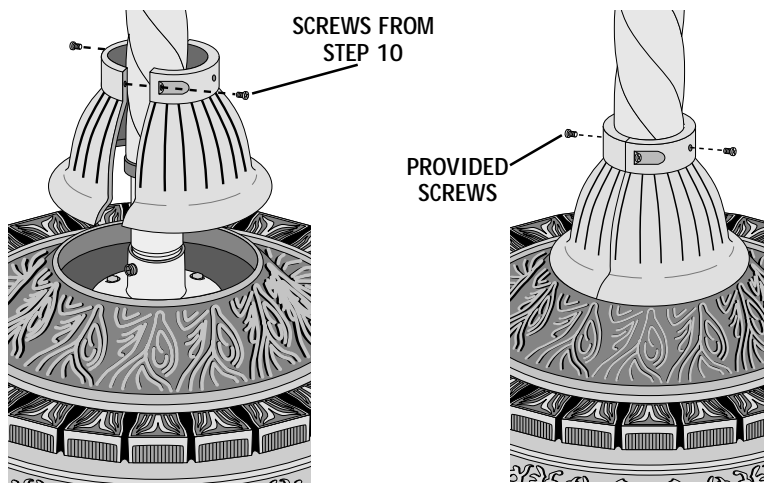

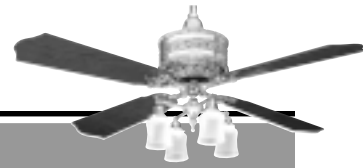

## BLADE HARDWARE

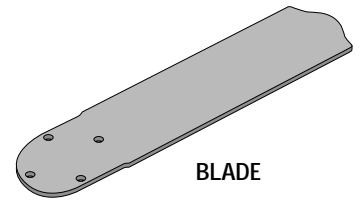
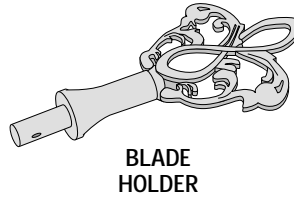

## ATTACH BLADE HOLDERS

**Step 13.** Attach the blades to the blade holders by aligning the screw holes of the holder with the holes of the blade.

Attach the blade holder using the four blade screws and blade washers provided for each blade.

Using the screwdriver, tighten securely by *hand* only.

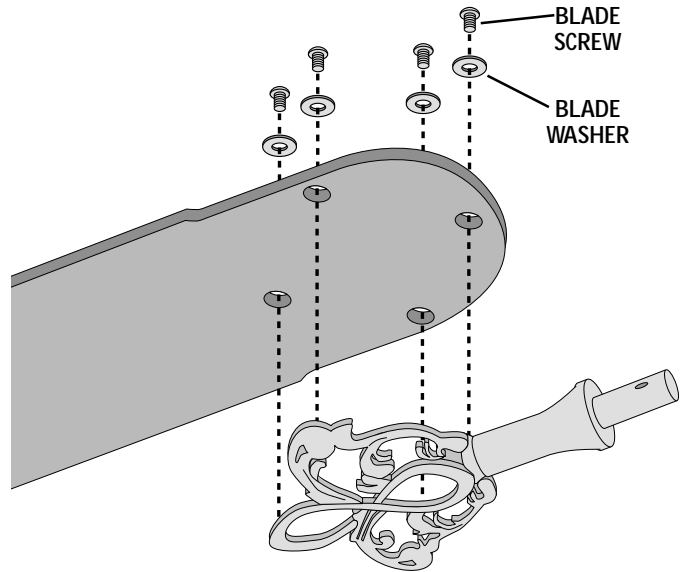

## INSTALL BLADE ASSEMBLY

**Step 14.** Remove the blade holder screw from the fan. Slide the blade assembly into the cross bar, assuring that the alignment holes line up.

Reinstall the blade holder screw, making sure that the blade assembly is secure and does not rotate when turned.

Using a wrench or pliers, tighten securely by *hand* only.

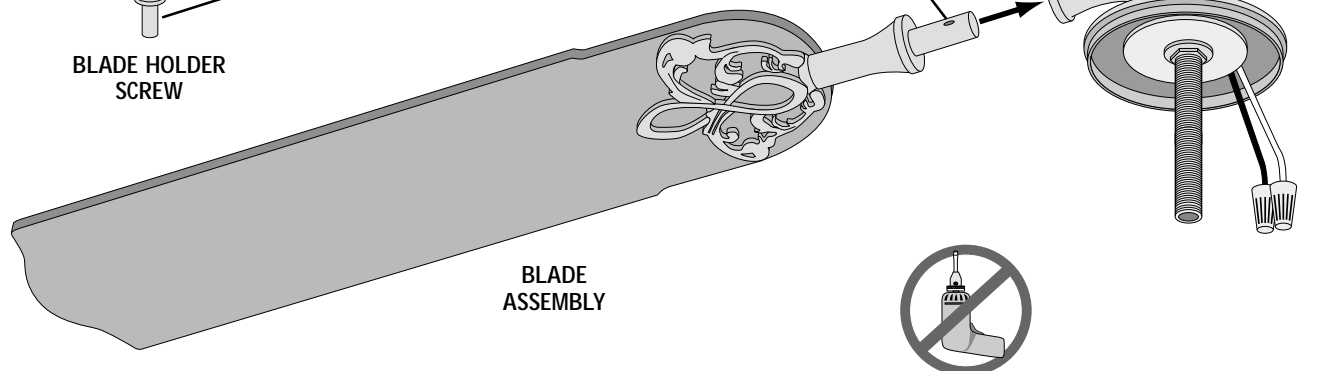
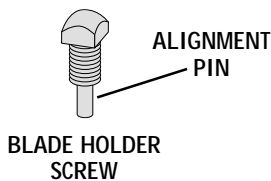

## LIGHT KIT WIRING

**NOTE:** If you do not desire to install the light kit, see "Optional Switch Housing Cup" installation instructions on Page 11.

**Step 15.** Remove the wire nuts on the BLACK and WHITE wires from the fan. If necessary remove the insulation from the last 1/2" of each wire (fan and light fixture).

**Step 16.** Attach the switch housing wires to the light fixture wires by placing the bare ends of the wires together and then securing with a wire nut. Connect in this order:

- WHITE wire from fan to WHITE wire from light fixture. Secure with wire nut.
- BLACK wire from fan to BLACK wire from light fixture. Secure with wire nut.

Inspect each wire nut and ensure that no bare wire is visible; pull on each wire to test the connection is mechanically sound.

WIRE NUT

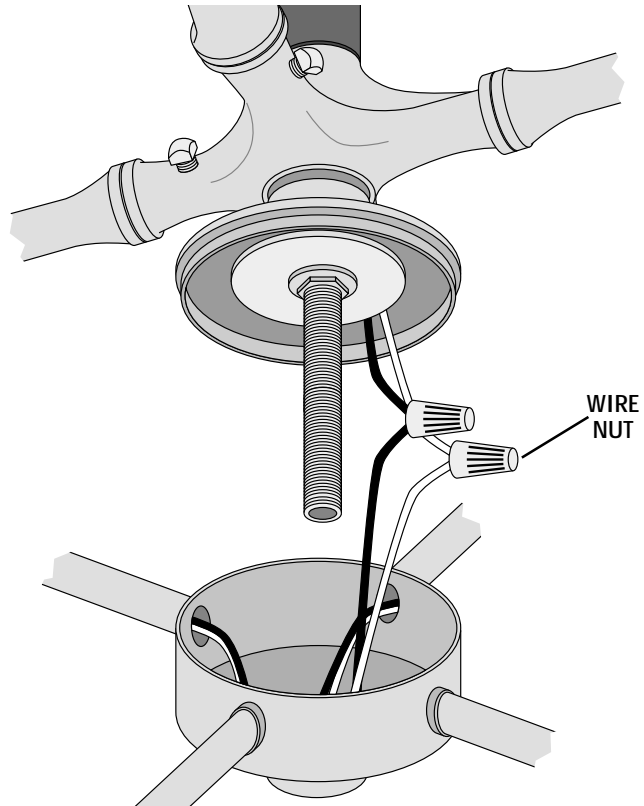

## INSTALL LIGHT KIT

**Step 17.** Slide the light kit over the threaded pipe from the switch housing. Assure that no wires are pinched.

Secure the light kit to the fan with the finial.

Tighten securely by *hand* only.

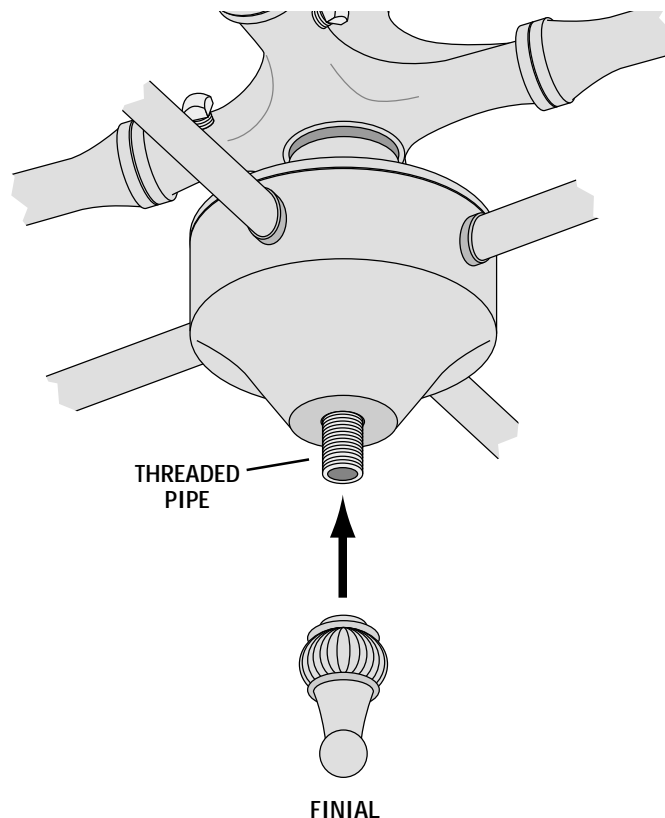

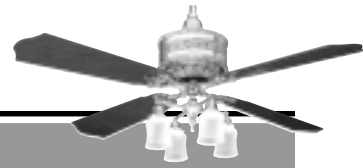

## GLASS HARDWARE

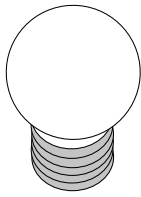

60 WATT TYPE A15  
INCANDESCENT BULB

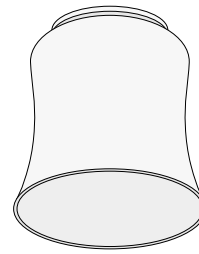

GLASS SHADE

## GLASS & BULB INSTALLATION

**Step 18.** Loosen the three glass screws for each fixture so the end of the screws are flush with the inside of the fixture.

Slide the glass shade into the fixture and hold firmly. Turn each screw several times, going in a circle, to assure that all glass screws have engaged the glass.

Tighten securely by *hand* only.

**Step 19.** Install the four 60 Watt type A15 bulbs into each fixture.

**CAUTION: TO REDUCE THE RISK OF FIRE USE MAX FOUR 60W STANDARD BASE A15 INCANDESCENT LIGHT BULBS**

*Note: Do NOT use standard (A-19) bulbs. This commonly available size is too large in diameter; the proximity of the bulb to the glass will not allow for adequate air circulation.*

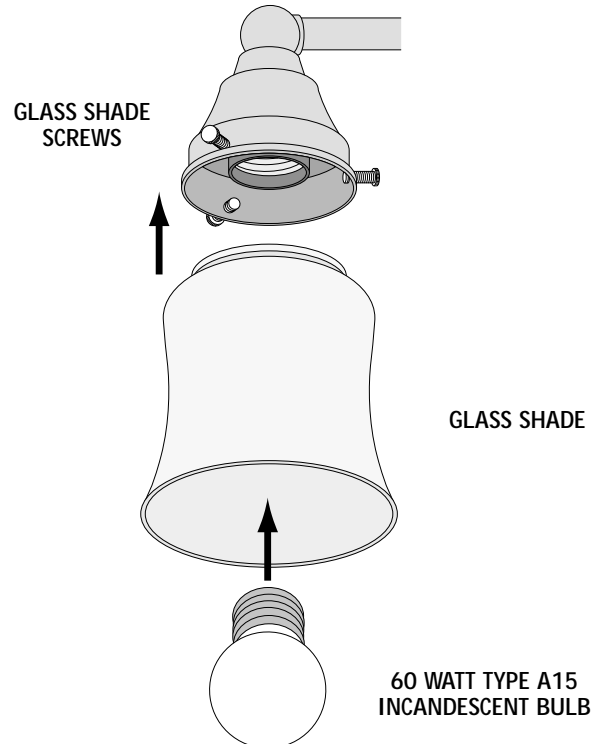

## OPTIONAL SWITCH HOUSING CUP

**NOTE:** This step is ONLY performed if you have chosen NOT to install the light kit.

Slide the optional switch housing cup over the threaded pipe from the switch housing. Assure that no wires are pinched.

Secure the cup to the fan with the finial.

Tighten securely by *hand* only.

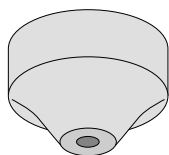

OPTIONAL SWITCH  
HOUSING CUP

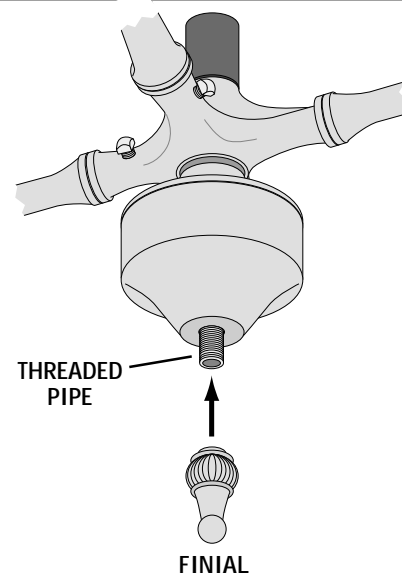

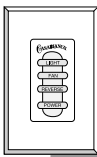

## INTELI-TOUCH © INSTALLING THE W-32 WALL CONTROL

The wall control installs in the same manner as an ordinary light switch, using an existing junction box and wiring. This controller is designed to signal the fan microcomputer as well as perform normal switching operations. For this reason the following precautions must be observed:

1. Use **only** the Casablanca W-32 wall control.
2. Do not use any additional control with your Intel-Touch fan (for example, dimmer, fan speed control, etc.).
3. Do not use more than **one fan per wall control**.
4. No other light fixtures or electrical appliances may be connected on the circuit controlled by the W-32 wall control unit.

### INTELI-TOUCH ♦ SINGLE W-32 INSTALLATION

**CAUTION!** Ensure power is turned OFF at the breaker or fuse panel before starting installation.

W-32 is used to describe either white (-11) or ivory finish.

1. Remove the screws and switch plate from the existing switch box.
2. Remove the screws holding the switch in the switch box.
3. Pull the existing switch from the switch box to expose the wire connections.
4. Remove the two wires from the switch.
5. Connect the two wires just removed from the switch to the W-32 wall control black wire and black/white stripe wire. Secure these connections with wire nuts.
6. Install the W-32 in the wall box with the two long screws provided.
7. Install the wall plate with the two color matched screws.

**NOTE:** If your wall control operation is reversed, i.e., fan switch controls lights and light switch controls fan, simply swap the two W-32 black/white stripe wires.

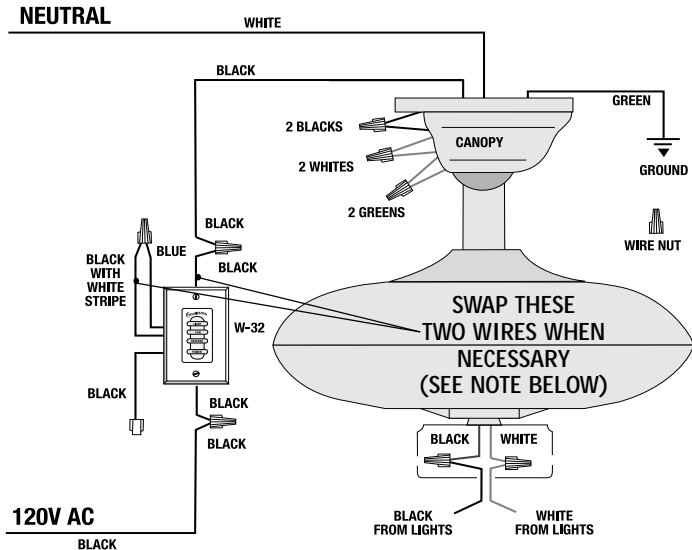

### INTELI-TOUCH ♦ DUAL W-32 INSTALLATION

**CAUTION!** Ensure power is turned OFF at the breaker or fuse panel before starting installation.

To control the fan and lights from two locations (a three-way circuit), use 2 W-32 wall controls.

1. Remove the screws and switch plate from the existing switch box and the screws holding the switch in the switch box.
2. Pull the existing switch from the switch box to expose the wire connections.
3. Determine which wire is connected to the common terminal of the 3-way switch. (The terminal will be marked on switch).
4. Remove the wire from the common terminal of the 3-way switch. Connect this wire to the remaining black/white striped wire on the W-32 control. Secure this splice with a wire nut.
5. Remove the two remaining wires from the 3-way switch. Connect one of these wires to a black wire on the W-32 control. Secure the splice with a wire nut. The remaining wire is to be connected to the other black wire on the W-32. Secure the splice with a wire nut.
6. Install the W-32 in the wall box with the two long screws provided.
7. Install the wall plate with the two short color-matched screws provided.
8. Installation of the second W-32 control is identical. Repeat steps 1 through 8.

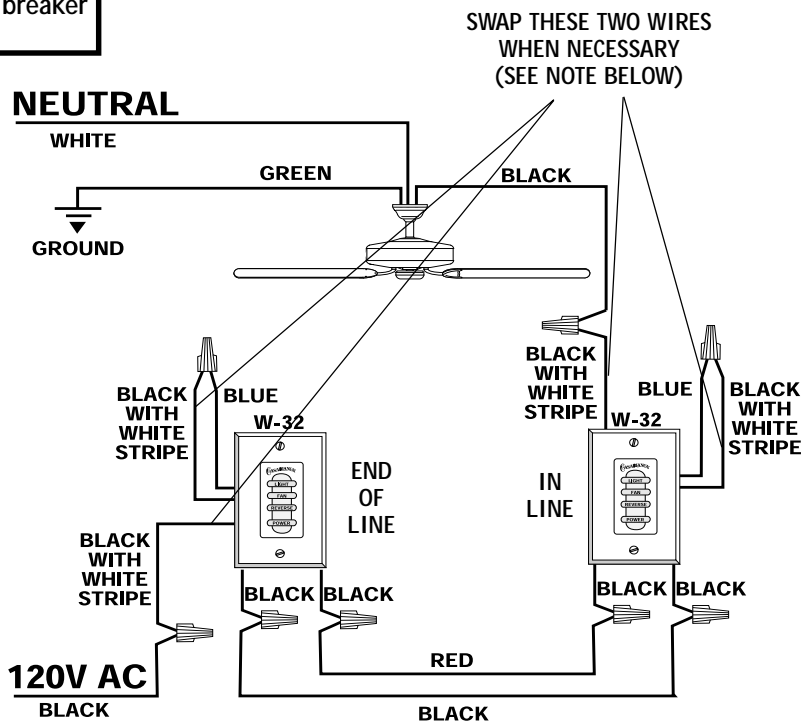

**NOTE:** If your wall control operation is reversed, i.e., fan switch controls lights and light switch controls fan, simply swap the two W-32 black/white stripe wires.

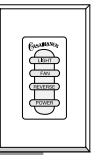

## INTELI-TOUCH OPERATION ♦ POWER

The **POWER** button is normally left in the on position. Always turn the power off during cleaning or servicing the fan and during thunderstorms. It is also used to exit or enter additional programs. **POWER must be left on to retain a previously set fan speed or light level.**

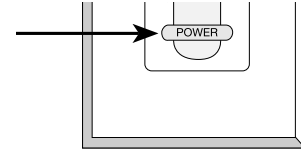

## INTELI-TOUCH OPERATION ♦ SPEED CONTROL

There are six individual speed settings for the fan; each speed is indicated by an audible tone of increasing pitch.

**To select the desired fan speed:**

1. With fan off, press and hold the button labeled **FAN**. The fan blades will start rotating at the slowest speed, and will increase in steps.
2. Release the button when the desired speed is reached.

The fan speed is now in memory and will automatically come on at the same speed each time the **FAN** button is used. To maintain this level of speed, turn the fan on by pressing **FAN** less than one second. To lower speed, turn fan off, then on by pressing and holding the **FAN** button until the desired speed is reached. When the fan is on, you may increase the speed by pressing and holding the **FAN** button until the desired speed is reached, then release it.

### FAN CONTROL

**ON - OFF:**  
A momentary press of the **FAN** button

**CHANGE SPEED:**  
Press and hold **FAN** button longer than one second

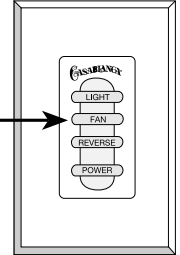

## INTELI-TOUCH OPERATION ♦ REVERSING AIRFLOW

The direction of airflow can be changed from downward to upward or from upward to downward.

**To reverse the airflow:**

1. Make sure the **FAN** is on.
2. Press the **REVERSE** button.

*Note: A four-toned signal indicates the command was accepted by the fan. A few seconds later the fan will slow to a stop and then reverse direction.*

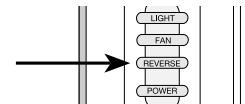

## INTELI-TOUCH OPERATION ♦ LIGHT

To turn the lights off and on, press and release the **LIGHT** button for less than one second.

**To vary the light brightness:**

1. With lights off, press and hold the **LIGHT** button. After one second the lights come on at their lowest level and gradually become brighter.
2. Release the button when the desired brightness level is reached.

The brightness level is now in the fan memory and will automatically come on at the same brightness the next time the **LIGHT** button is used. To maintain this level of brightness, press the **LIGHT** button for less than one second. To lower the brightness, turn the lights off, then press and hold the **LIGHT** button until the desired brightness level is reached. When the light is on, you may increase the brightness level by pressing and holding the **LIGHT** button until the desired level is reached, then release it.

### LIGHT CONTROL

**ON - OFF:**  
A momentary press of the **LIGHT** button

**CHANGE BRIGHTNESS:**  
PRESS AND HOLD **LIGHT** button longer than one second

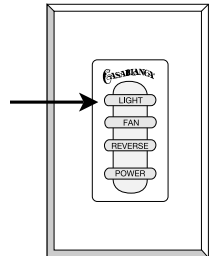

## AUTOMATIC DEMONSTRATION PROGRAM

Programmed into every Inteli-Touch Series fan is an Automatic Demonstration Program. It can be used to fully demonstrate and test the operation of the fan.

**To enter the demonstration program:**

1. Turn **POWER** off for at least three seconds. This will clear the fan memory ready for programming.
2. Turn **POWER** on.
3. Immediately operate the buttons in the following sequence:

**FAN - LIGHT - FAN - LIGHT - FAN**

A multi-tone signal will verify the start of the test program which proceeds as follows:

- Lights slowly increase to full intensity.
- Fan accelerates to speed three with audio tones.
- Light dims to half intensity.
- Fan accelerates to full speed with audio tones.
- Fan reverses at full speed with audio tones.
- Fan operates at full speed.
- Fan power is reversed with audio tones.
- Fan turns off with audio tones (blades coast for a short time).
- Lights turn off.

The complete cycle lasts slightly over one minute. It will continue to repeat until the **POWER** is turned off for more than three seconds, cancelling the program.

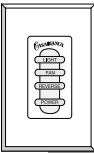

## INTELI-TOUCH OPERATION ♦ LIGHT-MINDER® PROGRAM

The Light-Minder program automatically turns OFF the fan mounted lights after two hours.

To enter the Light-Minder Program:

1. Turn the **POWER** OFF for at least three seconds.
2. Turn the **POWER** ON.
3. Immediately operate the buttons in the following sequence:

**FAN** + **FAN** + **LIGHT** + **LIGHT**

4. A series of tones indicates this command has been accepted. The fan and light will operate normally using the buttons to turn them on and off. But, if the lights are left on, they will automatically shut off after two hours. To cancel the Light-Minder Program, turn the **POWER** off for three seconds.

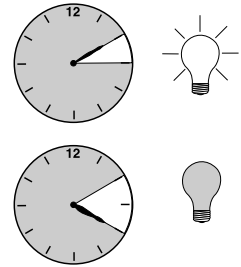

## INTELI-TOUCH OPERATION ♦ SAFE-EXIT® PROGRAM

The Safe-Exit Program gives you about thirty seconds of light when you turn the lights off, enabling you to exit your home before the lights go out.

To enter the Safe-Exit Program:

1. Turn the **POWER** off for at least three seconds.
2. Turn the **POWER** on.
3. Immediately operate the buttons in the following sequence:

**FAN** + **FAN** + **LIGHT** + **LIGHT**

After you hear the confirming audio

tones from the fan - **immediately press** **LIGHT**

4. The lights will blink to indicate this command has been accepted. The lights will stay on for twenty seconds and then begin to dim. After a total of thirty seconds has elapsed, the lights will be off completely. To cancel the Safe-Exit Program, turn the **POWER** off for three seconds.

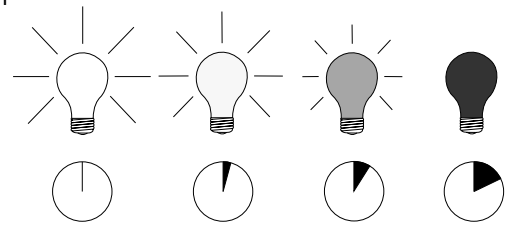

**Note:** Both Light-Minder and Safe-Exit programs can run at the same time, however the dimmer cannot be used, the light may only be turned ON/OFF.

## INTELI-TOUCH OPERATION ♦ HOME-SAFE® PROGRAM

The Home-Safe Program makes an unoccupied home appear occupied by turning the lights on and off at random times.

To enter the Home-Safe Program:

1. Turn the **POWER** off for at least three seconds.
2. Turn the **POWER** on.
3. Immediately operate the buttons in the following sequence:

**LIGHT** + **FAN** + **LIGHT** + **FAN**

4. A tone and flashing light indicate this command has been accepted. This program overrides all manual control of lights and fan. The lights will now be automatically cycled on and off in a controlled sequence as follows: On 1 hour, off 1/2 hour, on 2 hours, off 1 hour, on 1/2 hour then off 2 hours.

This seven hour pattern will repeat continuously so that a different pattern of lighting is seen each day of the week.

To cancel the Home-Safe Program, turn the **POWER** off for three seconds.



## INTELI-TOUCH OPERATION ♦ FAN-MINDER™ PROGRAM

The Fan-Minder feature will add to your comfort when used in the bedroom. The program reduces the speed of the fan each two-hour interval to compensate for the cooling night air.

To enter the Fan-Minder Program:

1. Turn the **POWER** off for at least three seconds.
2. Turn the **POWER** on.
3. Immediately operate the buttons in the following sequence:

**LIGHT** + **LIGHT** + **FAN** + **FAN**

4. The fan controller will respond with three descending tones. A timer is now initiated and the fan will reduce one speed for each two-hour interval. The fan will not, however, descend below the second lowest speed.

To cancel the Fan-Minder Program, turn the **POWER** off for three seconds. You may increase the fan speed by pressing and holding the **FAN** button until the desired speed is reached, then release it. The fan will again reduce one speed for each 2 hour interval.

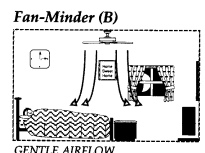
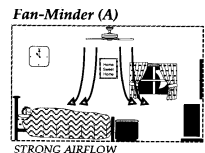

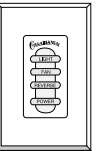

## TROUBLESHOOTING

*Before Requesting Service: Please follow this troubleshooting guide before contacting your dealer for assistance.*

**Caring for Finishes:** For cleaning, a soft brush or lint-free cloth should be used to prevent scratching the finish. A vacuum cleaner brush nozzle can remove heavier dust. Surface smudges or an accumulation of dirt and dust can easily be removed by using a mild detergent and slightly dampened soft cloth. An antistatic agent may be used, but *never* use abrasive cleaning agents. These will damage the finish. Painted and high-gloss blades may be cleaned in the same manner.

**Blades:** Wood finish blades should be cleaned with a furniture polishing cloth. Occasionally, a light coat of furniture polish may be applied for added protection and beauty.

**Never Lubricate this Fan!**

The precision motor at the heart of your Casablanca fan features sealed bearings that are lubricated for life. Do not attempt to oil the motor.

**Changing Light Bulbs**

Be sure to turn power to the fan OFF at the wall switch or circuit breaker before changing light bulbs. Replace bulbs with same type as removed from the fixture. Each fan is rated for a maximum **TOTAL** wattage of lighting.

Exceeding the rated maximum allowable wattage for the fan will burn out the fan electronics module and void the warranty.

PROBLEM	INTELI•TOUCH	POSSIBLE REMEDIES
---------	--------------	-------------------

<b>NO FAN OR LIGHT</b>	Check main circuit fuses, circuit breakers, or wall switch position. Check all wire connections, making sure the power is turned off during this inspection.	
------------------------	--	--

<b>FAN WOBBLER OR SHAKES EXCESSIVELY</b>	Be sure canopy pin is properly set into the slot on the ball Check the screws holding the blade holders to the fan motor. Tighten as necessary. Check the angle of the blades to make sure that a blade holder has not been bent during installation.	
--	---	--

<b>FAN NOISY DURING OPERATION</b>	Check and tighten light fixture retaining screws, glass shade screws and/or the light bulb(s). Tighten canopy screws and mounting plate assembly. Tighten the blade to bladeholder screws and blade holders to flywheel. Make sure all screws in the motor housing are snug, but not overly tight. Check that the wire nuts inside the canopy and switch housing are not touching the metal parts or have fallen off the wire splices. Tighten or adjust as necessary.	
-----------------------------------	--	--

<b>BREAK-IN PERIOD</b>	Let fan run at high speed for two (2) hours	
------------------------	---	--

<b>DOES NOT RUN ON LOW SPEED</b>	If new, "break-in" may be required - run at higher speed for several days	
----------------------------------	---	--

**LIGHTS FLASH OR BLINK DURING OPERATION OF W-32 WALL CONTROLS/FAN MAY ROTATE OR MAKE AUDIBLE TONES DURING OPERATION OF THE W-11 AND W-12 WALL CONTROLS:** Normal operation.

**WHEN AC POWER IS TURNED ON FOR THE FIRST TIME, THE LIGHTS OPERATE NORMALLY, BUT W-32 WALL CONTROL OPERATION IS REVERSED: FAN BUTTON OPERATES THE LIGHTS; LIGHT BUTTON OPERATES THE FAN:** Reverse the 2 black and white striped wire connections.

**FAN OR LIGHTS APPEAR TO OPERATE BY THEMSELVES (CHANGING SPEED OR INTENSITY), WALL CONTROL OPERATION IS INTERMITTENT:** Check AC supply for irregularities, (noise spikes, fluctuations, or failure); or circuit board assembly.

For questions or to locate the nearest  
Casablanca Authorized Service Center  
call toll free:  
**1-888-227-2178**  
or visit us on the web at:  
**www.CasablancaFanCo.com**





761 CORPORATE CENTER DRIVE • POMONA, CA 91768  
TOLL FREE: 888-CASA-1ST (227-2178)

[www.CasablancaFanCo.com](http://www.CasablancaFanCo.com)

©COPYRIGHT 2000 CASABLANCA FAN COMPANY • U.S. PATENT PENDING

PRINTED IN ROC

## Free Manuals Download Website

<http://myh66.com>

<http://usermanuals.us>

<http://www.somanuals.com>

<http://www.4manuals.cc>

<http://www.manual-lib.com>

<http://www.404manual.com>

<http://www.luxmanual.com>

<http://aubethermostatmanual.com>

Golf course search by state

<http://golfingnear.com>

Email search by domain

<http://emailbydomain.com>

Auto manuals search

<http://auto.somanuals.com>

TV manuals search

<http://tv.somanuals.com>