

# CONTENTS

INTRODUCTION . . . . .	1
MOUNTING RECOMMENDATIONS . . . . .	2
PREPARATION INSTRUCTIONS . . . . .	3
FAN INSTALLATION . . . . .	4
CONTROL FEATURES:	
3-SPEED OPERATION . . . . .	9
TROUBLESHOOTING . . . . .	9

**READ AND SAVE THESE INSTRUCTIONS**

## SAFETY FIRST

**Safety and the proper operation of your Casablanca fan both require a thorough knowledge of the product and proper installation; therefore, before attempting to install and operate your Casablanca fan, read this owner's manual completely and carefully. Retain this manual for future reference.**  
**CAUTION: To avoid possible electrical shock, make certain that electricity is turned off at the circuit breaker or fuse box before attempting any installation procedure.**

### BEFORE YOU START

- All wiring must be in accordance with the National Electric Code ANSI/NFPA 70-1993 and the appropriate local electrical codes. The National Electric Code requires proper grounding as a precaution against electrical shock. A qualified electrician should be consulted if you are unsure.
- This fan is designed to be installed on an existing electrical outlet box. The outlet box must be UL Listed for ceiling fan installations, if it is not, a new box must be installed. Casablanca extension poles are available for sloped or high ceiling installations.
- This ceiling fan requires a grounded electrical supply of 120 VAC, 60 Hz and a minimum 15 amp circuit. The maximum current requirement for the fan with light fixture is 3.8 amps. The fan uses about 1 amp or 100 watts. Maximum light current is 2.8 amps or 340 watts of lighting.
- Where wire nuts are employed, be sure all bare wires are within the connectors. When installing the canopy hatch, make sure all wires are within the canopy and that no wires are being pinched.

**For best performance and for your warranty to be valid, use only genuine Casablanca blades, light fixtures, and accessories.**

### SAFE USE

- The blades in each pack are matched for equal weight to assure smooth fan operation. If more than one fan is being installed, be careful not to mix blades from different cartons.
- Inspect the contents of your carton for possible shipping or handling damage and report any such damage directly to your authorized Casablanca dealer.
- It is always a good idea to have an assistant to help with the installation.
- When cleaning, painting, or working near your fan, be very careful of the fan and blades. Always turn the power OFF to the ceiling fan before servicing it, working on it, or replacing light bulbs.
- Never insert anything into the path of the fan blades while the fan is in operation.
- Never install a fan over a pool or spa.
- Never operate a fan that has been damaged in any way. Contact Casablanca Fan Company by calling toll free 1-888-227-2178, or contact your local authorized Casablanca dealer for assistance in obtaining service.

**FUSE BOX  
(REMOVE FUSE FOR THE  
CIRCUIT YOU WILL BE  
WORKING ON)**

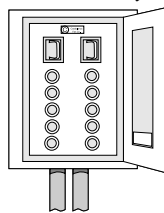

**CIRCUIT BREAKER  
(TRIP BREAKER FOR THE  
CIRCUIT YOU WILL BE  
WORKING ON)**

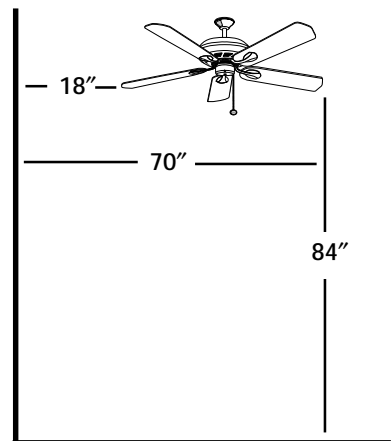
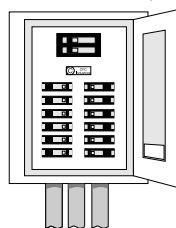

## MOUNTING RECOMMENDATIONS

Before mounting your Casablanca fan, read the following helpful recommendations. The location of the fan, air circulation, and fan size are all important factors to consider before installation.

### Location

Ceiling fans have practical uses in almost every room in your home. We suggest you follow these mounting recommendations as you decide where to install your Casablanca fan.

- For safety reasons, the fan blades must be a minimum of 7' above the floor.
- Do not locate the fan in a doorway or above a swinging door.
- In any installation, the tips of the blades must be at least 18" from the wall in order to provide sufficient clearance for the blades.
- In bedrooms, fans work best when mounted above the foot of the bed.
- Over pool tables, be sure to provide plenty of clearance to avoid damage from pool cues.
- In low ceiling locations, our optional Low Ceiling Adaptor (LCA)—available at extra cost—can be used to gain 3 1/2".
- In kitchens be sure to allow for open cupboard doors to clear the fan blades.
- Do not install a fan close to, or over, a pool or spa. High humidity combined with corrosive gases will destroy the finish and warp the blades.

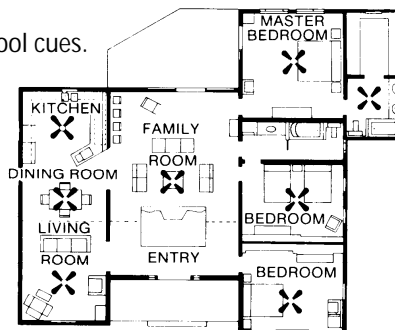

### Fan Size

Variable fan speed capability permits the use of a full-size 52" fan even in smaller rooms. For very large rooms, two fans may be needed.

## SLOPED CEILING INSTALLATIONS

Suggested Extension Pole Lengths	
Ceiling Height	Pole Length
8'	Standard
8' 6"	Standard
9'	6"
9' 6"	12"
10'	12"
11'	18"
12'	24"
13'	36"
14'	48"

### When to Use Extension Poles

For best performance and best appearance, an extension pole should be used with your Casablanca fan when installing on high (cathedral) ceilings or sloped ceilings. Casablanca offers standard poles in increments of 6" up to 5'. Custom poles are available in lengths up to 10'. See your Authorized Casablanca Dealer for details.

*Note: Fan may wobble or vibrate if pole length is not long enough and inside blade is too close to downslope or side wall. Extending pole length will usually solve problem.*

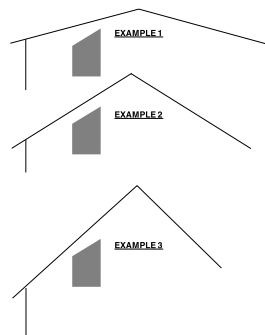
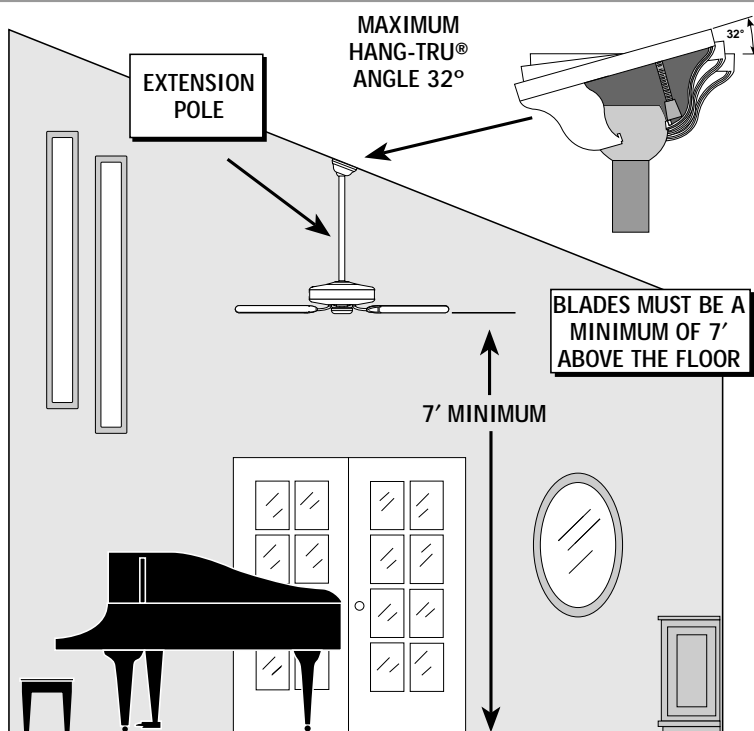

#### EXAMPLE 1

This slope is less than 32°. It is OK to install your fan.

#### EXAMPLE 2

This slope is 32°. This is the maximum slope that will allow the fan to hang straight down. It is OK to install your fan.

#### EXAMPLE 3

This slope is more than 32°. Your fan will not hang straight down, an adaptor is necessary. Contact your local Authorized Casablanca Dealer in regards to purchasing a "Slope Ceiling Adaptor."

### Calculation of 32°

Use the tear-off *Ceiling Angle Template* card inserted in the back of this manual, it provides you with a simple 'go' or 'no-go' for installing your fan on a sloped ceiling.

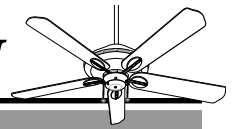

## PREPARATION INSTRUCTIONS

Unpacking: Before assembling and installing your ceiling fan, remove all parts from the shipping cartons and check them against the parts listed here. Before discarding packaging material, be certain that all parts have been removed.

## PERMA•LOCK™ HARDWARE



ALLEN SET SCREW  
1/4-20 x 1/4"  
(PRE-INSTALLED)



3mm  
ALLEN WRENCH

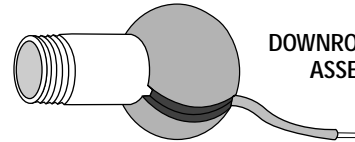

DOWNROD & BALL  
ASSEMBLY

## FAN PREPARATION

**CAUTION:** Before trimming wires or installing the downrod, pull the wires on the bottom of the fan to assure they are all the same length as shown.

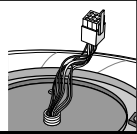

### IMPORTANT SAFETY INFORMATION!

BEFORE STARTING THE INSTALLATION OF YOUR CEILING FAN, INSTALL THE THREADED DOWNROD INTO THE MOTOR COUPLING AND LOCK THE ASSEMBLY

Prepare for fan installation as follows:

**Step A.** Route the wires from the motor through the Perma•Lock™ downrod and ball assembly.

**Tip:** The downrod has a tapered thread that is designed to lock completely when correctly installed.

**Step B.** Using the provided allen wrench, loosen the set screw several turns to allow installation of the downrod. Thread the downrod into the motor coupling until it stops turning, this will take at least four and a half full turns.

**Step C.** Securely tighten the set screw with the provided allen wrench to ensure safe operation of your fan.

**CAUTION:** Failure to fully lock in the downrod before securely tightening the allen set screw may cause the fan to separate from the downrod during normal operation!

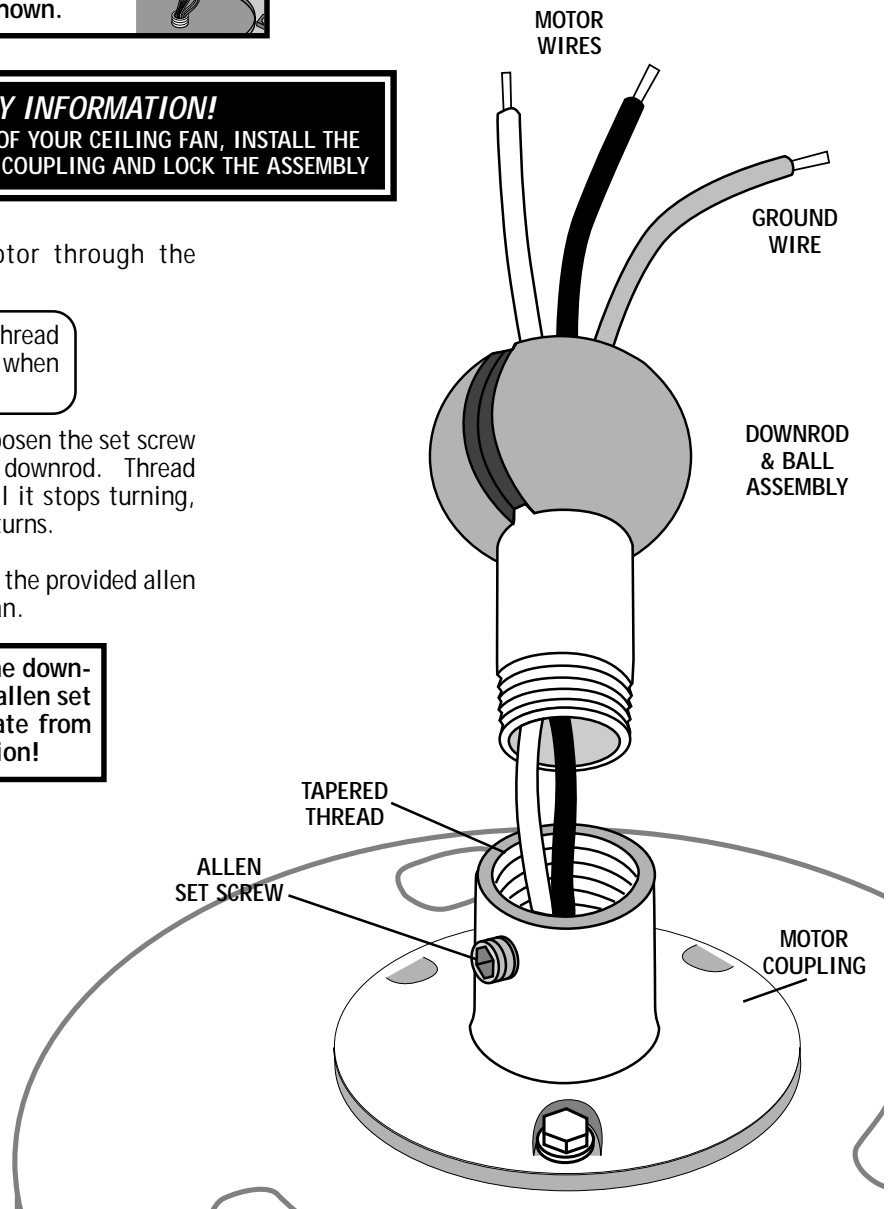

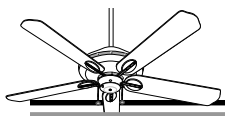

# UTOPIAN

## CEILING HARDWARE

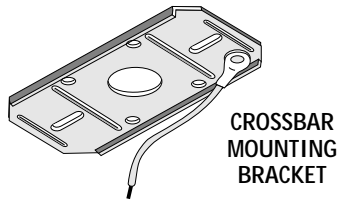

CROSSBAR MOUNTING BRACKET



WIRE NUT (4)

**ADDITIONAL HARDWARE**

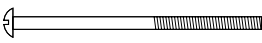

2 1/4" x 8-32 ROUNDED HEAD SCREW (2)



1" x 8-32 ROUNDED HEAD SCREW (2)



FLAT WASHER (2)

## GETTING STARTED

### Installing a New Ceiling Fixture Outlet Box

If you do not have an existing fixture located where you wish to place your Casablanca fan, an approved ceiling fixture outlet box must be installed and wired.

**Warning:** To reduce the risk of fire, electrical shock, or personal injury, mount to outlet box marked acceptable for ceiling fan support using the mounting hardware provided with the outlet box.

### Using Existing Ceiling Fixture Outlet Box

After turning the power OFF at its source (either circuit breaker or fuse box), lower the old fixture and disconnect the wiring. Check the ceiling fixture outlet box to be sure that it is marked 'Approved for ceiling fan mounting'. If it is not, a new box must be installed.

## CROSSBAR MOUNTING BRACKET INSTALLATION

**WARNING:** Damp Location rated fans require a Ground Fault Interrupter (GFI). Use a weather-proof outlet box, properly connect ground wires, and use only under a weather-proof structure.

Proceed with installation as follows:

**Step 1.** Route the wires from the ceiling outlet box through the crossbar mounting bracket center hole. Attach the bracket, with ground wire and ridges down, to the ceiling fixture outlet box with the mounting hardware included with the outlet box.

Using the screwdriver, tighten the screws firmly by *hand* only, being careful not to bend the bracket by over tightening.

**CAUTION:** To reduce the risk of personal injury, use only the mounting hardware provided with the approved outlet box to install the crossbar mounting bracket.

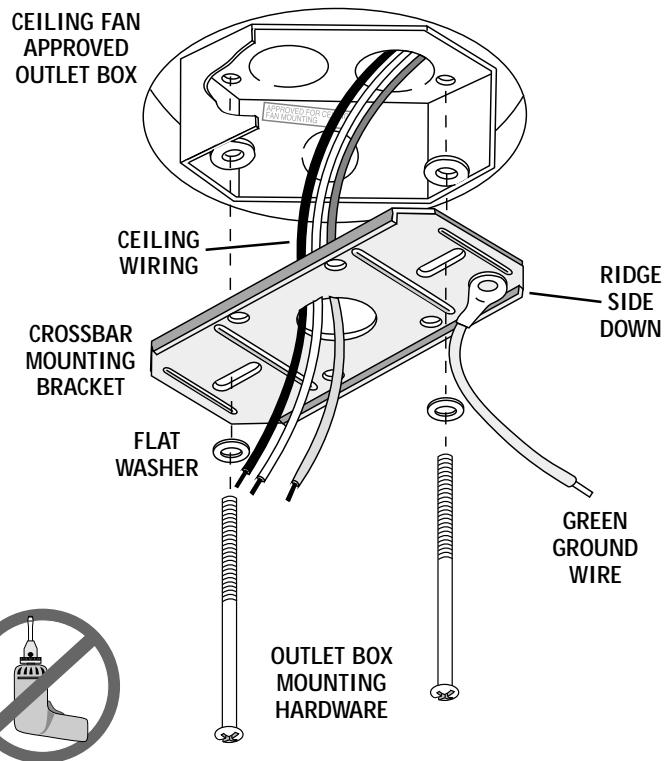

## CANOPY HARDWARE



CANOPY HATCH

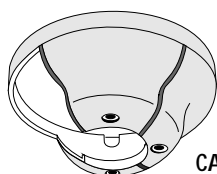

CANOPY

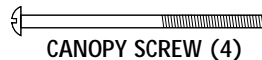

CANOPY SCREW (4)



CANOPY LOCK WASHER (4)

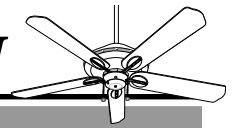

## CANOPY INSTALLATION

**Step 2.** Thread the wires from the ceiling through the opening in the canopy. Attach the canopy to the crossbar mounting bracket with three of the 8-32 x 2 1/4" long canopy screws and canopy lock washers.

Using the screwdriver, tighten the screw firmly by *hand* only.

**Note:** On sloped ceilings, align the canopy opening toward the top or room peak.

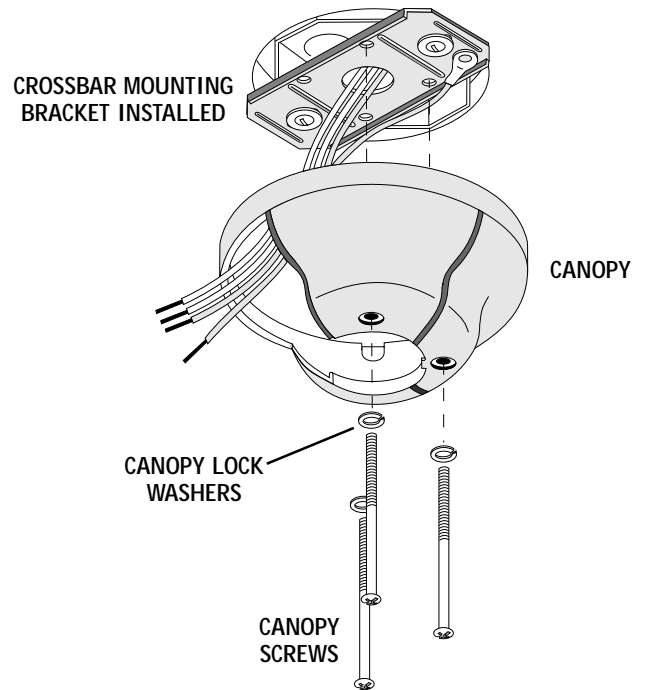

## HANGING THE FAN

**Step 3.** To hang the fan body in the canopy, hold the fan body firmly and insert the ball into the canopy opening. Check that no wires were pinched. Rotate the fan body until the slot in the ball fits into the pin opposite the canopy opening.

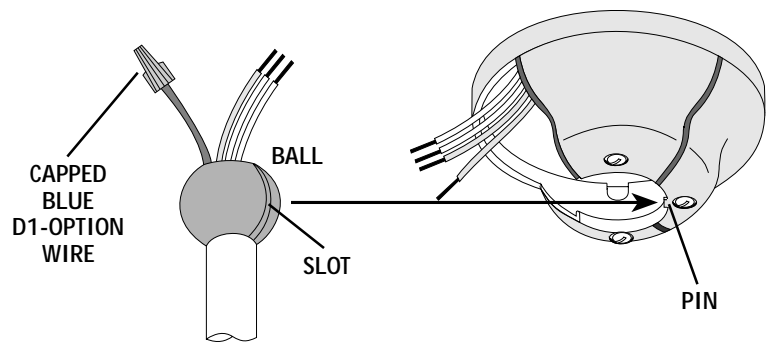

## CANOPY ELECTRICAL CONNECTIONS

**Step 4a.** Attach the fan wires to the ceiling fixture outlet box wiring by placing the bare ends of the wires side by side and then securing with a wire nut. Test that the connection is secure by pulling on the wire nut. Connect in this order:

**Step 4b. Pull Chain Connections**

- GREEN leads from mounting plate and fan to GROUND conductor of power source. Secure with wire nut.
- WHITE wire from fan to white NEUTRAL wire in ceiling fixture outlet box. Secure with wire nut.
- BLUE wire and BLACK power wire from fan to BLACK power wire in ceiling outlet box. Secure with wire nut.

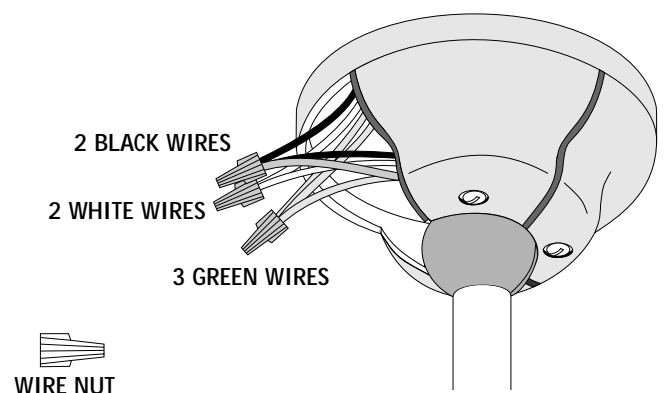

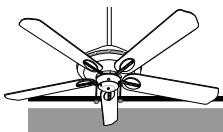

# UTOPIAN

## CANOPY HATCH INSTALLATION

**Step 5.** Tuck the wires into the canopy with the wire nuts pointed upwards, so that the WHITE and BLACK wires are on opposite sides of the canopy and all wires are clear of the canopy opening.

**Step 6.** Install canopy hatch with the last canopy screw and lock washer. To do this, tilt the fan body away from the hatch opening. Using the screwdriver, tighten the screws firmly by *hand* only,

**Step 7.** Straighten the fan, then check to ensure that there is no movement between the canopy and ceiling or Hang-Tru ball and top support shaft.

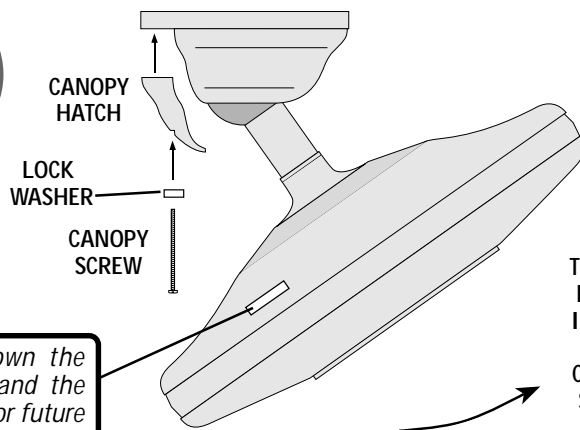

*Note: Write down the Serial Number and the model number for future reference.*

## BLADE TO BLADE HOLDER INSTALLATION BLADE & BLADE HOLDER HARDWARE

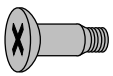

BLADE SCREW  
(4 PER BLADE)



RUBBER GROMMET  
(4 PER BLADE)

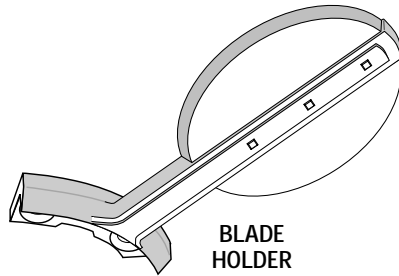

BLADE  
HOLDER



BLADE HOLDER  
SCREW  
(2 PER BLADE)

## RUBBER GROMMET INSTALLATION

**Step 8.** Insert a rubber grommet through each blade hole of every blade. Inspect both sides of the blade to assure that the lips of the grommet are fully engaged.



CORRECT INSTALLATION



INCORRECT INSTALLATION

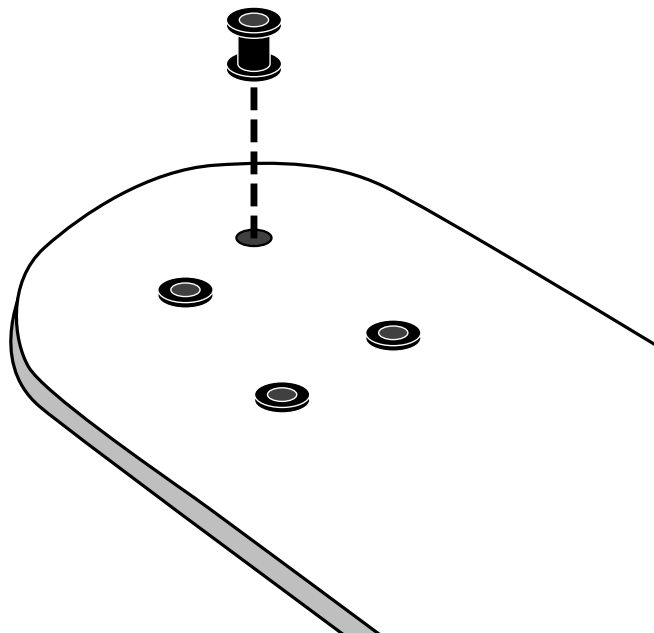

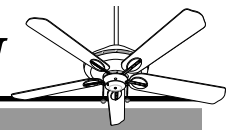

## BLADE INSTALLATION

**Step 9.** Attach each blade to a blade holder securing it with the four blade screws provided.

Using the screwdriver, tighten securely by *hand* only.

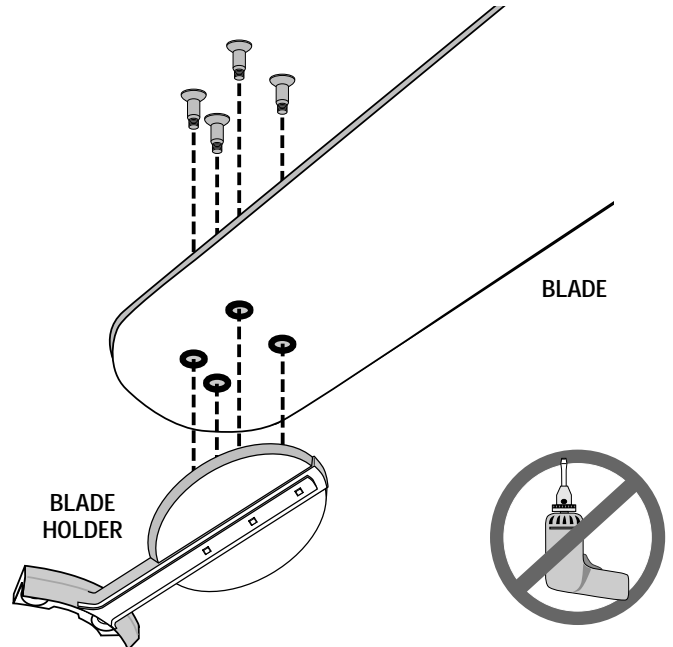
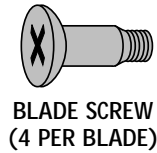

## REMOVE SHIPPING BLOCKS

**Step 10.** On the motor remove the five shipping blocks by unscrewing the screws. Set these screws aside for installing the blades in Step 11.

Discard the five shipping blocks.

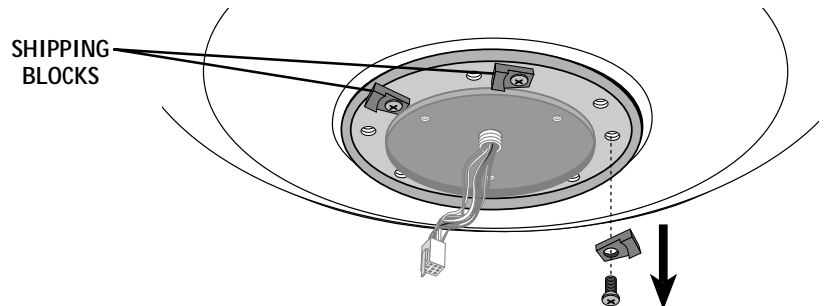

## BLADE/BLADE HOLDER INSTALLATION

**Step 11.** Using the five screws removed in Step 10, and the five additional screws from the pack, attach each blade/blade holder assembly to the motor.

Using the screwdriver, tighten securely by *hand* only.

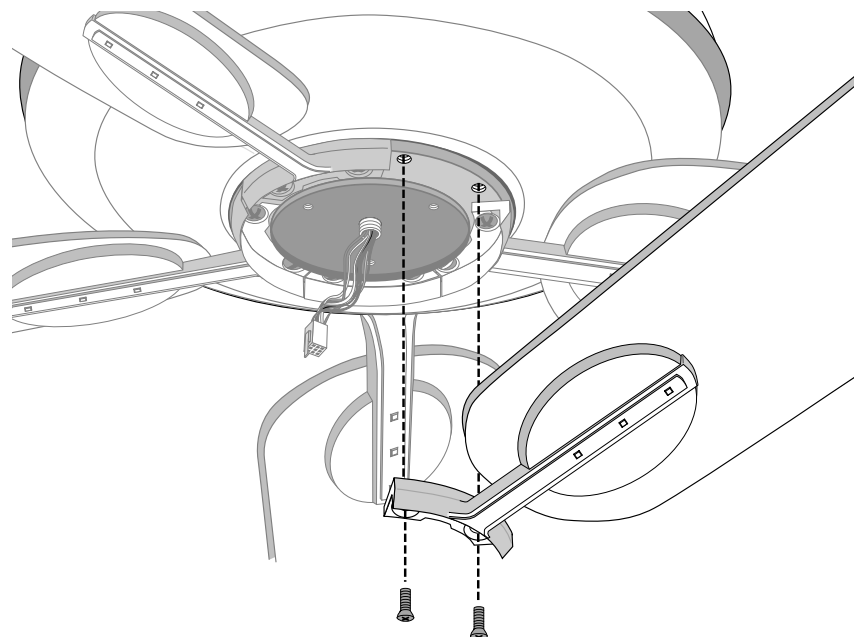

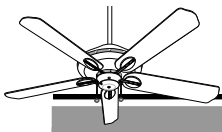

# UTOPIAN

## REMOVE SWITCH HOUSING CAP SCREWS

**Step 12.** Remove the two screws of the switch housing cap. Set the cap and screws aside for use in Step 15.

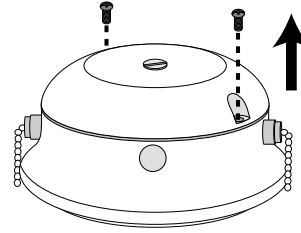

## INSTALL SWITCH HOUSING

**Step 13.** Install 2 of the 3 switch housing screws onto the fan adapter plate, leaving  $\frac{1}{8}$ " threads visible. Feed the wire connector from the fan through the center of the switch housing.

Align the 2 screws on the adapter plate with the keyhole slots of the switch housing. Raise the switch housing, pulling on the fan wire connector to assure no wires get pinched.

Turn the switch housing counter clockwise, engaging the 2 screws. Install the third screw and tighten all 3 screws.

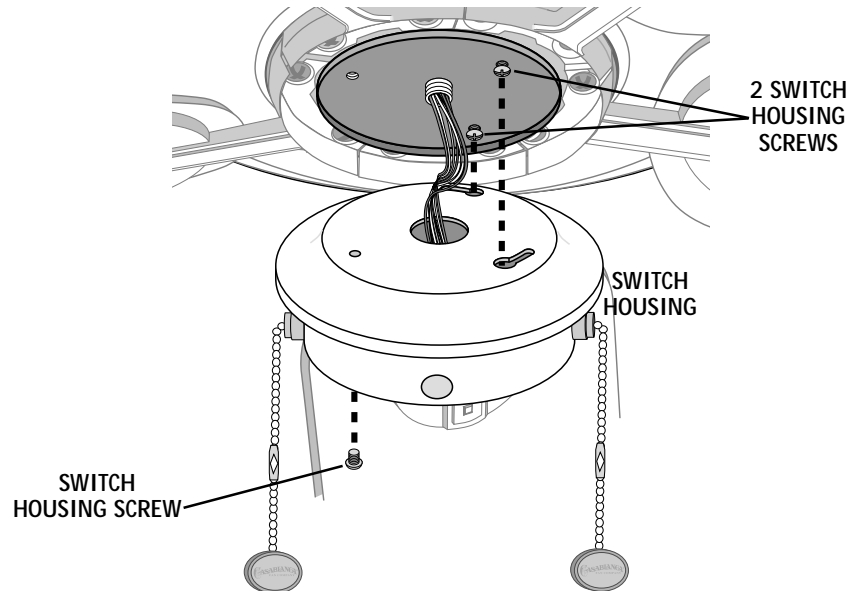

## CONNECT WIRES

**Step 14.** Plug the wire connector for the fan into the wire connector for the switch housing. Assure that the clip from the fan connector engages the notch on the switch housing connector.

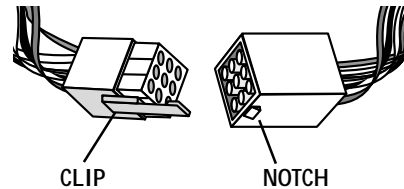

## INSTALL SWITCH HOUSING CAP SCREWS

**Step 15.** If you are installing a light fixture, please refer to the "3-Speed Optional Light Fixture Installation" on the next page.

If no light fixture is being installed, carefully push the wires and components back into the switch housing. Align the guiding pegs of the cap to the non-threaded holes of the switch housing. Reinstall the switch housing cap screws removed in Step 12.

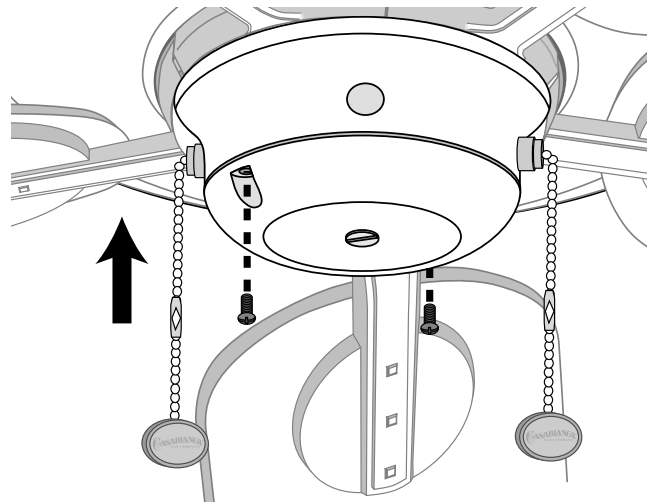



## 3-SPEED ♦ OPERATION

Pull-chain switches on the fan control the fan and lights.

Using the fan control pull-chain switch: Fan off at start.

*First pull:* fan ON, low speed

*Second pull:* medium speed

*Third pull:* high speed

*Fourth pull:* fan OFF

Using the optional light pull-chain switch: Light off at start.

*First pull:* light ON

*Second pull:* light OFF

Direction of blade rotation is controlled by the reverse pull chain on the side of the switch housing.

No changes in household wiring are required.

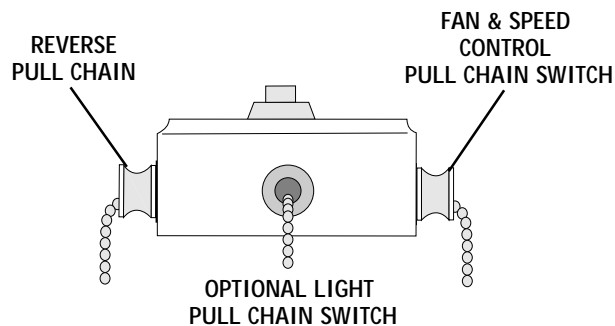

## 3-SPEED ♦ OPTIONAL LIGHT FIXTURE INSTALLATION

**NOTE:** If a separate circuit is used to control the lights from a wall control, the BLUE D1-Option wire in the canopy should be connected to that switch leg with the BLACK fan power wire.

1. Refer to light kit instructions to assemble and attach your light kit correctly.
2. Remove the two 8-32 screws from the switch housing cap.
3. Remove the plug from switch housing.
4. Install pull-chain switch and finger tighten collar on switch.
5. Connect one wire from pull-chain switch to the BLUE D1-Option wire. Secure splice with a wire nut.
6. Connect other wire from pull-chain switch to BLACK wire from light kit. Secure splice with a wire nut.
7. Connect WHITE wire from switch housing to WHITE wire from light kit. Secure splice with a wire nut.
8. At the canopy, connect the BLACK and BLUE wires.

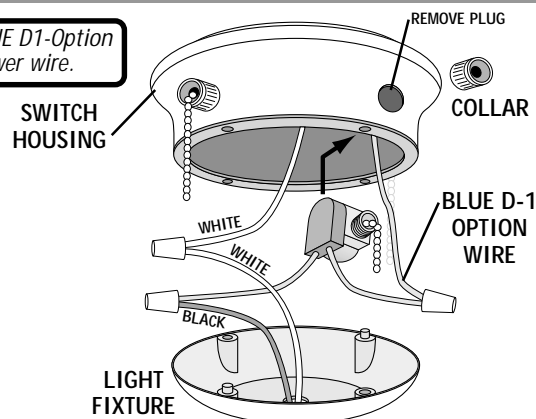

## TROUBLESHOOTING

**Before Requesting Service:** Please follow this troubleshooting guide before contacting your dealer for assistance.

**Caring for Finishes:** For cleaning, a soft brush or lint-free cloth should be used to prevent scratching the finish. A vacuum cleaner brush nozzle can remove heavier dust. Surface smudges or an accumulation of dirt and dust can easily be removed by using a mild detergent and slightly dampened soft cloth. An antistatic agent may be used, but *never* use abrasive cleaning agents. These will damage the finish. Painted and high-gloss blades may be cleaned in the same manner.

**Blades:** Wood finish blades should be cleaned with a furniture polishing cloth. Occasionally, a light coat of furniture polish may be applied for added protection and beauty.

**Never Lubricate this Fan!**

The precision motor at the heart of your Casablanca fan features sealed bearings that are lubricated for life. Do not attempt to oil the motor.

**Changing Light Bulbs**

Be sure to turn power to the fan OFF at the wall switch or circuit breaker before changing light bulbs. Replace bulbs with same type as removed from the fixture. Each fan is rated for a maximum **TOTAL** wattage of lighting.

Exceeding the rated maximum allowable wattage for the fan will burn out the fan electronics module and void the warranty.

### FAN WILL NOT START

Check main circuit fuses, circuit breakers, or wall switch position.  
Check all wire connections, making sure the power is turned off during this inspection.  
Check that reverse switch is not set in center of throw.

### FAN WOBBLER OR SHAKES EXCESSIVELY

Be sure canopy pin is properly set into the slot on the ball.  
Check the screws holding the blade holders to the flywheel (or direct drive motor). Tighten as necessary.  
Check that bladeholders have not been bent during installation.

### FAN NOISY DURING OPERATION

Check and tighten light fixture retaining screws, glass shade screws and/or the light bulb(s) as necessary.  
Tighten the blade to bladeholder screws.  
Tighten canopy screws and mounting plate assembly.  
Check and tighten blade holders to flywheel (or direct drive motor).  
Make sure all screws in the motor housing are snug, but not overly tight.  
Check that the wire nuts inside the canopy and switch housing are not touching the metal parts or have fallen off the wire splices. Tighten or adjust as necessary.

### BREAK-IN PERIOD DOES NOT RUN ON LOW SPEED

Let fan run at high speed for two (2) hours  
If new, "break-in" may be required - run at higher speed for several days

**FAN RUNS SLOWLY IN EITHER DIRECTION IF ROTATION IS STARTED BY HAND; WILL NOT REVERSE:** Defective reverse switch; defective capacitor; or open motor winding: Replace reverse switch assembly; replace PCB assembly; or replace motor unit.

**FAN WILL NOT OPERATE AT PROPER SPEEDS OR WILL NOT OPERATE AT ANY SPEED:** Defective three-speed pull-chain switch assembly; or defective capacitor: Replace three-speed pull-chain switch assembly; or replace PCB assembly.

## PRODUCT SPECIFICATIONS

**Model Name:** Utopian®

**Model Number:** 77xxD

**Dimensions:** A = 10.7"  
B = 12.22"  
C = 3"  
D = 11.2"  
E = 5.6"

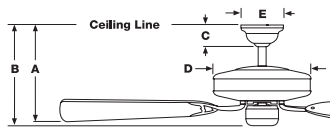

**Weight:** 25 lbs.

**Motor:** 172mm x 20mm Direct Drive™

**Blade Span With:** 50"

**Blade Pitch:** 16°

**No. of Blades:** 5

**Technology:** 3-Speed

**Airflow:** 6,152 cfm

**Electricity Use:** 80 watts

**Airflow Efficiency:** 76 cfm/watt

## Free Manuals Download Website

<http://myh66.com>

<http://usermanuals.us>

<http://www.somanuals.com>

<http://www.4manuals.cc>

<http://www.manual-lib.com>

<http://www.404manual.com>

<http://www.luxmanual.com>

<http://aubethermostatmanual.com>

Golf course search by state

<http://golfingnear.com>

Email search by domain

<http://emailbydomain.com>

Auto manuals search

<http://auto.somanuals.com>

TV manuals search

<http://tv.somanuals.com>