

EXILIM

E

Digital Camera

EX-P700

User's Guide

Thank you for purchasing this CASIO product.

- Before using it, be sure to read the precautions contained in this User's Guide.
- Keep the User's Guide in a safe place for future reference.
- For the most up-to-date information about this product, visit the official EXILIM Website at <http://www.exilim.com/>.

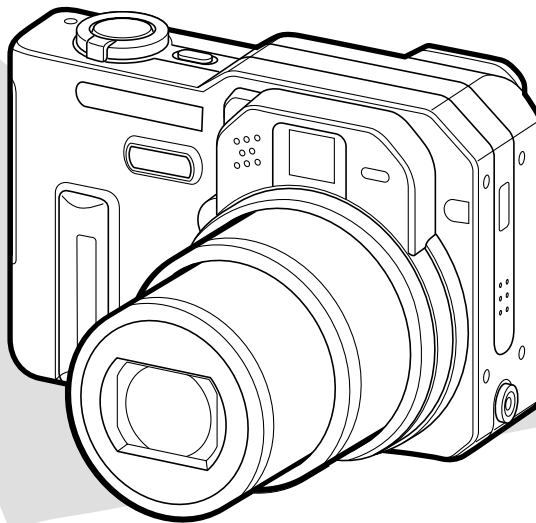

K824PCM1DMX

CASIO[®]

Download from [Www.Somanuals.com](http://www.Somanuals.com). All Manuals Search And Download.

INTRODUCTION

Unpacking

Check to make sure that all of the items shown below are included with your camera. If something is missing, contact your dealer as soon as possible.



Camera



Rechargeable Lithium Ion
Battery (NP-40)

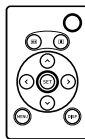

Card Remote Controller
(WR-4C)



Lithium Battery (CR2025)
• For card remote controller.

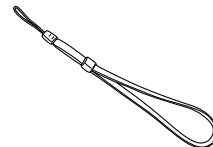

Strap



CD-ROM
(CASIO Digital Camera Software)

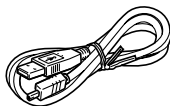

USB Cable

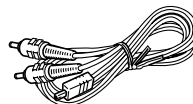

AV Cable

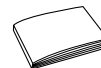

Basic Reference

• Note that the shape of the rapid charger depends on the area where you purchased the camera.

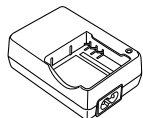

Rapid Charger (BC-30L)
(Power Cord Type)

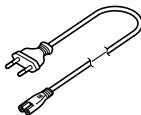

AC Power Cord *

* The shape of the AC power
cord plug varies according to
country or geographic area.

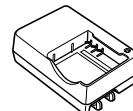

Rapid Charger (BC-30L)
(Plug-in Type)

Contents

2 INTRODUCTION

Unpacking	2
Features	11
Precautions	14
General Precautions	14
Test for proper operation before using the camera!	16
Data Error Precautions	17
Operating conditions	17
Condensation	18
Lens and Phase Differential Sensor	18
Other	18

19 QUICK START GUIDE

First, charge the battery!	19
To configure display language and clock settings	21
To record an image	22
To view a recorded image	23
To delete an image	23

24 GETTING READY

About This Manual	24
General Guide	26
Camera	26
Monitor Screen Contents	29
REC modes	29
PLAY mode	33
Changing the Contents of the Monitor Screen	34
Indicator Lamps	35
Attaching the Strap	36
Power Requirements	37
Using the Rapid Charger	37
To load the battery	41
To remove the battery	42
Power Supply Precautions	45
Using AC Power	48
Turning the Camera On and Off	50
Configuring Power Saving Settings	51
Using the On-screen Menus	52
Configuring Display Language and Clock Settings ...	54
To configure display language and clock settings	55

58 BASIC IMAGE RECORDING

Recording an Image	58
Specifying the Recording Mode	58
Aiming the Camera	59
Recording an Image	60
Recording Precautions	62
About Auto Focus	63
About the REC Mode Monitor Screen	63
Previewing the Last Image Recorded	64
To view current preview buffer contents after recording a single image	64
To delete preview buffer contents after recording a single image	65
Orientation Sensor	65
Using the Optical Viewfinder	67
Using Zoom	68
Optical Zoom	68
Digital Zoom	69
Using the Flash	71
Flash Unit Status	72
Changing the Flash Intensity Setting	73
Using Flash Assist	73
Flash Precautions	74

Using the Self-timer	75
Specifying Image Size	77
Specifying Image Quality	78

80 OTHER RECORDING FUNCTIONS

Selecting the Focus Mode	80
Using Auto Focus	81
Using the Macro Mode	84
Using the Infinity Mode	85
Using Manual Focus	85
Using Pan Focus	87
Using Focus Lock	87
Exposure Compensation (EV Shift)	88
Adjusting White Balance	90
Configuring the White Balance Setting Manually	91
Specifying the Exposure Mode	93
Using Aperture Priority AE	93
Using Shutter Speed Priority AE	94
Setting Exposure Settings Manually	96
Using Manual Assist On-screen Guidance	97
Exposure Mode Recording Precautions	98
Using Auto Exposure Lock (AE Lock)	99

INTRODUCTION

Using a Continuous Shutter Mode	100	Recording a Subject onto an Existing Background Image (Pre-shot)	119
Using the Normal Speed Continuous Shutter Mode	101	Recording Images of Business Cards and Documents (Business Shot)	121
Using the High Speed Continuous Shutter Mode	102	To use Business Shot	123
25-shot Stop Action Images (Using the Multi Continuous Shutter Mode)	103	Using the Movie Mode	124
Continuous Shutter Precautions	104	Recording Audio	126
Using Auto Bracketing	105	Adding Audio to a Snapshot	126
Using Auto Bracketing with Exposure Selected as the Variable (AE Bracketing)	106	Recording Your Voice	128
Using Auto Bracketing with White Balance as the Variable (WB Bracketing)	107	Using the Histogram	130
Using Auto Bracketing with the Focus Distance as the Variable (Focus Bracketing)	108	REC Mode Camera Settings	132
Using Auto Bracketing with Non-configurable Variables (Multi Bracketing)	109	Specifying ISO Sensitivity	133
Auto Bracketing Precautions	110	Selecting the Auto Focus (AF) Mode	134
Previewing Images Recorded with High Speed Continuous Shutter or Auto Bracketing	111	Selecting the Metering Mode	135
To view current preview buffer contents after recording multiple images	111	Using the Filter Function	136
To delete current preview buffer contents after recording multiple images	112	Specifying Outline Sharpness	136
Using the BESTSHOT Mode	113	Specifying Color Saturation	137
Creating Your Own BESTSHOT Setup	115	Specifying Contrast	137
Combining Shots of Two People into a Single Image (Coupling Shot)	117	Turning the On-screen Grid On and Off	138
		Turning Image Review On and Off	138
		Using Icon Help	139
		Assigning Functions to the [◀] and [▶] Keys	140
		Specifying Power On Default Settings	141
		Resetting the Camera	143

INTRODUCTION

Using the Shortcut Menu (EX Menu)	143
Using the Card Remote Controller for Recording ...	144
Loading the Battery	145
Before Using the Card Remote Controller for Recording	146
Using the Card Remote Controller	147
Using an External Flash	149
External Flash Unit Requirements	149
Before Using an External Flash Unit	150
Using an External Flash Unit	151
External Flash Precautions	152
Using a Conversion Lens or Filter	153
Installing a Conversion Lens or Close-up Lens	154
Installing a Filter	156

157 PLAYBACK

Basic Playback Operation	157
Playing an Audio Snapshot	158
Zooming the Display Image	159
Resizing an Image	160
Cropping an Image	161
Checking the Focus of a Recorded Image	163

Playing a Movie	164
Displaying the 9-image View	165
Selecting a Specific Image in the 9-image View	166
Displaying the Calendar Screen	166
Playing a Slideshow	167
To specify the slideshow images	169
To specify the slideshow time	170
To set the slideshow interval	170
Rotating the Display Image	171
Using Image Roulette	172
Adding Audio to a Snapshot	173
To re-record audio	174
Playing Back a Voice Recording File	175
Displaying Camera Images on a TV Screen	176
Selecting the Video Input System	177

178 DELETING FILES

Deleting a Single File	178
Deleting All Files	179

INTRODUCTION

180 FILE MANAGEMENT

Folders	180
Memory Folders and Files	180
Protecting Files	181
To protect a single file	181
To protect all files in memory	182
Using the FAVORITE Folder	182
To copy a file to the FAVORITE folder	182
To display a file in the FAVORITE folder	184
To delete a file from the FAVORITE folder	185
To delete all files from the FAVORITE folder	185

186 OTHER SETTINGS

Configuring Sound Settings	186
To configure sound settings	186
To set the volume level	187
Specifying an Image for the Startup Screen	187
Configuring Power Down Image Settings	188
Specifying the File Name Serial Number Generation Method	190
Using the Alarm	191
To set an alarm	191
Stopping the Alarm	192

Setting the Clock	192
To select your Home Time zone	192
To set the current time and date	193
Changing the Date Format	194
Using World Time	194
To display the World Time screen	194
To configure World Time settings	195
To configure summer time (DST) settings	196
Changing the Display Language	197
Changing the USB Port Protocol	197
Formatting Built-in Memory	198

200 USING A MEMORY CARD

Using a Memory Card	201
To insert a memory card into the camera	201
To remove a memory card from the camera	202
To format a memory card	202
Memory Card Precautions	203
Copying Files	204
To copy all the files in built-in memory to a memory card	204
To copy a specific file from a memory card to built-in memory	205

INTRODUCTION

206 PRINTING IMAGES

DPOF	207
To configure print settings for a single image	208
To configure print settings for all images	209
Using PictBridge or USB DIRECT-PRINT	210
To print a single image	210
To print a group of images	213
Printing Precautions	214
PRINT Image Matching III	215
Exif Print	215

216 VIEWING IMAGES ON A COMPUTER

Using the Camera with a Windows Computer	216
USB Connection Precautions	222
Using the Camera with a Macintosh Computer	222
USB Connection Precautions	226
Operations You Can Perform from Your Computer ..	226
Using a Memory Card to Transfer Images to a Computer	227
Memory Data	228
DCF Protocol	228
Memory Folder Structure	228

Image Files Supported by the Camera	230
Built-in Memory and Memory Card Precautions	231

232 USING THE CAMERA WITH A COMPUTER

Using the Album Feature	232
Creating an album	232
Selecting an Album Layout	234
Configuring Detailed Album Settings	234
Viewing Album Files	237
Saving an Album	239
To delete an album	240
Installing the Software from the CD-ROM	240
About the bundled CD-ROM (CASIO Digital Camera Software)	240
Computer System Requirements	242
Installing Software from the CD-ROM in Windows	243
Getting Started	244
Selecting a Language	244
Viewing the Contents of the "Read me" File	244
Installing an Application	245
Viewing User Documentation (PDF Files)	245
User Registration	246
Exiting the Menu Application	246

INTRODUCTION

Installing Software from the CD-ROM on a Macintosh	246
Installing Software	246
Viewing User Documentation (PDF Files)	247

249 APPENDIX

Menu Reference	249
Indicator Lamp Reference	252
REC modes	252
PLAY mode	253
Rapid Charger	254
Troubleshooting Guide	255
If you have problems installing the USB driver...	259
Display Messages	260
Specifications	262

▶▶ IMPORTANT! ◀◀

- The contents of this manual are subject to change without notice.
- CASIO COMPUTER CO., LTD. assumes no responsibility for any damage or loss resulting from the use of this manual.
- CASIO COMPUTER CO., LTD. assumes no responsibility for any loss or claims by third parties which may arise through the use of the EX-P700.
- CASIO COMPUTER CO., LTD. shall not be held liable for any damages or losses suffered by you or any third party due to the use of Photo Loader and/or Photohands.
- CASIO COMPUTER CO., LTD. assumes no responsibility for any damage or loss caused by deletion of data as a result of malfunction, repairs, or battery replacement. Be sure to back up all important data on other media to protect against its loss.
- Note that the example screens and product illustrations shown in this User's Guide may differ somewhat by the screens and configuration of the actual camera.
- *The SD logo is a registered trademark.*
- *Windows, Internet Explorer, and DirectX are registered trademarks of Microsoft Corporation.*
- *Macintosh is a registered trademark of Apple Computer, Inc.*

INTRODUCTION

- *MultiMediaCard* is a trademark of Infineon Technologies AG of Germany, and licensed to the MultiMediaCard Association (MMCA).
- *Adobe* and *Reader* are either registered trademarks or trademarks of Adobe Systems Incorporated in the United States and/or other countries.
- Other company, product and service names used herein may also be trademarks or service marks of others.
- *Photo Loader* and *Photohands* are the property of CASIO COMPUTER CO., LTD. Except as stipulated above, all copyrights and other related rights to these applications revert to CASIO COMPUTER CO., LTD.

■ Copyright Restrictions

Except for the purpose of your own personal enjoyment, unauthorized copying of snapshot files, movie files, and audio files violates copyright laws and international contracts.

Distribution to third parties of such files over the Internet without permission of the copyright holder, whether for profit or for free, violates copyright laws and international contracts.

Features

- 7.2 million effective pixels
The CCD provides 7.41 million total pixels of very high-resolution for crisp, clear, prints and display images.
- 2.0-inch TFT color LCD monitor screen
- Long battery life
A low-power design combines with a large-capacity battery to provide more recording and playback between charges.
- 16X zoom (page 68)
4X optical zoom, 4X digital zoom
- 8.9MB flash memory
Images can be recorded without using a memory card.
- High-speed, high-precision Auto Focus
A phase differential sensor combines with contrast Auto Focus for faster focusing.
- Three continuous shutter modes (page 100)
In addition to normal continuous shutter operation that can continually record shots as long as memory is available, you can also use high-speed continuous shutter and stop-action continuous shutter, which records a series of shots in a single image.
- Four auto bracketing modes (page 105)
Configurable variables can be set up to record multiple versions of an image altering the exposure, white balance, or focus distance setting. Non-configurable variables create multiple versions of the same image using various filters and other settings.
- Ex Finder view (page 32)
The Ex Finder view provides you with a wealth of information on the monitor screen as you compose your images.
- Ex Menu (page 143)
Ex Menu gives you short-cut menu access to four frequently-used settings.
- Multi Auto Focus (page 82)
When "Multi" is selected for the Auto Focus area, the camera takes simultaneous meter readings at seven different points and automatically selects the best one. This avoids unintended auto focusing on the background, which can cause foreground subject to be out of focus.
- Movable Auto Focus (AF) Area (page 82)
You can move the focus area to the location you want.
- Support for SD memory cards and MMC (MultiMedia Cards) for memory expansion (page 201)

INTRODUCTION

- **Manual Assist (page 97)**
Follow the on-screen guidance when configuring manual exposure settings.
- **AE Lock (page 99)**
A simple operation locks exposure on a particular subject, helping to ensure that the image is focused the way you want.
- **BESTSHOT (page 113)**
Simply select the sample scene that matches the type of image you are trying to record and the camera performs troublesome setups automatically for beautiful pictures every time.
- **Business Shot (page 121)**
Business Shot automatically corrects rectangular shapes when recording the image of a business card, document, whiteboard, or similar subjects from an angle.
- **Coupling Shot and Pre-shot (pages 117, 119)**
Coupling Shot lets you combine two subjects into a single image, while Pre-shot lets you add a subject to a previously recorded background image. This means you can create images that include you and your friend, even if you are the only two people around.
- **Triple Self-timer (page 75)**
The self-timer can be set up to repeat three times, automatically.
- **Real-time RGB histogram (page 130)**
An on-screen histogram lets you adjust exposure as you view the effect on overall image brightness, which makes shooting under difficult lighting conditions easier than ever before.
- **World Time (page 194)**
A simple operation sets the current time for your current location. You can select from among 162 cities in 32 time zones.
- **Alarm (page 191)**
A built-in alarm helps to keep you on time for important events, and even can be used in place of an alarm clock. You can also have a specific image appear, or a movie or audio file to play when the alarm time is reached.
- **Album Function (page 232)**
HTML files are generated automatically to create an album of recorded images. Album contents can be viewed and printed using a standard Web browser. Images can also be incorporated into Web pages quickly and easily.
- **Calendar screen (page 166)**
A simple operation displays a full-month calendar on the camera's monitor screen. Each day of the full-month calendar shows a thumbnail of the first image recorded for that date, which helps to make searching for a particular image quicker and easier.

INTRODUCTION

- Audio Snapshot mode (page 126)
Use this mode to record snapshots that also include audio.
- Movie + Audio mode (page 124)
- Voice recording (page 128)
Quick and easy recording of voice input.
- After Recording (page 173)
Use this mode to add audio to snapshots after you record them.
- Selectable Sound Settings (page 186)
You can configure different sounds to play whenever you turn on the camera, press the shutter button half-way or all the way, or perform a key operation.
- Card remote controller (page 144)
- External flash connectability (page 149)
- Conversion lens/close-up lens support (page 153)
Use of a conversion lens enhances telephoto and wide angle shots, while the close-up lens enhances macro shots.
- DCF Data Storage (page 228)
DCF (Design rule for Camera File system) data storage protocol provides image compatibility between the digital camera and printers.
- Digital Print Order Format (DPOF) (page 207)
Images can be printed easily in the sequence you want using a DPOF compatible printer. DPOF can also be used when specifying images and quantities for printing by professional print services.
- PRINT Image Matching III Compatible (page 215)
Images include PRINT Image Matching III data (mode setting and other camera setup information). A printer that supports PRINT Image Matching III reads this data and adjusts the printed image accordingly, so your images come out just the way you intended when you recorded them.
- USB DIRECT-PRINT and PictBridge support (page 210)
Connect directly to a USB DIRECT-PRINT or PictBridge compatible printer and you can print images without going through a computer.
- Transfer images to a computer simply by connecting the camera with a USB cable (page 216).
- Connect the camera to a TV with the AV cable and use the TV screen for image recording and viewing (page 176).

INTRODUCTION

- Photo Loader and Photohands (page 241)
Your camera comes bundled with Photo Loader, the popular application that automatically loads images from your camera to your PC. It also comes with Photohands, and application that makes image retouching quick and easy.

Precautions

General Precautions

Be sure to observe the following important precautions whenever using the EX-P700.

All references in this manual to “camera” refer to the CASIO EX-P700 Digital Camera.

- Never try to take pictures or use the built-in display while operating a motor vehicle or while walking. Doing so creates the risk of serious accident.
- Never try to open the case of the camera or attempt your own repairs. High-voltage internal components create the risk of electric shock when exposed. Always leave maintenance and repair work up to a CASIO authorized service center.
- Never look at the sun or any other bright light through the camera’s viewfinder. Doing so can damage your eyesight.
- Keep the small parts and accessories of this camera out of the reach of small children. If swallowed accidentally, contact your physician immediately.
- Never fire the flash in the direction of a person operating a motor vehicle. Doing so can interfere with the driver’s vision and create the risk of accident.

INTRODUCTION

- Never fire the flash while it is too close to the subject's eyes. Intense light from the flash can cause eye damage if it is fired too close to the eyes. This is especially true with young children. When using the flash, the camera should be at least one meter (3.3') from the eyes of the subject.
- Keep the camera away from water and other liquids, and never let it get wet. Moisture creates the risk of fire and electric shock. Never use the camera outdoors in the rain or snow, at the seashore or beach, in the bathroom, etc.
- Should foreign matter or water ever get into the camera, immediately turn it off. Next, remove the camera's battery and/or unplug the AC adaptor power cord from the power outlet, and contact your dealer or nearest CASIO authorized service center. Using the camera under these conditions creates the risk of fire and electric shock.
- Should you ever notice smoke or a strange odor coming out of the camera, immediately turn it off. Next, taking care you do not burn your fingers, remove the camera's battery and/or unplug the AC adaptor power cord from the power outlet, and contact your dealer or nearest CASIO authorized service center. Using the camera under these conditions creates the risk of fire and electric shock. After making sure there is no more smoke coming from the camera, take it to your nearest CASIO authorized service center for repair. Never attempt your own maintenance.
- Never use the AC adaptor to power any other device besides this camera. Never use any other AC adaptor besides the one that comes with this camera.
- Never cover the AC adaptor with a quilt, blanket, or other cover while it is in use, and do not use it near a heater.
- At least once a year, unplug the AC adaptor power cord from the power outlet and clean the area around the prongs of the plug. Dust build up around the prongs can create the risk of fire.
- If the camera's case should ever become cracked due to dropping it or otherwise subjecting it to rough treatment, immediately turn it off. Next, remove the camera's battery and/or unplug the AC adaptor power cord from the power outlet, and contact your dealer or nearest CASIO authorized service center.
- Never use the camera inside of an aircraft or in any other area where its use is prohibited. Doing so creates the risk of accident.
- Physical damage and malfunction of this camera can cause the data stored in its memory to be deleted. Always keep backup copies of data by transferring them to personal computer memory.

INTRODUCTION

- Never open the battery cover, disconnect the AC adaptor from the camera, or unplug the AC adaptor from the wall socket while an image is being recorded. Doing so will not only make storage of the current image impossible, it can also corrupt other image data already stored in file memory.

Test for proper operation before using the camera!

- Before using the camera to record important images, make sure you first record a number of test images and check the results to ensure that the camera is configured correctly and operating properly (page 19).

Data Error Precautions

- Your digital camera is manufactured using precision digital components. Any of the following creates the risk of corruption of data in file memory.
 - Removing the battery or memory card while the camera is performing a record or memory access operation
 - Removing the battery or memory card while the operation lamp is still flashing after you turn off the camera
 - Disconnecting the USB cable while a data communication operation is being performed
 - Low battery power
 - Other abnormal operations

Any of the above conditions can cause an error message to appear on the monitor screen (page 260). Follow the instructions provided by the message to eliminate the cause of the error.

Operating conditions

- This camera is designed for use in temperatures ranging from 0°C to 40°C (32°F to 104°F).
- Do not use or keep the camera in the following areas.
 - In areas subject to direct sunlight
 - In areas subject to high humidity or dust
 - Near air conditioners, heaters, or other areas subject to temperature extremes
 - Inside of a closed vehicle, especially one parked in the sun
 - In areas subject to strong vibration

Condensation

- When you bring the camera indoors on a cold day or otherwise expose it to a sudden change of temperature, there is the possibility that condensation can form on the exterior or on interior components. Condensation can cause malfunction of the camera, so you should avoid exposing it to conditions that might cause condensation.
- To keep condensation from forming, place the camera into a plastic bag before moving it into a location that is much warmer or colder than your current location. Leave it in the plastic bag until the air inside the bag has a chance to reach the same temperature as the new location. If condensation does form, remove the battery from the camera and leave the battery cover open for a few hours.

Lens and Phase Differential Sensor

- Never apply too much force when cleaning the surface of the lens and phase differential sensor. Doing so can scratch the lens and phase differential sensor surface and cause malfunction.
- Fingerprints, dust, or any other soiling of the lens and phase differential sensor can interfere with proper image recording. Never touch the lens and phase differential sensor with your fingers. You can remove dust particles from the lens and phase differential sensor surface by using a lens blower to blow them off. Next, wipe the surface of the lens and phase differential sensor with a soft lens cloth.
- When aiming the camera, make sure that your finger does not block the phase differential sensor.

Other

- The camera may become slightly warm during use. This does not indicate malfunction.
- If the exterior of the camera needs cleaning, wipe it with a soft, dry cloth.

QUICK START GUIDE

First, charge the battery!

1. Charge the rechargeable lithium ion battery (NP-40) that comes with the camera (page 37).

- Note that the shape of the rapid charger depends on the area where you purchased the camera.
- It takes about two hours to achieve a full charge.

1

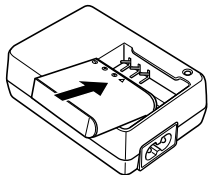

2

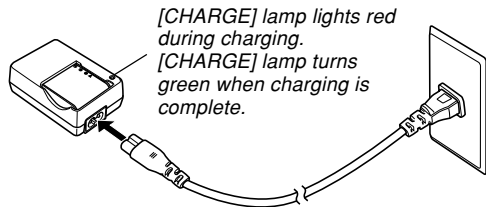

*[CHARGE] lamp lights red during charging.
[CHARGE] lamp turns green when charging is complete.*

Power Cord Type

1

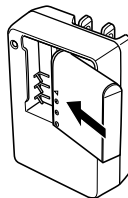

2

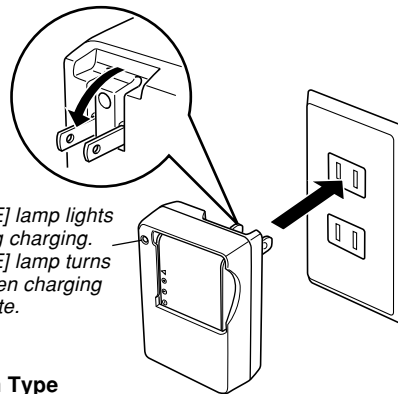

*[CHARGE] lamp lights red during charging.
[CHARGE] lamp turns green when charging is complete.*

Plug-in Type

2. Load the battery into the camera. (page 41).

1

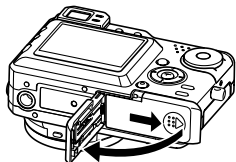

3

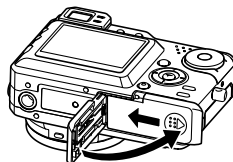

2

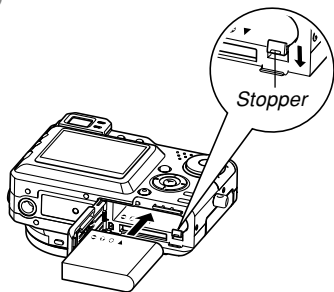

To configure display language and clock settings

- Be sure to configure the following settings before using the camera to record images. See page 54 for details.

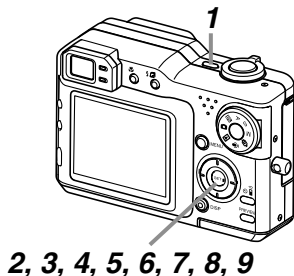

1. Press the power button to turn on the camera.
2. Press [▲] to select the language you want.
3. Press [SET] to register the language setting.
4. Use [▲], [▼], [◀], and [▶] to select the geographical area you want, and then press [SET].
5. Use [▲] and [▼] to select the city you want, and then press [SET].
6. Use [▲] and [▼] to select the summer time (DST) setting you want, and then press [SET].
7. Use [▲] and [▼] to select the date format setting you want, and then press [SET].
8. Set the date and the time.
9. Press [SET] to register the clock settings and exit the setting screen.

To record an image

See page 58 for details.

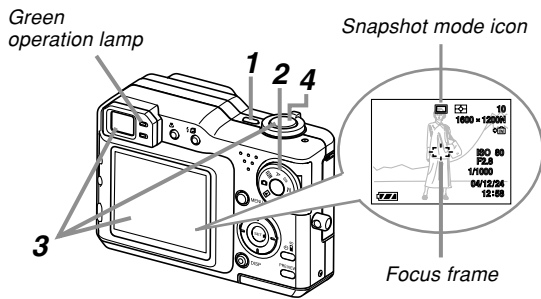

- 1. Press the power button to turn on the camera.**
- 2. Align the mode dial with  (Snapshot mode).**
- 3. Point the camera at the subject, use the monitor screen or viewfinder to compose the image, and then press the shutter button half way.**
 - When proper focus is achieved, the focus frame turns green and the green operation lamp lights.
- 4. Holding the camera still, gently press the shutter button all the way down.**

To view a recorded image

See page 157 for details.

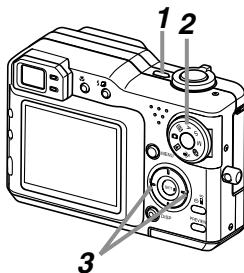



1. Press the power button to turn on the camera.
2. Align the mode dial with  (PLAY mode).
3. Use [**◀**] and [**▶**] to scroll through the images.

To delete an image

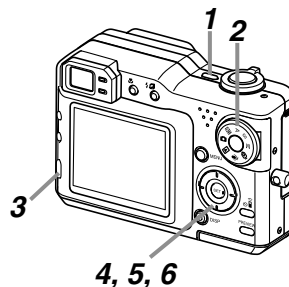
See page 178 for details.



1. Press the power button to turn on the camera.
2. Align the mode dial with  (PLAY mode).
3. Press [EX ].
4. Use [**◀**] and [**▶**] to display the image you want to delete.
5. Use [**▲**] and [**▼**] to select “Delete”.
 - To exit the image delete operation without deleting anything, select “Cancel”.
6. Press [SET] to delete the image.

GETTING READY

This section contains information about things you need to know about and do before trying to use the camera.

About This Manual

This section contains information about the conventions used in this manual.

■ Terminology

The following table defines the terminology used in this manual.

This term as used in this manual:	Means this:
"camera"	The CASIO EX-P700 Digital Camera
"file memory"	The location where the camera is currently storing images you record (page 60)
"battery"	The NP-40 Rechargeable Lithium Ion Battery
"rapid charger"	The CASIO BC-30L Rapid Charger

This term as used in this manual:	Means this:
"a REC mode"	The currently selected recording mode (Snapshot, BESTSHOT, Aperture Priority AE, Shutter Speed Priority AE, Manual Exposure, Movie, Voice Recording)
"digital noise"	Tiny flecks or "snow" in a recorded image or on the monitor screen, which makes the image look grainy.

■ Button Operations

Button operations are indicated by the button name inside of brackets ([]).

■ On-screen Text

On-screen text is always enclosed by double quotation marks (“ ”).

■ File Memory

The term “file memory” in this manual is a general term that refers to the location where your camera is currently storing the images you record. File memory can be any one of the following three locations.

- The camera’s built-in flash memory
- An SD memory card loaded in the camera
- A MultiMediaCard loaded in the camera

For more information about how the camera stores images, see page 228.

General Guide

The following illustrations show the names of each component, button, and switch on the camera.

Camera

■ Front

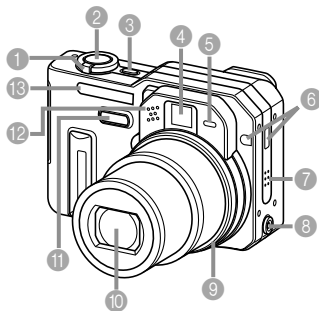

- 1 Zoom controller
- 2 Shutter button
- 3 Power button
- 4 Viewfinder
- 5 Self-timer lamp
- 6 Remote control signal receiver
- 7 Speaker
- 8 External flash sync terminal
- 9 Lens ring

- Be sure to reinstall the lens ring on the camera lens when you are not using a conversion lens. Optical zoom is possible only up to about 2X while the lens ring is not installed properly.

- 10 Lens
- 11 Phase differential sensor
- 12 Microphone
- 13 Flash
- 14 [DC IN](AC adaptor connector)
- 15 [USB/AV](USB/AV port)
- 16 Terminal panel cover

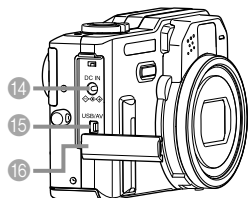

Open Terminal Panel Cover

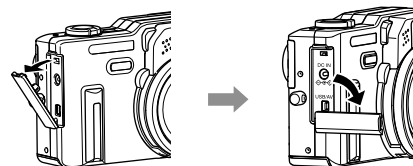

■ Back

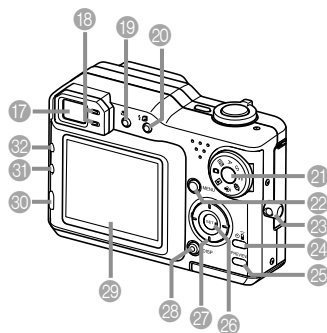

- 17 Viewfinder
- 18 Operation lamp
- 19 [F] (Focus) button
- 20 [Flash / Calendar] button
- 21 Mode dial
 - [▶] : PLAY mode
 - [📷] : Snapshot mode
 - [BS] : BESTSHOT mode
 - A : Aperture Priority AE mode
 - S : Shutter Speed Priority AE mode
 - M : Manual Exposure mode
 - [🎥] : Movie mode
 - [🎤] : Voice Recording mode
- 22 [MENU] button
- 23 Strap ring
- 24 [⏱] (Self-timer / Remote Controller) button
- 25 [PREVIEW] button
- 26 [SET] button
- 27 [▲][▼][◀][▶]
- 28 [DISP] button
- 29 Monitor Screen
- 30 [EX] (EX/Delete) button
- 31 [AE-L] (AE Lock) button
- 32 [BKT] (Continuous Shutter/ Auto Bracketing) button

REC modes

GETTING READY

■ Bottom

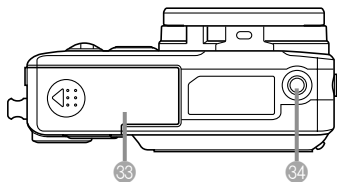

33 Battery cover

34 Tripod screw hole

- Use this hole when attaching to a tripod.

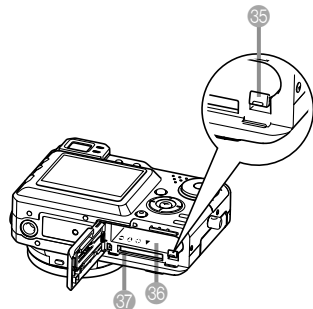

35 Stopper

36 Battery compartment

37 Memory card slot

Monitor Screen Contents

The monitor screen uses various indicators and icons to keep you informed of the camera's status.

- Note that the example screens in this chapter are for illustrative purposes only. They do not exactly match the screen contents actually produced on the camera.

REC modes

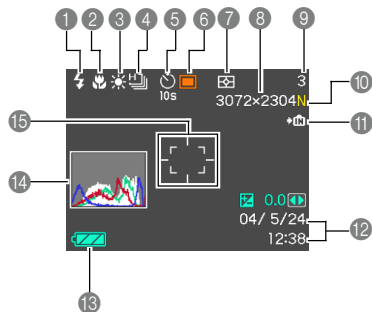

1 Flash mode indicator (page 71)

- None
- Auto
- Flash Off
- Flash On
- Red Eye Reduction

- If the camera detects that flash is required while auto flash is selected, the flash on indicator will appear when the shutter button is pressed half way.

2 Focus mode indicator (page 80)

- None
- Auto Focus
- Macro
- PF Pan Focus
- ∞ Infinity
- MF Manual Focus

- **PF** (Pan Focus) appears in the Movie mode only.

3 White balance indicator (page 90)

- None
- Auto
- Daylight
- Cloudy
- Shade
- Fluorescent 1
- Fluorescent 2
- Tungsten
- Flash
- Manual

4 Continuous shutter/auto bracketing mode (pages 100, 105)

- Single Shot
- High Speed Continuous Shutter
- Normal Speed Continuous Shutter
- Multi Continuous Shutter







- AEB** AE Bracketing
- WBB** WB Bracketing
- AFB** Focus Bracketing
- MB** Multi Bracketing

5 Self-timer/Remote controller mode (pages 75, 146)



- None
- 1 Shot
- 10s 10-second Self-timer
- 2s 2-second Self-timer
- x3 Triple Self-timer
- Remote controller
- Remote controller and 2-second Self-timer

GETTING READY

6 Recording mode (page 58)

-  Snapshot
-  BESTSHOT
-  Aperture Priority AE
-  Shutter Speed Priority AE
-  Manual Exposure
-  Movie
-  Voice Recording

7 Metering mode indicator (page 135)

-  Multi
-  Center Weighted
-  Spot

8 Image size (page 77)

- 3072 × 2304 pixels
 - 3072 × 2048 (3:2) pixels
 - 2304 × 1728 pixels
 - 1600 × 1200 pixels
 - 1280 × 960 pixels
 - 640 × 480 pixels
- Movie Recording: recording time



9 Memory Capacity (pages 124, 262)

(Remaining number of storable images)
Movie Recording: Remaining recording time

10 Image quality (page 78)

F : FINE
N : NORMAL
E : ECONOMY
T : TIFF

11 Memory indicator (page 201)

-  Built-in memory selected for data storage.
-  Memory card selected for data storage.

12 Date and time (page 192)

13 Battery capacity (page 45)

14 Histogram (page 130)

15 Focus frame (page 61)

- Focused: Green
- Unfocused: Red

NOTE

- Changing the setting of any one of the following functions will cause Icon Help text to appear on the monitor screen. You can turn off Icon Help if you want (page 139).
Recording mode, flash mode, focus mode, white balance, self-timer/remote controller mode, metering mode

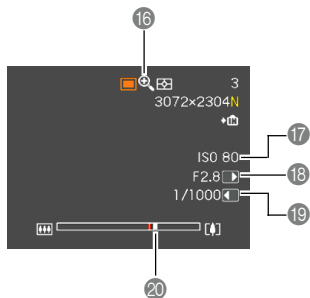

- 16 Digital zoom indicator (page 69)
- 17 ISO sensitivity (page 133)
- 18 Aperture value (pages 93, 96)
- 19 Shutter speed value (pages 94, 96)
 - An out of range ISO sensitivity, aperture, or shutter speed setting causes the corresponding monitor screen value to turn amber.
- 20 Zoom indicator (page 69)
 - Left side indicates optical zoom.
 - Right side indicates digital zoom.

■ Exposure Panel

The exposure panel is an area in the lower right corner of the REC modes monitor screen that shows various adjustable parameters. You can also use the exposure panel to adjust exposure settings.

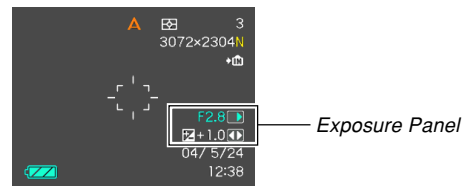

- The following explains the items that appear on the exposure panel. Note that the current REC mode determines which items appear.

- 1 Aperture value (pages 93, 96)
 - Use this item to adjust the aperture.
 - The aperture value is displayed in the exposure panel when the mode dial is set to "A" (aperture priority AE) or "M" (manual exposure).

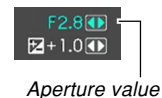

GETTING READY

- 2 Shutter speed (pages 94, 96)
Use this item to adjust the shutter speed.
- The shutter speed is displayed in the exposure panel when the mode dial is set to “S” (shutter speed priority AE) or “M” (manual exposure).

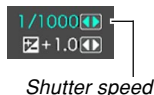

- 3 EV shift (exposure compensation value) (page 88)
Use this item to adjust the exposure compensation (EV shift) value.
- The EV shift value is displayed in the exposure panel when the mode dial is set to “” (snapshot), “BS” (BESTSHOT), “A” (aperture priority AE), or “S” (shutter speed priority AE).



- 4 Manual Focus (MF) setting (page 85)
Use this item for adjust focus manually.
- The manual focus setting item is displayed in the exposure panel when manual focus is selected (indicated by “MF” on the monitor screen) using .



Ex Finder View

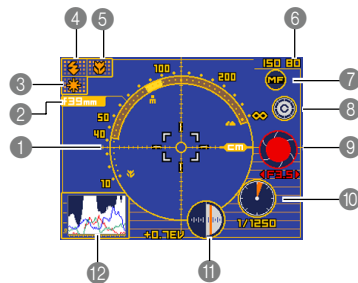

- 1 Focus distance scale (page 263)
- This scale indicates the focus distance range. Note that this scale is not intended for precision measurement. It is provided as a general guide only.
 - The focus distance scale may not appear when any one of the following conditions exists.
 - When “Contrast” is selected as the Auto Focus (AF) mode (page 134)
 - When “Hybrid” is selected as the Auto Focus (AF) mode (page 134) and Macro is selected as the focus mode (page 80)
 - Conditions that are so dark or so bright that distance measurement is impossible
 - When “Free” is selected as the Auto Focus Area (AF Area) mode (page 82)

GETTING READY

- 2 Focal distance (page 263)
- 3 White balance indicator (page 90)
- 4 Flash mode indicator (page 71)
- 5 Focus mode indicator (page 80)
- 6 ISO sensitivity (page 133)
- 7 Manual focus icon
 - This icon is displayed only when “MF (Manual Focus)” is selected as the focus mode.
 - If you use [▲] and [▼] to move the cursor to “MF” and then press [◀] or [▶], the Ex Finder view will disappear and the manual focus position indicator (page 85) will appear. After a few moments, the Ex Finder view will reappear.
- 8 Color change icon
 - Use [▲] and [▼] to move the cursor to “C” and then press [◀] or [▶] to change the color of the Ex Finder view.
- 9 Aperture value (pages 93, 96)
- 10 Shutter speed (pages 94, 96)
 - ISO sensitivity, aperture, and shutter speed values on the monitor screen will turn amber when you press the shutter button half way if the image is over-exposed or under-exposed.
- 11 EV shift (exposure compensation value) (page 88)
- 12 Histogram (page 130)

PLAY mode

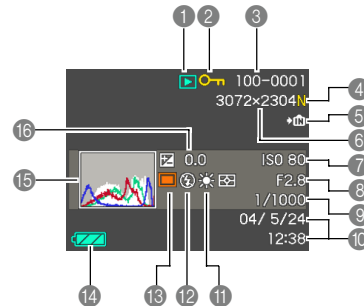



- 1 **PLAY mode file type**
 - Snapshot
 - Movie
 - Audio Snapshot
 - Voice Recording
- 2 **Image protection indicator (page 181)**
- 3 **Folder number/File number (page 180)**

Example : When a file named CIMG0023.JPG is stored in a folder named 100CASIO

100-0023	
Folder name	File name
- 4 **Image quality (page 78)**

F : FINE
N : NORMAL
E : ECONOMY
T : TIFF

GETTING READY

- 5  Built-in memory selected for data storage.
 Memory card selected for data storage.
(page 201)

6 Image size (page 77)

3072 × 2304 pixels
3072 × 2048 (3:2) pixels
2304 × 1728 pixels
1600 × 1200 pixels
1280 × 960 pixels
640 × 480 pixels

Movie Playback: Elapsed play time

7 ISO sensitivity (page 133)

8 Aperture value
(pages 93, 96)

9 Shutter speed value
(pages 94, 96)

10 Date and time (page 192)

11 White balance indicator
(page 90)

 Auto

 Daylight

 Cloudy

 Shade

 Fluorescent 1

 Fluorescent 2

 Tungsten

 Flash

 Manual

12 Flash mode indicator
(page 71)

 Flash On

 Flash Off

 Red-eye reduction

13 Recording mode
(page 58)

 Snapshot

 BESTSHOT

 Aperture Priority AE

 Shutter Speed Priority AE

 Manual Exposure

14 Battery capacity
(page 45)

15 Histogram (page 130)

16 EV value (page 88)

Changing the Contents of the Monitor Screen

Each press of [DISP] cycles the contents of the monitor screen as shown below.

■ REC modes

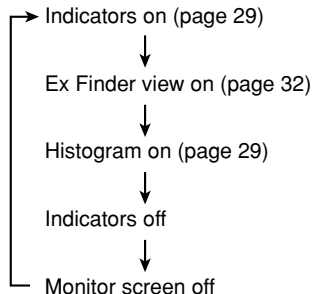

■ PLAY mode

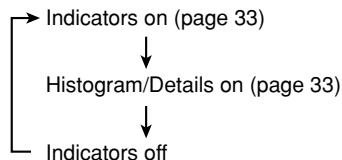

►► IMPORTANT! ◀◀

- The Ex Finder view cannot be displayed in the following modes: PLAY, Coupling Shot, Pre-shot, Movie.
- You cannot turn off the monitor screen in the following modes: PLAY, BESTSHOT, Movie (standby).
- Pressing [DISP] will not change monitor screen contents during movie recording, or during standby or recording of an audio snapshot.
- The only display options that appear when you press [DISP] in the Coupling Shot is “Indicators on” and “Monitor screen off”.
- Pressing [DISP] in the Voice Recording REC mode toggles the monitor screen on (“indicators on”) and off. While a Voice Recording file is displayed in the PLAY mode, pressing [DISP] toggles between “indicators on” and “indicators off”.
- When playing back the contents of a Voice Recording file while “indicators off” is selected (Voice Recording file icon only on the monitor screen), the monitor screen will go black about two seconds after you press [SET] to start playback. The Voice Recording file icon (indicators off) will reappear after playback is complete.

Indicator Lamps

You can find out the operational status of the camera at a glance by checking the color of the indicator lamps, and whether a lamp is lit or flashing. For details, see “Indicator Lamp Reference” on page 252.

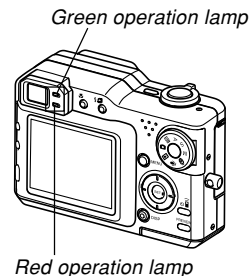
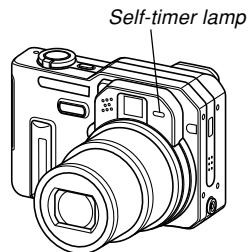

Attaching the Strap

Attach the strap to the strap ring as shown in the illustration.

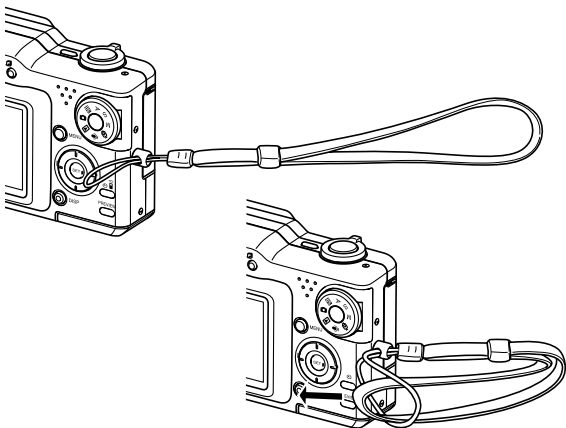

►► IMPORTANT! ◀◀

- To avoid dropping the camera while operating it, be sure to wear the strap around your wrist. Use the buckle to ensure that the strap is fastened snugly around your wrist.
- The supplied strap is intended for use with this camera only. Do not use it for any other purpose.
- Never swing the camera around by the strap.

GETTING READY

Power Requirements

Your camera can operate on either battery power or AC power.

- Battery
One NP-40 rechargeable lithium ion battery

The battery is not charged when you purchase the camera. You need to charge the battery before using the camera for the first time.

- Household AC Power
AC Adaptor: AD-C40 (Option)

Using the Rapid Charger

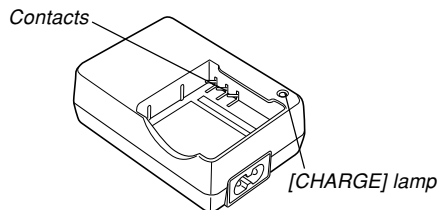

■ Loading the Battery into the Rapid Charger

Making sure that the positive and negative contacts are aligned correctly, load the battery into the rapid charger. Note that the battery will not charge properly if it is not positioned correctly in the rapid charger.

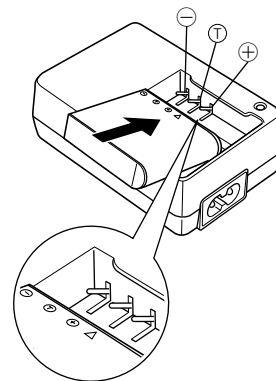

■ To charge the battery

1. Correctly positioning the positive and negative terminals of the battery, load the battery into the rapid charger.

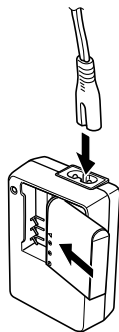

Power Cord Type

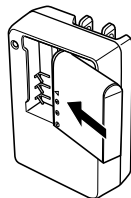

Plug-in Type

2. Plug the rapid charger into a household power outlet.

- This will cause the [CHARGE] lamp to turn red.
- Charging will take about two hours.
- Note that the shape of the rapid charger depends on the area where you purchased the camera.

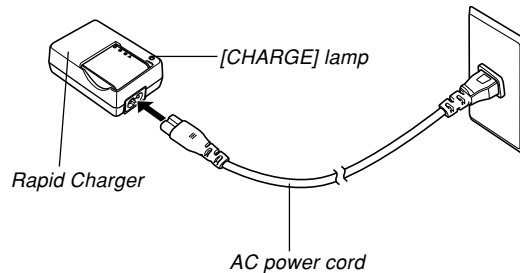

GETTING READY

►► NOTE ◀◀

- The power cord type rapid charger is designed for operation with any power supply in the range of 100V to 240V AC. Note, however, that the shape of the AC power cord plug varies according to country or geographic area. If you plan to use the rapid charger in a geographic area where the power receptacle shape is different from that in your area, replace the AC power cord with one of the other ones that come with the camera, or purchase a commercially available AC power cord that is compatible with the power outlets in that area.

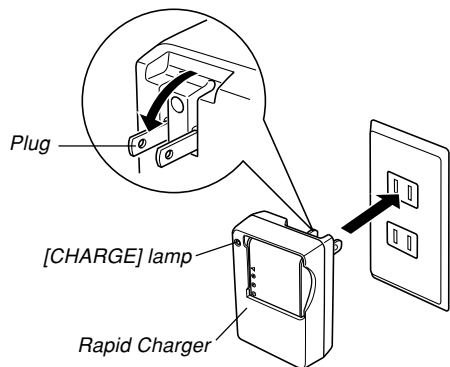

►► NOTE ◀◀

- The plug-in type rapid charger is designed for operation on power ranging from 100V AC to 240V AC. Note, however, that the shape of the power plug varies according to country or geographic area. When traveling abroad, it is up to you to find out if the shape of the rapid charger power plug is compatible with local power outlets and to purchase any required adaptors.

3. The [CHARGE] lamp turns green when charging is complete.

4. After charging is complete, unplug the rapid charger from the power outlet, and remove the battery from it.

- Always unplug the rapid charger from the power outlet and remove the battery whenever you are not charging.

GETTING READY

►► IMPORTANT! ◀◀

- If the battery or rapid charger is very hot or cold when you start charging or if it becomes hot during charging, the rapid charger will enter a standby state, which is indicated when its [CHARGE] lamp is lit amber. Charging will resume when the temperature returns to the allowable charging temperature range, which is indicated when the [CHARGE] lamp turns red.
 - Charging the battery while it is still warm immediately after removing it from the camera can result in only partial charging. Give the battery time to cool before charging it.
 - Battery discharges slightly even when it is left without loading it into the camera. Because of this, it is recommended that you charge the battery immediately before you need to use it.
 - The battery used with this camera is specifically designed for use with digital cameras. If you want to try to use it to power another type of device, you should first check the user documentation that comes with the device to see if the battery is compatible.
 - Though the actual service life of the battery depends on the environment under which it is used, you can expect to be able to recharge it about 500 times before it needs replacement.
- Charging the battery may cause interference with TV and radio reception. If this happens, plug the charger into an outlet that is further away from the TV or radio.
 - Dirty charger contacts and/or battery terminals can make proper charging impossible. Be sure to wipe contacts and terminals occasionally with a dry cloth to keep them clean.

To load the battery

1. Slide the battery cover on the bottom of the camera in the direction indicated by the arrow, and then swing it open.

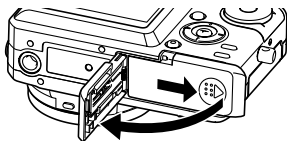

2. While pulling the stopper in the direction indicated by the arrow in the illustration, slide the battery into the camera.

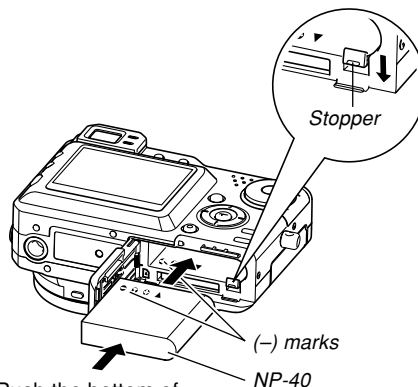

- Push the bottom of the battery, and make sure that the stopper securely locks the battery in place.

GETTING READY

3. Swing the battery cover closed, and then slide it in the direction indicated by the arrow.

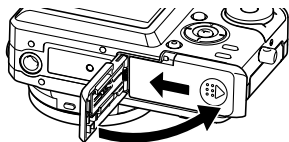

►► IMPORTANT! ◀◀

- Use only the special NP-40 rechargeable lithium ion battery to power this camera. Use of any other type of battery is not supported.

To remove the battery

1. Open the battery cover.
2. Pull the stopper in the direction indicated by the arrow.
 - This will cause the battery to come part way out of the slot.

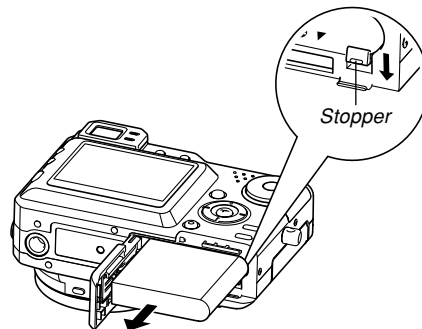

3. Release the stopper and pull the battery from the camera.
 - Take care so you do not drop the battery.

■ If the camera does not work normally

This can mean there is a problem with how the battery is loaded. Remove the battery from the camera and check the battery contacts for dirt. If the contacts are dirty, wipe them clean with a dry cloth.

■ Battery Life Guidelines

The battery life guideline values given below indicate the amount of time under the conditions defined below the table, until power automatically turns off due to battery failure. They do not guarantee that the battery will provide the amount of service indicated. Low temperatures and continued use reduce battery life.

Operation	Approximate Battery Life
Number of Shots (CIPA Standard)* ¹ (Operating Time)	200 shots (100 minutes)
Number of Shots, Continuous Recording* ² (Operating Time)	440 shots (110 minutes)
Continuous Snapshot Playback* ³	220 minutes
Continuous Voice Recording* ⁴	210 minutes

GETTING READY

Supported Battery: NP-40

Storage Medium: SD Memory Card

*1 Number of Shots (CIPA Standard)

- Temperature: 23°C (73°F)
- Monitor Screen: On
- Zoom operation between full wide to full telephoto every 30 seconds, during which two images are recorded, one image with flash; power turned off and back on every time 10 images are recorded.

*2 Continuous Recording Conditions

- Temperature: 23°C (73°F)
- Monitor screen: On
- Flash: Off
- Image recorded every 15 seconds, alternating full wide-angle and full telephoto zoom

*3 Continuous Snapshot Playback Conditions

- Temperature: 23°C (73°F)
- Scroll one image about every 10 seconds



*4 Voice recording times are based on continuous recording.





- The above values are based on a new battery starting from a full charge. Repeated charging shortens battery life.
- Battery life is greatly affected by how much you use flash, zoom and other functions, and how long you leave power turned on.

■ Tips to Make the Battery Last Longer

- If you do not need the flash while recording, select  (flash off) for the flash mode. See page 71 for more information.
- Enable the Auto Power Off and the Sleep features (page 51) to protect against wasting battery power when you forget to turn off the camera.
- You can also conserve battery power by using the [DISP] button to turn off the monitor screen.

■ Low Battery Indicator

The following shows how the battery capacity indicator on the monitor screen changes as battery power is used. The  indicator means that remaining battery power is low. Note that you will not be able to record images while the battery indicator is . Charge the battery immediately whenever either of these indicators appears.

Battery Level	High ←————→ Low
Indicator	 →  →  → 

Power Supply Precautions

Note the following precautions when handling or using the battery and the rapid charger.

■ Battery Handling Precautions

● SAFETY PRECAUTIONS

Be sure to read the following Safety Precautions before using the battery for the first time. Keep these safety precautions and all operating instructions on hand for future reference.

☺☺ NOTE ☹☹

- The term “battery” in this manual refers to the CASIO NP-40 Rechargeable Lithium Ion Battery.
- Use only the rapid charger (BC-30L) to charge the special NP-40 rechargeable lithium ion battery. Never use any other charging device.

GETTING READY

- Failure to observe any of the following precautions while using the battery creates the risk of overheating, fire, and explosion.
 - Never try to use the battery to power any device other than this camera.
 - Never use or leave the battery near open flame.
 - Never place the battery in a microwave oven, throw it into fire, or otherwise expose it to intense heat.
 - Make sure the battery is oriented correctly when you load it into the camera or attach it to the rapid charger.
 - Never carry or store the battery together with items that can conduct electricity (necklaces, pencil lead, etc.)
 - Never try to take the battery apart, modify it in any way, or expose it to strong impact.
 - Do not immerse the battery in fresh water or salt water.
 - Do not use or leave the battery under direct sunlight, in an automobile parked in the sun, or in any other area subject to high temperatures.
- Should you ever notice any of the following conditions while using, charging, or storing a battery, immediately remove it from the camera or rapid charger, and keep it away from open flame:
 - Fluid leaking
 - Emission of a strange odor
 - Heat emission
 - Battery discoloration
 - Battery deformation
 - Any other battery abnormality
- If the battery does not achieve full charge after the normal charging time has passed, stop charging. Continued charging creates the risk of overheating, fire, and explosion.
- Battery fluid can damage your eyes. Should battery fluid get into your eyes accidentally, immediately rinse them with clean tap water and then consult a physician.
- If the battery is to be used by young children, make sure that a responsible adult makes them aware of the precautions and proper handling instructions and make sure that they handle the battery correctly.
- Should fluid from the battery accidentally get onto clothing or your skin, immediately rinse it off with clean tap water. Prolonged contact with battery fluid can cause skin irritation.

● PRECAUTIONS DURING USE

- Charge the battery in a location where the temperature is in the range of 5°C to 35°C (41°F to 95°F). Charging outside this temperature range can cause charging to take longer than normal or even cause charging to fail.
- Very limited operation following a full charge indicates that the battery has reached the end of its service life. Replace the battery with a new one.
- Never wipe the battery with thinner, benzene, alcohol, or other volatile agents or chemically treated rags. Doing so can cause deformation of the battery and lead to malfunction.
- Always make sure that the rapid charger is on a level surface when using it for charging.

● BATTERY STORAGE PRECAUTIONS

- Make sure you remove the battery from the camera when you do not plan to use it for a long time. A battery left in the camera discharges very small amounts of power even when power is turned off, which can lead to a dead battery or the need for longer charging before the next use.
- Store the battery in a cool, dry place (20°C (68 °F) or lower).

● USING THE BATTERY

- When transporting a battery, keep it either loaded in the camera or stored in its case.

■ Rapid Charger Precautions

- Never plug the rapid charger into an outlet whose voltage rating is different from that marked on the rapid charger. Doing so creates the risk of fire, malfunction, and electric shock.
- Never plug in or unplug the rapid charger while your hands are wet. Doing so creates the risk of electric shock.
- Do not plug the rapid charger into an outlet or extension cord that is shared by other devices. Doing so creates the risk of fire, malfunction, and electric shock.
- The rapid charger becomes slightly warm during charging. This is normal and does not indicate malfunction.
- Unplug the rapid charger from the power outlet whenever you are not using it.

Using AC Power

You need to purchase the optionally available AC adaptor (AD-C40) in order to be able to power the camera using AC power.

- 1. Connect the AC power cord to the AC adaptor.**
- 2. Open the camera's terminal panel cover and connect the AC adaptor to the port marked [DC IN].**

GETTING READY

3. Plug the AC power cord into an electrical outlet.

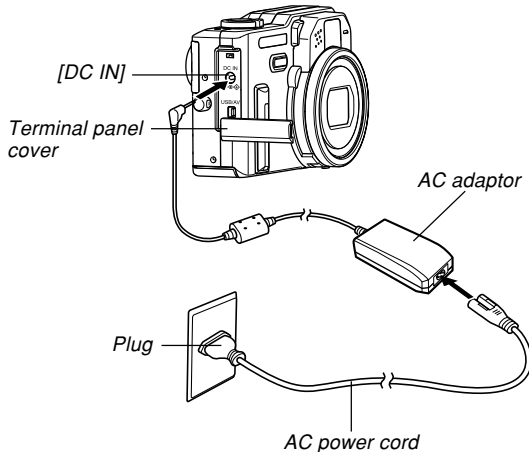

■ Using AC Adaptor In Another Geographic Area

- The AC adaptor can be used with any power source rated from 100V to 240V AC. If you plan to use the AC adaptor in another country, it is up to you to purchase the applicable AC power cord that matches the configuration of power receptacles in that country.

■ AC Adaptor Precautions

- Be sure to turn off power before connecting or disconnecting the AC adaptor.
- Always turn camera power off before disconnecting the AC adaptor, even if the camera has a battery installed. If you don't, the camera will turn off automatically when you disconnect the AC adaptor. You also run the risk of damaging the camera whenever you disconnect the AC adaptor without first turning power off.
- The AC adaptor may become warm to touch after extended periods of use. This is normal and is not cause for alarm.
- After using the camera, turn it off and unplug the AC adaptor from the AC outlet.
- The camera automatically switches over to AC adaptor powered operation whenever the AC adaptor is plugged into the camera.
- Always use the AC adaptor to power the camera whenever it is connected to a computer.
- Never place a blanket or any other cover on the AC adaptor. Doing so creates the risk of fire.

Turning the Camera On and Off

Press the power button to turn the camera on and off. Pressing the power button to turn on the camera causes the green operation lamp to flash. Press the power button again to turn off the camera.

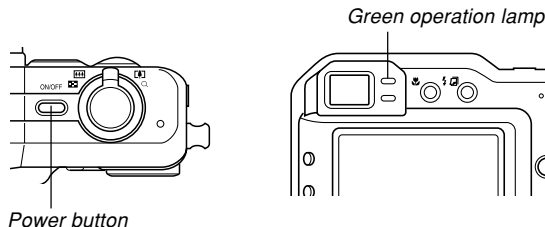

▶▶ IMPORTANT! ◀◀

- If camera power is turned off by the Auto Power Off feature, press the power button to turn it back on again.
- Turning on camera power while the mode dial is set to a REC mode causes the lens to extend from the camera. Make sure there is nothing in front of the camera that can be hit by the lens when you turn on the camera.

Configuring Power Saving Settings

You can configure the settings described below to conserve battery power.

- Sleep** : Automatically turns off the monitor screen if no operation is performed for a specified amount of time in a REC mode. Performing any button operation causes the monitor screen to turn back on.
- Auto Power Off** : Turns off power if you do not perform any operation for a specified amount of time.

1. Turn on the camera.
2. Press [MENU].
3. Use [◀] and [▶] to select the “Set Up” tab.
4. Use [▲] and [▼] to select the feature whose setting you want to configure, and then press [▶].

- See “Using the On-screen Menus” (page 52) for information about how to use menus.

To configure this feature:	Select this setting:
Sleep	Sleep
Auto Power Off	Auto Power Off

5. Use [▲] and [▼] to change the currently selected setting, and then press [SET].

- Available Sleep settings are: “30 sec”, “1 min”, “2 min”, and “Off”.
- Available Auto Power Off settings are: “2 min” and “5 min”.
- Note that the Sleep feature does not operate in the PLAY mode.
- Pressing any button while the camera is in the Sleep state immediately turns the monitor screen back on.
- The Auto Power Off and Sleep features are disabled in the following cases.
 - While the camera is connected to computer or TV via its USB/AV port
 - While a slideshow is in progress
 - While playing back a voice recording file
 - While playing back a movie

Using the On-screen Menu

Pressing [MENU] displays menus on the monitor screen that you can use to perform various operations. The menu that appears depends on whether you are in a REC mode or the PLAY mode. The following shows an example menu procedure in the snapshot mode.

1. Turn on the camera, and then align the mode dial with .

- If you want to enter the PLAY mode instead, you would align the mode dial with .

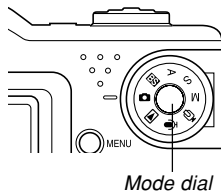

2. Press [MENU].

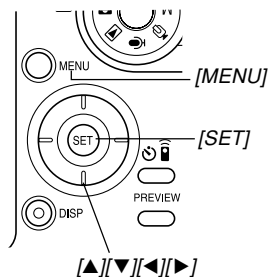

Selection cursor

(Indicates the currently selected item)

Tab



Settings

GETTING READY

● Menu Screen Operations

When you want to do this:	Do this:
Move between tabs	Press [◀] and [▶].
Move from the tab to the settings	Press [▼].
Move from the settings to the tab	Press [▲].
Move between the settings	Press [▲] and [▼].
Display the options available for a setting	Press [▶] or press [SET].
Select an option	Press [▲] and [▼].
Apply the setting and exit the menu screen	Press [SET].
Apply the setting and return to tab selection	Press [◀].
Exit the menu screen	Press [MENU].

3. Press [◀] or [▶] to select the tab you want, and then press [SET] to move the selection cursor from the tab to the settings.

4. Use [▲] and [▼] to select the feature whose setting you want to configure, and then press [▶].

- Instead of pressing [▶], you could also press [SET].



Example: To select the "Size" item.

5. Use [▲] and [▼] to change the currently selected setting.

6. Perform one of the following operations to apply the setting you configured.

To do this:	Perform this key operation:
Apply the setting and exit the menu screen.	Press [SET].
Apply the setting and return to feature selection in step 4.	Press [◀].
Apply the setting and return to tab selection in step 3.	1. Press [◀]. 2. Use [▲] to move back up to tab selection.

- See “Menu Reference” on page 249 for more information about menus.

Configuring Display Language and Clock Settings

Be sure to configure the following settings before using the camera to record images.

- Display language
- Home city
- Date style
- Date and time

Note that the current date and time settings are used by the camera to generate the date and time that are stored along with image data, etc.

▶▶ IMPORTANT! ◀◀

- Recording images without configuring the clock settings causes incorrect time information to be stored with image data. Be sure to configure the clock settings before using the camera.
- A built-in backup battery retains the date and time settings for about two days if the camera is not supplied with power. The date and time settings will be cleared when the backup battery goes dead. The following are the conditions when power is not being supplied to the camera.
 - When the rechargeable battery is dead or removed from the camera
 - When using the AC adaptor to power the camera, disconnecting the AC adaptor
- The date and time setting screen will appear on the monitor screen the next time you turn on the camera after the date and time settings have been cleared. If this happens, reconfigure the date and time settings.
- If you make a mistake when setting the language or clock with the following procedure, you will need to use the camera's menu to individually change the language (page 197) or clock (page 192) settings.

To configure display language and clock settings

1. Press the power button to turn on the camera.
2. Use [▲], [▼], [◀], and [▶] to select the language you want, and then press [SET].



日本語	: Japanese
English	: English
Français	: French
Deutsch	: German
Español	: Spanish
Italiano	: Italian
Português	: Portuguese
中國語	: Chinese (Complex)
中国語	: Chinese (Simplified)
한국어	: Korean

GETTING READY

3. Use [▲], [▼], [◀], and [▶] to select the geographical area where you live, and then press [SET].



4. Use [▲] and [▼] to select the name of the city where you live, and then press [SET].



5. Use [▲] and [▼] to select the summer time (DST) setting you want, and then press [SET].

When you want to do this:	Select this setting:
Keep time using summer time (Daylight Saving Time)	On
Keep time using standard time	Off

6. Use [▲] and [▼] to select the date format setting you want, and then press [SET].

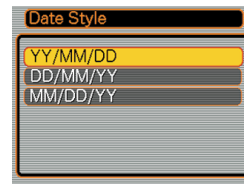

Example: December 24, 2004

To display the date like this:	Select this format:
04/12/24	YY/MM/DD
24/12/04	DD/MM/YY
12/24/04	MM/DD/YY

GETTING READY

7. Set the current date and the time.

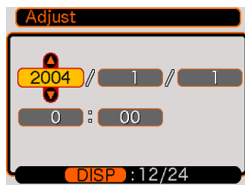

To do this:	Do this:
Change the setting at the current cursor location	Press [▲] and [▼].
Move the cursor between settings	Press [◀] and [▶].
Toggle between 12-hour and 24-hour timekeeping	Press [DISP].

8. Press [SET] to register the settings and exit the setting screen.

BASIC IMAGE RECORDING

This section describes the basic procedure for recording an image.

Recording an Image

Specifying the Recording Mode

Your CASIO digital camera has seven recording modes, each of which is described below. Before recording an image, use the mode dial to select the recording mode that suits the type of image you are trying to record.

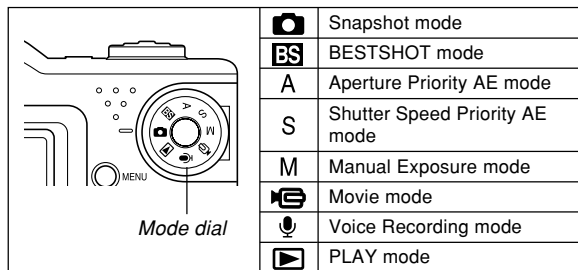

- (Snapshot mode)
Use this mode to record still images. This is the mode you should normally use for image recording.
- **BS** (BESTSHOT mode)
This mode makes camera setup as easy as selecting the applicable sample scene. Simply select one of 27 sample scenes, and the camera will automatically be configured with the settings required to record a similar image (page 113).
- **A** (Aperture Priority AE mode)
In this mode, you select the aperture, and other settings are adjusted accordingly (page 93).
- **S** (Shutter Speed Priority AE mode)
In this mode, you select the shutter speed, and other settings are adjusted accordingly (page 94).
- **M** (Manual Exposure mode)
This mode gives you total control over aperture and shutter speed settings (page 96).
- (Movie mode)
Use this mode to record movies (page 124).
- (Voice Recording mode)
Use this mode to record audio only (page 128).

NOTE

- The icon of the currently selected recording mode (like  for the Snapshot mode) is displayed on the monitor screen.

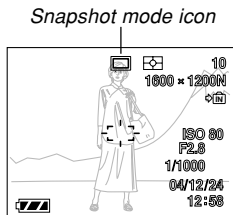

Aiming the Camera

Use both hands to hold the camera still when shooting an image. Holding the camera with one hand increases the chance of movement, which can blur your images.

- Horizontal



Hold the camera still in both hands, with your arms firmly against your sides.

- Vertical

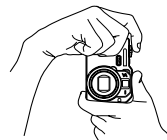

When holding the camera vertically, make sure that the flash is above the lens. Hold the camera still with both hands.

BASIC IMAGE RECORDING

▶▶ IMPORTANT! ◀◀

- Make sure your fingers and the strap do not block the flash, microphone or lens.
- When aiming the camera, take particular care to ensure that your finger is not blocking the phase differential sensor.

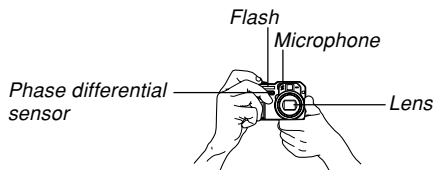

▶▶ NOTE ◀◀

- Your image will be blurred if you move the camera when pressing the shutter button. Press the shutter button carefully, taking care to avoid camera movement. This is especially important when available lighting is low, which slows down the shutter speed.

Recording an Image

Your camera automatically adjusts shutter speed and aperture values in accordance with the brightness of the subject. Images you record are stored in the camera's built-in memory, or to a memory card if you have one loaded in the camera.

- When an optionally available SD memory card or MultiMediaCard (MMC) is loaded in the camera, images are stored on the card (page 201).

1. Press the power button to turn on the camera.

- This causes an image or a message to appear on the monitor screen.



BASIC IMAGE RECORDING

2. Align the mode dial with “” (Snapshot mode).

- This enters the Snapshot mode for image recording.

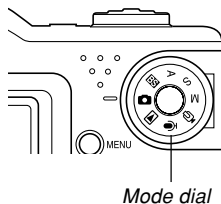

3. Compose the image on the monitor screen so the main subject is within the focus frame.

- The focusing range of the camera depends on focus mode you are using (page 80).
- You can compose images using either the monitor screen or the optical viewfinder (page 67).
- When using the optical viewfinder to compose images, you can use [DISP] to turn off the monitor screen and conserve battery power.

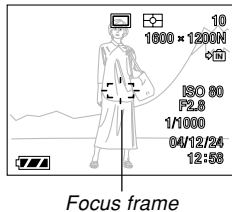

4. Press the shutter button half way to focus the image.

- When you press the shutter button half way, the camera's Auto Focus feature automatically focuses the image, and displays the shutter speed and aperture values. The ISO sensitivity value also appears on the display at this time.
- You can tell whether the image is focused by observing the focus frame and the green operation lamp.

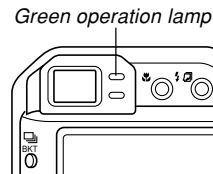
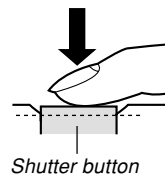

BASIC IMAGE RECORDING

● Operation Lamp and Focus Frame Operation

When you see this:	It means this:
Green focus frame Green operation lamp	The image is in focus.
Red focus frame Flashing green operation lamp	The image is not in focus.

5. After making sure that the image is focused properly, press the shutter button the rest of the way down to record.

- The number of images that can be stored in memory depends on the image size and image quality setting you are using (pages 77, 78, 262).

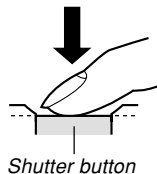

Recording Precautions

- Never open the battery cover while the green operation lamp is flashing. Doing so not only causes the current image to be lost, it can also corrupt images already stored in file memory and even lead to malfunction of the camera.
- Never remove the memory card while an image is being stored to the memory card.
- Fluorescent lighting actually flickers at a frequency that cannot be detected by the human eye. When using the camera indoors under such lighting, you may experience some brightness or color problems with recorded images.
- When "Auto" is selected for the ISO sensitivity setting (page 133), the camera automatically adjusts its sensitivity in accordance with the brightness of the subject. This can cause some digital noise (graininess) to appear in images of relatively dark subjects.
- When recording a dimly lit subject while "Auto" is selected for the ISO sensitivity setting (page 133), the camera increases sensitivity and uses a slower shutter speed. Because of this, you need to guard against camera movement if you have flash turned off (page 71).
- Bright light shining on the lens can cause images to appear "washed out". This tends to happen when recording images outdoors in bright sunlight. To protect against this, use your free hand to shade the lens from the light.

About Auto Focus

- Auto Focus tends not to work well if the camera is moved during recording, or when recording the types of subjects listed below.
 - Solid color walls or subjects with little contrast
 - Strongly backlit subjects
 - Polished metal or other brightly reflective subjects
 - Venetian blinds or other horizontally repeating patterns
 - Multiple subjects that are varying distances from the camera
 - Subjects in poorly lit areas
 - Moving subjects
- Note that a green operation lamp and focus frame do not necessarily guarantee that the resulting image will be in focus.
- If Auto Focus does not produce the results you want for some reason, try using focus lock (page 87) or manual focus (page 85).

About the REC Mode Monitor Screen

- The image shown on the monitor screen in a REC mode is a simplified image for composing purposes. The actual image is recorded in accordance with the image quality setting currently selected on your camera. The image saved in file memory has much better resolution and detail than the REC mode monitor screen image.
- Certain levels of subject brightness can cause the response of the REC mode monitor screen to slow down, which causes some digital noise (graininess) in the monitor screen image.
- Very bright light inside of an image can cause a vertical band to appear in the monitor screen image. This is a CCD phenomenon known as “vertical smear”, and does not indicate malfunction of the camera. Note that vertical smear is not recorded with the image in the case of a snapshot, but it is recorded in the case of a movie (page 124).

Previewing the Last Image Recorded

Whenever you record an image, the camera stores a copy of it in a preview buffer. You can use the procedures described here to view the contents of the preview buffer, without exiting a REC mode. The last recorded image remains in the preview buffer until you record another image, change to the PLAY mode, or turn off camera power.

To view current preview buffer contents after recording a single image

1. In a REC mode, press [PREVIEW] to display the current contents of the preview buffer.

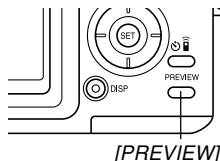

IMPORTANT!

- Preview buffer contents are cleared by the following operations.
 - Turning off the camera
 - Changing the mode dial setting
- Nothing is stored in the preview buffer when you record a movie.

To delete preview buffer contents after recording a single image

►► IMPORTANT! ◀◀

- Note that image deletion cannot be undone. Once you delete an image, it is gone. Make sure you really do not need an image anymore before you delete it.

1. In a REC mode, press [PREVIEW] to display the current contents of the preview buffer.
2. While the preview image is on the display, press [EX ].
3. In response to the confirmation message that appears, use [▲] and [▼] to select “Delete”.
 - To cancel the delete operation without deleting anything, select “Cancel”.
4. Press [SET].
 - This deletes the image and returns to the REC mode screen.

Orientation Sensor

The camera has an orientation sensor that detects whether the camera is being held horizontally (its normal orientation) or vertically when you record an image. Information about camera orientation is recorded along with the image data so the image can be displayed properly. When you transfer images to a computer using the bundled Photo Loader application (page 241), Photo Loader also detects the orientation of each image and displays it accordingly.

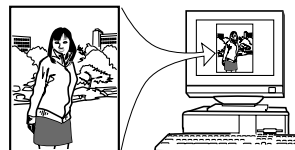

BASIC IMAGE RECORDING

▶▶ IMPORTANT! ◀◀

- To ensure proper operation of the orientation sensor, note the following points.
 - Keep the camera still during recording. Moving the camera while recording can cause misoperation of the orientation sensor.
 - When recording an image using portrait (vertical) orientation, make sure the camera is standing straight up, 90 degrees from horizontal. A sensor error may occur if the camera is angled more than about 20 degrees from vertical.
 - When positioning the camera vertically, keep the flash above the lens.

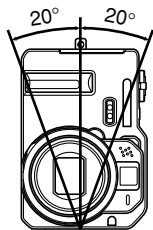

- Miss-operation of the orientation sensor can also occur if the camera is angled towards the front or back. A sensor error may occur if the camera is angled more than about 60 degrees towards the front or back.

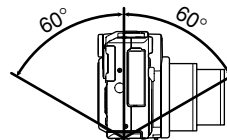

- Note that the orientation sensor does not operate in the Movie mode.

Using the Optical Viewfinder

You can conserve battery power by turning off the camera's monitor screen (page 34) and using the optical viewfinder to compose images.

▶▶ IMPORTANT! ◀◀

- The visible area framed by the viewfinder shows the image that would be recorded at a distance of about one meter (3.3'). When recording a subject that is closer to you than one meter, the recorded image will be lower than what you can see inside the viewfinder area.

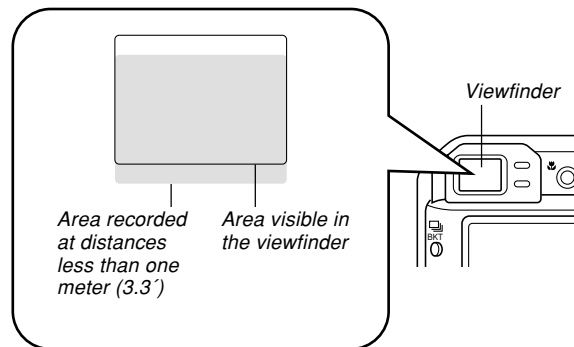

- Since the monitor screen shows exactly what will be recorded, always use it for composing images in the Macro and Manual Focus modes.

Using Zoom

Your camera is equipped with two types of zoom: optical zoom and digital zoom. Normally, the camera automatically switches over to digital zoom after you reach the maximum limit for optical zoom. You can, however, configure the camera to disable digital zoom, if you want.

Optical Zoom

The optical zoom range is 1X to 4X.

- In a REC mode, shift the zoom controller to change the zoom factor.**

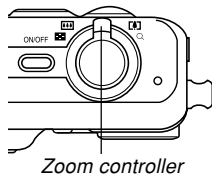

To do this:	Shift this side of the zoom controller:
Zoom out	(Wide Angle)
Zoom in	(Telephoto)

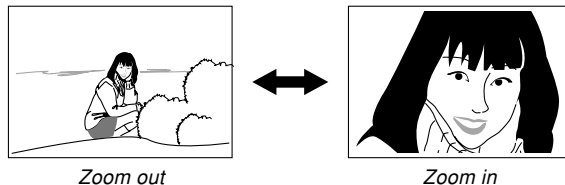

- Compose the image, and then press the shutter button.**

NOTE

- The optical zoom factor also affects the lens aperture.
- Use of a tripod is recommended to protect against hand movement when using the telephoto setting (zoom in).
- You can change the digital zoom setting during movie recording, but not the optical zoom setting. Make sure you select the optical zoom setting you want to use before you press the shutter button to start movie recording.
- Whenever you perform an optical zoom operation while recording with the Macro mode (page 84) or manual focus (page 85), a value will appear on the monitor screen to tell you the focusing range.

Digital Zoom

Digital zoom digitally enlarges the part of the image at the center of the image screen. The range of digital zoom is 4X to 16X (in combination with optical zoom).

▶▶ IMPORTANT! ◀◀

- Digital zoom is disabled whenever the monitor screen is turned off (page 34).
- When you perform a digital zoom operation, the camera manipulates the image data to enlarge the center of the image. Unlike optical zoom, an image enlarged with digital zoom appears coarser than the original.

■ To record an image using digital zoom

1. In a REC mode, hold the zoom controller towards [⏏] (telephoto) / [Q] side.

- This causes the zoom indicator to appear on the display.

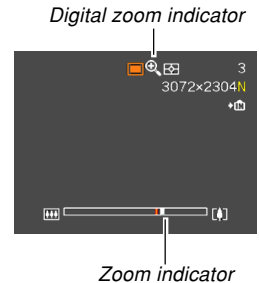

2. When the zoom pointer reaches the optical/digital zoom switch over point, it will stop.

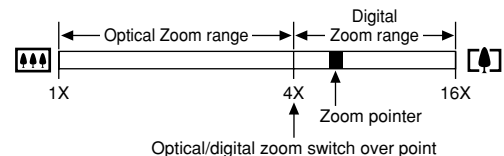

- The above shows what the zoom indicator looks like when digital zoom is turned on. The digital zoom range is not displayed when digital zoom is turned off.

3. Release the zoom controller momentarily, and then slide it towards [📷] (telephoto) / [🔍] side again to move the zoom pointer into the digital zoom range.

- The zoom pointer will also stop when you move the pointer back to the switch over point to re-enter the optical zoom range. Release the zoom controller and then slide it towards [📷] (wide angle) / [🔍] side again to move into the optical zoom range.

4. Compose the image, and then press the shutter button.

■ **To turn digital zoom on and off**

- 1. In a REC mode, press [MENU].**
- 2. Use [◀] and [▶] to select the “REC” tab.**
- 3. Use [▲] and [▼] to select “Digital Zoom”, and then press [▶].**
- 4. Use [▲] and [▼] to select the setting you want, and then press [SET].**

To do this:	Select this setting:
Turn on digital zoom	On
Turn off digital zoom	Off

- Only the optical zoom range is displayed in the zoom level indicator when digital zoom is turned off.

BASIC IMAGE RECORDING

Using the Flash

Perform the following steps to select the flash mode you want to use.



- The approximate effective range of the flash is shown below.

Wide Angle : Approximately 0.4 meters to 3.6 meters
(1.3' to 11.8') (ISO Sensitivity: Auto)

Telephoto : Approximately 0.4 meters to 2.5 meters
(1.3' to 8.2') (ISO Sensitivity: Auto)

1. In a REC mode, press [MENU].

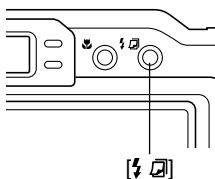

2. Press [ ] to select the flash mode.

- Each press of [ ] cycles through the flash mode settings described below on the monitor screen.



Flash mode indicator



To do this:	Select this setting:
Have the flash fire automatically when required (Auto Flash)	None
Turn off the flash (Flash Off)	
Always fire the flash (Flash On)	
Fire a pre-flash followed by image recording with flash, reducing the chance of red-eye in the image (Red-eye reduction) In this case, the flash fires automatically when required	

3. Record the image.

!!! IMPORTANT! !!!

- Image recording may not be performed if you press the shutter button while the flash is charging (which is indicated by a flashing red operation lamp).
- Using the flash while “Auto” is selected for the ISO Sensitivity setting increases sensitivity, which can cause large amounts of digital noise to appear in the image. You can reduce digital noise by using a lower ISO Sensitivity setting. Note, however, that this also has the effect of shortening the flash range (the range that is covered by the light from the flash) (page 133).

■ About Red-eye Reduction

Using the flash to record at night or in a dimly lit room can cause red spots inside the eyes of people who are in the image. This happens because the light from the flash reflects off of the retina of the eye. When red-eye reduction is selected as the flash mode, the camera performs two pre-flash operations, one designed to cause the irises in the eyes of any people in the image to close, and one for the Auto Focus operation. This is followed by another flash operation for actual recording of the image.

▶▶ IMPORTANT! ◀◀

Note the following important points when using red-eye reduction.

- Red-eye reduction does not work unless the people in the image are looking directly at the camera during the pre-flash. Before pressing the shutter button, call out to the subjects so they all look at the camera while the pre-flash operation is performed.
- Red-eye reduction may not work very well if the subjects are located far away from the camera.

Flash Unit Status

You can find out the current flash unit status by pressing the shutter button half way and checking the monitor screen and red operation lamp.

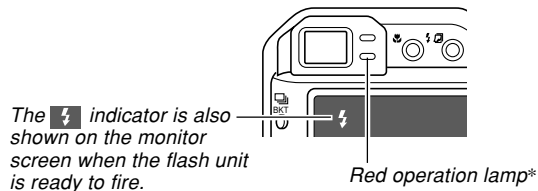

* Red operation lamp

When the red operation lamp is this:	It means this:
Flashing	Flash unit is charging
Lit	Flash unit is ready to fire

Changing the Flash Intensity Setting

Perform the following steps to change the flash intensity setting.

1. In a REC mode, press [MENU].
2. Use [◀] and [▶] to select the “REC” tab.
3. Use [▲] and [▼] to select “Flash Intensity”, and then press [▶].
4. Use [▲] and [▼] to select the setting you want, and then press [SET].

To make flash intensity:	Select this setting:
Stronger	+2
↑	+1
Normal	0
↓	-1
Weaker	-2

NOTE

- Flash intensity may not change if the subject is too far or too close to the camera.

Using Flash Assist

Recording a subject that is outside the flash range can cause the subject to appear dark in the resulting image, because not enough of the flash reaches the subject. When this happens, you can use flash assist to correct the brightness of the recorded subject, so it appears as if the flash illumination was sufficient.



Flash assist used



Flash assist not used

1. In a REC mode, press [MENU].
2. Use [◀] and [▶] to select the “REC” tab.
3. Use [▲] and [▼] to select “Flash Assist”, and then press [▶].

4. Use [▲] and [▼] to select “Auto”, and then press [SET].

- Selecting “Off” disables flash assist.



▶▶ IMPORTANT! ◀◀

- Flash assist may not produce the desired result for some types of subjects.
- Flash assist may have little effect on your image if you changed any of the following settings when you recorded it.
 - Flash intensity (page 73)
 - Exposure compensation (EV shift) (page 88)
 - ISO sensitivity (page 133)
 - Contrast (page 137)

Flash Precautions

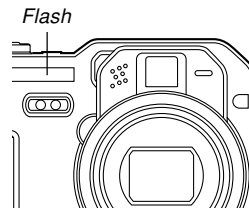
Take care that your fingers do not block the flash when you hold the camera. Covering the flash with your finger can greatly reduce its effectiveness.



- You may not be able to achieve the desired results using a flash if the subject is too close or too far away.
- The flash takes anywhere from a few seconds to as long as 10 seconds to attain full charge after being fired. The actual time required depends on the battery level, temperature, and other conditions.
- The flash does not fire when recording using the following modes and functions: infinity (∞) focus mode (page 85), continuous shutter (page 100), auto bracketing (page 105), Movie mode (page 124). The  (Flash Off) icon on the monitor screen indicates that the flash is turned off.
- The flash unit may not be able to charge when battery power is low. Low battery power is indicated by  (Flash Off) on the monitor screen, and when the flash fails to fire properly resulting in poor image exposure. When these symptoms occur, charge the camera's battery as soon as possible.

BASIC IMAGE RECORDING

- When recording with the flash turned off (🚫) while available lighting is dim, mount the camera on a tripod. Recording images under dim lighting without the flash can cause digital noise, which makes images appear coarse.
- When red-eye reduction (👁️) is selected, flash intensity is adjusted automatically in accordance with the exposure. The flash may not fire at all when the subject is brightly lit.
- Using flash in combination with another light source (daylight, fluorescent light, etc.) can result in abnormal image colors.

Using the Self-timer



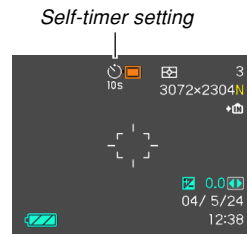

The self-timer lets you select either a 2-second or 10-second delay of the shutter release after you press the shutter button. A Triple Self-timer feature lets you perform three consecutive self-timer operations to record three images.

1. In a REC mode, use [🕒] to cycle through the available self-timer modes.

- Each press of [🕒] cycles through the timer settings on the monitor screen in the sequence shown below.



BASIC IMAGE RECORDING

To do this:	Select this setting:
Disable the self-timer	No icon displayed
Specify a 10-second self-timer	
Specify a 2-second self-timer	
Specify Triple Self-timer	
Specify self-timer off for remote controller operation (page 146)	
Specify 2-second self-timer for remote controller operation (page 146)	

- With the Triple Self-timer, the camera records a series of three images in the sequence described below.
 1. The camera performs a 10-second countdown and then records the first image.
 2. The camera prepares to record the next image. The amount of time required for preparation depends on the camera's current "Size" and "Quality" settings, the type of memory (built-in or card) you are using for image storage, and whether or not the flash is charging.

3. After preparation is complete, the indicator "1sec" appears on the monitor screen, and another image is recorded one second later.
4. Steps 2 and 3 are repeated once more to record the third image.

2. Record the image.

- When you press the shutter button, the self-timer lamp flashes as the countdown progresses, and then the shutter releases after the self-timer reaches the end of its countdown.
- You can interrupt an ongoing self-timer countdown by pressing the shutter button while the self-timer lamp is flashing.

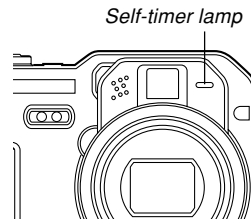

»» NOTE ««

- The “2 sec” self-timer setting is best when shooting with a slow shutter speed, because it helps to avoid blurring of images due to hand movement.
- The functions below are not available for use in combination with the Triple Self-timer.
BULB (pages 95, 96), Continuous Shutter (page 100), Auto Bracketing (page 105), Coupling Shot (page 117), Pre-shot (page 119)

Specifying Image Size

“Image size” is the size of the image, expressed as the number of vertical and horizontal pixels. A “pixel” is one of the many tiny dots that make up the image. More pixels provide finer detail when an image is printed, but a higher pixel count also causes the image’s file size to be larger. You can select an image size to suit your needs for greater detail or smaller file size.

- 1. In a REC mode, press [MENU].**
- 2. Use [◀] and [▶] to select the “REC” tab.**
- 3. Use [▲] and [▼] to select “Size”, and then press [▶].**
- 4. Use [▲] and [▼] to select the image size (in pixels) you want, and then press [SET].**
 - When selecting the image size, the image size value (pixels) will alternate on the display with a corresponding print size. The print size indicates the optimum paper size when you print an image that is the image size you select.

BASIC IMAGE RECORDING

Image Size:	Print Size:	
3072 × 2304	A3 Print	Larger ↑ ↓ Smaller
3072 × 2048 (3:2)	A3 Print (3:2 horizontal-to-vertical ratio)	
2304 × 1728	A4 Print	
1600 × 1200	5" × 7" Print	
1280 × 960	3.5" × 5" Print	
640 × 480	E-mail (optimum size when attaching image to e-mail)	Smaller

• Indicated sizes are rough approximates only.

- The above print sizes are all approximate values when printing at a resolution of 200 dpi (dots per inch). Use a larger setting when you want to print at a higher resolution or when you plan to produce a larger size print.
- Selecting the "3072 × 2048 (3:2)" image size will record images with a 3:2 (horizontal : vertical) aspect ratio, which is optimal for printing on paper with an aspect ratio of 3:2.

Specifying Image Quality

Compressing an image before storage can cause a deterioration of its quality. The more an image is compressed, the greater the loss of quality. The image quality setting specifies the compression ratio to be used when an image is stored in memory. You can select an image quality setting to suit your needs for higher quality or smaller file size.

1. In a REC mode, press [MENU].
2. Use [◀] and [▶] to select the "REC" tab.
3. Use [▲] and [▼] to select "Quality", and then press [▶].
4. Use [▲] and [▼] to select the setting you want, and then press [SET].

BASIC IMAGE RECORDING

To get this:	Select this setting:	
Image recording without compression	TIFF	Higher Quality
High image quality, large file size	Fine	↕
Normal image quality and normal file size	Normal	
Low image quality, small file size	Economy	Lower Quality

▶▶ IMPORTANT! ◀◀

- Actual file size depends on the type of image you record. This means that the remaining image capacity noted on the monitor screen may not be exactly accurate (pages 30, 262).
- It takes longer to store a TIFF (uncompressed) image than a JPEG (compressed) image.
- When you record a TIFF image, a JPEG format FINE version of the same image is also stored. The FINE version is the one that appears on the camera's monitor screen when you display the image in the PLAY mode.
- A TIFF image cannot be resized (page 160), cropped (page 161), or copied (page 204). All of these operations must be performed on JPEG images.
- You cannot transfer a TIFF image to a computer using the bundled Photo Loader application (page 241). Use the procedure under "Viewing Images on a Computer" (page 216) instead.

OTHER RECORDING FUNCTIONS

This section describes other powerful features and functions that are available for recording.

Selecting the Focus Mode

You can select one of five different focus modes: Auto Focus, Macro, Infinity, Manual, and Pan Focus.

▶▶▶ IMPORTANT! ◀◀◀

- Pan Focus can be used in the Movie mode only. You cannot use Pan Focus in any other REC mode.

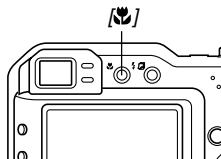

1. In a REC mode, press [].

- Each press of [] cycles through the focus mode settings.



Focus mode indicator



To set up the camera to do this:	Select this setting:
Focus automatically (Auto Focus)	None
Perform close-up focus (Macro)	
Fix the focal distance (Pan Focus)	PF*
Perform infinity focus (Infinity)	
Focus manually (Manual Focus)	MF

* The PF (Pan Focus) setting is available in the Movie mode only.

Using Auto Focus

As its name suggests, Auto Focus focuses the image automatically. The automatic focus operation starts when you press the shutter button down half way. The following is the Auto Focus range.

Range: Approximately 40cm to ∞ (1.3' to ∞)

1. Press [M/AF] to cycle through the focus mode settings until there is no focus mode indicator on the display.

2. Compose the image so the main subject is within the focus frame, and then press the shutter button half way.

- You can tell whether the image is focused by observing the focus frame and the green operation lamp.

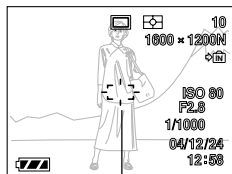

Focus frame

Green operation lamp

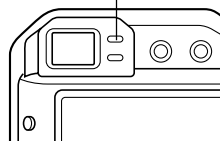

When you see this:	It means this:
Green focus frame Green operation lamp	The image is focused.
Red focus frame Flashing green operation lamp	The image is not focused.

3. Press the shutter button the rest of the way to record the image.

»» NOTE ««

- When “Hybrid” is selected as the Auto Focus mode (page 134), pressing the shutter button all the way without pausing at the half-way point will perform high-speed Auto Focus using the phase differential sensor only. Note, however, that high-speed Auto Focus is somewhat less reliable than the Auto Focus operation performed when you press the shutter button half way and pause.
- Except when you specifically need very fast focusing and response, it is recommended that you normally press the shutter button half way and wait for the Auto Focus operation to complete before pressing the shutter button the rest of the way down to record.
- When proper focusing is not possible because the subject is closer than the Auto Focus range, the camera automatically switches to the Macro mode range (page 84).

■ Specifying the Auto Focus Area

You can use the following procedure to change the Auto Focus area used in the Auto Focus mode and the Macro mode. Note that the configuration of the focus frame changes in accordance with the Auto Focus area you select.

- 1. In a REC mode, press [MENU].**
- 2. On the “REC” tab, select “AF Area”, and then press [▶].**
- 3. Use [▲] and [▼] to select the Auto Focus area you want, and then press [SET].**

OTHER RECORDING FUNCTIONS

For this type of Auto Focus area:	Select this:
<p>Very limited range in the center of the screen</p> <ul style="list-style-type: none"> This setting works well with focus lock (page 87). 	Spot
<p>Automatic selection of the focus area where the subject closest to the camera is located</p> <ul style="list-style-type: none"> With this setting, a wide focus frame, which contains seven focus points, appears on the monitor screen first. When you press the shutter button half way, the camera automatically selects the focus point where the subject closest to the camera is located, and a focus frame appears at that point. This setting works well for group photos. 	Multi
<p>Free movement of the focus point location you want.</p> <ul style="list-style-type: none"> Selecting this setting initially displays the focus point in the center of the monitor screen. Then you can use the [▲], [▼], [◀], and [▶] keys to move it to the location you want. Finally, press [SET] to select the current focus point location. Selecting "Free" also automatically changes from Auto Focus (AF) to contrast focus (page 134). 	Free

• Spot



Focus frame

• Multi

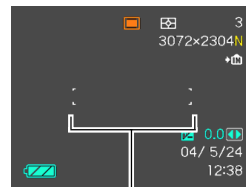

Focus frame

• Free

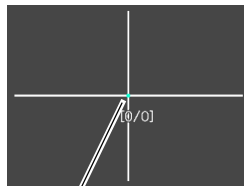

Focus point

→ [SET]

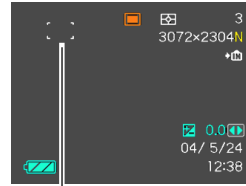

Focus frame

Using the Macro Mode

The Macro mode lets you focus on close up subjects automatically. The automatic focus operation starts when you press the shutter button down half way. The following are the approximate focus ranges in the Macro mode.

Ranges: 10cm to 50cm (3.9" to 19.7") at wide angle
40cm to 50cm (15.6" to 19.7") at telephoto

1. Press [M] to cycle through the focus mode settings until "M" is shown as the focus mode indicator.

2. Record the image.

- The focus and image recording operations are identical to those in the Auto Focus mode.
- You can tell whether the image is focused by observing the focus frame and the green operation lamp. The indications of the focus frame and green operation lamp are the same as those in the Auto Focus mode.

►► IMPORTANT! ◀◀

- Use of the flash along with wide angle zoom or the Macro mode can cause the light of the flash to become blocked, which can produce unwanted shadows in your image.

►► NOTE ◀◀

- When the Macro mode cannot focus properly because the subject is too far away, the camera automatically switches to the Auto Focus range (page 81).
- Whenever you perform an optical zoom operation (page 68) while recording with the Macro mode, a value will appear on the monitor screen as shown below to tell you the focusing range.
Example: M 10cm – 50cm

Using the Infinity Mode

The Infinity mode fixes focus at infinity (∞). Use this mode when recording scenery and other faraway images.

1. Press [

Using Manual Focus

With the Manual Focus mode, you can adjust the focus of an image manually. The following shows focus ranges in the Macro mode for two optical zoom factors.

Optical Zoom Factor	Approximate Focus Range
1X	10cm (3.9”) to infinity (∞)
4X	40cm (15.7”) to infinity (∞)

1. Press [
 - At this point, a boundary also appears on the display, indicating the part of the image that will be used for manual focus.



Boundary

OTHER RECORDING FUNCTIONS

2. While watching the image on the monitor screen, use [◀] and [▶] to focus.



Manual focus position

To do this:	Do this:
Focus in on the subject	Press [◀].
Focus out on the subject	Press [▶].

- Pressing [◀] or [▶] causes the area inside of the boundary displayed in step 1 to fill the monitor screen momentarily to aid in focus. The normal image reappears a short while later.

3. Press the shutter button to record the image.

►► IMPORTANT! ◀◀

- In the Manual Focus mode, the [◀] and [▶] keys adjust focus, even if you used key customization to assign other functions to them (page 140).

►► NOTE ◀◀

- Whenever you perform an optical zoom operation (page 68) while recording with manual focus, a value will appear on the monitor screen as shown below to tell you the focusing range.

Example: MF 10cm – ∞

Using Pan Focus

You can use pan focus in the Movie mode (page 124) to fix the focus for recording without Auto Focus.

1. Enter the Movie mode (page 124).

- This automatically selects Pan Focus as the focus mode, which is indicated by "PF" appearing on the monitor screen.
- If another focus mode is selected in the Movie mode, use  to display the "PF" (Pan Focus) indicator.



2. Press the shutter button to record a movie.

▶▶ IMPORTANT! ◀◀

- Pan Focus can be used in the Movie mode only. You cannot use Pan Focus in any other REC mode.

Using Focus Lock

Focus lock is a technique you can use to focus on a subject that is not located within the focus frame when you record an image. You can use focus lock in the Auto Focus mode and the Macro mode ().

1. Using the monitor screen, compose the image so the main subject is within the focus frame, and then press the shutter button half way.

- This locks the focus on the subject that is currently within the focus frame.

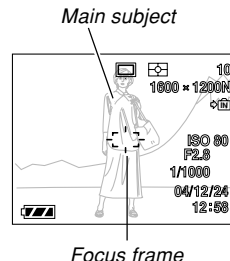

2. Keeping the shutter button pressed half way down, re-compose the image as you like.

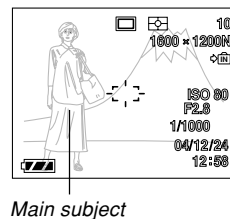

3. When the image is composed the way you want, press the shutter button the rest of the way to record it.

NOTE

- Locking the focus also locks the exposure.

Exposure Compensation (EV Shift)

Exposure compensation lets you change the exposure setting (EV value) manually to adjust for the lighting of your subject. This feature helps to achieve better results when recording a backlit subject, a strongly lit subject indoors, or a subject that is against a dark background.

EV Shift Range: -2.0EV to +2.0EV

Steps: 1/3EV

1. In a REC mode, press [MENU].
2. Select the “REC” tab, select “EV Shift”, and then press [▶].



Exposure compensation value

OTHER RECORDING FUNCTIONS

3. Use [▲] and [▼] to change the exposure compensation value, and then press [SET].

- Pressing [SET] registers the displayed value.



EV value

[▲] : Increases the EV value. A higher EV value is best used for light-colored subjects and backlight subjects.

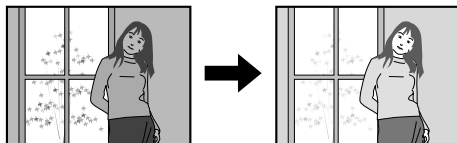

[▼] : Decreases the EV value. A lower EV value is best for dark-color subjects and for shooting outdoors on a clear day.

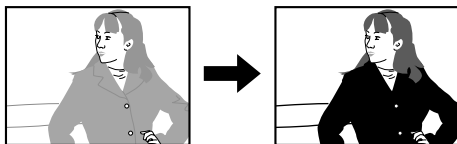

- To cancel EV Shift, adjust the value until it becomes 0.0.

4. Record the image.

▶▶ IMPORTANT! ◀◀

- When shooting under very dark or very bright conditions, you may not be able to obtain satisfactory results even after performing exposure compensation.

▶▶ NOTE ◀◀

- Performing an EV shift operation while using multi-pattern metering (page 135) will cause the metering mode to switch automatically to center weighted metering (page 135). Returning the EV shift value to 0.0 causes the metering mode to change back to multi-pattern metering.
- You can use key customization (page 140) to configure the camera to perform exposure compensation whenever you press [◀] or [▶] while in a REC mode.

Adjusting White Balance

The wavelengths of the light produced by various light sources (daylight, light bulb, etc.) can affect the color of a subject when it is recorded. White balance lets you make adjustments to compensate for different lighting types, so the colors of an image appear more natural.

1. In a REC mode, press [MENU].
2. Select the “REC” tab, select “White Balance”, and then press [▶].

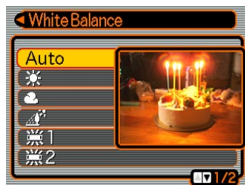

3. Use [▲] and [▼] to select the setting you want, and then press [SET].

When shooting under these conditions:	Select this setting:
Normal conditions	Auto
Outdoor daylight on a clear day	
Outdoor daylight on an overcast or rainy day, in the shade of a tree, etc.	
In the shade of a building or any other area where the color temperature is high	
Under white or daylight white fluorescent light (suppresses color fogging)	
Under daylight fluorescent light (suppresses color fogging)	
Under incandescent lighting	
Flash	
Difficult lighting that requires manual control (See “Configuring the White Balance Setting Manually.”)	Manual

»» NOTE ««

- When “Auto” is selected for the white balance setting, the camera automatically determines the white point of the subject. Certain subject colors and light source conditions can cause problems when the camera tries to determine the white point, which makes proper white balance adjustment impossible. When this happens, use daylight, cloudy, or one of the other fixed white balance settings to specify the type of lighting available.
- You can use key customization (page 140) to configure the camera so the white balance setting changes whenever you press [◀] or [▶] while in a REC mode.

Configuring the White Balance Setting Manually

Certain complex light sources or other environmental conditions can make it impossible to obtain good results when “Auto” or one of the fixed light source settings is selected for white balance. Manual white balance lets you configure the camera for a particular light source and other conditions.

Note that you must perform manual white balance under the same conditions you will be shooting under. Have a sheet of white paper on hand before starting the following procedure.

1. In a REC mode, press [MENU].
2. Select the “REC” tab, select “White Balance”, and then press [▶].
3. Use [▲] and [▼] to select “Manual”.

- This causes the object you last used to adjust manual white balance to appear on the monitor screen.



OTHER RECORDING FUNCTIONS

- 4. Point the camera at a white paper or similar object under the lighting conditions for which you want to set the white balance, and then press the shutter button.**

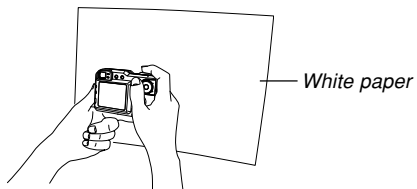

- This starts the white balance adjustment procedure. The message “Complete” appears on the monitor screen after white balance adjustment is complete.
- 5. Press [SET].**
 - This registers the white balance settings and returns to the currently selected recording mode.

NOTE

- After you adjust white balance manually, the setting remains in effect until you change it or until you turn off the camera.

Specifying the Exposure Mode

You can use the mode dial to select the exposure mode, which controls the aperture and shutter speed settings used during image recording.

A mode : Aperture Priority AE

S mode : Shutter Speed Priority AE

M mode : Manual Exposure

Using Aperture Priority AE

When A mode (aperture priority AE) is selected as the exposure mode, the camera adjusts the shutter speed automatically in accordance with a fixed aperture value specified by you. A wider aperture (a lower aperture value) provides a shallow depth of field, while a small aperture (a higher aperture value) provides a greater depth of field.

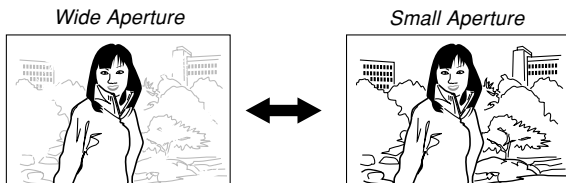

1. Align the mode dial with “A” (Aperture Priority).

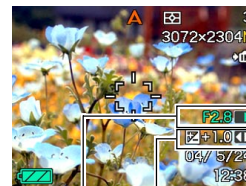

Aperture value EV shift

2. Use [▲] and [▼] to select the aperture value in the exposure panel, and then use [◀] and [▶] to change the setting.

Aperture value*	Wide ←→ Small F2.8, 3.2, 3.5, 4.0, 4.5, 5.0, 5.6, 6.3, 7.1, 8.0
Depth of Field	Shallow ←→ Deep

* The above values are full wide angle optical zoom. Aperture values are different at other optical zoom settings.

- You could also use [▲] and [▼] to select “EV Shift” here, and then use [◀] and [▶] to specify an exposure compensation value (page 88).
- If you are using manual focus (page 85), you can also use [▲] and [▼] to select “FOCUS” (manual focus adjustment), and then use [◀] and [▶] to focus manually.

OTHER RECORDING FUNCTIONS

3. Press the shutter button half way.

- This causes the camera to configure shutter speed automatically in accordance with the aperture value you selected. Then it focuses the image.
- The shutter speed and aperture values on the monitor screen will turn amber when you press the shutter button half way if the image is over-exposed or under-exposed.

4. When the image is focused, press the shutter button all the way down to record.

Using Shutter Speed Priority AE

When S mode (shutter speed priority AE) is selected as the exposure mode, the camera adjusts the aperture automatically in accordance with a fixed shutter speed specified by you. You should specify a shutter speed in accordance with how much your subject is moving.

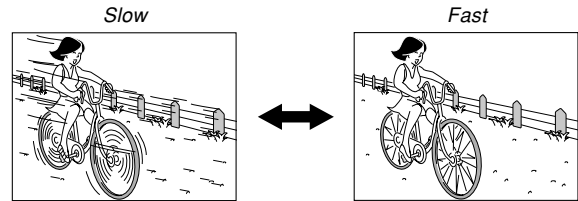

1. Align the mode dial with "S" (Shutter Speed Priority).



Shutter speed EV shift

OTHER RECORDING FUNCTIONS

- 2. Use [▲] and [▼] to select the shutter speed value in the exposure panel, and then use [◀] and [▶] to change the setting.**

Shutter speed	Slow ←→ Fast
	BULB, 60 seconds ←→ 1/2000 second
Movement	Blurred ←→ Stopped

- You could also use [▲] and [▼] to select “EV Shift” here, and then use [◀] and [▶] to specify an exposure compensation value (page 88).
- If you are using manual focus (page 85), you can also use [▲] and [▼] to select “FOCUS” (manual focus adjustment), and then use [◀] and [▶] to focus manually.

- 3. Press the shutter button half way.**

- This causes the camera to configure the aperture value automatically in accordance with the shutter speed you selected. Then it focuses the image.
- The shutter speed and aperture values on the monitor screen will turn amber when you press the shutter button half way if the image is over-exposed or under-exposed.

- 4. When the image is focused, press the shutter button all the way down to record.**

Setting Exposure Settings Manually

In the M mode (manual exposure), you can adjust shutter speed and aperture manually.

1. Align the mode dial with “M” (Manual).

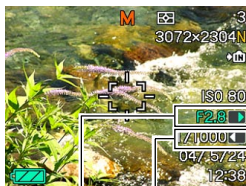

Aperture value
Shutter speed

2. Use [▲] and [▼] to select the aperture value in the exposure panel, and then use [◀] and [▶] to change the setting.

Aperture value*	Wide ←→ Small
	F2.8, 3.2, 3.5, 4.0, 4.5, 5.0, 5.6, 6.3, 7.1, 8.0
Depth of Field	Shallow ←→ Deep

* The above values are full wide angle optical zoom. Aperture values are different at other optical zoom settings.

3. Use [▲] and [▼] to select the shutter speed value in the exposure panel, and then use [◀] and [▶] to change the setting.

Shutter speed	Slow ←→ Fast
	BULB, 60 seconds ←→ 1/2000 second
Movement	Blurred ←→ Stopped

- If you are using manual focus (page 85), you can also use [▲] and [▼] to select “FOCUS” (manual focus adjustment), and then use [◀] and [▶] to focus manually.

4. Press the shutter button half way.

- This causes the camera to adjust focus automatically.

5. When the image is focused, press the shutter button all the way down to record.

Using Manual Assist On-screen Guidance

Pressing [SET] while in the A mode (aperture priority AE), S mode (shutter speed priority AE), or M mode (manual exposure) causes on-screen guidance and exposure indicators (aperture and shutter speed) to appear on the display.

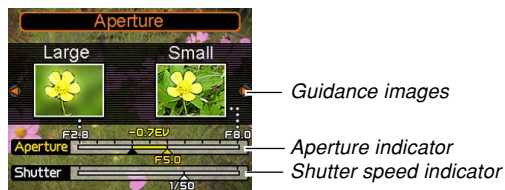

- In the A mode, you can use [◀] and [▶] to change the aperture value setting. Pressing a button causes the Guidance images to disappear from the display.
- In the S mode, you can use [◀] and [▶] to change the shutter speed setting. Pressing a button causes the Guidance images to disappear from the display.
- In the M mode, you can use [▲] and [▼] to switch the Guidance images between the aperture value and shutter speed settings. After displaying the screen you want, you can use [◀] and [▶] to change the setting.
- If the Guidance images disappear from the monitor screen, you can display them again by pressing [DISP].

►► IMPORTANT! ◀◀

- The shutter speed displayed in the A mode and the aperture value displayed in the S mode are rough approximations only. Because of this, these settings may be slightly different from the settings that appear when you press the shutter button half way (which are more precise).

Exposure Mode Recording Precautions

- You may not be able to achieve the brightness you want when recording an image that is very dark or very bright. If this happens, use the M mode (manual exposure) to adjust the aperture or shutter speed manually.
 - You can select the “BULB” setting in the S mode (shutter speed priority AE) or M mode (manual exposure).
 - With the “BULB” setting, exposure continues as long as you keep the shutter button depressed, for up to 60 seconds.
 - Note that when you are using the “BULB” setting, the record operation with the card remote controller (page 148) is different from the record operation on the camera.
 - Using slow shutter speeds can cause digital noise (graininess) to appear in the image. Because of this, the camera automatically performs a digital noise reduction process whenever the shutter speed is 1/8 second or slower. The slower the shutter speed, the greater the possibility that digital noise will be generated in an image. If you notice digital noise in your images at very slow shutter speeds, try using a shutter speed setting that is faster than four seconds. Also note that the digital noise reduction process can cause it to take longer (about double the shutter speed setting or more) to record each image.
- At shutter speeds slower than 1 second, the brightness of the recorded image may not be the same as the brightness of the image that appears on the monitor screen.

Using Auto Exposure Lock (AE Lock)

The AE Lock feature lets you lock auto exposure at a particular setting. This feature is separate from the AE lock that is achieved by pressing the shutter button half way in any exposure mode besides the M mode (manual exposure).

You can use AE Lock in the following instances.

- To set up exposure on a subject that is different from the subject selected by Auto Focus
- To setup exposure prior to using the flash for recording

1. In a REC mode, point the camera at the subject on which you want exposure to be performed.

2. Press [AE-L].

- This fixes the exposure settings (aperture and shutter speed), and displays “AE-L” on the monitor screen.
- The AE Lock is released by pressing [AE-L] again or by changing to another mode.

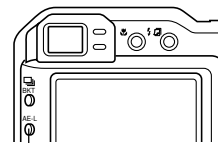

[AE-L]

AE-L



3. Record the image.

- AE Lock is released automatically when the image is recorded.

▶▶ IMPORTANT! ◀◀

- If AE Lock is already in effect, you can re-execute it by pressing [AE-L] once to release AE Lock, and then pressing [AE-L] again to perform a new AE Lock operation.
- Continuous shutter recording is always performed with AE Lock.
- AE Lock can be used before starting movie recording or while movie recording is in progress (page 124).
- Proper Auto Focus may not be possible if you try to use AE Lock to record an image in which there is a very large variation in brightness.
- You can also perform AE Lock by holding down [AE-L], instead of performing the procedure described above.

Using a Continuous Shutter Mode

You can configure the camera to record only a single snapshot each time the shutter button is pressed, or to keep recording as long as the shutter button remains depressed (continuous shutter). You can select from among three different continuous shutter modes.

- Normal speed continuous shutter mode
This mode records images as long as you keep the shutter button depressed.
- High speed continuous shutter mode
This mode records up to 5 consecutive images, at a speed of about three images per second, as long as you keep the shutter button depressed. This mode records faster than the normal speed continuous shutter mode.
- Multi continuous shutter mode
Pressing the shutter button once records 25 consecutive stop-action shots at high speed and combines them into a single image.

Using the Normal Speed Continuous Shutter Mode

The normal speed continuous shutter mode records images as long as you keep the shutter button depressed.

- Recording Speed: Depends on image size and image quality settings.
- Number of Shots: Maximum number of shots possible (based on remaining memory capacity)

1. In a REC mode, press [ BKT].

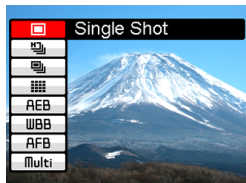



2. Use [▲] and [▼] to select “”, and then press [SET].

- This causes “” to appear on the monitor screen.

3. Press the shutter button to record.

- Recording continues as long as you keep the shutter button depressed. Release the shutter button to stop recording.



NOTE

- You can also select a continuous shutter mode by holding down [ BKT], selecting the mode you want with [▲] and [▼], and then releasing [ BKT].

Using the High Speed Continuous Shutter Mode

The high speed continuous shutter mode provides higher speed recording than the normal speed continuous shutter mode.

- Recording Speed: Three images per second (The interval between shots is longer when shooting at slow shutter speeds)
- Maximum Number of Shots: 5

- 1. In a REC mode, press [ BKT].**
- 2. Use [▲] and [▼] to select “”, and then press [SET].**
 - This causes “” to appear on the monitor screen.
- 3. Press the shutter button to record.**
 - Recording continues as long as you keep the shutter button depressed. Release the shutter button to stop recording.

►► IMPORTANT! ◀◀

- Nothing is displayed on the monitor screen while recording is in progress.
- The camera automatically performs a digital noise reduction process at shutter speeds slower than 1 second. Because of this, the maximum number of high-speed continuous shutter mode shots becomes four (instead of five) at shutter speeds slower than 1 second.

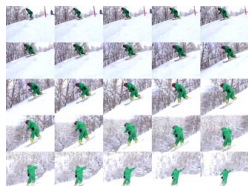

25-shot Stop Action Images (Using the Multi Continuous Shutter Mode)

Use the following procedure to record 25 consecutive stop-action shots at high speed and combine them into a single image.



►► IMPORTANT! ◀◀

- Note with the above procedure, you do not need to keep the shutter button depressed.
- The size of the 25-shot images is 1600 × 1200 pixels.

1. In a REC mode, press [📺] BKT].
2. Use [▲] and [▼] to select “”, and then press [SET].
 - This causes “” to appear on the monitor screen.
3. Press the shutter button once to record.
 - After 25 shots are recorded, they are combined into a single image, which is stored in memory.

Continuous Shutter Precautions

Continuous shutter cannot be used when any one of the following conditions exists.

- When TIFF is selected for the image resolution (page 78)
- When “BULB” is selected for the shutter speed (pages 95, 96)
- When using Coupling Shot, Pre-shot, or Soft Focus (pages 113, 117, 119)
- The flash is disabled while a continuous shutter mode is being used.
- You cannot use the self-timer in combination with the normal speed continuous shutter mode. Also, you cannot use the high speed continuous shutter mode or multi continuous shutter mode in combination with the Triple Self-timer (page 75).
- The slowest possible shutter speed setting when using the multi continuous shutter mode is 1/15 second.
- Starting a continuous shutter operation causes the exposure and focus settings to be fixed at the levels for the first image. The same settings are applied to all subsequent images.
- When using a continuous shutter mode, keep the camera still until all recording is finished.

- A continuous shutter operation may stop part way through if memory capacity runs low.
- Using a slow shutter speed setting causes a longer interval between images.

Using Auto Bracketing

Auto bracketing lets you select a single particular setting as a variable, and then record a series of images, each of which uses a different setting for the variable you selected.

You can then select the image(s) you want to keep.

There are two types of auto bracketing variables: configurable and non-configurable.

■ Configurable Auto Bracketing Variables

There are three configurable auto bracketing variables.

- Exposure
- White Balance
- Focus distance

With these configurable variables, you can specify how the setting of the variable changes, and whether three or five images should be recorded when the shutter button is pressed.

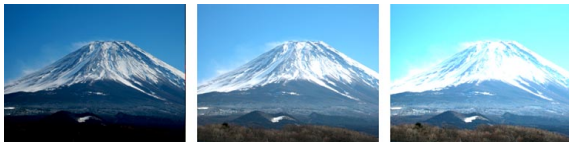

Three images using exposure as a variable

■ Non-configurable Auto Bracketing Variables

There are six non-configurable auto bracketing variables.

- Filter 1
- Filter 2
- Portrait
- Sharpness
- Saturation
- Contrast

The shift range of a non-configurable variable and the number of images recorded are fixed, and cannot be changed by you.

Using Auto Bracketing with Exposure Selected as the Variable (AE Bracketing)

With AE bracketing, you can specify recording of three images or five images each of which is recorded with a different Auto Exposure setting. You can also specify the range of change for the exposure value (shift range).

- You can specify the shift range you want for AE bracketing.

- In a REC mode, press [BKT].



- Use [▲] and [▼] to select "AEB", and then press [▶].

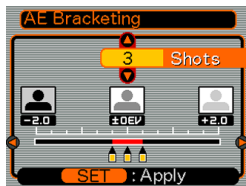

- Use [▲] and [▼] to specify the number of images you want to record.

- You can specify either three images or five images.

- Use [◀] and [▶] to specify the shift range.

- When the settings are the way you want, press [SET].

- This causes the "AEB" indicator to appear on the monitor screen.

- Press the shutter button to record.

- Pressing the shutter button once records the number of images you specified.

NOTE

- The recording speed is the same as that for high speed continuous shutter mode (page 102).
- You can also select an auto bracketing mode by holding down [BKT], selecting the mode you want with [▲] and [▼], and then releasing [BKT].

Using Auto Bracketing with White Balance as the Variable (WB Bracketing)

With WB bracketing, you can specify recording of three images or five images, each of which is recorded with a different white balance setting. As the white balance setting changes, the image takes on a more reddish or bluish tinge. You can also specify the range of change for the white balance setting (shift range).

- You can specify the shift range you want for WB bracketing.

1. In a REC mode, press [📺] BKT].

2. Use [▲] and [▼] to select “WBB”, and then press [▶].

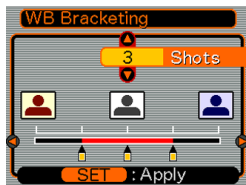

3. Use [▲] and [▼] to specify the number of images you want to record.

- You can specify either three images or five images.

4. Use [◀] and [▶] to specify the shift range.

5. When the settings are the way you want, press [SET].

- This causes the “WBB” indicator to appear on the monitor screen.

6. Press the shutter button to record.

- Pressing the shutter button once records the number of images you specified.

NOTE

- The recording speed is the same as that for high speed continuous shutter mode (page 102).

Using Auto Bracketing with the Focus Distance as the Variable (Focus Bracketing)

With focus bracketing, you can specify recording of three images or five images, each of which is recorded using a different focus distance setting. You can also specify the range of change for the focus distance (shift range). This comes in handy when performing the hard-to-focus macro and telephoto recording.

- You can specify the shift range you want for focus bracketing

1. In a REC mode, press [📺] BKT].

2. Use [▲] and [▼] to select “AFB”, and then press [▶].

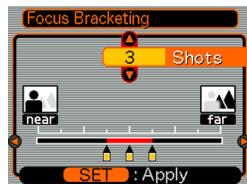

3. Use [▲] and [▼] to specify the number of images you want to record.

- You can specify either three images or five images.

4. Use [◀] and [▶] to specify the shift range.

5. When the settings are the way you want, press [SET].

- This causes the “AFB” indicator to appear on the monitor screen.

6. Press the shutter button to record.

- Pressing the shutter button once records the number of images you specified.

NOTE

- The recording speed is the same as that for high speed continuous shutter mode (page 102).

Using Auto Bracketing with Non-configurable Variables (Multi Bracketing)

There are six non-configurable auto bracketing variables.

- Filter 1 (five images)
- Filter 2 (five images)
- Portrait (three images)
- Sharpness (five images)
- Saturation (five images)
- Contrast (five images)

The shift range of a non-configurable variable and the number of images recorded are fixed, and cannot be changed by you.

■ To use auto bracketing with a non-configurable variable

1. In a REC mode, press [] BKT].
2. Use [\blacktriangle] and [\blacktriangledown] to select “Multi”, and then press [\blacktriangleright].

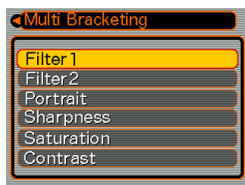

3. Use [\blacktriangle] and [\blacktriangledown] to select the non-configurable variable you want, and then press [SET].

- This causes the “MB” indicator to appear on the monitor screen.

4. Press the shutter button to record.

- Pressing the shutter button once records the image. After that, the image data is processed internally to create other versions of the same image in accordance with the selected auto bracketing function.

NOTE

- Selecting “Filter 1” records images with the monochrome, sepia, red, and purple filters.
- Selecting “Filter 2” records images with the green, blue, yellow, and pink filters.
- Selecting “Portrait” records a normal image, followed by an image with soft focus and enhanced flesh tones.

IMPORTANT!

- Note that you can use only one non-configurable variable at a time. You cannot use them in combination with each other.

Auto Bracketing Precautions

- Auto bracketing cannot be used when any one of the following conditions exists.
 - When TIFF is selected for the image resolution (page 78)
 - When “BULB” is selected for the shutter speed (pages 95, 96)
 - During Coupling Shot, Pre-shot, or Soft Focus recording (pages 113, 117, 119)
- The flash is disabled while auto bracketing is being used.
- The Triple Self-timer (page 75) cannot be used together with auto bracketing.
- Take care not to move the camera until all of the shots (three or five) of the auto bracketing operation are recorded.
- The camera automatically performs a digital noise reduction process at shutter speeds slower than 1 second. Because of this, an auto bracketing operation that normally records five shots records only four shots at shutter speeds slower than 1 second.
- An auto bracketing operation may stop part way through if memory capacity or battery power runs low.
- Certain menu settings may be ignored when you use Auto Bracketing for recording.

Previewing Images Recorded with High Speed Continuous Shutter or Auto Bracketing

You can preview all of the images recorded by a high speed continuous shutter (page 102) or auto bracketing (page 105) operation.

To view current preview buffer contents after recording multiple images

1. In a REC mode after recording with high speed continuous shutter or auto bracketing, press [PREVIEW] to display the current contents of the preview buffer.

- This displays all of the images in the preview buffer. The currently selected image is the one with the selection boundary around it.

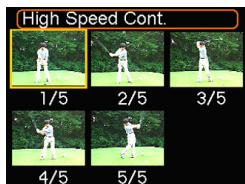
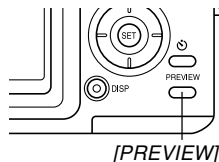

Images recorded using the high speed continuous shutter mode

- This screen does not appear if the recording operation recorded only one image.
2. Use [▲], [▼], [◀], and [▶] to move the selection boundary to the image you want to view, and then press [SET] to display it.
 - This displays the image with an indicator (like "1/5") that shows the recording method used, along with a value indicating the image number in the series.
 3. After displaying an image, use [◀] and [▶] to scroll between images.
 4. Press [PREVIEW] again to return to the REC mode screen.

▶▶ IMPORTANT! ◀◀

- Pressing [PREVIEW] following normal speed, multi continuous shutter mode, or snapshot operation displays the last image recorded only.
- Preview buffer contents are cleared by the following operations.
 - Turning off the camera
 - Changing the mode dial setting
 - Recording a new image without high speed continuous shutter or auto bracketing

To delete current preview buffer contents after recording multiple images

▶▶ IMPORTANT! ◀◀

- Note that image deletion cannot be undone. Once you delete an image, it is gone. Make sure you really do not need an image anymore before you delete it.

1. In a REC mode after recording with high speed continuous shutter or auto bracketing, press [PREVIEW] to display the current contents of the preview buffer.

2. Press [EX .

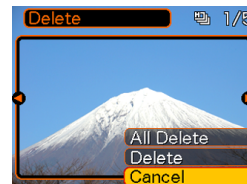

3. Use [▲] and [▼] to select the delete operation you want.

OTHER RECORDING FUNCTIONS

To do this:	Select this option:
Delete all of the images of the last high speed continuous shutter or auto bracketing operation	All Delete
Delete only the image you selected using [◀] and [▶]	Delete
Cancel the delete operation	Cancel

4. After the setting is the way you want, press [SET].

►► IMPORTANT! ◀◀

- The “All Delete” option is not available when there is only one image.

Using the BESTSHOT Mode

Selecting one of the 27 BESTSHOT scenes automatically sets up the camera for recording a similar type of image.

Scene Number	Scene Name
1	Portrait
2	Scenery
3	Portrait With Scenery
4	Coupling Shot (page 117)
5	Pre-shot (page 119)
6	Soft Focus
7	Children
8	Sports
9	Candlelight Portrait
10	Party
11	Pet
12	Flower
13	Natural Green
14	Soft Flowing Water
15	Splashing Water
16	Sundown
17	Night Scene
18	Night Scene Portrait
19	Fireworks
20	Food
21	Text
22	Collection

OTHER RECORDING FUNCTIONS

Scene Number	Scene Name
23	Monochrome
24	Retro
25	Twilight
26	Business cards and documents (page 121)
27	White board,etc. (page 121)
	Register User Scene (page 115)

1. Align the mode dial with **[BS]**, and then press **[SET]**.

- This enters the BESTSHOT mode and displays a sample scene.



2. Use **[◀]** and **[▶]** to select the sample scene you want, and then press **[SET]**.

3. Record the image.

▶▶ IMPORTANT! ◀◀

- BESTSHOT scenes were not recorded using this camera. They are provided as samples only.
- Due to shooting conditions and other factors, an image recorded using the setup of a BESTSHOT scene may not produce exactly the results you expect.
- After selecting a BESTSHOT scene, you can change to a different one by pressing **[SET]** and then using **[◀]** and **[▶]** to scroll through available scenes. When the one you want is displayed, press **[SET]**.
- You can change the camera settings that are made when you select a BESTSHOT scene. Note, however, that the BESTSHOT settings revert to their defaults when you select another BESTSHOT scene, change the recording mode, or turn off the camera.
- Digital noise reduction processing is performed automatically when you are recording a night scene, fireworks, or other image that requires slow shutter speeds. Because of this, it takes longer to record images at lower shutter speeds. Make sure that you do not perform any camera button operations until the image recording operation is complete.
- When recording the image of a night scene, fireworks, or some other image using a slow shutter speed, use of a tripod is recommended to prevent hand movement.

OTHER RECORDING FUNCTIONS

- The slowest possible shutter speed setting when using the multi continuous shutter mode (page 103) is 1/15 second. Because of this, images probably will be underexposed if you use the multi continuous shutter mode while the fireworks BESTSHOT scene is selected.

NOTE

- Operation guidance and the currently selected BESTSHOT scene appear on the display for about two seconds if the camera is in the BESTSHOT mode when you turn it on.



Creating Your Own BESTSHOT Setup

You can use the procedure below to save the setup of an image you recorded for later recall when you need it again. Recalling a setup you save automatically sets up the camera accordingly.

1. Align the mode dial with **BS**, and then press **[SET]**.

- This enters the BESTSHOT mode and displays a sample scene.

2. Use **[◀]** and **[▶]** to display “Register User Scene”.



3. Press **[SET]**.

OTHER RECORDING FUNCTIONS

4. Use [◀] and [▶] to display the image whose setup you want to register as a BESTSHOT scene.



5. Use [▲] and [▼] to select "Save", and then press [SET].

- This registers the setup.
- Now you can use the procedure on page 114 to select your user setup for recording.

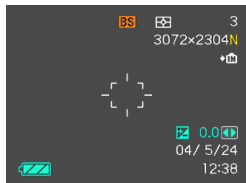

NOTE

- The following are the settings that are included in a BESTSHOT mode user setup: focus mode, EV shift value, filter, metering mode, white balance mode, flash intensity, sharpness, saturation, contrast, flash mode, ISO sensitivity, Flash Assist, aperture and shutter speed.
- Note that images recorded with this camera only can be used to create a BESTSHOT user setup.
- You can have up to 999 BESTSHOT user setups in the camera's built-in memory at one time.
- You can check the current setup of a scene by displaying the various setting menus.
- When you register a BESTSHOT user setup, it is automatically assigned a file name using the format "UP700nnn.JPE" (n=0 to 9).

IMPORTANT!

- BESTSHOT user setups are located in the camera's built-in memory after the built-in sample scenes.
- Note that formatting the built-in memory (page 198) deletes all BESTSHOT user setups.

■ To delete a BESTSHOT user setup

1. Align the mode dial with **[BS]**, and then press **[SET]**.
2. Use **[◀]** and **[▶]** to display the user setup you want to delete.
3. Press **[EX 

Combining Shots of Two People into a Single Image (Coupling Shot)**

Coupling Shot lets you record images of two people and combine them into a single image. This makes it possible for you to include yourself in group images, even when there is no one else around to record the image for you. Coupling Shot is available in the BESTSHOT mode (page 113).

- First Image



This is the part of the image that does not include the person who is recording the first image.



- Second Image



Making sure that the background of the image is aligned correctly, record the image of the person who recorded the first image.

OTHER RECORDING FUNCTIONS

- Combined Images



1. Align the mode dial with **[BS]**, and then press **[SET]**.
2. Use **[◀]** and **[▶]** to select “Coupling Shot”, and then press **[SET]**.
3. Align the focus frame on the monitor screen with the subject you want on the left side of the image.

- While “Coupling Shot” is selected, the “AF Area” (page 82) setting automatically becomes “Spot”.

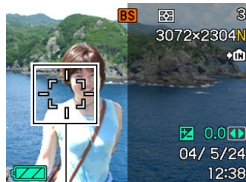

Focus frame

4. Press the shutter button to record the left side of the image.

- The focus, exposure, white balance, zoom, and flash settings are fixed for this type of image.

5. Next, align the focus frame with the subject you want in the right side of the image, taking care to align the actual background with the semi-transparent background of the first image, which is shown on the monitor screen.



Semi-transparent background

- Pressing **[MENU]** any time after step 4 of the above procedure cancels the first image and returns to step 3.

6. When everything is aligned correctly, record the right side of the image.

▶▶ IMPORTANT! ◀◀

- Coupling Shot temporarily uses file memory to store data. You may get an error during Coupling Shot recording if there is not enough file memory available to store the required data. If this happens, delete images you no longer need and try again.

Recording a Subject onto an Existing Background Image (Pre-shot)

Pre-shot helps you get the background you want, even if you need to ask someone else to record the image for you. Basically, Pre-shot is a two-step process.

1. You compose the background you want and press the shutter button, which causes a semi-transparent image of the background to remain on the monitor screen.
2. Ask someone else to record a shot of you against your original background, telling them to compose the image by using the semi-transparent monitor screen image as a guide.
 - The camera stores the image produced by step 2 only.
 - Depending on how the image is actually composed in step 2, its background may not be exactly the same as the one you composed in step 1.

Note that Pre-shot is available in the BESTSHOT mode only (page 113).

OTHER RECORDING FUNCTIONS

- Freeze the background on the monitor screen.



- Record the image, using the background on the monitor screen as a guide.



- Only the second image is recorded.



1. Align the mode dial with **[BS]**, and then press **[SET]**.
2. Use **[◀]** and **[▶]** to select “Pre-shot”, and then press **[SET]**.
3. Compose the background you want on the monitor screen, and then press the shutter button to temporarily record it as a reference image.
 - This operation causes a semi-transparent image of the background to appear on the monitor screen, but the displayed image is not actually saved in camera memory.
 - The focus, exposure, white balance, zoom, and flash settings are fixed for this type of image.
4. Now you can stand in front of the background and ask someone else to snap your picture, using the semi-transparent background on the monitor screen as a composition guide.



Semi-transparent background

OTHER RECORDING FUNCTIONS

- You can press [MENU] at this point to clear the semi-transparent background from the monitor screen. Then you can repeat step 3 to record a new background.

5. After composing the final image (using the semi-transparent background as a guide), the person with the camera should press the shutter button to record.

- Note that the semi-transparent background image you temporarily record in step 3 is for composition purposes only. The final image contains only what is in front of the camera when the shutter button is pressed in step 5.

Recording Images of Business Cards and Documents (Business Shot)

Recording a business card, document, white board, or similarly shaped object from an angle can cause the subject to appear misshaped in the resulting image. Business Shot automatically corrects the shape of rectangular objects to make them appear like the camera was positioned directly in front of them.

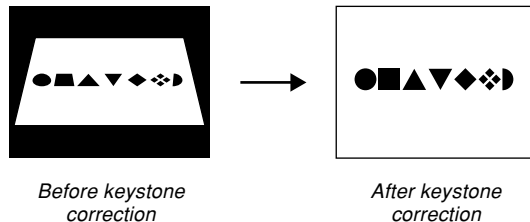

■ Setup Sample Images

- Business cards and documents
- White board, etc.

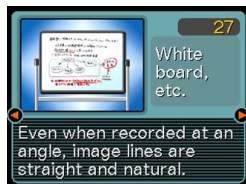
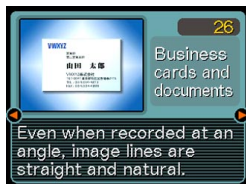

▶▶ IMPORTANT! ◀◀

- Before recording, compose the image so outline of the item you want to record fits entirely within the monitor screen. The camera will not be able to detect the shape of the subject correctly unless it is enclosed entirely within the monitor screen.
- The camera also will be unable to detect the shape of the subject if it is the same color as the background. Make sure the subject is against a background that allows the outline of the subject to stand out.

▶▶ NOTE ◀◀

- When the camera is at an angle to a business card or document it is recording, the shape of the business card or document may appear distorted in the image. Auto keystone correction corrects for this distortion, which means that subjects appear normal even if you record at an angle.

To use Business Shot

1. Align the mode dial with “**BS**”, and then press [SET].
2. Use [◀] and [▶] to select the Business Shot image you want, and then press [SET].
3. Record the image.

- This displays a screen that shows all of the objects in the image that qualify as candidates for keystone correction.
- An error message will appear (page 260) if the camera is unable to find any suitable keystone correction candidate in the image. After a short while, the original image will be stored in memory, as-is.

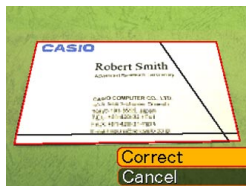

4. Use [◀] and [▶] to select the candidate you want to correct.
5. Use [▲] and [▼] to select “Correct”, and then press [SET].

- Selecting “Cancel” in place of “Correct” stores the original image as-is, without correcting it.

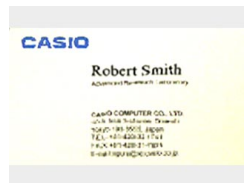

▶▶ IMPORTANT! ◀◀

- The maximum Business Shot image size is 1600 × 1200 pixels, even if the camera is configured for a larger image size. An image size setting smaller than 1600 × 1200 pixels records images at the specified size.

OTHER RECORDING FUNCTIONS

Using the Movie Mode

You can record movies with audio. A single movie can be as long as available memory capacity allows.

- File Format: AVI
AVI format conforms to the Motion JPEG format promoted by the Open DML Group.
- Image Size: 320 × 240 pixels
- Movie File Size: Approximately 300KB/second.
- Maximum Movie Length
 - One Movie:
As long as available memory capacity allows
 - Total Movie Time:
29 seconds with built-in memory; 200 seconds with 64MB SD memory card

NOTE

- You can play back files recorded in the Movie mode on your computer using Windows Media Player.

1. Align the mode dial with .

Remaining recording time

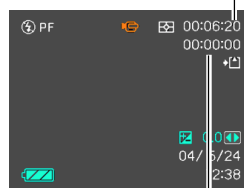

Recording time

2. Point the camera at the subject and then press the shutter button.

Movie recording indicator



OTHER RECORDING FUNCTIONS

- The remaining recording time counts down and the elapsed recording time counts up on the monitor screen as you record.
- Starting a movie record operation causes optical zoom to be disabled. Only digital zoom is available while a movie record operation is in progress. If you want to use optical zoom to record a movie, perform the zoom operation before starting the record operation.
- The focus mode automatically changes to Pan Focus (page 87) when you enter the Movie mode, regardless of the mode memory's (page 141) Focus setting. You can, however, change to another focus mode before starting a recording.



3. When movie recording is complete, the movie file is stored in file memory.

▶▶ IMPORTANT! ◀◀

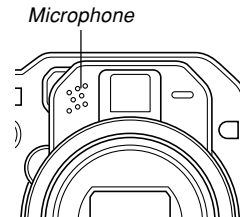
- The flash does not fire in the Movie mode.
- This camera also records audio. Note the following points when recording a movie.
 - Take care that you do not block the microphone with your fingers.
 - Good recording results are not possible when the camera is too far from the subject.
 - Operating camera buttons during recording can cause button noise to be included in the audio.
 - Movie audio is recorded in monaural.
 - The camera focuses automatically whenever you have Auto Focus or Macro (AF) selected as the focus mode (page 80). Note that the confirmation tone that sounds during the Auto Focus operation will be recorded in the audio. If you do not want confirmation tones in your audio, keep Pan Focus (PF) as the focus mode, or select Manual Focus (MF) and manually focus the image before starting your recording.



OTHER RECORDING FUNCTIONS

- Auto Focus is not performed in the case of the Pan Focus (PF), Manual Focus (MF) and Infinity (∞) focus modes, and so no confirmation tone sounds. In the case of the Manual Focus mode, you cannot adjust focus settings while recording is in progress. Be sure to make all adjustments before beginning the record operation.
- Certain types of memory cards take longer to record data, which can cause movie frames to be dropped.  and  flash on the monitor screen during recording to let you know when a frame has been dropped.

Recording Audio

Adding Audio to a Snapshot

You can add audio to a snapshot after you record it.

- **Image Format: JPEG**
JPEG is an image format that provides efficient data compression.
The file extension of a JPEG file is “.JPG”.
- **Audio Format: WAVE/ADPCM recording format**
This is the Windows standard format for audio recording.
The file extension of a WAVE/ADPCM file is “.WAV”.
- **Recording Time:**
Up to about 30 seconds per image
- **Audio File Size:**
Approximately 120KB (30-second recording of approximately 4KB per second)

OTHER RECORDING FUNCTIONS

NOTE

- You can play back an audio file recorded in the Audio Snapshot mode on your computer using Windows Media Player.
- Recording audio for a snapshot creates two separate files: one for the image data and one for the audio data. Each file is stored in a different folder in camera memory (page 228).

- 1. In a REC mode, press [MENU].**
- 2. Select the “REC” tab, select “Audio Snap”, and then press [▶].**
- 3. Use [▲] and [▼] to select “On” and then press [SET].**
 - This enters the Audio Snapshot mode.
 - Selecting “Off” enters the Normal Snapshot mode (no audio).

4. Press the shutter button to record the image.

- After the image is recorded, the camera enters audio recording standby, with the image you just recorded on the monitor screen and displays a  indicator.
- You can cancel audio recording standby by pressing [MENU].



Remaining recording time

5. Press the shutter button to start audio recording.

- The green operation lamp flashes as recording is performed.
- If you have the monitor screen turned off (page 34), the monitor screen turns on while you are adding audio to a snapshot.

6. Recording stops after about 30 seconds or when you press the shutter button.

▶▶ IMPORTANT! ◀◀

- The Audio Snapshot mode is unavailable during image recording using any of the following: Triple Self-timer, continuous shutter, auto bracketing, Coupling Shot.
- You can also perform “after-recording” to add audio to a snapshot after recording it, and also change the audio recorded for an image. See page 173 for more information.

Recording Your Voice

The Voice Recording mode provides quick and easy recording of your voice.

- **Audio Format:** WAVE/ADPCM recording format
This is the Windows standard format for audio recording. The file extension of a WAVE/ADPCM file is “.WAV”.
- **Recording Time:**
Approximately 38 minutes with built-in memory
- **Audio File Size:**
Approximately 120KB (30-second recording of approximately 4KB per second)

▶▶ NOTE ◀◀

- You can play back files recorded in the Voice Recording mode on your computer using Windows Media Player.

OTHER RECORDING FUNCTIONS

1. Align the mode dial with “U”.

- This enters the Voice Recording mode and displays a  indicator.

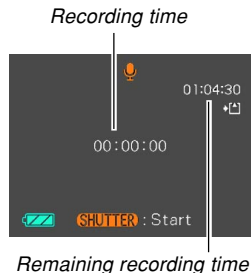

2. Press the shutter button to start voice recording.

- The remaining recording time value counts down on the monitor screen and the green operation lamp flashes as recording is performed.
- Pressing [DISP] during voice recording turns off the monitor screen.
- You can insert index marks while recording by pressing [SET]. See page 175 for information about jumping to an index mark during playback.

3. Recording stops when you press the shutter button, when memory becomes full, or when the battery goes dead.

■ Audio Recording Precautions

- Keep the microphone on the front of the camera pointed at the source.
- Take care that you do not block the microphone with your fingers.

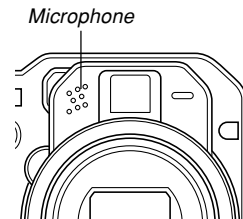

- Good recording results are not possible when the camera is too far from the subject.
- Pressing the power button or rotating the mode dial stops recording and stores any audio recorded up to that point.

Using the Histogram

You can use [DISP] to display a histogram on the monitor screen. The histogram lets you check exposure conditions as you record images (page 34). You can also display the histogram of a recorded image in the PLAY mode.

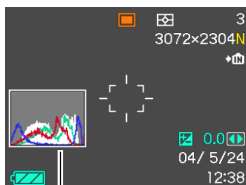

Histogram

- A histogram is a graph that represents the lightness of an image in terms of the number of pixels. The vertical axis indicates the number of pixels, while the horizontal axis indicates lightness. You can use the histogram to determine whether an image includes the shadowing (left side), mid tones (center), and highlighting (right) required to bring out sufficient image detail. If the histogram appears too lopsided for some reason, you can use EV shift (exposure compensation) to move it left or right in order to achieve better balance. Optimum exposure can be achieved by correcting exposure so the graph is as close to the center as possible.

- An RGB histogram that shows the distribution of R (red), G (green), and B (blue) components is also displayed. This histogram can be used to determine whether there is too much or too little of each of the color components in an image.

NOTE

- You can use key customization (page 140) to configure the camera to perform exposure compensation whenever you press [◀] or [▶] while in a REC mode. If you do this, you can adjust exposure compensation while viewing the on-screen histogram (page 88).
- When the histogram is too far to the left, it means that there are too many dark pixels. This type of histogram results when the overall image is dark. A histogram that is too far to the left may result in “black out” of the dark areas of an image.



OTHER RECORDING FUNCTIONS

- When the histogram is too far to the right, it means that there are too many light pixels.

This type of histogram results when the overall image is light. A histogram that is too far to the right may result in “white out” of the light areas of an image.

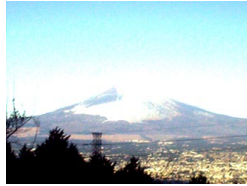

- A centered histogram indicates that there is good distribution of light pixels and dark pixels. This type of histogram results when the overall image is at optimal lightness.

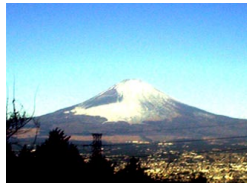

▶▶ IMPORTANT! ◀◀

- Note that the above histograms are shown for illustrative purposes only. You may not be able to achieve exactly the same shapes for particular subjects.
- A centered histogram does not necessarily guarantee optimum exposure. The recorded image may be over-exposed or under-exposed, even though its histogram is centered.
- You may not be able to achieve an optimum histogram configuration due to the limitations of EV shift.
- Use of the flash as well as certain shooting conditions can cause the histogram to indicate exposure that is different from the actual exposure of the image when it was recorded.
- The RGB (color component) histogram is displayed for snapshots only. In the Movie mode, only the luminance distribution histogram appears on the monitor screen.

REC Mode Camera Settings

The following are the settings you can configure before recording an image using a REC mode.

- ISO sensitivity
- Auto Focus mode (AF mode)
- Metering
- Color filtering
- Sharpness
- Saturation
- Contrast
- Grid on/off
- Image Review on/off
- Icon Help
- L/R key setting
- Power on default settings
- Resetting the camera

NOTE

- You can also configure the settings listed below. See the referenced pages for more information.
 - Size (page 77)
 - Quality (page 78)
 - White Balance (page 90)
 - AF Area (page 82)
 - Audio Snap (page 126)
 - Flash Intensity (page 73)
 - Flash Assist (page 73)
 - Digital Zoom (page 69)

Specifying ISO Sensitivity

You can change the ISO sensitivity setting for better images in places where lighting is dim or when you are using faster shutter speeds.

- ISO sensitivity is expressed in terms of values that originally indicated the sensitivity to light for photographic film. A larger value indicates higher sensitivity, which is better for recording when available lighting is dim.

1. In a REC mode, press [MENU].
2. Select the “REC” tab, select “ISO”, and then press [▶].
3. Use [▲] and [▼] to select the setting you want and then press [SET].

To get this:	Select this setting:
Automatic sensitivity selection	Auto
Conforms to ISO 80	ISO 80
Conforms to ISO 160	ISO 160
Conforms to ISO 320	ISO 320
Conforms to ISO 640	ISO 640

►► IMPORTANT! ◀◀

- Under certain conditions, a high shutter speed in combination with a high ISO sensitivity setting can cause digital noise (graininess), which makes an image appear rough. For clean, good-quality images, use the lowest ISO sensitivity setting possible.
- Using a high ISO sensitivity setting along with the flash to shoot a nearby subject may result in improper illumination of the subject.

►► NOTE ◀◀

- You can use key customization (page 140) to configure the camera so the ISO sensitivity setting changes whenever you press [◀] and [▶] while in a REC mode.

Selecting the Auto Focus (AF) Mode

Use the following procedure to change the AF mode.

1. In a REC mode, press [MENU].
2. Select the “REC” tab, select “AF Mode”, and then press [▶].
3. Use [▲] and [▼] to select the setting you want, and then press [SET].

To perform this type of Auto Focus:	Select this AF mode:
Combination of phase difference and contrast focus • Normally, you should use this mode.	Hybrid
At normal distance, high-speed continual focus	Continuous
Contrast type Auto Focus, which allows Auto Focusing capabilities even if the phase differential sensor is blocked	Contrast

▶▶ IMPORTANT! ◀◀

- Use of Continuous AF performs focus non-stop, so battery power runs down faster than with Hybrid AF.
- Even if “Hybrid” or “Continuous” is selected as the AF mode, the camera automatically uses the contrast AF for focusing when “Free” is selected for the Auto Focus area setting (page 82).
- Be sure to use Contrast AF whenever you have a telephoto conversion, wide angle conversion, or close-up lens installed (page 153). Note that Contrast AF is slower to focus than Hybrid AF.

Selecting the Metering Mode

Use the following procedure to specify multi (multi pattern) metering, spot metering, or center weighted metering as the metering mode.

1. In a REC mode, press [MENU].
2. Select the “REC” tab, select “Metering”, and then press [▶].
3. Use [▲] and [▼] to select the setting you want, and then press [SET].

Multi (Multi pattern)

Multi (Multi pattern) metering divides the image into sections and measures the light in each section for a balanced exposure reading. The camera automatically determines shooting conditions according to the measured lighting pattern, and makes exposure settings accordingly. This type of metering provides error-free exposure settings for a wide range of shooting conditions.



Center Weighted

Center weighted metering measures light concentrating on the center of the focus area. Use this metering method when you want to exert some control over exposure, without leaving settings totally up to the camera.



Spot

Spot metering takes readings at a very small area. Use this metering method when you want exposure to be set according to the brightness of a particular subject, without it being affected by surrounding conditions.



▶▶ IMPORTANT! ◀◀

- When “Multi” is selected as the metering mode, certain procedures cause the metering mode setting to change automatically as described below.
- Changing the exposure compensation setting (page 88) to a value other than 0.0 changes the metering mode setting to “Center Weighted.” The metering mode changes back to “Multi” when you return the exposure compensation setting to 0.0.

Using the Filter Function

The camera's filter function lets you alter the tint of an image when you record it.

1. In a REC mode, press [MENU].
2. Select the "REC" tab, select "Filter", and then press [▶].
3. Use [▲] and [▼] to select the setting you want, and then press [SET].
 - Available filter settings are: Off, B/W, Sepia, Red, Green, Blue, Yellow, Pink, Purple

▶▶ IMPORTANT! ◀◀

- Using the camera's filter feature produces the same effect as attaching a color filter to the lens.

Specifying Outline Sharpness

Use the following procedure to control the sharpness of image outlines.

1. In a REC mode, press [MENU].
2. Select the "REC" tab, select "Sharpness", and then press [▶].
3. Use [▲] and [▼] to select the setting you want, and then press [SET].

To get this:	Select this setting:
High sharpness	+2
↑	+1
Normal sharpness	0
↓	-1
Low sharpness	-2

Specifying Color Saturation

Use the following procedure to control the intensity of the image you are recording.

1. In a REC mode, press [MENU].
2. Select the “REC” tab, select “Saturation”, and then press [▶].
3. Use [▲] and [▼] to select the setting you want, and then press [SET].

To get this:	Select this setting:
High color saturation (intensity)	+2
↑	+1
Normal color saturation (intensity)	0
↓	-1
Low color saturation (intensity)	-2

Specifying Contrast

Use this procedure to adjust the relative difference between the light areas and dark areas of the image you are recording.

1. In a REC mode, press [MENU].
2. Select the “REC” tab, select “Contrast”, and then press [▶].
3. Use [▲] and [▼] to select the setting you want, and then press [SET].

To get this:	Select this setting:
High contrast	+2
↑	+1
Normal contrast	0
↓	-1
Low contrast	-2

Turning the On-screen Grid On and Off

You can display gridlines on the monitor screen to help you compose images and ensure that the camera is straight when recording.



1. In a REC mode, press [MENU].
2. Select the “REC” tab, select “Grid”, and then press [▶].
3. Use [▲] and [▼] to select the setting you want, and then press [SET].

To do this:	Select this setting:
Display the grid	On
Hide the grid	Off

Turning Image Review On and Off

Image review displays the images you record on the monitor screen as soon as you record them. Use the following procedure to turn image review on and off.

1. In a REC mode, press [MENU].
2. Select the “REC” tab, select “Review”, and then press [▶].
3. Use [▲] and [▼] to select the setting you want, and then press [SET].

To do this:	Select this setting:
Display images on the monitor screen for about one second immediately after they are recorded	On
Do not display images immediately after they are recorded	Off

Using Icon Help

Icon Help displays guidance text about an icon when you select it on the monitor screen while in a REC mode (page 29).

- Icon Help text is displayed for the following functions: current recording mode, flash mode, focus mode, white balance, self-timer/remote controller mode, metering mode.

Note, however, that white balance and metering icon help text appears only when “White Balance” or “Metering” is assigned to the [◀] and [▶] keys with the key customization feature (page 140).

1. In a REC mode, press [MENU].
2. Select the “REC” tab, select “Icon Help”, and then press [▶].
3. Use [▲] and [▼] to select the setting you want, and then press [SET].

To do this:	Select this setting:
Display guidance text when you select an icon on the monitor screen	On
Turn off Icon Help	Off

▶▶ IMPORTANT! ◀◀

- Selecting one of the following settings causes the icon and its Icon Help text to appear momentarily on the monitor screen. The icon and text disappear after a short while.
 - Flash mode **FA** (Auto) icon (page 71)
 - Focus mode **AF** (Auto Focus) icon (page 80)
 - White balance **AWB** (Auto) icon (page 90)

Assigning Functions to the [◀] and [▶] Keys

A “key customization” feature lets you configure the [◀] and [▶] keys so they change camera settings whenever they are pressed in a REC mode. After you configure the [◀] and [▶] keys, you can change the setting assigned to them without going through the menu screen.

1. In a REC mode, press [MENU].
2. Select the “REC” tab, select “L/R Key”, and then press [▶].
3. Use [▲] and [▼] to select the setting you want, and then press [SET].

When you want to assign this function to [◀] and [▶] keys:	Select this:
EV shift • [◀] decreases compensation, [▶] increases compensation (page 88).	EV Shift
White balance setting • [◀] and [▶] cycle through white balance settings (page 90).	White Balance
ISO sensitivity • [◀] and [▶] cycle through ISO sensitivity settings (page 133).	ISO
Metering mode • [◀] and [▶] cycle through metering modes (page 135).	Metering
AF Area • [◀] and [▶] cycle through AF areas (page 82).	AF Area
No function assigned	Off

Specifying Power On Default Settings

The camera's "mode memory" feature lets you specify the power on default settings individually for the flash mode, focus mode, white balance mode, ISO sensitivity, AF Area, Metering, Self-timer, Cont./BKT, Flash Intensity, digital zoom mode, manual focus position and zoom position. Turning on mode memory for a mode tells the camera to remember the status of that mode when you turn off the camera, and restore it the next time you turn the camera back on. When mode memory is turned off, the camera automatically restores the initial factory default setting for the applicable mode.

The following table shows what happens when you turn mode memory on or off for each mode.

Function	On	Off
Flash	Setting when camera is turned off	Auto
Focus* ¹		Auto
White Balance		Auto
ISO		Auto
AF Area		Spot
Metering		Multi
Self-timer		Off
Cont./BKT		1 Shot
Flash Intensity		0
Digital Zoom		On
MF Position		Last Auto Focus position that was in effect before you switched to manual focus
Zoom Position* ²		Wide Angle

*1 The focus mode setting is not remembered for the Movie mode. PF (Pan Focus) is automatically selected in the Movie mode.

*2 Only the optical zoom position is remembered.

OTHER RECORDING FUNCTIONS

1. In a REC mode, press [MENU].
2. Use [◀] and [▶] to select the “Memory” tab.
3. Use [▲] and [▼] to select the item you want to change, and then press [▶].
4. Use [▲] and [▼] to select the setting you want, and then press [SET].

To do this:	Select this setting:
Turn on mode memory so settings are restored at power on	On
Turn off mode memory so settings are initialized at power on	Off

►► IMPORTANT! ◀◀

- If you change the BESTSHOT mode sample scene selection or if you turn off the camera while it is in the BESTSHOT mode, the camera's setup (except for “Zoom Position”) will be configured according to the BESTSHOT sample scene settings when you turn it back on again. This is true, regardless of mode memory on/off settings.
- If you turn the camera off while in the Movie mode, the flash will be turned off when you turn the camera back on again, regardless of mode memory on/off setting for the flash.

Resetting the Camera

Use the following procedure to reset all of the camera's settings to their initial defaults as shown under "Menu Reference" on page 249.

1. In a REC mode or the PLAY mode, press [MENU].
2. Select the "Set Up" tab, select "Reset", and then press [▶].
3. Use [▲] and [▼] to select "Reset", and then press [SET].
 - To cancel the procedure without resetting, select "Cancel" and press [SET].

Using the Shortcut Menu (EX Menu)



Pressing [EX 

1. In a REC mode, press [EX 

2. Use [◀] and [▶] to select the item you want, and then use [▲] and [▼] to scroll through the available settings.
 - Refer to the following pages for details about each of the settings.
 - Adjusting the White Balance (page 90)
 - Specifying ISO Sensitivity (page 133)
 - Specifying the Metering Mode (page 135)
 - Specifying the Auto Focus Area (page 82)
3. After configuring the settings you want, press [SET] to exit the shortcut menu.

OTHER RECORDING FUNCTIONS

»» NOTE ««

- You can also configure a setting by holding down [EX , selecting the item you want with [◀] and [▶], and then changing the setting with [▲] and [▼]. The setting is applied when you release [EX ].

Using the Card Remote Controller for Recording

You can use the card remote controller (WR-4C) that comes with the camera when recording. By mounting the camera on a tripod and using the remote shutter release, you can eliminate the chance of blurred images due to accidental hand movement.

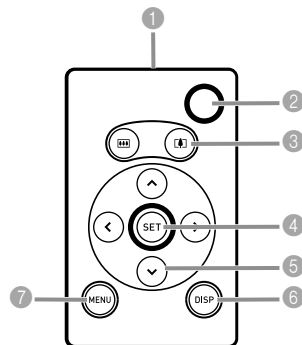

- 1 Signal emitter
- 2 Shutter button
- 3 Zoom button
- 4 SET button
- 5 Control buttons
- 6 DISP button
- 7 MENU button

Loading the Battery

You need to load a lithium battery (CR2025) into the card remote controller before you can use it to control the camera.

1. While pressing point (A) in the direction indicated by the arrow, pull the battery holder from the remote controller.

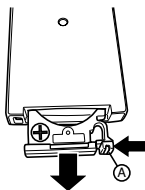

2. Wipe the surfaces of the battery with a soft, dry cloth, and then place it onto the battery holder so its positive (+) side is facing upwards (so you can see it).

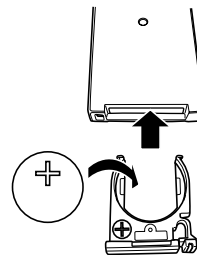

3. Slide the battery holder back into the remote controller.



▶▶ IMPORTANT! ◀◀

- Take care to ensure that the battery is not accidentally swallowed when it is removed from the remote controller. Particular care is required where young children are present.
- Keep this button battery out of the reach of small children. If swallowed accidentally, contact your physician immediately.

Before Using the Card Remote Controller for Recording



Be sure to perform the following steps before using the card remote controller for recording.

1. In a REC mode, use to select the card remote controller mode you want to use.

- Enabling the card remote controller for recording causes either  or  to appear on the monitor screen.

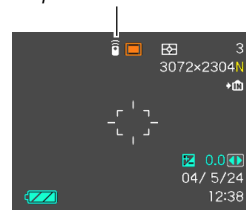
Remote controller operation enabled



-  : Pressing the remote controller's shutter button immediately releases the shutter.
-  : Pressing the remote controller's shutter button releases the shutter about two seconds later (same as the 2-second self-timer).

▶▶ IMPORTANT! ◀◀

- The “” setting is useful when you want to be part of the image you are recording. The delay gives you time to look at the camera after operating the remote controller.
- The remote controller can be used in the PLAY mode and the Voice Recording mode, regardless of the Triple Self-timer setting.

Using the Card Remote Controller

Point the signal emitter on the remote controller at the camera's signal receiver (front or side), and perform the operation you want.

Card remote controller button operations are identical to those of the corresponding camera buttons.

- The range of the card remote controller is normally about five meters on a straight line between the signal emitter and front camera signal receiver, and about one meter from an angle to the right of the front of the camera.

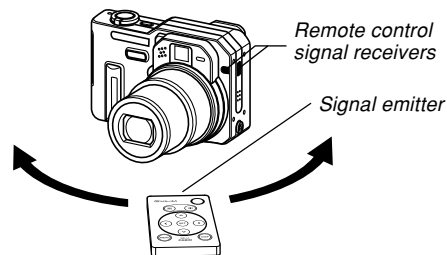

OTHER RECORDING FUNCTIONS

►► IMPORTANT! ◀◀

- Any one of the following conditions can reduce the range for remote controller operations.
 - When the card remote controller signal emitter is at an angle to the camera's signal receiver
 - When the camera is exposed to bright light
 - When the card remote controller battery is low
 - Unlike the camera's shutter button, you cannot press the remote controller shutter button half way. Pressing the remote controller shutter button causes the camera to perform an auto focus operation and then record the image.
 - Contrast type Auto Focus, which allows Auto Focusing capabilities even if the phase differential sensor is blocked
 - When performing a high-speed continuous shutter mode operation with the card remote controller, keep the shutter button of the card remote controller depressed until all of the images (up to five) are recorded. If you want to stop recording part way through, release the shutter button.
 - A continuous shutter or auto bracketing record operation may be interrupted part way through if remote control signal reception is interfered with or if the card remote controller battery goes low.
- When using the card remote controller for "BULB" recording (pages 95, 96), press the card remote controller shutter button once to start exposure, and a second time to stop exposure. This is different from the operation using the camera's shutter button, which you must keep depressed as long as you want exposure to be performed. Note that card remote controller shutter button operations are different from camera shutter button operations.
 - Installing a conversion lens on the camera can cause the signal receiver on the front of the camera to become blocked. Point the card remote controller at the signal receiver on the side of the camera in this case (page 153).

Using an External Flash

Use of a commercially available flash unit makes it possible to obtain a higher level of brightness (guide number) than you get when using the built-in flash alone. An external flash also makes it possible to extend the effective range of flash photography.

- The guide number of the internal flash is 8 (ISO 80/m).

External Flash Unit Requirements

Any external flash unit you use with this camera must satisfy the following requirements.

- Variable flash intensity (AUTO)
- Flash Duration: Less than 1/1000 sec.
- Coverage Angle: Coverage of 33mm equivalent 35mm focal length lens (without wide conversion lens)

►► IMPORTANT! ◀◀

- Some flash performance may be lost when using a ring flash or other type of unit with a long flash time.
- The aperture value and ISO sensitivity available with some flash units may not match the values supported by your camera. In such a case, make adjustments in the aperture setting of the external flash and the camera until proper brightness is achieved.

Before Using an External Flash Unit

Be sure to perform the following steps before using an external flash unit.

1. In a REC mode, press [MENU].
2. Select the “REC” tab, select “External flash”, and then press [▶].
3. Use [▲] and [▼] to select “On”, and then press [SET].

To do this:	Select this setting:
Enables firing of an external flash.	On
Disables firing of an external flash.	Off

▶▶ IMPORTANT! ◀◀

- Note that the brightness of what you see on the monitor screen will be different from the brightness of the image you record. Make sure you check the settings of your external flash and of the camera before recording.
- Turning the camera’s external flash setting on and off not only determines whether or not a connected external flash fires, it also changes the setup of the camera. Make sure you always turn the external flash setting off whenever you are not using an external flash unit for recording.

Using an External Flash Unit

►► IMPORTANT! ◀◀

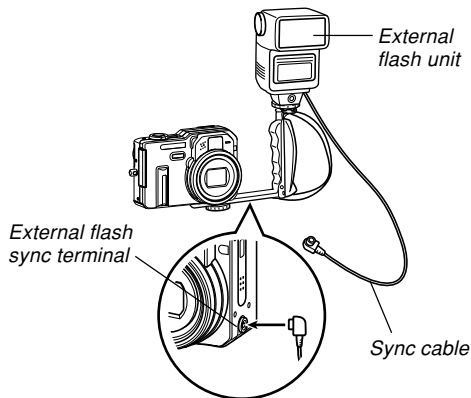

- Always make sure that the external flash unit is turned off before attaching it to or detaching it from the camera. Leaving the flash unit on can cause it to fire unexpectedly.

1. Attach the flash unit's sync cable to the camera's external flash sync terminal.



- When attaching an external flash unit to the camera, you should also purchase and install a gripped bracket that can be secured to the camera's tripod hole.

2. Turn on camera power and make the required camera settings.

- Exposure Mode: M (Manual Exposure) mode
- Shutter Speed: Around 1/60 (Actual setting should be in accordance with aperture setting.)
- For maximum brightness of areas that are not reached by flash illumination, use the camera's maximum aperture opening (F2.8).
- White Balance:  (Daylight)
- Flash Mode:  (Off)

3. Turn on the external flash unit, and set it up for the camera's aperture (F) value (pages 93, 96) and sensitivity (ISO 80 equivalent) value.

- Depending on shooting conditions, proper exposure may not be obtained even if you properly set the auto aperture (F) value and ISO sensitivity of the flash unit to match those of the camera. If this happens, adjust the auto aperture (F) value, ISO sensitivity, or other settings of the flash unit. Also try adjusting the aperture of the camera.

External Flash Precautions

- The external flash connected to the external flash sync terminal always fires. To record an image without using external flash, disconnect the sync cable from the terminal or turn off external flash unit power.
- After recording an image, check it on the monitor screen. If it is not what you expected, use the controls on the external flash unit to adjust flash intensity, and adjust the aperture and ISO sensitivity settings on the camera. Note that you cannot control external flash unit intensity using camera settings.
- Close up images often tend to be overexposed. If you are having overexposure problems, try adjusting the aperture and ISO sensitivity settings of the external flash unit and the camera. You can also try using the camera's built in flash to correct for overexposure.
- Note that the camera's built in flash fires whenever its Flash mode setting is something other than  (Off).
- Camera aperture (F) values are based on the widest optical zoom (1X). Using telephoto can cause slight lens darkness. Adjust the aperture and ISO sensitivity settings of the external flash unit and the camera as required when using optical zoom.
- When using a zoom flash, a coverage angle for a focal distance of 33mm or less for the flash unit is recommended.

OTHER RECORDING FUNCTIONS

Using a Conversion Lens or Filter

Installing the optionally available Conversion Lens Adaptors (LU-60A) on the camera makes it possible to use a recommended conversion lens or close-up lens, or a commercially available filter for recording.

- The Conversion Lens Adaptors (LU-60A) includes a TELE CONVERTER ADAPTOR and a WIDE CONVERTER ADAPTOR.
- The Canon Inc. conversion lenses and close-up lenses described below are recommended for use with this camera.

● Telephoto

Focal Distance: 1.5X the focal distance of the camera
The distance from the surface of the Tele Converter to the subject can be in the range of one meter to infinity (at full zoom).

Canon Tele Converter TC-DC58

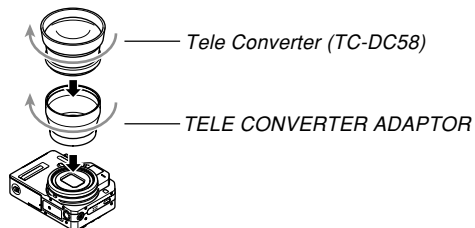

● Wide Angle

Focal Distance: 0.7X the focal distance of the camera
Canon Wide Converter WC-DC58N

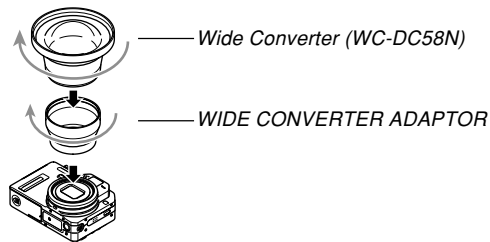

● Macro

In the Macro mode, the allowable distance from the close up lens surface to the subject is 6 cm (2.4") to 25.1 cm (9.9") (when zoom is set to maximum wide angle).

Canon Close-up Lens 250D (58mm)

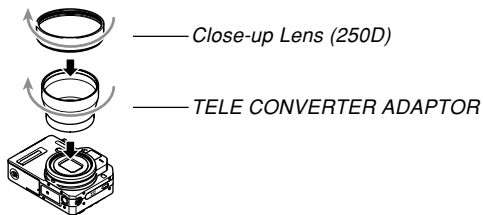

Installing a Conversion Lens or Close-up Lens

A conversion lens provides your camera with telephoto or wide angle capabilities. A close-up lens enables macro photography.

1. Turn off the camera, and then remove the lens ring installed on its lens.

- If you experience difficulty when trying to remove the lens ring, try grasping it lightly with the tips of your thumb, forefinger, middle finger, and ring finger when you rotate it. Grasping the lens ring strongly with your thumb and forefinger can put pressure on the ring and camera threads, making it difficult to rotate the lens ring.

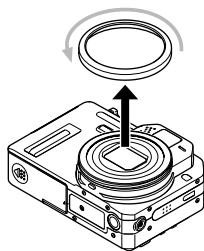

3. Install a conversion lens or close-up lens on the camera.



►► IMPORTANT! ◀◀

- Installing a conversion lens or close-up lens can cause blackening around the edges of the image, which can interfere with proper operation of the camera's phase differential sensor. Before recording an image, be sure to select "Contrast" for the Auto Focus mode. See "Selecting the Auto Focus (AF) Mode" on page 134 for more information.

►► NOTE ◀◀

- Installing or removing the lens ring while the camera is turned on will cause it to turn off automatically.

■ Conversion Lens and Close-up Lens Precautions

- Be sure to install the TELE CONVERTER ADAPTOR or WIDE CONVERTER ADAPTOR before installing a conversion lens or close-up lens.
 - Carefully read the user documentation that comes with the conversion lenses and close-up lens for information about how to use them properly.
 - Be sure to use the monitor screen to compose images while a conversion lens or close-up lens is installed on the camera. Do not use the viewfinder, because its image is not changed by the lens you are using. Also, there will be darkening around the edges of the image within the viewfinder.
 - Installing a conversion lens or close-up lens can interfere with proper operation of the camera's built-in flash. When using a conversion lens or close-up lens, select  (Off) for the flash mode or use an external flash (page 149).
 - When using a telephoto conversion lens, select Auto Focus as the focus mode (page 80).
 - Using optical zoom to select wide angle while a telephoto conversion lens is installed can cause blackening around the edges of the image. Set optical zoom to telephoto (page 68).
 - Use of a tripod is recommended to avoid camera movement during recording with a telephoto conversion lens.
- When installing a wide angle conversion lens, be sure to turn off the camera so the lens is retracted. This protects against scratching of the lens.
 - When using a wide angle conversion lens, select Auto Focus or Macro () as the focus mode (page 80).
 - The wide angle conversion lens may cause distortion of an image.
 - When using a close-up lens, be sure to set the focus mode to Macro () (page 80). Proper focus of a close-up image is not possible with any other focus mode.

■ Optical Zoom Precautions

- Optical zoom is possible only up to about 2X while a wide converter is installed. This is to prevent damage to the wide converter by contact with the camera lens as it extends.

▶▶ IMPORTANT! ◀◀

- Be sure to reinstall the lens ring on the camera lens when you are not using a conversion lens. Optical zoom is possible only up to about 2X while the lens ring is not installed properly, even if the camera does not have the wide converter installed.

Installing a Filter

This camera supports use of commercially available 58mm filters.

▶▶ IMPORTANT! ◀◀

- Be sure to install the TELE CONVERTER ADAPTOR before installing a filter. If you attach a filter directly to the lens without the TELE CONVERTER ADAPTOR, the convex surface of the lens will come into contact with the filter and damage it.
- Carefully read the user documentation that comes with filters for information about how to use them properly.
- Keep the following points in mind when purchasing a filter.
 - Use of a filter can cause blackening around the edges of images.
 - Use of a filter may interfere with proper operation of Auto Focus and flash.
 - Filters may not deliver the same results as those obtained with a film camera.
- Do not use multiple filters.
- Use of a commercially available lens hood may cause blackening around the edges of images.

PLAYBACK

You can use the camera's built-in monitor screen to view images after you record them.

Basic Playback Operation

Use the following procedure to scroll through files stored in the camera's memory.

1. Press the power button to turn on the camera.

- This causes an image or a message to appear on the monitor screen.

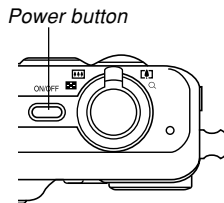

2. Align the mode dial with "▶" (PLAY mode).

- This enters the PLAY mode.

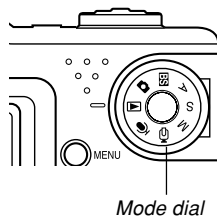

3. Use [▶] (forward) or [◀] (back) to scroll through files on the monitor screen.



NOTE

- Holding down [◀] or [▶] scrolls images at high speed.
- In order to allow for faster playback image scrolling, the image that initially appears on the monitor screen is a preview image, which is of somewhat lower quality than the actual display image. The actual display image appears a short while after the preview image. This does not apply to images copied from another digital camera.

Playing an Audio Snapshot

Perform the steps below to display an audio snapshot (indicated by ) and play its audio.

1. In the PLAY mode, use [◀] and [▶] until the image you want is displayed.

2. Press [SET].

- This plays back the audio that accompanies the displayed image.
- You can perform the following operations while audio is playing.



To do this:	Do this:
Fast forward or fast reverse the audio	Hold down [◀] or [▶].
Pause and unpauses audio playback	Press [SET].
Adjust audio volume	Press [▲] or [▼].
Cancel playback	Press [MENU].

▶▶ IMPORTANT! ◀◀

- Audio volume can be adjusted only when playback is being performed or is paused.

Zooming the Display Image

Perform the following procedure to zoom the image currently on the monitor screen up to eight times its normal size.

1. In the PLAY mode, use [◀] and [▶] to display the image you want.

2. Shift the zoom controller towards  to enlarge the image.

- This displays an indicator that shows the current zoom factor.
- You can toggle display of the zoom factor on and off by pressing [DISP].



Current zoom factor

3. Use [▲], [▼], [◀], and [▶] to shift the image up, down, left, or right.

4. Press [MENU] to return the image to its original size.

▶▶ IMPORTANT! ◀◀

- You cannot zoom a movie image.
- Depending on the original size of the recorded image, you may not be able to zoom a display image the full eight times normal size.

Resizing an Image

You can use the following procedure to change a snapshot image to one of the three sizes.

1600 × 1200-pixel UXGA size

1280 × 960-pixel SXGA size

640 × 480-pixel VGA size

- VGA is the optimum image size for attachment to e-mail messages or incorporation into Web pages.

1. In the PLAY mode, press [MENU].

2. Select the “PLAY” tab, select “Resize”, and then press [▶].

- Note that this operation is possible only when a snapshot image is on the monitor screen.



4. Use [▲] and [▼] to select the setting you want, and then press [SET].

To do this:	Select this:
Resize to 1600 × 1200 pixels (UXGA)	1600 × 1200
Resize to 1280 × 960 pixels (SXGA)	1280 × 960
Resize to 640 × 480 pixels (VGA)	640 × 480
Cancel the resizing operation	Cancel

▶▶ IMPORTANT! ◀◀

- Resizing an image creates a new file that contains the image in the size you select. The file with the original image also remains in memory.
- Images smaller than 640×480 pixels cannot be resized.
- An image recorded using the 3072×2048 (3:2) pixel size cannot be resized.
- Movie images and the voice recording file icon cannot be resized.
- Note that you can resize snapshots recorded with this camera only.
- If the message “This function is not supported for this file.” appears, it means that the current image cannot be resized.
- The resize operation cannot be performed if there is not enough memory to store the resized image.
- When you display a resized image on the camera’s monitor screen, the date and time that appears when the image is displayed indicates when the image was originally recorded, not when the image was resized.

Cropping an Image

Use the following procedure when you want to crop a portion of an enlarged image and use the remaining part of the image as an e-mail attachment, Web page image, etc.

1. In the PLAY mode, use [◀] and [▶] to scroll through images and display the one you want to crop.

2. Press [MENU].

3. Select the “PLAY” tab, select “Trimming”, and then press [▶].

- This causes a cropping boundary to appear.
- Note that this operation is possible only when a snapshot image is on the monitor screen.



4. Use the zoom controller to make the cropping boundary larger or smaller.

- The size of the cropping boundary depends on the size of the image on the display.

5. Use [▲], [▼], [◀], and [▶] to move the cropping boundary up, down, left, or right until the area of the image you want to extract is within the boundary.
6. Press [SET] to extract the part of the image enclosed in the cropping boundary.
 - If you want to cancel the procedure at any point, press [MENU].

▶▶ IMPORTANT! ◀◀

- Cropping an image creates a new file that contains the cropped image. The file with the original image also remains in memory.
- The smaller the image, the more limited is the size of the cropping boundary.
- You cannot resize the cropping boundary for an image that is 640×480 pixels.
- An image recorded using the 3072×2048 (3:2) pixel size cannot be cropped.
- Movie images and the voice recording file icon cannot be cropped.
- An image recorded using another camera model cannot be cropped.
- If the message "This function is not supported for this file." appears, it means that the current image cannot be cropped.
- The cropping operation cannot be performed if there is not enough memory to store the cropped image.
- When you display a cropped image on the camera's monitor screen, the date and time that appears when the image is displayed indicates when the image was originally recorded, not when the image was cropped.

Checking the Focus of a Recorded Image

You can use the following procedure to enlarge a recorded image to check its focus.

1. In the **PLAY** mode, use [**◀**] and [**▶**] to display the image whose focus you want to check.



2. Press [**PREVIEW**].

- This displays a window that shows an enlargement of the image, with the point that was focused upon in the center.

3. Use [**▲**], [**▼**], [**◀**], and [**▶**] to scroll the image on the monitor screen.

4. To return the image to its normal size, press [**PREVIEW**].

▶▶ IMPORTANT! ◀◀

- You can use the above procedure to check the focus of snapshots and audio snapshots only.
- You cannot check the focus of images recorded by any other camera model.

Playing a Movie

Use the following procedure to play back a movie that was recorded in the Movie mode.

1. In the **PLAY** mode, press [**◀**] and [**▶**] to scroll through images until the movie you want to play is displayed.



2. Press [**SET**].

- This start playback of the movie.
- You can perform the following operations while a movie is playing.

To do this:	Do this:
Fast forward or fast reverse the movie	Hold down [◀] or [▶].
Pause and unpause movie playback	Press [SET].
Skip forward or back one frame while paused	Press [◀] or [▶].
Cancel playback	Press [MENU].
Adjust audio volume	Press [▲] or [▼].

▶▶ IMPORTANT! ◀◀

- You cannot repeat play a movie. To play a movie more than once, repeat the steps of the above procedure.
- Audio volume can be adjusted only when playback is being performed or is paused.

Displaying the 9-image View

The following procedure displays nine images on the monitor screen at the same time.

1. In the PLAY mode, shift the zoom controller towards .

- This displays the 9-image screen with the image that was on the monitor screen in step 2 in the center, with a selection boundary around it.
- On the 9-image screen,  indicates a voice recording file (page 175).
- If there are fewer than nine images in memory, they are displayed starting from the upper left corner. The selection boundary is located at the image that was on the display before you switched to the 9-image view.

2. Use [, [, [, and [] to move the selection boundary to the image you want. Pressing [] while the selection boundary is in the right column or [] while it is in the left column scrolls to the next full screen of nine images.

Example: When there are 20 images in memory, and Image 1 is displayed first

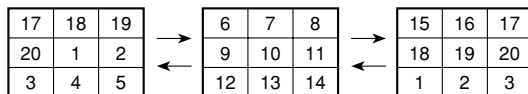

3. Pressing any button besides [, [, [, or [] displays the full-size version of the image where the selection boundary is located.

Selecting a Specific Image in the 9-image View

1. Display the 9-image view.

2. Use [▲], [▼], [◀], and [▶] to move the selection boundary up, down, left, or right until it is located at the image you want to view.

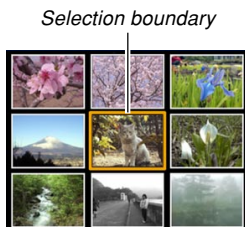

3. Pressing any button besides [▲], [▼], [◀], or [▶] displays the selected image.

- This displays the full-size version of the image you selected.



Displaying the Calendar Screen

Use the following procedure to display a 1-month calendar. Each day shows the first image recorded on that day, which makes it easy to find the image you want.

1. In the PLAY mode, press [⏏].



- You can also display the calendar screen by pressing [MENU] in the PLAY mode, selecting "Calendar" on the "PLAY" tab, and then pressing [▶].

2. Use [▲], [▼], [◀], and [▶] to move the date selection cursor.

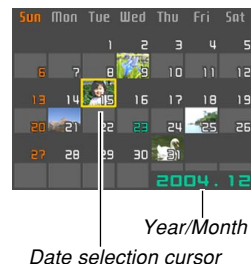
- Use the procedure under "Changing the Date Format" on page 194 to specify the date format.
- The image displayed on the calendar for each date is the first image that was recorded on that date.



PLAYBACK

- Pressing [▲] while the date selection cursor is located anywhere in the top line of the calendar causes the previous month to appear.
- Pressing [▼] while the date selection cursor is located anywhere in the bottom line of the calendar causes the next month to appear.
- To exit the calendar screen, press [MENU] or [DISP].
- On the calendar screen,  indicates a voice recording file (page 175).
-  appears in place of the image when the date contains data that cannot be displayed by this camera.

3. To view the large version of a date's image, move the date selection cursor to the date and then press [SET].

- This displays the first image that was recorded on the selected date.

Playing a Slideshow

A slideshow automatically plays back images in sequence at a fixed interval.



1. In the PLAY mode, press [MENU].
2. Select the "PLAY" tab, select "Slideshow", and then press [▶].

3. Configure the slideshow settings.

- See the pages indicated below for more information.

For information about configuring this setting:	Go here:
Images	"To specify the slideshow images" on page 169
Time	"To specify the slideshow time" on page 170
Interval	"To set the slideshow interval" on page 170

- To exit the slideshow setting screen and cancel the slideshow, use [▲] and [▼] to select "Cancel" and then press [SET].

4. Use [▲] and [▼] to select "Start", and then press [SET].

- This starts the slideshow.

5. To stop the slideshow, press [SET].

- The slideshow will also stop automatically after the amount of time you specified for "Time" elapses.

▶▶ IMPORTANT! ◀◀

- Note that all buttons are disabled while an image change is in progress. Wait until an image is stopped on the monitor screen before performing a button operation, or hold down the button until the image stops.
- Pressing [◀] during a slideshow will scroll to the previous image, while [▶] scrolls to the next image.
- When the slideshow comes to a movie file, it plays the movie and its audio once and then advances to the next file.
- When the slideshow comes to an audio snapshot or voice recording file, it plays the audio recording once and then advances to the next file.
- While audio is playing, you can use [▲] and [▼] to adjust the volume level.
- Images copied from another digital camera or a computer may take longer time to appear than the slideshow interval time you specify.

To specify the slideshow images

1. Use [▲] and [▼] to select “Images”, and then press [▶].
2. Use [▲] and [▼] to select the setting you want, and then press [SET].

To do this:	Select this setting:
Include all files in file memory in the slideshow	All images
Display a single file	One Image
Include all files in the FAVORITE folder (page 182) in the slideshow	Favorites

3. Use [▲] and [▼] to select “Start”, and then press [SET].
 - This starts the slideshow.
 - The audio of audio snapshots, movies, and voice recording files are also played back during a slideshow.

■ Selecting a Single Image for a Slideshow

When you select “One image” as the slideshow type, the slideshow displays only one image, without changing it.

1. Select “One image”, and then press [▶].
2. Use [◀] and [▶] to scroll through the images until the one you want to use is on the monitor screen.
3. Press [SET] to register your selection and return to the menu screen.

- Pressing [MENU] instead of [SET] returns to the menu screen without registering the setting.



To specify the slideshow time

1. Use [▲] and [▼] to select “Time”.
2. Use [◀] and [▶] to specify the time setting you want, and then press [SET].
 - You can specify a time in the range of 1 to 60 minutes.
3. Use [▲] and [▼] to select “Start”, and then press [SET].
 - This starts the slideshow.

To set the slideshow interval

1. Use [▲] and [▼] to select “Interval”.
2. Use [◀] and [▶] to specify the interval setting you want, and then press [SET].
 - You can specify “MAX”, or a value in the range of 1 to 30 seconds as the interval.
 - When the interval setting is in the range of 1 to 30, the audio of movies, audio snapshots, and voice recording files are played back to the end, even if the recording is longer than the specified interval.
 - When “MAX” is specified for the interval, the audio of movies, audio snapshots, and voice recording files are not played back.
 - When “MAX” is selected for the interval, only the first frame of movie files is played.
3. Use [▲] and [▼] to select “Start”, and then press [SET].
 - This starts the slideshow.

Rotating the Display Image

Use the following procedure to rotate the image 90 degrees and register the rotation information along with the image. After you do this, the image is always displayed in its rotated orientation.

1. In the **PLAY** mode, press **[MENU]**.
2. Select the **“PLAY”** tab, select **“Rotation”**, and then press **[▶]**.
 - Note that this operation is possible only when a snapshot image is on the monitor screen.
3. Use **[◀]** and **[▶]** to scroll through images until the one you want to rotate is on the monitor screen.
4. Use **[▲]** and **[▼]** to select **“Rotate”**, and then press **[SET]**.
 - Each press of **[SET]** rotates the image 90 degrees.

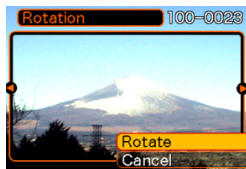





5. After you are finished configuring settings, press **[MENU]** to exit the setting screen.

▶▶ IMPORTANT! ◀◀

- You cannot rotate an image that is protected. To rotate such an image, first unprotect it.
- You may not be able to rotate a digital image that was recorded with another type of digital camera.
- You cannot rotate movie images or the voice recording file icon.

Using Image Roulette

Image Roulette cycles images like a slot machine on the display, before stopping at one of them. When you start an Image Roulette operation, images scroll randomly on the screen. At first, images scroll at high speed. Then the scrolling gradually slows down until a single image is stopped on the screen. The image that finally appears is random.

- 1. Align the mode dial with  (PLAY mode).**
- 2. While the camera is turned off, hold down [] as you press the power button to turn it on.**
 - Keep [] held down until images appear on the monitor screen.
 - This starts the Image Roulette operation, scrolling images on the display, finally stopping at one.
- 3. Press [] or [] to restart the Image Roulette operation.**
- 4. To turn off Image Roulette, align the mode dial to enter a REC mode or press the power button to turn off the camera.**

▶▶ IMPORTANT! ◀◀

- Image Roulette does not play movie files or display the voice recording file icon.
- Image Roulette is disabled when there is only one snapshot image available.
- Note that Image Roulette works only with images recorded with this camera. Image Roulette may not operate properly when other types of images are in memory.
- If you do not start another Image Roulette operation for about one minute after the final image appears, the camera will automatically cancel Image Roulette and enter the normal PLAY mode.

Adding Audio to a Snapshot

The “after-recording” feature lets you add audio to snapshots after they are recorded. You can also re-record the audio of an audio snapshot (one with a  icon on it).

- **Audio Format:** WAVE/ADPCM recording format
This is the Windows standard format for audio recording. The file extension of a WAVE/ADPCM file is “.WAV”.
- **Recording Time:**
Up to about 30 seconds per image
- **Audio File Size:**
Approximately 120KB (30-second recording of approximately 4KB per second)

1. In the PLAY mode, use [◀] and [▶] to scroll through snapshots until the one to which you want to add audio is displayed.

2. Press [MENU].

3. Select the “PLAY” tab, select “Dubbing”, and then press [▶].



4. Press the shutter button to start audio recording.

5. Recording stops after about 30 seconds or when you press the shutter button.

To re-record audio

1. In the PLAY mode, use [◀] and [▶] to scroll through snapshots until the one whose audio you want to re-record is displayed.
2. Press [MENU].
3. Select the “PLAY” tab, select “Dubbing”, and then press [▶].
4. Use [▲] and [▼] to select “Delete”, and then press [SET].
 - If you merely want to delete the audio without re-recording, press [MENU] here to complete the procedure.
5. Press the shutter button to start audio recording.
6. Recording stops after about 30 seconds or when you press the shutter button.
 - This deletes the existing audio and replaces it with the new one.

▶▶ IMPORTANT! ◀◀

- Keep the microphone on the front of the camera pointed at the subject.
- Take care that you do not block the microphone with your fingers.
- Good recording results are not possible when the camera is too far from the subject.
- Operating camera buttons during recording can cause button noise to be included in the audio.
- The  (Audio) icon appears on the monitor screen after audio recording is complete.
- You will not be able to record audio when remaining memory capacity is low.
- The following types of audio recording are not supported.
 - Adding audio to a movie image
 - Adding audio to a protected snapshot (page 181)
- Audio that is re-recorded or deleted cannot be recovered. Make sure you no longer need audio before re-recording or deleting it.

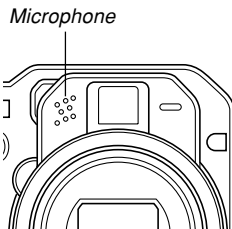

Playing Back a Voice Recording File

Perform the following steps to play back a voice recording file.

1. In the **PLAY** mode, use [**◀**] and [**▶**] to display the voice recording file (a file with  on it) you want to play.
2. Press [**SET**].

- This starts playback of the voice recording file through the camera's speaker.
- You can perform the following operations while audio is playing.



To do this:	Do this:
Fast forward or fast reverse the audio	Hold down [◀] or [▶].
Pause and unpause audio playback	Press [SET].
Adjust audio volume	Press [▲] or [▼].
Cancel playback	Press [MENU].

▶▶ IMPORTANT! ◀◀

- Audio volume can be adjusted only when playback is being performed or is paused.
- If your recording has index marks (page 129) inside it, you can jump to the index mark before or after the current playback location by pausing playback and then pressing [**◀**] or [**▶**]. Next, press [**SET**] to resume playback from the index mark position.

Displaying Camera Images on a TV Screen

You can display recorded images on a TV screen and even use a TV screen to compose images before you record them. To display camera images on a TV, you need a television equipped with a video input terminal, and the AV cable that comes with the camera.

1. Connect one end the AV cable that comes with the camera to the camera's [USB/AV] port, and the other end to the video input terminal of the TV.

- Connect the yellow plug of the AV cable to the video input (yellow) terminal of the TV, and the white plug to the TV's audio input (white) terminal.

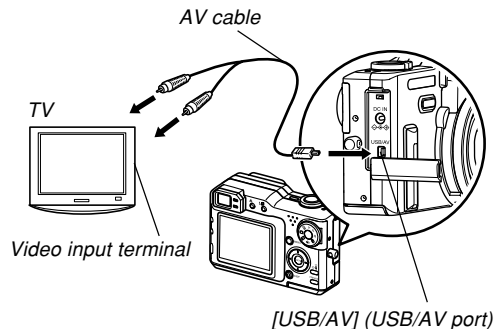

- 2. Turn on the TV and select its video input mode.**
- 3. Now when you perform normal image playback and recording operations on the camera, the applicable image appears on the TV screen.**

▶▶ IMPORTANT! ◀◀

- All icons and indicators that appear on the monitor screen also appear on the TV screen.
- Note that the audio output is monaural.
- The camera's monitor screen will go blank during video output.
- Depending on the size of the TV screen, recorded images and images during recording may not fill the entire screen.

Selecting the Video Input System

You can select either NTSC or PAL for the video output system to match the system of the TV you are using.

- 1. In a REC mode or the PLAY mode, press [MENU].**
- 2. Select the "Set Up" tab, select "Video Out", and then press [▶].**
- 3. Use [▲] and [▼] to select the setting you want, and then press [SET].**

If you are using a TV designed for use in this area:	Select this setting:
U.S., Japan, and other areas that use the NTSC system	NTSC
Europe and other areas that use the PAL system	PAL

DELETING FILES

You can delete a single file, or you can delete all files currently in memory.

»» IMPORTANT! ««

- Note that file deletion cannot be undone. Once you delete a file, it is gone. Make sure you really do not need a file anymore before you delete it. Especially when deleting all files, make sure you check all the files you have stored before proceeding.
- A protected file cannot be deleted. To delete a protected file, unprotect it first (page 181).
- Delete cannot be performed when all files in memory are protected (page 182).
- Deleting an audio snapshot deletes both its image file and the audio file attached to it.
- You cannot use the procedures in this section to delete images from the FAVORITE folder. See the procedures on page 185 for details about deleting FAVORITE folder contents.

Deleting a Single File

Perform the following steps when you want to delete a single file.

1. In the **PLAY** mode, press **[EX]** .

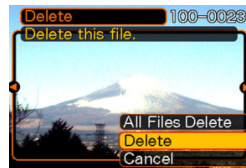

2. Use **[◀]** and **[▶]** to scroll through files and display the one you want to delete.
3. Use **[▲]** and **[▼]** to select “Delete”.
 - To exit the file delete operation without deleting anything, select “Cancel”.
4. Press **[SET]** to delete the file.
 - Repeat steps 2 through 4 to delete other files, if you want.
5. Press **[MENU]** to exit the menu screen.

►► IMPORTANT! ◀◀

- If a file cannot be deleted for some reason, the message “This function is not supported for this file.” appears when you try to delete it.

Deleting All Files

The following procedure deletes all unprotected files currently in memory.

- 1. In the PLAY mode, press [EX 

Download from Www.Somanuals.com All Manuals Search And Download.**

FILE MANAGEMENT

The file management capabilities of the camera make it easy to keep track of images. You can protect files against deletion and store the files you want in the camera's built-in memory.

Folders

Your camera automatically creates folders in its built-in flash memory or on the memory card.

Memory Folders and Files

An image you record is automatically stored in a folder, whose name is a serial number. You can have up to 900 folders in memory at the same time. Folder names are generated as shown below.

Example: Name of the 100th folder.

100CASIO

Serial number (3 digits)

Each folder can hold files numbered up to 9,999. Trying to store the 10,000th file in a folder causes the next serially numbered folder to be created. File names are generated as shown below.

Example: Name of the 26th file

CIMG0026.JPG

Extension

Serial number (4 digits)

- The folder and file names described here appear when you view folders and files on a computer. See page 33 for information about how the camera displays folder and file names.
- The actual number of files you will be able to store on a memory card depends on the image size and quality, card capacity, etc.
- For details about the folder structure, see "Memory Folder Structure" on page 228.

Protecting Files

Once you protect a file it cannot be deleted (page 178). You can protect files individually or you can protect all files in memory with a single operation.

To protect a single file

1. In the **PLAY** mode, press **[MENU]**.
2. Select the “**PLAY**” tab, select “**Protect**”, and then press **[▶]**.
 
3. Use **[◀]** and **[▶]** to scroll through files and display the one you want to protect.

4. Use **[▲]** and **[▼]** to select “**On**”, and then press **[SET]**.

- A file that is protected is indicated by the  mark.
- To unprotect a file, select “**Off**” in step 4, and then press **[SET]**.



5. Press **[MENU]** to exit the menu screen.

To protect all files in memory

1. In the **PLAY** mode, press **[MENU]**.
2. Select the **“PLAY”** tab, select **“Protect”**, and then press **[▶]**.
3. Use **[▲]** and **[▼]** to select **“All Files : On”**, and then press **[SET]**.
 - To unprotect all files, press **[SET]** in step 3 so the setting shows **“All Files : Off”**.
4. Press **[MENU]** to exit the menu screen.

Using the FAVORITE Folder

You can copy scenery shots, photos of your family, or other special images from a file storage folder (page 228) to the FAVORITE folder in built-in memory (page 228). Images in the FAVORITE folder are not displayed during normal playback, so it helps to keep your personal images private as you carry them around. FAVORITE folder images are not deleted when you change memory cards, so you can always keep them on hand.

To copy a file to the FAVORITE folder

1. In the **PLAY** mode, press **[MENU]**.
2. Select the **“PLAY”** tab, select **“Favorites”**, and then press **[▶]**.



FILE MANAGEMENT

3. Use [▲] and [▼] to select “Save”, and then press [SET].

- This displays the names of the files in built-in memory or on the loaded memory card.

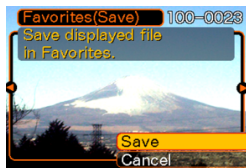

4. Use [◀] and [▶] to select the file you want to copy to the FAVORITE folder.

5. Use [▲] and [▼] to select “Save”, and then press [SET].

- This copies the displayed file to the FAVORITE folder.

6. After copying all of the files you want, use [▲] and [▼] to select “Cancel”, and then press [SET] to exit.

NOTE

- Copying an image file with the above procedure creates a 320 × 240-pixel QVGA-size image in the FAVORITE folder.
- A file copied into the FAVORITE folder is automatically assigned a file name that is a serial number. Though the serial number starts from 0001 and can go as high as 9999, the actual upper end of the range depends on built-in memory capacity. Remember that the maximum number of images that can be stored in built-in memory depends on the size of each image and other factors.

IMPORTANT!

- Note that an image that has been copied to the FAVORITE folder and then resized cannot be returned to its original size.
- Files in the FAVORITE folder cannot be copied to a memory card.

To display a file in the FAVORITE folder

1. In the PLAY mode, press [MENU].
2. Select the “PLAY” tab, select “Favorites”, and then press [▶].
3. Use [▲] and [▼] to select “Show”, and then press [SET].
 - If the FAVORITE folder is empty, the message “No Favorites file!” appears.
4. Use [▶] (forward) and [◀] (back) to scroll through the files in the FAVORITE folder.



5. After you are finished viewing files, press [MENU] twice to exit.

NOTE

- Holding down [◀] or [▶] scrolls images at high speed.

IMPORTANT!

- Note that a FAVORITE folder is created in the camera's built-in memory only. No FAVORITE folder is created on a memory card when you use one. If you want to view the contents of the FAVORITE folder on your computer screen, you need to remove the memory card from the camera (if you are using one) before connecting the USB cable and starting data communication (pages 216, 228).

To delete a file from the FAVORITE folder

1. In the PLAY mode, press [MENU].
2. Select the “PLAY” tab, select “Favorites”, and then press [▶].
3. Use [▲] and [▼] to select “Show”, and then press [SET].
4. Press [EX ].
5. Use [◀] and [▶] to select the file you want to delete from the FAVORITE folder.
6. Use [▲] and [▼] to select “Delete”, and then press [SET].
 - To exit the file delete operation without deleting anything, select “Cancel”.
7. After deleting all of the files you want, use [▲] and [▼] to select “Cancel”, and then press [SET] to exit.

To delete all files from the FAVORITE folder

1. In the PLAY mode, press [MENU].
2. Select the “PLAY” tab, select “Favorites”, and then press [▶].
3. Use [▲] and [▼] to select “Show”, and then press [SET].
4. Press [EX ].
5. Use [▲] and [▼] to select “All Files Delete”, and then press [SET].

▶▶ IMPORTANT! ◀◀

- You cannot use the standard delete operations on page 178 to delete images from the FAVORITE folder. Performing the memory format operation (page 198), however, does delete FAVORITE folder files.

OTHER SETTINGS

Configuring Sound Settings

You can configure different sounds to play whenever you turn on the camera, press the shutter button half-way or all the way, or perform a key operation.

To configure sound settings

1. In a REC mode or the PLAY mode, press [MENU].
2. Select the “Set Up” tab, select “Sounds”, and then press [▶].
3. Use [▲] and [▼] to select the sound whose setting you want to configure, and then press [▶].

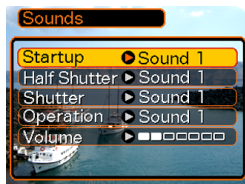

4. Use [▲] and [▼] to change the setting, and then press [SET].

To do this:	Select this setting:
Select a built-in sound	Sound 1 through Sound 5
Turn off the sound	Off

NOTE

- The default sound setting for all operations is “Sound 1”.

To set the volume level

1. In a REC mode or the PLAY mode, press [MENU].
2. Select the “Set Up” tab, select “Sounds”, and then press [▶].
3. Use [▲] and [▼] to select “Volume”.
4. Use [◀] and [▶] to specify the volume setting you want, and then press [SET].
 - You can set the volume in the range of 0 (no sound) to 7 (loudest).

NOTE

- The initial default volume setting is 3.

Specifying an Image for the Startup Screen

You can specify an image you recorded as the startup screen image, which causes it to appear on the monitor screen for about two seconds whenever you turn on the camera in a REC mode.

1. In a REC mode or the PLAY mode, press [MENU].
2. Select the “Set Up” tab, select “Startup”, and then press [▶].
3. Use [◀] and [▶] to display the image you want to use as the startup image.
4. Use [▲] and [▼] to change the setting, and then press [SET].

To do this:	Select this setting:
Use the currently displayed image as the startup screen image	On
Disable the startup screen	Off

»» IMPORTANT! ««

- You can select any one of the following types of image as the startup image.
 - The camera's built-in startup image
 - A snapshot you recorded with the camera
 - An audio snapshot you recorded with the camera (Audio not played back at startup.)
 - A movie whose file size is less than the amount of unused built-in memory still available
- The snapshot image or movie that you select as the startup image is stored in the camera's built-in memory. Only one image can be stored in startup image memory at one time. Selecting a new startup image overwrites anything that is already stored in startup image memory. Because of this, if you want to return to a previous startup image, you need to have a separate copy of that image in the camera's standard image memory.
- The startup image is deleted if you format built-in memory (page 198).
- If you store an audio snapshot to startup image memory, the image's audio is not played when the image is displayed at startup.

Configuring Power Down Image Settings

With the power down image feature, you can configure the camera so a specific image stored in camera image memory appears whenever you turn off power. You can specify a snapshot or a movie as the power down image.

■ To configure power down image settings

- 1. Use the USB cable to connect the camera to your computer (page 216).**
- 2. Move the image data that you want to use for the power down image to the top (root) folder of the camera's built-in Flash memory.**
 - The file name extension will not be displayed if your computer is configured to hide file name extensions. Example: CIMG0001
 - If there is a memory card loaded in the camera, be sure to copy the image to built-in memory before removing the memory card from the camera.

3. Change the name of the file to one of the following.

Snapshot Image: ENDING.JPG

Movie Image: ENDING.AVI

- You do not need to input the file name extension (JPG or AVI) if your computer is configured to hide file name extensions.
File Name: ENDING
- Your camera is now configured to display a power down image. The power down image will appear any time you press the power button to turn off the camera. The power down image appears regardless of whether or not your camera has a memory card loaded in it.

►► IMPORTANT! ◀◀

- Only a snapshot (JPEG) or movie (AVI) file can be used as the power down image.
- Note that the power down image feature works only with images recorded with this camera. The power down image feature may not operate properly when another type of image is specified as the power down image.
- Formatting the camera's flash memory deletes the power down image (page 198).
- When both a still image and a movie are present for the power down image, only the movie is used.
- Note that a power down image display operation cannot be interrupted once it starts. Because of this, you should select a relatively short movie when using a movie file as the power down image.

■ To cancel power down image settings

1. Use the USB cable to connect the camera to your computer (page 216).
2. Change the name of the current power down image from ENDING.JPG or ENDING.AVI to something else, or delete the current power down image from flash memory.

Specifying the File Name Serial Number Generation Method

Use the following procedure to specify the method for generating the serial number used for file names (page 180).

1. In a REC mode or the PLAY mode, press [MENU].
2. Select the “Set Up” tab, select “File No.,” and then press [▶].
3. Use [▲] and [▼] to change the setting, and then press [SET].

To do this for a newly saved file:	Select this setting:
Store the last file number used and increment it, regardless of whether files are deleted or whether the memory card is replaced with a new one	Continue
Find the highest file number in the current folder and increment it	Reset

Using the Alarm

You can configure up to three alarms that cause the camera to beep and display a specified image at the time you specify. Specifying a movie or an audio snapshot plays back the image and the audio at the assigned time.

Specifying a voice recording file plays the audio.

- You can configure up to three alarms, named “Alarm 1”, “Alarm 2”, and “Alarm 3”.

To set an alarm

1. In the **PLAY** mode, press **[MENU]**.
2. Select the “**PLAY**” tab, select “**Alarm**”, and then press **[▶]**.
3. Use **[▲]** and **[▼]** to select the alarm (1, 2, or 3) whose setting you want to configure, and then press **[▶]**.

4. Use **[◀]** and **[▶]** to select the setting you want to change, and then use **[▲]** and **[▼]** to change the selected setting.

- You can set an alarm time and configure the alarm to sound only once (Once) or at the same time everyday (Daily). You can also turn the alarm on or off.

5. Press **[DISP]**.

- You could press **[SET]** in place of **[DISP]** if you want to configure the alarm without an image.

6. Use **[◀]** and **[▶]** to select the scene you want to appear at the alarm time, and then press **[SET]**.

7. After all the settings are the way you want, press **[SET]**.

Stopping the Alarm

When an alarm time is reached while the camera is turned off, the alarm will sound for about one minute (or until you stop it), and then the camera will turn on. To stop the alarm after it starts to sound, press any button.

▶▶ IMPORTANT! ◀◀

- Note that the alarm does not sound if the alarm time is reached when any one of the following conditions exists.
 - While the camera is turned on
 - While a USB data communication operation is in progress

Setting the Clock

Use the procedures in this section to select a Home Time zone, and to change its date and time settings. If you want to change the time and date setting only without changing the Home Time Zone, perform the procedure under “To set the current time and date” (page 193) only.

▶▶ IMPORTANT! ◀◀

- Make sure you select your Home Time zone (the zone where you are currently located) before changing the time and date settings. Otherwise, the time and date setting will change automatically when you select another time zone.

To select your Home Time zone

1. In a REC mode or the PLAY mode, press [MENU].
2. Select the “Set Up” tab, select “World Time”, and then press [▶].
 - This displays the current World Time zone.
3. Use [▲] and [▼] to select “Home”, and then press [▶].

OTHER SETTINGS

4. Use [▲] and [▼] to select “City”, and then press [▶].
5. Use [▲], [▼], [◀], and [▶] to select the geographical area that contains location you want to select as your Home Time zone, and then press [SET].
6. Use [▲] and [▼] to select the city you want, and then press [SET].
7. After selecting the city you want, press [SET] to register its zone as your Home Time zone.

To set the current time and date

1. In a REC mode or the PLAY mode, press [MENU].
2. Select the “Set Up” tab, select “Adjust”, and then press [▶].
3. Set the current date and the time.

To do this:	Do this:
Change the setting at the current cursor location	Press [▲] or [▼].
Move the cursor between settings	Press [◀] or [▶].
Toggle between 12-hour and 24-hour timekeeping	Press [DISP].

4. When all the settings are the way you want, press [SET] to register them and exit the setting screen.

Changing the Date Format

You can select from among three different formats for display of the date.

1. In a REC mode or the PLAY mode, press [MENU].
2. Select the “Set Up” tab, select “Date Style”, and then press [▶].
3. Use [▲] and [▼] to change the setting, and then press [SET].

Example: December 24, 2004

To display the date like this:	Select this format:
04/12/24	YY/MM/DD
24/12/04	DD/MM/YY
12/24/04	MM/DD/YY

Using World Time

You can use the World Time screen to select time zone and instantly change the time setting of the camera's clock when you go on a trip, etc. World Time lets you select one of 162 cities in 32 time zones.

To display the World Time screen

1. In a REC mode or the PLAY mode, press [MENU].
2. Select the “Set Up” tab, select “World Time”, and then press [▶].
 - This displays the current World Time zone.
3. Use [▲] and [▼] to select “World”.

To do this:	Select this:
Display the time in your home time zone	Home
Display the time in the zone currently selected on the World Time screen	World

4. Press [SET] to exit the setting screen.

To configure World Time settings

1. In a REC mode or the PLAY mode, press [MENU].
2. Select the “Set Up” tab, select “World Time”, and then press [▶].
 - This displays the current World Time zone.
3. Use [▲] and [▼] to select “World”, and then press [▶].
4. Use [▲] and [▼] to select “City”, and then press [▶].
5. Use [▲], [▼], [◀], and [▶] to select the geographical area you want, and then press [SET].



6. Use [▲] and [▼] to select the city you want, and then press [SET].

- This displays the current time in the city you select.



7. When the setting is the way you want, press [SET] to apply it and exit the setting screen.

To configure summer time (DST) settings

Summer time is used in some geographical areas to advance the current time setting by one hour during the summer months.

- Use of summer time depends on the local customs and laws.

- 1. In a REC mode or the PLAY mode, press [MENU].**
- 2. Select the “Set Up” tab, select “World Time”, and then press [▶].**
 - This displays the current World Time Settings.
- 3. Use [▲] and [▼] to select “World”, and then press [▶].**
 - If you want to configure Home Time settings, select “Home” instead.

To do this:	Select this:
Advance the current time setting by one hour	On
Display the current time as-is	Off

- 4. Use [▲] and [▼] to select “DST”, and then press [▶].**
- 5. Use [▲] and [▼] to select the summer time (DST) setting you want.**
- 6. After the setting is the way you want, press [SET].**
 - This displays the current time in accordance with your setting.
- 7. Press [SET] again to exit the setting screen.**

Changing the Display Language

You can use the following procedure to select one of ten languages as the display language.

1. In a REC mode or the PLAY mode, press [MENU].
2. Select the “Set Up” tab, select “Language”, and then press [▶].
3. Use [▲], [▼], [◀], and [▶] to change the setting, and then press [SET].

日本語	: Japanese
English	: English
Français	: French
Deutsch	: German
Español	: Spanish
Italiano	: Italian
Português	: Portuguese
中國語	: Chinese (Complex)
中国語	: Chinese (Simplified)
한국어	: Korean

Changing the USB Port Protocol

You can use the procedure below to change the communication protocol of the camera's USB port when connecting to a computer, printer, or other external device. Select the protocol that suits the device to which you are connecting.

1. In a REC mode or the PLAY mode, press [MENU].
2. Select the “Set Up” tab, select “USB”, and then press [▶].
3. Use [▲] and [▼] to select the setting you want, and then press [SET].

When connecting to this type of device:	Select this setting:
Computer or USB DIRECT-PRINT-compatible printer (page 210)	Mass Storage (USB DIRECT-PRINT)
PictBridge-compatible printer (page 210)	PTP (PictBridge)*

* “PTP” stands for “Picture Transfer Protocol”.

OTHER SETTINGS

- Mass Storage (USB DIRECT-PRINT) causes the camera to see the computer as an external storage device. Use this setting for normal transfer of images from the camera to a computer (using the bundled Photo Loader application).
- PTP (PictBridge) simplifies the transfer of image data to the connected device.

Formatting Built-in Memory

Formatting built-in memory deletes any data stored in it.

►► IMPORTANT! ◀◀

- Note that data deleted by a format operation cannot be recovered. Check to make sure you do not need any of the data in memory before you format it.
- Formatting built-in memory deletes all files, including files in the FAVORITE folder (page 182), protected files (page 181), and BESTSHOT user setups (page 115).
- The startup screen image (page 187) and the power down image (page 188) are deleted by formatting memory.

1. Check to make sure there is no memory card loaded in the camera.

- If there is a memory card loaded in the camera, remove it (page 202).

2. In a REC mode or the PLAY mode, press [MENU].

3. Select the “Set Up” tab, select “Format”, and then press [▶].

4. Use [▲] and [▼] to select “Format”, and then press [SET].

- To exit the format operation without formatting, select “Cancel”.

USING A MEMORY CARD

You can expand the storage capabilities of your camera by using a commercially available memory card (SD memory card or MultiMediaCard). You can also copy files from built-in flash memory to a memory card and from a memory card to flash memory.



- Normally, files are stored in built-in flash memory. When you insert a memory card, however, the camera automatically stores files to the card.
- Note that you cannot save files to built-in memory while a memory card is installed in the camera.

» IMPORTANT! «

- Use only an SD memory card or a MultiMediaCard with this camera. Proper operation is not guaranteed when any other type of card is used.
- See the instructions that come with the memory card for information about how to use it.
- Certain types of cards can slow down processing speeds.
- SD memory cards have a write protect switch, which you can use to protect against accidental deletion of image data. Note, however, if you write protect an SD memory card, you must remove write protection whenever you want to record to it, format it, or delete any of its files.
- Electrostatic charge, digital noise, and other phenomena can cause data to become corrupted or even lost. Always maintain backup copies of important data on other media (CD-R, CD-RW, MO disc, computer hard disk, etc.)

USING A MEMORY CARD

Using a Memory Card

▶▶ IMPORTANT! ◀◀

- Make sure you turn off the camera before inserting or removing a memory card.
- Be sure to orient the card correctly when inserting it. Never try to force a memory card into the slot when you feel resistance.

To insert a memory card into the camera

1. Slide the battery cover in the direction indicated by the arrow, and then swing it open.

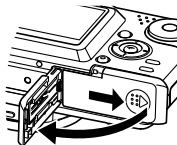

2. Positioning the memory card so its front is facing in the same direction as the camera's monitor screen, carefully slide it into the card slot. Slide the card all the way in until you hear it click securely into place.

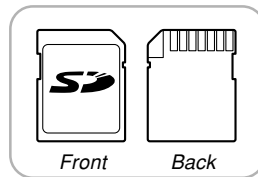
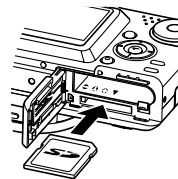

3. Swing the battery cover closed, and then slide it in the direction indicated by the arrow.

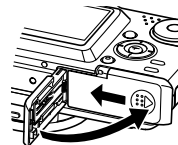

To remove a memory card from the camera

1. Press the memory card into the camera and then release it. This will cause the card to come part way out of the camera.

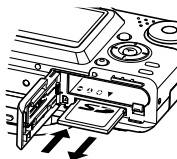

2. Pull the memory card out of the slot.

▶▶ IMPORTANT! ◀◀

- Never insert any other object besides a memory card into the camera's card slot. Doing so creates the risk of damage to the camera and card.
- Should water or any foreign object ever get into the card slot, immediately turn off the camera, remove the battery, and contact your dealer or nearest CASIO authorized service center.
- Never remove a card from the camera while the green operation lamp is flashing. Doing so can cause the file save operation to fail, and even damage the memory card.

To format a memory card

Formatting a memory card deletes any data already stored on it.

▶▶ IMPORTANT! ◀◀

- Be sure to use the camera to format a memory card. Formatting a memory card on a computer and then using it in the camera can slow down data processing by the camera. In the case of an SD card, formatting on a computer can result in non-conformity with the SD format, causing problems with compatibility, operation, etc.
- Note that data deleted by a memory card format operation cannot be recovered. Check to make sure you do not need any of the data on the memory card before you format it.
- Formatting a memory card that contains files deletes all the files, even those that are protected (page 181).

1. Load the memory card into the camera.
2. Turn on the camera. Next, enter the REC mode or PLAY mode and press [MENU].
3. Select the “Set Up” tab, select “Format”, and then press [▶].
4. Use [▲] and [▼] to select “Format”, and then press [SET].
 - To exit the format operation without formatting, select “Cancel”.

Memory Card Precautions

- If a memory card starts to behave abnormally, you can restore normal operation by reformatting it. However, we recommend that you always take along more than one memory card whenever using the camera far away from the home or office.
- We recommend that you format a memory card before using it for the first time after purchasing it, or whenever the card you are using seems to be the cause of abnormal images.
- As you record data to and delete data from an SD memory card a number of times, it loses its ability to retain data. Because of this, periodic re-formatting of an SD memory card is recommended.
- Before starting a format operation, check to make sure that the battery is fully charged. Power interruption during the format operation can result in improper formatting, and even damage the memory card and make it unusable.

Copying Files

Use the procedures below to copy files between built-in memory and a memory card.

▶▶ IMPORTANT! ◀◀

- Only snapshot, movie files, audio snapshot, and voice recording files recorded with this camera can be copied. Other files cannot be copied.
- Files in the FAVORITE folder cannot be copied.
- Copying an audio snapshot copies both its image file and the audio file.

To copy all the files in built-in memory to a memory card

1. Load the memory card into the camera.
2. Turn on the camera. Next, enter the PLAY mode and press [MENU].

3. Select the “PLAY” tab, select “Copy”, and then press [▶].



4. Use [▲] and [▼] to select “Built-in → Card”, and then press [SET].
 - This starts the copy operation and displays the message “Busy.... Please wait...”.
 - After the copy operation is complete, the monitor screen shows the last file in the folder.

To copy a specific file from a memory card to built-in memory

1. Perform steps 1 through 3 of the procedure under “To copy all the files in built-in memory to a memory card”.
2. Use [▲] and [▼] to select “Card → Built-in”, and then press [SET].
3. Use [◀] and [▶] to select the file you want to copy.
4. Use [▲] and [▼] to select “Copy”, and then press [SET].
 - This starts the copy operation and displays the message “Busy.... Please wait...”.
 - The file reappears on the monitor screen after the copy operation is complete.
 - Repeat steps 3 through 4 to copy other images, if you want.
5. Press [MENU] to exit the copy operation.

NOTE

- Files are copied to the folder in built-in memory whose name has the largest number.

PRINTING IMAGES

A digital camera provides you with a variety of different ways to print the images it records. The three main printing methods are described below. Use the method that best suits your needs.

■ Professional Print Service

The camera's DPOF feature lets you specify which images you want to print and how many copies of each you want. For more information, see "DPOF" (page 207).

■ Printing Directly on a Printer Equipped with a Card Slot, or a Printer that Supports USB DIRECT-PRINT or PictBridge

After using the camera's DPOF feature to specify the images you want to print and how many copies of each should be printed, you can plug the memory card into a printer equipped with a card slot, or connect the camera to a PictBridge or USB DIRECT-PRINT printer for printing. For more information, see "DPOF" (page 207) and "Using PictBridge or USB DIRECT-PRINT" (page 210).

■ Printing with a Computer

Windows Users

The camera comes bundled with Photo Loader and Photohands applications (page 241), which can be installed on a Windows computer for image transfer, management, and printing. For more information, see "Viewing Images on a Computer" (page 216) and "Installing the Software from the CD-ROM" (page 240).

►► IMPORTANT! ◀◀

- Refer to the pages referenced above for information about how to connect the camera to a computer. Image management procedures are provided in the following pages of this section.

PRINTING IMAGES

Macintosh Users

The camera comes bundled with Photo Loader for the Macintosh, which can be installed for image transfer and management, but not for printing. Use commercially available software for printing with a Macintosh. For more information, see “Viewing Images on a Computer” (page 216) and “Installing the Software from the CD-ROM” (page 240).

►► IMPORTANT! ◀◀

- Refer to the pages referenced above for information about how to connect the camera to your Macintosh. Image management procedures are provided in the following pages of this section.

DPOF

The letters “DPOF” stand for “Digital Print Order Format”, which is a format for recording on a memory card or other medium which digital camera images should be printed and how many copies of the image should be printed. Then you can print on a DPOF-compatible printer or at a professional print service in accordance with the file name and number of copies settings recorded on the card.



With this camera, you can select images by viewing them on the monitor screen without needing to remember the file names, their locations in memory, etc.

■ DPOF Settings

File Name,
number of copies,
date

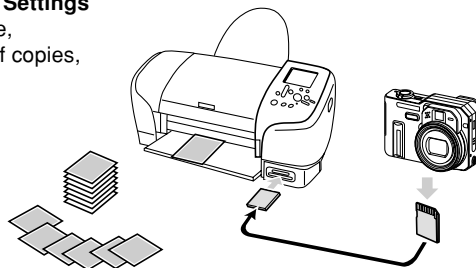

To configure print settings for a single image

1. In the PLAY mode, press [MENU].

2. Select the “PLAY” tab, select “DPOF”, and then press [▶].



3. Use [▲] and [▼] to select “Select images”, and then press [▶].



4. Use [◀] and [▶] to display the image you want.



5. Use [▲] and [▼] to specify the number of copies.

- You can specify up to 99 for the number of copies. Specify 00 if you do not want to have the image printed.

6. To turn on date stamping for the prints, press [DISP] so  is displayed.

-  indicates that date stamping is turned on.
- To turn off date stamping for the prints, press [DISP] so  is not displayed.
- Repeat steps 4 through 6 if you want to configure other images for printing.

7. After all the settings are the way you want, press [SET] to apply them.



To configure print settings for all images

1. In the **PLAY** mode, press **[MENU]**.
2. Select the **“PLAY”** tab, select **“DPOF”**, and then press **[▶]**.
3. Use **[▲]** and **[▼]** to select **“All images”**, and then press **[▶]**.
4. Use **[▲]** and **[▼]** to specify the number of copies.

- You can specify up to 99 for the number of copies. Specify 00 if you do not want to have the image printed.



5. To turn on date stamping for the prints, press **[DISP]** so  is displayed.

-  indicates that date stamping is turned on.
- To turn off date stamping for the prints, press **[DISP]** so  is not displayed.

6. After all the settings are the way you want, press **[SET]** to apply them.

» IMPORTANT! ««

- If you take a memory card to a professional print service, be sure to tell them that it includes DPOF settings for the images to be printed and the number of copies. If you don't, they may print all images on the card, including the ones you do not want printed.
- Note that some professional print services do not support DPOF printing. Check with your service before ordering prints.
- Some printers may have settings that disable date stamp and/or DPOF printing. See the user documentation that comes with your printer for details about how to enable these features.

Using PictBridge or USB DIRECT-PRINT

You can connect the camera directly to a printer that supports PictBridge or USB DIRECT-PRINT, and perform image selection and printing using the camera monitor screen and controls. DPOF support (page 207) also lets you specify which images you want to print and how many copies of each should be printed.

- PictBridge is a standard established by the Camera and Imaging Products Association (CIPA).
- USB DIRECT-PRINT is a standard proposed by Seiko Epson Corporation.

»» IMPORTANT! ««

- Use of the optional AC adaptor (AD-C40) is recommended when printing with PictBridge or USB DIRECT-PRINT.

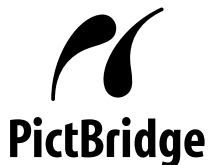

To print a single image

1. Press [MENU].
2. Select the "Set Up" tab, select "USB", and then press [▶].
3. Use [▲] and [▼] to select the setting you want, and then press [SET].

When connecting to this type of device:	Select this setting:
Computer or USB DIRECT-PRINT-compatible printer	Mass Storage (USB DIRECT-PRINT)
PictBridge-compatible printer	PTP (PictBridge)

- Mass Storage (USB DIRECT-PRINT) causes the camera to see the computer as an external storage device. Use this setting for normal transfer of images from the camera to a computer (using the bundled Photo Loader application).
- PTP (PictBridge) simplifies the transfer of image data to the connected device.

PRINTING IMAGES

4. Connect the optionally available AC adaptor to the camera.

- If you are using battery to power the camera, check to make sure that the battery is fully charged.
- Note that the camera does not draw any power over the USB cable.

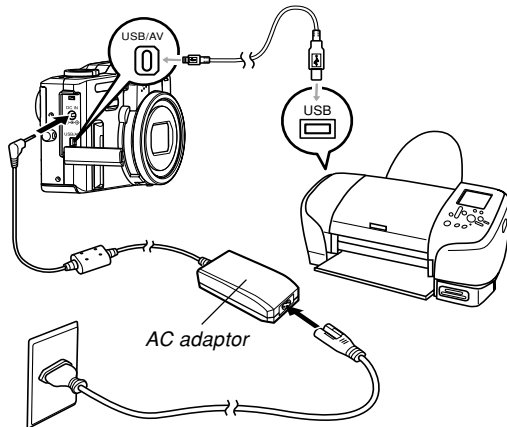

5. Use the USB cable that comes with the camera to connect the camera to a printer.

6. Turn on the printer.

7. Load paper for printing the images into the printer.

8. Press the camera's power button.

- This displays the print menu on the camera's monitor screen.

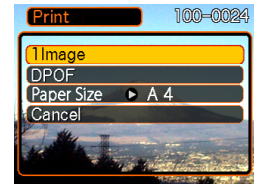

9. Use [▲] and [▼] to select "Paper Size", and then press [▶].

PRINTING IMAGES

10. Use [▲] and [▼] to select the paper size you want to use for printing, and then press [SET].

- The following are the print sizes that are available.
 - 3.5"× 5"
 - 5"× 7"
 - 4"× 6"
 - A4
 - 8.5"× 11"
- By Printer
- Selecting "By Printer" prints using the paper size selected on the printer.
- Available paper size settings depend on the connected printer. For full details, see the instructions that come with your printer.

11. On the print menu, use [▲] and [▼] to select "1 Image", and then press [SET].

- You can use [◀] and [▶] to select the image you want to print.
- You can toggle date stamping of the image on and off by pressing [DISP]. The  icon indicates that date stamping is turned on.



12. On the camera's monitor screen, use [▲] and [▼] to select "Print", and then press [SET].

- This starts printing and displays the message "Busy... Please wait..." on the monitor screen. The message will disappear after a short while, even though printing is still being performed. Pressing any of the camera's buttons while printing is in progress will cause the message to reappear.
- The print menu will appear when printing is complete.
- To print again, repeat this step.

- 13. The camera will turn off automatically when printing is complete. After this happens, disconnect the USB cable from the camera.**

To print a group of images

- 1. Use the DPOF procedure on page 207 to specify the images in file memory that you want to print.**
- 2. Perform steps 1 through 10 of the procedure under “To print a single image” on page 210.**
- 3. On the print menu, use [▲] and [▼] to select “DPOF”, and then press [SET].**
- 4. On the camera’s monitor screen, use [▲] and [▼] to select “Print”, and then press [SET].**
 - This starts printing and displays the message “Busy... Please wait...” on the monitor screen. The message will disappear after a short while, even though printing is still being performed. Pressing any of the camera’s buttons while printing is in progress will cause the message to reappear.
 - The print menu will appear when printing is complete.
 - This automatically starts printing of the images you specified with the DPOF procedure.

5. To print again, repeat the above from step 3.

- A message appears on the monitor screen, followed by the DPOF setting screen (page 208), if there are no DPOF settings currently configured on the camera to control the printing operation. If this happens, configure the required DPOF settings and then try printing again.

6. The camera will turn off automatically when printing is complete. After this happens, disconnect the USB cable from the camera.

Printing Precautions

- See the documentation that comes with your printer for information about print quality and paper settings.
- Contact your printer manufacturer for information about models that support PictBridge and USB DIRECT-PRINT, upgrades, etc.
- Never disconnect the USB cable, or perform any camera operation while printing is in progress. Doing so causes a printer error.

PRINT Image Matching III

Images include PRINT Image Matching III data (mode setting and other camera setup information). A printer that supports PRINT Image Matching III reads this data and adjusts the printed image accordingly, so your images come out just the way you intended when you recorded them.

- Seiko Epson Corporation holds the copyright for PRINT Image Matching and PRINT Image Matching III.



Exif Print

Exif Print is an internationally supported, open standard file format that makes it possible to capture and display vibrant digital images with accurate colors. With Exif 2.2, files include a wide range of shooting condition information that can be interpreted by an Exif Print printer to produce better-looking prints.



▶▶ IMPORTANT! ◀◀

- Information about the availability of Exif Print compatible printer models can be obtained from each printer manufacturer.

VIEWING IMAGES ON A COMPUTER

After using the USB cable to establish a USB connection between the camera and your computer, you can use your computer to view images in file memory and copy images to your computer's hard disk or other storage media. In order to do this, you first need to install the USB driver located on the CD-ROM that comes bundled with the camera onto your computer.

Note that the procedure you need to perform depends on whether you are using computer running under Windows (see below) or a Macintosh (see page 222).

Using the Camera with a Windows Computer

The following are the general steps for viewing and copying files from a computer running under Windows. You can find details about each operation in the procedures that follow below. Note that you should also refer to the documentation that comes with your computer for other information about USB connections, etc.

1. If you are running Windows 98, Me, or 2000, install the USB driver onto your computer.
 - You need to perform this step only once, the first time you connect to your computer.
 - If you are running Windows XP, you do not need to install the USB driver.



2. Use the USB cable to establish a connection between the camera and computer.



3. View and copy the images you want.

►► IMPORTANT! ◀◀

- Low battery power can cause the camera to power down suddenly during data communication. Use of the special AC adaptor is recommended to power the camera during data communication.
- If you want to transfer files from the camera's built-in memory to a computer, make sure there is no memory card loaded in the camera before you connect the USB cable.

Do not try to establish a connection between the camera and computer before installing the USB driver onto the computer. If you do, the computer will not be able to recognize the camera.

- USB driver installation is required in the case of Windows 98, Me, and 2000. Do not connect the camera to a computer running one of the above operating systems without installing the USB driver first.
- USB driver installation is not required in the case of Windows XP.

1. What you should do first depends on whether your computer is running under Windows 98, Me, 2000, or XP.

■ Windows 98/Me/2000 Users

- Start from step 2 to install the USB driver.
- Note that the example installation presented here uses Windows 98.

■ Windows XP Users

- Installation of the USB driver is not required, so jump directly to step 6.

2. Set the bundled CD-ROM (CASIO Digital Camera Software) into the CD-ROM drive of your computer.

3. On the menu screen that appears, click "English".

4. Click [USB driver] and then [Install].

- This starts installation.
- The following steps show installation under the English version of Windows.

- 5. On the screen that appears after installation is complete, select the “Yes, I want to restart my computer now.” check box and then click [Finish] to restart your computer.**
- Note that you should leave the bundled CD-ROM in your computer’s CD-ROM drive when you restart.

- 6. Connect the optional AC adaptor to the [DC IN] connector of the camera, and then plug it in to a household power outlet.**

- If you are using battery to power the camera, check to make sure that the battery is fully charged.

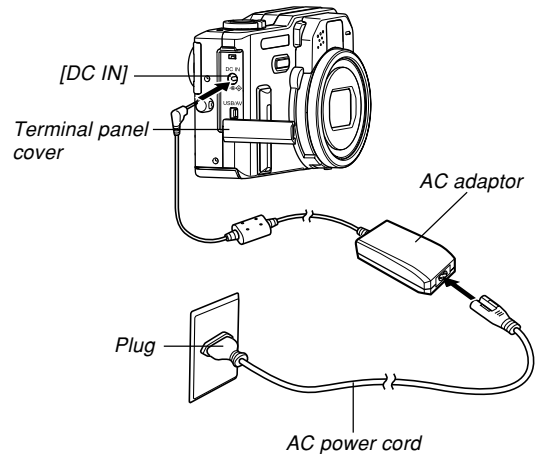

VIEWING IMAGES ON A COMPUTER

7. Turn on the camera, and then press [MENU].

- It makes no difference whether the camera is in a REC mode or the PLAY mode.

8. Select the “Set Up” tab, select “USB”, and then press [▶].

9. Use [▲] and [▼] to select “Mass Storage (USB DIRECT-PRINT)”, and then press [SET].

10. Turn off the camera, and connect the USB cable that comes bundled with the camera to the camera’s [USB/AV] port and your computer’s USB port.

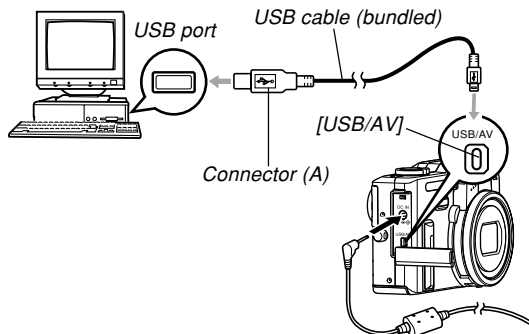

- Take care when connecting the USB cable to the camera or your computer. USB ports and cable plugs are shaped for proper positioning.
- Plug the USB cable plugs into the ports securely, as far as they will go. Proper operation is not possible if connections are not correct.

11. Turn on the camera.

- This will cause the “New Hardware...” dialog box to appear on the computer screen as the computer automatically detects the camera’s file memory. After you install the USB driver, “New Hardware...” dialog box will no longer appear when you perform the above steps to establish a USB connection.
- The camera’s green operation lamp lights (page 252).

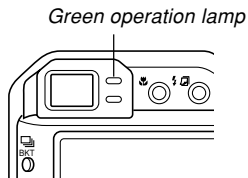

- At this point, some operating systems will display a “Removable Disk” dialog box. If your operating system does, close the dialog box.

12. On your computer, double-click “My Computer”.

- If you are running Windows XP, click [Start] and then [My Computer].

13. Double-click “Removable Disk”.

- Your computer sees the camera’s file memory as a removable disk.

14. Double-click the “Dcim” folder.

15. Double-click the folder that contains the image you want.

16. Double-click the file that contains the image you want to view.

- For information about file names, see “Memory Folder Structure” on page 228.

17. Depending on your operating system, perform one of the following procedures to save the files, if you want.

■ Windows 98, 2000, Me

1. In the camera's file memory (Removable Disk), right-click the "Dcim" folder.
 2. On the shortcut menu that appears, click [Copy].
 3. Double click [My Documents] to open it.
 4. On the My Documents [Edit] menu, click [Paste].
- This copies the "Dcim" folder (which contains the image files) to your "My Documents" folder.

■ Windows XP

1. In the camera's file memory (Removable Disk), right-click the "Dcim" folder.
 2. On the shortcut menu that appears, click [Copy].
 3. Click [Start] and then [My Documents].
 4. On the My Documents [Edit] menu, click [Paste].
- This copies the "Dcim" folder (which contains the image files) to your "My Documents" folder.

▶▶ IMPORTANT! ◀◀

- Never use your computer to edit, delete, move, or rename images stored in the camera's file memory. Doing so can cause problems with the image management data used by the camera, which may make it impossible to display images on the camera or it may cause large error in the number of images value displayed by the camera. Always copy images to your computer before performing any edit, delete, move, or rename operation.

18. Depending on the version of Windows you are running, use one of the following procedures to terminate the USB connection.

■ Windows Me/98/XP Users

- Press the camera's power button. After making sure that the camera's green operation lamp is not lit, disconnect the camera from the computer.

■ Windows 2000 Users

- Click card services in the task tray on your computer screen, and disable the drive number assigned to the camera. Next, disconnect the USB cable from the camera, and then turn off the camera.

USB Connection Precautions

- Do not leave the same image displayed on your computer screen for a long time. Doing so can cause the image to “burn in” on the screen.
- Never disconnect the USB cable, or perform any camera operation while data communication is in progress. Doing so can cause data to become corrupted.

Using the Camera with a Macintosh Computer

The following are the general steps for viewing and copying files from a Macintosh.

You can find details about each operation in the procedures that follow below. Note that you should also refer to the documentation that comes with your Macintosh for other information about USB connections, etc.

►► IMPORTANT! ◀◀

- This camera does not support operation on a computer running Mac OS 8.6 or lower, or Mac OS X 10.0. If you have a Macintosh running Mac OS 9 or OS X (10.1, 10.2, or 10.3), use the standard USB driver that comes with your OS.

1. Use the USB cable to establish a connection between the camera and your Macintosh.



2. View and copy the images you want.

VIEWING IMAGES ON A COMPUTER

►► IMPORTANT! ◀◀

- Low battery power can cause the camera to power down suddenly during data communication. Use the optional AC adaptor is recommended to power the camera during data communication with a computer.
- If you want to transfer files from the camera's built-in memory to a computer, make sure there is no memory card loaded in the camera before you connect the USB cable.

1. Connect the optional AC adaptor to the [DC IN] connector of the camera, and then plug it in to a household power outlet.

- If you are using battery to power the camera, check to make sure that the battery is fully charged.

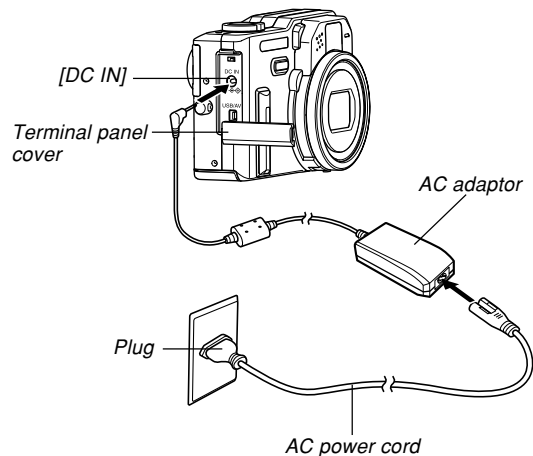

VIEWING IMAGES ON A COMPUTER

2. Turn on the camera, and then press [MENU].
 - It makes no difference whether the camera is in a REC mode or the PLAY mode.
3. Select the “Set Up” tab, select “USB”, and then press [▶].
4. Use [▲] and [▼] to select “Mass Storage (USB DIRECT-PRINT)”, and then press [SET].

5. Turn off the camera, and connect the USB cable that comes bundled with the camera to the camera’s [USB/AV] port and your computer’s USB port.

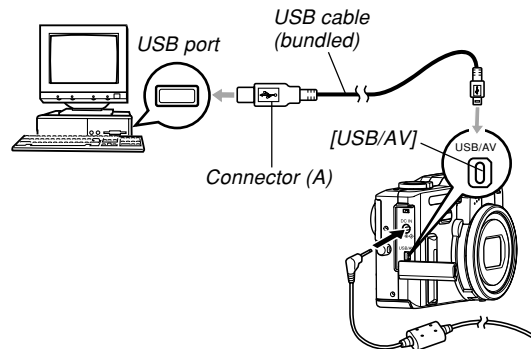

- Take care when connecting the USB cable to the camera or your computer. USB ports and cable plugs are shaped for proper positioning.
- Plug the USB cable plugs into the ports securely, as far as they will go. Proper operation is not possible if connections are not correct.

6. Turn on the camera.

- Your Macintosh will see the camera's file memory as a drive.
- The appearance of the drive icon depends on the Mac OS version you are using.
- After installing the USB driver, your Macintosh will see the camera's file memory as a drive whenever you establish a USB connection between them.

7. Double-click the drive icon for the camera's file memory, the "DCIM" folder, and then the folder that contains the image you want.

8. Double-click the file that contains the image you want to view.

- For information about file names, see "Memory Folder Structure" on page 228.

9. To copy all the files in file memory to your Macintosh hard disk, drag the "DCIM" folder to the folder to which you want to copy it.

▶▶ IMPORTANT! ◀◀

- Never use your computer to edit, delete, move, or rename images stored in the camera's file memory. Doing so can cause problems with the image management data used by the camera, which may make it impossible to display images on the camera or it may cause large error in the number of images value displayed by the camera. Always copy images to your computer before performing any edit, delete, move, or rename operation.

10. To terminate the USB connection, drag the drive icon that represents the camera to Trash. Next, disconnect the USB cable from the camera, and then turn off the camera.

USB Connection Precautions

- Do not leave the same image displayed on your computer screen for a long time. Doing so can cause the image to “burn in” on the screen.
- Never disconnect the USB cable, or perform any camera operation while data communication is in progress. Doing so can cause data to become corrupted.

Operations You Can Perform from Your Computer

The following are the operations you can perform while there is a USB connection between your camera and computer. See the referenced pages for more information about each operation.

- View images in album format
.... See “Using the Album Feature” on page 232.
- Print images in album format
.... See “Using the Album Feature” on page 232.
- Automatically transfer images to your computer and manage images
.... See “Installing the Software from the CD-ROM” on page 240 for information about installing Photo Loader.
- Retouch images
.... See “Installing the Software from the CD-ROM” on page 240 for information about installing Photohands.

Using a Memory Card to Transfer Images to a Computer

The procedures in this section describe how to transfer images from the camera to your computer using a memory card.

Using a Computer with a Built-in SD Memory Card Slot

Insert the SD memory card directly into the slot.

Using a Computer with a Built-in PC Card Slot

Use a commercially available PC card adaptor (for an SD memory card or MMC). For full details, see the user documentation that comes with the PC card adaptor and your computer.

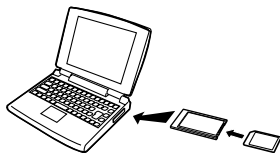

Using a Commercially Available SD Memory Card Reader/Writer

See the user documentation that comes with the SD memory card reader/writer for details about how to use it.

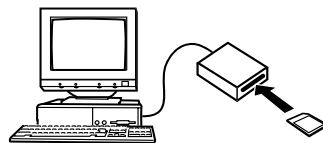

Using a Commercially Available PC Card Reader/Writer and PC Card Adaptor (for an SD memory card or MMC)

See the user documentation that comes with the PC card reader/writer and PC card adaptor (for an SD memory card or MMC) for details about how to use them.

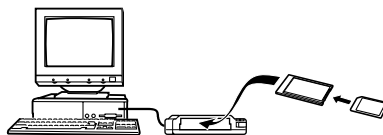

Memory Data

Images recorded with this camera and other data are stored in memory using DCF (Design rule for Camera File system) protocol. DCF protocol is designed to make it easier to exchange image and other data between digital cameras and other devices.

DCF Protocol

DCF devices (digital cameras, printers, etc.) can exchange images with each other. DCF protocol defines a format for image file data and the folder structure for file memory, so images can be viewed using another manufacturer's DCF camera or printed on a DCF printer.

Memory Folder Structure

Folder Structure

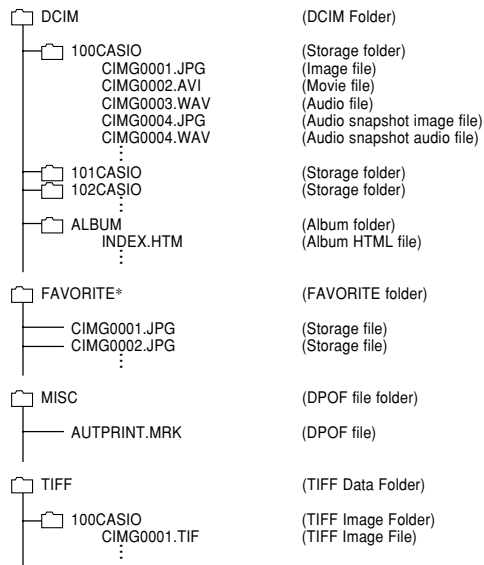

VIEWING IMAGES ON A COMPUTER



* These folders are created in built-in memory only.

■ Folder and File Contents

- DCIM folder
Folder that stores all of the digital camera files
- Storage folder
Folder for storing files created by the digital camera
- Image file
File that contains an image recorded with the digital camera (File Name Extension: JPG)
- Movie file
File that contains a movie recorded with the digital camera (File Name Extension: AVI)
- Audio file
File that contains an audio recording (File Name Extension: WAV)
- Audio snapshot image file
File that contains the image part of an audio snapshot (File Name Extension: JPG)
- Audio snapshot audio file
File that contains the audio part of an audio snapshot (File Name Extension: WAV)
- Album folder
Folder that contains files used by the album function
- Album HTML file
File used by the album function (File Name Extension: HTM)

VIEWING IMAGES ON A COMPUTER

- **FAVORITE folder**
Folder that contains Favorites image files
(Image Size: 320 × 240 pixels)
- **DPOF file folder**
Folder that contains DPOF files
- **TIFF Data Folder**
Folder that contains All TIFF format image related files
- **TIFF Image Folder**
Folder that contains TIFF format image files
- **TIFF Image File**
File that contains a TIFF format image (File Name
Extension: TIF)
- **BESTSHOT folder (Built-in memory only)**
Folder that contains BESTSHOT user setup files
- **User setup files (Built-in memory only)**
Files that contain BESTSHOT user setups

Image Files Supported by the Camera

- Image files recorded with this camera
- DCF protocol image files

Certain DCF functions may not be supported. When displaying an image recorded on another camera model, it may take a long time for the image to appear on the display.

Built-in Memory and Memory Card Precautions

- Note that the folder named “DCIM” is the parent (top) folder of all the files in memory. When transferring memory contents to a hard disk, CD-R, MO disk, or other external storage, treat all the contents inside a DCIM folder as a set and always keep them together. You can change the name of the DCIM folder on your computer. Changing the name to a date is a good way to keep track of multiple DCIM folders. However, if you even want to copy the folders back to the camera’s file memory, be sure you change the name of the DCIM folder back to “DCIM” first. The camera does not recognize any folder name other than DCIM.

USING THE CAMERA WITH A COMPUTER

The album feature of the camera creates files that make it possible for you to view images on your computer in a photo album layout. You can also use the applications contained on the CD-ROM that comes bundled with the camera to automate image transfer and to retouch images.

Using the Album Feature

The album feature creates an HTML photo album layout that displays your images. You can use the HTML layout to post your images on a Web page, or for printing the images.

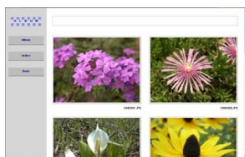

Album



Index



Info

- You can use the Web browser shown below to view or print the contents of an album. Note that to view a movie on a computer running Windows 2000 or 98, you need to install DirectX from the bundled CD-ROM.

Microsoft Internet Explorer Ver 5.5 or later

Creating an album

►► IMPORTANT! ◀◀

- Remember that creating an "ALBUM" folder (page 228) causes different size versions of each image to be created in memory. If there is an "ALBUM" folder in image memory when you specify printing of all images by a professional print service or on a printer, you may end up with unwanted multiple prints of the same image. To avoid this problem, use the procedure under "To delete an album" on page 240 to delete the ALBUM folder.

1. In the **PLAY** mode, press **[MENU]**.

2. Select the **“PLAY”** tab, select **“Create Album”**, and then press **[▶]**.

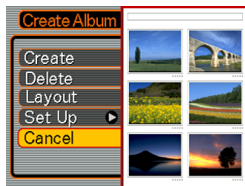

Sample layout

3. Use **[▲]** and **[▼]** to select **“Create”**, and then press **[SET]**.

- This starts creation of the album, and causes the message “Busy.... Please wait...”. to appear on the monitor screen.
- The **PLAY** mode screen reappears after creation of the album is complete.
- Creating an album causes a file folder named **“ALBUM”**, which contains a file named **“INDEX.HTM”** plus other files to be created in camera memory or on the memory card.

▶▶ IMPORTANT! ◀◀

- Never open the battery cover or remove the memory card from the camera while an album is being created. Doing so not only runs the risk of certain album files being skipped, it can also result in image data and other data in memory being corrupted.
- If memory becomes full while an album is being created, the message **“Memory Full”** appears on the monitor screen and album creation is terminated.
- Album creation will not be performed properly if the battery goes dead while album creation is in progress.
- Pressing **[SET]** in step 3 of the above procedure creates an album regardless of whether auto album creation is turned on or off (page 236).
- Images in the **“ALBUM”** folder (page 228) cannot be viewed on the camera’s monitor screen.

Selecting an Album Layout

You can select from among 10 different display layouts for an album.

1. In the **PLAY** mode, press [MENU].
2. Select the “**PLAY**” tab, select “**Create Album**”, and then press [▶].
3. Use [▲] and [▼] to select “**Layout**”.
4. Use [◀] and [▶] to select the layout you want.
 - When you select a layout, the corresponding layout sample appears on the right side of the screen.

▶▶ IMPORTANT! ◀◀

- The sample layout shows the arrangement of items and the background color only. It does not reflect any of the detailed album settings you configure in the following section.

Configuring Detailed Album Settings

1. In the **PLAY** mode, press [MENU].
2. Select the “**PLAY**” tab, select “**Create Album**”, and then press [▶].
3. Use [▲] and [▼] to select “**Set Up**”, and then press [▶].
4. Use [▲] and [▼] to select the item whose setting you want to change, and then press [▶].
 - Details about each of the settings are provided in the following sections.
5. Use [▲] and [▼] to change the setting, and then press [SET].



■ Background Color

You can specify white, black, or gray as the color of the album background using the procedure under “Configuring Detailed Album Settings”.

■ Album Type

There are two album types: “Normal” and “Index/Info”.

“Normal” Type : This type of album displays images in accordance with the currently selected layout.

“Index/Info” Type : In addition to the normal album screen, this type of album also includes thumbnails of images and detailed information about each image.

■ Image Use

This setting lets you select from among three different image uses, as described below. Select the image use that best suits the way you plan to use the image.

For this purpose:	Select this setting:
<p>Smaller images for album browsing, Website thumbnails, or archiving on a CD-R or other media, with the full-size image displayed when a thumbnail is clicked</p> <ul style="list-style-type: none"> This setting can be used for browsing with the thumbnails. Clicking a thumbnail displays a larger version for viewing or printing. 	View
<p>Small image files only for album browsing, or uploading to a Website, etc.</p> <ul style="list-style-type: none"> This option displays only the small-file images (located in the camera’s “ALBUM” folder). Smaller files upload to the Internet faster. You cannot enlarge images by clicking a thumbnail or play movies while this image is selected. 	WEB
<p>Printing (high resolution)</p> <ul style="list-style-type: none"> High-resolution images take longer to display on your computer screen. You cannot enlarge images by clicking a thumbnail or play movies while this image is selected. 	Print

■ Auto Album Creation On/Off

This setting controls whether an album is created automatically whenever you turn off the camera.

To do this:	Select this option:
Turn on auto album creation	On
Turn off auto album creation	Off

- When auto album creation is turned on, an album is created automatically in built-in memory or on the memory card whenever you turn off the camera.

»» IMPORTANT! ««

- When you turn off the camera while auto album creation is turned on, the monitor screen turns off, but the green operation lamp continues to flash for a few seconds to indicate that the album creation process is being performed. Never open the battery cover or remove the memory card while the green operation lamp is flashing.

»» NOTE ««

- Depending on the number of images in memory, it can take quite a bit of time to complete auto album creation when you turn off the camera. If you do not plan to use the album feature, we suggest that you keep auto album creation turned off, which shortens the amount of time the camera takes to power down completely.

Viewing Album Files

You can view and print album files using your computer's Web browser application.

1. Use your computer to access the data in built-in memory or on the memory card, or access a memory card with your computer (pages 216, 227).
2. Open the built-in memory "ALBUM" folder or the memory card "ALBUM" folder, which is located inside the folder named "DCIM".
3. Use your computer's Web browser to open the file named "INDEX.HTM".

- This displays a list of folders in built-in memory or on the memory card.

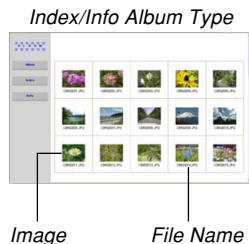

4. If you created the album after selecting "Index/Info" as the album type under "Configuring Detailed Album Settings" on page 234, you can click one of the following display options.

Album : Displays an album created by the camera.

Index : Displays a list of images stored in a folder.

Info : Displays information about each image.

- If "View" is selected for "Use" (page 235), you can double-click an image on your computer screen to display the full-size version.

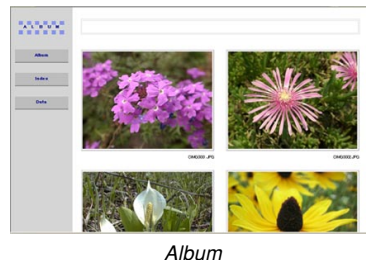

USING THE CAMERA WITH A COMPUTER



Index

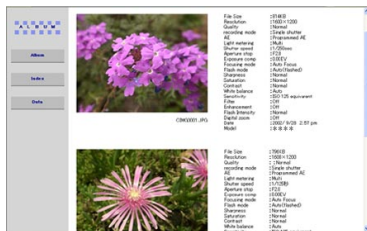

Info

- The following describes the information that appears on the Info Screen.

This Info Screen item:	Shows this:
File Size	Image file size
Resolution	Resolution
Quality	Quality
Recording mode	Recording mode
AE	Exposure mode
Drive mode	Drive mode
Light metering	Metering mode
Shutter speed	Shutter speed
Aperture stop	Aperture stop
Exposure comp	EV shift
Focusing mode	Focusing mode
AF Area	Auto Focus area
Flash mode	Flash mode
Sharpness	Sharpness
Saturation	Saturation
Contrast	Contrast
White balance	White balance
Sensitivity	Sensitivity
Filter	Filter setting
Enhancement	Enhancement setting
Flash intensity	Flash intensity

This Info Screen item:	Shows this:
Digital zoom	Digital zoom setting
World	Location
Date	Recording date and time
Model	Camera model name

NOTE

- When printing an album page, you should set up your Web browser as described below.
 - Select the browser frame where the images are located.
 - Set margins to the lowest possible values.
 - Set the background color to a printable color.
- See the user documentation that came with your Web browser application for details about printing and configuring settings for printing.
- Album contents (titles, comments, etc.) cannot be edited on the camera. Use a commercially available HTML file editor to edit album contents.

5. After you are finished viewing the album, exit your Web browser application.

Saving an Album

- To save an album, copy the “DCIM” folder from camera memory or the memory card to your computer’s hard disk, a CD-R, an MO disk, or some other storage medium. Note that copying only the “ALBUM” folder, does not copy image data and other necessary files.
- After copying the “DCIM” folder, do not change or delete any of the files inside of it. Adding new images or deleting existing images may lead to abnormal album display.
- If you plan to use a memory card again after saving its album, first delete all of its files or format it before loading it into the camera.
- When you have “WEB” selected for the “Use” setting, the album shows only the smaller image files stored in the “ALBUM” folder. Such images can be uploaded to the Internet more quickly.

To delete an album

1. In the **PLAY** mode, press **[MENU]**.
2. Select the **“PLAY”** tab, select **“Create Album”**, and then press **[▶]**.
3. Use **[▲]** and **[▼]** to select **“Delete”**, and then press **[SET]**.
 - This deletes the album and returns to the **PLAY** mode screen.

Installing the Software from the CD-ROM

Your digital camera comes bundled with useful applications for using it in combination with a computer. Install the applications you need on your computer.

About the bundled CD-ROM (CASIO Digital Camera Software)

The CD-ROM (CASIO Digital Camera Software) that comes bundled with the camera contains the applications described below. Installation of these applications is optional, and you should install only the ones you want to use.

USB Driver for Mass Storage (for Windows)

This is the software that makes it possible for the camera to “talk” to your personal computer over a USB connection. If you are using Windows XP, do not install the USB driver from the CD-ROM. With Windows XP, you will be able to perform USB communication simply by connecting the camera to your computer with the USB cable.

Photo Loader (for Windows/Macintosh)

This application automatically transfers image, audio snapshot, and voice recording WAV files from the camera to your computer. Photo Loader automatically stores transferred files in folders named using the current date (year, month, day) and generates HTML files that make it possible to view images using a web browser. Photo Loader (Windows version only) also includes a feature that simplifies the task of attaching images to e-mail.

- See the user documentation file (PDF) on the bundled “CASIO Digital Camera Software” CD-ROM for details about using Photo Loader.

Photohands (for Windows)

Photohands includes retouching tools for adjusting image color, contrast, and brightness, for resizing images, and for changing image orientation. You can also use Photohands for printing images and for adding a date stamp to printed images.

- See the user documentation file (PDF) on the bundled “CASIO Digital Camera Software” CD-ROM for details about using Photohands.

DirectX (for Windows)

This software provides an extended tool set including a codec that allows Windows 98 and 2000 to handle movie files recorded using a digital camera. You do not need to install DirectX if you are running Windows XP or Me.

Adobe Reader (for Windows)

This is an application that lets you read PDF files. Use it to read the user documentation for the camera, Photo Loader, and Photohands, all of which is included on the bundled CD-ROM.

- See the user documentation files (PDF) on the bundled CD-ROM for details about using Photo Loader and Photohands. See “Viewing User Documentation (PDF files)” on page 245 (Windows) and page 247 (Macintosh) of this manual for more information.

Computer System Requirements

Computer system requirements depend on each of the applications, as described below.

Windows

	USB Driver* ¹	Photo Loader	Photohands
OS	XP* ² /2000/Me/98	XP/2000/Me/98	XP/2000/Me/98
Memory	–	At least 16MB	At least 64MB
HD	–	At least 7MB	At least 10MB

*¹ In the case of Windows 2000, you need to install a data file that enables use of the operating system's standard USB driver. You do not need to install a special USB driver. Proper operation is not guaranteed on a computer that has been upgraded from Windows 95 or 3.1 to Windows Me or 98, or from Windows 95 or NT to Windows 2000.

*² With Windows XP, use the USB driver that comes with the operating system. You do not need to install the USB driver that comes with the camera.

Macintosh

	Photo Loader
OS	9
Memory	At least 32MB
HD	At least 3MB

- USB connection is supported on a Macintosh running OS 9, 10.1, 10.2, or 10.3. Operation is supported using the standard USB driver that comes with the operating system, so all you need to do is connect the camera to your Macintosh using the USB cable.

►► IMPORTANT! ◀◀

- For details about Windows minimum system requirements, see the “Readme” file on the CD-ROM (CASIO Digital Camera Software) that comes bundled with the camera.
- For details about Macintosh minimum system requirements, use a Web browser application to read the contents of the “readme” file on the CD-ROM (CASIO Digital Camera Software) that comes bundled with the camera.
- The software on the CD-ROM (CASIO Digital Camera Software) that comes bundled with the camera does not support operation under Mac OS X (10.0).

Installing Software from the CD-ROM in Windows

Use the procedures in this section to install the software from the bundled CD-ROM (CASIO Digital Camera Software) to your computer.

►► NOTE ◀◀

- If you already have one of the bundled applications installed on your computer, check its version. If the bundled version is newer than the one you have, uninstall the old version and then install the newer version.

The CD-ROM (CASIO Digital Camera Software) includes the software and user documentation for various languages. Check the CD-ROM menu screen to see if applications and user documentation are available for a particular language.

Getting Started

Start up your computer and insert the CD-ROM into its CD-ROM drive. This will automatically launch the menu application, which displays a menu screen on your computer.

- The menu application may not start up automatically on some computers. If this happens, navigate to the CD-ROM and double-click “menu.exe” to launch the menu application.

Selecting a Language

First select a language. Note that some software is not available in all languages.

- 1. On the menu screen, click the tab for the language you want.**

Viewing the Contents of the “Read me” File

You should always read the “Read me” file for any application before installing it. The “Read me” file contains information you need to know when installing the application.

- 1. Click the “Read me” button for the application you are going to install.**

►► IMPORTANT! ◀◀

- Before upgrading or reinstalling Photo Loader, or before installing it onto another computer, be sure to read the “Read me” file for information about retaining existing libraries.

Installing an Application

1. Click the “Install” button for the application you want to install.
2. Follow the instructions that appear on your computer screen.

»» IMPORTANT! ««

- Be sure to follow the instructions carefully and completely. If you make a mistake when installing Photo Loader, you may not be able to browse your existing library information and HTML files that are created automatically by Photo Loader. In some cases, image files may be lost.
- When using an operating system other than Windows XP, never connect the camera to your computer without installing the USB driver from the CD-ROM first.

Viewing User Documentation (PDF Files)

1. In the “Manual” area, click the name of the manual you want to read.

»» IMPORTANT! ««

- You need to have Adobe Reader installed on your computer to read user documentation files. If you do not already have Adobe Reader installed, you can install it from the bundled CD-ROM.

User Registration

You can perform user registration over the Internet. To do so, of course, you need to be able to connect to the Internet with your computer.

1. Click the “Register” button.

- This starts up your Web browser and accesses the user registration website. Follow the instructions that appear on your computer screen to register.

Exiting the Menu Application

1. On the menu screen, click “Exit” to exit the menu.

Installing Software from the CD-ROM on a Macintosh

Use the procedures in this section to install the software from the bundled CD-ROM (CASIO Digital Camera Software) to your computer.

Installing Software

Use the following procedures to install the software.

■ To install Photo Loader

1. Open the folder named “Photo Loader”.
2. Open the folder named “English”, and then open the file named “Important”.
3. Open the folder named “Installer”, and then open the file named “readme”.
4. Follow the instructions in the “readme” file to install Photo Loader.

▶▶ IMPORTANT! ◀◀

- If you are upgrading to the new version of Photo Loader from a previous version and you want to use library management data and HTML files created using the old version of Photo Loader, be sure to read the “Important” file in the “Photo Loader” folder. Follow the instructions in the file to use your existing library management files. Failure to follow this procedure correctly can result in loss or corruption of your existing files.

Viewing User Documentation (PDF Files)

To perform the following procedures, you must have Adobe Reader installed on your Macintosh. You can download the latest version of Adobe Reader by visiting the Adobe Systems website.

■ To view the camera user’s guide

1. On the CD-ROM, open the “Manual” folder.
2. Open the “Digital Camera” folder, and then open the folder for the language whose user’s guide you want to view.
3. Open the file named “camera_xx.pdf”.
 - “xx” is the language code (Example: camera_e.pdf is for English, camera_g.pdf is for German, etc.).

■ To view the Photo Loader user's guide

1. On the CD-ROM, open the "Manual" folder.
2. Open the "Photo Loader" folder and then open the "English" folder.
3. Open "PhotoLoader_english".

■ To register as a camera user

Internet registration only is supported. Visit the following CASIO website to register:

<http://world.casio.com/qv/register/>

APPENDIX







Menu Reference

The following shows lists of menus that appear in REC modes and the PLAY mode, and their settings.

- The settings that are underlined in the following table are initial defaults.

■ REC modes

● REC tab menu

Size	<u>3072</u> × <u>2304</u> / 3072 × 2048 (3:2) / 2304 × 1728 / 1600 × 1200 / 1280 × 960 / 640 × 480
Quality	Fine / <u>Normal</u> / Economy / TIFF
EV Shift	-2.0 / -1.7 / -1.3 / -1.0 / -0.7 / -0.3 / <u>0.0</u> / +0.3 / +0.7 / +1.0 / +1.3 / +1.7 / +2.0
White Balance	<u>Auto</u> /  (Daylight) /  (Cloudy) /  (Shade) /  (Fluorescent 1) /  (Fluorescent 2) /  (Tungsten) /  (Flash) / Manual
ISO	<u>Auto</u> / ISO 80 / ISO 160 / ISO 320 / ISO 640
AF Mode	<u>Hybrid</u> / Continuous / Contrast
AF Area	<u>Spot</u> / Multi / Free
Metering	<u>Multi</u> / Center weighted / Spot
Audio Snap	On / <u>Off</u>

Filter	<u>Off</u> / B/W / Sepia / Red / Green / Blue / Yellow / Pink / Purple
Sharpness	+2 / +1 / <u>0</u> / -1 / -2
Saturation	+2 / +1 / <u>0</u> / -1 / -2
Contrast	+2 / +1 / <u>0</u> / -1 / -2
Flash Intensity	+2 / +1 / <u>0</u> / -1 / -2
Flash Assist	Auto / <u>Off</u>
External flash	On / <u>Off</u>
Grid	On / <u>Off</u>
Digital Zoom	<u>On</u> / Off
Review	<u>On</u> / Off
Icon Help	<u>On</u> / Off
L/R Key	<u>EV shift</u> / White Balance / ISO / Metering / AF Area / Off

APPENDIX

● Memory tab menu

Flash	<u>On</u> / Off
Focus	On / <u>Off</u>
White Balance	On / <u>Off</u>
ISO	On / <u>Off</u>
AF Area	<u>On</u> / Off
Metering	On / <u>Off</u>
Self-timer	On / <u>Off</u>
Cont. / BKT	On / <u>Off</u>
Flash Intensity	On / <u>Off</u>
Digital Zoom	<u>On</u> / Off
MF Position	On / <u>Off</u>
Zoom Position	On / <u>Off</u>

● Set Up tab menu

Sounds	<u>Startup</u> / Half Shutter / Shutter / Operation / Volume
Startup	On (Selectable image) / <u>Off</u>
File No.	<u>Continue</u> / Reset
World Time	<u>Home</u> / World Home Time setup (city, DST, etc.) World Time setup (city, DST, etc.)
Date Style	YY/MM/DD / DD/MM/YY / MM/DD/YY
Adjust	Time setting
Language	日本語 / English / Français / Deutsch / Español / Italiano / Português / 中國語 / 中国語 / 한국어
Sleep	30 sec / <u>1 min</u> / 2 min / Off
Auto Power Off	<u>2 min</u> / 5 min
USB	<u>Mass Storage (USB DIRECT- PRINT)</u> / PTP (PictBridge)
Video Out	<u>NTSC</u> / PAL
Format	Format / <u>Cancel</u>
Reset	Reset / <u>Cancel</u>

■ PLAY mode

● PLAY tab menu

Slideshow	<u>Start</u> / Images / Time / Interval / Cancel
Calendar	–
Favorites	<u>Show</u> / Save / Cancel
DPOF	<u>Select images</u> / All images / Cancel
Protect	<u>On</u> / All Files : On / Cancel
Rotation	<u>Rotate</u> / Cancel
Resize	<u>1600 × 1200</u> / 1280 × 960 / 640 × 480 / Cancel
Trimming	–
Create Album	Create / Delete / Layout / Set Up / <u>Cancel</u>
Dubbing	–
Alarm	Alarm setups
Copy	<u>Built-in</u> → Card / Card → Built-in / Cancel

● Set Up tab menu

Sounds	<u>Startup</u> / Half Shutter / Shutter / Operation / Volume
Startup	On (Selectable image) / <u>Off</u>
File No.	<u>Continue</u> / Reset
World Time	<u>Home</u> / World Home Time setup (city, DST, etc.) World Time setup (city, DST, etc.)
Date Style	YY/MM/DD / DD/MM/YY / MM/DD/YY
Adjust	Time setting
Language	日本語 / English / Français / Deutsch / Español / Italiano / Português / 中國語 / 中国語 / 한국어
Sleep	30 sec / <u>1 min</u> / 2 min / Off
Auto Power Off	<u>2 min</u> / 5 min
USB	<u>Mass Storage (USB DIRECT- PRINT)</u> / PTP (PictBridge)
Video Out	<u>NTSC</u> / PAL
Format	Format / <u>Cancel</u>
Reset	Reset / <u>Cancel</u>

Indicator Lamp Reference

The camera has three indicator lamps: a green operation lamp, a red operation lamp, and a self-timer lamp. These lamps light and flash to indicate the current operational status of the camera.

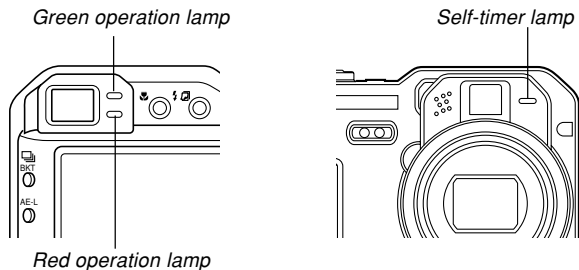

* There are three lamp flash patterns. Pattern 1 flashes once per second, Pattern 2 flashes twice per second, and Pattern 3 flashes four times per second. The table below explains what each flash pattern indicates.

REC modes

Operation Lamp		Self-timer Lamp	Meaning
Green	Red	Red	
Lit			Operational (Power on, recording enabled)
	Pattern 3		Flash is charging.
	Lit		Flash charging is complete.
Lit			Auto Focus operation was successful.
Pattern 3			Cannot Auto Focus.
Lit			Monitor screen is off.
Pattern 2			Storing image
Pattern 1			Storing movie data / processing image data
		Pattern 1	Self-timer countdown (10 to 3 seconds)
		Pattern 2	Self-timer countdown (3 to 0 seconds)
	Pattern 1		Cannot charge flash.
	Pattern 2		Memory card problem / Memory card is unformatted. / BESTSHOT setup cannot be registered.
	Lit		Memory card is locked. / Cannot create folder. / Memory is full. / Write error

APPENDIX

Operation Lamp		Self-timer Lamp	Meaning
Green	Red	Red	
	Pattern 3		Low battery alert
Pattern 3			Formatting card
Pattern 3			Powering down

▶▶ IMPORTANT! ◀◀

- When you are using a memory card, never remove the card from the camera while the green operation lamp is flashing. Doing so will cause recorded images to be lost.

PLAY mode

Operation Lamp		Self-timer Lamp	Meaning
Green	Red	Red	
Lit			Operational (Power on, recording enabled)
Pattern 3			One of the following operations is being performed: delete, DPOF, image protect, copy, album creation, format, power down
	Pattern 2		Memory card problem / Memory card is unformatted.
	Lit		Memory card is locked. / Cannot create folder. / Memory is full.
	Pattern 3		Low battery alert

Rapid Charger

The rapid charger has a [CHARGE] lamp that lights or flashes in accordance with the rapid charger operation that is being performed.

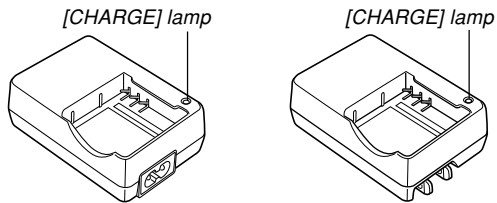



[CHARGE] Lamp		Meaning
Color	Status	
Red	Lit	Charging
Green	Lit	Charging complete
Red	Flashing	Rapid charger or battery abnormality
Amber	Lit	Charge standby state (Ambient temperature is too high or too low.)





Troubleshooting Guide

	Symptom	Possible Cause	Action
Power Supply	Power does not turn on.	<ol style="list-style-type: none"> 1) The battery is not oriented correctly. 2) The battery is dead. 	<ol style="list-style-type: none"> 1) Orient the battery correctly (page 41). 2) Charge the battery (page 37). If the battery goes dead soon after being charged, it means the battery has reached the end of its life and needs to be replaced. Purchase a separately available NP-40 rechargeable lithium ion battery.
	Camera suddenly powers down.	<ol style="list-style-type: none"> 1) Auto Power Off activated (page 51). 2) The battery is dead. 	<ol style="list-style-type: none"> 1) Turn power back on. 2) Charge the battery (page 37).
Image Recording	Image is not recorded when the shutter button is pressed.	<ol style="list-style-type: none"> 1) The camera is in the PLAY mode. 2) Flash unit is being charged. 3) Memory is full. 	<ol style="list-style-type: none"> 1) Use the mode dial to select the currently selected recording mode (page 58). 2) Wait until the flash unit finishes charging. 3) Transfer files you want to keep to your computer and then delete files from image memory, or use a different memory card.

APPENDIX

	Symptom	Possible Cause	Action
Image Recording	Auto Focus does not focus properly	<ol style="list-style-type: none"> 1) The lens is dirty. 2) The phase differential sensor is dirty. 3) You are blocking the phase differential sensor with your finger. 4) The subject is not located in the center of the focus frame when you compose the image. 5) The subject you are shooting is a type that is not compatible with Auto Focus operation (page 63). 6) You are moving the camera. 7) An Auto Focus mode other than "Contrast" is selected while a conversion lens is installed on the camera (page 134). 	<ol style="list-style-type: none"> 1) Clean the lens. 2) Clean the phase differential sensor. 3) Move your finger so it does not block the phase differential sensor. 4) Make sure the subject is centered in the focus frame when composing the image. 5) Use manual focus (page 85). 6) Mount the camera on a tripod. 7) Change the Auto Focus mode setting to "Contrast" (page 134).
	The subject is out of focus in the recorded image.	The image is not focused properly.	When composing the image, make sure the subject on which you want to focus is located inside the focus frame.
	The flash does not fire.	<ol style="list-style-type: none"> 1)  (flash off) is selected as the flash mode. 2) The battery is dead. 3) The camera is in the Movie mode. 4) A scene that selects  (flash off) as the flash mode is selected in the BESTSHOT mode. 	<ol style="list-style-type: none"> 1) Select a different flash mode (page 71). 2) Charge the battery (page 37). 3) Select a different REC mode. 4) Select a different flash mode (page 71) or BESTSHOT scene (page 113).

APPENDIX

	Symptom	Possible Cause	Action
Image Recording	Camera powers down during self-timer countdown.	The battery is dead.	Charge the battery (page 37).
	Monitor screen image is out of focus.	<ol style="list-style-type: none"> 1) You are using the Manual Focus mode and have not focused the image. 2) You are trying to use the Macro mode () when shooting a scenery or portrait shot. 3) You are trying to use Auto Focus or the Infinity mode () when shooting a close-up shot. 	<ol style="list-style-type: none"> 1) Focus the image (page 85). 2) Use Auto Focus for scenery and portrait shots. 3) Use the Macro mode () for close-ups.
	Recorded images are not saved in memory.	<ol style="list-style-type: none"> 1) Camera powers down before the save operation is complete. 2) Removing the memory card before the save operation is complete. 	<ol style="list-style-type: none"> 1) When the battery indicator shows , charge the battery as soon as possible (page 37). 2) Do not remove the memory card before the save operation is complete.
	The images produced by an auto bracketing operation look the same.	<ol style="list-style-type: none"> 1) The subject you are recording is a type for which the different settings do not produce much of a difference in appearance. 2) The image is drastically under-exposed or over-exposed. 	<ol style="list-style-type: none"> 1) Shoot a different subject. 2) Adjust the exposure.

APPENDIX

	Symptom	Possible Cause	Action
Playback	Color of the playback image is different from the image on the monitor screen during recording.	Sunlight or light from another source is shining directly into the lens during recording.	Position the camera so sunlight does not shine directly into the lens.
	Images are not displayed.	A memory card with non-DCF images recorded with another camera is loaded in the camera.	Use a different card. This camera cannot display non-DCF images recorded onto a memory card using another digital camera.
Other	All buttons and switches are disabled.	Circuit problem caused by electrostatic charge, impact, etc. while the camera was connected to another device.	Remove the battery from the camera, reinsert it, and then try again.
	Monitor screen is off.	<ol style="list-style-type: none"> 1) USB communication is in progress. 2) The monitor screen is turned off (in a REC mode). 3) The camera is connected to a TV for image output. 	<ol style="list-style-type: none"> 1) After confirming that the computer is not accessing camera memory, disconnect the USB cable. 2) Press [DISP] to turn on the monitor screen. 3) Unplug the AV cable.
	Cannot transfer files over a USB connection.	<ol style="list-style-type: none"> 1) USB cable is not connected securely. 2) USB driver is not installed. 3) Camera is turned off. 	<ol style="list-style-type: none"> 1) Check all connections. 2) Install the USB driver on your computer (page 216). 3) Turn on the camera.

If you have problems installing the USB driver...

You may not be able to install the USB driver properly if you use the USB cable to connect the camera to a computer running Windows 98 before installing the USB driver from the bundled CD-ROM (CASIO Digital Camera Software), or if you have another type of driver installed. This will make it impossible for the computer to recognize the digital camera when it is connected. If this happens, you will need to re-install the camera's USB driver. For information about how to re-install the USB driver, see the USB driver's "Read me" file on "CASIO Digital Camera Software" CD-ROM that comes bundled with the camera.

Display Messages

Alarm setting complete. This message appears after you change the alarm setting.

Battery is low. The battery is dead.

Cannot correct image! Keystone correction cannot be performed for some reason. The image will be stored as-is, without correction (page 121).

Can not find the file. The camera cannot find an image specified by the slideshow "Images" setting. Specify another image (page 169).

Cannot register any more files.

- You are attempting to save a BESTSHOT user setup when the "SCENE" folder already contains 999 setups (page 116).
- You are attempting to copy a FAVORITE file when the "FAVORITE" folder already contains 9999 files (page 182).

Card ERROR Some problem occurred with the memory card. Turn off the camera, and remove and then reinsert the memory card. If the same message appears, format the memory card (page 202).

»» IMPORTANT! ««

Formatting the memory card deletes all files on the memory card. Before formatting, try transferring recoverable files to a computer or some other storage device.

Check connections! You are trying to print on the printer over an incompatible USB connection.

File could not be saved because battery is low. The battery is dead, so the recorded image could not be saved.

Folder cannot be created. This message appears when you try to record an image while there are 9,999 files stored in the 999th folder. If you want to record more files, delete files you no longer need (page 178).

LENS ERROR If the lens comes into contact with some obstacle while it is extending, this message appears, the lens retracts, and the camera turns off. Take action to remove the obstacle, and try turning on power again.

Load paper! The camera is in the Printer mode, and the printer is out of paper.

Memory Full Memory is full. If you want to record more files, delete files you no longer need (page 178).

No Favorites file! There is no FAVORITE file.

Printing Error One of the following problems occurred during printing.

- Printer power off
- Printer internal error

APPENDIX

Record Error Image compression could not be performed during image data storage for some reason. Record the image again.

Replenish ink! The camera is in the Printer mode, and the printer is running low on ink or is out of ink.

SYSTEM ERROR Your camera system is corrupted. Contact your retailer or a CASIO service center.

The card is locked. The LOCK switch of the SD memory card is locked. You cannot store images to or delete images from a memory card that is locked.

There are no files. There are no files in built-in memory or on the memory card.

There are no printing images. There are no DPOF settings specifying images and the number of copies of each for printing.
Set up DPOF. Configure the required DPOF settings (page 207).

There is no image to register. You are trying to save an invalid image as a BESTSHOT user setup, or as an original startup image.

This card is not formatted. The memory card loaded in the camera is not formatted. Format the memory card (page 202).

This file cannot be played. The image file or audio file is corrupted, or is a type that cannot be displayed by this camera.

This function cannot be used. You attempted to copy files from built-in memory to a memory card loaded in the camera while there is no memory card in the camera (page 204).

This function is not supported for this file. The function you are trying to perform is not supported for the file on which you are trying to perform it.

Specifications

Product Digital Camera

Model EX-P700

■ Camera Functions

Image Files Format

Snapshots JPEG (Exif Ver.2.2); TIFF; DCF
(Design rule for Camera File system)
1.0 standard; DPOF compliant

Movies AVI (Motion JPEG)

Audio WAV

Recording Media 8.9MB built-in flash memory
SD Memory Card
MultimediaCard

Image Size

Snapshots 3072 × 2304 pixels
3072 × 2048 (3:2) pixels
2304 × 1728 pixels
1600 × 1200 pixels
1280 × 960 pixels
640 × 480 pixels

Movies 320 × 240 pixels

Approximate Memory Capacity and File sizes:

• Snapshots

File Size (pixels)	Quality	Approximate Image File Size	Built-in flash memory 8.9MB	SD Memory Card* 64MB
3072 × 2304	Fine	4.4MB	2 shots	13 shots
	Normal	2.2MB	3 shots	26 shots
	Economy	1.1MB	7 shots	51 shots
	TIFF	20.3MB	0 shot	2 shots
3072 × 2048 (3:2)	Fine	3.9MB	2 shots	15 shots
	Normal	2.0MB	4 shots	29 shots
	Economy	1.0MB	8 shots	56 shots
	TIFF	18.0MB	0 shot	2 shots
2304 × 1728	Fine	1.95MB	4 shots	30 shots
	Normal	1.53MB	5 shots	37 shots
	Economy	800KB	10 shots	68 shots
	TIFF	11.4MB	0 shot	4 shots
1600 × 1200 (UXGA)	Fine	1.05MB	7 shots	53 shots
	Normal	710KB	11 shots	79 shots
	Economy	370KB	22 shots	154 shots
	TIFF	5.5MB	1 shot	9 shots
1280 × 960 (SXGA)	Fine	680KB	12 shots	82 shots
	Normal	460KB	18 shots	126 shots
	Economy	250KB	32 shots	221 shots
	TIFF	3.5MB	2 shots	14 shots
640 × 480 (VGA)	Fine	190KB	42 shots	294 shots
	Normal	140KB	56 shots	386 shots
	Economy	90KB	90 shots	618 shots
	TIFF	900KB	8 shots	55 shots

APPENDIX

- Movies (320 × 240 pixels)

Data Size	300KB/second max.
-----------	-------------------

- * Based on Matsushita Electric Industrial Co., Ltd. products. Capacity depends on card manufacturer.
- * To determine the number of images that can be stored on a memory card of a different capacity, multiply the capacities in the table by the appropriate value.

Delete Single-file, all files (with protection)

Effective Pixels 7.2 million

Imaging Element 1/1.8-inch square pixel color CCD
(Total pixels: 7.41 million)

Lens/Focal Distance Eight lenses in seven groups, including an aspherical lens
F2.8 (W) to 4 (T); $f=7.1$ (W) to 28.4mm (T) (equivalent to approximately 33 (W) to 132 (T) for 35mm film)

Zoom 4X optical zoom; 4X digital zoom
(16X in combination with optical zoom)

Focusing Combination phase differential sensor and contrast Auto Focus (AF) mode (AF Area: Spot, Multi, or Free); Macro mode; Infinity mode; Manual Focus; focus lock

Approximate Focus Range (from lens surface)

Normal 40cm to ∞ (1.3' to ∞)
Macro Approximately 10cm to 50cm
(3.9" to 19.7") at wide angle
Approximately 40cm to 50cm
(15.6" to 19.7") at telephoto

Exposure Control

Light Metering Multi-pattern by CCD
Exposure Program AE, Aperture priority AE, Shutter speed priority AE, Manual exposure
Exposure Compensation -2EV to +2EV (1/3EV units)

Shutter CCD electronic shutter; mechanical shutter,
Snapshot mode, BESTSHOT mode :
1/8 to 1/2000 second
Aperture Priority AE mode : 1 to 1/2000 second
Shutter Speed Priority AE mode,
Manual Exposure mode : BULB, 60 to 1/2000 second
• Shutter speed is different for the following BESTSHOT scenes.
Night Scene: 4 to 1/2000 second
Fireworks: BULB, 60 to 1/2000 second

Aperture F2.8, 3.2, 3.5, 4.0, 4.5, 5.0, 5.6, 6.3, 7.1, 8.0
• Using optical zoom causes the aperture to change.
• An aperture setting from F2.8 to 5.6 is possible in the Snapshot mode

APPENDIX

White Balance	Automatic, fixed (7 modes), manual switching
Sensitivity	Auto, ISO 80, ISO 160, ISO 320, ISO 640
Self-timer	10 seconds, 2 seconds, Triple Self-timer, Remote controller, Remote controller and 2-second Self-timer
Built-in Flash	
Flash Modes	AUTO, ON, OFF, Red eye reduction
Flash Range	Wide Angle Optical Zoom: 0.4 to 3.6 meters (1.3' to 11.8') Telephoto Optical Zoom: 0.4 to 2.5 meters (1.3' to 8.2') (ISO Sensitivity: "Auto")
Recording Functions	Audio snapshot; Macro; self-timer; Aperture priority AE; Shutter speed priority AE; Manual exposure; BESTSHOT; Continuous shutter; Auto Bracketing; Movie with audio; voice recording * Audio recording is monaural.
Audio Recording Time	
Audio Snapshot	Approximately 30 seconds maximum per image
Voice Recording	Approximately 38 minutes with built-in memory
After Recording	Approximately 30 seconds maximum per image

Monitor Screen	2.0-inch TFT color LCD 115,200 pixels (480 × 240)
Viewfinder	Monitor screen and optical viewfinder
Timekeeping Functions	
Built-in digital quartz clock	
Date and Time	Recorded with image data
Auto Calendar	To 2049
World Time	City; Date; Time; Summer time; 162 cities in 32 time zones
Input/Output Terminals	
AC adaptor connector (DC IN); USB / AV port (Special mini port, NTSC/PAL); External flash sync terminal	
Microphone	Monaural
Speaker	Monaural

APPENDIX

■ Power Requirements

Power Requirements Rechargeable lithium ion battery (NP-40) × 1
AC adaptor (AD-C40)

Approximate Battery Life:

The values below indicate the amount of time under the conditions defined below, until power automatically turns off due to battery failure. They do not guarantee that you will be able to achieve this level of operation. Low temperatures shorten battery life.

Operation	Approximate Battery Life
Number of Shots (CIPA Standard)*1 (Operating Time)	200 shots (100 minutes)
Number of Shots, Continuous Recording*2 (Operating Time)	440 shots (110 minutes)
Continuous Snapshot Playback*3	220 minutes
Continuous Voice Recording*4	210 minutes

Supported Battery: NP-40 (Rated Capacitance: 1230mAh)
Storage Medium: SD Memory Card

*1 Number of Shots (CIPA Standard)

- Temperature: 23°C (73°F)
- Monitor Screen: On
- Zoom operation between full wide to full telephoto every 30 seconds, during which two images are recorded, one image with flash; power turned off and back on every time 10 images are recorded.

*2 Continuous Recording Conditions

- Temperature: 23°C (73°F)
- Monitor screen: On
- Flash: Off
- Image recorded every 15 seconds, alternating full wide-angle and full telephoto zoom

*3 Continuous Snapshot Playback Conditions

- Temperature: 23°C (73°F)
- Scroll one image about every 10 seconds

*4 Voice recording times are based on continuous recording.

Power Consumption 4.5V DC Approximately 5.5W

Dimensions 97.5(W) × 67.5(H) × 45.1(D) mm
(3.8"(W) × 2.7"(H) × 1.8"(D))
(excluding projections; 26.1mm (1.0")
at thinnest part)

Weight Approximately 225 g (7.9 oz)
(excluding battery and accessories)

Bundled Accessories Rechargeable lithium ion battery (NP-40); Rapid charger (BC-30L); Card Remote Controller (WR-4C); lithium battery (CR2025); AC power cord; USB cable; AV cable; Strap; CD-ROM; Basic Reference

APPENDIX

■ Rechargeable Lithium Ion Battery (NP-40)

Rated Voltage 3.7 V

Rated Capacitance 1230 mAh

Operating Temperature

Range 0°C to 40°C (32°F to 104°F)

Dimensions 38.5(W) × 38.0(H) × 9.3(D) mm
(1.5"(W) × 1.5"(H) × 0.37"(D))

Weight Approximately 34 g (1.20 oz)

■ Rapid Charger (BC-30L) : Power Cord Type

Power Requirement 100 to 240V AC, 0.13A, 50/60Hz

Output 4.2V DC, 900 mA

Charging Temperature 5°C to 35°C (41°F to 95°F)

Chargeable Battery type ... Rechargeable lithium ion battery (NP-40)

Full Charge Times Approximately 2 hours

Dimensions 80 (W) × 55 (H) × 30 (D) mm
(3.1"(W) × 2.2"(H) × 1.2"(D))
(excluding projections)

Weight Approximately 60 g (2.1 oz)

■ Rapid Charger (BC-30L) : Plug-in Type

Power Requirement 100 to 240V AC, 0.13A, 50/60Hz

Output 4.2V DC, 900 mA

Charging Temperature 5°C to 35°C (41°F to 95°F)

Chargeable Battery type ... Rechargeable lithium ion battery (NP-40)

Full Charge Times Approximately 2 hours

Dimensions 80 (W) × 55 (H) × 25 (D) mm
(3.1"(W) × 2.2"(H) × 0.98"(D))
(excluding projections)

Weight Approximately 63 g (2.2 oz)

■ Card Remote Controller (WR-4C)

Power Requirements Lithium battery (CR2025) × 1

Approximate Battery Life ... 20,000 button operations

- One button operation is defined as depressing a button for one second, and then releasing it for one second.

Operating Temperature 0°C to 40°C (32°F to 104 °F)

Dimensions 35.0 (W) × 56.6 (H) × 6.5 (D) mm
(1.38" (W) × 2.23" (H) × 0.26" (D))

Weight Approximately 11 g (0.39 oz)
(including battery)

Power Supply

- Use only the special NP-40 rechargeable lithium ion battery to power this camera. Use of any other type of battery is not supported.
- This camera does not have a separate battery for the clock. The date and time settings of the camera are cleared whenever power is totally cut off (from both the battery and AC adaptor). Be sure to reconfigure these settings after power is interrupted (page 54).

LCD Panel

- The LCD panel is a product of the latest LCD manufacturing technology that provides a pixel yield of 99.99%. This means that less than 0.01% of the total pixels are defective (they do not turn on or always remain turned on).

Lens

- You may sometimes notice some distortion in certain types of images, such as a slight bend in lines that should be straight. This is due to the characteristics of lens, and does not indicate malfunction of the camera.

Free Manuals Download Website

<http://myh66.com>

<http://usermanuals.us>

<http://www.somanuals.com>

<http://www.4manuals.cc>

<http://www.manual-lib.com>

<http://www.404manual.com>

<http://www.luxmanual.com>

<http://aubethermostatmanual.com>

Golf course search by state

<http://golfingnear.com>

Email search by domain

<http://emailbydomain.com>

Auto manuals search

<http://auto.somanuals.com>

TV manuals search

<http://tv.somanuals.com>