

Digital Camera

E

QV-R61

User's Guide

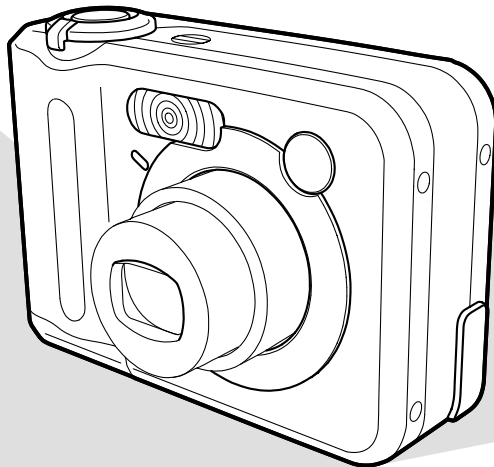

Thank you for purchasing this CASIO product.

- Before using it, be sure to read the precautions contained in this User's Guide.
- Keep the User's Guide in a safe place for future reference.
- For the most up-to-date information about this product, visit the CASIO Website at <http://world.casio.com/>.

K867PCM1DKX

Download from [Www.Somanuals.com](http://www.Somanuals.com). All Manuals Search And Download.

CASIO[®]

INTRODUCTION

Unpacking

Check to make sure that all of the items shown below are included with your camera. If something is missing, contact your dealer as soon as possible.



Camera

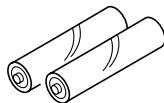

2 AA-size Rechargeable
Nickel-Metal Hydride
Batteries (HR-3U <Rated
Capacitance 2100 mAh>)

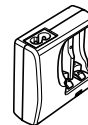

Charger Unit
(BC-5H)

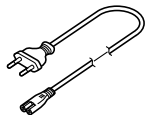

AC Power Cord *

* The shape of the AC
power cord plug varies
according to country or
geographic area.

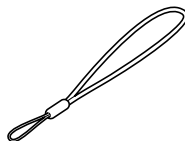

Strap



CD-ROM

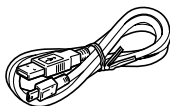

USB Cable

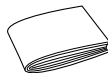

Basic Reference

Contents

2 INTRODUCTION

Unpacking	2
Features	9
Precautions	12
General Precautions	12
Data Error Precautions	19
Operating conditions	20
Condensation	20
Lens	21
Other	21

22 QUICK START GUIDE

First, charge the batteries!	22
To configure display language and clock settings	23
To record an image	24
To view a recorded image	25
To delete an image	25

26 GETTING READY

About This Manual	26
General Guide	27
Monitor Screen Contents	29
REC mode	29
PLAY mode	31
Changing the Contents of the Monitor Screen	32
Indicator Lamps	33
Attaching the Strap	33
Power Requirements	34
Charging Batteries	34
To load batteries	39
To remove the batteries from the camera	39
Using AC Power	43
Turning the Camera On and Off	45
Configuring Power Saving Settings	46
Using the On-screen Menus	47
Configuring Display Language and Clock Settings ...	50
To configure display language and clock settings	51

INTRODUCTION

53 BASIC IMAGE RECORDING

Recording an Image	53
Specifying the Recording Mode	53
Aiming the Camera	54
Recording an Image	55
Recording Precautions	57
About Auto Focus	58
About the REC Mode Monitor Screen	59
Using the Optical Viewfinder	59
Using Zoom	60
Optical Zoom	60
Digital Zoom	62
Using the Flash	63
Flash Unit Status	65
Changing the Flash Intensity Setting	65
Using Flash Assist	66
Flash Precautions	67
Using the Self-timer	68
Specifying Image Size	70
Specifying Image Quality	71

72 OTHER RECORDING FUNCTIONS

Selecting the Focus Mode	72
Using Auto Focus	73
Using the Macro Mode	75
Using the Infinity Mode	76

Using Manual Focus	76
Using Focus Lock	78
Exposure Compensation (EV Shift)	79
Adjusting White Balance	80
Configuring the White Balance Setting Manually	82
Using the High-speed Continuous Shutter Mode	83
Using the BESTSHOT Mode	84
Creating Your Own BESTSHOT Setup	87
Combining Shots of Two People into a Single Image (Coupling Shot)	89
Recording a Subject onto an Existing Background Image (Pre-shot)	91
Recording Images of Business Cards and Documents (Business Shot)	93
To use Business Shot	94
Using the Movie Mode	95
Using the Histogram	97
REC Mode Camera Settings	99
Specifying ISO Sensitivity	100
Selecting the Metering Mode	101
Using the Filter Function	102
Specifying Outline Sharpness	103
Specifying Color Saturation	103
Specifying Contrast	104
Turning the On-screen Grid On and Off	104
Turning Image Review On and Off	105
Using Icon Help	105
Assigning Functions to the [◀] and [▶] Keys	106

INTRODUCTION

Specifying Power On Default Settings	107
Resetting the Camera	109

110 PLAYBACK

Basic Playback Operation	110
Zooming the Display Image	111
Resizing an Image	112
Cropping an Image	113
Playing a Movie	115
Displaying the 9-image View	116
Selecting a Specific Image in the 9-image View	117
Displaying the Calendar Screen	117
Playing a Slideshow	118
To specify the slideshow images	120
To specify the slideshow time	121
To set the slideshow interval	121
Rotating the Display Image	122
Using Image Roulette	123

124 DELETING FILES

Deleting a Single File	124
Deleting All Files	125

126 FILE MANAGEMENT

Folders	126
Memory Folders and Files	126
Protecting Files	127
To protect a single file	127
To protect all files in memory	128
Using the FAVORITE Folder	128
To copy a file to the FAVORITE folder	128
To display a file in the FAVORITE folder	130
To delete a file from the FAVORITE folder	131
To delete all files from the FAVORITE folder	131

132 OTHER SETTINGS

Specifying the File Name Serial Number Generation Method	132
Turning the Key Tone On and Off	132
Specifying an Image for the Startup Screen	133
Configuring Power Down Image Settings	134
Using the Alarm	136
To set an alarm	136
Stopping the Alarm	137
Setting the Clock	137
To select your Home Time zone	138
To set the current time and date	139
Changing the Date Format	139

INTRODUCTION

Using World Time	140
To display the World Time screen	140
To configure World Time settings	140
To configure summer time (DST) settings	141
Changing the Display Language	142
Changing the USB Port Protocol	143
Configuring [RECORD] (REC) and [PLAY] (PLAY)	
Power On/Off Functions	144
Formatting Built-in Memory	145

146 USING A MEMORY CARD

Using a Memory Card	147
To insert a memory card into the camera	147
To remove a memory card from the camera	148
To format a memory card	148
Memory Card Precautions	149
Copying Files	150
To copy all the files in	
built-in memory to a memory card	150
To copy a specific file from	
a memory card to built-in memory	151

152 PRINTING IMAGES

DPOF	153
To configure print settings for a single image	154
To configure print settings for all images	155
Using PictBridge or USB DIRECT-PRINT	156
To print a single image	156
To print a group of images	159
Printing Precautions	160
PRINT Image Matching III	160
Exif Print	161

162 VIEWING IMAGES ON A COMPUTER

Using the Camera with a Windows Computer	162
USB Connection Precautions	168
Using the Camera with a Macintosh Computer	168
USB Connection Precautions	172
Operations You Can Perform from Your Computer .	172
Using a Memory Card to	
Transfer Images to a Computer	173
Memory Data	174
DCF Protocol	174
Memory Folder Structure	174
Image Files Supported by the Camera	175
Built-in Memory and Memory Card Precautions	176

177 USING THE CAMERA WITH A COMPUTER

Using the Album Feature	177
Creating an album	177
Selecting an Album Layout	179
Configuring Detailed Album Settings	179
Viewing Album Files	182
Saving an Album	184
To delete an album	185
Installing the Software from the CD-ROM	185
About the bundled CD-ROM	185
Computer System Requirements	187
Installing Software from the CD-ROM in Windows ..	188
Getting Started	189
Selecting a Language	189
Viewing the Contents of the "Read me" File	189
Installing an Application	190
Viewing User Documentation (PDF Files)	190
User Registration	191
Exiting the Menu Application	191
Installing Software from the CD-ROM on a Macintosh	191
Installing Software	191
Viewing User Documentation (PDF Files)	192

194 APPENDIX

Menu Reference	194
Indicator Lamp Reference	196
REC mode	197
PLAY mode	198
Charger Unit	198
Troubleshooting Guide	199
If you have problems installing the USB driver...	203
Display Messages	204
Specifications	206

INTRODUCTION

»» IMPORTANT! ««

- The contents of this manual are subject to change without notice.
- CASIO COMPUTER CO., LTD. assumes no responsibility for any damage or loss resulting from the use of this manual.
- CASIO COMPUTER CO., LTD. assumes no responsibility for any loss or claims by third parties which may arise through the use of the QV-R61.
- CASIO COMPUTER CO., LTD. shall not be held liable for any damages or losses suffered by you or any third party due to the use of Photo Loader and/or Photohands.
- CASIO COMPUTER CO., LTD. assumes no responsibility for any damage or loss caused by deletion of data as a result of malfunction, repairs, or battery replacement. Be sure to back up all important data on other media to protect against its loss.
- Note that the example screens and product illustrations shown in this User's Guide may differ somewhat by the screens and configuration of the actual camera.

- *The SD logo is a registered trademark.*
- *Windows, Internet Explorer, and DirectX are registered trademarks of Microsoft Corporation.*
- *Macintosh is a registered trademark of Apple Computer, Inc.*
- *MultiMediaCard is a trademark of Infineon Technologies AG of Germany, and licensed to the MultiMediaCard Association (MMCA).*
- *Adobe and Reader are either registered trademarks or trademarks of Adobe Systems Incorporated in the United States and/or other countries.*
- *Other company, product and service names used herein may also be trademarks or service marks of others.*
- *Photo Loader and Photohands are the property of CASIO COMPUTER CO., LTD. Except as stipulated above, all copyrights and other related rights to these applications revert to CASIO COMPUTER CO., LTD.*

INTRODUCTION

■ Copyright Restrictions

Except for the purpose of your own personal enjoyment, unauthorized copying of snapshot files and movie files violates copyright laws and international contracts. Distribution to third parties of such files over the Internet without permission of the copyright holder, whether for profit or for free, violates copyright laws and international contracts.

Features

- 6 million effective pixels
The CCD provides 6.37 million total pixels of very high-resolution for crisp, clear, prints and display images.
- 2.0-inch TFT color LCD monitor screen
- 12X seamless zoom
3X optical zoom, 4X digital zoom
- 9.7MB flash memory
Images can be recorded without using a memory card.
- Support for SD memory cards and MMC (MultiMedia Cards) for memory expansion (page 146)
- Easy Image Transfer (pages 162, 168)
Transfer images to a computer simply by connecting the camera with a USB cable.
- High-speed continuous shutter mode (page 83)
Images are recorded at high speed as long as you keep the shutter button depressed.
- BESTSHOT (page 84)
Simply select the sample scene that matches the type of image you are trying to record and the camera performs troublesome setups automatically for beautiful pictures every time.

INTRODUCTION

- **Business Shot (page 93)**
Business Shot automatically corrects rectangular shapes when recording the image of a business card, document, whiteboard, or similar subjects from an angle.
- **Coupling Shot and Pre-shot (pages 89, 91)**
Coupling Shot lets you combine two subjects into a single image, while Pre-shot lets you add a subject to a previously recorded background image. This means you can create images that include you and your friend, even if you are the only two people around.
- **Slideshow Feature (page 118)**
Images are displayed automatically one-by-one.
- **Triple Self-timer mode (page 68)**
The self-timer can be set up to repeat three times, automatically.
- **Real-time histogram (page 97)**
An on-screen histogram lets you adjust exposure as you view the effect on overall image brightness, which makes shooting under difficult lighting conditions easier than ever before.
- **World Time (page 140)**
A simple operation sets the current time for your current location. You can select from among 162 cities in 32 time zones.
- **Alarm (page 136)**
A built-in alarm helps to keep you on time for important events, and even can be used in place of an alarm clock. You can also have a specific image appear on the monitor screen when the alarm time is reached.
- **Album Function (page 177)**
HTML files are generated automatically to create an album of recorded images. Album contents can be viewed and printed using a standard Web browser. Images can also be incorporated into Web pages quickly and easily.
- **Calendar screen (page 117)**
A simple operation displays a full-month calendar on the camera's monitor screen. Each day of the full-month calendar shows a thumbnail of the first image recorded for that date, which helps to make searching for a particular image quicker and easier.

INTRODUCTION

- DCF Data Storage (page 174)
DCF (Design rule for Camera File system) data storage protocol provides image compatibility between the digital camera and printers.
- Digital Print Order Format (DPOF) (page 153)
Images can be printed easily in the sequence you want using a DPOF compatible printer. DPOF can also be used when specifying images and quantities for printing by professional print services.
- PRINT Image Matching III Compatible (page 160)
Images include PRINT Image Matching III data (mode setting and other camera setup information). A printer that supports PRINT Image Matching III reads this data and adjusts the printed image accordingly, so your images come out just the way you intended when you recorded them.
- USB DIRECT-PRINT and PictBridge support (page 156)
Connect directly to a USB DIRECT-PRINT or PictBridge compatible printer and you can print images without going through a computer.
- Photo Loader and Photohands (page 186)
Your camera comes bundled with Photo Loader, the popular application that automatically loads images from your camera to your PC. It also comes with Photohands, an application that makes image retouching quick and easy.

Precautions

General Precautions

Be sure to observe the following important precautions whenever using the QV-R61. All references in this manual to “camera” refer to the CASIO QV-R61 Digital Camera.

■ Test for proper operation before using the camera!

- Before using the camera to record important images, make sure you first record a number of test images and check the results to ensure that the camera is configured correctly and operating properly (page 22).

■ Avoid Use While In Motion

- Never use the camera to record or play back images while operating an automobile or other vehicle, or while walking. Looking at the monitor while in motion creates the risk of serious accident.

■ Directly Viewing the Sun or Bright Light

- Never look at the sun or any other bright light through the camera’s viewfinder. Doing so can damage your eyesight.

■ Flash

- Never use the flash unit in areas where flammable or explosive gas may be present. Such conditions create the risk of fire and explosion.
- Never fire the flash in the direction of a person operating a motor vehicle. Doing so can interfere with the driver’s vision and creates the risk of accident.
- Never fire the flash too close to the eyes of the subject. Doing so creates the risk of loss of eyesight.

■ Display Panel

- Do not apply strong pressure to the LCD panel surface or subject it to strong impact. Doing so can cause the display panel glass to crack.
- Should the display panel ever become cracked, never touch any of the liquid inside the panel. Doing so creates the risk of skin inflammation.
- Should display panel liquid ever get into your mouth, immediately rinse your mouth out and contact your physician.
- Should display panel liquid ever get into your eyes or onto your skin, immediately rinse with clean water for at least 15 minutes and contact your physician.

■ Connections

- Never plug any devices that are not specified for use with this camera into connectors. Connecting a non-specified device creates the risk of fire and electric shock.

■ Transport

- Never operate the camera inside of an aircraft or anywhere else where operation of such devices is restricted. Improper use creates the risk of serious accident.

■ Smoke, abnormal odor, overheating, and other abnormalities

- Continued use of the camera while it is emitting smoke or strange odor, or overheating creates the risk of fire and electric shock. Immediately perform the following steps whenever any of the above symptoms are present.
 1. Turn off the camera.
 2. If you are using the AC adaptor to power the camera, unplug it from the wall outlet. If you are using battery power, remove the batteries from the camera, taking care to protect yourself against burn injury.
 3. Contact your dealer or nearest CASIO authorized service center.

■ Water and Foreign Matter

- Water, other liquids, or foreign matter (especially metal) getting inside the camera creates the risk of fire and electric shock. Immediately perform the following steps whenever any of the above symptoms are present. Particular care is required when using the camera where it is raining or snowing, near the ocean or other body of water, or in a bathroom.
1. Turn off the camera.
 2. If you are using the AC adaptor to power the camera, unplug it from the wall outlet. If you are using battery power, remove the batteries from the camera.
 3. Contact your dealer or nearest CASIO authorized service center.

■ Dropping and Rough Treatment

- Continued use of the camera after it is damaged by dropping or other rough treatment creates the risk of fire and electric shock. Immediately perform the following steps whenever any of the above symptoms are present.
1. Turn off the camera.
 2. If you are using the AC adaptor to power the camera, unplug it from the wall outlet. If you are using battery power, remove the batteries from the camera.
 3. Contact your dealer or nearest CASIO authorized service center.

■ Keep Away From Fire

- Never expose the camera to fire, which can cause it to explode and creates the risk of fire and electric shock.

■ Disassembly and Modification

- Never try to take the camera apart or modify it in any way. Doing so creates the risk of electric shock, burn injury, and other personal injury. Be sure to leave all internal inspection, maintenance, and repair up to your dealer or nearest CASIO authorized service center.

■ Locations To Be Avoided

- Never leave the camera in any of the following types of locations. Doing so creates the risk of fire and electric shock.
 - Areas subject to large amounts of humidity or dust
 - Food preparation areas or other locations where oil smoke is present
 - Near heaters, on a heated carpet, in areas exposed to direct sunlight, in a closed vehicle parked in the sun, or other areas subject to very high temperatures
- Never place the camera on an unstable surface, on a high shelf, etc. Doing so can cause the camera to fall, creating the risk of personal injury.

■ Backing Up Important Data

- Always keep backup copies of important data in camera memory by transferring it to a computer or other storage device. Note that data can be deleted in the case of camera malfunction, repair, etc.

■ Memory Protection

- Whenever replacing batteries, be sure to follow the correct procedure as described in the documentation that comes with the camera. Incorrectly replacing batteries can result in corruption or loss of data in camera memory.

■ Batteries

- Misuse of batteries can cause them to leak, which damages and corrodes the area around the batteries and creates the risk of fire and personal injury. Make sure you observe the following precautions when using batteries.
 - Never try to take batteries apart and never allow them to become shorted.
 - Do not expose batteries to heat or fire.
 - Never mix new batteries with old ones.
 - Never mix batteries of different types.
 - Do not charge non-rechargeable batteries.
 - When loading batteries, make sure their positive (+) and negative (–) ends are facing correctly.
 - When using rechargeable batteries, be sure to read the Safety Precautions section of the user documentation that comes with them.
 - Use only the batteries that are specified for this camera.
 - If you do not plan to use the camera for a long time, remove its batteries.

INTRODUCTION

■ Alkaline Batteries

- Should liquid from an alkaline battery ever get into your eyes, take the following steps.
 1. Immediately rinse your eyes with clean water. Do not rub!
 2. See a physician as soon as possible.

Failure to clean alkaline battery fluid from the eyes creates the risk of loss of sight.

■ Rechargeable Batteries

- Should you ever notice any of the following conditions while using, charging, or storing batteries, immediately remove them from the camera or the battery charger unit, and keep it away from open flame:
 - Fluid leaking
 - Emission of a strange odor
 - Heat emission
 - Battery discoloration
 - Battery deformation
 - Any other battery abnormality
- The term “battery” in this manual refers to the rechargeable nickel-metal hydride batteries.
- The term “charger unit” in the following precautions refers to the CASIO BC-5H Charger Unit.

- Failure to observe any of the following precautions while using batteries creates the risk of overheating, fire, and explosion.
 - Never use any other type of charger unit except the one specified for the batteries.
 - Never try to use batteries to power any device other than this camera.
 - Never use or leave batteries near open flame.
 - Never place batteries in a microwave oven, throw it into fire, or otherwise expose it to intense heat.
 - Make sure batteries are oriented correctly when you load them into the camera or attach them to the charger unit.
 - Never carry or store batteries together with items that can conduct electricity (necklaces, pencil lead, etc.).
 - Never try to take batteries apart, modify them in any way, or expose them to strong impact.
 - Do not immerse batteries in fresh water or salt water.
 - Do not use or leave batteries under direct sunlight, in an automobile parked in the sun, or in any other area subject to high temperatures.

INTRODUCTION

- If the batteries do not achieve full charge after the normal charging time has passed, stop charging. Continued charging creates the risk of overheating, fire, and explosion.
- Battery fluid can damage your eyes. Should battery fluid get into your eyes accidentally, immediately rinse them with clean tap water and then consult a physician.
- If batteries are to be used by young children, make sure that a responsible adult makes them aware of the precautions and proper handling instructions, and make sure that they handle batteries correctly.
- Should fluid from batteries accidentally get onto clothing or your skin, immediately rinse it off with clean tap water. Prolonged contact with battery fluid can cause skin irritation.

■ Charger Unit

- Never plug the charger unit into an outlet whose voltage rating is different from that marked on the charger unit. Doing so creates the risk of fire, malfunction, and electric shock.
- Never plug in or unplug the charger unit while your hands are wet. Doing so creates the risk of electric shock.
- Do not plug the charger unit into an outlet or extension cord that is shared by other devices. Doing so creates the risk of fire, malfunction, and electric shock.
- The charger unit becomes slightly warm during charging. This is normal and does not indicate malfunction.
- Unplug the charger unit from the power outlet whenever you are not using it.

■ AC Adaptor (Option)

- Misuse of the optional AC adaptor creates the risk of fire and electric shock. Make sure you observe the following precautions when using the AC adaptor.
 - Use only the optional AC adaptor specified for this camera.
 - Use a 100 to 240V AC (50/60Hz) wall outlet as a power source.
 - Never plug the power cord into a wall outlet that is shared by other devices, or into a shared extension cord.
- Misuse of the AC adaptor can cause it to become damaged, creating the risk of fire and electric shock. Make sure you observe the following precautions when using the AC adaptor.
 - Never place heavy objects on the AC adaptor or subject it to direct heat.
 - Never try to modify the AC adaptor or subject it to bending.
 - Do not twist or pull on the power cord.
 - Should the power cord or plug ever become damaged, contact your dealer or nearest CASIO authorized service center.
- Use the AC adaptor where it will not be splashed with water. Water creates the risk of fire and electric shock.
- Do not place a vase or any other container filled with liquid on top of the AC adaptor. Water creates the risk of fire and electric shock.
- Never touch the AC adaptor while your hands are wet. Doing so creates the risk of electric shock.
- Misuse of the optional AC adaptor creates the risk of fire and electric shock. Make sure you observe the following precautions when using the AC adaptor.
 - Never locate the power cord near a stove or other heating device.
 - When unplugging from the wall outlet, grasp the plug on the AC adaptor power cord. Never pull on the power cord.
 - Insert the plug into the wall outlet as far as it will go.
 - Unplug the AC adaptor from the wall outlet before leaving the camera unattended for long periods, such as when leaving on a trip, etc.
 - At least once a year, unplug the AC adaptor from the wall outlet and clean off any dust built up around the prongs.

■ Battery Life

- The battery lives noted in the User's Guide are approximate values until power fails, based on use of batteries of recommended brands at temperature 23°C (73°F), and do not guarantee you will be able to achieve operation for the life noted. Actual battery life is greatly affected by the battery brand, battery production date, and ambient temperature.
- Leaving the camera on can run down batteries and cause the low battery warning to appear. Turn off the camera whenever you are not using it.
- Sometimes, the camera may shutdown after the low battery warning appears. If this happens, immediately replace both of the batteries. Leaving low or dead batteries in the camera can lead to battery leakage and data corruption.
- Though you could use alkaline batteries when there are no other types of batteries available, note that the life of alkaline batteries will be very short. Use of rechargeable nickel-metal hydride batteries or lithium batteries is recommended.

Data Error Precautions

- Your digital camera is manufactured using precision digital components. Any of the following creates the risk of corruption of data in file memory.
 - Removing the batteries or memory card from the camera, or connecting the USB cable to the camera while the camera is performing a record or memory access operation
 - Removing the batteries or memory card from the camera, or connecting the USB cable to the camera while the operation lamp is still flashing after you turn off the camera
 - Disconnecting the USB cable or disconnecting the AC adaptor from the camera while a USB data communication operation is being performed
 - Low battery power
 - * Note that continued use of weak batteries can lead to malfunction of the camera. Charge the batteries or replace the batteries with new ones as soon as possible after signs of low power appear.
 - Other abnormal operations

Any of the above conditions can cause an error message to appear on the monitor screen (page 204). Follow the instructions provided by the message to eliminate the cause of the error.

Operating conditions

- This camera is designed for use in temperatures ranging from 0°C to 40°C (32°F to 104°F).
- Do not use or keep the camera in the following areas.
 - In areas subject to direct sunlight
 - In areas subject to high humidity or dust
 - Near air conditioners, heaters, or other areas subject to temperature extremes
 - Inside of a closed vehicle, especially one parked in the sun
 - In areas subject to strong vibration

Condensation

- When you bring the camera indoors on a cold day or otherwise expose it to a sudden change of temperature, there is the possibility that condensation can form on the exterior or on interior components. Condensation can cause malfunction of the camera, so you should avoid exposing it to conditions that might cause condensation.
- To keep condensation from forming, place the camera into a plastic bag before moving it into a location that is much warmer or colder than your current location. Leave it in the plastic bag until the air inside the bag has a chance to reach the same temperature as the new location. If condensation does form, remove the batteries from the camera and leave the battery compartment cover open for a few hours.

Lens

- Never apply too much force when cleaning the surface of the lens. Doing so can scratch the lens surface and cause malfunction.
- Fingerprints, dust, or any other soiling of the lens can interfere with proper image recording. Never touch the lens with your fingers. You can remove dust particles from the lens surface by using a lens blower to blow them off. Next, wipe the surface of the lens with a soft lens cloth.

Other

- The camera may become slightly warm during use. This does not indicate malfunction.
- If the exterior of the camera needs cleaning, wipe it with a soft, dry cloth.

QUICK START GUIDE

First, charge the batteries!

1. Charge the rechargeable nickel-metal hydride batteries (HR-3U) that come with the camera (page 34).

- It takes about four hours to achieve a full charge.

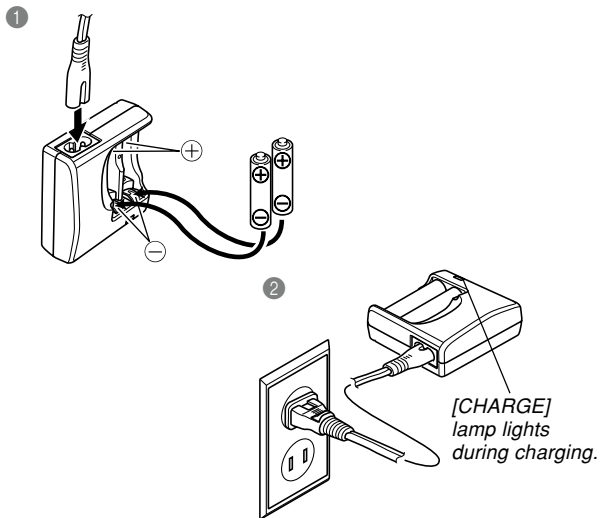

2. Load the batteries into the camera. (page 39).

- Note that you can also power the camera using commercially available AA-size lithium batteries and AA-size alkaline batteries.

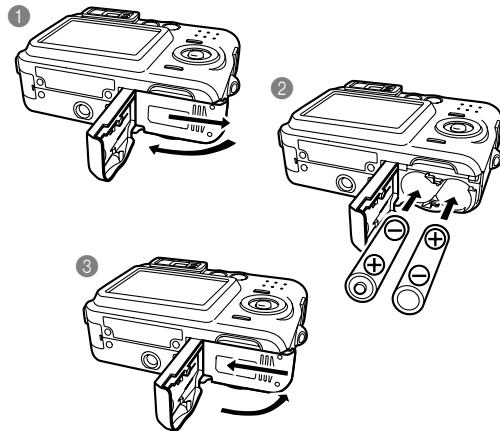

To configure display language and clock settings

- Be sure to configure the following settings before using the camera to record images.
(See page 50 for details.)

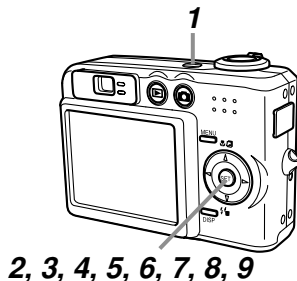

1. Press the power button to turn on the camera.
2. Use [▲], [▼], [◀], and [▶] to select the language you want.
3. Press [SET] to register the language setting.
4. Use [▲], [▼], [◀], and [▶] to select the geographical area you want, and then press [SET].
5. Use [▲] and [▼] to select the city you want, and then press [SET].
6. Use [▲] and [▼] to select the summer time (DST) setting you want, and then press [SET].
7. Use [▲] and [▼] to select the date format setting you want, and then press [SET].
8. Set the date and the time.
9. Press [SET] to register the clock settings and exit the setting screen.

To record an image

Green operation lamp (See page 53 for details.)

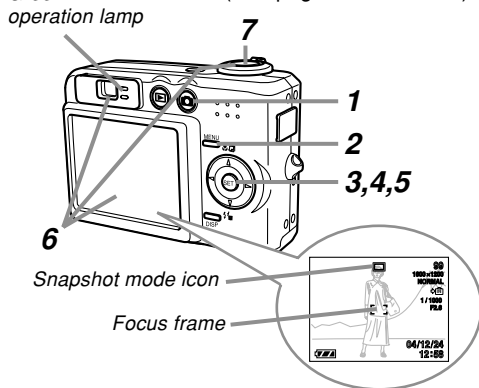

1. Press [] (REC).

2. Press [MENU].



3. Use [◀] and [▶] to select the “REC” tab.

4. Use [▲] and [▼] to select “REC Mode”, and then press [▶].

5. Use [▲] and [▼] to select “ Snapshot”, and then press [SET].

- This causes “” (Snapshot Mode) to appear on the monitor screen.

6. Point the camera at the subject, use the monitor screen or viewfinder to compose the image, and then press the shutter button half way.

- When proper focus is achieved, the focus frame turns green and the green operation lamp lights.

7. Holding the camera still, gently press the shutter button all the way down.

To view a recorded image

(See page 110 for details.)

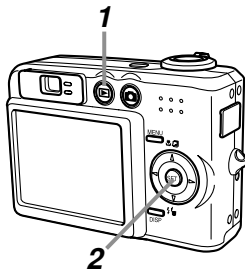

1. Press [▶] (PLAY).
2. Use [◀] and [▶] to scroll through the images.

To delete an image

(See page 124 for details.)

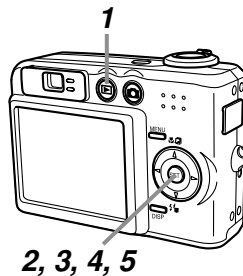

1. Press [▶] (PLAY).
2. Press [▼] (⏏).
3. Use [◀] and [▶] to display the image you want to delete.
4. Use [▲] and [▼] to select "Delete".
 - To exit the image delete operation without deleting anything, select "Cancel".
5. Press [SET] to delete the image.

GETTING READY

This section contains information about things you need to know about and do before trying to use the camera.

About This Manual

This section contains information about the conventions used in this manual.

Terminology

The following table defines the terminology used in this manual.

This term as used in this manual:	Means this:
"camera"	The CASIO QV-R61 Digital Camera
"file memory"	The location where the camera is currently storing images you record (page 55)
"batteries"	The Rechargeable nickel-metal hydride batteries
"charger unit"	The CASIO BC-5H Charger Unit

Button Operations

Button operations are indicated by the button name inside of brackets ([]).

On-screen Text

On-screen text is always enclosed by double quotation marks (" ").

File Memory

The term "file memory" in this manual is a general term that refers to the location where your camera is currently storing the images you record. File memory can be any one of the following three locations.

- The camera's built-in flash memory
- An SD memory card loaded in the camera
- A MultiMediaCard loaded in the camera

For more information about how the camera stores images, see page 174.

General Guide

The following illustrations show the names of each component, button, and switch on the camera.

■ Front

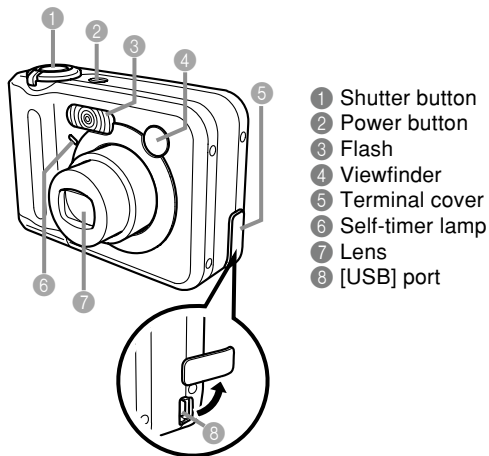

■ Back

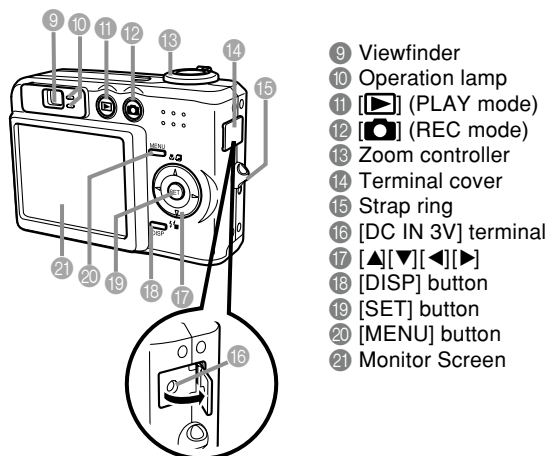

GETTING READY

■ Bottom

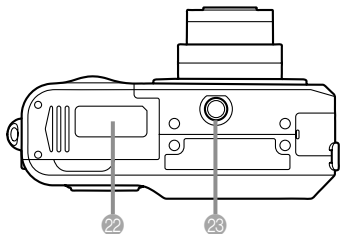

- 22 Battery compartment cover
- 23 Tripod screw hole
 - Use this hole when attaching to a tripod.

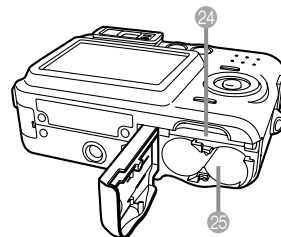

- 24 Memory card slot
- 25 Battery compartment

Monitor Screen Contents

The monitor screen uses various indicators and icons to keep you informed of the camera's status.

- Note that the example screens in this chapter are for illustrative purposes only. They do not exactly match the screen contents actually produced on the camera.

REC mode

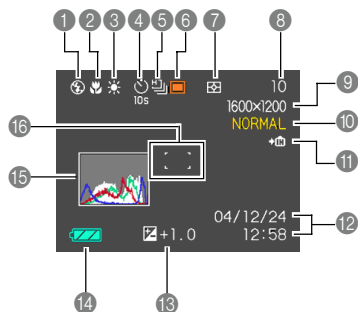

1 Flash mode indicator (page 63)

- None Auto
- Flash Off
- Flash On
- Red-eye reduction

- If the camera detects that flash is required while auto flash is selected, the flash on indicator will appear when the shutter button is pressed half way.

2 Focus mode indicator (page 72)

- None Auto Focus
- Macro
- Infinity
- Manual Focus

3 White balance indicator (page 80)

- None Auto
- Daylight
- Cloudy
- Shade
- Fluorescent 1
- Fluorescent 2
- Light Bulb
- Manual

4 Self-timer (page 68)

- None 1-Image
- Self-timer 10 sec
- Self-timer 2 sec
- Triple self-timer

5 Continuous shutter mode (page 83)

- None Single Shot
- High-speed Continuous

6 REC modes (page 53)

- Snapshot
- BESTSHOT
- Movie

7 Metering mode indicator (page 101)

- Multi-pattern Metering
- Center-weighted Metering
- Spot Metering

8 Memory capacity (pages 95, 206)

- (Remaining number of storable images)
- Movie Recording: Remaining recording time

GETTING READY

9 Image size (page 70)

2816 × 2112 pixels
2816 × 1872 (3:2) pixels
2048 × 1536 pixels
1600 × 1200 pixels
1280 × 960 pixels
640 × 480 pixels

Moving Recording : Recording time

10 Quality (page 71)

FINE
NORMAL
ECONOMY

11  Built-in memory selected for data storage.

 Memory card selected for data storage.

(page 146)

NOTE

- Changing the setting of any one of the following functions will cause Icon Help text to appear on the monitor screen. You can turn off Icon Help if you want (page 105).
REC mode, flash mode, focus mode, white balance, self-timer, metering mode

12 Date and time (page 137)

13 EV value (page 79)

14 Battery capacity (page 40)

15 Histogram (page 97)

16 Focus frame (page 56)

- Focusing complete: Green
- Focusing failed: Red

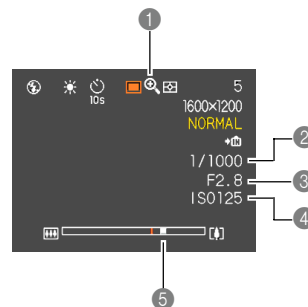

1 Digital zoom indicator (page 62)

2 Shutter speed value (page 56)

- An out of range aperture or shutter speed causes the corresponding monitor screen value to turn amber.

3 Aperture value (page 56)

4 ISO sensitivity (page 100)

5 Zoom indicator (page 62)

- Left side indicates optical zoom.
- Right side indicates digital zoom.

PLAY mode

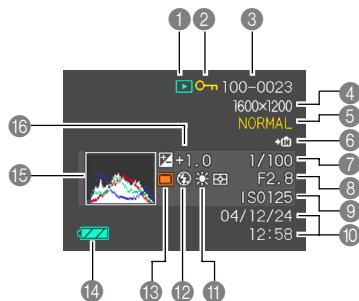

1 **PLAY mode file type**

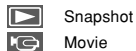

Snapshot
Movie

2 **Image protection indicator**
(page 127)

3 **Folder number/File number**
(page 126)

Example : When a file named
CIMG0023.JPG is stored in a folder
named 100CASIO

100-0023

Folder name File name

4 **Image size (page 70)**

2816 × 2112 pixels
2816 × 1872 (3:2) pixels
2048 × 1536 pixels
1600 × 1200 pixels
1280 × 960 pixels
640 × 480 pixels

Movie Playback: Elapsed play time

5 **Quality (page 71)**

FINE
NORMAL
ECONOMY

- 6 Built-in memory selected for data storage.
 Memory card selected for data storage.
(page 146)

7 **Shutter speed value (page 56)**

8 **Aperture value (page 56)**

9 **ISO sensitivity (page 100)**

10 **Date and time (page 137)**

11 **White balance indicator (page 80)**

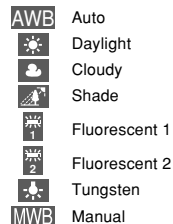

12 **Flash mode indicator (page 63)**

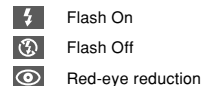

13 **REC modes (page 53)**

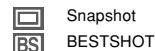

14 **Battery capacity (page 40)**

15 **Histogram (page 97)**

16 **EV value (page 79)**

Changing the Contents of the Monitor Screen

Each press of [DISP] changes the contents of the monitor screen as shown below.

■ REC mode

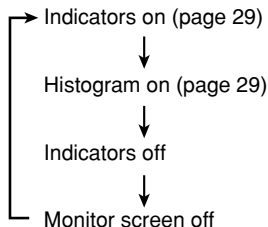

■ PLAY mode

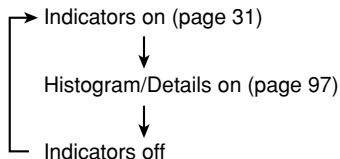

▶▶ IMPORTANT! ◀◀

- You cannot turn off the monitor screen in the following cases:
In the PLAY mode, in the BESTSHOT mode, when not recording in the Movie mode
- You cannot use [DISP] to change the contents of the monitor screen while a movie is being recorded.

Indicator Lamps

You can find out the operational status of the camera at a glance by checking the color of the indicator lamps, and whether a lamp is lit or flashing. For details, see “Indicator Lamp Reference” on page 196.

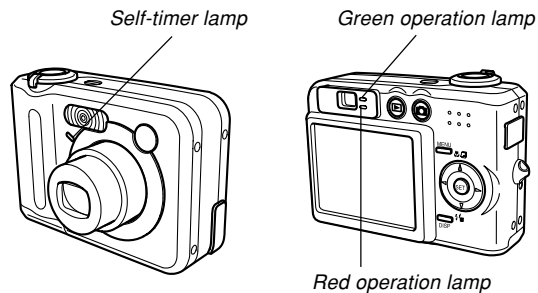

Attaching the Strap

Attach the strap to the strap ring as shown in the illustration.

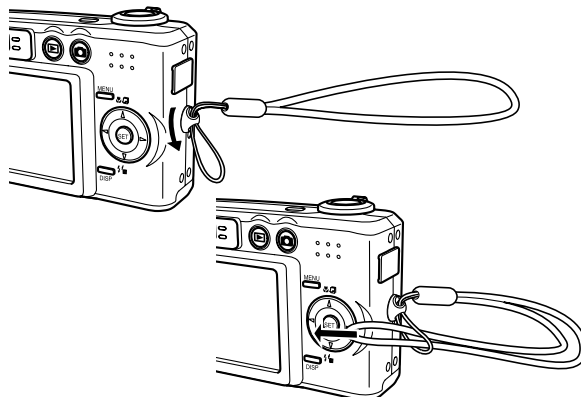

IMPORTANT!

- Be sure to keep the strap around your wrist when using the camera to protect against accidentally dropping it.
- The supplied strap is intended for use with this camera only. Do not use it for any other purpose.
- Never swing the camera around by the strap.

Power Requirements

Your camera features a two-way power supply that lets you use either AA-size batteries or household AC current. A set of AA-size rechargeable nickel-metal hydride batteries is supplied with the camera. The other items listed below are available separately.

■ Batteries

- Two AA-size rechargeable nickel-metal hydride batteries : HR-3U (Rated Capacitance 2100 mAh) (bundled)
HR-3U (Rated Capacitance 2300 mAh)
- Two AA-size lithium batteries: FR6
- Two AA-size alkaline batteries: LR6
- Proper operation cannot be guaranteed if you use any other type of battery other than that noted above.
- When being powered by AA-size alkaline batteries (LR6), the camera may not operate at all at temperatures of 5°C (41°F) or lower.

The batteries are not charged when you purchase the camera. You need to charge batteries before using the camera for the first time.

■ Household Current

- AC Adaptor: AD-C30

Charging Batteries

You can use the steps below to charge the rechargeable nickel-metal hydride batteries (HR-3U) using the charger unit (BC-5H) that comes with the camera.

Never try to use the charger unit to charge any other type of batteries besides the specified rechargeable nickel-metal hydride batteries (HR-3U). Attempting to use it to charge dry cells or other types of rechargeable batteries creates the risk of battery leakage, overheating, and explosion.

■ To charge the batteries

- 1. Positioning the positive and negative terminals of each battery as shown in the illustration, attach the batteries to the charger unit.**

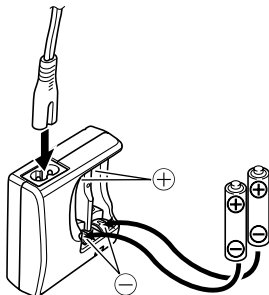

- 2. Plug the charger unit into a household power outlet.**

- This will cause the [CHARGE] lamp to light.
- Charging will take about four hours.
 - * Actual charging time depends on current battery capacity and charging conditions.

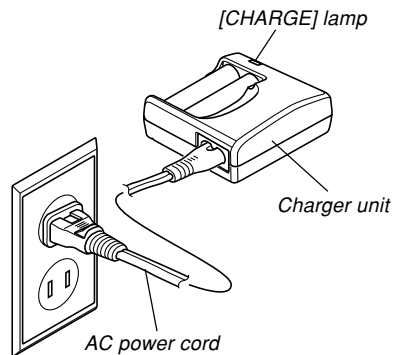

- 3. The [CHARGE] lamp will go out when charging is complete.**
- 4. After charging is complete, unplug the charger unit from the power outlet, and remove the batteries from it.**
 - Always unplug the charger unit from the power outlet and remove the batteries whenever you are not using it for charging.

»» IMPORTANT! ««

- If the [CHARGE] lamp starts to flash when you start a charge operation, it means that charging cannot be started yet because the surrounding temperature or the temperature of the charger unit is outside the range of about 0°C to 40°C (32°F to 104°F). Charging will start automatically (indicated when the [CHARGE] lamp stops flashing and remains lit) as soon as temperature returns to normal.
- Charging batteries while they are still warm immediately after removing them from the camera can result in only partial charging. Give batteries time to cool before charging them.
- Batteries discharge slightly even when they are left without loading them into the camera. Because of this, it is recommended that you charge batteries immediately before you need to use them.
- The batteries used with this camera are specifically designed for use with digital cameras. If you want to try to use them to power another type of device, you should first check the user documentation that comes with the device to see if the batteries are compatible.

GETTING READY

- Though the actual service life of the batteries depends on the environment under which they are used, you can expect to be able to recharge them about 500 times before they need replacement.
- Charging the batteries may cause interference with TV and radio reception. If this happens, plug the charger into an outlet that is further away from the TV or radio.
- Dirty charger contacts and/or battery terminals can make proper charging impossible. Be sure to wipe contacts and terminals occasionally with a dry cloth to keep them clean.

■ Using The Charger Unit In Another Geographic Area

- The bundled charger unit is designed for operation with any power supply in the range of 100V to 240V AC. Note, however, that the shape of the AC power cord plug varies according to country or geographic area. If you plan to use the charger unit in a geographic area where the power receptacle shape is different from that in your area, replace the AC power cord with one of the other ones that come with the camera, or purchase a commercially available AC power cord that is compatible with the power outlets in that area.

■ Charger Unit Precautions

- The charger unit becomes slightly warm during charging. This is normal and does not indicate malfunction.
- Unplug the charger unit from the power outlet whenever you are not using it.
- Always make sure that the charger unit is on a level surface when using it for charging.

■ Battery Precautions

Precautions During Use

- Charge the batteries in a location where the temperature is in the range of 10°C to 35°C (50°F to 95°F). Charging outside this temperature range can cause charging to take longer than normal or even cause charging to fail.
- Very limited operation following a full charge indicates that the batteries have reached the end of their service life. Replace the batteries with new ones.

Storage Precautions

- Though rechargeable nickel-metal hydride batteries provide high power in a compact configuration, storing them for long periods while they are charged can cause batteries to deteriorate.
 - Always remove the batteries from the camera when you are not using it. Leaving batteries in the camera can cause them to discharge and go dead or even leak.
 - Store batteries in a dry place where the temperature is 20°C (68°F) or lower.
 - If you store batteries for a long time, charge them two or three times before using them again.

■ Optional Batteries

Use of SANYO Electric Co., Ltd. Rechargeable nickel-metal hydride batteries (HR-3U) is recommended for this camera. Proper operation cannot be guaranteed when other brands of rechargeable batteries are used.

▶▶ IMPORTANT! ◀◀

- Never mix two batteries of different brands, ages, or charge levels. Doing so creates the risk of shortened battery life and can even damage the camera.

To load batteries

1. Turn off the camera.
2. Slide the battery compartment cover on the bottom of the camera in the direction indicated by the arrow and then swing it open.
3. Load batteries as shown in the illustration.
4. While pressing down at the point indicated by the arrow in the illustration, slide the battery compartment cover closed.

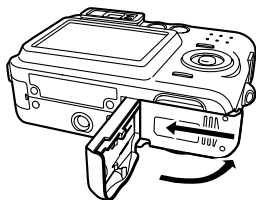
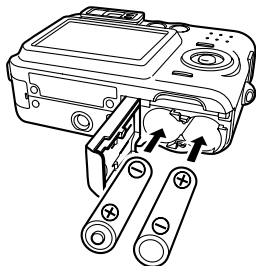
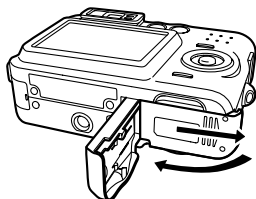

IMPORTANT!



- Use only the included rechargeable nickel-metal hydride batteries or the specified type of AA-size batteries.



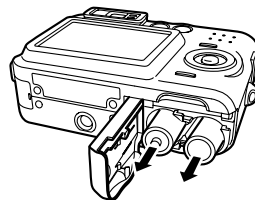
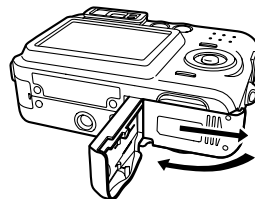

To remove the batteries from the camera

1. Slide the battery compartment cover on the bottom of the camera in the direction indicated by the arrow and then swing it open.
2. Carefully tilt the camera until the batteries slide out.
 - Take care to avoid dropping the batteries.



■ Low Battery Indicator

The following shows how the battery capacity indicator on the monitor screen changes as battery power is used. The  indicator means that remaining battery power is low. Note that you will not be able to record images while the battery indicator is . Immediately replace or charge the batteries whenever either of these indicators appears.

Charge Level	High ←————→ Low
Indicator	 →  →  → 

■ Battery Life Guidelines

The battery life guideline values given below indicate the approximate amount of time under the conditions defined below the table, until power automatically turns off due to battery failure. They do not guarantee that the batteries will provide the amount of service indicated. Low temperatures and continued use reduce battery life.

Operation	Rechargeable Nickel-Metal Hydride batteries	Alkaline batteries
Number of Shots (CIPA Standard)* ¹ (Operating Time)	280 shots (140minutes)	50 shots (25 minutes)
Number of Shots, Continuous Recording* ² (Operating Time)	900 shots (150 minutes)	245 shots (40 minutes)
Continuous Snapshot Playback* ³	260 minutes	150 minutes

- The above approximate guidelines are based on the following battery types:

Rechargeable Nickel-Metal Hydride

:HR-3U (Rated Capacitance 2100 mAh)

SANYO Electric Co., Ltd.

Alkaline :LR6 Matsushita Battery Industrial Co., Ltd.

* Battery life varies with brand.

- Storage Medium: SD Memory Card

GETTING READY

*1 Number of Shots (CIPA Standard)

- Temperature: 23°C (73°F)
- Monitor Screen: On
- Zoom operation between full wide to full telephoto every 30 seconds, during which two images are recorded, one image with flash; power turned off and back on every time 10 images are recorded.

*2 Continuous Recording Conditions

- Temperature: 23°C (73°F)
- Monitor screen: On
- Flash: Off
- Image recorded every 10 seconds, alternating full wide-angle and full telephoto zoom

*3 Continuous Snapshot Playback Conditions

- Temperature: 23°C (73°F)
- Scroll one image about every 10 seconds

- The above values are based on new batteries starting from a full charge. Repeated charging shortens battery life.
- Battery life is greatly affected by how much you use flash, zoom and other functions, and how long you leave power turned on.

■ Tips to Make the Batteries Last Longer

- If you do not need the flash while recording, select  (flash off) for the flash mode (page 63).
- Enable the Auto Power Off and the Sleep features (page 46) to protect against wasting battery power when you forget to turn off the camera.
- You can also conserve battery power by using [DISP] to turn off the monitor screen.

■ Alkaline Battery Life

The actual life of alkaline batteries is affected by a variety of factors, including the battery manufacturer, the amount of time the batteries spend in storage before you use them, temperature while you are recording, and photographic conditions. As a rule, we recommend the use of rechargeable nickel-metal hydride batteries, which have longer lives than alkaline batteries.

- Certain conditions, especially at cold temperatures below about 5°C (41°F), can cause the message “Battery is low.” to appear when you turn on the camera.
- The PLAY mode requires less power than the REC mode. If you experience a problem turning on the camera in the REC mode, try switching to the PLAY mode.

■ Battery Handling Precautions

Misuse of batteries can cause them to leak or explode, which damages and corrodes the area around the batteries and creates the risk of fire and personal injury. Make sure you observe the following precautions when using batteries.

- When loading batteries, make sure their positive (+) and negative (–) ends are facing correctly.
- Never mix new batteries with old ones.
- Never mix batteries of different brands.
- Use only the batteries that are specified for this camera.
- Never try to take batteries apart and always take care to avoid conditions where their two ends can become connected to each other (shorting). Never expose batteries to heat or throw them into fire.
- Dead batteries are susceptible to leakage, which can cause serious damage to your camera. Remove batteries from the camera as soon as you notice they are dead.
- Remove batteries from the camera if you do not plan to use it for more than two weeks.
- The batteries that power the camera normally become warm as you use them.

Using AC Power

You need to purchase the optionally available AC adaptor (AD-C30) in order to be able to power the camera using AC power.

1. Connect the AC power cord to the AC adaptor.
2. Open the camera's terminal cover and connect the AC adaptor to the port marked [DC IN 3V].

3. Plug the AC power cord into an electrical outlet.

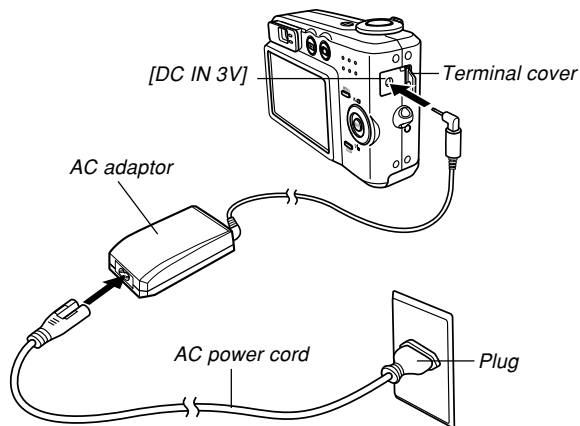

■ Using AC Adaptor In Another Geographic Area

- The AC adaptor can be used with any power source rated from 100V to 240V AC. If you plan to use the AC adaptor in another country, it is up to you to purchase the applicable AC power cord that matches the configuration of power receptacles in that country.

■ AC Adaptor Precautions

- Be sure to turn off power before connecting or disconnecting the AC adaptor.
- Always turn camera power off before disconnecting the AC adaptor, even if the camera has batteries installed. If you don't, the camera will turn off automatically when you disconnect the AC adaptor. You also run the risk of damaging the camera whenever you disconnect the AC adaptor without first turning power off.
- The AC adaptor may become warm to touch after extended periods of use. This is normal and is not cause for alarm.
- After using the camera, turn it off and unplug the AC adaptor from the AC outlet.
- The camera automatically switches over to AC adaptor powered operation whenever the AC adaptor is plugged into the camera.
- Always use the AC adaptor to power the camera whenever it is connected to a computer.
- Never place a blanket or any other cover on the AC adaptor. Doing so creates the risk of fire.

Turning the Camera On and Off

■ To turn on the camera

Press the power button, [📷] (REC), or [▶] (PLAY). This will cause the green operation lamp to light momentarily, and then power will turn on. The mode the camera enters depends on which button you pressed to turn it on.

To enter this mode at startup:	Press this button to turn on the camera:
REC	Power button or [📷] (REC)
PLAY	[▶] (PLAY)

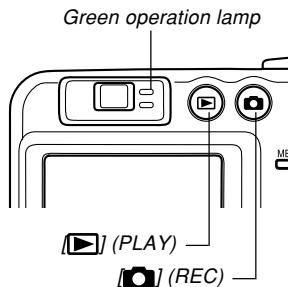
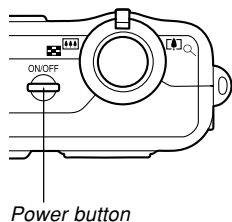

▶▶ NOTE ◀◀

- Pressing [📷] (REC) to turn on the camera enters the REC mode, while pressing [▶] (PLAY) enters the PLAY mode.
- Pressing [▶] (PLAY) while in the REC mode switches to the PLAY mode. The lens retracts about 10 seconds after switching modes.

▶▶ IMPORTANT! ◀◀

- If camera power is turned off by the Auto Power Off feature, press the power button, [📷] (REC) or [▶] (PLAY) to turn it back on again.
- Pressing the power button or [📷] (REC) to turn on the camera also causes the lens to extend. Take care to any interference with the lens operation or allowing anything to strike the lens when it is extended.

■ To turn off the camera

Press the power button to turn off the camera.

»» NOTE ««

- You can setup the camera so it does not turn on when you press [RECORD] (REC) or [PLAY] (PLAY), or to turn off when you press [RECORD] (REC) or [PLAY] (PLAY). For details, see "Configuring [RECORD] (REC) and [PLAY] (PLAY) Power On/Off Functions" on page 144.

Configuring Power Saving Settings

You can configure the settings described below to conserve battery power.

- Sleep** : Automatically turns off the monitor screen if no operation is performed for a specified amount of time in the REC mode. Performing any button operation causes the monitor screen to turn back on.
- Auto Power Off** : Turns off power if you do not perform any operation for a specified amount of time.

1. Turn on the camera.
2. Press [MENU].
3. Use [LEFT] and [RIGHT] to select the "Set Up" tab.
4. Use [UP] and [DOWN] to select the feature whose setting you want to configure, and then press [RIGHT].

GETTING READY

- See “Using the On-screen Menus” below for information about how to use menus.

To configure this feature:	Select this setting:
Sleep	Sleep
Auto Power Off	Auto Power Off

5. Use [▲] and [▼] to change the currently selected setting, and then press [SET].

- Available Sleep settings are: “30 sec”, “1 min”, “2 min”, and “Off”.
- Available Auto Power Off settings are: “2 min” and “5 min”.
- Note that the Sleep feature does not operate in the PLAY mode.
- Pressing any button while the camera is in the Sleep state immediately turns the monitor screen back on.
- The Auto Power Off and Sleep features are disabled in the following cases.
 - When the camera is connected to a computer through the USB cable
 - While playing back a movie

Using the On-screen Menus

Pressing [MENU] displays menus on the monitor screen that you can use to perform various operations. The menu that appears depends on whether you are in the REC mode or the PLAY mode. The following shows an example menu procedure in the REC mode.

1. Press the power button or [CAM] (REC).

- If you want to enter the PLAY mode instead, press [▶] (PLAY).

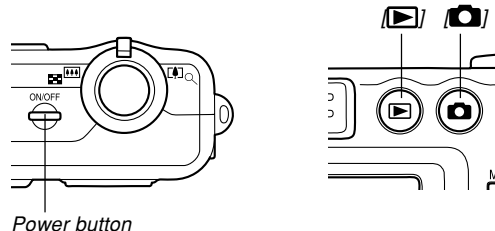

2. Press [MENU].

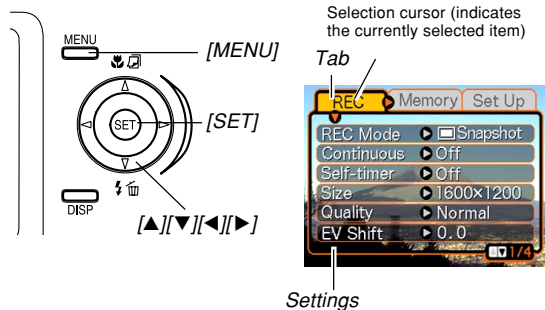

● Menu Screen Operations

When you want to do this:	Do this:
Move between tabs	Press [◀] and [▶].
Move from the tab to the settings	Press [▼].
Move from the settings to the tab	Press [▲].
Move between the settings	Press [▲] and [▼].
Display the options available for a setting	Press [▶] or press [SET].
Select an option	Press [▲] and [▼].
Apply the setting and exit the menu screen	Press [SET].
Apply the setting and return to tab selection	Press [◀].
Exit the menu screen	Press [MENU].

GETTING READY

3. Press [◀] or [▶] to select the tab you want, and then press [SET] to move the selection cursor from the tab to the settings.

4. Use [▲] and [▼] to select the feature whose setting you want to configure, and then press [▶].

- Instead of pressing [▶], you could also press [SET].



Example: To select the "REC Mode" item.

5. Use [▲] and [▼] to change the currently selected setting.

6. Perform one of the following operations to apply the setting you configured.

To do this:	Perform this key operation:
Apply the setting and exit the menu screen.	Press [SET].
Apply the setting and return to feature selection in step 4.	Press [◀].
Apply the setting and return to tab selection in step 3.	1. Press [◀]. 2. Use [▲] to move back up to tab selection.

- See "Menu Reference" on page 194 for more information about menus.

Configuring Display Language and Clock Settings

Be sure to configure the following settings before using the camera to record images.

- Display language
- Home city
- Date style
- Date and time

Note that the current date and time settings are used by the camera to generate the date and time that are stored along with image data, etc.

»» IMPORTANT! ««

- Recording images without configuring the clock settings causes incorrect time information to be stored with image data. Be sure to configure the clock settings before using the camera.
- A built-in backup battery retains the date and time settings for about two days if the camera is not supplied with power. The date and time settings will be cleared when the backup battery goes dead. The following are the conditions when power is not being supplied to the camera.
 - When the rechargeable batteries are dead or removed from the camera
 - Disconnecting the AC adaptor while it is being used to power the camera (without batteries loaded)
- The date and time setting screen will appear on the monitor screen the next time you turn on the camera after the date and time settings have been cleared. If this happens, reconfigure the date and time settings.
- If you make a mistake when setting the language or clock with the following procedure, you will need to use the camera's menu to individually change the language (page 142) or clock (page 137) settings.

To configure display language and clock settings

1. Press the power button, [CAM] (REC) or [PLAY] (PLAY) to turn on the camera.

2. Use [▲], [▼], [◀], and [▶] to select the language you want, and then press [SET].



- 日本語 : Japanese
 English : English
 Français : French
 Deutsch : German
 Español : Spanish
 Italiano : Italian
 Português : Portuguese
 中國語 : Chinese (Complex)
 中国語 : Chinese (Simplified)
 한국어 : Korean

3. Use [▲], [▼], [◀], and [▶] to select the geographical area where you live, and then press [SET].



4. Use [▲] and [▼] to select the name of the city where you live, and then press [SET].



5. Use [▲] and [▼] to select the summer time (DST) setting you want, and then press [SET].

When you want to do this:	Select this setting:
Keep time using summer time (Daylight Saving Time)	On
Keep time using standard time	Off

GETTING READY

6. Use [▲] and [▼] to select the date format setting you want, and then press [SET].



Example: December 24, 2004

To display the date like this:	Select this format:
04/12/24	YY/MM/DD
24/12/04	DD/MM/YY
12/24/04	MM/DD/YY

7. Set the current date and the time.

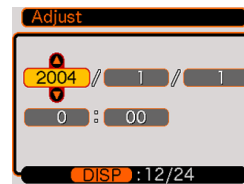

To do this:	Do this:
Change the setting at the current cursor location	Press [▲] and [▼].
Move the cursor between settings	Press [◀] and [▶].
Toggle between 12-hour and 24-hour timekeeping	Press [DISP].

8. Press [SET] to register the settings and exit the setting screen.



BASIC IMAGE RECORDING







This section describes the basic procedure for recording an image.

Recording an Image



Specifying the Recording Mode

Your CASIO digital camera has three recording modes, each of which is described below. Before recording an image, use the procedure below to select the applicable recording mode.

-  (Snapshot mode)
Use this mode to record still images. This is the mode you should normally use for image recording.
-  (BESTSHOT mode)
This mode makes camera setup as easy as selecting the applicable sample scene. Simply select one of 23 sample scenes, and the camera will automatically be configured with the settings required to record a similar image (page 84).
-  (Movie mode)
Use this mode to record movies (page 95).

1. Press the power button or  (REC).
2. Press [MENU], and use [] and [] to select the “REC” tab.
3. Use [] and [] to select “REC Mode”, and then press [].



4. Use [] and [] to select the recording mode you want, and then press [SET].

- The icon (like ) for the mode you select is displayed on the monitor screen.

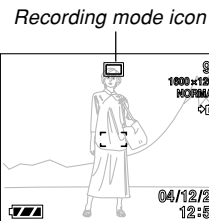

Aiming the Camera

Use both hands to hold the camera still when shooting an image. Holding the camera with one hand increases the chance of movement, which can blur your images.

- Horizontal

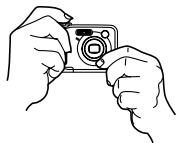

Hold the camera still in both hands, with your arms firmly against your sides.

- Vertical

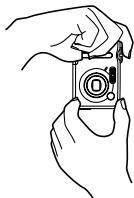

When holding the camera vertically, make sure that the flash is above the lens. Hold the camera still with both hands.

►► IMPORTANT! ◀◀

- Make sure your fingers and the strap do not block the flash or lens.

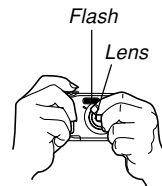

►► NOTE ◀◀

- Your image will be blurred if you move the camera when pressing the shutter button. Press the shutter button carefully, taking care to avoid camera movement. This is especially important when available lighting is low, which slows down the shutter speed.

Recording an Image

Your camera automatically adjusts shutter speed in accordance with the brightness of the subject. Images you record are stored in the camera's built-in memory, or to a memory card if you have one loaded in the camera.

- When an optionally available SD memory card or MultiMediaCard (MMC) is loaded in the camera, images are stored on the card (page 146).

1. Press the power button or [CAMERA] (REC) to turn on the camera.

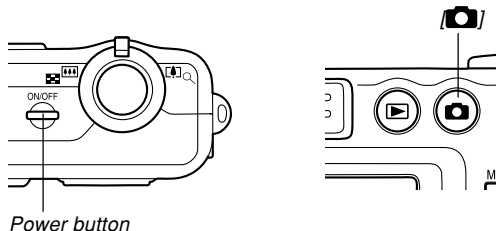

- This causes an image or a message to appear on the monitor screen.
- This enters the REC mode for image recording.
- If the camera is in the PLAY mode when it turns on, the message "There are no files" will appear if you do not have any images stored in memory yet. In addition, the [PLAY] icon will be visible at the top of the display. If this happens, press [CAMERA] (REC) to enter the REC mode.

2. Select "[CAMERA] Snapshot" as the recording mode (page 53).

- This enters the Snapshot Mode and causes "[CAMERA]" (Snapshot mode) to appear on the monitor screen.
- You can use the key customization feature (page 106) to configure the camera to enter the Snapshot mode whenever you press [◀] or [▶] while in the REC mode.

3. Compose the image on the monitor screen so the main subject is within the focus frame.

- The focusing range of the camera depends on focus mode you are using (page 72).
- You can compose images using either the monitor screen or the optical viewfinder (page 59).
- When using the optical viewfinder to compose images, you can use [DISP] to turn off the monitor screen and conserve battery power (page 32).

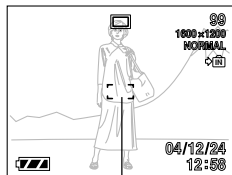

Focus frame

4. Press the shutter button half way to focus the image.

- When you press the shutter button half way, the camera's Auto Focus feature automatically focuses the image, and displays the shutter speed and aperture values.
- You can tell whether the image is focused by observing the focus frame and the green operation lamp.

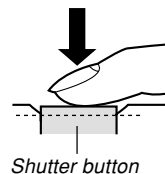

Green operation lamp

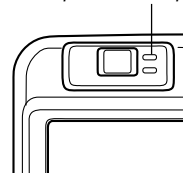

● Operation Lamp and Focus Frame Operation

When you see this:	It means this:
Green focus frame Green operation lamp	The image is in focus.
Red focus frame Flashing green operation lamp	The image is not in focus.

5. After making sure that the image is focused properly, press the shutter button the rest of the way down to record.

- The number of images that can be stored in memory depends on the resolution setting you are using (pages 70, 71, 206).

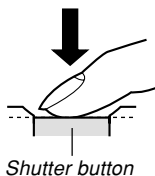

Recording Precautions

- Never open the battery compartment cover while the green operation lamp is flashing. Doing so not only causes the current image to be lost, it can also corrupt images already stored in file memory and even lead to malfunction of the camera.
- Never remove the memory card while an image is being stored to the memory card.
- Fluorescent lighting actually flickers at a frequency that cannot be detected by the human eye. When using the camera indoors under such lighting, you may experience some brightness or color problems with recorded images.
- When "Auto" is selected for the ISO sensitivity setting (page 100), the camera automatically adjusts its sensitivity in accordance with the brightness of the subject. This can cause some static noise to appear in images of relatively dark subjects.

BASIC IMAGE RECORDING

- When recording a dimly lit subject while “Auto” is selected for the ISO sensitivity setting (page 100), the camera increases sensitivity and uses a slower shutter speed. Because of this, you need to guard against camera movement if you have flash turned off (page 63).
- Bright light shining on the lens can cause images to appear “washed out”. This tends to happen when recording images outdoors in bright sunlight. To protect against this, use your free hand to shade the lens from the light.

About Auto Focus

- Auto Focus tends not to work well if the camera is moved during recording, or when recording the types of subjects listed below.
 - Solid color walls or subjects with little contrast
 - Strongly backlit subjects
 - Polished metal or other brightly reflective subjects
 - Venetian blinds or other horizontally repeating patterns
 - Multiple subjects that are varying distances from the camera
 - Subjects in poorly lit areas
 - Moving subjects
- Note that a green operation lamp and focus frame do not necessarily guarantee that the resulting image will be in focus.
- If Auto Focus does not produce the results you want for some reason, try using focus lock (page 78) or manual focus (page 76).

About the REC Mode Monitor Screen

- The image shown on the monitor screen in the REC mode is a simplified image for composing purposes. The actual image is recorded in accordance with the image quality setting currently selected on your camera. The image saved in file memory has much better resolution and detail than the REC mode monitor screen image.
- Certain levels of subject brightness can cause the response of the REC mode monitor screen to slow down, which causes some static noise in the monitor screen image.
- Very bright light inside of an image can cause a vertical band to appear in the monitor screen image. This is a CCD phenomenon known as “vertical smear”, and does not indicate malfunction of the camera. Note that vertical smear is not recorded with the image in the case of a snapshot, but it is recorded in the case of a movie (page 95).

Using the Optical Viewfinder

You can conserve battery power by turning off the camera's monitor screen (page 32) and using the optical viewfinder to compose images.

▶▶ IMPORTANT! ◀◀

- The visible area framed by the viewfinder shows the image that would be recorded at a distance of about one meter (3.3'). When recording a subject that is closer to you than one meter, the recorded image will be lower than what you can see inside the viewfinder area.

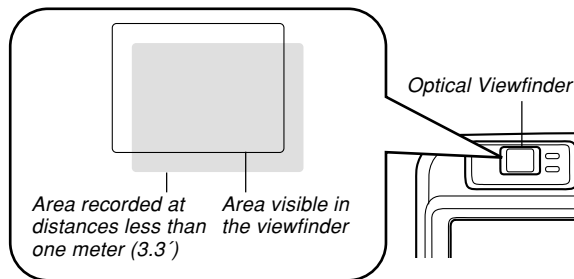

BASIC IMAGE RECORDING

- The monitor screen turns on automatically whenever you select the Macro mode or Manual Focus mode. Always use the monitor screen to compose images in these modes.

Using Zoom

Your camera is equipped with two types of zoom: optical zoom and digital zoom.



Optical Zoom

The range of the optical zoom factor is shown below.

Optical Zoom Factor Range: 1X to 3X

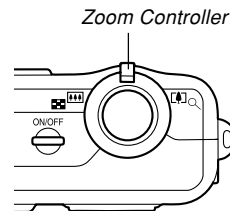
- 1. In the REC mode, slide the zoom controller left or right to change the zoom factor.**



To do this:	Slide the zoom controller in this direction:
Zoom out	 (Wide Angle)
Zoom in	 (Telephoto)

BASIC IMAGE RECORDING

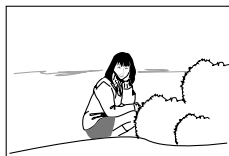

Zoom out



Zoom in

2. Record the image.

NOTE

- The optical zoom factor also affects the lens aperture.
- Use of a tripod is recommended to protect against hand movement when using the telephoto setting (zoom in).
- Optical zoom is disabled during movie recording, but digital zoom is enabled. Make sure you select the optical zoom setting you want to use before you press the shutter button to start movie recording.
- Whenever you perform an optical zoom operation while recording with the Macro mode (page 75) or manual focus (page 76), a value will appear on the monitor screen to tell you the focusing range.

Digital Zoom

Digital zoom is activated after you reach the maximum optical zoom factor (3X). It enlarges the part of the image at the center of the image screen. The range of the digital zoom factor is shown below.

Digital Zoom Factor Range: 3X to 12X
(in combination with optical zoom)

1. In the REC mode, press [MENU].
2. Use [◀] and [▶] to select the “REC” tab.
3. Use [▲] and [▼] to select “Digital Zoom”, and then press [▶].
4. Use [▲] and [▼] to select “On”, and then press [SET].
 - Selecting “Off” disables digital zoom.

5. Slide the zoom controller towards [▲] (Telephoto)/ [Q] side to change the zoom factor.

- When zoom reaches maximum optical zoom, it stops momentarily. Keep the zoom controller pressed to the [▲] (Telephoto)/ [Q] side and zoom will switch over to digital zoom.
- Switching to digital zoom causes the zoom indicator to appear on the monitor screen. The zoom indicator shows the current approximate zoom factor.

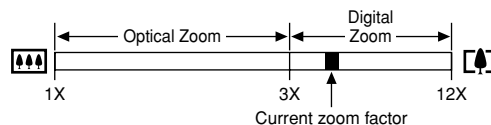

6. Record the image.

►► IMPORTANT! ◀◀

- Digital zoom is disabled whenever the monitor screen is turned off (page 32).
- When you perform a digital zoom operation, the camera manipulates the image data to enlarge the center of the image. Unlike optical zoom, an image enlarged with digital zoom appears coarser than the original.

Using the Flash

Perform the following steps to select the flash mode you want to use.

- The approximate effective range of the flash is shown below.

Wide Angle : Approximately 0.6 meters to 2.6 meters
(2.0' to 8.5')(ISO Sensitivity: Auto)

Telephoto : Approximately 0.6 meters to 2.1 meters
(2.0' to 6.9')(ISO Sensitivity: Auto)

1. In the REC mode, press [MENU].

2. Press [▼] (⚡ 🗑️) to select the flash mode.

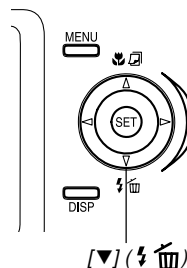

- Each press of [▼] (⚡ 🗑️) cycles through the flash mode settings described below on the monitor screen.

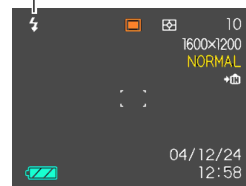

Flash mode indicator



BASIC IMAGE RECORDING

To do this:	Select this setting:
Have the flash fire automatically when required (Auto Flash)	None
Turn off the flash (Flash Off)	
Always fire the flash (Flash On)	
Fire a pre-flash followed by image recording with flash, reducing the chance of red-eye in the image (Red-eye reduction) In this case, the flash fires automatically when required	

3. Record the image.

▶▶ IMPORTANT! ◀◀

- The flash unit of this camera fires a number of times when you record an image. The initial flashes are pre-flashes, which the camera uses to obtain information that it uses for exposure settings. The final flash is for recording. Make sure that you keep the camera still until the shutter releases.
- Image recording may not be performed if you press the shutter button while the flash is charging (which is indicated by a flashing red operation lamp).
- Using the flash while "Auto" is selected for the ISO Sensitivity setting increases sensitivity, which can cause large amounts of digital noise to appear in the image. You can reduce digital noise by using a lower ISO Sensitivity setting. Note, however, that this also has the effect of shortening the flash range (the range that is covered by the light from the flash)(page 100).

■ About Red-eye Reduction

Using the flash to record at night or in a dimly lit room can cause red spots inside the eyes of people who are in the image. This happens because the light from the flash reflects off of the retina of the eye. When red-eye reduction is selected as the flash mode, the camera performs two pre-flash operations, one designed to cause the irises in the eyes of any people in the image to close, and one for the Auto Focus operation. This is followed by another flash operation for actual recording of the image.

▶▶ IMPORTANT! ◀◀

- Note the following important points when using red-eye reduction.
 - Red-eye reduction does not work unless the people in the image are looking directly at the camera during the pre-flash. Before pressing the shutter button, call out to the subjects so they all look at the camera while the pre-flash operation is performed.
 - Red-eye reduction may not work very well if the subjects are located far away from the camera.

Flash Unit Status

You can find out the current flash unit status by pressing the shutter button half way and checking the monitor screen and red operation lamp.

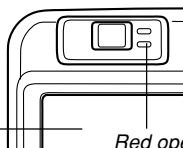

The  indicator is also shown on the monitor screen when the flash unit is ready to fire.

Red operation lamp*

* Red operation lamp

When the red operation lamp is this:	It means this:
Flashing	Flash unit is charging
Lit	Flash unit is ready to fire

Changing the Flash Intensity Setting

Perform the following steps to change the flash intensity setting.

1. In the REC mode, press [MENU].
2. Use [◀] and [▶] to select the “REC” tab.
3. Use [▲] and [▼] to select “Flash Intensity”, and then press [▶].
4. Use [▲] and [▼] to select the setting you want, and then press [SET].

To make flash intensity:	Select this setting:
Stronger	+2
↑	+1
Normal	0
↓	-1
Weaker	-2

▶▶ IMPORTANT! ◀◀

- Flash intensity may not change if the subject is too far or too close to the camera.

Using Flash Assist

Recording a subject that is outside the flash range can cause the subject to appear dark in the resulting image, because not enough of the flash reaches the subject. When this happens, you can use flash assist to correct the brightness of the recorded subject, so it appears as if the flash illumination was sufficient.



Flash assist used



Flash assist not used

1. In a REC mode, press [MENU].
2. Use [◀] and [▶] to select the “REC” tab.
3. Use [▲] and [▼] to select “Flash Assist”, and then press [▶].

4. Use [▲] and [▼] to select “Auto”, and then press [SET].

- Selecting “Off” disables flash assist.



▶▶ IMPORTANT! ◀◀

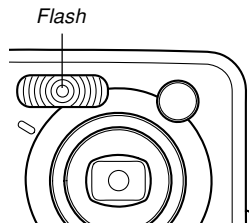

- Flash assist may not produce the desired result for some types of subjects.
- Flash assist may have little effect on your image if you changed any of the following settings when you recorded it.
 - Flash intensity (page 65)
 - Exposure compensation (EV shift) (page 79)
 - ISO sensitivity (page 100)
 - Contrast (page 104)

Flash Precautions

- Take care that your fingers do not block the flash when you hold the camera. Covering the flash with your finger can greatly reduce its effectiveness.



- You may not be able to achieve the desired results using a flash if the subject is too close or too far away.
- The flash takes anywhere from a few seconds to as long as 10 seconds to attain full charge after being fired. The actual time required depends on the battery level, temperature, and other conditions.
- The flash does not fire when recording using the following modes and functions: infinity (∞) focus mode (page 76), continuous shutter (page 83), Movie mode (page 95). The  (Flash Off) icon on the monitor screen indicates that the flash is turned off.
- The flash unit may not be able to charge when battery power is low. Low battery power is indicated by  (Flash Off) on the monitor screen, and when the flash fails to fire properly resulting in poor image exposure. When these symptoms occur, charge the camera's batteries as soon as possible.

- When the flash is turned off () , mount the camera on a tripod to record images in an area where available lighting is dim. Recording images under dim lighting without the flash can cause digital noise, which makes images appear coarse.
- When the red-eye reduction mode () is selected, flash intensity is adjusted automatically in accordance with the exposure. The flash may not fire at all when the subject is brightly lit.
- Using flash in combination with another light source (daylight, fluorescent light, etc.) can result in abnormal image colors.
- Use of the flash along with wide angle zoom (page 60) or the Macro mode (page 75) can cause the light of the flash to become blocked, which can produce unwanted shadows in your image. Shadows may be particularly noticeable when using the flash with the Macro mode.

Using the Self-timer

The self-timer lets you select either a 2-second or 10-second delay of the shutter release after you press the shutter button. A Triple Self-timer feature lets you perform three consecutive self-timer operations to record three images.

1. In the REC mode, press [MENU].
2. Use [◀] and [▶] to select the “REC” tab.
3. Use [▲] and [▼] to select “Self-timer”, and then press [▶].
4. Use [▲] and [▼] to select the self-timer time you want to use, and then press [SET].
 - Selecting “Off” in step 4 disables the self-timer.

To do this:	Select this setting:
Specify a 10-second self-timer	10 sec
Specify a 2-second self-timer	2 sec
Specify Triple Self-timer	X3
Disable the self-timer	Off

- With the Triple Self-timer, the camera records a series of three images in the sequence described below.
 1. The camera performs a 10-second countdown and then records the first image.
 2. The camera prepares to record the next image. The amount of time required for preparation depends on the camera’s current “Size” and “Quality” settings, the type of memory (built-in or card) you are using for image storage, and whether or not the flash is charging.
 3. After preparation is complete, the indicator “1sec” appears on the monitor screen, and another image is recorded one second later.
 4. Steps 2 and 3 are repeated once more to record the third image.

5. Record the image.

- When you press the shutter button, the self-timer lamp flashes as the countdown progresses, and then the shutter releases after the self-timer reaches the end of its countdown.
- You can interrupt an ongoing self-timer countdown by pressing the shutter button while the self-timer lamp is flashing.

Self-timer lamp

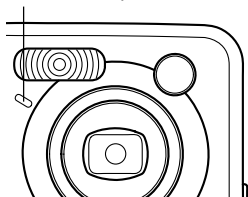

NOTE

- The “2 sec” self-timer setting is best when shooting with a slow shutter speed, because it helps to avoid blurring of images due to hand movement.
- In the case of the Triple Self-timer, the indicator “1sec” appears on the monitor screen between the recording of each image, indicating an interval of about one second between image recording. The actual amount of time required between images depends on the camera’s current “Size” and “Quality” settings, as well as the type of memory being used and whether or not the flash is being used.
- The functions below are not available for use in combination with the Triple Self-timer.
Coupling Shot (page 89), Pre-shot (page 91),
Business Shot (page 93)

Specifying Image Size

“Image size” is the size of the image, expressed as the number of vertical and horizontal pixels. A “pixel” is one of the many tiny dots that make up the image. More pixels provide finer detail when an image is printed, but a higher pixel count also causes the image’s file size to be larger. You can select an image size to suit your needs for greater detail or smaller file size.

1. In the REC mode, press [MENU].
2. Use [◀] and [▶] to select the “REC” tab.
3. Use [▲] and [▼] to select “Size”, and then press [▶].
4. Use [▲] and [▼] to select the image size (in pixels) you want, and then press [SET].
 - When selecting the image size, the image size value (pixels) will alternate on the display with a corresponding print size. The print size indicates the optimum paper size when you print an image that is the image size you select.

Image Size	Print Size	
2816 × 2112	A3 Print	Larger ↑ ↓ Smaller
2816 × 1872 (3:2)	A3 Print (3:2 horizontal-to-vertical ratio)	
2048 × 1536	A4 Print	
1600 × 1200	5" × 7" Print	
1280 × 960	3.5" × 5" Print	
640 × 480	E-mail (optimum size when attaching image to e-mail)	

- Indicated sizes are rough approximates only.
- The above print sizes are all approximate values when printing at a resolution of 200 dpi (dots per inch). Use a larger setting when you want to print at a higher resolution or when you plan to produce a larger size print.
- Selecting the “2816 × 1872 (3:2)” image size will record images with a 3:2 (horizontal : vertical) aspect ratio, which is optimal for printing on paper with an aspect ratio of 3:2.

Specifying Image Quality

Compressing an image before storage can cause a deterioration of its quality. The more an image is compressed, the greater the loss of quality. The image quality setting specifies the compression ratio to be used when an image is stored in memory. You can select an image quality setting to suit your needs for higher quality or smaller file size.

1. In the REC mode, press [MENU].
2. Use [◀] and [▶] to select the “REC” tab.
3. Use [▲] and [▼] to select “Quality”, and then press [▶].
4. Use [▲] and [▼] to select the setting you want, and then press [SET].

To get this:	Select this setting:	
High image quality, large file size	Fine	Higher Quality
Normal image quality and normal file size	Normal	↕
Low image quality, small file size	Economy	Lower Quality

►► IMPORTANT! ◀◀

- Actual file size depends on the type of image you record. This means that the remaining image capacity noted on the monitor screen may not be exactly accurate (pages 29, 206).

OTHER RECORDING FUNCTIONS

This section describes other powerful features and functions that are available for recording.

Selecting the Focus Mode

You can select one of four different focus modes: Auto Focus, Macro, Infinity, and Manual.

1. In the REC mode, press [▲] (👁️ 📷).

- Each press of [▲] (👁️ 📷) cycles through the focus mode settings shown below on the monitor screen.

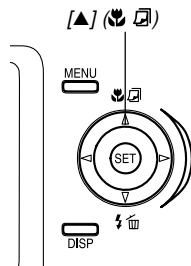

Focus mode indicator

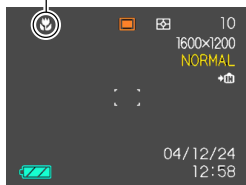

To set up the camera to do this:	Select this setting:
Focus automatically (Auto Focus)	None
Perform close-up focus (Macro)	
Perform infinity focus (Infinity)	
Focus manually (Manual Focus)	MF

Using Auto Focus

As its name suggests, Auto Focus focuses the image automatically. The automatic focus operation starts when you press the shutter button down half way. The following is the Auto Focus range.

Range: Approximately 60cm to ∞ (23.6" to ∞)

1. Keep pressing [▲] (👉 📷) until there is no focus mode indicator on the display.

2. Compose the image so the main subject is within the focus frame, and then press the shutter button half way.

- You can tell whether the image is focused by observing the focus frame and the green operation lamp.

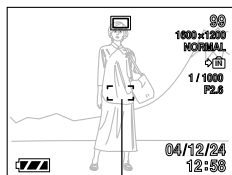

Focus frame

Green operation lamp

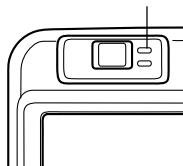

When you see this:	It means this:
Green focus frame Green operation lamp	The image is focused.
Red focus frame Flashing green operation lamp	The image is not focused.

3. Press the shutter button the rest of the way to record the image.

NOTE

- When proper focusing is not possible because the subject is closer than the Auto Focus range, the camera automatically switches to the Macro mode range (page 75).

OTHER RECORDING FUNCTIONS

■ Specifying the Auto Focus Area

You can use the following procedure to change the Auto Focus area used in the Auto Focus mode and the Macro mode. Note that the configuration of the focus frame changes in accordance with the Auto Focus area you select.

1. In the REC mode, press [MENU].
2. On the “REC” tab, select “AF Area”, and then press [▶].

3. Use [▲] and [▼] to select the Auto Focus area you want, and then press [SET].

For this type of Auto Focus area:	Select this:
Very limited range in the center of the screen • This setting works well with focus lock (page 78).	Spot
Automatic selection of the focus area where the subject closest to the camera is located • With this setting, a wide focus frame, which contains seven focus points, appears on the monitor screen first. When you press the shutter button half way, the camera automatically selects the focus point where the subject closest to the camera is located, and a focus frame appears at that point. • This setting works well for group photos.	Multi

• Spot

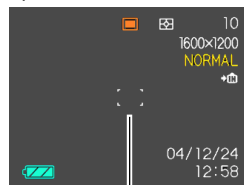

Focus frame

• Multi

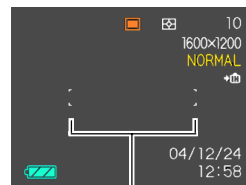

Focus frame

Using the Macro Mode

The Macro mode lets you focus on close up subjects automatically. The automatic focus operation starts when you press the shutter button down half way. The following are the approximate focus ranges in the Macro mode.

Ranges: 10cm to 70cm (3.9" to 27.6") at wide angle
60cm to 70cm (23.6" to 27.6") at telephoto

1. Keep pressing [▲] (👉📷) until the focus mode indicator shows "👉📷".

2. Record the image.

- The focus and image recording operations are identical to those in the Auto Focus mode.
- You can tell whether the image is focused by observing the focus frame and the green operation lamp. The indications of the focus frame and green operation lamp are the same as those in the Auto Focus mode.

▶▶ IMPORTANT! ◀◀

- Use of the flash along with wide angle zoom or the Macro mode can cause the light of the flash to become blocked, which can produce unwanted shadows in your image.

▶▶ NOTE ◀◀

- When the Macro mode cannot focus properly because the subject is too far away, the camera automatically switches to the Auto Focus range (page 73).
- Whenever you perform an optical zoom operation (page 60) while recording with the Macro mode, a value will appear on the monitor screen as shown below to tell you the focusing range.
Example: 👉 10cm - 50cm

Using the Infinity Mode

Use this mode when recording scenery and other faraway images.

1. Keep pressing [▲] (👉 📷) until the focus mode indicator shows “∞”.
2. Record the image.

Using Manual Focus

With the Manual Focus mode, you can adjust the focus of an image manually. The following shows focus ranges in the Macro mode for two optical zoom factors.

Optical Zoom Factor	Approximate Focus Range
1X	10cm (3.9”) to infinity (∞)
3X	60cm (23.6”) to infinity (∞)

1. Keep pressing [▲] (👉 📷) until the focus mode indicator shows “MF”.

- At this point, a boundary also appears on the display, indicating the part of the image that will be used for manual focus.

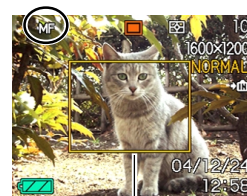

Boundary

OTHER RECORDING FUNCTIONS

2. While watching the image on the monitor screen, use [◀] and [▶] to focus.



Manual focus position

To do this:	Do this:
Focus in on the subject	Press [◀].
Focus out on the subject	Press [▶].

- Pressing [◀] or [▶] causes the area inside of the boundary displayed in step 1 to fill the monitor screen momentarily to aid in focus. The normal image reappears a short while later.

3. Record the image.

▶▶ IMPORTANT! ◀◀

- In the Manual Focus mode, the [◀] and [▶] keys adjust focus, even if you used key customization to assign other functions to them (page 106).

▶▶ NOTE ◀◀

- Whenever you perform an optical zoom operation (page 60) while recording with manual focus, a value will appear on the monitor screen as shown below to tell you the focusing range.

Example: MF 10cm - ∞

Using Focus Lock

Focus lock is a technique you can use to focus on a subject that is not located within the focus frame when you record an image. You can use focus lock in the Auto Focus mode and the Macro mode ().

- Using the monitor screen, compose the image so the main subject is within the focus frame, and then press the shutter button half way.

- This locks the focus on the subject that is currently within the focus frame.

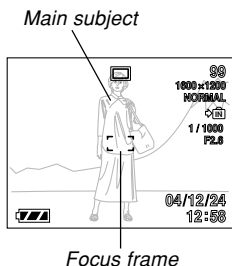

- Keeping the shutter button pressed half way down, re-compose the image as you like.

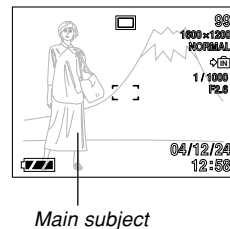

- When the image is composed the way you want, press the shutter button the rest of the way to record it.

NOTE

- Locking the focus also locks the exposure.

Exposure Compensation (EV Shift)

Exposure compensation lets you change the exposure setting (EV value) manually to adjust for the lighting of your subject. This feature helps to achieve better results when recording a backlit subject, a strongly lit subject indoors, or a subject that is against a dark background.

EV Shift Range: -2.0EV to +2.0EV

Steps: 1/3EV

1. In the REC mode, press [MENU].

2. Select the “REC” tab, select “EV Shift”, and then press [▶].

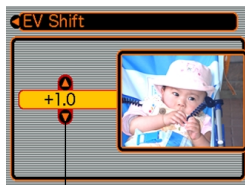

Exposure compensation value

3. Use [▲] and [▼] to change the exposure compensation value, and then press [SET].

- Pressing [SET] registers the displayed value.



EV value

[▲] : Increases the EV value. A higher EV value is best used for light-colored subjects and backlight subjects.

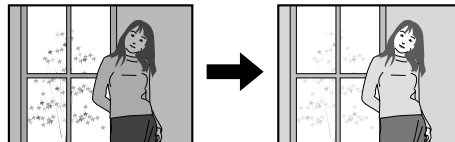

[▼] : Decreases the EV value. A lower EV value is best for dark-color subjects and for shooting outdoors on a clear day.

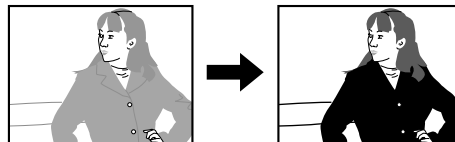

OTHER RECORDING FUNCTIONS

- To cancel EV Shift, adjust the value until it becomes 0.0.

4. Record the image.

▶▶ IMPORTANT! ◀◀

- When shooting under very dark or very bright conditions, you may not be able to obtain satisfactory results even after performing exposure compensation.

▶▶ NOTE ◀◀

- Performing an EV shift operation while using multi-pattern metering (page 101) will cause the metering mode to switch automatically to center weighted metering (page 101). Returning the EV shift value to 0.0 causes the metering mode to change back to multi-pattern metering.
- You can use key customization (page 106) to configure the camera to perform exposure compensation whenever you press [◀] or [▶] while in the REC mode.

Adjusting White Balance

The wavelengths of the light produced by various light sources (daylight, light bulb, etc.) can affect the color of a subject when it is recorded. White balance lets you make adjustments to compensate for different lighting types, so the colors of an image appear more natural.





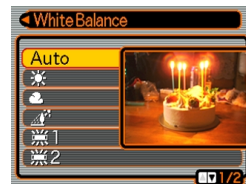

1. In the REC mode, press [MENU].

2. Select the “REC” tab, select “White Balance”, and then press [▶].



OTHER RECORDING FUNCTIONS

3. Use [▲] and [▼] to select the setting you want, and then press [SET].

When shooting under these conditions:	Select this setting:
Normal conditions	Auto
Outdoor daylight on a clear day	
Outdoor daylight on an overcast or rainy day, in the shade of a tree, etc.	
In the shade of a building or any other area where the color temperature is high	
Under white or daylight white fluorescent light (suppresses color fogging)	
Under daylight fluorescent light (suppresses color fogging)	
Under incandescent lighting	
Difficult lighting that requires manual control (See “Configuring the White Balance Setting Manually”.)	Manual

NOTE

- When “Auto” is selected for the white balance setting, the camera automatically determines the white point of the subject. Certain subject colors and light source conditions can cause problems when the camera tries to determine the white point, which makes proper white balance adjustment impossible. When this happens, use daylight, cloudy, or one of the other fixed white balance settings to specify the type of lighting available.
- You can use the key customization feature (page 106) to configure the camera so the white balance setting changes whenever you press [◀] or [▶] while in the REC mode.

Configuring the White Balance Setting Manually

Certain complex light sources or other environmental conditions can make it impossible to obtain good results when “Auto” or one of the fixed light source settings is selected for white balance. Manual white balance lets you configure the camera for a particular light source and other conditions.

Note that you must perform manual white balance under the same conditions you will be shooting under. You must also have a white paper or other similar object on hand in order to perform manual white balance.

1. In the REC mode, press [MENU].
2. Select the “REC” tab, select “White Balance”, and then press [▶].
3. Use [▲] and [▼] to select “Manual”.

- This causes the object you last used to adjust manual white balance to appear on the monitor screen.

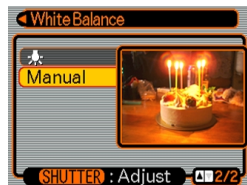

4. Point the camera at a white paper or similar object under the lighting conditions for which you want to set the white balance, and then press the shutter button.

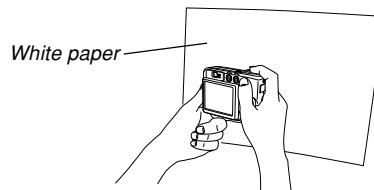

- This starts the white balance adjustment procedure. The message “Complete” appears on the monitor screen after white balance adjustment is complete.
5. Press [SET].
- This registers the white balance settings and returns to the currently selected recording mode.

»» NOTE ««

- After you adjust white balance manually, the setting remains in effect until you change it or until you turn off the camera.

Using the High-speed Continuous Shutter Mode

You can configure the camera to record only a single snapshot each time the shutter button is pressed, or to keep recording as long as the shutter button remains depressed.

- Recording Speed: Three images per second (The interval between shots is longer when shooting at slow shutter speeds)
- Maximum Number of Shots: 3

- 1. In the REC mode, press [MENU].**
- 2. Select the “REC” tab, select “Continuous”, and then press [▶].**
- 3. Use [▲] and [▼] to select “On”, and then press [SET].**
 - This causes  to appear on the monitor screen.
 - Select “Off” if you want to turn off the high-speed continuous shutter mode.
- 4. Press the shutter button to record.**
 - Recording continues as long as you keep the shutter button depressed. Release the shutter button to stop recording.

OTHER RECORDING FUNCTIONS

▶▶ IMPORTANT! ◀◀

- Nothing is displayed on the monitor screen while recording is in progress.
- Recording pauses and the message “Busy.... Please wait...” appears on the monitor screen after three images are recorded.
- The flash is disabled while the high-speed continuous shutter mode is turned on.
- You cannot use the Triple Self-timer in combination with the high-speed continuous shutter mode (page 68).
- You cannot use the high-speed continuous shutter mode during Coupling Shot, Pre-shot, or Business Shot recording (pages 89, 91, 93).
- When using the continuous shutter mode, keep the camera still until all recording is finished.
- A continuous shutter operation may stop part way through if memory capacity runs low.

Using the BESTSHOT Mode

Selecting one of the 23 BESTSHOT scenes automatically sets up the camera for recording a similar type of image.

Scene Number	Scene Name
1	Portrait
2	Scenery
3	Portrait With Scenery
4	Coupling Shot (page 89)
5	Pre-shot (page 91)
6	Children
7	Candlelight Portrait
8	Party
9	Pet
10	Flower
11	Natural Green
12	Sundown
13	Night Scene
14	Night Scene Portrait
15	Fireworks
16	Food
17	Text
18	Collection
19	Monochrome

OTHER RECORDING FUNCTIONS

Scene Number	Scene Name
20	Retro
21	Twilight
22	Business card and documents (page 93)
23	White board, etc. (page 93)
	Register User Scene (page 87)

1. Enter the REC Mode, and select “**BS** BESTSHOT” as the recording mode (page 53).



- This enters the BESTSHOT Mode and displays a sample scene.
 - You can use the key customization feature (page 106) to configure the camera to enter the BESTSHOT Mode whenever you press [◀] or [▶] while in the REC mode.
2. Use [◀] and [▶] to select the sample scene you want, and then press [SET].
 3. Record the image.

OTHER RECORDING FUNCTIONS

▶▶ IMPORTANT! ◀◀

- BESTSHOT scenes were not recorded using this camera. They are provided as samples only.
- Images recorded using a BESTSHOT scene may not produce the results you expected due to shooting conditions and other factors.
- After selecting a BESTSHOT scene, you can change to a different one by pressing [SET] and then using [◀] and [▶] to scroll through available scenes. When the one you want is displayed, press [SET].
- You can change the camera settings that are made when you select a BESTSHOT scene. Note, however, that the BESTSHOT settings revert to their defaults when you select another BESTSHOT scene, change the recording mode, or turn off the camera.
- Noise reduction processing is performed automatically when you are recording a night scene, fireworks, or other image that requires slow shutter speeds. Because of this, it takes longer to record images at lower shutter speeds. Make sure that you do not perform any camera button operations until the image recording operation is complete.
- When recording the image of a night scene, fireworks, or some other image using a slow shutter speed, use of a tripod is recommended to prevent hand movement.

▶▶ NOTE ◀◀

- You can use the key customization feature (page 106) to configure the camera to enter the BESTSHOT mode whenever you press [◀] or [▶] while in the REC mode. Operation guidance and the currently selected BESTSHOT scene appear on the display for about two seconds after you enter the BESTSHOT mode this way, or if the camera is in the BESTSHOT mode when you turn it on.



Creating Your Own BESTSHOT Setup

You can use the procedure below to save the setup of an image you recorded for later recall when you need it again. Recalling a setup you save automatically sets up the camera accordingly.

1. Enter the REC Mode, and select “BS BESTSHOT” as the recording mode (page 53).

- This enters the BESTSHOT mode and displays a sample scene.

2. Use [◀] and [▶] to display “Register User Scene”.



3. Press [SET].

4. Use [◀] and [▶] to display the image whose setup you want to register as a BESTSHOT scene.



5. Use [▲] and [▼] to select “Save”, and then press [SET].

- This registers the setup.
- Now you can use the procedure on page 85 to select your user setup for recording.

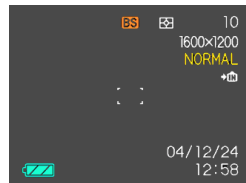

OTHER RECORDING FUNCTIONS

▶▶ IMPORTANT! ◀◀

- Setups that you register as BESTSHOT sample scenes are located after the built-in sample scenes.
- Note that formatting the built-in memory (page 145) deletes all BESTSHOT user setups.

▶▶ NOTE ◀◀

- The following are the settings that are included in a BESTSHOT user setup: focus mode, EV shift value, filter, metering mode, white balance mode, flash intensity, flash assist, sharpness, saturation, contrast, flash mode, and ISO sensitivity.
- Note that images recorded with this camera only can be used to create a BESTSHOT user setup.
- You can have up to 999 BESTSHOT user setups in the camera's built-in memory at one time.
- You can check the current setup of a scene by displaying the various setting menus.
- When you register a BESTSHOT user setup, it is automatically assigned a file name using the format "UQR61nnn.JPE" (n=0 to 9).

■ To delete a BESTSHOT user setup

1. Enter the REC Mode, and select "BS BESTSHOT" as the recording mode (page 53).
2. Use [◀] and [▶] to display the user setup you want to delete.
3. Press [▼] (⚡ ) to delete the user setup.
4. Use [▲] and [▼] to select "Delete".
5. Press [SET] to delete the file.
6. Press [MENU] .

Combining Shots of Two People into a Single Image (Coupling Shot)

The Coupling Shot mode lets you record images of two people and combine them into a single image. This makes it possible for you to include yourself in group images, even when there is no one else around to record the image for you. Coupling Shot is available in the BESTSHOT mode (page 84).

- First Image



This is the part of the image that does not include the person who is recording the first image.



- Second Image



Making sure that the background of the image is aligned correctly, record the image of the person who recorded the first image.

- Combined Images

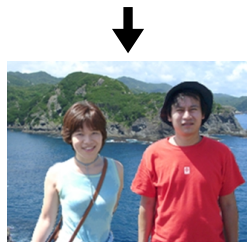

1. Enter the REC Mode, and select “**BS** BESTSHOT” as the recording mode (page 53).
2. Use [◀] and [▶] to select “Coupling Shot”, and then press [SET].
3. Align the focus frame on the monitor screen with the subject you want on the left side of the image.



Focus frame

- While “Coupling Shot” is selected, the “AF Area” (page 74) setting automatically becomes “Spot”.

OTHER RECORDING FUNCTIONS

4. Press the shutter button to record the left side of the image.

- The focus, exposure, white balance, zoom, and flash settings are fixed for this type of image.

5. Next, align the focus frame with the subject you want in the right side of the image, taking care to align the actual background with the semi-transparent image of the background of the first image, which is shown on the monitor screen.

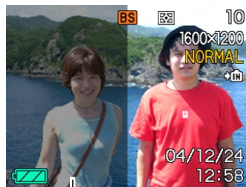

Semi-transparent background

- Pressing [MENU] any time after step 4 of the above procedure cancels the first image and returns to step 3.

6. When everything is aligned correctly, record the right side of the image.

▶▶ IMPORTANT! ◀◀

- Coupling Shot temporarily uses file memory to store data. You may get an error during Coupling Shot recording if there is not enough file memory available to store the required data. If this happens, delete images you no longer need and try again.

OTHER RECORDING FUNCTIONS

Recording a Subject onto an Existing Background Image (Pre-shot)

Pre-shot helps you get the background you want, even if you need to ask someone else to record the image for you. Basically, Pre-shot is a two-step process.

1. You compose the background you want and press the shutter button, which causes a semi-transparent image of the background to remain on the monitor screen.
2. Ask someone else to record a shot of you against your original background, telling them to compose the image by using the semi-transparent monitor screen image as a guide.
 - The camera stores the image produced by step 2 only.
 - Depending on how the image is actually composed in step 2, its background may not be exactly the same as the one you composed in step 1.

Note that Pre-shot is available in the BESTSHOT mode only (page 84).

- Freeze the background on the monitor screen.



- Record the image, using the background on the monitor screen as a guide.



- Only the second image is recorded.



OTHER RECORDING FUNCTIONS

1. Enter the REC Mode, and select “**[BS]** BESTSHOT” as the recording mode (page 53).
2. Use [**◀**] and [**▶**] to select “Pre-shot”, and then press [**SET**].
3. Compose the background you want on the monitor screen, and then press the shutter button to temporarily record it as a reference image.
 - This operation causes a semi-transparent image of the background to appear on the monitor screen, but the displayed image is not actually saved in camera memory.
 - The focus, exposure, white balance, zoom, and flash settings are fixed for this type of image.
4. Now you can stand in front of the background and ask someone else to snap your picture, using the semi-transparent background on the monitor screen as a composition guide.



Semi-transparent background

- You can press [**MENU**] at this point to clear the semi-transparent background from the monitor screen. Then you can repeat step 3 to record a new background.
5. After composing the final image (using the semi-transparent background as a guide), the person with the camera should press the shutter button to record.
 - Note that the semi-transparent background image you temporarily record in step 3 is for composition purposes only. The final image contains only what is in front of the camera when the shutter button is pressed in step 5.

Recording Images of Business Cards and Documents (Business Shot)

Recording a business card, document, white board, or similarly shaped object from an angle can cause the subject to appear misshaped in the resulting image. Business Shot automatically corrects the shape of rectangular objects to make them appear like the camera was positioned directly in front of them.

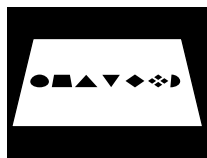

Before keystone correction

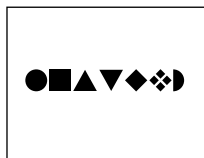

After keystone correction

■ Setup Sample Images

- Business cards and documents
- White board, etc.

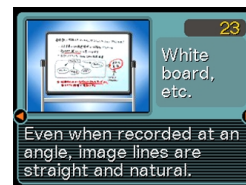
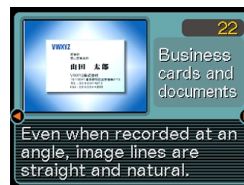

OTHER RECORDING FUNCTIONS

►► IMPORTANT! ◀◀

- Before recording, compose the image so outline of the item you want to record fits entirely within the monitor screen. The camera will not be able to detect the shape of the subject correctly unless it is enclosed entirely within the monitor screen.
- The camera also will be unable to detect the shape of the subject if it is the same color as the background. Make sure the subject is against a background that allows the outline of the subject to stand out.

►► NOTE ◀◀

- When the camera is at an angle to a business card or document it is recording, the shape of the business card or document may appear distorted in the image. Auto keystone correction corrects for this distortion, which means that subjects appear normal even if you record at an angle.

To use Business Shot

1. Enter the REC Mode, and select “**BS** BESTSHOT” as the recording mode (page 53).
2. Use [◀] and [▶] to select the Business Shot image you want, and then press [SET].
3. Record the image.

- This displays a screen that shows all of the objects in the image that qualify as candidates for keystone correction. An error message will appear (page 204) if the camera is unable to find any suitable keystone correction candidate in the image. After a short while, the original image will be stored in memory, as-is.



4. Use [◀] and [▶] to select the candidate you want to correct.

5. Use [▲] and [▼] to select “Correct”, and then press [SET].

- Selecting “Cancel” in place of “Correct” stores the original image as-is, without correcting it.



►► IMPORTANT! ◀◀

- The maximum Business Shot image size is 1600 × 1200 pixels, even if the camera is configured for a larger image size. An image size setting smaller than 1600 × 1200 pixels records images at the specified size.

Using the Movie Mode

You can record movies. A single movie can be as long as available memory capacity allows.

- File Format: AVI
 - AVI format conforms to the Motion JPEG format promoted by the Open DML Group.
- Image Size: 320 × 240 pixels
- Movie File Size: Approximately 300KB/second
- Maximum Movie Length
 - One Movie:
 - As long as available memory capacity allows
 - Total Movie Time:
 - 30 seconds with built-in memory; 205 seconds with 64MB SD memory card

►► NOTE ◀◀

- You can play back files recorded in the Movie Mode on your computer using Windows Media Player.

OTHER RECORDING FUNCTIONS

1. Enter the REC Mode, and select “ Movie” as the recording mode (page 53).

- This enters the Movie Mode and causes “” to appear on the monitor screen.
- You can use the key customization feature (page 106) to configure the camera to enter the Movie Mode whenever you press [◀] or [▶] while in the REC mode.

Remaining recording time

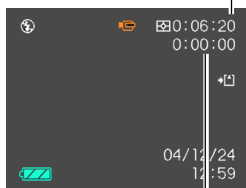

Recording time

2. Point the camera at the subject and then press the shutter button.

- Movie recording continues as long as remaining memory capacity allows, or until you stop it by pressing the shutter button again.

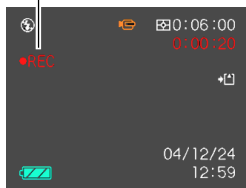

Movie recording indicator



- The remaining recording time counts down and the elapsed recording time counts up on the monitor screen as you record.
- Starting a movie record operation causes optical zoom to be disabled. Only digital zoom is available while a movie record operation is in progress. If you want to use optical zoom to record a movie, perform the zoom operation before starting the record operation.

3. When movie recording is complete, the movie file is stored in file memory.

▶▶ IMPORTANT! ◀◀

- The flash does not fire in the Movie mode.
- Certain types of memory cards take longer to record data, which can cause movie frames to be dropped.  and  flash on the monitor screen during recording to let you know when a frame has been dropped.

Using the Histogram

You can use [DISP] to display a histogram on the monitor screen. The histogram lets you check exposure conditions as you record images (page 32). You can also display the histogram of a recorded image in the PLAY mode.

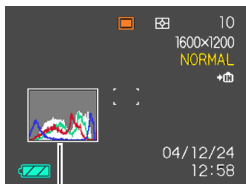

Histogram

- A histogram is a graph that represents the lightness of an image in terms of the number of pixels. The vertical axis indicates the number of pixels, while the horizontal axis indicates lightness. You can use the histogram to determine whether an image includes the shadowing (left side), mid tones (center), and highlighting (right) required to bring out sufficient image detail. If the histogram appears too lopsided for some reason, you can use EV shift (exposure compensation) to move it left or right in order to achieve better balance. Optimum exposure can be achieved by correcting exposure so the graph is as close to the center as possible.

- An RGB histogram that shows the distribution of R (red) , G (green) , and B (blue) components is also displayed. This histogram can be used to determine whether there is too much or too little of each of the color components in an image.

NOTE

- You can use key customization (page 106) to configure the camera to perform exposure compensation whenever you press [◀] or [▶] while in the REC mode. If you do this, you can adjust exposure compensation while viewing the on-screen histogram (page 79).

OTHER RECORDING FUNCTIONS

- When the histogram is too far to the left, it means that there are too many dark pixels. This type of histogram results when the overall image is dark. A histogram that is too far to the left may result in “black out” of the dark areas of an image.

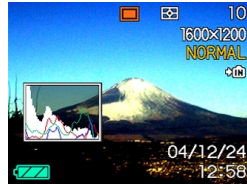

- When the histogram is too far to the right, it means that there are too many light pixels. This type of histogram results when the overall image is light. A histogram that is too far to the right may result in “white out” of the light areas of an image.



- A centered histogram indicates that there is good distribution of light pixels and dark pixels. This type of histogram results when the overall image is at optimal lightness.

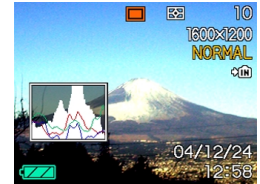

►► IMPORTANT! ◀◀

- Note that the above histograms are shown for illustrative purposes only. You may not be able to achieve exactly the same shapes for particular subjects.
- A centered histogram does not necessarily guarantee optimum exposure. The recorded image may be over-exposed or under-exposed, even though its histogram is centered.
- You may not be able to achieve an optimum histogram configuration due to the limitations of EV shift.
- Use of the flash as well as certain shooting conditions can cause the histogram to indicate exposure that is different from the actual exposure of the image when it was recorded.
- The histogram does not appear when you are using Coupling Shot (page 89) or Pre-shot (page 91).
- The RGB (color component) histogram is displayed for snapshots only. In the Movie mode, only the luminance distribution histogram appears on the monitor screen.

REC Mode Camera Settings

The following are the settings you can configure before recording an image using a REC mode.

- ISO sensitivity
- Metering
- Color filtering
- Sharpness
- Saturation
- Contrast
- Grid on/off
- Image Review on/off
- Icon Help
- L/R key setting
- Power on default settings
- Resetting the camera

►► NOTE ◀◀

- You can also configure the settings listed below. See the referenced pages for more information.
 - Size (page 70)
 - Quality (page 71)
 - White Balance (page 80)
 - AF Area (page 74)
 - Flash Intensity (page 65)
 - Flash Assist (page 66)
 - Digital Zoom (page 62)

Specifying ISO Sensitivity

You can change the ISO sensitivity setting for better images in places where lighting is dim or when you are using faster shutter speeds.

- ISO sensitivity is expressed in terms of values that originally indicated the sensitivity to light for photographic film. A larger value indicates higher sensitivity, which is better for recording when available lighting is dim.

1. In the REC mode, press [MENU].
2. Select the “REC” tab, select “ISO”, and then press [▶].
3. Use [▲] and [▼] to select the setting you want, and then press [SET].

To get this:	Select this setting:
Automatic sensitivity selection	Auto
Conforms to ISO 64	ISO 64
Conforms to ISO 125	ISO 125
Conforms to ISO 250	ISO 250
Conforms to ISO 500	ISO 500

►► IMPORTANT! ◀◀

- Under certain conditions, a high shutter speed in combination with a high ISO sensitivity setting can cause digital noise, which makes an image appear rough. For clean, good-quality images, use the lowest possible ISO sensitivity setting possible.
- Using a high ISO sensitivity setting along with the flash to shoot a nearby subject may result in improper illumination of the subject.

►► NOTE ◀◀

- You can use key customization (page 106) to configure the camera so the ISO sensitivity setting changes whenever you press [◀] and [▶] while in the REC mode.

Selecting the Metering Mode

Use the following procedure to specify multi-pattern metering, spot metering, or center-weighted metering as the metering mode.

1. In the REC mode, press [MENU].
2. Select the "REC" tab, select "Metering", and then press [▶].
3. Use [▲] and [▼] to select the setting you want, and then press [SET].

Multi (Multi-pattern)

Multi-pattern metering divides the image into sections and measures the light in each section for a balanced exposure reading. The camera automatically determines shooting conditions according to the measured lighting pattern, and makes exposure settings accordingly. This type of metering provides error-free exposure settings for a wide range of shooting conditions.



Center weighted

Center weighted metering measures light concentrating on the center of the focus area. Use this metering method when you want to exert some control over exposure, without leaving settings totally up to the camera.



Spot

Spot metering takes readings at a very small area. Use this metering method when you want exposure to be set according to the brightness of a particular subject, without it being affected by surrounding conditions.



►► IMPORTANT! ◀◀

- When “Multi” is selected as the metering mode, certain procedures cause the metering mode setting to change automatically as described below.
- Changing the exposure compensation setting (page 79) to a value other than 0.0 changes the metering mode setting to “Center Weighted.” The metering mode changes back to “Multi” when you return the exposure compensation setting to 0.0.

Using the Filter Function

The camera’s filter function lets you alter the tint of an image when you record it.

- 1. In the REC mode, press [MENU].**
- 2. Select the “REC” tab, select “Filter”, and then press [▶].**
- 3. Use [▲] and [▼] to select the setting you want, and then press [SET].**
 - Available filter settings are: Off, B/W, Sepia, Red, Green, Blue, Yellow, Pink, Purple

►► IMPORTANT! ◀◀

- Using the camera’s filter feature produces the same effect as attaching a color filter to the lens.

Specifying Outline Sharpness

Use the following procedure to control the sharpness of image outlines.

1. In the REC mode, press [MENU].
2. Select the “REC” tab, select “Sharpness”, and then press [▶].
3. Use [▲] and [▼] to select the setting you want, and then press [SET].

To get this:	Select this setting:
High sharpness	+2
↑	+1
Normal sharpness	0
↓	-1
Low sharpness	-2

Specifying Color Saturation

Use the following procedure to control the intensity of the image you are recording.

1. In the REC mode, press [MENU].
2. Select the “REC” tab, select “Saturation”, and then press [▶].
3. Use [▲] and [▼] to select the setting you want, and then press [SET].

To get this:	Select this setting:
High color saturation (intensity)	+2
↑	+1
Normal color saturation (intensity)	0
↓	-1
Low color saturation (intensity)	-2

Specifying Contrast

Use this procedure to adjust the relative difference between the light areas and dark areas of the image you are recording.

1. In the REC mode, press [MENU].
2. Select the “REC” tab, select “Contrast”, and then press [▶].
3. Use [▲] and [▼] to select the setting you want, and then press [SET].

To get this:	Select this setting:
High contrast	+2
↑	+1
Normal contrast	0
↓	-1
Low contrast	-2

Turning the On-screen Grid On and Off

You can display gridlines on the monitor screen to help you compose images and ensure that the camera is straight when recording.

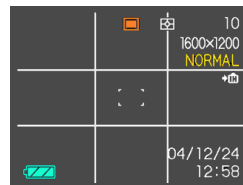

1. In the REC mode, press [MENU].
2. Select the “REC” tab, select “Grid”, and then press [▶].
3. Use [▲] and [▼] to select the setting you want, and then press [SET].

To do this:	Select this setting:
Display the grid	On
Hide the grid	Off

Turning Image Review On and Off

Image review displays the images you record on the monitor screen as soon as you record them. Use the following procedure to turn image review on and off.

1. In the REC mode, press [MENU].
2. Select the “REC” tab, select “Review”, and then press [▶].
3. Use [▲] and [▼] to select the setting you want, and then press [SET].

To do this:	Select this setting:
Display images on the monitor screen for about one second immediately after they are recorded	On
Do not display images immediately after they are recorded	Off

Using Icon Help



Icon Help displays guidance text about an icon when you select it on the monitor screen while in the REC mode (page 29).

- Icon Help text is displayed for the following functions: current REC mode, flash mode, focus mode, white balance, self-timer, metering mode.
Note, however, that current REC mode, white balance and self-timer icon help text appears only when “REC Mode”, “White Balance” or “Self-timer” is assigned to the [◀] and [▶] keys with the key customization feature (page 106).

1. In the REC mode, press [MENU].
2. Select the “REC” tab, select “Icon Help”, and then press [▶].
3. Use [▲] and [▼] to select the setting you want, and then press [SET].

To do this:	Select this setting:
Display guidance text when you switch a function	On
Turn off Icon Help	Off

▶▶ IMPORTANT! ◀◀

- Selecting one of the following settings causes the icon and its Icon Help text to appear momentarily on the monitor screen. The icon and text disappear after a short while.
 - Flash mode  (Auto) icon (page 63)
 - Focus mode  (Auto Focus) icon (page 72)
 - White balance  (Auto) icon (page 80)

Assigning Functions to the [◀] and [▶] Keys

A “key customization” feature lets you configure the [◀] and [▶] keys so they change camera settings whenever they are pressed in the REC mode. After you configure the [◀] and [▶] keys, you can change the setting assigned to them without going through the menu screen.

- 1. In the REC mode, press [MENU].**
- 2. Select the “REC” tab, select “L/R Key”, and then press [▶].**
- 3. Use [▲] and [▼] to select the setting you want, and then press [SET].**

OTHER RECORDING FUNCTIONS



When you want to assign this function to [◀] and [▶] keys:	Select this:
Recording mode • [◀] and [▶] cycle through recording modes: Snapshot, BESTSHOT, Movie (page 53).	REC Mode
EV shift • [◀] decreases compensation, [▶] increases compensation (page 79).	EV Shift
White balance setting • [◀] and [▶] cycle through white balance settings (page 80).	White Balance
ISO sensitivity • [◀] and [▶] cycle through ISO sensitivity settings (page 100).	ISO
Self-timer mode • [◀] and [▶] cycle through self-timer modes (page 68).	Self-timer
No function assigned	Off

Specifying Power On Default Settings

The camera's "mode memory" feature lets you specify the power on default settings individually for the REC mode, flash mode, focus mode, white balance mode, ISO sensitivity, AF Area, metering mode, self-timer, flash intensity, digital zoom mode, manual focus position, and zoom position. Turning on mode memory for a mode tells the camera to remember the status of that mode when you turn off the camera, and restore it the next time you turn the camera back on. When mode memory is turned off, the camera automatically restores the initial factory default setting for the applicable mode.

The following table shows what happens when you turn mode memory on or off for each mode.

OTHER RECORDING FUNCTIONS

Function	On	Off
REC Mode	Setting when camera is turned off	 Snapshot
Flash		Auto
Focus		Auto
White Balance		Auto
ISO		Auto
AF Area		Spot
Metering		Multi
Self-timer		Off
Flash Intensity		0
Digital Zoom		On
MF Position		Last Auto Focus position that was in effect before you switched to manual focus
Zoom Position*		 (Wide Angle)

* Only the optical zoom position is remembered.

1. In the REC mode, press [MENU].
2. Use [◀] and [▶] to select the “Memory” tab.
3. Use [▲] and [▼] to select the item you want to change, and then press [▶].
4. Use [▲] and [▼] to select the setting you want, and then press [SET].

To do this:	Select this setting:
Turn on mode memory so settings are restored at power on	On
Turn off mode memory so settings are initialized at power on	Off

▶▶ IMPORTANT! ◀◀

- If you change the BESTSHOT mode sample scene selection or if you turn off the camera while it is in the BESTSHOT mode, the camera's setup (except for "REC mode" and "Zoom Position") will be configured according to the BESTSHOT sample scene settings when you turn it back on again. This is true, regardless of mode memory on/off settings.
- If you turn the camera off while in the Movie mode, the flash will be turned off when you turn the camera back on again, regardless of mode memory on/off setting for the flash.

Resetting the Camera

Use the following procedure to reset all of the camera's settings to their initial defaults as shown under "Menu Reference" on page 194.

- 1. In the REC mode or the PLAY mode, press [MENU].**
- 2. Select the "Set Up" tab, select "Reset", and then press [▶].**
- 3. Use [▲] and [▼] to select "Reset", and then press [SET].**
 - To cancel the procedure without resetting, select "Cancel" and press [SET].

PLAYBACK

You can use the camera's built-in monitor screen to view images after you record them.

Basic Playback Operation

Use the following procedure to scroll through files stored in the camera's memory.

1. Press [▶] (PLAY) to turn on the camera.

- This enters the PLAY mode and causes an image or a message to appear on the monitor screen.

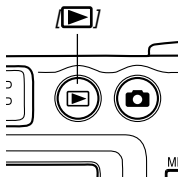

2. Use [▶] (forward) or [◀] (back) to scroll through files on the monitor screen.



NOTE

- Holding down [◀] or [▶] scrolls images at high speed.
- In order to allow for faster playback image scrolling, the image that initially appears on the monitor screen is a preview image, which is of somewhat lower quality than the actual display image. The actual display image appears a short while after the preview image. This does not apply to images copied from another digital camera.

Zooming the Display Image

Perform the following procedure to zoom the image currently on the monitor screen up to four times its normal size.

1. In the PLAY mode, use [◀] and [▶] to display the image you want.

2. Slide the zoom controller towards  to enlarge the image.

- This displays an indicator that shows the current zoom factor.
- You can toggle display of the zoom factor on and off by pressing [DISP].



Current zoom factor

3. Use [▲], [▼], [◀], and [▶] to shift the image up, down, left, or right.

4. Press [MENU] to return the image to its original size.

▶▶ IMPORTANT! ◀◀

- You cannot zoom a movie image.
- Depending on the original size of the recorded image, you may not be able to zoom a display image the full four times its normal size.

Resizing an Image

You can use the following procedure to change an image to one of the three sizes.

- 1600 × 1200-pixel UXGA size
- 1280 × 960-pixel SXGA size
- 640 × 480-pixel VGA size

- VGA is the optimum image size for attachment to e-mail messages or incorporation into Web pages.

1. In the PLAY mode, press [MENU].

2. Select the “PLAY” tab, select “Resize”, and then press [▶].

- Note that this operation is possible only when a snapshot image is on the monitor screen.



4. Use [▲] and [▼] to select the setting you want, and then press [SET].

To do this:	Select this:
Resize to 1600 × 1200 pixels (UXGA)	1600 × 1200
Resize to 1280 × 960 pixels (SXGA)	1280 × 960
Resize to 640 × 480 pixels (VGA)	640 × 480
Cancel the resizing operation	Cancel

▶▶ IMPORTANT! ◀◀

- Resizing an image creates a new file that contains the image in the size you select. The file with the original image also remains in memory.
- Images smaller than 640 × 480 pixels cannot be resized.
- An image recorded using the 2816 × 1872 (3:2) pixel size cannot be resized.
- A Movie mode image cannot be resized.
- Note that you can resize snapshots recorded with this camera only.
- If the message “This function is not supported for this file.” appears, it means that the current image cannot be resized.
- The resize operation cannot be performed if there is not enough memory to store the resized image.
- When you display a resized image on the camera's monitor screen, the date and time that appear when the image is displayed indicate when the image was originally recorded, not when the image was resized.

Cropping an Image

Use the following procedure when you want to crop a portion of an enlarged image and use the remaining part of the image as an e-mail attachment, Web page image, etc.

- 1. In the PLAY mode, use [◀] and [▶] to scroll through images and display the one you want to crop.**
- 2. Press [MENU].**
- 3. Select the “PLAY” tab, select “Trimming”, and then press [▶].**

- This causes a cropping boundary to appear.
- Note that this operation is possible only when a snapshot image is on the monitor screen.

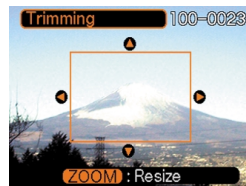

4. Use the zoom controller to make the cropping boundary larger or smaller.

- The size of the cropping boundary depends on the size of the image on the display.

5. Use [▲], [▼], [◀], and [▶] to move the cropping boundary up, down, left, or right until the area of the image you want to extract is within the boundary.**6. Press [SET] to extract the part of the image enclosed in the cropping boundary.**

- If you want to cancel the procedure at any point, press [MENU].

▶▶ IMPORTANT! ◀◀

- Cropping an image creates a new file that contains the cropped image. The file with the original image also remains in memory.
- The size of the area you can select with the cropping boundary is limited for smaller image sizes.
- For a 640×480 size image, you cannot change the size of the cropping boundary at all.
- An image recorded using the 2816×1872 (3:2) pixel size cannot be cropped.
- A Movie mode image cannot be cropped.
- An image recorded using another camera model cannot be cropped.
- If the message "This function is not supported for this file." appears, it means that the current image cannot be cropped.
- The cropping operation cannot be performed if there is not enough memory to store the cropped image.
- When you display a cropped image on the camera's monitor screen, the date and time that appear when the image is displayed indicate when the image was originally recorded, not when the image was cropped.

Playing a Movie

Use the following procedure to play back a movie that was recorded in the Movie mode.

1. In the **PLAY** mode, press [**◀**] and [**▶**] to scroll through images until the movie you want to play is displayed.

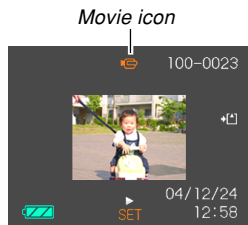

2. Press [**SET**].

- This starts playback of the movie.

- You can perform the following operations while a movie is playing.

To do this:	Do this:
Fast forward or fast reverse the movie	Hold down [◀] or [▶].
Pause and unpause movie playback	Press [SET].
Skip forward or back one frame while paused	Press [◀] or [▶].
Cancel playback	Press [MENU].

▶▶ IMPORTANT! ◀◀

- You cannot repeat play a movie. To play a movie more than once, repeat the steps of the above procedure.

Displaying the 9-image View

The following procedure displays nine images on the monitor screen at the same time.

1. In the PLAY mode, slide the zoom controller towards briefly, and then release it.

- This displays the 9-image screen with the image that was on the monitor screen in step 2 in the center, with a selection boundary around it.
- If there are fewer than nine images in memory, they are displayed starting from the upper left corner. The selection boundary is located at the image that was on the display before you switched to the 9-image view.

2. Use [▲], [▼], [◀], and [▶] to move the selection boundary to the image you want. Pressing [▶] while the selection boundary is in the right column or [◀] while it is in the left column scrolls to the next full screen of nine images.

Example: When there are 20 images in memory, and Image 1 is displayed first

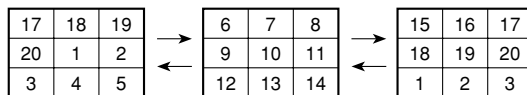

3. Pressing any button besides [▲], [▼], [◀], or [▶] displays the full-size version of the image where the selection boundary is located.

Selecting a Specific Image in the 9-image View

1. Display the 9-image view.
2. Use [▲], [▼], [◀], and [▶] to move the selection boundary up, down, left, or right until it is located at the image you want to view.

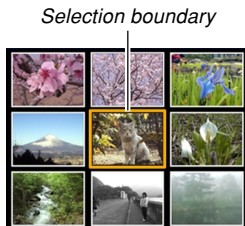

3. Pressing any button besides [▲], [▼], [◀], or [▶] displays the selected image.

- This displays the full-size version of the image you selected.



Displaying the Calendar Screen

Use the following procedure to display a 1-month calendar. Each day shows the first image recorded on that day, which makes it easy to find the image you want.

1. In the PLAY mode, press [▲] (📅).
2. Use [▲], [▼], [◀], and [▶] to move the date selection cursor.

- Use the procedure under “Changing the Date Format” on page 139 to specify the date format.

- The image displayed on the calendar for each date is the first image that was recorded on that date.

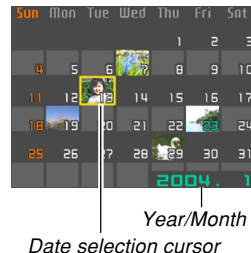

PLAYBACK

- Pressing [▲] while the date selection cursor is located anywhere in the top line of the calendar causes the previous month to appear.
 - Pressing [▼] while the date selection cursor is located anywhere in the bottom line of the calendar causes the next month to appear.
 - To exit the calendar screen, press [MENU] or [DISP].
 -  appears in place of the image when the date contains data that cannot be displayed by this camera.
- 3. To view the large version of a date's image, move the date selection cursor to the date, and then press [SET].**
- This displays the first image that was recorded on the selected date.

Playing a Slideshow

Slideshow automatically plays back images in sequence at a fixed interval.



- 1. In the PLAY mode, press [MENU].**
- 2. Select the "PLAY" tab, select "Slideshow", and then press [▶].**

3. Configure the slideshow settings.

- See the pages indicated below for more information.

For information about configuring this setting:	Go here:
Images	"To specify the slideshow images" on page 120
Time	"To specify the slideshow time" on page 121
Interval	"To set the slideshow interval" on page 121

- To exit the slideshow setting screen and cancel the slideshow, use [▲] and [▼] to select "Cancel" and then press [SET].

4. Use [▲] and [▼] to select "Start", and then press [SET].

- This starts the slideshow.

5. To stop the slideshow, press [SET].

- The slideshow will also stop automatically after the amount of time you specified for "Time" elapses.

►► IMPORTANT! ◀◀

- Note that all buttons are disabled while an image change is in progress. Wait until an image is stopped on the monitor screen before performing a button operation, or hold down the button until the image stops.
- Pressing [◀] during a slideshow will scroll to the previous image, while [▶] scrolls to the next image.
- When the slideshow comes to a movie file, it plays the movie once and advances to the next file.
- Images copied from another digital camera or a computer may take longer time to appear than the slideshow interval time you specify.
- If there are indicators on the display, you can clear them by pressing [DISP] (page 32).

To specify the slideshow images

1. Use [▲] and [▼] to select “Images”, and then press [▶].
2. Use [▲] and [▼] to select the setting you want, and then press [SET].

To do this:	Select this setting:
Include all files in file memory in the slideshow	All images
Display a single file	One Image
Include all files in the FAVORITE folder (page 174) in the slideshow	Favorites

3. Use [▲] and [▼] to select “Start”, and then press [SET].
 - This starts the slideshow.

■ Selecting a Single Image for a Slideshow

When you select “One image” as the slideshow type, the slideshow displays only one image, without changing it.

1. Select “One image”, and then press [▶].
2. Use [◀] and [▶] to scroll through the images until the one you want to use is on the monitor screen.
3. Press [SET] to register your selection and return to the menu screen.

- Pressing [MENU] instead of [SET] returns to the menu screen without registering the setting.



To specify the slideshow time

1. Use [▲] and [▼] to select “Time”.
2. Use [◀] and [▶] to specify the time setting you want, and then press [SET].
 - You can specify a time in the range of 1 to 60 minutes.
3. Use [▲] and [▼] to select “Start”, and then press [SET].
 - This starts the slideshow.

To set the slideshow interval

1. Use [▲] and [▼] to select “Interval”.
2. Use [◀] and [▶] to specify the interval setting you want, and then press [SET].
 - You can specify “MAX”, or a value in the range of 1 to 30 seconds as the interval.
 - When “MAX” is selected for the interval, only the first frame of movie files is played.
3. Use [▲] and [▼] to select “Start”, and then press [SET].
 - This starts the slideshow.

Rotating the Display Image

Use the following procedure to rotate the image 90 degrees and register the rotation information along with the image. After you do this, the image is always displayed in its rotated orientation.

1. In the **PLAY** mode, press **[MENU]**.
2. Select the **“PLAY”** tab, select **“Rotation”**, and then press **[▶]**.
 - Note that this operation is possible only when a snapshot image is on the monitor screen.
3. Use **[◀]** and **[▶]** to scroll through images until the one you want to rotate is on the monitor screen.
4. Use **[▲]** and **[▼]** to select **“Rotate”**, and then press **[SET]**.
 - This rotates the image 90 degrees to the right.

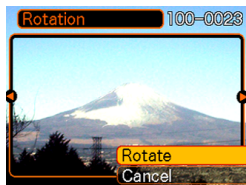

5. After you are finished configuring settings, press **[MENU]** to exit the setting screen.

▶▶ IMPORTANT! ◀◀

- You cannot rotate an image that is protected. To rotate such an image, first unprotect it.
- You may not be able to rotate a digital image that was recorded with another type of digital camera.
- You cannot rotate movie images.

Using Image Roulette

Image Roulette cycles images like a slot machine on the display, before stopping at one of them. When you start an Image Roulette operation, images scroll randomly on the screen. At first, images scroll at high speed. Then the scrolling gradually slows down until a single image is stopped on the screen. The image that finally appears is random.

1. While the camera is turned off, hold down [◀] as you press [▶] (PLAY) to turn it on.

- Keep [◀] held down until images appear on the monitor screen.
- This starts the Image Roulette operation, scrolling images on the display, finally stopping at one.

2. Press [◀] or [▶] to restart the Image Roulette operation.

3. To turn off Image Roulette, press [📷] (REC) to enter the REC mode or press the power button to turn off the camera.

▶▶ IMPORTANT! ◀◀

- Image Roulette does not play movie files.
- Image Roulette is disabled when there is only one snapshot image available.
- Note that Image Roulette works only with images recorded with this camera. Image Roulette may not operate properly when other types of images are in memory.
- If you do not start another Image Roulette operation for about one minute after the final image appears, the camera will automatically cancel Image Roulette and enter the normal PLAY mode.

DELETING FILES

You can delete a single file, or you can delete all files currently in memory.

»» IMPORTANT! ««

- Note that file deletion cannot be undone. Once you delete a file, it is gone. Make sure you really do not need a file anymore before you delete it. Especially when deleting all files, make sure you check all the files you have stored before proceeding.
- A protected file cannot be deleted. To delete a protected file, unprotect it first (page 127).
- Delete cannot be performed when all files in memory are protected (page 128).
- You cannot use the procedures in this section to delete images from the FAVORITE folder. See the procedures on page 128 for details about deleting FAVORITE folder contents.

Deleting a Single File

1. In the **PLAY** mode, press [**▼**] (⏏).

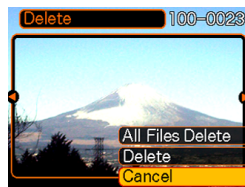

2. Use [**◀**] and [**▶**] to scroll through files and display the one you want to delete.
3. Use [**▲**] and [**▼**] to select “Delete”.
 - To exit the file delete operation without deleting anything, select “Cancel”.
4. Press [**SET**] to delete the file.
 - Repeat steps 2 through 4 to delete other files, if you want.
5. Press [**MENU**] to exit the menu screen.

▶▶ IMPORTANT! ◀◀

- If a file cannot be deleted for some reason, the message “This function is not supported for this file.” appears when you try to delete it.

Deleting All Files

- 1. In the PLAY mode, press [▼] (⚡ 🗑).**
- 2. Use [▲] and [▼] to select “All File Delete”, and then press [SET].**
- 3. Use [▲] and [▼] to select “Yes”.**
 - To exit the file delete operation without deleting anything, select “No”.
- 4. Press [SET] to delete all the files.**
 - The message “There are no files.” appears on the screen after all of the files are deleted.

FILE MANAGEMENT

The file management capabilities of the camera make it easy to keep track of images. You can protect files against deletion and store the files you want in the camera's built-in memory.

Folders

Your camera automatically creates folders in its built-in flash memory or on the memory card.

Memory Folders and Files

An image you record is automatically stored in a folder, whose name is a serial number. You can have up to 900 folders in memory at the same time. Folder names are generated as shown below.

Example: Name of the 100th folder.

100CASIO

Serial number (3 digits)

Each folder can hold files numbered up to 9,999. Trying to store the 10,000th file in a folder causes the next serially numbered folder to be created. File names are generated as shown below.

Example: Name of the 26th file

CIMG0026.JPG

Extension

Serial number (4 digits)

- The folder and file names described here appear when you view folders and files on a computer. See page 31 for information about how the camera displays folder and file names.
- The actual number of files you will be able to store on a memory card depends on the image size and quality, card capacity, etc.
- For details about the folder structure, see "Memory Folder Structure" on page 174.

Protecting Files

Once you protect a file it cannot be deleted (page 124). You can protect files individually or you can protect all files in memory with a single operation.

To protect a single file

1. In the **PLAY** mode, press **[MENU]**.
2. Select the “**PLAY**” tab, select “**Protect**”, and then press **[▶]**.
 
3. Use **[◀]** and **[▶]** to scroll through files and display the one you want to protect.

4. Use **[▲]** and **[▼]** to select “**On**”, and then press **[SET]**.

- A file that is protected is indicated by the  mark.
- To unprotect a file, select “**Off**” in step 4, and then press **[SET]**.



5. Press **[MENU]** to exit the menu screen.

To protect all files in memory

1. In the **PLAY** mode, press **[MENU]**.
2. Select the **“PLAY”** tab, select **“Protect”**, and then press **[▶]**.
3. Use **[▲]** and **[▼]** to select **“All Files : On”**, and then press **[SET]**.
 - To unprotect all files, press **[SET]** in step 3 so the setting shows **“All Files : Off”**.
4. Press **[MENU]** to exit the menu screen.

Using the FAVORITE Folder

You can copy scenery shots, photos of your family, or other special images from a file storage folder (page 174) to the FAVORITE folder in built-in memory (page 174). Images in the FAVORITE folder are not displayed during normal playback, so it helps to keep your personal image private as you carry them around. FAVORITE folder images are not deleted when you change memory cards, so you can always keep them on hand.

To copy a file to the FAVORITE folder

1. In the **PLAY** mode, press **[MENU]**.
2. Select the **“PLAY”** tab, select **“Favorites”**, and then press **[▶]**.

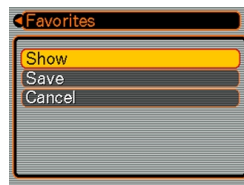

FILE MANAGEMENT

3. Use [▲] and [▼] to select “Save”, and then press [SET].

- This displays the names of the files in built-in memory or on the loaded memory card.



4. Use [◀] and [▶] to select the file you want to copy to the FAVORITE folder.

5. Use [▲] and [▼] to select “Save”, and then press [SET].

- This copies the displayed file to the FAVORITE folder.

6. After copying all of the files you want, use [▲] and [▼] to select “Cancel”, and then press [SET] to exit.

NOTE

- Copying an image file with the above procedure creates a 320 × 240-pixel QVGA-size image in the FAVORITE folder.
- A file copied into the FAVORITE folder is automatically assigned a file name that is a serial number. Though the serial number starts from 0001 and can go as high as 9999, the actual upper end of the range depends on built-in memory capacity. Remember that the maximum number of images that can be stored in built-in memory depends on the size of each image and other factors.

IMPORTANT!

- Note that an image that has been copied to the FAVORITE folder and then resized cannot be returned to its original size.
- Files in the FAVORITE folder cannot be copied to a memory card.

To display a file in the FAVORITE folder

1. In the PLAY mode, press [MENU].
2. Select the “PLAY” tab, select “Favorites”, and then press [▶].
3. Use [▲] and [▼] to select “Show”, and then press [SET].
 - If the FAVORITE folder is empty, the message “No Favorites file!” appears.
4. Use [▶] (forward) and [◀] (back) to scroll through the files in the FAVORITE folder.

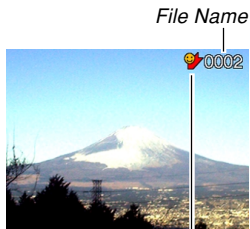

FAVORITE folder icon

5. After you are finished viewing files, press [MENU] twice to exit.

NOTE

- Holding down [◀] or [▶] scrolls images at high speed.

IMPORTANT!

- Note that a FAVORITE folder is created in the camera's built-in memory only. No FAVORITE folder is created on a memory card when you use one. If you want to view the contents of the FAVORITE folder on your computer screen, you need to remove the memory card from the camera (if you are using one) before connecting the USB cable and starting data communication (pages 162, 168).

To delete a file from the FAVORITE folder

1. In the PLAY mode, press [MENU].
2. Select the "PLAY" tab, select "Favorites", and then press [▶].
3. Use [▲] and [▼] to select "Show", and then press [SET].
4. Press [▼] (⚡ .
5. Use [◀] and [▶] to select the file you want to delete from the FAVORITE folder.
6. Use [▲] and [▼] to select "Delete", and then press [SET].
 - To exit the file delete operation without deleting anything, select "Cancel".
7. After deleting all of the files you want, use [▲] and [▼] to select "Cancel", and then press [SET] to exit.

To delete all files from the FAVORITE folder

1. In the PLAY mode, press [MENU].
2. Select the "PLAY" tab, select "Favorites", and then press [▶].
3. Use [▲] and [▼] to select "Show", and then press [SET].
4. Press [▼] (⚡ .
5. Use [▲] and [▼] to select "All File Delete", and then press [SET].

▶▶ IMPORTANT! ◀◀

- You cannot use the standard delete operations on page 124 to delete images from the FAVORITE folder. Performing the memory format operation (page 145), however, does delete FAVORITE folder files.

OTHER SETTINGS

Specifying the File Name Serial Number Generation Method

Use the following procedure to specify the method for generating the serial number used for file names (page 126).

1. In the REC mode or the PLAY mode, press [MENU].
2. Select the “Set Up” tab, select “File No.”, and then press [▶].
3. Use [▲] and [▼] to change the setting, and then press [SET].

To do this for a newly saved file:	Select this setting:
Store the last file number used and increment it, regardless of whether files are deleted or whether the memory card is replaced with a new one	Continue
Find the highest file number in the current folder and increment it	Reset

Turning the Key Tone On and Off

Use the following procedure to turn the tone that sounds when you press a key on and off.

1. In the REC mode or the PLAY mode, press [MENU].
2. Select the “Set Up” tab, select “Beep”, and then press [▶].
3. Use [▲] and [▼] to change the setting, and then press [SET].

To do this:	Select this setting:
Turn on the key tone	On
Turn off the key tone	Off

Specifying an Image for the Startup Screen

You can specify an image you recorded as the startup screen image, which causes it to appear on the monitor screen for about two seconds whenever you press the power button or **[RECORD]** (REC) to turn on the camera. The startup screen image does not appear if you press **[PLAY]** (PLAY) to turn on the camera.

1. In the REC mode or the PLAY mode, press **[MENU]**.
2. Select the “Set Up” tab, select “Startup”, and then press **[▶]**.
3. Use **[◀]** and **[▶]** to display the image you want to use as the startup image.
4. Use **[▲]** and **[▼]** to change the setting, and then press **[SET]**.

To do this:	Select this setting:
Use the currently displayed image as the startup screen image	On
Disable the startup screen	Off

►► IMPORTANT! ◀◀

- You can select any one of the following types of image as the startup image.
 - The camera’s built-in startup image
 - A snapshot you recorded with the camera
 - A movie you recorded with the camera, whose file size is smaller than the amount of unused built-in memory available
- The snapshot image or movie that you select as the startup image is stored in the camera’s built-in memory. Only one image can be stored in startup image memory at one time. Selecting a new startup image overwrites anything that is already stored in startup image memory. Because of this, if you want to return to a previous startup image, you need to have a separate copy of that image in the camera’s standard image memory. Note that you cannot delete an image from startup image memory. You can only replace it with another image.
- The startup image is deleted if you format built-in memory (page 145).

Configuring Power Down Image Settings

With the power down image feature, you can configure the camera so a specific image stored in camera image memory appears whenever you turn off power. You can specify a snapshot or a movie as the power down image.

■ To configure power down image settings

- 1. Use the USB cable to connect the camera to your computer (page 162).**
- 2. Move the image data that you want to use for the power down image to the top (root) folder of the camera's built-in Flash memory.**
 - The file name extension will not be displayed if your computer is configured to hide file name extensions.
Example: CIMG0001
 - If your power down image is stored on a memory card, be sure to copy the image to built-in memory before removing the memory card from the camera.

3. Change the name of the file to one of the following.

Snapshot Image: ENDING.JPG

Movie Image: ENDING.AVI

- You do not need to input the file name extension (JPG or AVI) if your computer is configured to hide file name extensions.
File Name: ENDING
- Your camera is now configured to display a power down image. The power down image will appear any time you press the power button to turn off the camera. The power down image appears regardless of whether or not your camera has a memory card loaded in it.

▶▶ IMPORTANT! ◀◀

- Only a snapshot (JPEG) or movie (AVI) file can be used as the power down image.
- Note that the power down image feature works only with images recorded with this camera. The power down image feature may not operate properly when another type of image is specified as the power down image.
- Formatting the camera's flash memory deletes the power down image (page 145).
- When both a still image and a movie are present for the power down image, only the movie is used.
- Note that a power down image display operation cannot be interrupted once it starts. Because of this, you should select a relatively short movie when using a movie file as the power down image.

■ To disable the power down image feature

- 1. Use the USB cable to connect the camera to your computer (page 162).**
- 2. Change the name of the current power down image from ENDING.JPG or ENDING.AVI to something else, or delete the current power down image from flash memory.**

Using the Alarm

You can configure up to three alarms that cause the camera to beep and display a specified image at the time you specify.

- You can configure up to three alarms, named “Alarm 1”, “Alarm 2”, and “Alarm 3”.

To set an alarm

1. In the **PLAY** mode, press **[MENU]**.
2. Select the “**PLAY**” tab, select “**Alarm**”, and then press **[▶]**.
3. Use **[▲]** and **[▼]** to select the alarm (1, 2, or 3) whose setting you want to configure, and then press **[▶]**.
4. Use **[◀]** and **[▶]** to select the setting you want to change, and then use **[▲]** and **[▼]** to change the selected setting.
 - You can set an alarm time and configure the alarm to sound only once (Once) or at the same time everyday (Daily). You can also turn the alarm on or off.

5. Press **[DISP]**.

- You could press **[SET]** in place of **[DISP]** if you want to configure the alarm without an image.

6. Use **[◀]** and **[▶]** to select the scene you want to appear at the alarm time, and then press **[SET]**.

7. After all the settings are the way you want, press **[SET]**.

Stopping the Alarm

When an alarm time is reached while the camera is turned off, the alarm will sound for about one minute (or until you stop it), and then the camera will turn on. To stop the alarm after it starts to sound, press any button.

▶▶ IMPORTANT! ◀◀

- Note that the alarm does not sound if the alarm time is reached when any one of the following conditions exists.
 - While the camera is turned on
 - While a USB data communication operation is in progress

Setting the Clock

Use the procedures in this section to select a Home Time Zone, and to change its date and time settings. If you want to change the time and date setting only without changing the Home Time Zone, perform the procedure under “To set the current time and date” (page 139) only.

▶▶ IMPORTANT! ◀◀

- Make sure you select your Home Time zone (the zone where you are currently located) before changing the time and date settings. Otherwise, the time and date setting will change automatically when you select another time zone.

To select your Home Time zone

1. In the REC mode or the PLAY mode, press [MENU].
2. Select the “Set Up” tab, select “World Time”, and then press [▶].
 - This displays the current World Time zone.
3. Use [▲] and [▼] to select “Home”, and then press [▶].
4. Use [▲] and [▼] to select “City”, and then press [▶].
5. Use [▲], [▼], [◀], and [▶] to select the geographical area that contains location you want to select as your Home Time zone, and then press [SET].
6. Use [▲] and [▼] to select the city you want, and then press [SET].
7. After selecting the city you want, press [SET] to register its zone as your Home Time zone.

To set the current time and date

1. In the **REC** mode or the **PLAY** mode, press **[MENU]**.
2. Select the “Set Up” tab, select “Adjust”, and then press **[▶]**.
3. Set the current date and the time.

To do this:	Do this:
Change the setting at the current cursor location	Press [▲] or [▼] .
Move the cursor between settings	Press [◀] or [▶] .
Toggle between 12-hour and 24-hour timekeeping	Press [DISP] .

4. When all the settings are the way you want, press **[SET]** to register them and exit the setting screen.

Changing the Date Format

You can select from among three different formats for display of the date.

1. In the **REC** mode or the **PLAY** mode, press **[MENU]**.
2. Select the “Set Up” tab, select “Date Style”, and then press **[▶]**.
3. Use **[▲]** and **[▼]** to change the setting, and then press **[SET]**.

Example: December 24, 2004

To display the date like this:	Select this format:
04/12/24	YY/MM/DD
24/12/04	DD/MM/YY
12/24/04	MM/DD/YY

Using World Time

You can use the World Time screen to view a time zone that is different from the home time zone when you go on a trip, etc. World Time can display the time in one of 162 cities in 32 time zones.

To display the World Time screen

1. In the REC mode or the PLAY mode, press [MENU].
2. Select the “Set Up” tab, select “World Time”, and then press [▶].
 - This displays the current World Time zone.
3. Use [▲] and [▼] to select “World”.

To do this:	Select this:
Display the time in your home time zone	Home
Display the time in the zone currently selected on the World Time screen	World

4. Press [SET] to exit the setting screen.

To configure World Time settings

1. In the REC mode or the PLAY mode, press [MENU].
2. Select the “Set Up” tab, select “World Time”, and then press [▶].
 - This displays the current World Time zone.
3. Use [▲] and [▼] to select “World”, and then press [▶].
4. Use [▲] and [▼] to select “City”, and then press [▶].
5. Use [▲], [▼], [◀], and [▶] to select the geographical area you want, and then press [SET].



OTHER SETTINGS

6. Use [▲] and [▼] to select the city you want, and then press [SET].

- This displays the current time in the city you select.

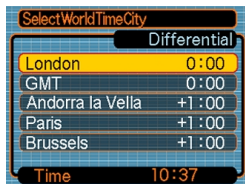

7. When the setting is the way you want, press [SET] to apply it and exit the setting screen.

To configure summer time (DST) settings

Summer time is used in some geographical areas to advance the current time setting by one hour during the summer months.

- Use of summer time depends on the local customs and laws.

1. In the REC mode or the PLAY mode, press [MENU].
2. Select the "Set Up" tab, select "World Time", and then press [▶].
 - This displays the current World Time Settings.
3. Use [▲] and [▼] to select "World", and then press [▶].
 - If you want to configure Home Time settings, select "Home" instead.
4. Use [▲] and [▼] to select "DST", and then press [▶].

OTHER SETTINGS

5. Use [▲] and [▼] to select the summer time (DST) setting you want.

To do this:	Select this:
Advance the current time setting by one hour	On
Display the current time as-is	Off

6. After the setting is the way you want, press [SET].

- This displays the current time in accordance with your setting.

7. Press [SET] again to exit the setting screen.

Changing the Display Language

You can use the following procedure to select one of ten languages as the display language.

1. In the REC mode or the PLAY mode, press [MENU].
2. Select the “Set Up” tab, select “Language”, and then press [▶].
3. Use [▲], [▼], [◀], and [▶] to change the setting, and then press [SET].

日本語 : Japanese

English : English

Français : French

Deutsch : German

Español : Spanish

Italiano : Italian

Português : Portuguese

中國語 : Chinese (Complex)

中国語 : Chinese (Simplified)

한국어 : Korean

Changing the USB Port Protocol

You can use the procedure below to change the communication protocol of the camera's USB port when connecting to a computer, printer, or other external device. Select the protocol that suits the device to which you are connecting.

- 1. In the REC mode or the PLAY mode, press [MENU].**
- 2. Select the "Set Up" tab, select "USB", and then press [▶].**
- 3. Use [▲] and [▼] to select the setting you want, and then press [SET].**

When connecting to this type of device:	Select this setting:
Computer or USB DIRECT-PRINT-compatible printer (page 156)	Mass Storage (USB DIRECT-PRINT)
PictBridge-compatible printer (page 156)	PTP (PictBridge)*

* "PTP" stands for "Picture Transfer Protocol".

- Mass Storage (USB DIRECT-PRINT) causes the camera to see the computer as an external storage device. Use this setting for normal transfer of images from the camera to a computer (using the bundled Photo Loader application).
- PTP (PictBridge) simplifies the transfer of image data to the connected device.

Configuring [RECORD] (REC) and [PLAY] (PLAY) Power On/Off Functions

You can use the following procedures to configure [RECORD] (REC) and [PLAY] (PLAY) so power turns on or off whenever they are pressed.

1. In the REC mode or the PLAY mode, press [MENU].
2. Select the “Set Up” tab, select “REC/PLAY”, and then press [▶].
3. Use [▲] and [▼] to select the setting you want, and then press [SET].

To configure this operation:	Select this setting:
Power turns on when [RECORD] (REC) or [PLAY] (PLAY) is pressed (but does not turn off)	Power On
Power turns on or off when [RECORD] (REC) is pressed in the REC mode or [PLAY] (PLAY) is pressed in the PLAY mode	Power On/Off
Power does not turn on or off when [RECORD] (REC) or [PLAY] (PLAY) is pressed	Disable

►► IMPORTANT! ◀◀

- When “Power On/Off” is selected, pressing [RECORD] (REC) in the REC mode or [PLAY] (PLAY) in the PLAY mode turns off the camera.
- Pressing [RECORD] (REC) in the PLAY mode switches to the REC mode, and pressing [PLAY] (PLAY) in the REC mode switches to the PLAY mode.

►► NOTE ◀◀

- The initial default setting is “Power On”.

Formatting Built-in Memory

Formatting built-in memory deletes any data stored in it.

►► IMPORTANT! ◀◀

- Note that data deleted by a format operation cannot be recovered. Check to make sure you do not need any of the data in memory before you format it.
- Formatting built-in memory deletes all files, including files in the FAVORITE folder (page 128), protected files (page 127), BESTSHOT user setups (page 87), the startup image (page 133), and the power down image (page 134).

1. Check to make sure there is no memory card loaded in the camera.

- If there is a memory card loaded in the camera, remove it (page 148).

2. In the REC mode or the PLAY mode, press [MENU].

3. Select the “Set Up” tab, select “Format”, and then press [▶].

4. Use [▲] and [▼] to select “Format”, and then press [SET].

- To exit the format operation without formatting, select “Cancel”.

USING A MEMORY CARD

You can expand the storage capabilities of your camera by using a commercially available memory card (SD memory card or MultiMediaCard). You can also copy files from built-in flash memory to a memory card and from a memory card to flash memory.



- Normally, files are stored in built-in flash memory. When you insert a memory card, however, the camera automatically stores files to the card.
- Note that you cannot save files to built-in memory while a memory card is installed in the camera.

▶▶ IMPORTANT! ◀◀

- Use only an SD memory card or a MultiMediaCard with this camera. Proper operation is not guaranteed when any other type of card is used.
- See the instructions that come with the memory card for information about how to use it.
- Certain types of cards can slow down processing speeds.
- SD memory cards have a write protect switch, which you can use to protect against accidental deletion of image data. Note, however, if you write protect an SD memory card, you must remove write protection whenever you want to record to it, format it, or delete any of its files.
- Electrostatic charge, electrical noise, and other phenomena can cause data to become corrupted or even lost. Always maintain backup copies of important data on other media (CD-R, CD-RW, MO disc, computer hard disk, etc.).

Using a Memory Card

▶▶ IMPORTANT! ◀◀

- Make sure you turn off the camera before inserting or removing a memory card.
- Be sure to orient the card correctly when inserting it. Never try to force a memory card into the slot when you feel resistance.

To insert a memory card into the camera

1. While pressing the battery compartment cover on the bottom of the camera, slide the cover in the direction indicated by the arrow, and then swing it open.

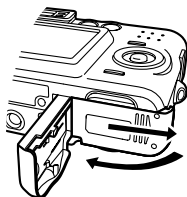

2. Positioning the memory card so its back is facing in the same direction as the camera's monitor screen, carefully slide it into the card slot. Slide the card all the way in until you hear it click securely into place.

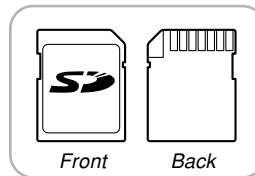
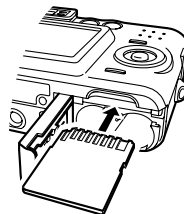

3. Swing the battery compartment cover closed, and then slide it in the direction indicated by the arrow.

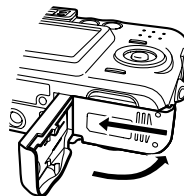

To remove a memory card from the camera

1. Press the memory card into the camera and then release it. This will cause the card to come part way out of the camera.

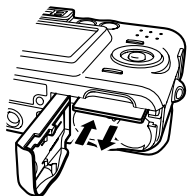

2. Pull the memory card out of the slot.

▶▶ IMPORTANT! ◀◀

- Never insert any other object besides a memory card into the camera's card slot. Doing so creates the risk of damage to the camera and card.
- Should water or any foreign object ever get into the card slot, immediately turn off the camera, remove the batteries, and contact your dealer or nearest CASIO authorized service center.
- Never remove a card from the camera while the operation lamp is flashing. Doing so can cause the file save operation to fail, and even damage the memory card.

To format a memory card

Formatting a memory card deletes any data already stored on it.

▶▶ IMPORTANT! ◀◀

- Be sure to use the camera to format a memory card. Formatting a memory card on a computer and then using it in the camera can slow down data processing by the camera. In the case of an SD card, formatting on a computer can result in non-conformity with the SD format, causing problems with compatibility, operation, etc.
- Note that data deleted by a memory card format operation cannot be recovered. Check to make sure you do not need any of the data on the memory card before you format it.
- Formatting a memory card that contains files deletes all the files, even those that are protected (page 127).

1. Load the memory card into the camera.
2. Turn on the camera. Next, enter the REC mode or PLAY mode, and press [MENU].
3. Select the “Set Up” tab, select “Format”, and then press [▶].
4. Use [▲] and [▼] to select “Format”, and then press [SET].
 - To exit the format operation without formatting, select “Cancel”.

Memory Card Precautions

- If a memory card starts to behave abnormally, you can restore normal operation by reformatting it. However, we recommend that you always take along more than one memory card whenever using the camera far away from the home or office.
- We recommend that you format a memory card before using it for the first time after purchasing it, or whenever the card you are using seems to be the cause of abnormal images.
- As you record data to and delete data from an SD memory card a number of times, it loses its ability to retain data. Because of this, periodic re-formatting of an SD memory card is recommended.
- Before starting a format operation, check to make sure that the batteries are fully charged. Power interruption during the format operation can result in improper formatting, and even damage the memory card and make it unusable.

Copying Files

Use the procedures below to copy files between built-in memory and a memory card.

▶▶ IMPORTANT! ◀◀

- Only snapshot and movie files recorded with this camera can be copied. Other files cannot be copied.
- Files in the FAVORITE folder cannot be copied.

To copy all the files in built-in memory to a memory card

1. Load the memory card into the camera.
2. Turn on the camera. Next, enter the PLAY mode, and press [MENU].
3. Select the “PLAY” tab, select “Copy”, and then press [▶].



4. Use [▲] and [▼] to select “Built-in → Card”, and then press [SET].

- This starts the copy operation and displays the message “Busy....Please wait...”.
- After the copy operation is complete, the monitor screen shows the last file in the folder.

To copy a specific file from a memory card to built-in memory

1. Perform steps 1 through 3 of the procedure under “To copy all the files in built-in memory to a memory card”.
2. Use [▲] and [▼] to select “Card → Built-in”, and then press [SET].
3. Use [◀] and [▶] to select the file you want to copy.
4. Use [▲] and [▼] to select “Copy”, and then press [SET].
 - This starts the copy operation and displays the message “Busy....Please wait...”.
 - The file reappears on the monitor screen after the copy operation is complete.
 - Repeat steps 3 through 4 to copy other images, if you want.
5. Press [MENU] to exit the copy operation.

NOTE

- Files are copied to the folder in built-in memory whose name has the largest number.

PRINTING IMAGES

A digital camera provides you with a variety of different ways to print the images it records. The three main printing methods are described below. Use the method that best suits your needs.

■ Professional Print Service

The camera's DPOF feature lets you specify which images you want to print and how many copies of each you want. For more information, see "DPOF" (page 153).

■ Printing Directly on a Printer Equipped with a Card Slot, or a Printer that Supports USB DIRECT-PRINT or PictBridge

After using the camera's DPOF feature to specify the images you want to print and how many copies of each should be printed, you can plug the memory card into a printer equipped with a card slot, or connect the camera to a PictBridge or USB DIRECT-PRINT printer for printing. For more information, see "DPOF" (page 153) and "Using PictBridge or USB DIRECT-PRINT" (page 156).

■ Printing with a Computer

Windows Users

The camera comes bundled with Photo Loader and Photohands applications (page 186), which can be installed on a Windows computer for image transfer, management, and printing. For more information, see "Viewing Images on a Computer" (page 162) and "Installing the Software from the CD-ROM" (page 185).

▶▶ IMPORTANT! ◀◀

- Refer to the pages referenced above for information about how to connect the camera to a computer. Image management procedures are provided in the following pages of this section.

PRINTING IMAGES

Macintosh Users

The camera comes bundled with Photo Loader for the Macintosh, which can be installed for image transfer and management, but not for printing. Use commercially available software for printing with a Macintosh. For more information, see “Viewing Images on a Computer” (page 162) and “Installing the Software from the CD-ROM” (page 185).

▶▶ IMPORTANT! ◀◀

- Refer to the pages referenced above for information about how to connect the camera to your Macintosh. Image management procedures are provided in the following pages of this section.

DPOF

The letters “DPOF” stand for “Digital Print Order Format”, which is a format for recording on a memory card or other medium which digital camera images should be printed and how many copies of the image should be printed. Then you can print on a DPOF-compatible printer or at a professional print service in accordance with the file name and number of copies settings recorded on the card.

With this camera, you can select images by viewing them on the monitor screen without needing to remember file names, their locations in memory, etc.



■ DPOF Settings

File Name,
number of copies,
date

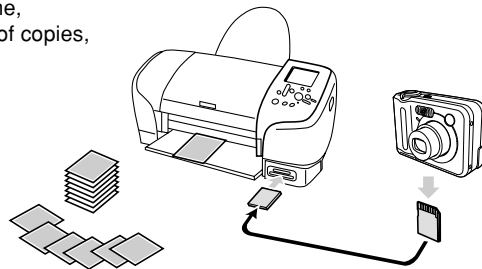

To configure print settings for a single image

1. In the **PLAY** mode, press **[MENU]**.

2. Select the “**PLAY**” tab, select “**DPOF**”, and then press **[▶]**.



3. Use **[▲]** and **[▼]** to select “**Select images**”, and then press **[▶]**.



4. Use **[◀]** and **[▶]** to display the image you want.



5. Use **[▲]** and **[▼]** to specify the number of copies.

- You can specify up to 99 for the number of copies. Specify 00 if you do not want to have the image printed.

6. To turn on date stamping for the prints, press **[DISP]** so  is displayed.

-  indicates that date stamping is turned on.
- To turn off date stamping for the prints, press **[DISP]** so  is not displayed.
- Repeat steps 4 through 6 if you want to configure other images for printing.

7. After all the settings are the way you want, press **[SET]** to apply them.



To configure print settings for all images

1. In the **PLAY** mode, press **[MENU]**.
2. Select the **“PLAY”** tab, select **“DPOF”**, and then press **[▶]**.
3. Use **[▲]** and **[▼]** to select **“All images”**, and then press **[▶]**.
4. Use **[▲]** and **[▼]** to specify the number of copies.

- You can specify up to 99 for the number of copies. Specify 00 if you do not want to have the image printed.



5. To turn on date stamping for the prints, press **[DISP]** so  is displayed.

-  indicates that date stamping is turned on.
- To turn off date stamping for the prints, press **[DISP]** so  is not displayed.

6. After all the settings are the way you want, press **[SET]** to apply them.

» IMPORTANT! ««

- If you take a memory card to a professional print service, be sure to tell them that it includes DPOF settings for the images to be printed and the number of copies. If you don't, they may print all images on the card, including the ones you do not want printed.
- Note that some professional print services do not support DPOF printing. Check with your service before ordering prints.
- Some printers may have settings that disable date stamp and/or DPOF printing. See the user documentation that comes with your printer for details about how to enable these features.

Using PictBridge or USB DIRECT-PRINT

You can connect the camera directly to a printer that supports PictBridge or USB DIRECT-PRINT, and perform image selection and printing using the camera monitor screen and controls. DPOF support (page 153) also lets you specify which images you want to print and how many copies of each should be printed.

- PictBridge is a standard established by the Camera and Imaging Products Association (CIPA).
- USB DIRECT-PRINT is a standard proposed by Seiko Epson Corporation.



▶▶ IMPORTANT! ◀◀

- Use of the optional AC adaptor (AD-C30) is recommended when printing with PictBridge or USB DIRECT-PRINT.

To print a single image

1. In the REC mode or the PLAY mode, press [MENU].
2. Select the "Set Up" tab, select "USB", and then press [▶].
3. Use [▲] and [▼] to select the setting you want, and then press [SET].

When connecting to this type of device:	Select this setting:
Computer or USB DIRECT-PRINT-compatible printer	Mass Storage (USB DIRECT-PRINT)
PictBridge-compatible printer	PTP (PictBridge)

- Mass Storage (USB DIRECT-PRINT) causes the camera to see the computer as an external storage device. Use this setting for normal transfer of images from the camera to a computer (using the bundled Photo Loader application).
- PTP (PictBridge) simplifies the transfer of image data to the connected device.

PRINTING IMAGES

4. Connect the optionally available AC adaptor to the camera.

- If you are using batteries to power the camera, check to make sure that the batteries are fully charged.
- Note that the camera does not draw any power over the USB cable.

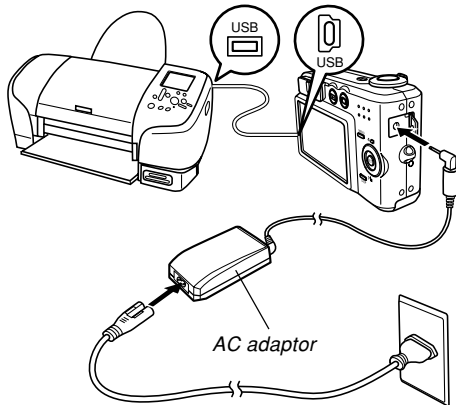

5. Use the USB cable that comes with the camera to connect the camera to a printer.

6. Turn on the printer.

7. Load paper for printing the images into the printer.

8. Press the camera's power button.

- This displays the print menu on the camera's monitor screen.

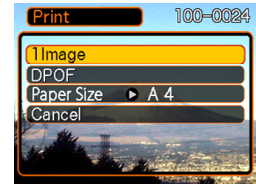

9. Use [▲] and [▼] to select "Paper Size", and then press [▶].

PRINTING IMAGES

10. Use [▲] and [▼] to select the paper size you want to use for printing, and then press [SET].

- The following are the print sizes that are available.
3.5" × 5"
5" × 7"
A4
4" × 6"
By Printer
- Selecting "By Printer" prints using the paper size selected on the printer.
- Available paper size settings depend on the connected printer. For full details, see the instructions that come with your printer.

11. On the print menu, use [▲] and [▼] to select "1 Image", and then press [SET].

- You can use [◀] and [▶] to select the image you want to print.
- You can toggle date stamping of the image on and off by pressing [DISP]. The  icon indicates that date stamping is turned on.

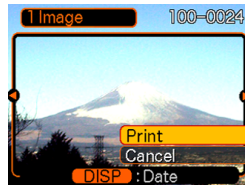

12. On the camera's monitor screen, use [▲] and [▼] to select "Print", and then press [SET].

- This starts printing and displays the message "Busy.... Please wait..." on the monitor screen. The message will disappear after a short while, even though printing is still being performed. Pressing any of the camera's buttons while printing is in progress will cause the message to reappear.
- The print menu will appear when printing is complete.
- To print again, repeat this step.

13. The camera will turn off automatically when printing is complete. After this happens, disconnect the USB cable from the camera.

To print a group of images

- 1. Use the DPOF procedure on page 153 to specify the images in file memory that you want to print.**
- 2. Perform steps 1 through 10 of the procedure under “To print a single image” on page 156.**
- 3. On the print menu, use [▲] and [▼] to select “DPOF”, and then press [SET].**
- 4. On the camera’s monitor screen, use [▲] and [▼] to select “Print”, and then press [SET].**
 - This starts printing and displays the message “Busy.... Please wait...” on the monitor screen. The message will disappear after a short while, even though printing is still being performed. Pressing any of the camera’s buttons while printing is in progress will cause the message to reappear.
 - The print menu will appear when printing is complete.
 - This automatically starts printing of the images you specified with the DPOF procedure.
- 5. To print again, repeat the above from step 3.**
 - A message appears on the monitor screen, followed by the DPOF setting screen (page 154), if there are no DPOF settings currently configured on the camera to control the printing operation. If this happens, configure the required DPOF settings and then try printing again.
- 6. The camera will turn off automatically when printing is complete. After this happens, disconnect the USB cable from the camera.**

Printing Precautions

- See the documentation that comes with your printer for information about print quality and paper settings.
- Contact your printer manufacturer for information about models that support PictBridge and USB DIRECT-PRINT, upgrades, etc.
- Never disconnect the USB cable, or perform any camera operation while printing is in progress. Doing so causes a printer error.

PRINT Image Matching III

Images include PRINT Image Matching III data (mode setting and other camera setup information). A printer that supports PRINT Image Matching III reads this data and adjusts the printed image accordingly, so your images come out just the way you intended when you recorded them.

- Seiko Epson Corporation holds the copyright for PRINT Image Matching and PRINT Image Matching III.



Exif Print

Exif Print is an internationally supported, open standard file format that makes it possible to capture and display vibrant digital images with accurate colors. With Exif 2.2, files include a wide range of shooting condition information that can be interpreted by an Exif Print printer to produce better-looking prints.

The logo for Exif Print features the words "Exif Print" in a bold, italicized, sans-serif font. Above the text, there is a decorative arc of seven small, solid black circles.

»» IMPORTANT! ««

- Information about the availability of Exif Print compatible printer models can be obtained from each printer manufacturer.

VIEWING IMAGES ON A COMPUTER

After using the USB cable to establish a USB connection between the camera and your computer, you can use your computer to view images in file memory and copy images to your computer's hard disk or other storage media. In order to do this, you first need to install the USB driver located on the CD-ROM that comes bundled with the camera onto your computer.

Note that the procedure you need to perform depends on whether you are using computer running under Windows (see below) or a Macintosh (see page 168).

Using the Camera with a Windows Computer

The following are the general steps for viewing and copying files from a computer running under Windows. You can find details about each operation in the procedures that follow below. Note that you should also refer to the documentation that comes with your computer for other information about USB connections, etc.

1. If you are running Windows 98, Me, or 2000, install the USB driver onto your computer.
 - You need to perform this step only once, the first time you connect to your computer.
 - If you are running Windows XP, you do not need to install the USB driver.



2. Use the USB cable to establish a connection between the camera and computer.



3. View and copy the images you want.

►► IMPORTANT! ◀◀

- Low battery power can cause the camera to power down suddenly during data communication. Use of the special AC adaptor is recommended to power the camera during data communication.
- If you want to transfer files from the camera's built-in memory to a computer, make sure there is no memory card loaded in the camera before you connect the USB cable.

Do not try to establish a connection between the camera and computer before installing the USB driver onto the computer. If you do, the computer will not be able to recognize the camera.

- USB driver installation is required in the case of Windows 98, Me, and 2000. Do not connect the camera to a computer running one of the above operating systems without installing the USB driver first.
- USB driver installation is not required in the case of Windows XP.

1. What you should do first depends on whether your computer is running under Windows 98, Me, 2000, or XP.

■ Windows 98/Me/2000 Users

- Start from step 2 to install the USB driver.
- Note that the example installation presented here uses Windows 98.

■ Windows XP Users

- Installation of the USB driver is not required, so jump directly to step 6.

2. Set the bundled CD-ROM into the CD-ROM drive of your computer.

3. On the menu screen that appears, click "English".

VIEWING IMAGES ON A COMPUTER

4. Click [USB driver] and then [Install].

- This starts installation.
- The following steps show installation under the English version of Windows.

5. On the screen that appears after installation is complete, select the “Yes, I want to restart my computer now.” check box and then click [Finish] to restart your computer.

- Note that you should leave the bundled CD-ROM in your computer’s CD-ROM drive when you restart.

6. Connect the optional AC adaptor to the [DC IN 3V] connector of the camera, and then plug it in to a household power outlet.

- If you are using batteries to power the camera, check to make sure that the batteries are fully charged.

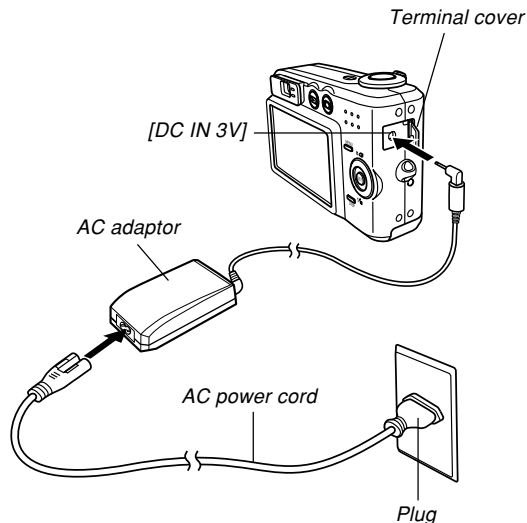

VIEWING IMAGES ON A COMPUTER

7. Turn on the camera, and then press [MENU].
 - It makes no difference whether the camera is in the REC mode or PLAY mode.
8. Select the “Set Up” tab, select “USB”, and then press [▶].
9. Use [▲] and [▼] to select “Mass Storage (USB DIRECT-PRINT)”, and then press [SET].

10. Turn off the camera, and connect the USB cable that comes bundled with the camera to the camera and your computer’s USB port.

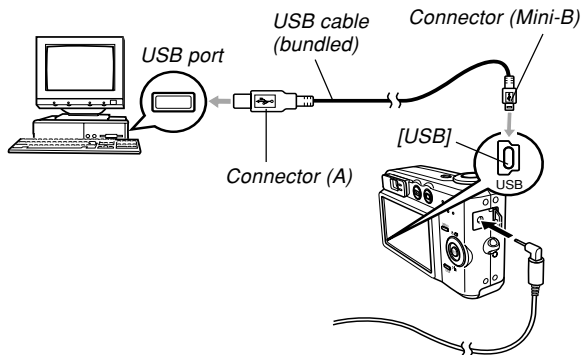

- Take care when connecting the USB cable to the camera or your computer. USB ports and cable plugs are shaped for proper positioning.
- Plug the USB cable plugs into the ports securely, as far as they will go. Proper operation is not possible if connections are not correct.

11. Turn on the camera.

- This will cause the “New Hardware...” dialog box to appear on the computer screen as the computer automatically detects the camera’s file memory. After you install the USB driver, “New Hardware...” dialog box will no longer appear when you perform the above steps to establish a USB connection.
- The camera’s green operation lamp lights (page 196).

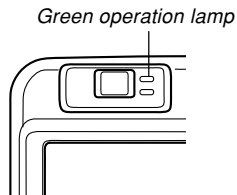

- At this point, some operating systems will display a “Removable Disk” dialog box. If your operating system does, close the dialog box.

12. On your computer, double-click “My Computer”.

- If you are running Windows XP, click [Start] and then [My Computer].

13. Double-click “Removable Disk”.

- Your computer sees the camera’s file memory as a removable disk.

14. Double-click the “Dcim” folder.

15. Double-click the folder that contains the image you want.

16. Double-click the file that contains the image you want to view.

- For information about file names, see “Memory Folder Structure” on page 174.

17. Depending on your operating system, perform one of the following procedures to save the files, if you want.

■ Windows 98, 2000, Me

1. In the camera's file memory (Removable Disk), right-click the "Dcim" folder.
 2. On the shortcut menu that appears, click [Copy].
 3. Double click [My Documents] to open it.
 4. On the My Documents [Edit] menu, click [Paste].
- This copies the "Dcim" folder (which contains the image files) to your "My Documents" folder.

■ Windows XP

1. In the camera's file memory (Removable Disk), right-click the "Dcim" folder.
 2. On the shortcut menu that appears, click [Copy].
 3. Click [Start] and then [My Documents].
 4. On the My Documents [Edit] menu, click [Paste].
- This copies the "Dcim" folder (which contains the image files) to your "My Documents" folder.

▶▶ IMPORTANT! ◀◀

- Never use your computer to edit, delete, move, or rename images stored in file memory. Doing so can cause problems with the image management data used by the camera, which may make it impossible to display images on the camera or it may cause a large error in the number of images value displayed by the camera. Always copy images to your computer memory before performing any edit, delete, move, or rename operation.

18. Depending on the version of Windows you are running, use one of the following procedures to terminate the USB connection.

■ Windows Me/98/XP Users

- Press the camera's power button. After making sure that the camera's green operation lamp is not lit, disconnect the camera from the computer.

■ Windows 2000 Users

- Click card services in the task tray on your computer screen, and disable the drive number assigned to the camera. Next, disconnect the USB cable from the camera, and then turn off the camera.

USB Connection Precautions

- Do not leave the same image displayed on your computer screen for a long time. Doing so can cause the image to “burn in” on the screen.
- Never disconnect the USB cable, or perform any camera operation while data communication is in progress. Doing so can cause data to become corrupted.

Using the Camera with a Macintosh Computer

The following are the general steps for viewing and copying files from a Macintosh.

You can find details about each operation in the procedures that follow below. Note that you should also refer to the documentation that comes with your Macintosh for other information about USB connections, etc.

►► IMPORTANT! ◀◀

- This camera does not support operation on a computer running Mac OS 8.6 or lower, or Mac OS X 10.0. If you have a Macintosh running Mac OS 9 or OS X (10.1, 10.2, or 10.3), use the standard USB driver that comes with your OS.

1. Use the USB cable to establish a connection between the camera and your Macintosh.



2. View and copy the images you want.

VIEWING IMAGES ON A COMPUTER

▶▶ IMPORTANT! ◀◀

- Low battery power can cause the camera to power down suddenly during data communication. Use the optional AC adaptor is recommended to power the camera during data communication with a computer.
- If you want to transfer files from the camera's built-in memory to a computer, make sure there is no memory card loaded in the camera before you connect the USB cable.

1. Connect the optional AC adaptor to the [DC IN 3V] connector of the camera, and then plug it in to a household power outlet.

- If you are using batteries to power the camera, check to make sure that the batteries are fully charged.

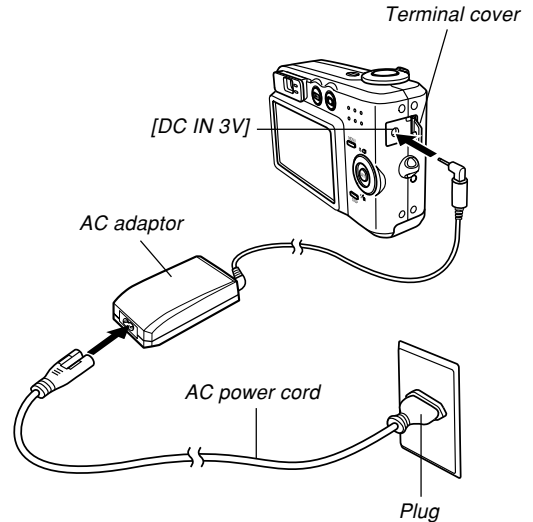

VIEWING IMAGES ON A COMPUTER

2. Turn on the camera, and then press [MENU].
 - It makes no difference whether the camera is in the REC mode or PLAY mode.
3. Select the “Set Up” tab, select “USB”, and then press [▶].
4. Use [▲] and [▼] to select “Mass Storage (USB DIRECT-PRINT)”, and then press [SET].

5. Turn off the camera, and connect the USB cable that comes bundled with the camera to the camera and your computer’s USB port.

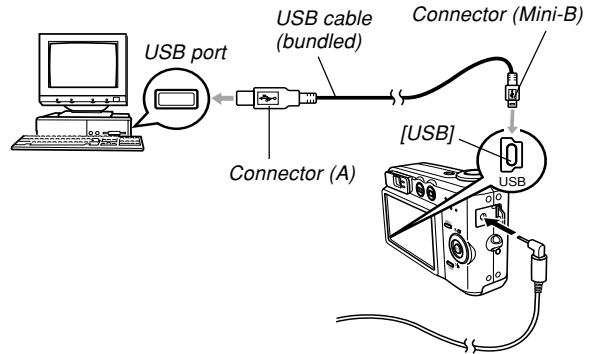

- Take care when connecting the USB cable to the camera or your computer. USB ports and cable plugs are shaped for proper positioning.
- Plug the USB cable plugs into the ports securely, as far as they will go. Proper operation is not possible if connections are not correct.

6. Turn on the camera.

- Your Macintosh will see the camera's file memory as a drive.
- The appearance of the drive icon depends on the Mac OS version you are using.
- After installing the USB driver, your Macintosh will see the camera's file memory as a drive whenever you establish a USB connection between them.

7. Double-click the drive icon for the camera's file memory, the "DCIM" folder, and then the folder that contains the image you want.

8. Double-click the file that contains the image you want to view.

- For information about file names, see "Memory Folder Structure" on page 174.

9. To copy all the files in file memory to your Macintosh hard disk, drag the "DCIM" folder to the folder to which you want to copy it.

»» IMPORTANT! ««

- Never use your computer to edit, delete, move, or rename images stored in the camera's file memory. Doing so can cause problems with the image management data used by the camera, which may make it impossible to display images on the camera or it may cause large error in the number of images value displayed by the camera. Always copy images to your computer before performing any edit, delete, move, or rename operation.

10. To terminate the USB connection, drag the drive icon that represents the camera to Trash. Next, disconnect the USB cable from the camera, and then turn off the camera.

USB Connection Precautions

- Do not leave the same image displayed on your computer screen for a long time. Doing so can cause the image to “burn in” on the screen.
- Never disconnect the USB cable, or perform any camera operation while data communication is in progress. Doing so can cause data to become corrupted.

Operations You Can Perform from Your Computer

The following are the operations you can perform while there is a USB connection between your camera and computer. See the referenced pages for more information about each operation.

- View images in album format
.... See “Using the Album Feature” on page 177.
- Print images in album format
.... See “Using the Album Feature” on page 177.
- Automatically transfer images to your computer and manage images
.... See “Installing the Software from the CD-ROM” on page 185 for information about installing Photo Loader.
- Retouch images
.... See “Installing the Software from the CD-ROM” on page 185 for information about installing Photohands.

Using a Memory Card to Transfer Images to a Computer

The procedures in this section describe how to transfer images from the camera to your computer using a memory card.

Using a Computer with a Built-in SD Memory Card Slot

Insert the SD memory card directly into the slot.

Using a Computer with a Built-in PC Card Slot

Use a commercially available PC card adaptor (for an SD memory card or MMC).

See the user documentation that comes with the PC card adaptor and your computer for details about how to use them.

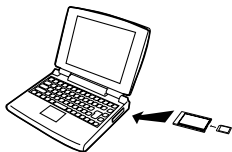

Using a Commercially Available SD Memory Card Reader/Writer

See the user documentation that comes with the SD memory card reader/writer for details about how to use it.

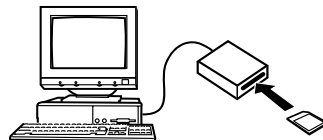

Using a Commercially Available PC Card Reader/Writer and PC Card Adaptor (for an SD memory card or MMC)

See the user documentation that comes with the PC card reader/writer and PC card adaptor for details about how to use them.

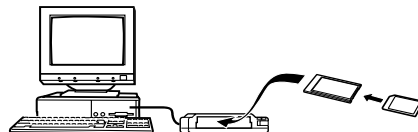

Memory Data

Images recorded with this camera and other data are stored in memory using DCF (Design rule for Camera File system) protocol. DCF protocol is designed to make it easier to exchange image and other data between digital cameras and other devices.

DCF Protocol

DCF devices (digital cameras, printers, etc.) can exchange images with each other. DCF protocol defines a format for image file data and the folder structure for file memory, so images can be viewed using another manufacturer's DCF camera or printed on a DCF printer.

Memory Folder Structure

■ Folder Structure

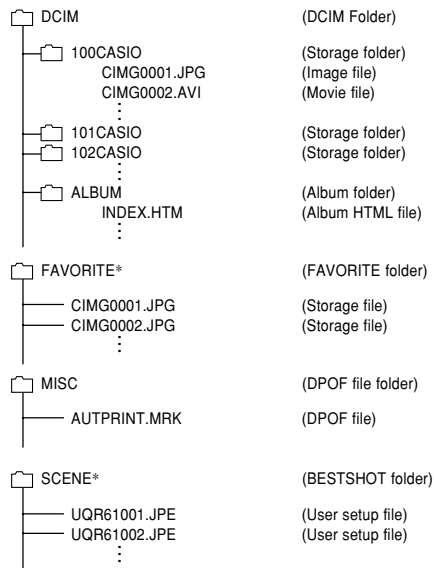

* These folders are created in built-in memory only.

■ Folder and File Contents

- DCIM folder
Folder that stores all of the digital camera files
- Storage folder
Folder for storing files created by the digital camera
- Image file
File that contains an image recorded with the digital camera (File Name Extension: JPG)
- Movie file
File that contains a movie recorded with the digital camera (File Name Extension: AVI)
- Album folder
Folder that contains files used by the album function
- Album HTML file
File used by the album function
(File Name Extension: HTM)
- FAVORITE folder
Folder that contains Favorites image files
(Image Size: 320 × 240 pixels)
- DPOF file folder
Folder that contains DPOF files
- BESTSHOT folder (Built-in memory only)
Folder that contains BESTSHOT user setup files
- User setup files (Built-in memory only)
Files that contain BESTSHOT user setups

Image Files Supported by the Camera

- Image files recorded with this camera
- DCF protocol image files

Certain DCF functions may not be supported. When displaying an image recorded on another camera model, it may take a long time for the image to appear on the display.

Built-in Memory and Memory Card Precautions

- Note that the folder named “DCIM” is the parent (top) folder of all the files in memory. When transferring memory contents to a hard disk, CD-R, MO disk, or other external storage, treat all the contents inside a DCIM folder as a set and always keep them together. You can change the name of the DCIM folder on your computer. Changing the name to a date is a good way to keep track of multiple DCIM folders. However, if you even want to copy the folders back to the camera’s file memory, be sure you change the name of the DCIM folder back to “DCIM” first. The camera does not recognize any folder name other than DCIM.

USING THE CAMERA WITH A COMPUTER

The album feature of the camera creates files that make it possible for you to view images on your computer in a photo album layout. You can also use the applications contained on the CD-ROM that comes bundled with the camera to automate image transfer and to retouch images.

Using the Album Feature

The album feature creates an HTML photo album layout that displays your images. You can use the HTML layout to post your images on a Web page, or for printing the images.

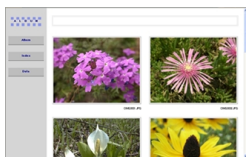

Album

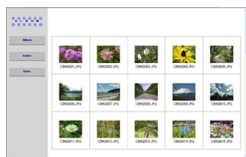

Index



Info

- You can use the Web browser shown below to view or print the contents of an album. Note that to view a movie on a computer running Windows 2000 or 98, you need to install DirectX from the bundled CD-ROM.

Microsoft Internet Explorer Ver 5.5 or later

Creating an album

▶▶ IMPORTANT! ◀◀

- Remember that creating an "ALBUM" folder (page 174) causes different size versions of each image to be created in memory. If there is an "ALBUM" folder in image memory when you specify printing of all images by a professional print service or on a printer, you may end up with unwanted multiple prints of the same image. To avoid this problem, use the procedure under "To delete an album" on page 185 to delete the ALBUM folder.

1. In the PLAY mode, press [MENU].

2. Select the “PLAY” tab, select “Create Album”, and then press [▶].

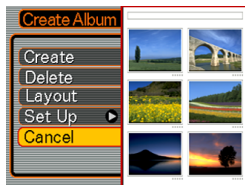

Sample layout

3. Use [▲] and [▼] to select “Create”, and then press [SET].

- This starts creation of the album, and causes the message “Busy....Please wait...” to appear on the monitor screen.
- The PLAY mode screen reappears after creation of the album is complete.
- Creating an album causes a file folder named “ALBUM”, which contains a file named “INDEX.HTM” plus other files to be created in camera memory or on the memory card.

▶▶ IMPORTANT! ◀◀

- Never open the battery compartment cover or remove the memory card from the camera while an album is being created. Doing so not only runs the risk of certain album files being skipped, it can also result in image data and other data in memory being corrupted.
- If memory becomes full while an album is being created, the message “Memory Full” appears on the monitor screen and album creation is terminated.
- Album creation will not be performed properly if the batteries go dead while album creation is in progress.
- Pressing [SET] in step 3 of the above procedure creates an album regardless of whether auto album creation is turned on or off (page 181).
- Images in the “ALBUM” folder (page 174) cannot be viewed on the camera’s monitor screen.

Selecting an Album Layout

You can select from among 10 different display layouts for an album.

1. In the **PLAY** mode, press [MENU].
2. Select the “**PLAY**” tab, select “**Create Album**”, and then press [▶].
3. Use [▲] and [▼] to select “**Layout**”.
4. Use [◀] and [▶] to select the layout you want.
 - Changing the layout causes the layout sample on the right side of the screen to change.

▶▶ IMPORTANT! ◀◀

- The sample layout shows the arrangement of items and the background color. It does not show whether the layout uses a list view or detailed view, or the current Image Type setting.

Configuring Detailed Album Settings

1. In the **PLAY** mode, press [MENU].
2. Select the “**PLAY**” tab, select “**Create Album**”, and then press [▶].
3. Use [▲] and [▼] to select “**Set Up**”, and then press [▶].
4. Use [▲] and [▼] to select the item whose setting you want to change, and then press [▶].
 - Details about each of the settings are provided in the following sections.
5. Use [▲] and [▼] to change the setting, and then press [SET].



■ Background Color

You can specify white, black, or gray as the color of the album background using the procedure under “Configuring Detailed Album Settings”.

■ Album Type

There are two album types: “Normal” and “Index/Info”.

“Normal” Type : This type of album displays images in accordance with the currently selected layout.

“Index/Info” Type : In addition to the normal album screen, this type of album also includes thumbnails of images and detailed information about each image.

■ Image Use

This setting lets you select from among three different image uses, as described below. Select the image use that best suits the way you plan to use the image.

For this purpose:	Select this setting:
<p>Smaller images for album browsing, Website thumbnails, or archiving on a CD-R or other media, with the full-size image displayed when a thumbnail is clicked</p> <ul style="list-style-type: none"> This setting can be used for browsing with the thumbnails. Clicking a thumbnail displays a larger version for viewing or printing. 	View
<p>Small image files only for album browsing, or uploading to a Website, etc.</p> <ul style="list-style-type: none"> This option displays only the small-file images (located in the camera’s “ALBUM” folder). Smaller files upload to the Internet faster. You cannot enlarge images by clicking a thumbnail or play movies while this image is selected. 	WEB
<p>Printing (high resolution)</p> <ul style="list-style-type: none"> High-resolution images take longer to display on your computer screen. You cannot enlarge images by clicking a thumbnail or play movies while this image is selected. 	Print

■ Auto Album Creation On/Off

This setting controls whether an album is created automatically whenever you turn off the camera.

To do this:	Select this option:
Turn on auto album creation	On
Turn off auto album creation	Off

- When auto album creation is turned on, an album is created automatically in built-in memory or on the memory card whenever you turn off the camera.

»» IMPORTANT! ««

- When you turn off the camera while auto album creation is turned on, the monitor screen turns off, but the operation lamp continues to flash for a few seconds to indicate that the album creation process is being performed. Never open the battery compartment cover or remove the memory card while the green operation lamp is flashing.

»» NOTE ««

- Depending on the number of images in memory, it can take quite a bit of time to complete auto album creation when you turn off the camera. If you do not plan to use the album feature, we suggest that you keep auto album creation turned off, which shortens the amount of time the camera takes to power down completely.

Viewing Album Files

You can view and print album files using your computer's Web browser application.

1. Use your computer to access the data in built-in memory or on the memory card, or access a memory card with your computer (pages 162, 173).
2. Open the built-in memory "ALBUM" folder or the memory card "ALBUM" folder, which is located inside the folder named "DCIM".
3. Use your computer's Web browser to open the file named "INDEX.HTM".

- This displays a list of folders in built-in memory or on the memory card.

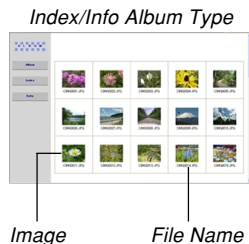

4. If you created the album after selecting "Normal" type or "Index/Info" as the album type under "Configuring Detailed Album Settings" on page 179, you can click one of the following display options.

Album : Displays an album created by the camera.

Index : Displays a list of images stored in a folder.

Info : Displays information about each image.

- If "View" is selected for "Use" (page 180), you can double-click an image on your computer screen to display the full-size version.

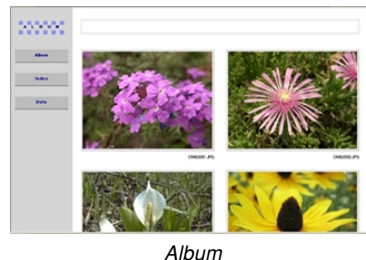

USING THE CAMERA WITH A COMPUTER



Index



Info

- The following describes the information that appears on the Info Screen.

This Info Screen item:	Shows this:
File Size	Image file size
Resolution	Resolution
Quality	Quality
Recording mode	Recording mode
AE	Exposure mode
Light metering	Metering mode
Shutter speed	Shutter speed
Aperture stop	Aperture stop
Exposure comp	EV shift
Focusing mode	Focusing mode
Flash mode	Flash mode
AF area	Auto Focus area
Sharpness	Sharpness
Saturation	Saturation
Contrast	Contrast
White balance	White balance
Sensitivity	Sensitivity
Filter	Filter setting
Enhancement	Enhancement setting
Flash intensity	Flash intensity
Digital zoom	Digital zoom setting
World	Location
Date	Recording date and time
Model	Camera model name

»» NOTE ««

- When printing an album page, you should set up your Web browser as described below.
 - Select the browser frame where the images are located.
 - Set margins to the lowest possible values.
 - Set the background color to a printable color.
- See the user documentation that came with your Web browser application for details about printing and configuring settings for printing.
- Album contents (titles, comments, etc.) cannot be edited on the camera. Use a commercially available HTML file editor to edit album contents.

5. After you are finished viewing the album, exit your Web browser application.

Saving an Album

- To save an album, copy the “DCIM” folder from camera memory or the memory card to your computer’s hard disk, a CD-R, an MO disk, or some other storage medium. Note that copying only the “ALBUM” folder, does not copy image data and other necessary files.
- After copying the “DCIM” folder, do not change or delete any of the files inside of it. Adding new images or deleting existing images may lead to abnormal album display.
- If you plan to use a memory card again after saving its album, first delete all of its files or format it before loading it into the camera.
- When you have “WEB” selected for the “Use” setting, the album shows only the smaller image files stored in the “ALBUM” folder. Such images can be uploaded to the Internet more quickly.

To delete an album

1. In the **PLAY** mode, press **[MENU]**.
2. Select the “**PLAY**” tab, select “**Create Album**”, and then press **[▶]**.
3. Use **[▲]** and **[▼]** to select “**Delete**”, and then press **[SET]**.
 - This deletes the album and returns to the **PLAY** mode screen.

Installing the Software from the CD-ROM

Your digital camera comes bundled with useful applications for using it in combination with a computer. Install the applications you need on your computer.

About the bundled CD-ROM

The CD-ROM that comes bundled with the camera contains the applications described below. Installation of these applications is optional, and you should install only the ones you want to use.

USB Driver for Mass Storage (for Windows)

This is the software that makes it possible for the camera to “talk” to your personal computer over a USB connection. If you are using Windows XP, do not install the USB driver from the CD-ROM. With Windows XP, you will be able to perform USB communication simply by connecting the camera to your computer with the USB cable.

Photo Loader (for Windows/Macintosh)

This application automatically transfers image files from the camera to your computer. Photo Loader automatically stores transferred files in folders named using the current date (year, month, day) and generates HTML files that make it possible to view images using a web browser. Photo Loader (Windows version only) also includes a feature that simplifies the task of attaching images to e-mail.

- See the user documentation file (PDF) on the bundled “CASIO Digital Camera Software” CD-ROM for details about using Photo Loader.

Photohands (for Windows)

Photohands includes retouching tools for adjusting image color, contrast, and brightness, for resizing images, and for changing image orientation. You can also use Photohands for printing images and for adding a date stamp to printed images.

- See the user documentation file (PDF) on the bundled “CASIO Digital Camera Software” CD-ROM for details about using Photohands.

DirectX (for Windows)

This software provides an extended tool set including a codec that allows Windows 98 and 2000 to handle movie files recorded using a digital camera. You do not need to install DirectX if you are running Windows XP or Me.

Adobe Reader (for Windows)

This is an application that lets you read PDF files. Use it to read the user documentation for the camera, Photo Loader, and Photohands, all of which is included on the bundled CD-ROM.

- See the user documentation files (PDF) on the bundled CD-ROM for details about using Photo Loader and Photohands. See “Viewing User Documentation (PDF files)” on page 190 (Windows) and page 192 (Macintosh) of this manual for more information.

Computer System Requirements

Computer system requirements depend on each of the applications, as described below.

Windows

	USB Driver* ¹	Photo Loader	Photohands
OS	XP* ² /2000/Me/98	XP/2000/Me/98	XP/2000/Me/98
Memory	–	At least 16MB	At least 64MB
HD	–	At least 7MB	At least 10MB

*¹ In the case of Windows 2000, you need to install a data file that enables use of the operating system's standard USB driver. You do not need to install a special USB driver. Proper operation is not guaranteed on a computer that has been upgraded from Windows 95 or 3.1 to Windows Me or 98, or from Windows 95 or NT to Windows 2000.

*² With Windows XP, use the USB driver that comes with the operating system. You do not need to install the USB driver that comes with the camera.

Macintosh

	Photo Loader
OS	9
Memory	At least 32MB
HD	At least 3MB

- USB connection is supported on a Macintosh running OS 9, 10.1, 10.2, or 10.3. Operation is supported using the standard USB driver that comes with the operating system, so all you need to do is connect the camera to your Macintosh using the USB cable.

►► IMPORTANT! ◀◀

- For details about Windows minimum system requirements, see the “Readme” file on the CD-ROM (CASIO Digital Camera Software) that comes bundled with the camera.
- For details about Macintosh minimum system requirements, use a Web browser application to read the contents of the “readme” file on the CD-ROM (CASIO Digital Camera Software) that comes bundled with the camera.
- The software on the CD-ROM (CASIO Digital Camera Software) that comes bundled with the camera does not support operation under Mac OS X (10.0).

Installing Software from the CD-ROM in Windows

Use the procedures in this section to install the software from the bundled CD-ROM to your computer.

►► NOTE ◀◀

- If you already have one of the bundled applications installed on your computer, check its version. If the bundled version is newer than the one you have, uninstall the old version and then install the newer version.

The CD-ROM includes the software and user documentation for various languages. Check the CD-ROM menu screen to see if applications and user documentation are available for a particular language.

Getting Started

Start up your computer and insert the CD-ROM into its CD-ROM drive. This will automatically launch the menu application, which displays a menu screen on your computer.

- The menu application may not start up automatically on some computers. If this happens, navigate to the CD-ROM and double-click “menu.exe” to launch the menu application.

Selecting a Language

First select a language. Note that some software is not available in all languages.

- 1. On the menu screen, click the tab for the language you want.**

Viewing the Contents of the “Read me” File

You should always read the “Read me” file for any application before installing it. The “Read me” file contains information you need to know when installing the application.

- 1. Click the “Read me” button for the application you are going to install.**

►► IMPORTANT! ◀◀

- Before upgrading or reinstalling Photo Loader, or before installing it onto another computer, be sure to read the “Read me” file for information about retaining existing libraries.

Installing an Application

1. Click the “Install” button for the application you want to install.
2. Follow the instructions that appear on your computer screen.

»» IMPORTANT! ««

- Be sure to follow the instructions carefully and completely. If you make a mistake when installing Photo Loader, you may not be able to browse your existing library information and HTML files that are created automatically by Photo Loader. In some cases, image files may be lost.
- When using an operating system other than Windows XP, never connect the camera to your computer without installing the USB driver from the CD-ROM first.

Viewing User Documentation (PDF Files)

1. In the “Manual” area, click the name of the manual you want to read.

»» IMPORTANT! ««

- You need to have Adobe Reader installed on your computer to read user documentation files. If you do not already have Adobe Reader installed, you can install it from the bundled CD-ROM.

User Registration

You can perform user registration over the Internet. To do so, of course, you need to be able to connect to the Internet with your computer.

1. Click the “Register” button.

- This starts up your Web browser and accesses the user registration website. Follow the instructions that appear on your computer screen to register.

Exiting the Menu Application

1. On the menu screen, click “Exit” to exit the menu.

Installing Software from the CD-ROM on a Macintosh

Use the procedures in this section to install the software from the bundled CD-ROM to your computer.

Installing Software

Use the following procedures to install the software.

■ To install Photo Loader

1. Open the folder named “Photo Loader”.
2. Open the folder named “English”, and then open the file named “Important”.
3. Open the folder named “Installer”, and then open the file named “readme”.
4. Follow the instructions in the “readme” file to install Photo Loader.

►► IMPORTANT! ◀◀

- If you are upgrading to the new version of Photo Loader from a previous version and you want to use library management data and HTML files created using the old version of Photo Loader, be sure to read the “Important” file in the “Photo Loader” folder. Follow the instructions in the file to use your existing library management files. Failure to follow this procedure correctly can result in loss or corruption of your existing files.

Viewing User Documentation (PDF Files)

To perform the following procedures, you must have Adobe Reader installed on your Macintosh. You can download the latest version of Adobe Reader by visiting the Adobe Systems website.

■ To view the camera user’s guide

1. On the CD-ROM, open the “Manual” folder.
2. Open the “Digital Camera” folder, and then open the folder for the language whose user’s guide you want to view.
3. Open the file named “camera_xx.pdf”.
 - “xx” is the language code (Example: camera_e.pdf is for English, camera_g.pdf is for German, etc.).

■ To view the Photo Loader user's guide

1. On the CD-ROM, open the "Manual" folder.
2. Open the "Photo Loader" folder and then open the "English" folder.
3. Open "PhotoLoader_english".

■ To register as a camera user

Internet registration only is supported. Visit the following CASIO website to register:

<http://world.casio.com/qv/register/>

APPENDIX

Menu Reference

The following shows lists of menus that appear in the REC mode and PLAY mode, and their settings.

- The settings that are underlined in the following table are initial defaults.

■ REC mode

● REC tab menu

REC Mode	Snapshot / BESTSHOT / Movie
Continuous	On / <u>Off</u>
Self-timer	10 sec / 2 sec / X3 / <u>Off</u>
Size	<u>2816 × 2112</u> / 2816 × 1872 (3:2) / 2048 × 1536 / 1600 × 1200 / 1280 × 960 / 640 × 480
Quality	Fine / <u>Normal</u> / Economy
EV Shift	-2.0 / -1.7 / -1.3 / -1.0 / -0.7 / -0.3 / <u>0.0</u> / +0.3 / +0.7 / +1.0 / +1.3 / +1.7 / +2.0
White Balance	Auto / (Daylight) / (Cloudy) / (Shade) / (Fluorescent 1) / (Fluorescent 2) / (Tungsten) / Manual
ISO	<u>Auto</u> / ISO 64 / ISO 125 / ISO 250 / ISO 500
AF Area	<u>Spot</u> / Multi
Metering	<u>Multi</u> / Center weighted / Spot
Filter	<u>Off</u> / B/W / Sepia / Red / Green / Blue / Yellow / Pink / Purple

Sharpness	+2 / +1 / <u>0</u> / -1 / -2
Saturation	+2 / +1 / <u>0</u> / -1 / -2
Contrast	+2 / +1 / <u>0</u> / -1 / -2
Flash Intensity	+2 / +1 / <u>0</u> / -1 / -2
Flash Assist	Auto / <u>Off</u>
Grid	On / <u>Off</u>
Digital Zoom	<u>On</u> / Off
Review	<u>On</u> / Off
Icon Help	<u>On</u> / Off
L/R Key	REC Mode / EV shift / White Balance / ISO / Self-timer / <u>Off</u>

● Memory tab menu

REC Mode	<u>On</u> / Off
Flash	<u>On</u> / Off
Focus	On / <u>Off</u>
White Balance	On / <u>Off</u>
ISO	On / <u>Off</u>
AF Area	<u>On</u> / Off
Metering	On / <u>Off</u>
Self-timer	On / <u>Off</u>
Flash Intensity	On / <u>Off</u>
Digital Zoom	<u>On</u> / Off
MF Position	On / <u>Off</u>
Zoom Position	On / <u>Off</u>

APPENDIX

● Set Up tab menu

Beep	<u>On</u> / Off
Startup	On (Selectable image) / <u>Off</u>
File No.	<u>Continue</u> / Reset
World Time	<u>Home</u> / World
	Home time setup (city, DST, etc.)
	World Time setup (city, DST, etc.)
Date Style	YY/MM/DD / DD/MM/YY / MM/DD/YY
Adjust	Time setting
Language	日本語 / English / Français / Deutsch / Español / Italiano / Português / 中國語 / 中国語 / 한국어
Sleep	30 sec / <u>1 min</u> / 2 min / Off
Auto Power Off	<u>2 min</u> / 5 min
REC / PLAY	<u>Power On</u> / Power On/Off / Disable
USB	<u>Mass Storage (USB DIRECT-PRINT)</u> / PTP
Format	Format / <u>Cancel</u>
Reset	Reset / <u>Cancel</u>

■ PLAY mode

● PLAY tab menu

Slideshow	<u>Start</u> / Images / Time / Interval / Cancel
Favorites	<u>Show</u> / Save / Cancel
DPOF	<u>Select images</u> / All images / Cancel
Protect	<u>On</u> / All Files : On / Cancel
Rotation	<u>Rotate</u> / Cancel
Resize	<u>1600 × 1200</u> / 1280 × 960 / 640 × 480 / Cancel
Trimming	–
Create Album	Create / Delete / Layout / Set Up / <u>Cancel</u>
Alarm	Alarm setups
Copy	<u>Built-in</u> → Card / Card → Built-in / Cancel

● Set Up tab menu

Beep	On / Off
Startup	On (Selectable image) / <u>Off</u>
File No.	<u>Continue</u> / Reset
World Time	<u>Home</u> / World
	Home time setup (city, DST, etc.)
	World Time setup (city, DST, etc.)
Date Style	YY/MM/DD / DD/MM/YY / MM/DD/YY
Adjust	Time setting
Language	日本語 / English / Français / Deutsch / Español / Italiano / Português / 中國語 / 中国語 / 한국어
Sleep	30 sec / <u>1 min</u> / 2 min / Off
Auto Power Off	<u>2 min</u> / 5 min
REC / PLAY	Power On / Power On/Off / Disable
USB	<u>Mass Storage (USB DIRECT- PRINT)</u> / PTP (PictBridge)
Format	Format / <u>Cancel</u>
Reset	Reset / <u>Cancel</u>

Indicator Lamp Reference

The camera has three indicator lamps: a green operation lamp, a red operation lamp, and a self-timer lamp. These lamps light and flash to indicate the current operational status of the camera.

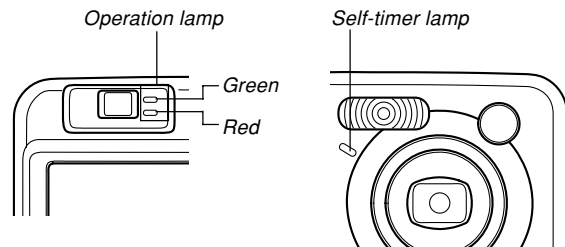

* There are three lamp flash patterns. Pattern 1 flashes once per second, Pattern 2 flashes twice per second, and Pattern 3 flashes four times per second. The table below explains what each flash pattern indicates.

REC mode

Operation Lamp		Self-timer Lamp	Meaning
Green	Red	Red	
Lit			Operational (Power on, recording enabled)
	Pattern 3		Flash is charging.
	Lit		Flash charging is complete.
Lit			Auto Focus operation was successful.
Pattern 3			Cannot Auto Focus.
Lit			Monitor screen is off.
Pattern 2			Storing image
Pattern 1			Storing movie data / processing image data
		Pattern 1	Self-timer countdown (10 to 3 seconds)
		Pattern 2	Self-timer countdown (3 to 0 seconds)
	Pattern 1		Cannot charge flash.
	Pattern 2		Memory card problem / Memory card is unformatted. / BESTSHOT setup cannot be registered.
	Lit		Memory card is locked. / Cannot create folder. / Memory is full. / Write error

Operation Lamp		Self-timer Lamp	Meaning
Green	Red	Red	
	Pattern 3		Low battery alert
Pattern 3			Formatting card
Pattern 3			Powering down
Lit			USB connection

▶▶ IMPORTANT! ◀◀

- When you are using a memory card, never remove the card from the camera while the green operation lamp is flashing. Doing so will cause recorded images to be lost.

PLAY mode

Operation Lamp		Self-timer Lamp	Meaning
Green	Red	Red	
Lit			Operational (Power on, recording enabled)
Pattern 3			One of the following operations is being performed: delete, DPOF, image protect, copy, album creation, format, power down
	Pattern 2		Memory card problem / Memory card is unformatted.
	Lit		Memory card is locked. / Cannot create folder. / Memory is full.
	Pattern 3		Low battery alert
Lit			USB connection

Charger Unit

The charger unit has a [CHARGE] lamp that lights or flashes in accordance with the charger unit operation that is being performed.

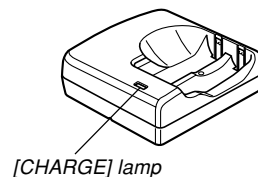



[CHARGE] lamp	Meaning
Lit	Charging
Unlit	Charging complete
Pattern A	Charge standby state (Ambient temperature is too high or too low.)
Pattern B	Charger unit or battery abnormality

* There are two lamp flash patterns. Pattern A flashes once every 1.6 seconds, Pattern B flashes once every 0.4 second.

Troubleshooting Guide

	Symptom	Possible Cause	Action
Power Supply	Power does not turn on.	<ol style="list-style-type: none"> 1) The batteries are not oriented correctly. 2) The batteries are dead. 3) You are using the wrong type of AC adaptor. 	<ol style="list-style-type: none"> 1) Orient the batteries correctly (page 39). 2) Charge the batteries (page 34). If the batteries go dead soon after being charged, it means they have reached the end of their life and need to be replaced. Purchase separately available rechargeable nickel-metal hydride batteries (HR-3U), or replace the batteries with other ones. 3) Use only the type of AC adaptor (AD-C30) specified for this camera.
	Camera suddenly powers down.	<ol style="list-style-type: none"> 1) Auto Power Off activated (page 46). 2) The batteries are dead. 	<ol style="list-style-type: none"> 1) Turn power back on. 2) Charge or replace the batteries.
Image Recording	Image is not recorded when the shutter button is pressed.	<ol style="list-style-type: none"> 1) The camera is in the PLAY mode. 2) Flash unit is being charged. 3) Memory is full. 	<ol style="list-style-type: none"> 1) Press  (REC) to enter the currently selected recording mode. 2) Wait until the flash unit finishes charging. 3) Transfer files you want to keep to your computer and then delete files from image memory, or use a different memory card.

APPENDIX

	Symptom	Possible Cause	Action
Image Recording	Auto Focus does not focus properly	<ol style="list-style-type: none"> 1) The lens is dirty. 2) The subject is not located in the center of the focus frame when you compose the image. 3) The subject you are shooting is a type that is not compatible with Auto Focus operation (page 73). 4) You are moving the camera. 	<ol style="list-style-type: none"> 1) Clean the lens. 2) Make sure the subject is centered in the focus frame when composing the image. 3) Use manual focus (page 76). 4) Mount the camera on a tripod.
	The subject is out of focus in the recorded image.	The image is not focused properly.	When composing the image, make sure the subject on which you want to focus is located inside the focus frame.
	The flash does not fire.	<ol style="list-style-type: none"> 1)  (flash off) is selected as the flash mode. 2) The batteries are dead. 3) The camera is in the Movie mode. 4) A scene that selects  (flash off) as the flash mode is selected in the BESTSHOT Mode. 	<ol style="list-style-type: none"> 1) Select a different flash mode (page 63). 2) Charge or replace the camera's batteries (page 34). 3) Select a different REC mode. 4) Select a different flash mode (page 63) or BESTSHOT scene (page 84).
	Camera powers down during self-timer countdown.	The batteries are dead.	Charge or replace the camera's batteries.

APPENDIX

	Symptom	Possible Cause	Action
Image Recording	Monitor screen image is out of focus.	<ol style="list-style-type: none"> 1) You are using the Manual Focus Mode and have not focused the image. 2) You are trying to use the Macro Mode (👉) when shooting a scenery or portrait shot. 3) You are trying to use Auto Focus or the Infinity Mode (∞) when shooting a close-up shot. 	<ol style="list-style-type: none"> 1) Focus the image (page 76). 2) Use Auto Focus for scenery and portrait shots. 3) Use the Macro Mode (👉) for close-ups.
	Recorded images are not saved in memory.	<ol style="list-style-type: none"> 1) Camera powers down before the save operation is complete. 2) Removing the memory card before the save operation is complete. 	<ol style="list-style-type: none"> 1) When the battery indicator shows 🔋, charge or replace the camera's batteries. 2) Do not remove the memory card before the save operation is complete.
Playback	Color of the playback image is different from the image on the monitor screen during recording.	Sunlight or light from another source is shining directly into the lens during recording.	Position the camera so sunlight does not shine directly into the lens.
	Images are not displayed.	A memory card with non-DCF images recorded with another camera is loaded in the camera.	Use a different card. This camera cannot display non-DCF images recorded onto a memory card using another digital camera.
Other	All buttons and switches are disabled.	Circuit problem caused by electrostatic charge, impact, etc. while the camera was connected to another device.	Remove the batteries from the camera, reinsert them, and then try again.

APPENDIX

	Symptom	Possible Cause	Action
Other	Monitor screen is off.	<ol style="list-style-type: none">1) USB communication is in progress.2) The monitor screen is turned off (in the REC mode).	<ol style="list-style-type: none">1) After confirming that the computer is not accessing camera memory, disconnect the USB cable.2) Press [DISP] to turn on the monitor screen.
	Cannot transfer files over a USB connection.	<ol style="list-style-type: none">1) USB cable is not connected securely.2) USB driver is not installed.3) Camera is turned off.	<ol style="list-style-type: none">1) Check all connections.2) Install the USB driver on your computer (page 162).3) Turn on the camera.

If you have problems installing the USB driver...

You may not be able to install the USB driver properly if you use the USB cable to connect the camera to a computer running Windows 98 before installing the USB driver from the bundled CD-ROM (CASIO Digital Camera Software), or if you have another type of driver installed. This will make it impossible for the computer to recognize the digital camera when it is connected. If this happens, you will need to re-install the camera's USB driver. For information about how to re-install the USB driver, see the USB driver's "Read me" file on "CASIO Digital Camera Software" CD-ROM that comes bundled with the camera.

Display Messages

Alarm setting complete. This message appears after you change the alarm setting.

Battery is low. The batteries are dead.

Cannot correct image! Keystone correction cannot be performed for some reason. The image will be stored as-is, without correction (page 93).

Can not find the file. The camera cannot find an image specified by the slideshow "Images" setting. Specify another image (page 120).

Cannot register any more files

- You are attempting to save a BESTSHOT user setup when the "SCENE" folder already contains 999 setups (page 88).
- You are attempting to copy a FAVORITE file when the "FAVORITE" folder already contains 9999 files (page 128).

Card ERROR Some problem occurred with the memory card. Turn off the camera, and remove and then reinsert the memory card. If the same message appears, format the memory card (page 148).

»» IMPORTANT! ««

Formatting the memory card deletes all files on the memory card. Before formatting, try transferring recoverable files to a computer or some other storage device.

Check connections! You are trying to print on the printer over an incompatible USB connection.

File could not be saved because battery is low. The batteries are dead, so the recorded image could not be saved.

Folder cannot be created. This message appears when you try to record an image while there are 9,999 files stored in the 999th folder. If you want to record more files, delete files you no longer need (page 124).

LENS ERROR If the lens comes into contact with some obstacle while it is extending, this message appears, the lens retracts, and the camera turns off. Take action to remove the obstacle, and try turning on power again.

Load paper! The camera is in the Printer mode, and the printer is out of paper.

Memory Full Memory is full. If you want to record more files, delete files you no longer need (page 124).

No Favorites file! There is no FAVORITE file.

Printing Error One of the following problems occurred during printing.

- Printer power off
- Printer internal error

APPENDIX

Record Error	Image compression could not be performed during image data storage for some reason. Record the image again.
---------------------	---

Replenish ink!	The camera is in the Printer mode, and the printer is running low on ink or is out of ink.
-----------------------	--

SYSTEM ERROR	Your camera system is corrupted. Contact your retailer or a CASIO service center.
---------------------	---

The card is locked.	The LOCK switch of the SD memory card is locked. You cannot store images to or delete images from a memory card that is locked.
----------------------------	---

There are no files.	There are no files in built-in memory or on the memory card.
----------------------------	--

There is no image to register.	You are trying to save an invalid image as a BESTSHOT user setup, or as an original startup image.
---------------------------------------	--

There are no printing images. Set up DPOF.	There are no DPOF settings specifying images and the number of copies of each for printing. Configure the required DPOF settings (page 153).
---	--

This card is not formatted.	The memory card loaded in the camera is not formatted. Format the memory card (page 148).
------------------------------------	---

This file cannot be played.	The image file or audio file is corrupted, or is a type that cannot be displayed by this camera.
------------------------------------	--

This function cannot be used.	You attempted to copy files from built-in memory to a memory card loaded in the camera while there is no memory card in the camera (page 150).
--------------------------------------	--

This function is not supported for this file.	The function you are trying to perform is not supported for the file on which you are trying to perform it.
--	---

Specifications

Product Digital Camera

Model QV-R61

■ Camera Functions

Image Files Format

Snapshots JPEG (Exif Ver.2.2); DCF (Design rule for Camera File system) 1.0 standard; DPOF compliant

Movies AVI (Motion JPEG)

Recording Media 9.7 MB built-in flash memory
SD Memory Card
MultiMediaCard

Image Size

Snapshots 2816 × 2112 pixels
2816 × 1872 (3:2) pixels
2048 × 1536 pixels
1600 × 1200 pixels
1280 × 960 pixels
640 × 480 pixels

Movies 320 × 240 pixels

Approximate Memory Capacity and File sizes

• Snapshots

File Size (pixels)	Quality	Approximate Image File Size	Built-in flash memory 9.7MB	SD Memory Card* 64MB
2816 × 2112	Fine	2.9MB	3 shots	20 shots
	Normal	2.3MB	4 shots	25 shots
	Economy	1.6MB	5 shots	36 shots
2816 × 1872 (3:2)	Fine	2.7MB	3 shots	22 shots
	Normal	2.1MB	4 shots	28 shots
	Economy	1.4MB	6 shots	41 shots
2048 × 1536	Fine	1.6MB	5 shots	34 shots
	Normal	1.2MB	7 shots	45 shots
	Economy	630 KB	14 shots	88 shots
1600 × 1200 (UXGA)	Fine	1.05MB	8 shots	53 shots
	Normal	710 KB	12 shots	79 shots
	Economy	370 KB	24 shots	154 shots
1280 × 960 (SXGA)	Fine	680 KB	13 shots	82 shots
	Normal	460 KB	20 shots	126 shots
	Economy	250 KB	35 shots	221 shots
640 × 480 (VGA)	Fine	190 KB	46 shots	294 shots
	Normal	140 KB	61 shots	386 shots
	Economy	90 KB	98 shots	618 shots

• Movies (320 × 240 pixels)

Data Size	300KB/second max.
-----------	-------------------

- * Based on Matsushita Electric Industrial Co., Ltd. products. Capacity depends on card manufacturer.
- * To determine the number of images that can be stored on a memory card of a different capacity, multiply the capacities in the table by the appropriate value.

APPENDIX

Delete	Single-file, all files (with protection)
Effective Pixels	6.00 million
Imaging Element	1/1.8-inch square pixel color CCD (Total pixels: 6.37 million)
Lens/Focal Distance	Seven lenses in six groups, including an aspherical lens F2.8 (W) to 4.9 (T); f= 8 (W) to 24mm (T) (equivalent to approximately 39 (W) to 117 (T) for 35mm film)
Zoom	3X optical zoom; 4 X digital zoom (12X in combination with optical zoom)
Focusing	Contrast-type Auto Focus (AF Mode (AF Area: Spot or Multi), Macro Mode), Infinity Mode; focus lock; manual focus
Approximate Focus Range (from lens surface)	
Normal	60 cm to ∞ (infinity) (2' to ∞)
Macro	Approximately 10cm to 70cm (3.9" to 27.6") at wide angle Approximately 60cm to 70cm (23.6" to 27.6") at telephoto
Manual	Wide angle: 10 cm to ∞ (infinity) (3.9" to ∞) Telephoto: 60 cm to ∞ (infinity) (23.6" to ∞)

Exposure Control

Light Metering	Multi-pattern center-weighted, spot by CCD
Exposure	Program AE
Exposure Compensation	-2EV to +2EV (1/3EV units)

Shutter	CCD electronic shutter; mechanical shutter, 1/8 to 1/2000 second (Changes in accordance with recording mode and ISO sensitivity setting.) • Shutter speed is different for the following BESTSHOT scenes. Night Scene: 4 to 1/2000 second Fireworks: 2 seconds (fixed)
----------------------	---

Aperture	Wide angle: F2.8/4.8, auto switching Telephoto: F4.9/8.4, auto switching
-----------------------	---

White Balance	Automatic, fixed (6 modes), manual switching
----------------------------	---

Sensitivity	Auto, ISO64, ISO125, ISO250, ISO500
--------------------------	-------------------------------------

Self-timer	10 seconds, 2 seconds, Triple Self- timer
-------------------------	--

Built-in Flash

Flash Modes	AUTO, ON, OFF, Red eye reduction
Flash Range	Wide Angle Optical Zoom: 0.6 to 2.6 meters (2.0' to 8.5') Telephoto Optical Zoom: 0.6 to 2.1 meters (2.0' to 6.9') (ISO Sensitivity: "Auto")

Recording Functions	Snapshot; BESTSHOT; Movie; high- speed continuous shutter mode
----------------------------------	---

APPENDIX

Monitor Screen	2.0-inch TFT color LCD 84,960 pixels (354 × 240)
Viewfinder	Monitor screen and optical viewfinder
Timekeeping Functions	Built-in digital quartz clock
Date and Time	Recorded with image data
Auto Calendar	To 2049
World Time	City; Date; Time; Summer time; 162 cities in 32 time zones
Input/Output Terminals	AC adaptor terminal (DC IN 3V) USB port (Mini-B)

■ Power Requirements

Power Requirements Two AA-size rechargeable nickel-metal hydride batteries (HR-3U <Rated Capacitance 2100mAh> and HR-3U <Rated Capacitance 2300mAh>) Two AA-size lithium batteries Two AA-size alkaline batteries AC adaptor (AD-C30)

Approximate Battery Life

The values below indicate the amount of time under the conditions defined below, until power automatically turns off due to battery failure. They do not guarantee that you will be able to achieve this level of operation. Low temperatures shorten battery life.

Operation	Rechargeable Nickel-Metal Hydride batteries	Alkaline batteries
Number of Shots (CIPA Standard)* ¹ (Operating Time)	280 shots (140minutes)	50 shots (25 minutes)
Number of Shots, Continuous Recording* ² (Operating Time)	900 shots (150 minutes)	245 shots (40 minutes)
Continuous Snapshot Playback* ³	260 minutes	150 minutes

- The above figures are approximations only.
- The above guidelines are based on the following battery types:
 - Rechargeable Nickel-Metal Hydride:
 - HR-3U (Rated Capacitance 2100 mAh) SANYO Electric Co., Ltd.
 - Alkaline: LR6 Matsushita Battery Industrial Co., Ltd.
 - Battery life varies with brand.
 - Storage Medium: SD Memory Card

APPENDIX

- *1 Number of Shots (CIPA Standard)
- Temperature: 23°C (73°F)
 - Monitor screen: On
 - Zoom operation between full wide to full telephoto every 30 seconds, during which two images are recorded, one image with flash; power turned off and back on every time 10 images are recorded.
- *2 Continuous Recording Conditions
- Temperature: 23°C (73°F)
 - Monitor screen: On
 - Flash: Off
 - Image recorded every 10 seconds, alternating full wide angle and full telephoto zoom
- *3 Continuous Snapshot Playback Conditions
- Temperature: 23°C (73°F)
 - Scroll one image about every 10 seconds

Power Consumption DC 3V Approximately 3.7 W

Dimensions 88.3 (W) × 60.4 (H) × 33.4 (D) mm
(3.5" (W) × 2.4" (H) × 1.3" (D))
(excluding projections)

Weight Approximately 168 g (5.9 oz)
(excluding batteries and accessories)

Bundled Accessories Rechargeable nickel-metal hydride batteries (HR-3U <Rated Capacitance 2100 mAh>); Charger unit (BC-5H); AC power cord; USB cable; Strap; CD-ROM; Basic Reference

■ Rechargeable nickel-metal hydride Batteries (HR-3U) (bundled)

Rated Voltage 1.2 V

Rated Capacitance 2100 mAh

Operating Temperature

Range 0°C to 40°C (32°F to 104°F)

Dimensions 14.35 (diameter) × 50.4 (H) mm
(0.56" (diameter) × 1.98" (H))

Weight Approximately 29.0 g (1.0 oz)
* Each battery

■ Special battery charger unit (BC-5H)

Power Requirement 100 to 240V AC, 0.08A, 50/60Hz

Output DC 1.2V, 550mA

Charging Temperature 0°C to 40°C (32°F to 104°F)

Chargeable Battery type ... Rechargeable nickel-metal hydride batteries (HR-3U)

Full Charge Times Approximately 4 hours

Dimensions 71 (W) × 75 (H) × 28 (D) mm
(2.8" (W) × 3.0" (H) × 1.1" (D))
(excluding projections)

Weight Approximately 75 g (2.6 oz)

APPENDIX

Power Supply

- Use only the special HR-3U rechargeable nickel-metal hydride batteries to power this camera. Use of any other type of battery is not supported.
- This camera does not have separate batteries for the clock. The date and time settings of the camera are cleared whenever power is totally cut off (from both the batteries and AC adaptor). Be sure to reconfigure these settings after power is interrupted (page 50).

LCD Panel

- The LCD panel is a product of the latest LCD manufacturing technology that provides a pixel yield of 99.99%. This means that less than 0.01% of the total pixels are defective (they do not turn on or always remain turned on).

Lens

- You may sometimes notice some distortion in certain types of images, such as a slight bend in lines that should be straight. This is due to the characteristics of lens, and does not indicate malfunction of the camera.

Free Manuals Download Website

<http://myh66.com>

<http://usermanuals.us>

<http://www.somanuals.com>

<http://www.4manuals.cc>

<http://www.manual-lib.com>

<http://www.404manual.com>

<http://www.luxmanual.com>

<http://aubethermostatmanual.com>

Golf course search by state

<http://golfingnear.com>

Email search by domain

<http://emailbydomain.com>

Auto manuals search

<http://auto.somanuals.com>

TV manuals search

<http://tv.somanuals.com>