

CTK-240 CTK-245

USER'S GUIDE GUÍA DEL USUARIO

Please keep all information for future reference.
Guarde toda información para tener como referencia futura.

English

Español



GUIDELINES LAID DOWN BY FCC RULES FOR USE OF THE UNIT IN THE U.S.A. (not applicable to other areas).

NOTICE

This equipment has been tested and found to comply with the limits for a Class B digital device, pursuant to Part 15 of the FCC Rules. These limits are designed to provide reasonable protection against harmful interference in a residential installation. This equipment generates, uses and can radiate radio frequency energy and, if not installed and used in accordance with the instructions, may cause harmful interference to radio communications. However, there is no guarantee that interference will not occur in a particular installation. If this equipment does cause harmful interference to radio or television reception, which can be determined by turning the equipment off and on, the user is encouraged to try to correct the interference by one or more of the following measures:

- Reorient or relocate the receiving antenna.
- Increase the separation between the equipment and receiver.
- Connect the equipment into an outlet on a circuit different from that to which the receiver is connected.
- Consult the dealer or an experienced radio/TV technician for help.

FCC WARNING

Changes or modifications not expressly approved by the party responsible for compliance could void the user's authority to operate the equipment.

Important!

Please note the following important information before using this product.

- Before using the optional AD-E95100L Adaptor to power the unit, be sure to check the AC Adaptor for any damage first. Carefully check the power cord for breakage, cuts, exposed wire and other serious damage. Never let children use an AC adaptor that is seriously damaged.
- Never attempt to recharge batteries.
- Do not use rechargeable batteries.
- Never mix old batteries with new ones.
- Use recommended batteries or equivalent types.
- Always make sure that positive (+) and negative (-) poles are facing correctly as indicated near the battery compartment.
- Replace batteries as soon as possible after any sign they are getting weak.
- Do not short-circuit the battery terminals.
- The product is not intended for children under 3 years.
- Use only CASIO AD-E95100L adaptor.
- The AC adaptor is not a toy.
- Be sure to disconnect the AC adaptor before cleaning the product.



This mark applies in EU countries only.



Manufacturer:
CASIO COMPUTER CO.,LTD.
6-2, Hon-machi 1-chome, Shibuya-ku, Tokyo 151-8543, Japan
Responsible within the European Union:
CASIO EUROPE GmbH
Casio-Platz 1, 22848 Norderstedt, Germany

Safety Precautions

Before using the instrument, be sure to carefully read through the instructions contained in this manual.

Symbols

Various symbols are used in this user's guide and on the product itself to ensure that the product is used safely and correctly, and to prevent injury to the user and other persons as well as damage to property. Those symbols along with their meanings are shown below.

DANGER

This symbol indicates information that, if ignored or applied incorrectly, creates the danger of death or serious personal injury.

WARNING

This indication stipulates matters that have the risk of causing death or serious injury if the product is operated incorrectly while ignoring this indication.

CAUTION

This indication stipulates matters that have the risk of causing injury as well as matters for which there is the likelihood of occurrence of physical damage only if the product is operated incorrectly while ignoring this indication.

Symbol Examples



This triangle symbol (\triangle) means that the user should be careful. (The example at left indicates electrical shock caution.)



This circle with a line through it (\odot) means that the indicated action must not be performed. Indications within or nearby this symbol are specifically prohibited. (The example at left indicates that disassembly is prohibited.)



The black dot (\bullet) means that the indicated action must be performed. Indications within this symbol are actions that are specifically instructed to be performed. (The example at left indicates that the power plug must be unplugged from the electrical socket.)

 **DANGER**

Alkaline Batteries

Perform the following steps immediately if fluid leaking from alkaline batteries ever gets into your eyes. 

1. Do not rub your eyes! Rinse them with water.
 2. Contact your physician immediately.
- Leaving alkaline battery fluid in your eyes can lead to loss of sight.



 **WARNING**

Smoke, Strange Odor, Overheating





Continued use of the product while it is emitting smoke, a strange odor, or heat creates the risk of fire and electric shock. Take the following steps immediately.

1. Turn off power.
2. If you are using the AC adaptor for power, unplug it from the wall outlet.
3. Contact your original retailer or an authorized CASIO Service Provider.

AC Adaptor

- Misuse of the AC adaptor creates the risk of fire and electric shock. Always make sure you observe the following precautions.
- Be sure to use only the AC adaptor that is specified for this product.
- Use only a power source whose voltage is within the rating marked on the AC adaptor. 
- Do not overload electrical outlets and extension cords. 

- Misuse of the AC adaptor's electric cord can damage or break it, creating the risk of fire and electric shock. Always make sure you observe the following precautions.

- Never place heavy objects on the cord or subject it to heat. 
- Never try to modify the cord or subject it to excessive bending.
- Never twist or stretch the cord.
- Should the electric cord or plug become damaged, contact your original retailer or authorized CASIO Service Provider. 
- Never touch the AC adaptor while your hands are wet. Doing so creates the risk of electric shock. 
- Use the AC adaptor where it will not be splashed with water. Water creates the risk of fire and electric shock. 
- Do not place a vase or any other container filled with liquid on top of the AC adaptor. Water creates the risk of fire and electric shock. 

Batteries

Misuse of batteries can cause them to leak, resulting in damage to nearby objects, or to explode, creating the risk of fire and personal injury. Always make sure you observe the following precautions.

- Never try to take batteries apart or allow them to become shorted. 
- Never expose batteries to heat or dispose of them by incineration.
- Never mix old batteries with new ones.
- Never mix batteries of different types.
- Do not charge the batteries.
- Make sure the positive (+) and negative (-) ends of the batteries are facing correctly.

Do not incinerate the product.

Never throw the product into fire. Doing so can cause it to explode, creating the risk of fire and personal injury.

**Water and Foreign Matter**

Water, other liquids, and foreign matter (such as pieces of metal) getting into the product create the risk of fire and electric shock. Take the following steps immediately.



1. Turn off power.
2. If you are using the AC adaptor for power, unplug it from the wall outlet.
3. Contact your original retailer or an authorized CASIO Service Provider.

Disassembly and Modification

Never try to take this product apart or modify it in any way. Doing so creates the risk of electric shock, burn injury, or other personal injury. Leave all internal inspection, adjustment, and maintenance up to your original retailer or authorized CASIO Service Provider.

**Dropping and Impact**

Continued use of this product after it has been damaged by dropping or subjecting it to strong impact creates the risk of fire and electric shock. Take the following steps immediately.

1. Turn off power.
2. If you are using the AC adaptor for power, unplug it from the wall outlet.
3. Contact your original retailer or an authorized CASIO Service Provider.

**Plastic Bags**

Never place the plastic bag the product comes in over your head or in your mouth. Doing so creates the risk of suffocation.



Particular care concerning this precaution is required where small children are present.

Keep off of the product and stand.*

Climbing onto the product or stand can cause it to tip over or become damaged.



Particular care concerning this precaution is required where small children are present.

Location



Avoid locating the product on an unstable stand, on an uneven surface, or any other unstable location. An unstable location can cause the product to fall over, creating the risk of personal injury.



 **CAUTION**

AC Adaptor

Misuse of the AC adaptor creates the risk of fire and electric shock. Always make sure you observe the following precautions.

- Do not locate the electric cord near a stove or other sources of heat. 
- Never pull on the cord when unplugging from the electrical outlet. Always grasp the AC adaptor when unplugging.
- Insert the AC adaptor into the wall outlet as far as it will go. 
- Unplug the AC adaptor from the wall outlet during lightening storms or before leaving on a trip or other longterm absence.
- At least once a year, unplug the AC adaptor from the wall outlet and wipe away any dust that is built up in the area around the prongs of the plug.
- Never use detergent to clean the power cord, especially the plug and jack parts.

Relocating the Product

Before relocating the product, always unplug the AC adaptor from the wall outlet and disconnect all other cables and connecting cords. Leaving cords connected creates the risk of damage to the cords, fire, and electric shock. 

Cleaning

Before cleaning the product, always unplug the AC adaptor from the wall outlet first. Leaving the AC adaptor plugged in creates the risk of damage to the AC adaptor, fire, and electric shock. 

Batteries

Misuse of batteries can cause them to leak resulting in damage to nearby objects, or to explode, creating the risk of fire and personal injury. Always make sure you observe the following precautions.

- Use only batteries that are specified for use with this product.
- Remove batteries from the product if you do not plan to use it for a long time.

Connectors

Connect only the specified devices and equipment to the product's connectors. Connection of a non-specified device or equipment creates the risk of fire and electric shock. 

Location

Avoid the following locations for this product. Such locations create the risk of fire and electric shock. 

- Areas subject to high humidity or large amounts of dust.
- In food preparation areas or other areas subject to oil smoke.
- Near air conditioning equipment, on a heated carpet, in areas exposed to direct sunlight, inside of a vehicle parked in the sun, or any other area that subjects the product to high temperatures.

Display Screen

- Never push on the display screen's LCD panel or subject it to strong impact. Doing so can cause the LCD panel's glass to crack, creating the risk of personal injury. 
- Should the LCD panel ever crack or break, never touch the liquid inside of the panel. LCD panel liquid can cause skin irritation.
- Should LCD panel liquid ever get inside your mouth, immediately wash out your mouth with water and contact your physician.
- Should LCD panel liquid ever get into your eyes or onto your skin, rinse with clear water for at least 15 minutes, and then contact a physician.

Sound Volume

Do not listen to music at very loud volumes for long periods. Particular care concerning this precaution is required when using headphones. High volume settings can damage your hearing. 

Heavy Objects

Never place heavy object on top of the product. 
Doing so can make the product top heavy, causing the product to tip over or the object to fall from it, creating the risk of personal injury.

Correct Stand* Assembly

An incorrectly assembled stand can tip over, causing the product to fall and creating the risk of personal injury. 
Make sure you assemble the stand correctly, following the assembly instructions that come with it. Make sure you mount the product on the stand correctly.

* Stand is available as an option.

IMPORTANT!

When using batteries, be sure to replace them or shift to one of the alternate power sources whenever you notice any of the following symptoms.

- Instrument does not turn on
- Display that is flickering, dim, or difficult to read
- Abnormally low speaker/headphone volume
- Distortion of sound output
- Occasional interruption of sound when playing at high volume
- Sudden power failure when playing at high volume
- Flickering or dimming of the display when playing at high volume
- Continued sound output even after you release a key
- A tone that is totally different from the one that is selected
- Abnormal rhythm pattern and Song Bank play



Introduction

Congratulations upon your selection of this CASIO musical instrument. This keyboard provides you with the following features and functions.

■ 100 tones

Choose from among orchestral sounds, synthesized sounds, and more.

■ 100 rhythms

100 versatile rhythms help to add plenty of life to all your keyboard performances.

■ Auto Accompaniment

Simply play a chord and the corresponding rhythm, bass and chord parts play automatically.

■ 50-tune Song Bank

A wide selection of favorites including "ODE TO JOY" and "JINGLE BELLS" is yours for your listening enjoyment or play along fun. A simple operation cuts out the melody part of the tune, allowing you to play along on the keyboard.

Contents

Safety Precautions..... E-1

Introduction E-6

General Guide E-8

Attachment of the Score Stand E-9

Using the Display E-10

Song Bank

Quick Reference..... E-11

Playing Back a Song Bank Tune..... E-11

Power Supply E-13

Using a Household Power Outlet E-13

Using Batteries E-13

Auto Power Off E-14

Settings E-14

Connections E-15

Phones/Output Terminal E-15

Accessories and Options..... E-15

Basic Operations E-16

Playing the Keyboard E-16

Selecting a Tone E-16

Auto Accompaniment..... E-18

Selecting a Rhythm E-18

Playing a Rhythm E-19

Adjusting the Tempo E-19

Using Auto Accompaniment..... E-20

Using a Fill-in Pattern E-22

Synchro Starting Accompaniment
with Rhythm Play..... E-22

Adjusting the Accompaniment
Volume E-23

Using the Song Bank..... E-24

Playing Back a Song Bank Tune E-24

Song Bank Mode Display E-25

Adjusting the Tempo of a
Song Bank Tune E-26

Changing the Tone of a
Song Bank Tune's Melody..... E-26

Playing Along with a
Song Bank Tune E-26

Applause Sound E-27

Playing Back All Song Bank
Tunes in Succession E-28

Keyboard Settings E-29

Transposing the Keyboard E-29

Tuning the Keyboard E-30

Troubleshooting..... E-31

Specifications..... E-33

Operating Precautions.... E-34

Appendix..... A-1

Tone List..... A-1

Rhythm List..... A-2

Note Table A-3

Fingered Chord Chart..... A-5

Percussion Instrument List A-7

Song List..... A-8

General Guide

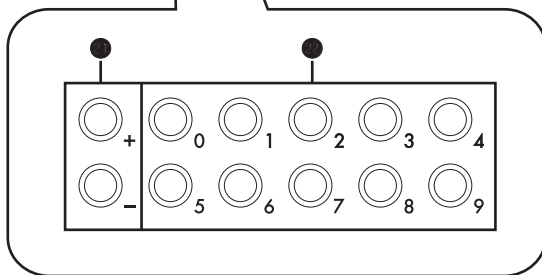
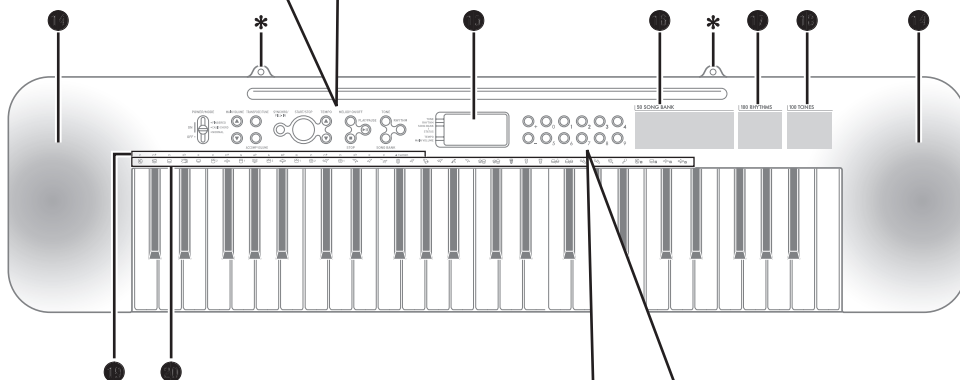
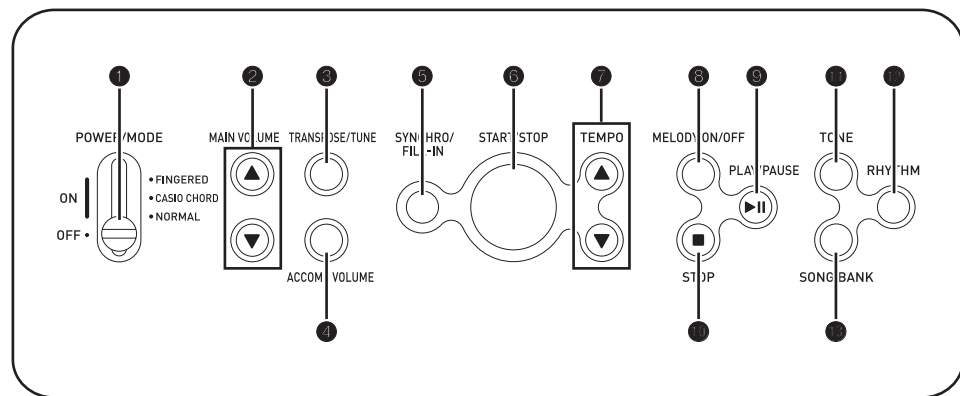

- ❶ POWER/MODE switch
- ❷ MAIN VOLUME buttons
- ❸ TRANSPOSE/TUNE button
- ❹ ACCOMP VOLUME button
- ❺ SYNCHRO/FILL-IN button
- ❻ START/STOP button
- ❼ TEMPO buttons
- ❶ SONG BANK CONTROLLER
 - ❸ MELODY ON/OFF button
 - ❹ PLAY/PAUSE button
 - ❺ STOP button
- ❷ TONE button
- ❸ RHYTHM button
- ❹ SONG BANK button
- ❺ Speakers
- ❻ Display
- ❼ Song bank list
- ❷ Rhythm list
- ❸ Tone list
- ❹ Chord name
- ❺ Percussion instrument list
- ❷ [+]/[-] buttons
 - Negative values can be changed only by using [+] and [-] to increase and decrease the displayed value.
- ❸ Number buttons
 - For input of numbers to change displayed settings.

Rear Panel

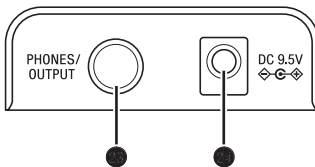

- ❸ PHONES/OUTPUT terminal
- ❹ DC 9.5V jack

***Attachment of the Score Stand**

Insert both ends of the music stand provided with the keyboard into the two holes on the top surface.

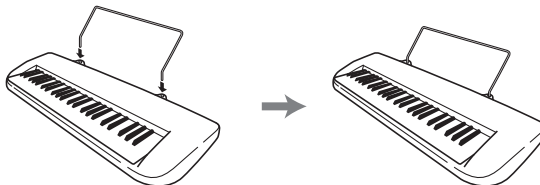

Using the Display

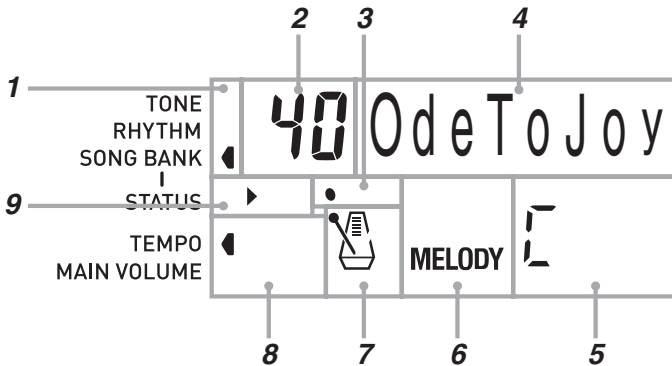

- This is how the display appears while the Song Bank is in use.

1. An indicator appears next to the type of setting you are currently performing (TONE, RHYTHM, SONG BANK).
2. Tone number, rhythm number, song number, keyboard settings value
3. Rhythm, auto-accompaniment, Song Bank tune beats
4. Tone name, rhythm name, song name, mode name, keyboard setting names
5. Auto-accompaniment and Song Bank chord names
6. “MELODY” indicates the on/off status of the melody part during Song Bank playback.
7. Rhythm, auto-accompaniment, Song Bank tune tempo
8. Rhythm, auto-accompaniment, Song Bank tune tempo; volume setting
9. Song Bank controller indicators

NOTE

- Display examples shown in this User’s Guide are intended for illustrative purposes only. The actual text and values that appear on the display may differ from the examples shown in this User’s Guide.

Song Bank Quick Reference

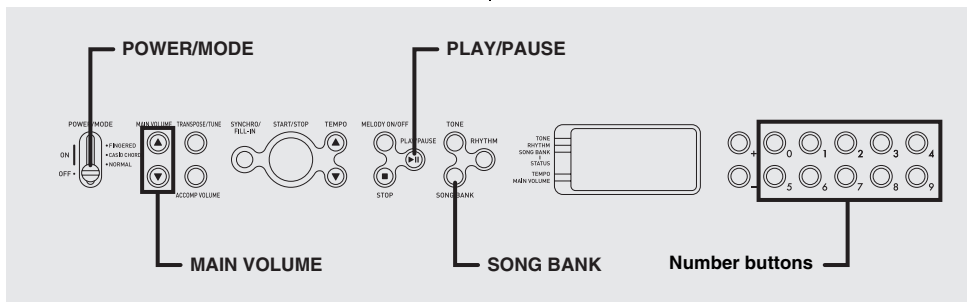

A selection of 50 Song Bank tunes comes built-in for your listening pleasure or play along fun. A simple operation cuts out the melody part of the tune, allowing you to play along on the keyboard. See "Using the Song Bank" on page E-24 for details on playing along with Song Bank tunes.

Playing Back a Song Bank Tune

To play back a Song Bank tune

1. Set the POWER/MODE switch to NORMAL.
2. Use the MAIN VOLUME buttons to lower the keyboard volume to a relatively low level.

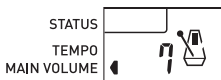

3. Press the SONG BANK button to enter the Song Bank Mode.

Appears when SONG BANK button is pressed



4. Use the Song Bank list to find the tune you want to play back, and then use the number buttons to input the tune's two-digit number.

Example: To select "40 ODE TO JOY", input 4 and then 0.



- Not all of the available songs are shown on the song bank list printed on the keyboard console. For a complete list, see the "Song List" on page A-8.
5. Press the PLAY/PAUSE button to start play of the tune.
 - The tune plays in an endless loop, restarting after it reaches the end.

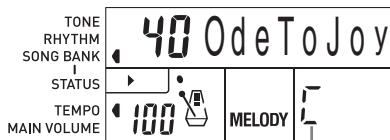

Chord name

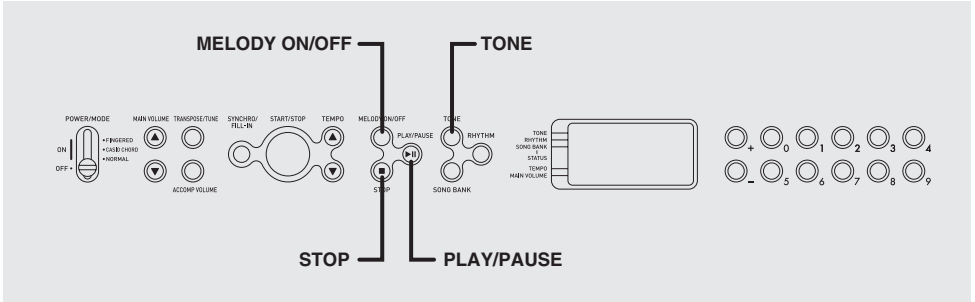

6. Press the MELODY ON/OFF button to turn off the melody part and try playing along on the keyboard.

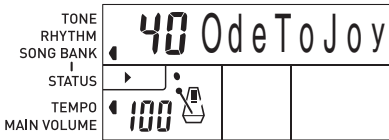

7. Press the MELODY ON/OFF button again to turn the melody part back on.

8. Press the STOP button to stop playback of the Song Bank tune.

9. Press the TONE button to exit the Song Bank Mode and return to the tone and rhythm selection screen.



NOTE

- You can also perform the following operation during play of a Song Bank tune.
 - Pause: Press the PLAY/PAUSE button.

Power Supply

Prepare a household power outlet or batteries.

IMPORTANT!

- **Be sure to comply with the “Safety Precautions” provided in this manual. Incorrect use of this product creates the risk of electric shock and fire.**
- **Always make sure that the Digital Keyboard is turned off before plugging in or unplugging the AC adaptor, or before loading or removing batteries.**

Using a Household Power Outlet

Make sure that you use only the AC adaptor specified for this keyboard. Use of a different type of AC adaptor can cause malfunction.

Specified AC Adaptor:

AD-E95100L (JEITA Standard plug)

Household power outlet

DC 9.5V terminal

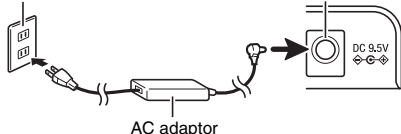

IMPORTANT!

- **The AC adaptor will become warm to the touch after very long use. This is normal and does not indicate malfunction.**
- **To prevent breaking of the wire, take care to avoid putting any type of load on the power cord.**

No bending!



No winding!

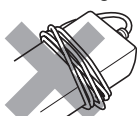

Using Batteries

You can use six AA-size batteries for power.

- Use alkaline or zinc-carbon batteries.
Never use oxyride or any other nickel based batteries.

Open the battery cover on the bottom of the Digital Keyboard, load the batteries, and then close the cover.

- Take care to ensure that the positive \oplus and negative \ominus ends of the batteries are facing correctly.

Open the battery cover.

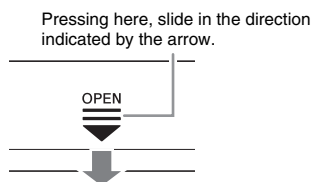

Load the batteries.

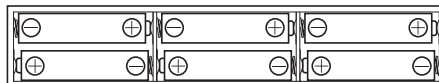

Important Battery Information

- The following shows the approximate battery life.

Zinc-carbon batteries6 hours*

* The above value is standard battery life at normal temperature, with the keyboard volume at medium setting. Temperature extremes or playing at very loud volume settings can shorten battery life.

- Any of the following symptoms indicate low battery power. Replace batteries as soon as possible whenever any of the following occurs.

- Instrument does not turn on
- Display that is flickering, dim, or difficult to read
- Abnormally low speaker/headphone volume
- Distortion of sound output
- Occasional interruption of sound when playing at high volume
- Sudden power failure when playing at high volume
- Flickering or dimming of the display when playing at high volume
- Continued sound output even after you release a key
- A tone that is totally different from the one that is selected
- Abnormal rhythm pattern and Song Bank play

Auto Power Off

The Digital Keyboard will turn off automatically to preserve battery power if you do not perform any operation for about six minutes (Auto Power Off).

To disable Auto Power Off

Hold down the TONE button while turning on the keyboard to disable Auto Power Off.

NOTE

- When Auto Power Off is disabled, the keyboard does not turn off automatically no matter how long it is left with no operation being performed.
- Auto Power Off is automatically enabled whenever you turn on keyboard power.

Settings

All keyboard settings are returned to their initial defaults whenever keyboard power is turned back on after being turned off by operation of the POWER/MODE switch or Auto Power Off.

Connections

Phones/Output Terminal

Before connecting phones or other external equipment, be sure to first turn down the volume settings of the keyboard and the connected equipment. You can then adjust volume to the desired level after connections are complete.

[Rear Panel]

PHONES/OUTPUT Terminal

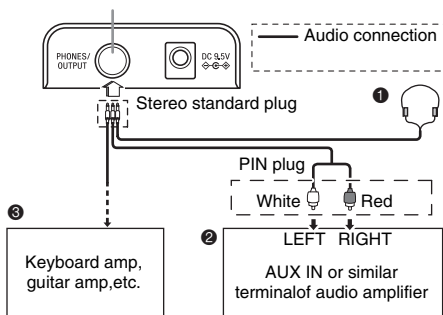

Connecting Phones (Figure 1)

Connecting phones cuts off output from the keyboard's built-in speakers, so you can play even late at night without disturbing anyone.

Audio Equipment (Figure 2)

Connect the keyboard to an audio equipment using a commercially available connecting cord with a standard plug on one end and two PIN plugs on the other end. In this configuration, you normally set the input selector of the audio equipment to the terminal (usually marked AUX IN or something similar) where the cord from the keyboard is connected. See the user documentation that comes with your audio equipment for full details.

Musical Instrument Amplifier (Figure 3)

Use a commercially available connecting cord* to connect the keyboard to a musical instrument amplifier.

* Be sure to use a connecting cord that has standard plugs on the ends you connect to the keyboard and amplifier.

When connected to a musical instrument amplifier, set the volume of the keyboard to a relatively low level and make output volume adjustments using the amplifier's controls.

[Connection Example]

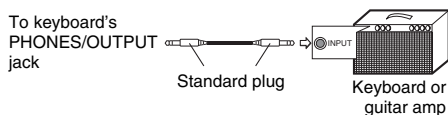

Accessories and Options

Use only the accessories and options specified for this keyboard. Use of non-authorized items creates the danger of fire, electrical shock, and personal injury.

- You can get information about accessories that are sold separately for this product from the CASIO catalog available from your retailer, and from the CASIO website at the following URL.
<http://world.casio.com/>

Basic Operations

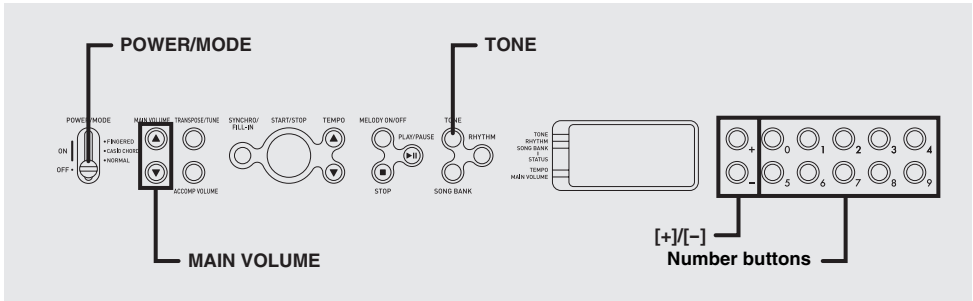

This section provides information on performing basic keyboard operations.

Playing the Keyboard

To play the keyboard

1. Set the **POWER/MODE** switch to **NORMAL**.
2. Use the **MAIN VOLUME** buttons to **lower the keyboard volume**.
 - It's always a good idea to set the keyboard volume at a relatively low level before playing.
 - Pressing [▲] or [▼] causes the current volume setting to appear on the display. Press [▲] or [▼] again to change the setting.
3. Play something on the keyboard.

Selecting a Tone

This keyboard comes with 100 built-in tones. Use the following procedure to select the tone you want to use.

To select a tone

1. Find the tone you want to use in the tone list and note its tone number.
 - Not all of the available tones are shown on the tone list printed on the keyboard console. For a complete list, see the "Tone List" on page A-1.

2. Press the **TONE** button.

Appears when TONE button is pressed



3. Use the number buttons to input the two digit tone number for the tone you want to select.

Example: To select "26 WOOD BASS", input 2 and then 6 .



- Now notes played on the keyboard will be played using an acoustical wood bass sound.

NOTE

- Always input both digits for the tone number, including a leading zero (if any). If you input one digit and stop, the display will automatically clear your input after a few seconds.
- You can also increment the displayed tone number by pressing [+] and decrement it by pressing [-].
- Sound effect tones such as 77 VEHICLE sound best when you keep a keyboard key depressed.

Combination tones

The following describes the two types of combination tones that are available.

Layered Tones (Tone Numbers: 80 through 89)

Example: 80 STR PIANO

This tone layers a strings tone with a piano tone so they both sound when a keyboard key is pressed.

Split Tones (Tone Numbers: 90 through 96)

Example: 90 BASS/PIANO

This tone splits the keyboard so one range is assigned a bass tone and another range is assigned a piano tone.

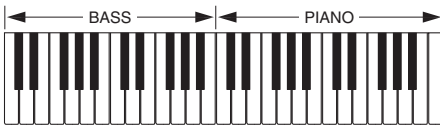

Percussion sounds

Example: 99 PERCUSSION

This tone assigns various percussion sounds to the keyboard. See the "Percussion Instrument List" on page A-7 for full details.

Sound Effect Tones

With sound effect tones 77 through 79, the type of sound produced depends on the octave where the key you press is located. When 78 PHONE is selected available sound types are PUSH TONE 1, PUSH TONE 2, RING 1, and RING 2.

Polyphony

The term polyphony refers to the maximum number of notes you can play at the same time. The keyboard has 12-note polyphony, which includes the notes you play as well as the rhythms and auto-accompaniment patterns that are played by the keyboard. This means that when a rhythm or auto-accompaniment pattern is being played by the keyboard, the number of notes (polyphony) available for keyboard play is reduced. Also note that some of the tones offer only 6-note polyphony.

NOTE

- When rhythm or auto accompaniment is playing, the number of sounds simultaneously played is reduced.

Digital Sampling

A number of the tones that are available with this keyboard have been recorded and processed using a technique called digital sampling. To ensure a high level of tonal quality, samples are taken in the low, mid, and high ranges and then combined to provide you with sounds that are amazingly close to the originals. You may notice very slight differences in volume or sound quality for some tones when you play them at different positions on the keyboard. This is an unavoidable result of multiple sampling, and it is not a sign of malfunction.

Auto Accompaniment

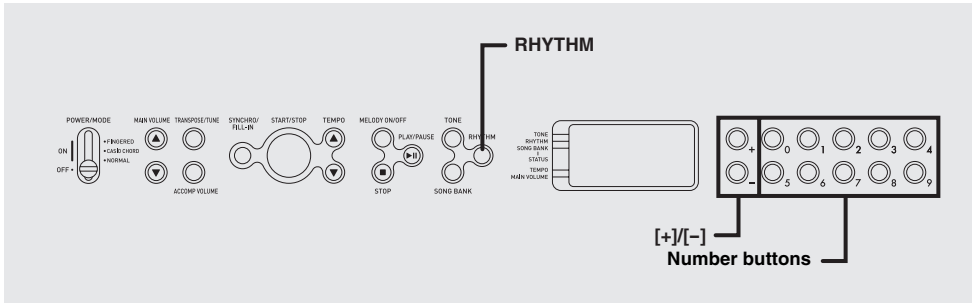

This keyboard automatically plays bass and chord parts in accordance with the chords you finger. The bass and chord parts are played using sounds and tones that are automatically selected to select the rhythm you are using. All of this means that you get full, realistic accompaniments for the melody notes you play with your right hand, creating the mood of a one-person ensemble.

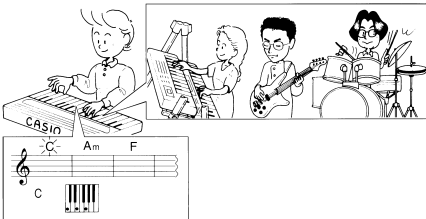

Selecting a Rhythm

This keyboard provides you with 100 exciting rhythms that you can select using the following procedure.

To select a rhythm

1. Find the rhythm you want to use in the rhythm list and note its rhythm number.

- Not all of the available rhythms are shown on the rhythm list printed on the keyboard console. For a complete list, see the "Rhythm List" on page A-2.

2. Press the RHYTHM button.

Appears when RHYTHM button is pressed

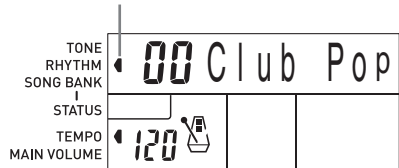

3. Use the number buttons to input the two digit rhythm number for the rhythm you want to select.

Example: To select "64 WALTZ", input 6 and then 4.

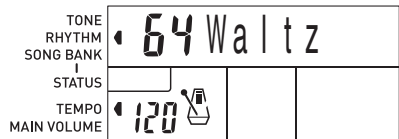

NOTE

- "00 CLUB POP" is the initial default rhythm setting whenever you turn on keyboard power.
- You can also increment the displayed rhythm number by pressing [+], and decrement it by pressing [-].

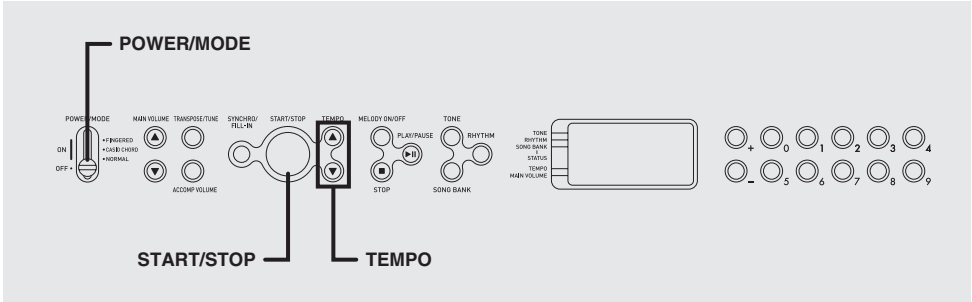

Playing a Rhythm

Use the following procedure to start and stop rhythm play.

To play a rhythm

1. Set the **POWER/MODE** switch to **NORMAL**.
2. Press the **START/STOP** button to start play of the currently selected rhythm.
3. To stop rhythm play, press the **START/STOP** button again.

NOTE

- All of the keyboard keys are melody keys while the **POWER/MODE** switch is set to **NORMAL**.

Adjusting the Tempo

You can adjust the tempo of rhythm play within a range of 20 to 255 beats per minute. The tempo setting is applied to Auto Accompaniment chord play, and song bank operations.

To adjust the tempo

1. Use the **TEMPO** buttons (**▲** / **▼**) to adjust the tempo.

▲ : Increases the tempo value.

▼ : Decreases the tempo value.

Example: Hold down the **▼** tempo value 110 is on the display.

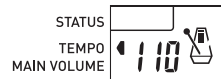

NOTE

- Pressing both **TEMPO** buttons (**▲** and **▼**) at the same time resets the tempo to the default value of the currently selected rhythm.

About the Graphic Metronome

The graphic metronome appears on the display along with the tempo value and beat of a rhythm or built-in tune. The graphic metronome helps you keep in time as you play along with a rhythm or built-in tune.

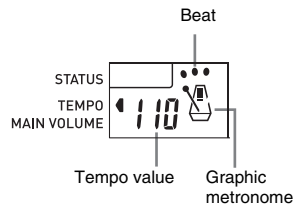

Using Auto Accompaniment

The following procedure describes how to use the keyboard's Auto Accompaniment feature. Before starting, you should first select the rhythm you want to use and set the tempo of the rhythm to the value you want.

To use Auto Accompaniment

1. Set the **POWER/MODE** switch to **CASIO CHORD** or **FINGERED**.
2. Press the **START/STOP** button to start play of the currently selected rhythm.
3. Play a chord.
 - The actual procedure you should use to play a chord depends on the current **POWER/MODE** switch position. Refer to the following pages for details on chord play.

CASIO CHORD..... This page
 FINGERED Page E-21

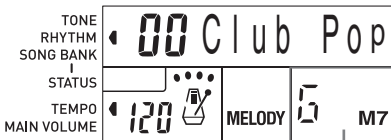

Chord name

4. To stop Auto Accompaniment play, press the **START/STOP** button again.

CASIO CHORD

This method of chord play makes it possible for anyone to easily play chords, regardless of previous musical knowledge and experience. The following describes the CASIO CHORD "Accompaniment keyboard" and "Melody keyboard", and tells you how to play CASIO CHORDs.

CASIO CHORD Accompaniment Keyboard and Melody Keyboard

Accompaniment keyboard

Melody keyboard

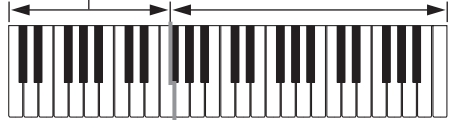





NOTE

- The accompaniment keyboard can be used for playing chords only. No sound will be produced if you try playing single melody notes on the accompaniment keyboard.

Chord Types

CASIO CHORD accompaniment lets you play four types of chords with minimal fingering.

Chord Types	Example
<p>Major chords</p> <p>Major chord names are marked above the keys of the accompaniment keyboard. Note that the chord produced when you press an accompaniment keyboard does not change octave, regardless of which key you use to play it.</p>	<p>C Major (C)</p> 
<p>Minor chords (m)</p> <p>To play a minor chord, keep the major chord key depressed and press any other two accompaniment keyboard key located to the right of the major chord key.</p>	<p>C minor (Cm)</p> 
<p>Seventh chords (7)</p> <p>To play a seventh chord, keep the major chord key depressed and press any other two accompaniment keyboard keys located to the right of the major chord key.</p>	<p>C seventh (C7)</p> 
<p>Minor seventh chords (m7)</p> <p>To play a minor seventh chord, keep the major chord key depressed and press any other three accompaniment keyboard keys located to the right of the major chord key.</p>	<p>C minor seventh (Cm7)</p> 

NOTE

- It makes no difference whether you press black or white keys to the right of a major chord key when playing minor and seventh chords.

FINGERED

FINGERED provides you with a total of 15 different chord types. The following describes the FINGERED “Accompaniment keyboard” and “Melody keyboard”, and tells you how to play a C-root chord using FINGERED.

FINGERED Accompaniment Keyboard and Melody Keyboard

Accompaniment keyboard

Melody keyboard

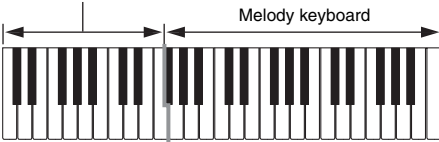

NOTE

- The accompaniment keyboard can be used for playing chords only. No sound will be produced if you try playing single melody notes on the accompaniment keyboard.

C 	Cm 	Cdim
Caug^{*1} 	Csus4 	C7^{*2}
Cm7^{*2} 	Cmaj7^{*2} 	Cm7⁵
C7⁵^{*1} 	C7sus4 	Cadd9^{*2}
Cmadd9^{*2} 	CmM7^{*2} 	Cdim7^{*1}

See the “Fingered Chord Chart” on page A-5 for details on playing chords with other roots.

- *1: Inverted fingerings cannot be used. The lowest note is the root.
- *2: The same chord can be played without pressing the 5th G.

NOTE

- Except for the chords specified in note^{*1} above, inverted fingerings (i.e. playing E-G-C or G-C-E instead of C-E-G) will produce the same chords as the standard fingering.
- Except for the exception specified in note^{*2} above, all of the keys that make up a chord must be pressed. Failure to press even a single key will not play the desired FINGERED chord.

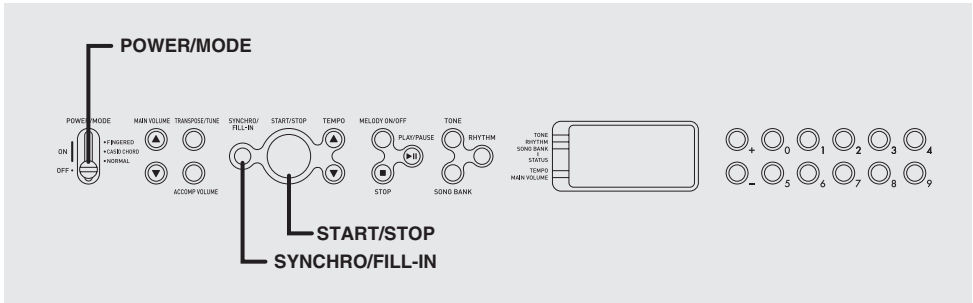

Using a Fill-in Pattern

Fill-in patterns let you momentarily change the rhythm pattern to add some interesting variation to your performances.

The following procedure describes how to use the Fill-in feature.

To insert a fill-in

1. Press the **START/STOP** button to start rhythm play.
2. Press the **SYNCHRO/FILL-IN** button to insert a fill-in pattern for the rhythm you are using.

Synchro Starting Accompaniment with Rhythm Play

You can set up the keyboard to start rhythm play at the same time you play the accompaniment on the keyboard.

The following procedure describes how to use synchro start. Before starting, you should first select the rhythm you want to use, set the tempo, and use the **POWER/MODE** switch to select the chord play method you want to use (CASIO CHORD, FINGERED).

To use synchro start

1. Press the **SYNCHRO/FILL-IN** button to put the keyboard into synchro start standby.



2. Play a chord on the accompaniment keyboard and the rhythm pattern starts to play automatically.

NOTE

- If the **POWER/MODE** switch is set to **NORMAL**, only the rhythm plays (without a chord) when you play on the accompaniment keyboard.
- To cancel synchro start standby, press the **SYNCHRO/FILL-IN** button one more time.

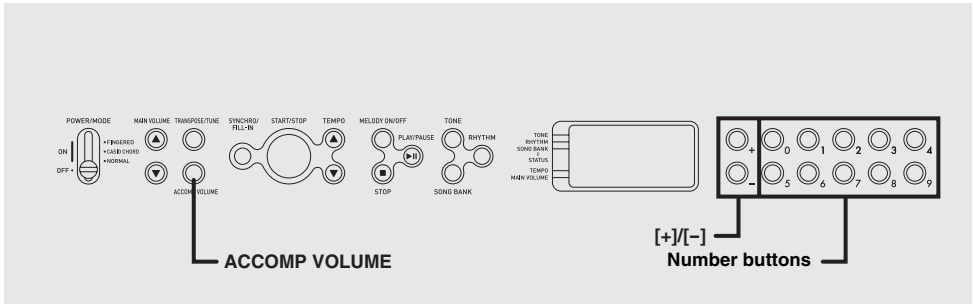

Adjusting the Accompaniment Volume

You can adjust the volume of the accompaniment parts as a value in the range of 0 (minimum) to 9.

1. Press the ACCOMP VOLUME button.

Current accompaniment volume setting



2. Use the number buttons or the [+]/[-] buttons to change the current volume setting value.

Example: 5



NOTE

- The current accompaniment volume value that appears in Step 1 automatically clears from the display if you do not input anything within about five seconds.
- Pressing [+]/[-] buttons at the same time automatically sets an accompaniment volume of 7.

Using the Song Bank

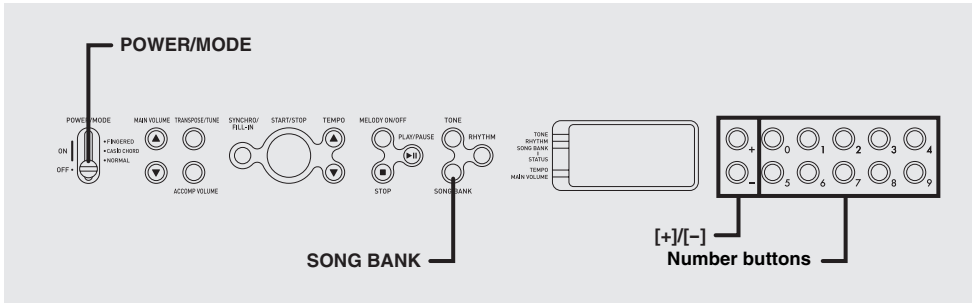

- A selection of 50 Song Bank tunes comes built-in for your listening enjoyment or play along fun. You can turn off the melody part to practice with the remaining part.

Playing Back a Song Bank Tune

To play back a Song Bank tune

1. Set the **POWER/MODE** switch to **NORMAL, FINGERED, or CASIO CHORD**.
2. Adjust the main volume and accomp volume.
3. Press the **SONG BANK** button to enter the Song Bank Mode.

Appears when SONG BANK button is pressed



4. Use the **Song Bank** list to find the tune you want to play back, and then use the **number buttons** to input the tune's two-digit number.

Example: To select "31 ALOHA OE", input 3 and then 1.

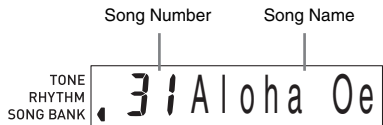

- Not all of the available songs are shown on the song bank list printed on the keyboard console. For a complete list, see the "Song List" on page A-8.

NOTE

- "00 TWINKLE TWINKLE LITTLE STAR" is the initial default Song Bank tune setting whenever you turn on keyboard power.
- You can also increment the displayed tune number by pressing [+], and decrement is by pressing [-].

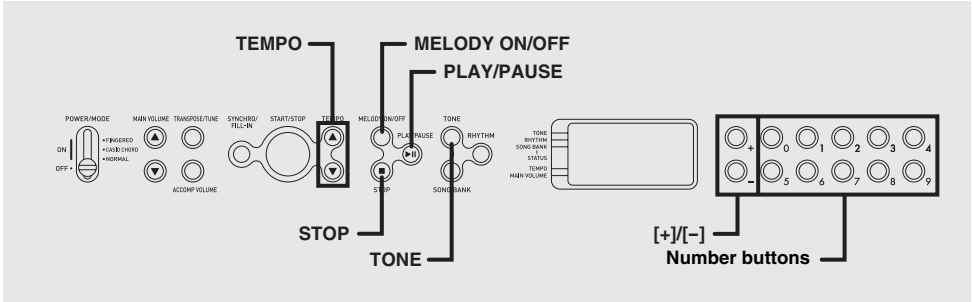

5. Press the PLAY/PAUSE button to start play of the tune.

Appears when PLAY/PAUSE button is pressed

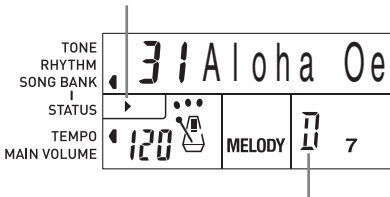

Chord name

6. Press the STOP button to stop playback of the Song Bank tune.

To pause Song Bank tune play

1. While a Song Bank tune is playing, press the PLAY/PAUSE button to pause it.

The indicator "||" appears while a tune play is paused.

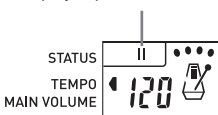

2. To resume play, press PLAY/PAUSE again.

NOTE

- Each time you select a new Song Bank tune, the tone, tempo, and rhythm that is programmed for the tune are automatically selected. You can change a tune's tone and tempo during playback, but you cannot change the rhythm.
- You can also adjust the accompaniment volume (page E-23) for Song Bank tunes.

Song Bank Mode Display

In the Song Bank Mode, the display shows a variety of information about the tune being played.

[Playback Display]

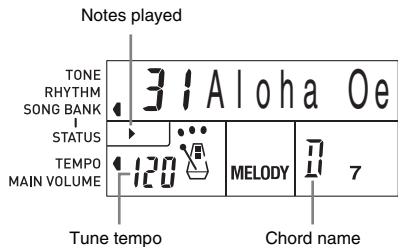

Adjusting the Tempo of a Song Bank Tune

To change the tempo of a Song Bank tune

The tempo can be set within a range of 20 to 255 beats per minute. The tempo setting can be adjusted while the tune is stopped, playing back, or paused.

1. Use the TEMPO buttons [▲ / ▼] to adjust the tempo.

- ▲ : Increases the tempo value.
- ▼ : Decreases the tempo value.

NOTE

- Pressing both the [▲] and [▼] TEMPO buttons at the same time returns the tempo setting to the preset value for the currently selected tune.

Changing the Tone of a Song Bank Tune's Melody

You can select any one of the keyboard's 100 tones to be used to play the melody part of a Song Bank tune. The tone setting can be changed while the tune is stopped or playing back.

1. While a song is playing back, press the TONE button.



2. Find the tone you want in the Tone List, and then use the number buttons or the [+] and [-] buttons to specify the tone number.

Example: To select "30 VIOLIN", input 3 and then 0.



NOTE

- Pressing both the [+] and [-] buttons at the same time selects "00 PIANO 1".
- To return a Song Bank tune to its original settings, simply select that tune again.

Playing Along with a Song Bank Tune

Each Song Bank tune has an accompaniment part and a melody part. You can turn off the melody part of a Song Bank tune and play along with the remaining part on the keyboard.

To play along with a Song Bank tune

1. Perform steps 1 through 4 under "To play back a Song Bank tune" on page E-24 to select the song you want to play along with.

2. Press the MELODY ON/OFF button to turn off the melody part.

- The on/off status of the melody part is indicated by "MELODY" that appears on the display. The melody part is turned on when "MELODY" is displayed, and turned off when "MELODY" is not displayed.



Indicator turns off.

Playing Back All Song Bank Tunes in Succession

1. Use the TONE or RHYTHM button to change to any mode other than the Song Bank Mode.

- Make sure a dot is not on the display next to the SONG BANK indicator.

Indicator turns off.

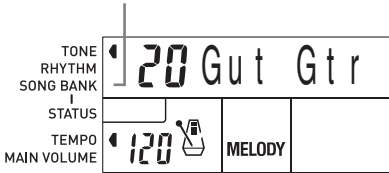

2. Press the PLAY/PAUSE button to start playback of the Song Bank tunes starting from tune 00.

3. To stop Song Bank tune playback, press the STOP button.

- Pausing playback automatically cancels consecutive playback of all Song Bank tunes. Re-starting playback causes repeat playback of the current tune only.

Keyboard Settings

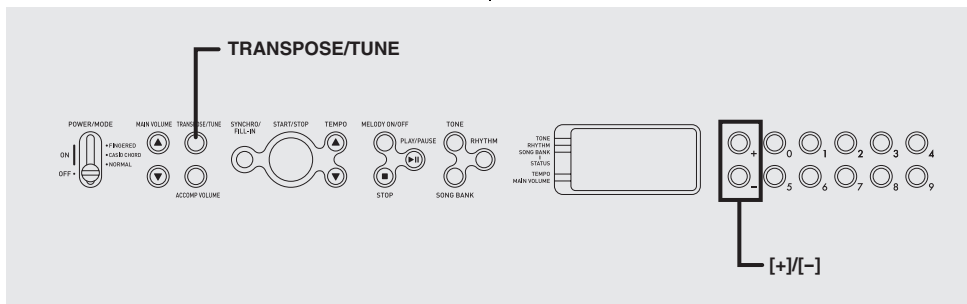

Transposing the Keyboard

Transpose lets you raise and lower the overall key of the keyboard in semitone units. If you want to play an accompaniment for a vocalist who sings in a key that's different from the keyboard, for example, simply use transpose to change the key of the keyboard.

To transpose the keyboard

1. Press the **TRANPOSE/TUNE** button until the transpose screen appears on the display.



2. Use **[+]** and **[-]** to change the transpose setting of the keyboard.

Example: To transpose the keyboard five semitones upwards.



NOTE

- The keyboard can be transposed within a range of -6 to +5.
- The default transpose setting is "0" when keyboard power is turned on.
- If you leave the transpose screen on the display for about five seconds without doing anything, the screen is automatically cleared.
- The transpose setting also affects Auto Accompaniment.
- Playing back a Song Bank tune automatically returns the transpose setting to its standard default of "0".

Tuning the Keyboard

The tuning feature lets you fine tune the keyboard to match the tuning of another musical instrument.

To tune the keyboard

1. Press the **TRANPOSE/TUNE** button twice to display the tuning screen.



2. Use **[+]** and **[-]** to change the tuning setting of the keyboard.

Example: To lower the tuning by 20.



NOTE

- The keyboard can be tuned within a range of -50 cents to +50 cents.
 - * 100 cents is equivalent to one semitone.
- The default tuning setting is "00" when keyboard power is turned on.
- If you leave the tuning screen on the display for about five seconds without doing anything, the screen is automatically cleared.
- The tuning setting also affects Auto Accompaniment.
- Playing back a Song Bank tune automatically returns the tuning setting to its standard default of "00".

Troubleshooting

Problem	Possible Cause	Action	See
No keyboard Sound	1. Power supply problem.	1. Correctly attach the AC adaptor, make sure that batteries poles (+/-) are facing correctly, and check to make sure that batteries are not dead.	Pages E-13, 14
	2. Power is not turned on.	2. Set the POWER/MODE switch to the NORMAL position.	Page E-16
	3. Volume setting is too low.	3. Use the MAIN VOLUME buttons to increase volume.	Page E-16
	4. The POWER/MODE switch is in the CASIO CHORD or FINGERED position.	4. Normal play is not possible on the accompaniment keyboard while the POWER/MODE switch is set to CASIO CHORD or FINGERED. Change the POWER/MODE switch setting to NORMAL.	Page E-16
Any of the following symptoms while using battery power. <ul style="list-style-type: none"> • Instrument does not turn on • Display that is flickering, dim, or difficult to read • Abnormally low speaker/headphone volume • Distortion of sound output • Occasional interruption of sound when playing at high volume • Sudden power failure when playing at high volume • Flickering or dimming of the display when playing at high volume • Continued sound output even after you release a key • A tone that is totally different from the one that is selected • Abnormal rhythm pattern and Song Bank play 	Low battery power	Replace the batteries with a set of new ones or use the AC adaptor.	Pages E-13, 14
Auto Accompaniment does not sound.	Auto accompaniment volume is set to 0.	Use the ACCOMP VOLUME button to increase the volume.	Page E-23

 **Troubleshooting**

Problem	Possible Cause	Action	See
The key or tuning does not match when playing along with another instrument.	The tuning or transpose parameter is set to a value other than 0 or 00.	Change the transpose or tuning parameter value to 0 or 00.	Pages E-29, 30
Missing Song Bank tune	Melody part is turned off.	Press the MELODY ON/OFF button to turn on the melody part.	Page E-26

Specifications

Model:	CTK-240/CTK-245
Keyboard:	49 standard-size keys, 4 octaves
Tones:	100
Polyphony:	12 notes maximum (6 for certain tones)
Auto Accompaniment	
Rhythm Patterns:	100
Tempo:	Variable (236 steps, ♩= 20 to 255)
Chords:	2 fingering methods (CASIO CHORD, FINGERED)
Rhythm Controller:	START/STOP, SYNCHRO/FILL-IN
Accomp Volume:	0 to 9 (10 steps)
Song Bank	
Tunes:	50
Controllers:	PLAY/PAUSE, STOP, MELODY ON/OFF
Display	
Name display:	TONE, RHYTHM, SONG BANK name/number, keyboard setting names/values
Tempo:	Tempo value, metronome, synchro standby, beat indicator
Chord:	Chord name
Song Bank Status:	PLAY, PAUSE, MELODY ON/OFF
Other Functions	
Transpose:	12 steps (-6 semitones to +5 semitones)
Tuning:	Variable (A4 = approximately 440Hz ±50 cents)
Volume:	0 to 9 (10 steps)
Terminals	
Phones/Output Terminal:	Stereo standard jack (Output is monaural.) Output Impedance: 78Ω Output Voltage: 1.9V (RMS) MAX
Power Supply Terminal:	9.5V DC
Power Supply:	Dual power supply system
Batteries:	6 AA-size zinc-carbon batteries or alkaline batteries Battery Life: Approximately 6 hours continuous operation on zinc-carbon batteries
AC Adaptor:	AD-E95100L
Auto Power Off:	Turns power off approximately 6 minutes after last operation.
Speaker Output:	∅ 10cm × 2 (1.6W + 1.6W)
Power Consumption:	9.5V --- 5.0W
Dimensions:	91.4 × 23.7 × 7.5 cm (36 × 9 ⁵ / ₁₆ × 2 ¹⁵ / ₁₆ inch)
Weight:	Approximately 2.8 kg (6.2 lbs) (without batteries)

NOTE

- Design and specifications are subject to change without notice.

Operating Precautions

Be sure to read and observe the following operating precautions.

■ Location

Avoid the following locations for this product.

- Areas exposed to direct sunlight and high humidity
- Areas subjected to temperature extremes
- Near a radio, TV, video deck, or tuner

The above devices will not cause malfunction of the product, but the product can cause interference in the audio or video of a nearby device.

■ User Maintenance

- Never use benzine, alcohol, thinner, or other chemical agents to clean the product.
- To clean the product or its keyboard, wipe with a soft cloth moistened in a weak solution of water and a mild neutral detergent. Wring all excess moisture from the cloth before wiping.

■ Included and Optional Accessories

Use only accessories that are specified for use with this product. Use of unauthorized accessories creates the risk of fire, electric shock, and personal injury.

■ AC Adaptor Handling Precautions

- Use a power outlet that is easily accessible so you can unplug the AC adaptor when a malfunction occurs or whenever else you need to do so.
- The AC adaptor is intended for indoor use only. Do not use it where it might be exposed to splashing or moisture. Do not place any container, such as a flower vase, that contains liquid on the AC adaptor.
- Store the AC adaptor in a dry place.
- Use the AC adaptor in an open, well-ventilated area.
- Never cover the AC adaptor with newspaper, a table cloth, a curtain, or any other similar item.
- Unplug the AC adaptor from the power outlet if you do not plan to use the product for a long time.
- Never try to repair the AC adaptor or modify it in any way.
- AC adaptor operating environment
 - Temperature: 0 to 40°C
 - Humidity: 10% to 90% RH
- Output polarity: 

■ Weld Lines

Lines may be visible on the exterior of the product. These are “weld lines” that result from the plastic molding process. They are not cracks or scratches.

■ Musical Instrument Etiquette

Always be aware of others around you whenever using this product. Be especially careful when playing late at night to keep the volume at levels that do not disturb others. Other steps you can take when playing late at night are closing windows and using headphones.

Appendix / Apéndice

Tone List / Lista de sonidos

PIANO/ORGAN		37	SYNTH-STR2	74	VOICE BASS
00	PIANO1	38	CHOIR	75	APPLAUSE
01	PIANO2	39	VOICE OOH	76	SYNTH-SFX
02	HONKY-TONK	BRASS/REED/PIPE		77	VEHICLE
03	STUDIOPIANO	40	TRUMPET	78	PHONE
04	ELEC PIANO1	41	TUBA	79	FUNNY
05	ELEC PIANO2	42	BRASS ENS	LAYER/SPLIT/PERCUSSION	
06	ELEC PIANO3	43	FR.HORN1	80	STR PIANO
07	ELEC PIANO4	44	FR.HORN2	81	STR E.PIANO
08	HARPSICHORD	45	BRASS1	82	CHOIRE.P
09	CLAVELECTRO	46	BRASS2	83	CHOIR ORGAN
10	ELEC ORGAN1	47	SYN-BRASS1	84	STR GUITAR
11	ELEC ORGAN2	48	SYN-BRASS2	85	STR HARP
12	ELEC ORGAN3	49	SYN-BRASS3	86	BRASS STR
13	ELEC ORGAN4	50	SOPRANO SAX	87	VIB PAD
14	CHURCH ORGAN	51	ALTO SAX	88	12 STR GTR
15	PIPE ORGAN	52	TENOR SAX	89	CHOIR STR
16	REED ORGAN	53	OBOE	90	BASS/PIANO
17	ACCORDION	54	CLARINET	91	BASS/E.PIANO
18	BANDONEON	55	PICCOLO	92	BASS/VIB
19	HARMONICA	56	FLUTE	93	BASS/GUT GTR
GUITAR/BASS/STRINGS		57	RECORDER	94	V.BASS/OOH
20	GUT GUITAR	58	PAN FLUTE	95	STR/PIANO
21	ACOUS GUITAR	59	WHISTLE	96	STR/TRUMPET
22	JAZZ GUITAR	SYNTH-SOUND		97	VIBRAPHONE
23	ELEC GUITAR	60	SYN-LEAD1	98	MARIMBA
24	MUTE GUITAR	61	SYN-LEAD2	99	PERCUSSION
25	DIST GUITAR	62	SYN-LEAD3		
26	WOOD BASS	63	SYN-CALLIOPE		
27	ELEC BASS	64	SYN-PAD1		
28	SLAP BASS	65	SYN-PAD2		
29	BANJO	66	SYN-PAD3		
30	VIOLIN	67	GLASS HMCA		
31	CELLO	68	COUNTRY FARM		
32	HARP	69	SYN-BASS		
33	STRINGS1	70	PEARL DROP		
34	STRINGS2	71	COSMIC SOUND		
35	STRINGS3	72	SOUNDTRACK		
36	SYNTH-STR1	73	SPACE PAD		

Rhythm List / Lista de ritmos

POPS I		35	HEAVY METAL	LATIN I	
00	CLUB POP	36	TWIST	70	BOSSA NOVA
01	VOCAL POP	37	NEW ORLNS R&R	71	SAMBA
02	RAP POP	38	CHICAGO BLUES	72	MAMBO
03	FUNKY POP 1	39	R&B	73	RHUMBA
04	SOUL BALLAD	JAZZ/FUSION		74	CHA-CHA-CHA
05	POP BALLAD	40	BIG BAND	75	MERENGUE
06	LOVE BALLAD	41	SLOW SWING	76	REGGAE
07	FUNKY POP 2	42	SWING	77	BOLERO
08	EPIC BALLAD	43	FOX TROT	78	TANGO 2
09	LITE POP	44	JAZZ WALTZ	79	LAMBADA
POPS II		45	MODERN JAZZ	LATIN II/VARIOUS I	
10	16 BEAT SHUFFLE	46	COOL	80	PUNTA
11	16 BEAT POP	47	HARD BOP	81	CUMBIA
12	16 BEAT FUNK	48	ACID JAZZ	82	SKA
13	8 BEAT POP	49	LATIN FUSION	83	TEX-MEX
14	8 BEAT SOUL	DANCE/FUNK		84	SALSA
15	8 BEAT SHUFFLE	50	VOCAL GROOVE	85	FOLKLORE
16	DANCE POP 1	51	RAVE	86	PASODOBLE
17	DANCE POP 2	52	CLUB GROOVE	87	RUMBA CATALANA
18	POP FUSION	53	TECHNO	88	SEVILLANA
19	FOLKIE POP	54	TRANCE	89	FOLK
ROCK I		55	HOUSE	VARIOUS II	
20	ROCK WALTZ	56	GROOVE SOUL	90	COUNTRY
21	SLOW ROCK 1	57	DISCO	91	BLUEGRASS
22	SLOW ROCK 2	58	RAP	92	TOWNSHIP
23	SOFT ROCK 1	59	FUNK	93	FAST GOSPEL
24	SOFT ROCK 2	EUROPEAN		94	SLOW GOSPEL
25	SOFT ROCK 3	60	POLKA 1	95	ADANI
26	POP ROCK 1	61	POLKA 2	96	BALADI
27	POP ROCK 2	62	MARCH 1	97	BAROQUE
28	50'S ROCK	63	MARCH 2	98	ENKA
29	60'S SOUL	64	WALTZ	99	NEW AGE
ROCK II		65	VIENNESE WALTZ		
30	4 BEAT ROCK	66	FRENCH WALTZ		
31	ROCK	67	SLOW WALTZ		
32	HEAVY ROCK	68	SERENADE		
33	8 BEAT ROCK	69	TANGO 1		
34	STRAIGHT ROCK				

Note Table / Tabla de notas

(1)	(2)	(3)	(1)	(2)	(3)	(1)	(2)	(3)	(1)	(2)	(3)	(1)	(2)	(3)
00	12	A	10	12	A	20	12	A	30	12	A	40	12	A
01	12	A	11	12	A	21	12	A	31	12	B	41	12	B
02	6	A	12	12	A	22	12	A	32	12	A	42	6	A
03	6	A	13	6	A	23	12	A	33	12	A	43	12	B
04	12	A	14	12	A	24	12	A	34	12	A	44	6	B
05	12	A	15	6	A	25	12	A	35	6	A	45	12	B
06	6	A	16	12	A	26	12	B	36	12	A	46	6	B
07	6	A	17	6	A	27	12	B	37	6	A	47	12	B
08	12	A	18	12	A	28	12	B	38	12	A	48	6	B
09	12	A	19	12	A	29	12	A	39	12	A	49	6	B

(1)	(2)	(3)	(1)	(2)	(3)	(1)	(2)	(3)	(1)	(2)	(3)	(1)	(2)	(3)
50	12	A	60	12	A	70	6	A	80	6	A	90	12	E
51	12	A	61	6	A	71	6	A	81	6	A	91	6	E
52	12	A	62	12	A	72	6	A	82	6	A	92	12	E
53	12	A	63	6	A	73	6	A	83	6	A	93	12	E
54	12	A	64	6	A	74	12	B	84	6	A	94	12	E
55	12	C	65	6	A	75	12	D	85	6	A	95	12	E
56	12	A	66	6	A	76	6	A	86	6	B	96	12	E
57	12	A	67	6	A	77	6	D	87	6	A	97	12	A
58	12	A	68	6	A	78	12	D	88	6	A	98	12	A
59	12	A	69	12	B	79	6	D	89	6	A	99	12	D

- (1): Tone number
 (2): Maximum polyphony
 (3): Range type

- (1): Número de sonido
 (2): Polifonía máxima
 (3): Tipo de gama

- See the illustration below for a description of range types (A through E).
- Vea la ilustración siguiente para una descripción de los tipos de gama (A a E).

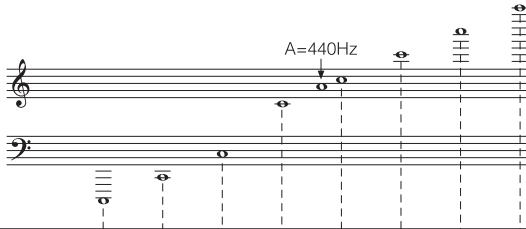

Range Type Tipo de gama	C-1	C0	A0C1	A1C2	A2C3	C4	C5	C6	C7	C8	C9	G9	
A (Standard type) (Tipo estándar)													
B (Low pitch instruments) (Instrumentos de altura tonal baja)													
C ("55 PICCOLO" only) (Solamente "55 PICCOLO")													
D (Sound Effect) (Efecto de sonido)	No scale for tones. Sin escala para los sonidos.												
E (SPLIT) (División)	Scale changes in accordance with tone. La escala cambia de acuerdo con el sonido.												



.....Range of keyboard play
.....Gama de ejecución de teclado

Fingered Chord Chart / Cuadros de acordes Fingered

This table shows the left-hand fingerings (including inverted forms) for a number of often-used chords.

Esta tabla muestra las digitaciones (incluyendo las formas invertidas) para varios de los acordes más a menudo usados.

Chord Type Root	M	m	7	m7	dim7	M7	m7-5	dim
C								
C# (Db)								
D								
Eb (D#)								
E								
F								
F# (Gb)								
G								
Ab (G#)								
A					*			
Bb (A#)					*			
B					*			

- Chords marked with asterisk (*) cannot be played in the Fingered Mode on this keyboard.
- En este teclado, los acordes marcados con asterisco (*) no pueden ejecutarse en el modo Fingered.

Chord Root Type	aug	sus4	7 sus4	m add9	m M7	7-5	add9
C							
C# (Db)							
D							
Eb (D#)							
E							
F							
F# (Gb)							
G							
Ab (G#)							
A							
Bb (A#)	*						
B	*						

Percussion Instrument List / Lista de instrumentos de percusión

- PERCUSSION (tone 99) assigns 39 percussion sound to the keyboard as illustrated below. The sound assigned to each key are indicated above the keyboard.
- PERCUSSION (sonido 99) asigna 39 sonidos de percusión al teclado como se ilustra debajo. Los sonidos asignados a cada tecla se indican sobre el teclado.

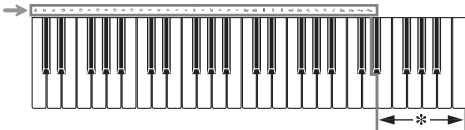

- * No sound is produced when the keys in this range are pressed.
- * Cuando se presionan las teclas en esta gama no se produce ningún sonido.

BASS DRUM	CRASH CYMBAL 1	MUTE HIGH CONGA
SIDE STICK	HIGH TOM 1	OPEN HIGH CONGA
ACOUSTIC SNARE	RIDE CYMBAL 1	LOW CONGA
HAND CLAP	CHINESE CYMBAL	HIGH TIMBALE
ELECTRIC SNARE	RIDE BELL	LOW TIMBALE
LOW TOM 2	TAMBOURINE	HIGH AGOGO
CLOSED HI-HAT	SPLASH CYMBAL	LOW AGOGO
LOW TOM 1	COWBELL	CABASA
PEDAL HI-HAT	CRASH CYMBAL 2	MARACAS
MID TOM 2	CLAVES	VOICE BASS DRUM
OPEN HI-HAT	RIDE CYMBAL 2	VOICE SNARE
MID TOM 1	HIGH BONGO	VOICE CLOSED HI-HAT
HIGH TOM 2	LOW BONGO	VOICE OPEN HI-HAT

Song List / Lista de canciones

SONG BANK / BANCO DE CANCIONES

00	TWINKLE TWINKLE LITTLE STAR	25	SWANEE RIVER (OLD FOLKS AT HOME)
01	GRANDFATHER'S CLOCK	26	YANKEE DOODLE
02	WHEN THE SAINTS GO MARCHING IN	27	HOME ON THE RANGE
03	WE WISH YOU A MERRY CHRISTMAS	28	OH! SUSANNA
04	JINGLE BELLS	29	BEAUTIFUL DREAMER
05	SILENT NIGHT	30	TURKEY IN THE STRAW
06	O CHRISTMAS TREE	31	ALOHA OE
07	GREENSLEEVES	32	JAMAICA FAREWELL
08	AMAZING GRACE	33	LA CUCARACHA
09	AULD LANG SYNE	34	LA PALOMA
10	ACH DU LIEBER AUGUSTIN	35	TROIKA
11	LONDON BRIDGE	36	SZLA DZIEWECZKA
12	J'AI PERDU LE DO DE MA CLARINETTE	37	WALTZING MATILDA
13	SUR LE PONT D'AVIGNON	38	AJO MAMMA
14	I'VE BEEN WORKING ON THE RAILROAD	39	RASA SAYANG
15	LITTLE BROWN JUG	40	ODE TO JOY
16	LONG LONG AGO	41	BRIDAL MARCH FROM "LOHENGGRIN"
17	SIPPIN' CIDER THROUGH A STRAW	42	AIR FROM "SUITE no.3"
18	UNDER THE SPREADING CHESTNUT TREE	43	SCENE FROM "SWAN LAKE"
19	SUMM SUMM SUMM	44	MARCH FROM "THE NUTCRACKER"
20	DANNY BOY	45	TRIUMPHAL MARCH FROM "AIDA"
21	MY DARLING CLEMENTINE	46	TOY SYMPHONY
22	HOUSE OF THE RISING SUN	47	SERENADE FROM "EINE KLEINE NACHTMUSIK"
23	AURA LEE	48	CHANSON DU TOREADOR FROM "CARMEN"
24	WHEN JOHNNY COMES MARCHING HOME	49	SPRING FROM "THE FOUR SEASONS"



This recycle mark indicates that the packaging conforms to the environmental protection legislation in Germany.

Esta marca de reciclaje indica que el empaquetado se ajusta a la legislación de protección ambiental en Alemania.

CASIO®

CASIO COMPUTER CO.,LTD.

6-2, Hon-machi 1-chome
Shibuya-ku, Tokyo 151-8543, Japan

 MA1006-B Printed in China
CTK240/245ES1A

Free Manuals Download Website

<http://myh66.com>

<http://usermanuals.us>

<http://www.somanuals.com>

<http://www.4manuals.cc>

<http://www.manual-lib.com>

<http://www.404manual.com>

<http://www.luxmanual.com>

<http://aubethermostatmanual.com>

Golf course search by state

<http://golfingnear.com>

Email search by domain

<http://emailbydomain.com>

Auto manuals search

<http://auto.somanuals.com>

TV manuals search

<http://tv.somanuals.com>