



ES

LK-70s

USER'S GUIDE GUÍA DEL USUARIO



LK70S-ES-1

CASIO®



GUIDELINES LAID DOWN BY FCC RULES FOR USE OF THE UNIT IN THE U.S.A. (not applicable to other areas).

NOTICE

This equipment has been tested and found to comply with the limits for a Class B digital device, pursuant to Part 15 of the FCC Rules. These limits are designed to provide reasonable protection against harmful interference in a residential installation. This equipment generates, uses and can radiate radio frequency energy and, if not installed and used in accordance with the instructions, may cause harmful interference to radio communications. However, there is no guarantee that interference will not occur in a particular installation. If this equipment does cause harmful interference to radio or television reception, which can be determined by turning the equipment off and on, the user is encouraged to try to correct the interference by one or more of the following measures:

- Reorient or relocate the receiving antenna.
- Increase the separation between the equipment and receiver.
- Connect the equipment into an outlet on a circuit different from that to which the receiver is connected.
- Consult the dealer or an experienced radio/TV technician for help.

FCC WARNING

Changes or modifications not expressly approved by the party responsible for compliance could void the user's authority to operate the equipment.

Important!

Please note the following important information before using this product.

- Before using the optional AD-5 Adaptor to power the unit, be sure to check the AC Adaptor for any damage first. Carefully check the power cord for breakage, cuts, exposed wire and other serious damage. Never let children use an AC adaptor that is seriously damaged.
- Never attempt to recharge batteries.
- Do not use rechargeable batteries.
- Never mix old batteries with new ones.
- Use recommended batteries or equivalent types.
- Always make sure that positive (+) and negative (-) poles are facing correctly as indicated near the battery compartment.
- Replace batteries as soon as possible after any sign they are getting weak.
- Do not short-circuit the battery terminals.
- The product is not intended for children under 3 years.
- Use only CASIO AD-5 adaptor.
- The AC adaptor is not a toy.
- Be sure to disconnect the AC adaptor before cleaning the product.



CASIO Europe GmbH
Bornbarch 10, 22848 Norderstedt, Germany

653A-E-002A



Safety Precautions

Congratulations on your selection of the CASIO electronic musical instrument.

- Before using the instrument, be sure to carefully read through the instructions contained in this manual.
- Please keep all information for future reference.

Symbols

Various symbols are used in this user's guide and on the product itself to ensure that the product is used safely and correctly, and to prevent injury to the user and other persons as well as damage to property. Those symbols along with their meanings are shown below.

DANGER

This symbol indicates information that, if ignored or applied incorrectly, creates the danger of death or serious personal injury.

WARNING

This indication stipulates matters that have the risk of causing death or serious injury if the product is operated incorrectly while ignoring this indication.

CAUTION

This indication stipulates matters that have the risk of causing injury as well as matters for which there is the likelihood of occurrence of physical damage only if the product is operated incorrectly while ignoring this indication.

Symbol Examples



This triangle symbol (\triangle) means that the user should be careful. (The example at left indicates electrical shock caution.)



This circle with a line through it (\odot) means that the indicated action must not be performed. Indications within or nearby this symbol are specifically prohibited. (The example at left indicates that disassembly is prohibited.)



The black dot (\bullet) means that the indicated action must be performed. Indications within this symbol are actions that are specifically instructed to be performed. (The example at left indicates that the power plug must be unplugged from the electrical socket.)



Safety Precautions

DANGER

Alkaline Batteries

Perform the following steps immediately if fluid leaking from alkaline batteries ever gets into your eyes.

1. Do not rub your eyes! Rinse them with water.
 2. Contact your physician immediately.
- Leaving alkaline battery fluid in your eyes can lead to loss of sight.



WARNING

Smoke, Strange Odor, Overheating

Continued use of the product while it is emitting smoke, a strange odor, or heat creates the risk of fire and electric shock. Take the following steps immediately.

1. Turn off power.
2. If you are using the AC adaptor for power, unplug it from the wall outlet.
3. Contact your original retailer or an authorized CASIO Service Provider.

AC Adaptor

- Misuse of the AC adaptor creates the risk of fire and electric shock. Always make sure you observe the following precautions.
 - Be sure to use only the AC adaptor that is specified for this product.
 - Use only a power source whose voltage is within the rating marked on the AC adaptor.
 - Do not overload electrical outlets and extension cords.
- Misuse of the AC adaptor's electric cord can damage or break it, creating the risk of fire and electric shock. Always make sure you observe the following precautions.
 - Never place heavy objects on the cord or subject it to heat.
 - Never try to modify the cord or subject it to excessive bending.
 - Never twist or stretch the cord.
 - Should the electric cord or plug become damaged, contact your original retailer or authorized CASIO Service Provider.



- Never touch the AC adaptor while your hands are wet. Doing so creates the risk of electric shock.
- Use the AC adaptor where it will not be splashed with water. Water creates the risk of fire and electric shock.
- Do not place a vase or any other container filled with liquid on top of the AC adaptor. Water creates the risk of fire and electric shock.



Batteries

Misuse of batteries can cause them to leak, resulting in damage to nearby objects, or to explode, creating the risk of fire and personal injury. Always make sure you observe the following precautions.

- Never try to take batteries apart or allow them to become shorted.
- Never expose batteries to heat or dispose of them by incineration.
- Never mix old batteries with new ones.
- Never mix batteries of different types.
- Do not charge the batteries.
- Make sure the positive (+) and negative (-) ends of the batteries are facing correctly.



Do not incinerate the product.

Never throw the product into fire. Doing so can cause it to explode, creating the risk of fire and personal injury.



Water and Foreign Matter

Water, other liquids, and foreign matter (such as pieces of metal) getting into the product create the risk of fire and electric shock. Take the following steps immediately.

1. Turn off power.
2. If you are using the AC adaptor for power, unplug it from the wall outlet.
3. Contact your original retailer or an authorized CASIO Service Provider.



Disassembly and Modification

Never try to take this product apart or modify it in any way. Doing so creates the risk of electric shock, burn injury, or other personal injury. Leave all internal inspection, adjustment, and maintenance up to your original retailer or authorized CASIO Service Provider.





Dropping and Impact

Continued use of this product after it has been damaged by dropping or subjecting it to strong impact creates the risk of fire and electric shock. Take the following steps immediately.

1. Turn off power.
2. If you are using the AC adaptor for power, unplug it from the wall outlet.
3. Contact your original retailer or an authorized CASIO Service Provider.



Plastic Bags

Never place the plastic bag the product comes in over your head or in your mouth. Doing so creates the risk of suffocation. Particular care concerning this precaution is required where small children are present.



Keep off of the product and stand.*

Climbing onto the product or stand can cause it to tip over or become damaged. Particular care concerning this precaution is required where small children are present.



Location

Avoid locating the product on an unstable stand, on an uneven surface, or any other unstable location. An unstable location can cause the product to fall over, creating the risk of personal injury.



CAUTION

AC Adaptor

● Misuse of the AC adaptor creates the risk of fire and electric shock. Always make sure you observe the following precautions.

- Do not locate the electric cord near a stove or other sources of heat.
- Never pull on the cord when unplugging from the electrical outlet. Always grasp the AC adaptor when unplugging.



● Misuse of the AC adaptor creates the risk of fire and electric shock. Always make sure you observe the following precautions.

- Insert the AC adaptor into the wall outlet as far as it will go.
- Unplug the AC adaptor from the wall outlet during lightening storms or before leaving on a trip or other long-term absence.
- At least once a year, unplug the AC adaptor from the wall outlet and wipe away any dust that is built up in the area around the prongs of the plug.



Relocating the Product

Before relocating the product, always unplug the AC adaptor from the wall outlet and disconnect all other cables and connecting cords. Leaving cords connected creates the risk of damage to the cords, fire, and electric shock.



Cleaning

Before cleaning the product, always unplug the AC adaptor from the wall outlet first. Leaving the AC adaptor plugged in creates the risk of damage to the AC adaptor, fire, and electric shock.



Batteries

Misuse of batteries can cause them to leak resulting in damage to nearby objects, or to explode, creating the risk of fire and personal injury. Always make sure you observe the following precautions.

- Use only batteries that are specified for use with this product.
- Remove batteries from the product if you do not plan to use it for a long time.





Safety Precautions

Connectors

Connect only the specified devices and equipment to the product's connectors. Connection of a non-specified device or equipment creates the risk of fire and electric shock.



Location

Avoid the following locations for this product. Such locations create the risk of fire and electric shock.



- Areas subject to high humidity or large amounts of dust.
- In food preparation areas or other areas subject to oil smoke.
- Near air conditioning equipment, on a heated carpet, in areas exposed to direct sunlight, inside of a vehicle parked in the sun, or any other area that subjects the product to high temperatures.

Display Screen

- Never push on the display screen's LCD panel or subject it to strong impact. Doing so can cause the LCD panel's glass to crack, creating the risk of personal injury.
- Should the LCD panel ever crack or break, never touch the liquid inside of the panel. LCD panel liquid can cause skin irritation.
- Should LCD panel liquid ever get inside your mouth, immediately wash out your mouth with water and contact your physician.
- Should LCD panel liquid ever get into your eyes or onto your skin, rinse with clear water for at least 15 minutes, and then contact a physician.



Sound Volume

Do not listen to music at very loud volumes for long periods. Particular care concerning this precaution is required when using headphones. High volume settings can damage your hearing.



Health Precaution

In extremely rare cases, exposure to strong sudden light or flashing light can cause momentary muscle spasms, loss of consciousness, or other physical problems with some individuals.

- If you suspect that you might be susceptible to any condition such as this, be sure to consult with your physician before using this product.
- Use this product in an area that is well illuminated.



- Should you ever feel any symptoms similar to those described above when using this product, stop using it immediately and contact your physician.



Heavy Objects

Never place heavy object on top of the product.

Doing so can make the product top heavy, causing the product to tip over or the object to fall from it, creating the risk of personal injury.



Correct Stand* Assembly

An incorrectly assembled stand can tip over, causing the product to fall and creating the risk of personal injury.

Make sure you assemble the stand correctly, following the assembly instructions that come with it. Make sure you mount the product on the stand correctly.



* Stand is available as an option.

IMPORTANT!

When using batteries, be sure to replace them or shift to one of the alternate power sources whenever you notice any of the following symptoms.

- Dim power supply indicator
- Instrument does not turn on
- Dim, difficult to read display
- Abnormally low speaker/headphone volume
- Distortion of sound output
- Occasional interruption of sound when playing at high volumes
- Sudden power failure when playing at high volumes
- Dimming of the display when playing at high volume
- Continued sound output even after you release a key
- A totally different tone may sound
- Abnormal rhythm pattern and demo tune play
- Abnormally low microphone volume
- Distortion of microphone input
- Dim power supply indicator when a microphone is used
- Sudden power failure when using the microphone
- Dimming of keyboard lights when notes sound
- Loss of power, sound distortion, or low volume when playing from a connected computer



Main Features

☐ 100 tones

A wide selection of tones includes grand piano and synthesized sounds, drum sets, and much more.

☐ 3-Step Lesson System

The 3-Step Lesson System lets you practice at your own pace. The keyboard automatically grades your performances, so you can trace your progress as you improve.

- 3-Step Lesson System: Use any of the keyboard's built-in tunes and SMF data from a SmartMedia™ card to learn to play as the keyboard keys light to teach you the correct notes. First practice the timing of the notes. Next, play along at your own pace. Soon you will be ready for step three, where you play along at normal speed.
 - * Note that key lights may be difficult to see under direct sunlight or under other very bright lighting.
- Evaluation System: The keyboard can be configured to rate your performances during Step 3 lesson by assigning points.

☐ Sing-along

Simply connect a commercially available microphone to the microphone jack* and you can sing along with the keyboard's built-in tunes and SMF data from a SmartMedia™ card.

* If a microphone was included with your keyboard, use that microphone.

☐ 60 built-in tunes

You can simply enjoy listening to the built-in tunes, or eliminate either hand part of a tune, and then play along on the keyboard.

☐ 50 rhythms

A selection of rhythms cover rock, pops, jazz and just about any other musical style imaginable.

☐ Auto Accompaniment

Simply play a chord and the corresponding rhythm, bass, and chord parts play along automatically.

☐ Musical Information System

A big LCD screen graphically shows you fingerings, making keyboard play more informative and enjoyable than ever before.

☐ Storing and Playing Back Tune Data You Transferred from Your Computer

You can connect your keyboard to a computer, use special CASIO conversion software to convert SMF data you purchase or create to CASIO format, and then transfer it to the keyboard.

☐ SmartMedia™ Card Slot

You can load a card with a standard MIDI file (SMF) and play it back on the keyboard.



Contents

Safety Precautions E-1

Main Features E-5

Contents E-6

General Guide E-8

Attaching the Score Stand E-9

Quick Reference E-11

To play the keyboard E-11

Care of your keyboard E-12

Power Supply E-13

Using batteries E-13

Using the AC Adaptor E-14

Auto Power Off E-15

Power On Alert E-15

Connections E-16

Phones/Output Jack E-16

USB port E-16

SUSTAIN Jack E-16

Microphone Jack E-16

Accessories and Options E-16

Basic Operations E-17

To play the keyboard E-17

Selecting a Tone E-17

Turning the Key Light System

On and Off E-18

Playing a Built-in Tune E-19

To play back a Song Bank tune E-19

Adjusting the Tempo E-20

To change the tone used for

the melody of a Song Bank tune E-20

To play all tunes in succession E-20

3-Step Lesson System E-21

Evaluation Mode E-22

Using the Lesson Functions and

Evaluation Mode E-23

Step 1 – Master the timing. E-23

Step 2 – Master the notes. E-24

Step 3 – Play at normal speed. E-24

Voice Fingering Guide E-25

**Using a Microphone for
Sing Along E-26**

Auto Accompaniment E-28

Playing rhythms E-28

Using auto-accompaniment E-28

Improvising with the preset patterns E-31



Keyboard Settings E-32

- Transposing the Keyboard E-32
- About FUNCTION button E-32
- Adjusting Accompaniment Volume E-33
- Tuning the Keyboard E-33

Connection to a Computer E-34

- Connecting to a Computer E-34
- Expanding the Selections in the Song Bank Tunes E-35
- General MIDI Tone E-35
- Changing the Settings E-35
- Messages E-38

Using a SmartMedia Card... E-40

- Getting Ready E-41
- Reading a SmartMedia card E-42
- SmartMedia Card Error Messages E-43

Troubleshooting E-45

Specifications E-47

Appendix A-1

- Tone List / Note Table A-1
- Fingered Chord Charts A-5
- Rhythm List A-7
- Song Bank List A-7

MIDI messages that can be sent and received using the USB port

Company and product names used in this manual may be registered trademarks of others.



General Guide

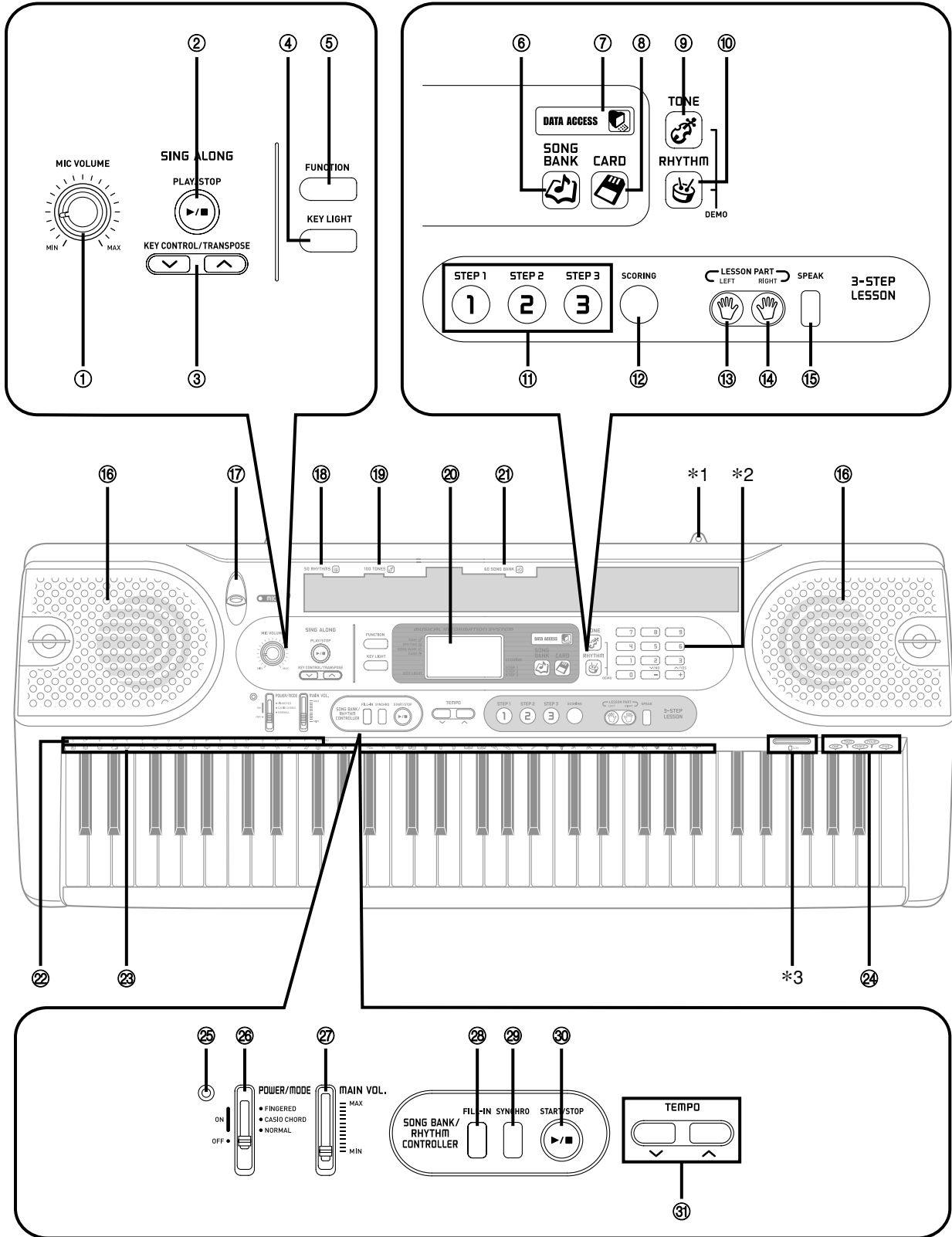



- ① MIC VOLUME knob
- ② PLAY/STOP button
- ③ KEY CONTROL/TRANSPOSE buttons
- ④ KEY LIGHT button
- ⑤ FUNCTION button
- ⑥ SONG BANK button
- ⑦ DATA ACCESS lamp
- ⑧ CARD button
- ⑨ TONE button
- ⑩ RHYTHM button

● **3-STEP LESSON SYSTEM**

- ⑪ STEP 1 to 3 button
- ⑫ SCORING button
- ⑬ LEFT button
- ⑭ RIGHT button
- ⑮ SPEAK button

- ⑯ Speaker
- ⑰ MIC jack
- ⑱ RHYTHM list
- ⑲ TONE list
- ⑳ Display
- ㉑ SONG BANK list
- ㉒ CHORD root names
- ㉓ Percussion instrument list
- ㉔ Voice 1 to 5
- ㉕ Power indicator
- ㉖ POWER/MODE switch
- ㉗ MAIN VOL. slider

● **SONG/RHYTHM CONTROLLER**

- ⑳ FILL-IN button
- ㉑ SYNCHRO button
- ⑳ START/STOP button
- ㉒ TEMPO buttons

***1 Attaching the Score Stand**

Insert both ends of the music stand provided with the keyboard into the two holes on the top surface.

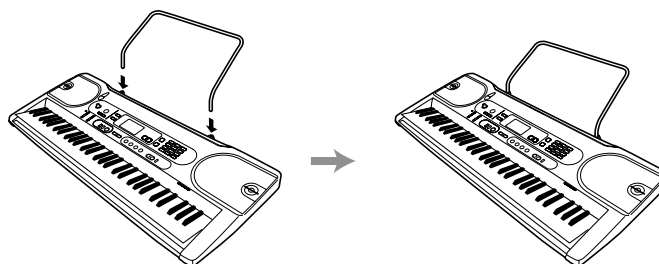



General Guide

*2

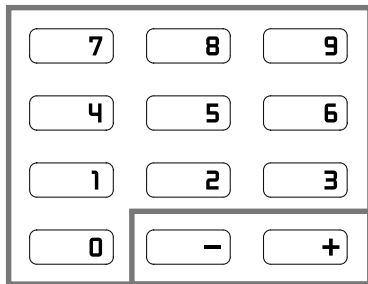

③② Number buttons

③③ [+]/[-] buttons

- For input of numbers to change a displayed number or setting.
- Negative values cannot be input using the number buttons. Use [+] (increase) and [-] (decrease) instead.

*3

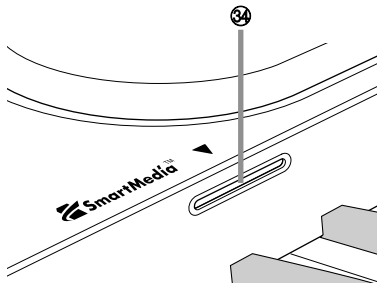

③④ Card slot

Rear Panel

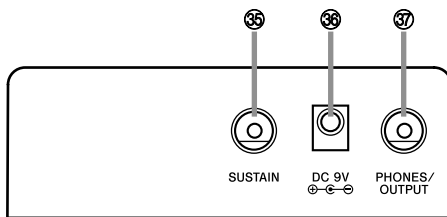

- ③⑤ SUSTAIN jack
- ③⑥ DC 9V jack
- ③⑦ PHONES/OUTPUT jack

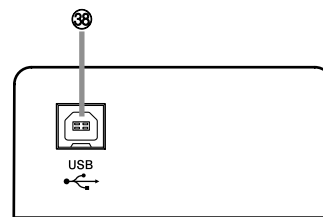

③⑧ USB port

Quick Reference

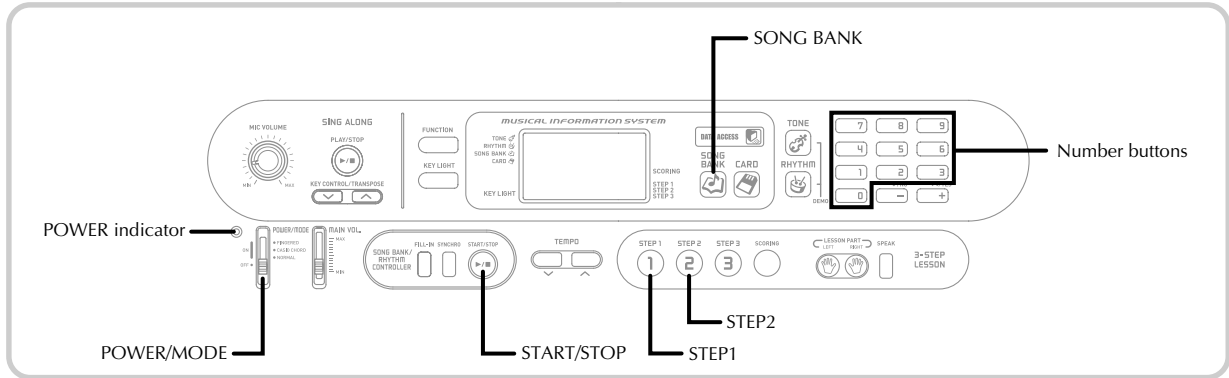

This section provides a quick overview of keyboard operation using steps one and two of the 3-step lesson feature.

To play the keyboard

- 1 Set the POWER/MODE switch to NORMAL.
 - This causes the power indicator to light.

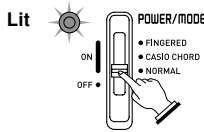

- 2 Press the SONG BANK button.

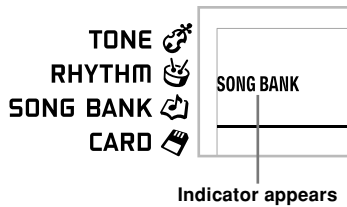

- 3 Find the tune you want to play in the SONG BANK List, and then use the number buttons to input its two-digit number.
 - See page A-7 for the Song Bank List.
 - Example:* To select "38 ALOHA OE", input 3 and then 8.



- 4 Press the STEP 1 button or STEP 2 button.
 - The keyboard sounds a count beat and waits for you to play something on the keyboard. The keys that you need to press first flash.
- 5 Play the melody along with the selected tune's accompaniment.
 - Play in accordance with the fingerings that appear on the display.

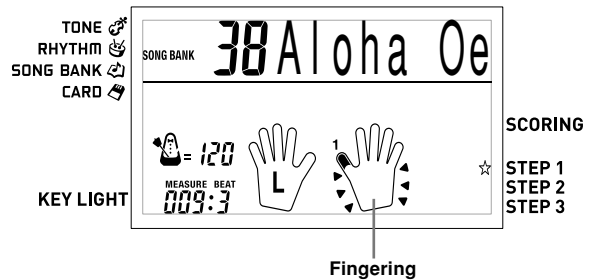



Quick Reference

If you selected lesson Step 1

- Play the notes on the keyboard.
- Accompaniment (left-hand part) plays in time with the notes.
- With Step 1, the correct melody note is played no matter which keyboard key you press.

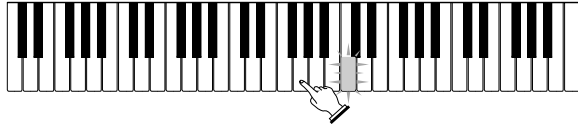

If you selected lesson Step 2

- Play the correct notes on the keyboard.



- Press the keyboard key that lights. Note that with a Piano Solo tune, the keyboard key light turns off as soon as you press the key.
- The keyboard key for the next note you will need to play flashes.
- Accompaniment (left-hand part) plays in time with the notes, as long as you press the correct keyboard keys.

- 6** To stop play at any time, press the START/STOP button.

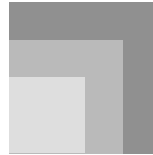

Care of your keyboard

Avoid heat, humidity or direct sunlight.

Do not overexpose the instrument to direct sunlight, or place it near an air conditioner, or in any extremely hot place.

Do not use near a TV or radio.

This instrument can cause video or audio interference with TV and radio reception. If this happens, move the instrument away from the TV or radio.

Do not use lacquer, thinner or similar chemicals for cleaning.

Clean the keyboard with a soft cloth dampened in a weak solution of water and a neutral detergent. Soak the cloth in the solution and squeeze until it is almost dry.

Avoid use in areas subjected to temperature extremes.

Extremely high or low temperature can cause figures on the LCD screen to become dim and difficult to read. This condition should correct itself when the keyboard is brought back to normal temperature.

NOTE

- You may notice lines in the finish of the case of this keyboard. These lines are a result of the molding process used to shape the plastic of the case. They are not cracks or breaks in the plastic, and are no cause for concern.



Power Supply

This keyboard can be powered by current from a standard household wall outlet (using the specified AC adaptor) or by batteries. Always make sure you turn the keyboard off whenever you are not using it.

Using batteries

Always make sure you turn off the keyboard before loading or replacing batteries.

To load batteries

- 1 Remove the battery compartment cover.
- 2 Load 6 AA-size batteries into the battery compartment.
 - Make sure that the positive (+) and negative (-) ends are facing correctly.

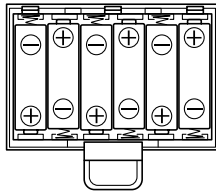

- 3 Insert the tabs on the battery compartment cover into the holes provided and close the cover.

NOTE

- The keyboard may not function correctly if you load or replace batteries with power turned on. If this happens, turning the keyboard off and then back on again should return functions back to normal.

Important Battery Information

- The following shows the approximate battery life.

Manganese batteries	1 hour
Alkaline batteries	4 hours

 The above value is standard battery life at normal temperature, with the keyboard volume at medium setting. Temperature extremes or playing at very loud volume settings can shorten battery life.
- Any of the following symptoms indicate low battery power. Replace batteries as soon as possible whenever any of the following occurs.
 - Dim power supply indicator
 - Instrument does not turn on
 - Dim, difficult to read display
 - Abnormally low speaker/headphone volume
 - Distortion of sound output
 - Occasional interruption of sound when playing at high volumes
 - Sudden power failure when playing at high volumes
 - Dimming of the display when playing at high volume
 - Continued sound output even after you release a key
 - A totally different tone may sound
 - Abnormal rhythm pattern and demo tune play
 - Abnormally low microphone volume
 - Distortion of microphone input
 - Dim power supply indicator when a microphone is used
 - Sudden power failure when using the microphone
 - Dimming of keyboard lights when notes sound
 - Loss of power, sound distortion, or low volume when playing from a connected computer

⚠ WARNING

Misuse of batteries can cause them to leak, resulting in damage to nearby objects, or to explode, creating the risk of fire and personal injury. Always make sure you observe the following precautions.

- Never try to take batteries apart or allow them to become shorted. 
- Never expose batteries to heat or dispose of them by incineration.
- Never mix old batteries with new ones.
- Never mix batteries of different types.
- Do not charge the batteries.
- Make sure the positive (+) and negative (-) ends of the batteries are facing correctly.

⚠ CAUTION

Misuse of batteries can cause them to leak resulting in damage to nearby objects, or to explode, creating the risk of fire and personal injury. Always make sure you observe the following precautions.

- Use only batteries that are specified for use with this product. 
- Remove batteries from the product if you do not plan to use it for a long time.



Power Supply

Using the AC Adaptor

Make sure that you use only the AC adaptor specified for this keyboard.

Specified AC Adaptor: AD-5

[Rear Panel]

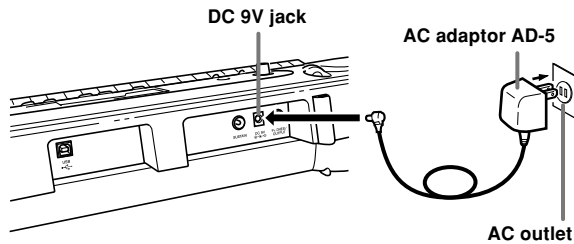

Also note the following important warnings and precautions when using the AC adaptor.

⚠ WARNING

Misuse of the AC adaptor creates the risk of fire and electric shock. Always make sure you observe the following precautions.

- Be sure to use only the AC adaptor that is specified for this product.
- Use only a power source whose voltage is within the rating marked on the AC adaptor. **!**
- Do not overload electrical outlets and extension cords. **⊘**
- Never place heavy objects on the cord or subject it to heat. **⊘**
- Never try to modify the cord or subject it to excessive bending.
- Never twist or stretch the cord.
- Should the electric cord or plug become damaged, contact your original retailer or authorized CASIO Service Provider. **!**
- Never touch the AC adaptor while your hands are wet. Doing so creates the risk of electric shock. **⊘**
- Use the AC adaptor where it will not be splashed with water. Water creates the risk of fire and electric shock. **!**
- Do not place a vase or any other container filled with liquid on top of the AC adaptor. Water creates the risk of fire and electric shock. **⊘**

⚠ CAUTION

Misuse of the AC adaptor creates the risk of fire and electric shock. Always make sure you observe the following precautions.

- Do not locate the electric cord near a stove or other sources of heat. **⊘**
- Never pull on the cord when unplugging from the electrical outlet. Always grasp the AC adaptor when unplugging.
- Insert the AC adaptor into the wall outlet as far as it will go. **!**
- Unplug the AC adaptor from the wall outlet during lightning storms or before leaving on a trip or other long-term absence.
- At least once a year, unplug the AC adaptor from the wall outlet and wipe away any dust that is built up in the area around the prongs of the plug.

IMPORTANT!

- Make sure that the keyboard is turned off before connecting or disconnecting the AC adaptor.
- Using the AC adaptor for a long time can cause it to become warm to the touch. This is normal and does not indicate malfunction.



Auto Power Off

When you are using battery power, keyboard power turns off automatically whenever you leave it on without performing any operation for about 6 minutes. When this happens, adjust the POWER/MODE switch to turn power back on.

NOTE

- Auto Power Off is disabled (it does not function) when you are using the AC adaptor to power the keyboard.

To disable Auto Power Off

Hold down the TONE button while turning on the keyboard to disable Auto Power Off.

NOTE

- When this function is turned off, the keyboard does not turn off automatically no matter how long it is left with no operation being performed.
- Auto Power Off is enabled again when you manually turn off power and then turn it back on again.

Power On Alert

Keyboard keys light to alert you if you leave power on and do not perform any operation for about 6 minutes. Note that keys light only, and no sound is produced. When this happens, press any button or keyboard key to clear the power on alert.

NOTE

- Power on alert operates only when you are powering the keyboard using the AC adaptor. It does not operate when you are using batteries.

To disable Auto Power Off and power on alert

Hold down the TONE button while turning on the keyboard to disable Auto Power Off and power on alert.

- When these functions are turned off, the keyboard does not turn off automatically and no alert is performed no matter how long it is left with no operation being performed.
- Auto Power Off and power on alert are enabled again when you manually turn off power and then turn it back on again.

Connections

Phones/Output Jack

PREPARATION

- Before connecting headphones or other external equipment, be sure to first turn down the volume settings of the keyboard and the connected equipment. You can then adjust volume to the desired level after connections are complete.

[Rear Panel]

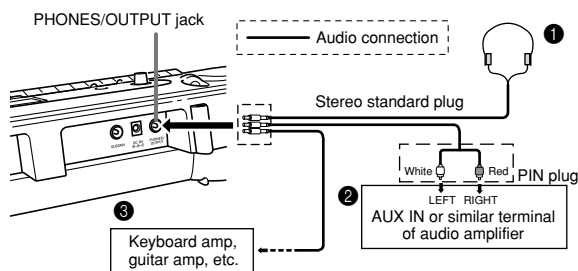

Connecting Headphones (Figure 1)

Connecting headphones cuts off output from the keyboard's built-in speakers, so you can play even late at night without disturbing anyone.

Audio Equipment (Figure 2)

Connect the keyboard to a audio equipment using a commercially available connecting cord with a standard plug on one end and two PIN plugs on the other end. Note that the standard plug you connect to the keyboard must be a stereo plug, otherwise you will be able to output only one of stereo channels. In this configuration, you normally set the input selector of the audio equipment to the terminal (usually marked AUX IN or something similar) where the cord from the keyboard is connected. See the user documentation that comes with your audio equipment for full details.

Musical Instrument Amplifier (Figure 3)

Use a commercially available connecting cord to connect the keyboard to a musical instrument amplifier.

NOTE

- Be sure to use a connecting cord that has a stereo standard plug on the end you connect to the keyboard, and a connector that provides dual channel (left and right) input to the amplifier to which you are connecting. The wrong type of connector at either end can cause one of the stereo channels to be lost.

When connected to a musical instrument amplifier, set the volume of the keyboard to a relatively low level and make output volume adjustments using the amplifier's controls.

Connection Example

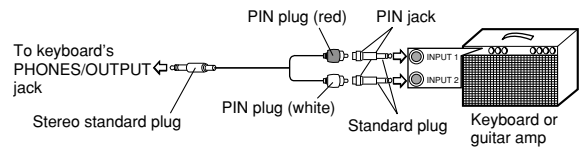

USB port

You can also connect the keyboard to a computer. See "Connection to a Computer" on page E-34 for details.

SUSTAIN Jack

You can connect an optional sustain pedal (SP-3 or SP-20) to the SUSTAIN jack to enable the capabilities described below.

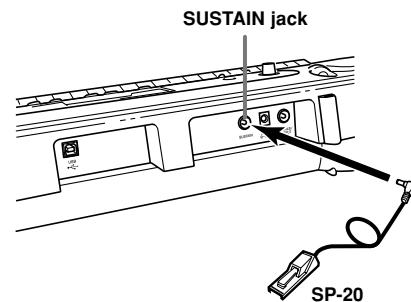

- With piano tones, depressing the pedal causes notes to linger, much like a piano's damper pedal.
- With organ tones, depressing the pedal causes notes to continue to sound until the pedal is released.

Microphone Jack

You can connect a commercially available microphone to the microphone jack and sing along with notes played on the keyboard. For details, see "Using a Microphone for Sing Along" on page E-26.

Accessories and Options

Use only the accessories and options specified for this keyboard. Use of non-authorized items creates the danger of fire, electrical shock, and personal injury.

Basic Operations

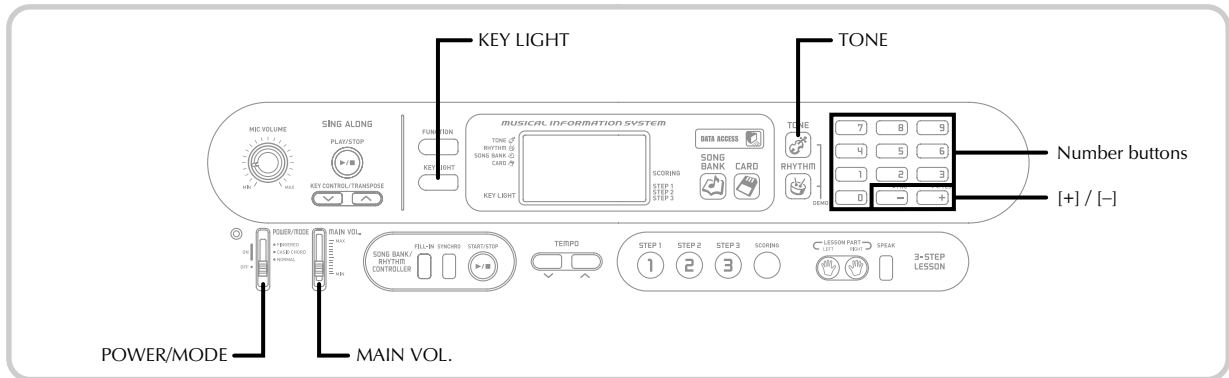

This section provides information on performing basic keyboard operations.

To play the keyboard

- 1 Set the POWER/MODE switch to NORMAL.
- 2 Use the MAIN VOL. slider to set the volume to a relatively low level.
- 3 Play something on the keyboard.
 - The keyboard's initial power on default setting is Song Bank Mode. The tone that is initially assigned to the keyboard is the tone used by Song Bank tune number 00.

Selecting a Tone

This keyboard comes with 100 built-in tones. Use the following procedure to select the tone you want.

To select a tone

- 1 Find the tone you want to use in the TONE List and note its tone number.
 - Not all of the available tones are shown on the tone list printed on the keyboard console. For a complete list, see the "Tone List" on page A-1.
- 2 Press the TONE button.

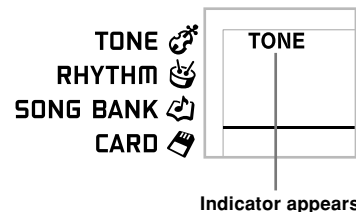

- 3 Use the number buttons to input the two-digit tone number of the tone you want to select.

Example: To select "42 ACOUSTIC BASS", input 4 and then 2.





Basic Operations

NOTE

- Always input all two digits for the tone number, including leading zeros (if any). If you input only one digit and stop, the display will automatically clear your input after a few seconds.
- You can also increment the displayed tone number by pressing [+] and decrement it by pressing [-].
- When the drum set is selected (tone number 99), each keyboard key is assigned a different percussion sound. See page A-3 for details.

Polyphony

The term polyphony refers to the maximum number of notes you can play at the same time. The keyboard has 24-note polyphony, which includes the notes you play as well as the rhythms and auto-accompaniment patterns that are played by the keyboard. This means that when a rhythm or auto-accompaniment pattern is being played by the keyboard, the number of notes (polyphony) available for keyboard play is reduced. Also note that some of the tones offer only 12-note polyphony.

- When rhythm or auto accompaniment is playing, the number of sounds simultaneously played is reduced.

Digital Sampling

A number of the tones that are available with this keyboard have been recorded and processed using a technique called digital sampling. To ensure a high level of tonal quality, samples are taken in the low, mid, and high ranges and then combined to provide you with sounds that are amazingly close to the originals. You may notice very slight differences in volume or sound quality for some tones when you play them at different positions on the keyboard. This is an unavoidable result of multiple sampling, and it is not a sign of malfunction.

Turning the Key Light System On and Off

Use the following procedure when you want to turn the key light system on or off.

To turn the key light system on and off

- 1 Press the KEY LIGHT button to toggle the key light system on and off.
 - The KEY LIGHT indicator disappears when the key light system is turned off.



NOTE

- The key light system is turned on automatically whenever you turn on keyboard power.

Playing a Built-in Tune

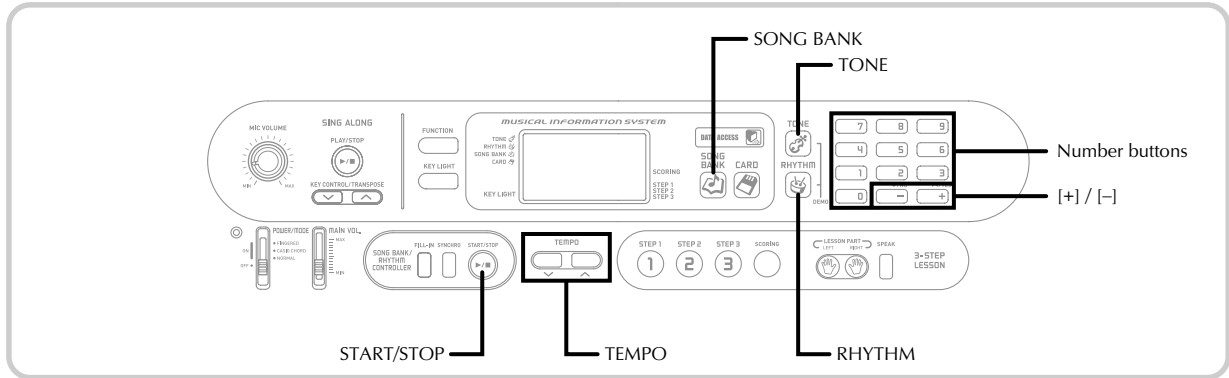

Your keyboard comes with a total of built-in 60 tunes. You can play back built-in tunes for your own listening pleasure, or you can use them for practice and even sing-along.

To play back a Song Bank tune

PREPARATION

- Adjust the main volume (page E-17).

- Find the tune you want to play in the SONG BANK List, and note its number.
 - See page A-7 for the Song Bank List.
- Press the SONG BANK button to enter the Song Bank Mode.

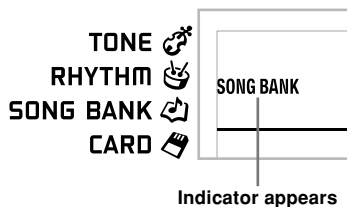

- Use the number buttons to input the tune's two-digit number.

Example: To select "38 ALOHA OE", input 3 and then 8.

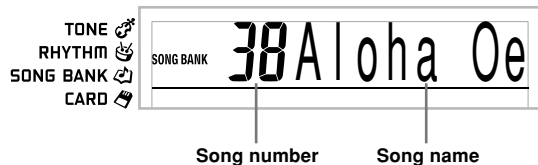

NOTE

- Tune Number 00 is the initial default Song Bank tune setting whenever you turn on keyboard power.
- You can also increment the displayed tune number by pressing [+] and decrement is by pressing [-].

- Press the START/STOP button to start play of the tune.

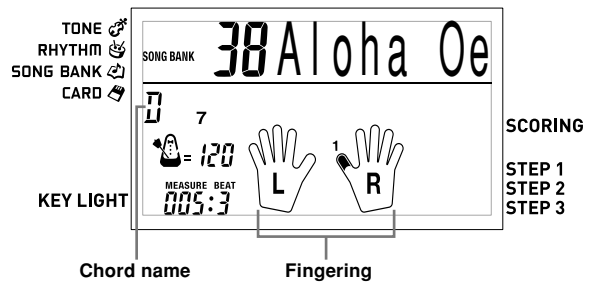

- Press the START/STOP button to stop playback of the Song Bank tune.
 - The tune you select continues to play until you stop it.



Playing a Built-in Tune

Adjusting the Tempo

Each tune has a preset default tempo (beats per minute) that is set automatically whenever you select a tune. While the tune is playing, you can change the tempo setting to a value in the range of 40 to 255.

To set the tempo

- Use the TEMPO buttons to set the tempo.
 - ∧ : Increases the tempo value.
 - ∨ : Decreases the tempo value.

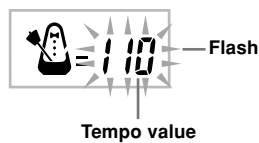

NOTE

- While the tempo value is flashing, you can also use the number buttons or [+] and [-] to input a three-digit value. Note that you must input leading zeros, so 90 is input as 090.
- Pressing both the ∧ and ∨ TEMPO buttons at the same time automatically returns the currently selected built-in tune or rhythm's default tempo.

To change the tone used for the melody of a Song Bank tune

- Following step 3 of the procedure on page E-19, press the TONE button.

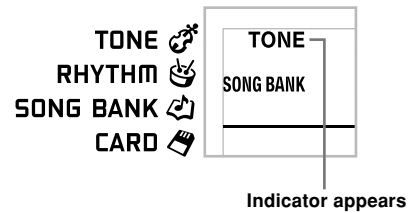

- Find the tone you want in the TONE List, and then use the number buttons to input its two-digit number.

Example: To select "50 VIOLIN", input 5, then 0.

- You can select any one of the keyboard's 100 built-in tones.



NOTE

- You can also use the [+] and [-] buttons to change the melody tones.
- Specifying the tune number for the same tune that is currently selected returns the melody tone to the default setting for that tune.

To play all tunes in succession

- Press the TONE button and RHYTHM button at the same time.
 - Playback starts from Song Bank tune number 00.
- To stop tune play, press the START/STOP button.

NOTE

- While a tune is playing, you can use the number buttons or [+] and [-] to change to another tune.
- You can play along with the tunes on the keyboard.

3-Step Lesson System

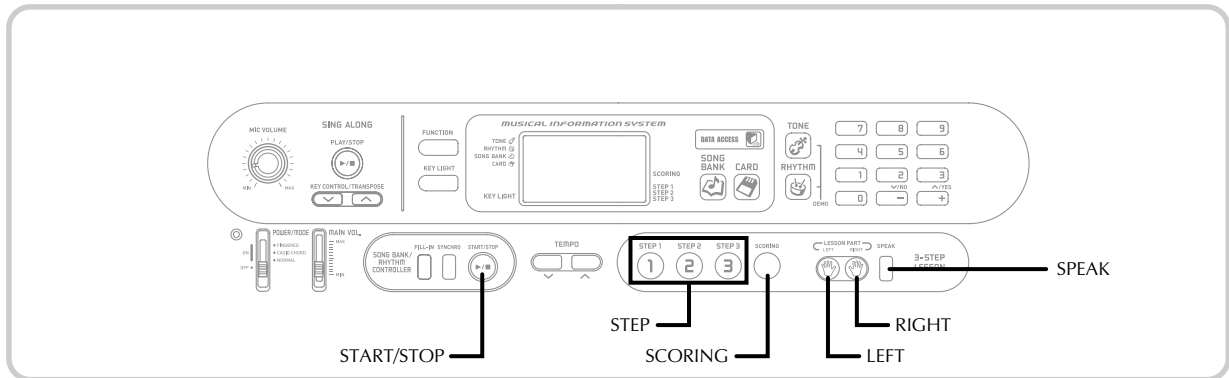

With the 3-Step Lesson System, you can practice built-in tunes and SMF data from a SmartMedia card, and even plot your progress according to the evaluation points the keyboard awards you.

* See “Using a SmartMedia card” on page E-40 for information about using the SMF data from a SmartMedia card for playback.

Lesson Progress

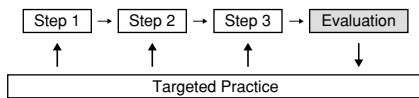

3-Step Lesson

The 3-step lesson feature takes you through the three distinct steps described below to help you learn to play tunes on the keyboard.

Step 1 – Master the timing.

In this step, pressing any key on the keyboard plays the correct note, so you can concentrate on getting the timing right without worrying about playing the right note. Accompaniment (left-hand part) waits until you press a key before proceeding to the next phrase.

Step 2 – Master the notes.

In this step, you use the display to learn which fingers you should use and how loud or soft to play, and the key light system to learn which keyboard keys to press. Accompaniment (left-hand part) waits until your play the correct note, so you can learn at your own pace.

Step 3 – Play at normal speed.

This is where you enjoy actually playing the tunes you learn using Step 1 and Step 2. The key light system still shows you which keyboard keys to press, but accompaniment proceeds at normal speed regardless of whether or not you play the correct notes.

Tune Types and Their Parts

Auto-accompaniment Tunes (Tune Numbers 00 to 49)

As their name suggests, these tunes are made up of an Auto Accompaniment part and a melody part. When using these tunes for a 3-step lesson, you can practice playing along with the melody (right hand) part only.

Piano Solo Tunes (Tune Numbers 50 to 59)

These types of tunes are played with both hands, as in a piano solo. When using these tunes for a 3-step lesson, you can practice playing along with both the left hand and right hand parts.

NOTE

- The selected Song Bank tune continues to repeat until you stop playback by pressing the START/STOP button.
- Chord names are not displayed during playback of Piano Solo tunes.



3-Step Lesson System

Key Lighting System Operation and Display Contents During 3-step Lesson Play

Whenever you select an Auto Accompaniment tune (00 to 49) for 3-step lesson play, the key lighting system shows you which keys to press, while the display shows you the fingerings.

Note Pitch

The keyboard key that should be pressed lights. The fingers you should use to play the notes are also shown on the display.

Note Length

Keyboard keys stay lit for as long as the note should be played. The fingerings also remain on the display for the length of the note.

Next Note

The keyboard key for the next note to be played flashes, while a number appears on the display near the finger you should use to play the next note.

Series of Same Pitch Notes

The keyboard key light turns off momentarily between the notes and lights again for each successive note. The fingerings also turn off and back on again.

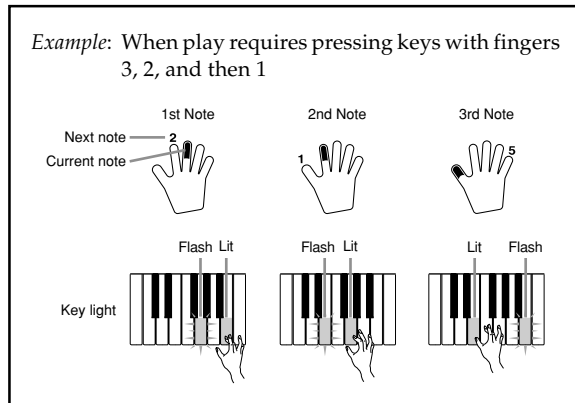

NOTE

- Note length is not indicated when you are using Piano Solo tunes with 3-step lesson Steps 1 and 2. As soon as you press a lit key, it goes out and the next key to be played starts to flash.
- Note length is indicated by the key light system when you use a Piano Solo tune with Step 3. In this case, the next key to be pressed does not flash when you press a lit key and the next finger number does not appear on the display. Only the current finger number is shown.

3-step Lesson Tempo Setting

Use the procedure under "Adjusting the Tempo" on page E-20 to adjust the tempo for 3-step lesson play.

Evaluation Mode

The keyboard's Evaluation Mode awards points to your performances during Step 3 of the 3-Step Lesson. A perfect score is 100. Also, the Evaluation Mode provides comments about your play on the monitor screen.

Evaluation Mode Display

Level Indicator (9 Levels): This indicator shows the evaluation of your current performance at a glance. The more segments that appear, the higher your points.

Example: 50 points



Timing Indicator: In the Evaluation Mode, the configuration of the star changes with each note to let you know how your timing is. The more stars, the better your timing.





3-Step Lesson System

Evaluation Results

After you finish playing, the keyboard calculates an evaluation of your total performance, from beginning to end, and displays your total score on the monitor screen. The greater the score, the higher your evaluation is.

Evaluation Rank Display Messages

Display Message	Evaluation Ranges
"Bravo!"	<High>
"Great!"	
"Not bad!"	
"Again!"	<Low>

"****" : indicates that the Evaluation Mode was exited before an evaluation result could be obtained.

NOTE

- If you press the START/STOP button and interrupt the Evaluation Mode part way through, the monitor screen shows the evaluation points you have accumulated up to that point. In this case, the keyboard does not display a message.

Using the Lesson Functions and Evaluation Mode

Perform the following steps to master your favorite tunes.

Step 1 – Master the timing.

- Select the tune you want to use.
- Press the STEP 1 button to start Step 1 play.
 - After a count sounds, the keyboard stands by and waits for you to play the first note of the tune.

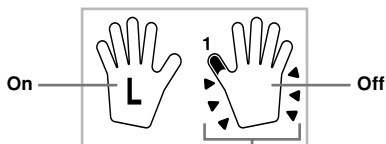

The hand you should use is indicated by arrows around it.

- Voice fingering guide will use a simulated human voice to call out fingering numbers. See "Voice Fingering Guide" on page E-25 for details.

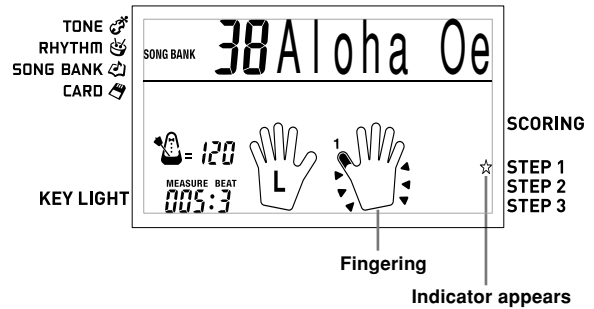

- Press any keyboard keys to play the notes.

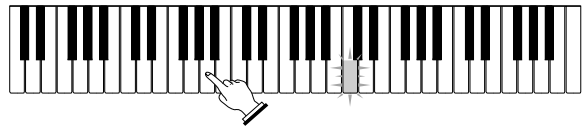

- The key for the next note to be played flashes while the keyboard waits for you to play it. When you press any key to play the note, the key remains lit as the note plays.
- Accompaniment (left-hand part) waits until you press any key to play a note.
- If you accidentally press more than one key in succession, accompaniment is played for the corresponding number of notes.
- Pressing more than one key at the same time counts as a single note. Pressing a key while another key is held down is counted as two notes.

- To stop play at any time, press the START/STOP button.

NOTE

- Left hand practice can also be performed with Piano Solo tunes. Simply select one of the Piano Solo tunes in step 1 of the above procedure, and then press the LEFT button following step 2.



3-Step Lesson System

Step 2 – Master the notes.

- 1 Select the tune you want to use.
- 2 Press the STEP 2 button to start Step 2 play.
 - After a count sounds, the keyboard stands by and waits for you to play the first note of the tune.
 - Voice fingering guide will use a simulated human voice to call out fingering numbers. See “Voice Fingering Guide” on page E-25 for details.

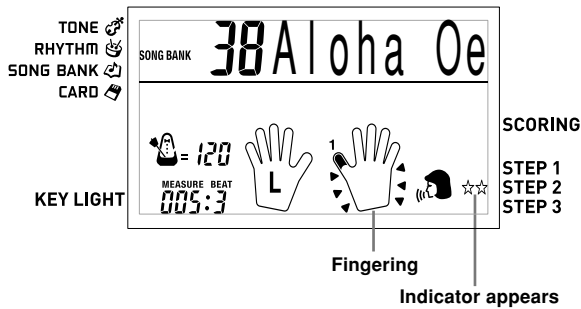

- 3 Follow the key light system to press the correct keyboard keys and play the notes.

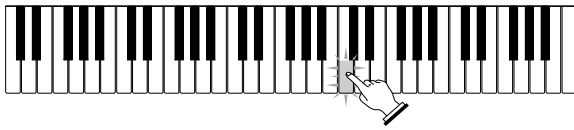

- The key for the next note to be played flashes while the keyboard waits for you to play it. When you press any key to play the note, the key remains lit as the note plays.
- If multiple keys light on the keyboard when you are using a Piano Solo tune, it means that you must press all of the keys that are lit.

- 4 To stop play at any time, press the START/STOP button.

NOTE

- Left hand practice can also be performed with Piano Solo tunes. Simply select one of the Piano Solo tunes in step 1 of the above procedure, and then press the LEFT button following step 2.

Step 3 – Play at normal speed.

- 1 Select the tune you want to play.
- 2 Press the STEP 3 button to start Step 3 play.
 - Accompaniment (left hand part) starts to play at normal speed.
 - Voice fingering guide will use a simulated human voice to call out fingering numbers. See “Voice Fingering Guide” on page E-25 for details.

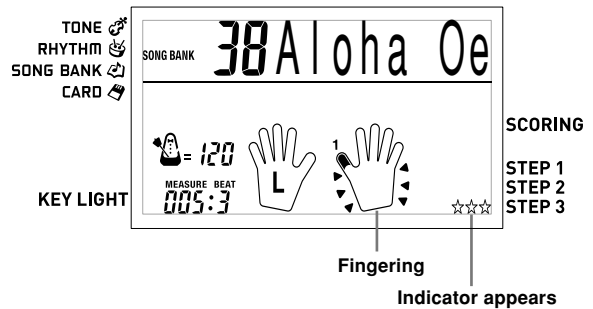

- 3 Follow the key light system to press the correct keyboard keys and play the notes.

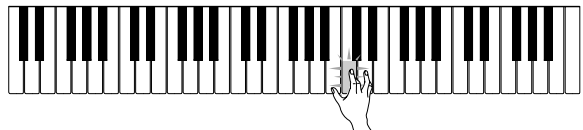

- 4 To stop play at any time, press the START/STOP button.

NOTE

- Left hand practice can also be performed with Piano Solo tunes. Simply select one of the Piano Solo tunes in step 1 of the above procedure, and then press the LEFT button following step 2.

Evaluation: Find out how the keyboard evaluates your Step 3 play.

Use the SCORING button to check the evaluation of your play in Step 3.

- 1 Press the SCORING button.
 - This causes the SCORING indicator to appear on the display.
 - A count beat sounds and then evaluation mode starts.

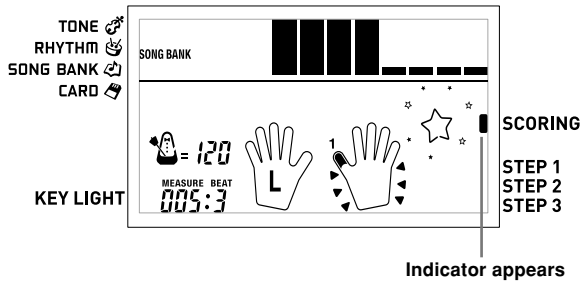

- 2 Play in accordance with the guidance on the monitor screen and as told by the voice.
 - To stop evaluation, press the START/STOP button. This displays only the points accumulated up to that point.
- 3 After you finished playing, your evaluation result appears on the display.
 - For information about evaluation ranks and sound effects, see "Evaluation Results" on page E-23.
 - Pressing the SONG BANK button returns to the tune selection screen.



Voice Fingering Guide

Voice fingering guide uses a simulated human voice to call out fingering numbers during Step 1 and Step 2 one-hand part practice. If you need to press a key with your thumb, for example, voice fingering guide says, "One!" In the case of a chord to be played with your thumb, middle and little finger, voice fingering guide says, "One, three, five!" Voice Fingering Guide calls out fingerings only when you do not press the proper key when you should.

Voice Fingering Guide

- One : Thumb
- Two : Forefinger
- Three : Middle finger
- Four : Ring finger
- Five : Little finger

To turn voice fingering guide on or off

- 1 Press the SPEAK button to toggle voice fingering guide on (voice fingering guide indicator displayed) and off (indicator not displayed).

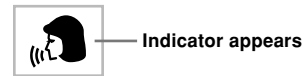

NOTE

- Note that Voice Fingering is disabled in the Evaluation Mode. Pressing the SCORING button automatically turns off Voice Fingering.
- Exiting the Evaluation Mode automatically restores the Voice Fingering setting that was in effect when you entered the Evaluation Mode.

Using a Microphone for Sing Along

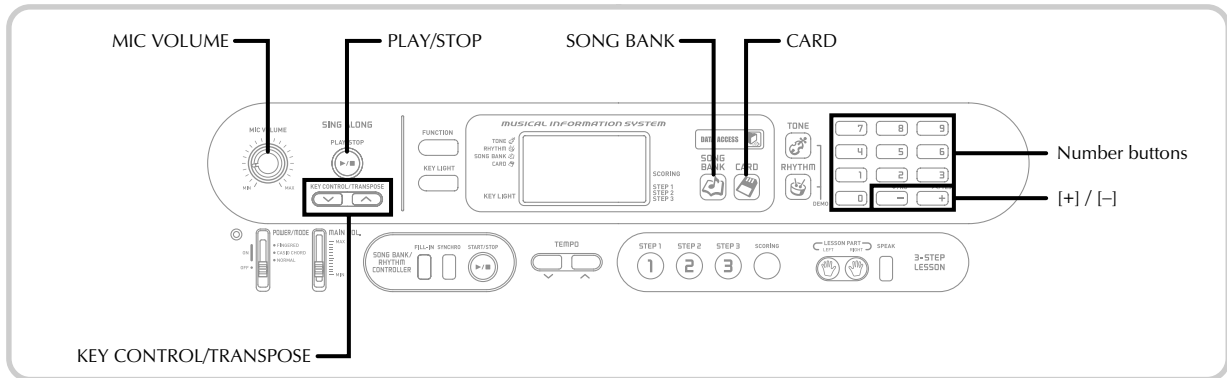

You can select any of the 60 Song Bank tunes or SMF data from a SmartMedia card, and sing along with its accompaniment.

Using the microphone jack

Connecting a commercially available microphone* to the MIC jack makes it possible to sing along with the keyboard's built-in tunes or with SMF playback. When connecting a microphone, be sure to first adjust the MIC VOLUME to a relatively low setting, and then adjust to the level you want after connecting.

* If a microphone was included with your keyboard, use that microphone. If your keyboard did not come with a microphone, use a commercially available microphone that satisfies the stipulated specifications.

- 1 Set the MIC VOLUME knob setting so it is on the "MIN" side.
- 2 Turn on the microphone's ON/OFF switch.
- 3 Use the MIC VOLUME knob to adjust microphone volume to the level you want.

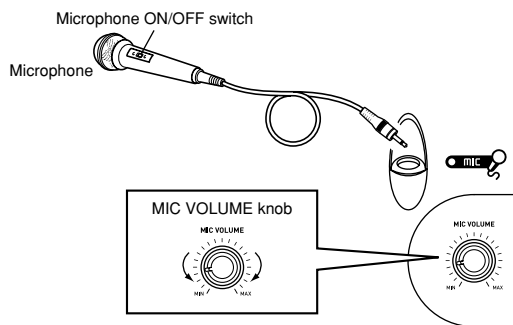

IMPORTANT!

- Be sure to use the microphone's ON/OFF switch to turn off the microphone and to disconnect the microphone from the keyboard whenever you are not using it.

Recommended Microphone Type

- Dynamic microphone (standard plug)

Howling (Feedback Noise)

Any of the following conditions can cause howling (feedback noise).

- Covering the head of the microphone with your hand
- Positioning the microphone too near to a speaker

Should howling occur, try grasping the microphone further away from the head, and move away from any nearby speaker.

Static Noise

Fluorescent lighting can cause static noise in the microphone signal. When this happens, move away from the lighting you suspect may be causing the static.



Using a Microphone for Sing Along

To use a microphone for sing along

PREPARATION

- Adjust the main volume (page E-17) and microphone volume (page E-26).

- Find the tune you want in the Song Bank List or on a Smart Media card, and note its number.
 - See page A-7 for the Song Bank List.
- Select the sing along source.

■ Song Bank

Press the SONG BANK button. This enters the Sing Along Song Bank Mode, and displays the Song Bank indicator.

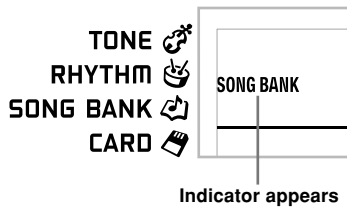

■ SmartMedia card

Press the CARD button. This enters the Sing Along Card Mode, and displays the CARD indicator.

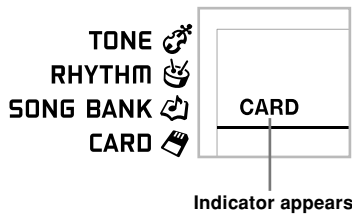

- Use the number buttons to input the song number.

NOTE

- The initial power on default tune setting is "00".
- You can also specify the song number using the [+] and [-] buttons.

- Press the PLAY/STOP button to start tune play.
 - Now use the microphone to sing along with the playback.
 - The Sing Along Mode is similar to the Song Bank Mode. The only difference is that the melody part in the Sing Along Mode is played back at a lower volume. Also a different tone setting is used in the Sing Along mode to make sing along easier.
- Use the KEY CONTROL/TRANPOSE buttons (Λ/∇) to change the overall key of the playback, if you want.
 - Λ : Raises the key by one semitone
 - ∇ : Lowers the key by one semitone
- Press the PLAY/STOP button to stop tune play.
 - The same song plays in an endless loop until you stop it.

NOTE

- To return a tune to its default key, press both of the KEY CONTROL/TRANPOSE buttons (Λ and ∇) at the same time.

Auto Accompaniment

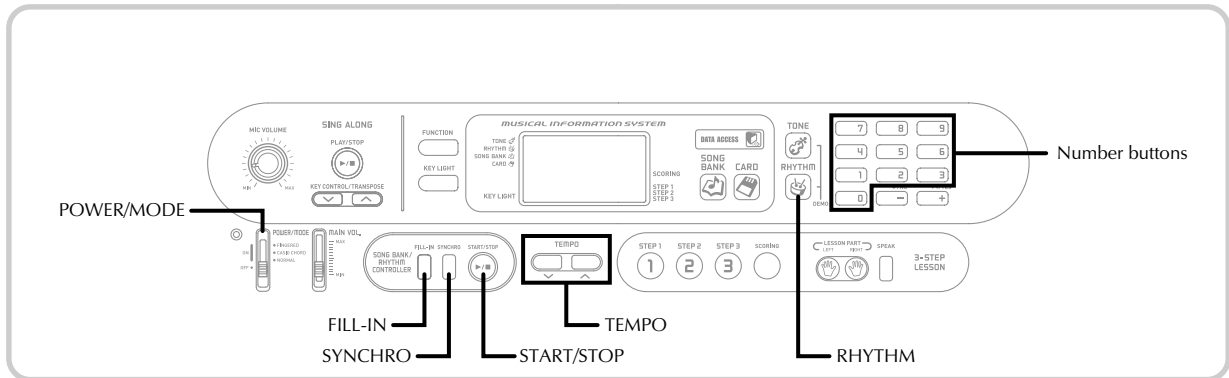

Playing rhythms

This keyboard features a collection of 50 exciting built-in rhythm patterns. Each pattern provides percussion back up for all your performances.

To select and play a rhythm

- 1 Set the POWER/MODE switch to NORMAL.
- 2 Find the rhythm you want to use in the "Rhythm List" (page A-7) and note its rhythm number.
- 3 Press the RHYTHM button.
 - When you do, the RHYTHM indicator appears.
 - The number and name that appear on the display indicate the currently selected rhythm.
- 4 Use the number buttons to input the 2-digit rhythm number for the rhythm you want to use.
Example: To select "37 SAMBA", input 3 and then 7.

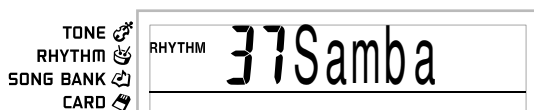

- Be sure to always specify a 2-digit number.
 - If you discover a mistake before you input the second digit, press the RHYTHM button to return to the previously set rhythm number.
 - You can change to another rhythm even while the current rhythm is sounding.
- 5 Press the START/STOP button to start play of the rhythm.
 - When you do, the selected rhythm starts to sound.

- 6 Use the TEMPO buttons to adjust the tempo of the rhythm.



- Each time you press one of the TEMPO buttons while the tempo value is displayed, the tempo setting changes one step, within the range of 040 to 255.
- The initial default tempo setting when you turn on power is 120.
- After displaying the current tempo setting by pressing the TEMPO buttons in step 6, you can also input the tempo setting you want by inputting a three-digit value with the number buttons.
- Holding down either of the TEMPO buttons changes the tempo setting at high speed.
- To reset the tempo to the standard value of each rhythm, press both TEMPO buttons.

- 7 To stop rhythm play, press the START/STOP button again.

Using auto-accompaniment

This keyboard features 50 accompaniment patterns that let you add full accompaniments to your performances automatically. With auto-accompaniment, part of the keyboard is reserved as an accompaniment keyboard. As you play your chords on the accompaniment keyboard, the accompaniment pattern adjusts automatically to follow the progression you play.

You get a choice between two different methods for chord play. FINGERED lets you play chords as you normally do, while CASIO CHORD makes it possible to play fully formed chords with one finger.



About the accompaniment keyboard

The lower (left) 1.5 octaves are reserved for use as an accompaniment keyboard whenever you select CASIO CHORD or FINGERED with the POWER/MODE switch. The panel above the accompaniment keyboard keys is marked with the names of the notes they play. The remainder of the keyboard (the part that is not included in the accompaniment keyboard) is called the melody keyboard. Please be sure to remember these terms, because they will be used throughout the rest of this manual.

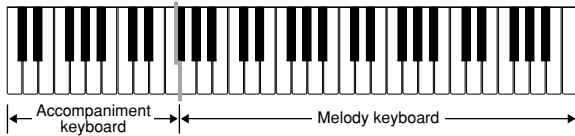

(The entire keyboard can be used for melody play while the POWER/MODE switch is set to NORMAL.)

Using the CASIO CHORD system

The CASIO CHORD system lets you easily play the four main types of chords. Play of chords is simplified as shown in the chart below.

Keys	Type	Example
Pressing one accompaniment key	Major chord	C (C Major Chord)
Pressing two accompaniment keys	Minor chord	Cm (C Minor Chord)
Pressing three accompaniment keys	Seventh chord	C7 (C Seventh Chord)
Pressing four accompaniment keys	Minor seventh chord	Cm7 (C Minor Seventh Chord)

NOTE

- The bottom (leftmost) note that you play determines the name of the chord. If the bottom note is a C for example, the keyboard produces a C chord.
- When pressing more than one accompaniment key, it makes no difference whether the keys to the right of the bottom note are white or black.

To play a CASIO CHORD auto-accompaniment

- 1 Use the POWER/MODE switch to select CASIO CHORD.
- 2 Select an auto-rhythm as described under "To select and play a rhythm" on page E-28.
- 3 Start play of the rhythm.
 - If you want to start play of the normal rhythm pattern, press the START/STOP button.
 - You can also use synchro start (page E-31) to start rhythm play.
- 4 Press either one or up to four keys on the accompaniment keyboard, and the corresponding accompaniment starts to play automatically.

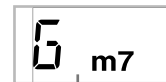

Chord name

- 5 Continue pressing different keys on the accompaniment keyboard to play your chord progression.
- 6 To stop auto-accompaniment play, press the START/STOP button again.



Auto Accompaniment

Using standard fingerings

The FINGERED mode lets you play a wider variety of chords. In this mode, you can start play of an accompaniment pattern by pressing three or four of the accompaniment keyboard keys.

This keyboard is capable of recognizing 15 different chords. The following shows the fingerings of these chords with a root of C. Note that you can omit the fifth notes (which are shown inside parentheses in the illustrations below) to produce 7, m7, M7, add9, madd9, and mM7 chords.

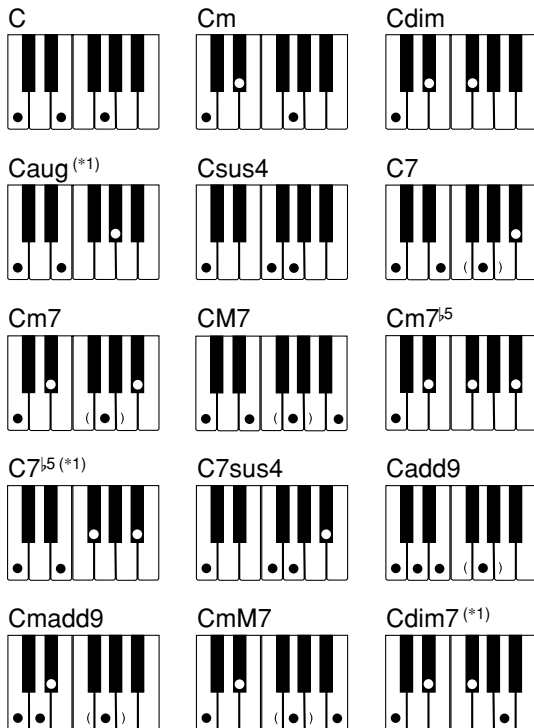

*1 With this chords, the lowest note in your fingering is always used as the root. Make sure that your fingering correctly identifies the root you want to use.

IMPORTANT!

- If you play one or two notes only in the left hand, or three notes that do not make up a recognizable chord formation, no sound will be produced. The FINGERED mode requires a conventional three or four-note chord formation to produce an auto-accompaniment. Also, note that auto-chords only work in conjunction with rhythm patterns, and not independently of them.

NOTE

- The above examples show only one of the possible fingerings for each chord. Note that you can play the notes that form a chord in any combination. Each of the following fingerings for example, produces the same C chord.

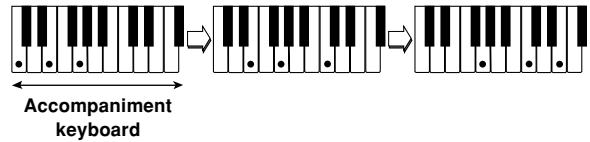

- See the "Fingered Chord Charts" on page A-5 for information on the fingerings of chords for all roots.



To play a FINGERED auto-accompaniment

- 1 Use the POWER/MODE switch to select FINGERED.
- 2 Select an auto-rhythm as described under "To select and play a rhythm" on page E-28.
- 3 Start play of the rhythm.
 - If you want to start play of the normal rhythm pattern, press the START/STOP button.
 - You can also use synchro start (on this page) to start rhythm play.
- 4 Play a chord on the accompaniment keyboard to start play of the auto-accompaniment.

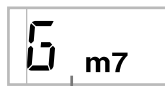

Chord name

- 5 Continue pressing keys on the accompaniment keyboard to play your chord progression.
- 6 To stop auto-accompaniment play, press the START/STOP button again.

Improvising with the preset patterns

Pressing the START/STOP button to start rhythm play causes the normal version of the pattern to be played. You can also play a variation of the rhythm using the operation described below.

Using fill-in rhythm

You can insert a fill-in rhythm by pressing the FILL-IN button while an auto-rhythm plays.

Using Synchro start

You can start the rhythm and accompaniment pattern at the same time, with your play of the accompaniment keyboard. To do this, follow the steps below.

- 1 Set the POWER/MODE switch to the CASIO CHORD or FINGERED position.
- 2 Select an auto-rhythm.
- 3 Press the SYNCHRO button.
- 4 Press the accompaniment keys to play the first chord. As soon as you do, the auto-accompaniment pattern begins to play.

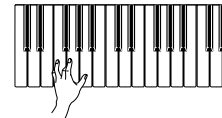

- 5 To stop the auto-accompaniment pattern play, press the START/STOP button.

NOTE

- If you set the POWER/MODE switch to NORMAL in step 1 on page E-28, the operation in step 4 starts play of the rhythm (percussion instruments) only.

Keyboard Settings

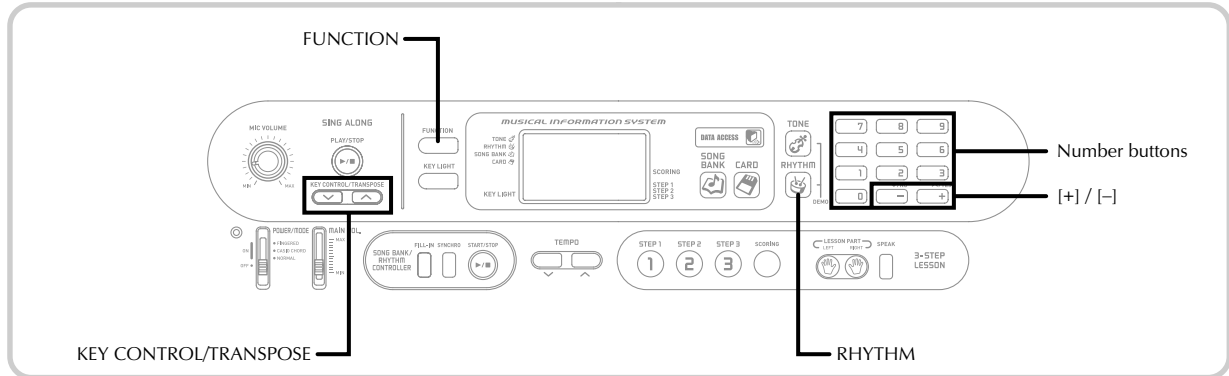

Transposing the Keyboard

Transpose lets you raise and lower the overall key of the keyboard in semitone units. If you want to play an accompaniment for a vocalist who sings in a key that's different from the keyboard, for example, simply use transpose to change the key of the keyboard.

To transpose the keyboard

- 1 Press the RHYTHM button to enter the Rhythm Mode.
- 2 Use the KEY CONTROL/TRANPOSE buttons (\wedge / \vee) to change the key of the keyboard.
 - \wedge : Raises the key by one semitone
 - \vee : Lowers the key by one semitone

Example: To transpose the keyboard five semitones upwards.



NOTE

- The keyboard can be transposed within a range of -12 (one octave downwards) to $+12$ (one octave upwards).
- The default transpose setting is "00" when keyboard power is turned on.
- If you leave the transpose screen on the display for about five seconds without doing anything, the screen is automatically cleared.
- The transpose setting also affects playback from Auto Accompaniment.
- To return the keyboard to its default key, perform the above procedure and press both of the KEY CONTROL/TRANPOSE buttons (\wedge and \vee) at the same time in step 2. You could also use the [+] and [-] buttons to change the transpose setting to "00".

About FUNCTION button

Each press of the FUNCTION button cycles through a total of 10 setting screens. If you accidentally pass the screen you want to use, keep pressing the FUNCTION button until the screen appears again.



Adjusting Accompaniment Volume

You can adjust the volume of the accompaniment independently of the notes you play on the keyboard. You can specify a volume level in the range of 00 (minimum) to 99 (maximum).

To adjust the accompaniment volume

- 1 Press the FUNCTION button until the accompaniment volume adjustment screen appears.

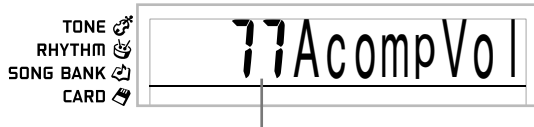

Current accompaniment volume setting

- 2 Use the number buttons or the [+]/[-] buttons to change the current volume setting value.
Example: 99



NOTE

- The current accompaniment volume value that appears in Step 1 automatically clears from the display if you do not input anything within about five seconds.

Tuning the Keyboard

Use the following procedure to fine tune the keyboard to match the tuning of another musical instrument.

To tune the keyboard

- 1 Press the FUNCTION button until the tuning screen appears.



- 2 Use the [+], [-], and the number buttons to adjust the tuning value.
Example: To lower tuning by 20



NOTE

- The keyboard can be tuned within a range of -50 cents to +50 cents.
* 100 cents is equivalent to one semitone.
- The default tuning setting is "00" when keyboard power is turned on.
- If you leave the tuning screen on the display for about five seconds without doing anything, the screen is automatically cleared.
- The tuning setting also affects playback from Auto Accompaniment.
- To return the keyboard to its default tuning, perform the above procedure and press the [+] and [-] buttons at the same time in step 2.

Connection to a Computer

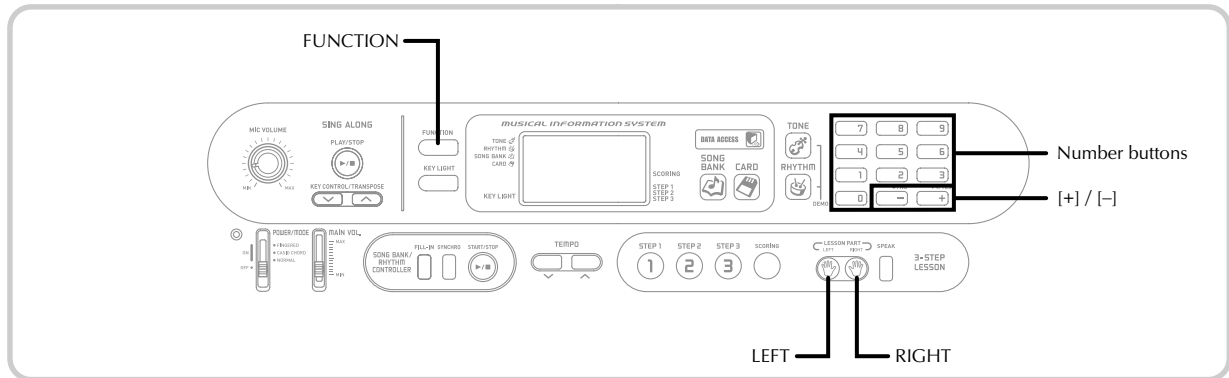

Connecting to a Computer

The keyboard's USB port makes it quick and simple to connect to a computer. After installing the USB driver onto your computer from the CD-ROM that comes with the keyboard, you will be able to use commercially available MIDI software on your computer to exchange data between the keyboard and your computer.

Using the USB port

Note that you need to purchase a commercially available USB cable to connect the keyboard to a computer using the USB port. Once you establish a USB connection between the keyboard and a computer, you can exchange data between them.

To connect to a computer using the USB port

- 1 On the computer to which you plan to connect, install the USB driver that comes on the CD-ROM that comes bundled with the keyboard.
 - For information about installing the driver, navigate to one of the language directories located in the root directory of the bundled CD-ROM, and read the contents of the "readme.txt" file.

- 2 Use a commercially available USB cable to connect the keyboard to the computer.

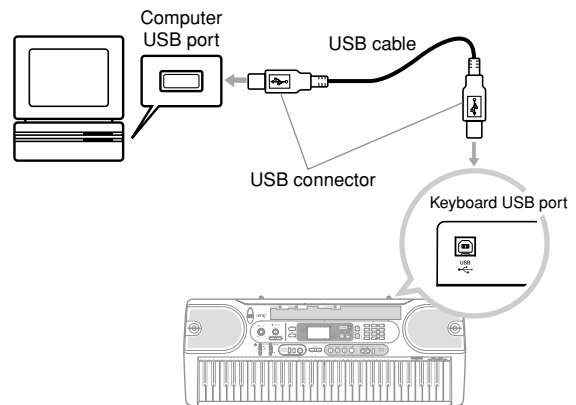



Expanding the Selections in the Song Bank Tunes

You can transfer song data from your computer to the keyboard. You can store up to 5 tunes as Song Bank tunes 60 through 64. For SMF data you purchase or create, you need to use special CASIO conversion software to convert it to CASIO format before transferring it to the keyboard. You can obtain a copy of the special CASIO conversion software by downloading it at the Web page shown below. After downloading, install the software on your computer.

CASIO MUSIC SITE

<http://music.casio.com/>

- In addition to the software itself, the CASIO MUSIC SITE will also provide you with information about its installation and use. You can also find out about the latest news about your keyboard and other CASIO musical instruments, and much more.

NOTE

- This keyboard supports SMF 0 format data.
- Voice Fingering Guide and on-screen fingering indicators are not supported for commercially available SMF data.

General MIDI Tone

The General MIDI standard defines the tone numbering sequence, the drum sound numbering sequence, the number of MIDI channels that can be used, and other general factors that determine the sound source configuration. Because of this, musical data produced on a General MIDI sound source can be played back using similar tones and identical nuances as the original, even when played on another manufacturers sound source.

This keyboard conforms with General MIDI standards, so it can be connected to a computer and used to play back General MIDI data that has been purchased, downloaded from the Internet, or obtained from any other source.

Changing the Settings

This section tells you how to make the settings required when connecting to a computer.

GM MODE (Default: Off)

on: Configures the keyboard for optimal General MIDI data play (tone specification matching, etc.)

oFF: Returns to default keyboard setup.

- 1 Press the FUNCTION button until the GM MODE screen appears.

Example: When GM MODE is turned off

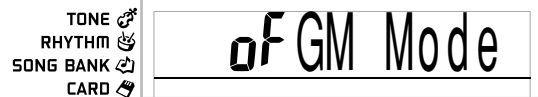

- 2 Use the [+] and [-] or [0] and [1] buttons to turn the setting on and off.

Example: To turn GM MODE on



KEYBOARD CHANNEL (Default: 1)

The keyboard channel is the channel used to send messages from this keyboard to a computer. You can specify one channel from 01 to 16 as the keyboard channel.

- 1 Press the FUNCTION button until the KEYBOARD CHANNEL screen appears.



- 2 Use the [+], [-], and the number buttons to change the channel number.

Example: To specify channel 4





Connection to a Computer

NAVIGATE CHANNEL (Default: 4)

When messages are received from a computer for play on this keyboard, the navigate channel is the channel whose note data appears on the display. You can select one channel from 01 to 16 as the navigate channel. Since this setting lets you use the data on any channel of commercially available SMF data to light on the on-screen keyboard guide, you can analyze how different parts of an arrangement are played.

- 1 Press the FUNCTION button until the NAVIGATE CHANNEL screen appears.



- 2 Use the [+], [-], and the number buttons [0] through [9] to change the channel number.
Example: To specify channel 2



To turn off specific sounds before playing back tune data that is being received

<<Navigate channel on/off>>

- 1 While playing tune data, press the RIGHT button.
 - This cuts the sound of the navigate channel, but on-screen keyboard guide keys continue to light in accordance with the channel's data as it is received. Press RIGHT button again to turn the channel back on.

<<Next lower channel from navigate channel on/off>>

- 1 While playing tune data, press the LEFT button.
 - This cuts the sound of the channel whose number is one less than the navigate channel, but on-screen keyboard guide keys continue to light in accordance with the channel's data as it is received. Press LEFT button again to turn the channel back on.
Example: If the navigate channel is channel 4, the above operation turns off channel 3.



LOCAL CONTROL (Default: On)

oFF: Anything played on the keyboard is output as a message from the USB port, without being sounded by the internal sound source.

- Note that no sound is produced by the keyboard if LOCAL CONTROL is turned off and no external device is connected.

- 1 Press the FUNCTION button until the LOCAL CONTROL screen appears.

Example: When LOCAL CONTROL is on

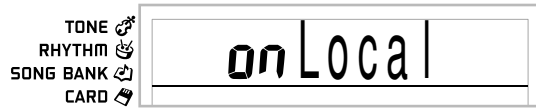

- 2 Use the [+] and [-] or [0] and [1] buttons to turn the setting on and off.

Example: To turn LOCAL CONTROL off

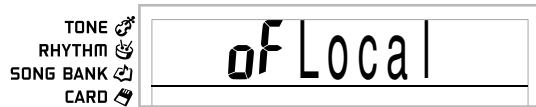



Connection to a Computer

Messages

The MIDI messages explained here can be sent and received when the keyboard is connected to a computer by USB connection. Note, however, that you need to install the USB driver from the CD-ROM that comes with the keyboard on your computer to send and receive these MIDI messages.

There is a wide variety of messages defined under the MIDI standard, and this section details the particular messages that can be sent and received by this keyboard. An asterisk is used to mark messages that affect the entire keyboard. Messages without an asterisk are those that affect only a particular channel.

NOTE ON/OFF

This message sends data when a key is pressed (NOTE ON) or released (NOTE OFF).

A NOTE ON/OFF message include a note number (to indicate note whose key is being pressed or released) and velocity (keyboard pressure as a value from 1 to 127). NOTE ON velocity is always used to determine the relative volume of the note. This keyboard does not receive NOTE OFF velocity data.

Whenever you press or release a key on this keyboard, the corresponding NOTE ON or NOTE OFF message is sent from the USB port.

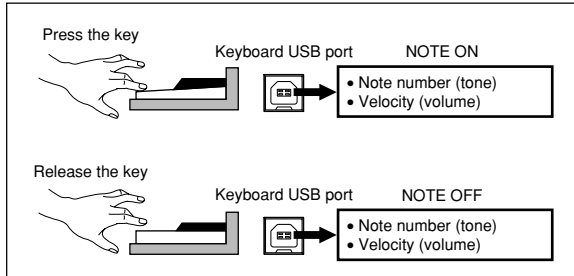

NOTE

- The pitch of a note depends on the tone that is being used, as shown in the Note Table on page A-1. Whenever this keyboard receives a note number that is outside its range for that tone, the same tone in the nearest available octave is substituted.

PROGRAM CHANGE

This is the tone selection message. PROGRAM CHANGE can contain tone data within the range of 0 to 127.

A PROGRAM CHANGE message is sent out through this keyboard's USB port whenever you manually change its tone number. Receipt of a PROGRAM CHANGE message from an external machine changes the tone setting of this keyboard.

PITCH BEND

This message carries pitch bend information for smoothly sliding the pitch upwards or downwards during keyboard play. This keyboard does not send pitch bend data, but it can receive such data.

CONTROL CHANGE

This message adds effects such as vibrato and volume changes applied during keyboard play. CONTROL CHANGE data includes a control number (to identify the effect type) and a control value (to specify the on/off status and depth of the effect).

The following is a list of data that can be send or received using CONTROL CHANGE.

Effect	Control Number
BANK SELECT*1	0, 32
★ Modulation	1
★ Volume	7
★ Pan	10
★ Expression	11
Hold1	64
RPN*2	100 / 101
Data Entry	6 / 38

★ indicates receive-only messages



*1 The BANK SELECT setting of PROGRAM CHANGE can be used to access any of this keyboard's 100 panel tones and 128 GM tones when selecting tones on this keyboard from an external machine.

See the "Tone List" on page A-1 for details about PROGRAM CHANGE and BANK SELECT combinations.

Example: To select tone number 96 (panel tone "FLUTE 1") from a computer.
 CONTROL NUMBER= 0,
 CONTROL VALUE= 2 (bank number)
 CONTROL NUMBER= 32, CONTROL VALUE= 0
 PROGRAM CHANGE= 73

*2 RPN stands for Registered Parameter Number, which is a special control change number used when combining multiple control changes. The parameter being controlled is selected using the control values of control numbers 100 and 101, and then settings are made using the control values of DATA ENTRY (control numbers 6 and 38).

This keyboard uses RPN to control this keyboard's pitch bend sense (pitch change width in accordance with bend data) from a computer, transpose (this keyboard's overall tuning adjusted in half-tone units), and tune (this keyboard's overall fine tuning).

NOTE

- Sustain (control number 64) effect applied using the foot pedal is also applied.

ALL SOUND OFF

This message forces all sound being produced over the current channel to turn off, regardless of how the sound is being produced.

ALL NOTES OFF

This message turns off all note data sent from an external device and currently being sounded on the channel.

- Any notes being sustained using a sustain pedal or sostenuto pedal continue to sound until the next pedal off.

RESET ALL CONTROLLERS

This message initializes pitch bend and all other control changes.

SYSTEM EXCLUSIVE*

This message is used to control system exclusives, which are tone fine adjustments that are unique to a particular machine. Originally, system exclusives were unique to a particular model, but now there are also universal system exclusives that are applicable to machines that are different models and even produced by different manufacturers.

The following are the system exclusive messages supported by this keyboard.

■ GM SYSTEM ON ([F0][7E][7F][09][01][F7])

GM SYSTEM ON is used by an external machine to turn on this keyboard's GM system. GM stands for General MIDI.

- GM SYSTEM ON takes more time to process than other messages, so when GM SYSTEM ON is stored in the computer it can take more than 100msec until the next message.

■ GM SYSTEM OFF ([F0][7E][7F][09][02][F7])

GM SYSTEM OFF is used by a computer to turn off this keyboard's GM system.

Using a SmartMedia Card

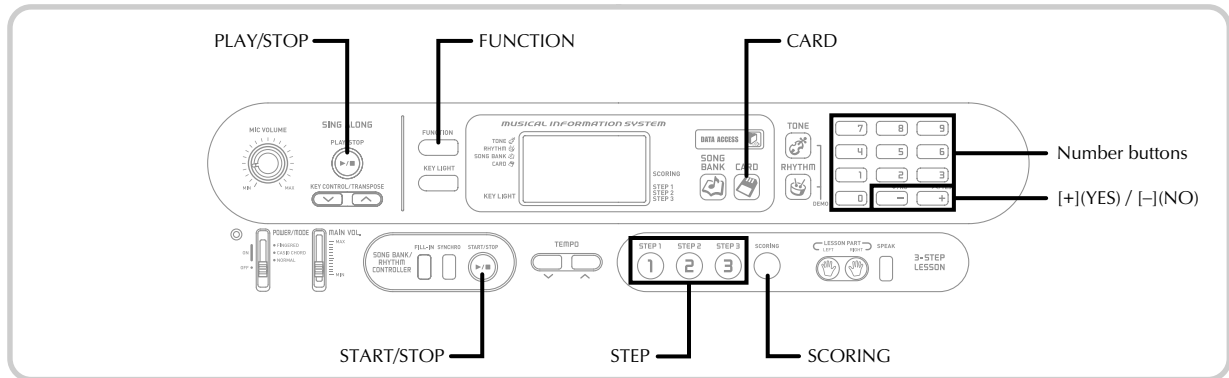

Your keyboard is equipped with a card slot that supports use of SmartMedia™ memory cards. This makes it possible for the keyboard to directly read commercially available SMF data, which has been saved to a SmartMedia card from your computer, for sing along and lessons. SmartMedia data can be used the same way as built-in tunes. This keyboard supports SMF (FORMAT 0) data.

IMPORTANT!

- Reading SMF data from a SmartMedia card causes all five user SMF songs in the user area to be deleted and replaced with the SMF data.

NOTE

- SMF data is converted to a format that can be played by this keyboard, and then stored in keyboard memory. Whether or not the data can fit in keyboard memory depends on the size of the converted data.
- This keyboard cannot write data to a SmartMedia card.
- The keyboard can manage up to 200 SMF data files.

IMPORTANT!

- There are two types of SmartMedia cards: 3.3V and 5V. Note that this keyboard supports use of 3.3V type SmartMedia cards only.
- Never try to use a 5V type SmartMedia card with this keyboard.
- Note you will not be able to store data to, delete data from, or rename a SmartMedia card that has a write protect sticker affixed to the card's write protect area.

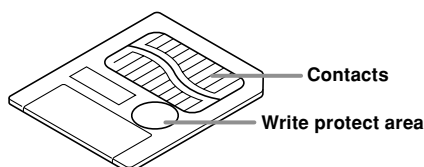

About SmartMedia™ Cards

- You can purchase SmartMedia cards at most household appliance stores, computer stores, etc.
- SmartMedia cards are commercially available in capacities ranging from 8MB up to 128MB.
- Though a SmartMedia card is about the size of a postage stamp, its capacity ranges from 8 to 100 times the capacity of a floppy diskette.
- The data read rate from a SmartMedia card is very fast.
- SmartMedia™ is a trademark of Toshiba Corporation.

SmartMedia Card and Card Slot Precautions

IMPORTANT!

- Be sure to carefully read all documentation that comes with the SmartMedia card for important information about how to handle it.
- Avoid storing and using SmartMedia cards in the following types of locations. Such conditions can cause corruption of data stored on the card.
 - Areas subject to high temperatures, high humidity, or corrosive agents
 - Areas subject to strong electrostatic charge or electrical noise
- Whenever handling a SmartMedia card, make sure that you never touch its contacts with your fingers.
- If the data access lamp is lit and the message "Pls Wait" is on the display, it means that data on the SmartMedia card is being accessed by a save, read, or delete operation. Never remove the SmartMedia card from the card slot or turn off the keyboard while the card is being accessed. Doing so can corrupt the data on the SmartMedia card or even damage the card slot.
- Never try to insert any type of card other than a 3.3V SmartMedia card into the card slot. Doing so can damage the keyboard.
- Inserting a SmartMedia card that is charged with static electricity into the card slot can cause malfunction of the keyboard. If this happens, turn the keyboard off and then back on again.



- A SmartMedia card that has been in the card slot for a long time may feel hot when you remove it. This is normal and does not indicate malfunction.
- Note that a SmartMedia card has a limited service life. After long use, you may not be able to store data to, read data from, and/or delete data from a card. When this happens, you will need to purchase a new SmartMedia card.

CASIO COMPUTER CO., LTD. assumes no responsibility for any loss or damage to you or any third party arising out of the loss or corruption of data.

Inserting and Removing a SmartMedia Card

The following describes how to insert a SmartMedia card into the card slot and how to remove it.

To insert a SmartMedia card into the card slot

With the contact side of the SmartMedia card facing downwards, insert the card into the card slot. Carefully push the card into the slot as far as it will go.

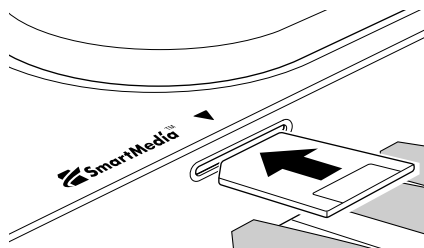

To remove a SmartMedia card from the slot

After making sure that the message "Pls Wait" is not on the display, carefully pull the card from the slot.*

* Never remove the SmartMedia card from the card slot or turn off the keyboard card while any of the following conditions exists.

- While there is the CARD indicator on the display
- While the message "Pls Wait" is on the display, indicating that a card access operation is being performed

IMPORTANT!

- Never remove the SmartMedia card from the card slot or turn off the keyboard while card data is being accessed by a read or format operation. Doing so can corrupt the data on the SmartMedia card or even damage the card slot.

Getting Ready

IMPORTANT!

- Before you can use a SmartMedia card with this keyboard, you need to perform the procedure below to format it. After formatting the card, transfer SMF data from your computer to the card.
- Formatting a SmartMedia card with this keyboard automatically creates a folder named "CASIO_MD" on the card. When transferring SMF data from your computer to the card for use by the keyboard, be sure to store it in the "CASIO_MD" folder.
- Note that formatting a card that already contains data causes all of that data to be deleted. Data deleted by the format operation cannot be recovered. Before performing the procedure below, check to make sure that the media does not contain any data you might need.

PREPARATION

- Insert the SmartMedia card you want to format into the keyboard's card slot. Make sure that the sticker is removed from the card's write area, which enables writing.

To format a SmartMedia card

- 1 Press the FUNCTION button a number of times until the card format setting screen appears.



- 2 Press the [+] (YES) button.
 - This will display a confirmation message asking whether you really want to format the media.
- 3 Press the [+] (YES) button to start formatting.
 - The message "Pls Wait" will remain on the display to indicate that a procedure is being performed. Never try to perform any other operation on the keyboard while the card is being formatted. After formatting is complete, the keyboard returns to the mode you were in before you displayed the setting screen.
 - To cancel the format operation, press the [-] (NO) button. This returns to the card format setting screen.
 - If an error message appears on the display, see "SmartMedia Card Error Messages" on page E-43. Pressing the FUNCTION button while an error message is on the display returns to the card format setting screen.



Using a SmartMedia Card

Reading a SmartMedia card

NOTE

- SMF data is converted to a format that can be played by this keyboard, and then stored in keyboard memory. Whether or not the data can fit in keyboard memory depends on the size of the converted data.

- 1 Press the CARD button.
- 2 Use the number buttons to input the two-digit number that corresponds to the SMF data you want to select.
 - Use the [+] and [-] buttons to input a data number that has more than two digits.
- 3 Perform one of the following operations.

IMPORTANT!

- All of the following points apply whenever you perform any one of the operations described below.
- If there is no data currently stored in User Song areas 60 through 64, the applicable SMF data will be loaded automatically into User Song area 60 of the keyboard's SONG BANK. After that, the keyboard will enter the Song Bank mode automatically, select area 60, and start playback.
 - If there is data already stored in User Areas 60 through 64, a confirmation message will appear asking if you want to replace all of the existing data. The existing data must be deleted in order to load the SMF data.
 - To delete the data, press the [+] button. This will delete the data, automatically enter the Song Bank Mode, and start playback of the data.
 - To cancel the delete operation, press the [-] button.

■ To play back SMF data

- 3-1 Press the START/STOP button.
 - If an error message appears, see "SmartMedia Card Error Messages" on page E-43 for information about what you need to do.

■ To sing along with SMF data

- 3-1 Press the PLAY/STOP button.
 - If an error message appears, see "SmartMedia Card Error Messages" on page E-43 for information about what you need to do.
 - Playback volume is lower for SMF data part that is assigned to Channel 4.

■ To use SMF data in a 3-Step Lesson

- 3-1 Press the STEP 1, STEP 2, or STEP 3 button.
 - If an error message appears, see "SmartMedia Card Error Messages" on page E-43 for information about what you need to do.
 - The channel specified as the navigate channel is assigned to the right-hand part, while the channel that is one less than the channel specified as the navigate channel is assigned to the left-hand part.
 - Voice Fingering Guide and on-screen fingering indicators are not supported for SMF data.

■ To evaluate your play using SMF Data

- 3-1 Press the SCORING button.
 - If an error message appears, see "SmartMedia Card Error Messages" on page E-43 for information about what you need to do.
 - The channel specified as the navigate channel is assigned to the right-hand part, while the channel that is one less than the channel specified as the navigate channel is assigned to the left-hand part.
 - On-screen fingering indicators are not supported for SMF data.
- 4 Press the START/STOP button to stop SMF data play.



SmartMedia Card Error Messages

Display Message	Cause	Action
Er Card R/W	There is something wrong with the card.	Use a different card.
Er No Card	(1) The card is not set correctly in the card slot. (2) There is no card in the card slot or the card was removed part way through a card operation.	(1) Remove the card and reinsert it correctly (page E-41). (2) Insert a card into the card slot. Never remove a card from the card slot while a card access operation is in progress.
Er Format	(1) The format of the card is not compatible with this keyboard. (2) The card is damaged.	(1) Change to a card that has the proper format. E-41 (2) Use a different card.
Er Protect	The card is write protected.	<ul style="list-style-type: none"> • Use a different card. • Remove the card's write protect sticker to enable data storage. E-40
Er SizeOver	The SMF you are trying to read is too large.	Press the CARD button to return to the SMF data selection screen, and then select different SMF data that is smaller than the file you are trying to read (page E-42).
Er WrongDat	The SMF data is corrupted or the wrong format.	Use different data.
Er Not SMF0	You are attempting to play SMF data that is not Format 0.	Use only Format 0 SMF data.
Er No File	You are trying to read data from a card that does not contain any SMF data that is supported by this keyboard.	Load a card that contains SMF data that is supported by this keyboard.

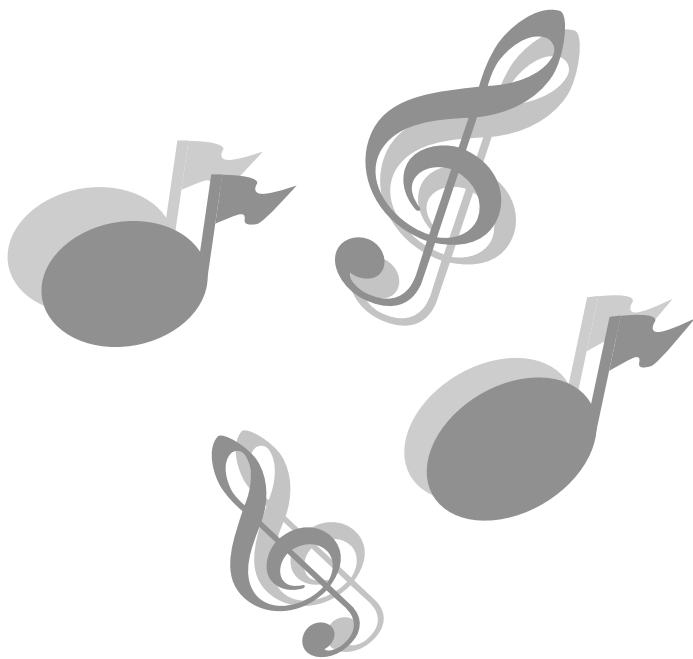
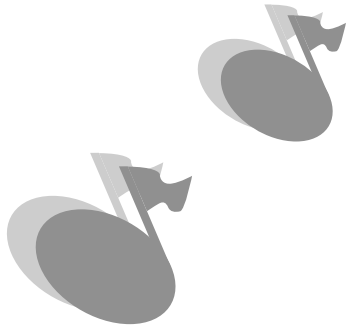



Troubleshooting

Problem	Possible Cause	Action	See page
No keyboard sound	(1) Power supply problem. (2) Power is not turned on. (3) Volume setting is too low. (4) The POWER/MODE switch is in the CASIO CHORD or FINGERED position. (5) LOCAL CONTROL is off.	(1) Correctly attach the AC adaptor, make sure that batteries poles (+/-) are facing correctly, and check to make sure that batteries are not dead. (2) Adjust the POWER/MODE switch to turn on power. (3) Use the MAIN VOL. slider to increase volume. (4) Normal play is not possible on the accompaniment keyboard while the POWER/MODE switch is set to CASIO CHORD or FINGERED. Change the POWER/MODE switch setting to NORMAL. (5) Turn on LOCAL CONTROL.	Pages E-14,15 Page E-17 Page E-17 Page E-29 Page E-37
Any of the following symptoms while using battery power.	Low battery power	Replace the batteries with a set of new ones or use the AC adaptor.	Pages E-14, 15
<ul style="list-style-type: none"> • Dim power supply indicator • Instrument does not turn on • Dim, difficult to read display • Abnormally low speaker/headphone volume • Distortion of sound output • Occasional interruption of sound when playing at high volumes • Sudden power failure when playing at high volumes • Dimming of the display when playing at high volume • Continued sound output even after you release a key • A totally different tone may sound • Abnormal rhythm pattern and demo tune play • Abnormally low microphone volume • Distortion of microphone input • Dim power supply indicator when a microphone is used • Sudden power failure when using the microphone • Dimming of keyboard lights when notes sound • Loss of power, sound distortion, or low volume when playing from a connected computer 			
Auto Accompaniment does not sound.	Accompaniment volume is set to 00.	Use the FUNCTION button to increase the volume.	Page E-33
Key light stays on.	Keyboard is waiting for play of the correct note during Step 1 or Step 2 play.	<ul style="list-style-type: none"> • Press the lit key to continue with Step 1 or Step 2 play. • Press the START/STOP button to quit Step 1 or Step 2 play. 	Page E-23 Page E-23
Keys are lit though no sound is being produced.	Power on alert is reminding you that power was left on without any operation being performed.	Press any button or keyboard key to restore power to normal.	Page E-15





Troubleshooting

Problem	Possible Cause	Action	See page
Static noise when a microphone is connected.	(1) Use of a microphone that is a different from the type that is recommended.	(1) Use a recommended type microphone.	Page E-26
	(2) Use of the microphone in the vicinity of fluorescent lighting.	(2) Move the microphone away from source of the static.	Page E-26
No microphone sound	(1) Microphone volume setting is too low.	(1) Increase the microphone volume setting.	Page E-26
	(2) Microphone ON/OFF switch is set to OFF.	(2) Change the microphone ON/OFF switch setting to ON.	Page E-26
Cannot recall data from a card.	(1) The card is not inserted correctly into the card slot.	(1) Correctly insert the card into the card slot.	Page E-41
	(2) You are trying to use a card whose voltage or capacity is not supported by this keyboard.	(2) Use only a card of the voltage and capacity specified for this keyboard.	Page E-40
	(3) The card is damaged.	(3) Use a different card.	Page E-40



Specifications

Model:	LK-70S
Keyboard:	61 standard-size keys, 5 octaves
Key Light System:	Can be turned on and off (up to 10 keys can be lit at the same time)
Tones:	100
Rhythm Instrument Tones:	52
Polyphony:	24 notes maximum (12 for certain tones)
Auto Accompaniment Rhythm Patterns: Tempo: Chords: Rhythm Controller: Accomp Volume:	50 Variable (216 steps, ♩ = 40 to 255) 2 fingering methods (CASIO CHORD, FINGERED) START/STOP, FILL-IN, SYNCHRO 0 to 99 (100 steps)
<3-Step Lesson System> 3-step Lesson: Playback: Evaluation Mode: Voice Fingering Guide:	3 lessons (Step 1, 2, 3) Repeat play of a single tune Scoring On/Off
Song Bank Number of Tunes: Controllers:	60 + Up to 5 download songs START/STOP, LEFT/RIGHT
Sing Along Mode Number of Tunes: Controllers:	60 PLAY/STOP, KEY CONTROL (25 steps, -12 semitones to +12 semitones)
User Area:	Capacity: Approximately 89 Kbytes
Other Functions Transpose: Tuning:	25 steps (-12 semitones to +12 semitones) 101 steps (A4 = approximately 440Hz ±50Cents)
Card Slot: Functions:	3.3V SmartMedia™ (8MB, 16MB, 32MB, 64MB, 128MB) Playback of SMF; card formatting;
Terminals SUSTAIN Jack: Headphone/Output Jack: Microphone In: USB Port	Standard jack Stereo standard jack Output Impedance: 94Ω Output Voltage: 3V (RMS) MAX Standard jack (with microphone volume knob) Input impedance: 3KΩ Input sensitivity: 10mV
Power Jack:	9V DC
Power Supply: Batteries: Battery Life: AC Adaptor: Auto Power Off:	2-way 6 AA-size batteries Approximately 1 hour continuous operation on manganese batteries Approximately 4 hours continuous operation on alkaline batteries AD-5 Turns power off approximately 6 minutes after last key operation. Enabled under batter power only, can be disabled manually.
Speaker Output:	2.0W + 2.0W
Power Consumption:	9V --- 7.7W
Dimensions:	94.4 × 37.3 × 13.0 cm (37 ³ / ₁₆ × 14 ¹¹ / ₁₆ × 5 ¹ / ₈ inch)
Weight:	Approximately 4.6kg (10.1 lbs)(without batteries)

• Design and specifications are subject to change without notice.



Appendix/Apéndice

Tone List / Note Table

NOTE

- The display screen will show “- -” for the number whenever a program change number other than those listed below is received over the navigate channel.

Lista de sonidos / Tabla de notas

NOTA

- La pantalla de presentación mostrará “- -” para el número, siempre que se recibe un número de cambio de programa diferente al listado debajo sobre el canal de navegación.

No./ Nº	Tone Name/ Nombre de sonido	Range Type/ Tipo de gama	Maximum Polyphony/ Polifonía máxima	Prog Change/ Cambio de programa	Bank Select Msb/ Msb de selección de banco
PIANO					
00	GRAND PIANO	A	32	0	2
01	BRIGHT PIANO	A	32	1	2
02	MELLOW PIANO	A	32	0	1
03	DANCE PIANO	A	32	1	1
04	STRINGS PIANO	A	16	0	8
05	HONKY-TONK	A	16	3	2
06	OCTAVE PIANO	A	16	3	8
07	ELEC. GRAND PIANO	A	16	2	2
08	ELEC. PIANO	A	32	4	2
09	MODERN E. PIANO	A	32	5	2
10	CHORUSED EP	A	16	4	1
11	SOFT E.PIANO	A	16	4	8
12	E.PIANO PAD	A	16	5	8
13	HARPSICHORD	A	32	6	2
14	COUPLED HARPSICHORD	A	16	6	8
15	CLAVI	A	32	7	2
CHROMATIC PERC					
16	CELESTA	A	32	8	2
17	GLOCKENSPIEL	B	32	9	2
18	VIBRAPHONE	A	32	11	2
19	MARIMBA	A	32	12	2
ORGAN					
20	DRAWBAR ORGAN 1	A	16	16	2
21	DRAWBAR ORGAN 2	A	16	16	1
22	PERC.ORGAN 1	A	16	17	2
23	PERC.ORGAN 2	A	16	17	1
24	ELEC.ORGAN	A	16	16	8
25	ROCK ORGAN	A	16	18	2
26	CHURCH ORGAN	A	16	19	2
27	CHAPEL ORGAN	A	32	19	8
28	ACCORDION	A	16	21	2
29	OCTAVE ACCORDION	A	16	21	8
30	BANDONEON	A	16	23	2
31	HARMONICA	A	32	22	2
GUITAR					
32	NYLON STR.GUITAR	C	32	24	2
33	STEEL STR.GUITAR	C	32	25	2
34	12 STR.GUITAR	C	16	25	8
35	JAZZ GUITAR	C	32	26	2
36	CLEAN GUITAR	C	32	27	2
37	ELEC.GUITAR	C	16	27	1
38	MUTE GUITAR	C	32	28	2
39	OVERDRIVE GT	C	32	29	2
40	DISTORTION GT	C	32	30	2
41	FEEDBACK GT	C	16	31	8

Appendix/Apéndice

No./ Nº	Tone Name/ Nombre de sonido	Range Type/ Tipo de gama	Maximum Polyphony/ Polifonía máxima	Prog Change/ Cambio de programa	Bank Select Msb/ Msb de selección de banco
BASS					
42	ACOUSTIC BASS	C	32	32	2
43	RIDE BASS	C	16	32	8
44	FINGERED BASS	C	32	33	2
45	PICKED BASS	C	32	34	2
46	FRETLESS BASS	C	32	35	2
47	SLAP BASS	C	32	36	2
48	SYNTH-BASS 1	C	32	38	2
49	SYNTH-BASS 2	C	32	39	2
STR/ORCHESTRA					
50	VIOLIN	A	32	40	2
51	SLOW VIOLIN	A	32	40	8
52	CELLO	C	32	42	2
53	HARP	A	32	46	2
ENSEMBLE					
54	STRINGS	A	32	48	2
55	SLOW STRINGS	A	32	49	2
56	CHAMBER	A	16	48	1
57	SYNTH-STRINGS 1	A	32	50	2
58	SYNTH-STRINGS 2	A	32	51	2
59	CHOIRS	A	32	52	2
60	VOICE DOO	A	32	53	2
61	SYNTH-VOICE	A	16	54	2
BRASS					
62	TRUMPET	A	32	56	2
63	TROMBONE	C	32	57	2
64	TUBA	C	32	58	2
65	MUTE TRUMPET	A	32	59	2
66	FRENCH HORN	C	16	60	2
67	BRASS	A	32	61	2
68	BRASS SFZ	A	16	61	8
69	SYNTH-BRASS 1	A	32	62	2
70	SYNTH-BRASS 2	A	16	63	2
REED					
71	SOPRANO SAX	A	32	64	2
72	ALTO SAX	C	32	65	2
73	TENOR SAX	C	32	66	2
74	BARITONE SAX	C	32	67	2
75	OBOE	A	32	68	2
76	CLARINET	A	32	71	2
PIPE					
77	PICCOLO	B	32	72	2
78	FLUTE	A	32	73	2
79	MELLOW FLUTE	A	32	73	8
80	RECORDER	A	32	74	2
81	PAN FLUTE	A	32	75	2
82	OCARINA	A	32	79	2



Appendix/Apéndice

No./ Nº	Tone Name/ Nombre de sonido	Range Type/ Tipo de gama	Maximum Polyphony/ Polifonía máxima	Prog Change/ Cambio de programa	Bank Select Msb/ Msb de selección de banco
SYNTH-LEAD					
83	SQUARE LEAD	A	16	80	2
84	SAWTOOTH LEAD	A	16	81	2
85	MELLOW SAW LEAD	A	16	81	8
86	SINE LEAD	A	32	80	8
87	CALLIOPE	A	16	82	2
88	VOICE LEAD	A	16	85	2
89	BASS+LEAD	A	16	87	2
SYNTH-PAD					
90	FANTASY	A	16	88	2
91	WARM PAD	A	16	89	2
92	POLYSYNTH	A	16	90	2
93	BOWED PAD	A	16	92	2
94	HALO PAD	A	16	94	2
95	SOUND TRACK	A	16	97	2
96	ATMOSPHERE	A	16	99	2
97	BRIGHTNESS	A	16	100	2
98	ECHO PAD	A	16	102	2
DRUMS					
99	DRUM SET	D	32	0	120

NOTE

- The meaning of each range type is described below.

NOTA

- El significado de cada tipo de gama se describe debajo.

- DRUM SET (No. 99) assigns 47 percussion sounds and five voice sounds to the keyboard as shown below. The sounds assigned to each key are indicated above the keyboard.
- DRUM SET (Nº 99) asigna 47 pulsadores de percusión y cinco sonidos de voz al teclado, como se muestra a continuación. Los sonidos asignados a cada tecla se indican arriba del teclado.



Standard1 Kick 1	High Tom 1	Open Low Conga	Mute Cuica
Side Stick	Ride Cymbal 1	High Timbale	Open Cuica
Standard1 Snare 1	Chinese Cymbal	Low Timbale	Mute Triangle
Hand Clap	Ride Bell	High Agogo	Open Triangle
Standard1 Snare 2	Tambourine	Low Agogo	Shaker
Low Tom 2	Splash Cymbal	Cabasa	ONE Count Voice 1
Closed Hi-Hat	Cowbell	Maracas	TWO Count Voice 2
Low Tom 1	Crash Cymbal 2	Short High Whistle	THREE Count Voice 3
Pedal Hi-Hat	Vibraslap	Long Low Whistle	FOUR Count Voice 4
Mid Tom 2	Ride Cymbal 2	Short Guiro	FIVE Count Voice 5
Open Hi-Hat	High Bongo	Long Guiro	
Mid Tom 1	Low Bongo	Claves	
High Tom 2	Mute High Conga	High Wood Block	
Crash Cymbal 1	Open High Conga	Low Wood Block	



Appendix/Apéndice

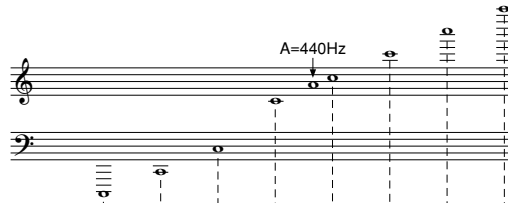

Range Type	C-1	C0	C1	C2	C3	C4	C5	C6	C7	G7	C8	C9	G9
A (Standard type) (Tipo estándar)													
B ("17 GLOCKENSPIEL"/ "77 PICCOLO")													
C (Low pitch instruments) (Instrumentos de altura tonal baja)													
D (Sound Effect) (Efecto de sonido)	No scale for tones. Sin escala para los sonidos.												

- aKeyboard range
.....Gama del teclado
- bAvailable range (using transpose or a message receive)
.....Gama disponible (usando la transposición o recepción de mensaje)



Fingered Chord Charts

Cuadros de acordes digitados

This table shows the left-hand fingerings (including inverted forms) for a number of often-used chords.

Esta tabla muestra las digitaciones (incluyendo las formas invertidas) para varios de los acordes más a menudo usados.

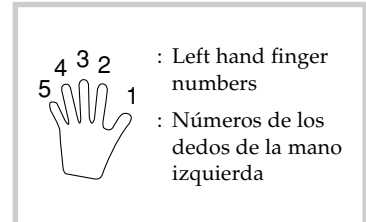

Chord Root	M	m	7	m7	dim7	M7	m7 ^b 5	dim
C	[5, 3, 1]	[5, 3, 1]	[5, 3, 2, 1]	[5, 3, 2, 1]	[5, 3, 2, 1]	[5, 3, 2, 1]	[5, 3, 2, 1]	[5, 3, 2]
C [#] (D ^b)	[5, 3, 1]	[5, 3, 1]	[5, 3, 2, 1]	[5, 3, 2, 1]	[5, 3, 2, 1]	[5, 3, 2, 1]	[5, 3, 2, 1]	[5, 3, 2]
D	[5, 3, 1]	[5, 3, 1]	[5, 3, 2, 1]	[5, 3, 2, 1]	[5, 3, 2, 1]	[5, 3, 2, 1]	[5, 3, 2, 1]	[5, 3, 2]
E ^b (D [#])	[5, 3, 1]	[5, 3, 1]	[5, 3, 2, 1]	[5, 3, 2, 1]	[5, 3, 2, 1]	[5, 3, 2, 1]	[5, 3, 2, 1]	[5, 3, 2]
E	[5, 3, 1]	[5, 3, 1]	[5, 3, 2, 1]	[5, 3, 2, 1]	[5, 3, 2, 1]	[5, 3, 2, 1]	[5, 3, 2, 1]	[5, 3, 2]
F	[5, 3, 1]	[5, 3, 1]	[5, 3, 2, 1]	[5, 3, 2, 1]	[5, 3, 2, 1]	[5, 3, 2, 1]	[5, 3, 2, 1]	[5, 3, 2]
F [#] (G ^b)	[5, 3, 1]	[5, 3, 1]	[5, 3, 2, 1]	[5, 3, 2, 1]	[5, 3, 2, 1]	[5, 3, 2, 1]	[5, 3, 2, 1]	[5, 3, 2]
G	[5, 3, 1]	[5, 3, 1]	[5, 3, 2, 1]	[5, 3, 2, 1]	[5, 3, 2, 1]	[5, 4, 2, 1]	[5, 3, 2, 1]	[5, 3, 2]
A ^b (G [#])	[5, 3, 1]	[5, 3, 1]	[5, 4, 2, 1]	[5, 4, 2, 1]	[5, 3, 2, 1]	[5, 4, 2, 1]	[5, 4, 2, 1]	[5, 3, 2]
A	[5, 3, 1]	[5, 3, 1]	[5, 4, 2, 1]	[5, 4, 2, 1]	*	[5, 4, 2, 1]	[5, 4, 2, 1]	[5, 3, 2]
B ^b (A [#])	[5, 3, 1]	[5, 3, 1]	[5, 4, 2, 1]	[5, 4, 2, 1]	*	[5, 4, 2, 1]	[5, 4, 2, 1]	[5, 3, 2]
B	[5, 2, 1]	[5, 2, 1]	[5, 3, 2, 1]	[5, 3, 2, 1]	*	[5, 3, 2, 1]	[5, 4, 2, 1]	[5, 3, 2]



Appendix/Apéndice

Chord Root Type	aug	sus4	7 sus4	m add9	m M7	7 ^b 5	add9
C	[5, 3, 1]	[5, 2, 1]	[5, 3, 2, 1]	[4, 3, 2, 1]	[5, 3, 2, 1]	[5, 3, 2, 1]	[4, 3, 2, 1]
C [#] (D ^b)	[5, 3, 1]	[5, 2, 1]	[5, 3, 2, 1]	[4, 3, 2, 1]	[5, 3, 2, 1]	[5, 3, 2, 1]	[4, 3, 2, 1]
D	[5, 3, 1]	[5, 2, 1]	[5, 3, 2, 1]	[4, 3, 2, 1]	[5, 3, 2, 1]	[5, 3, 2, 1]	[4, 3, 2, 1]
E ^b (D [#])	[5, 3, 1]	[5, 2, 1]	[5, 3, 2, 1]	[4, 3, 2, 1]	[5, 3, 2, 1]	[5, 3, 2, 1]	[4, 3, 2, 1]
E	[5, 3, 1]	[5, 2, 1]	[5, 3, 2, 1]	[4, 3, 2, 1]	[5, 3, 2, 1]	[5, 3, 2, 1]	[4, 3, 2, 1]
F	[5, 3, 1]	[5, 2, 1]	[5, 3, 2, 1]	[4, 3, 2, 1]	[5, 3, 2, 1]	[5, 3, 2, 1]	[4, 3, 2, 1]
F [#] (G ^b)	[5, 3, 1]	[5, 2, 1]	[5, 3, 2, 1]	[4, 3, 2, 1]	[5, 3, 2, 1]	[5, 3, 2, 1]	[4, 3, 2, 1]
G	[5, 3, 1]	[5, 2, 1]	[5, 3, 2, 1]	[4, 3, 2, 1]	[5, 4, 2, 1]	[5, 3, 2, 1]	[4, 3, 2, 1]
A ^b (G [#])	[5, 3, 1]	[5, 2, 1]	[5, 4, 2, 1]	[4, 3, 2, 1]	[5, 4, 2, 1]	[5, 4, 2, 1]	[4, 3, 2, 1]
A	[5, 3, 1]	[5, 2, 1]	[5, 4, 2, 1]	[4, 3, 2, 1]	[5, 4, 2, 1]	[5, 4, 2, 1]	[4, 3, 2, 1]
B ^b (A [#])	*	[5, 2, 1]	[5, 4, 2, 1]	[4, 3, 2, 1]	[5, 4, 2, 1]	[5, 4, 2, 1]	[4, 3, 2, 1]
B	*	[5, 2, 1]	[5, 3, 2, 1]	[5, 3, 2, 1]	[5, 3, 2, 1]	[4, 3, 2, 1]	[5, 3, 2, 1]

* Cannot be specified in FINGERED setting because of accompaniment keyboard limitations, but augmented and diminished (seventh) chords made up of the same component notes (with different base note) can be used instead.

Chords with same component notes as B^b aug D aug, F[#] aug
 Chords with same component notes as B aug E^b aug, G aug
 Chords with same component notes as A dim7 C dim7, E^b dim7, F[#] dim7
 Chords with same component notes as B^b dim7 C[#] dim7, E dim7, G dim7
 Chords with same component notes as B dim7 D dim7, F dim7, A^b dim7

* No puede especificarse en el ajuste FINGERED debido a las limitaciones del teclado de acompañamiento, pero en su lugar pueden usarse los acordes aumentados y disminuidos (séptima) compuestos por las mismas notas componentes (con diferente nota básica).

Acordes con las mismas notas componentes como B^b aumentada D aumentada, F[#] aumentada.
 Acordes con las mismas notas componentes como B aumentada E^b aumentada, G aumentada.
 Acordes con las mismas notas componentes como A dim7 C dim7, E^b dim7, F[#] dim7.
 Acordes con las mismas notas componentes como B^b dim7 C[#] dim7, E dim7, G dim7.
 Acordes con las mismas notas componentes como B dim7 D dim7, F dim7, A^b dim7.



Rhythm List / Lista de ritmos

POPS	
00	CLUB POP
01	FUNKY POP
02	SOUL BALLAD
03	POP BALLAD
04	LITE POP
05	16 BEAT FUNK
06	8 BEAT POP
07	POP ROCK
08	DANCE POP
09	POP FUSION
10	FOLKIE POP
ROCK	
11	ROCK WALTZ
12	SLOW ROCK
13	SOFT ROCK
14	50'S ROCK
15	60'S ROCK
16	4 BEAT ROCK
17	ROCK
18	TWIST
19	NEW ORLNS R&R
20	R&B
JAZZ/FUSION	
21	BIG BAND
22	SWING
23	FOX TROT
24	JAZZ WALTZ
25	LATIN FUSION
DANCE/FUNK	
26	TECHNO
27	TRANCE
28	DISCO
29	FUNK
30	RAP
EUROPEAN	
31	POLKA
32	MARCH
33	WALTZ
34	SLOW WALTZ
35	TANGO

LATIN/VARIOUS I	
36	BOSSA NOVA
37	SAMBA
38	MAMBO
39	REGGAE
40	SKA
41	SALSA
42	FOLKLORE
43	RUMBA CATALANA
VARIOUS II	
44	COUNTRY
45	TOWNSHIP
46	SLOW GOSPEL
47	BALADI
48	BAROQUE
49	NEW AGE

Song Bank List / Lista del banco de canciones

00	SEPTEMBER	39	SAKURA SAKURA
01	CROCODILE ROCK	40	HOLDIRIDIA
02	HAPPY BIRTHDAY TO YOU	41	LA PALOMA
03	WE WISH YOU A MERRY CHRISTMAS	42	SANTA LUCIA
04	JINGLE BELLS	43	TROIKA
05	SILENT NIGHT	44	WALTZING MATILDA
06	JOY TO THE WORLD	45	AJO MAMMA
07	O CHRISTMAS TREE	46	LA DONNA É MOBILE FROM "RIGOLETTE"
08	WHEN THE SAINTS GO MARCHING IN	47	CHANSON DU TOREADOR FROM "CARMEN"
09	GREENSLEEVES	48	HABANERA FROM "CARMEN"
10	AMAZING GRACE	49	LE CYGNE FROM "LE CARNAVAL DES ANIMAUX"
11	AULD LANG SYNE	50	THE ENTERTAINER
12	TWINKLE TWINKLE LITTLE STAR	51	FÜR ELISE
13	LIGHTLY ROW	52	PIANO SONATA op.13 "PATHÉTIQUE" 2nd Mov.
14	SUMM SUMM SUMM	53	PIANO SONATA op.27 no.2 "MOONLIGHT" 1st Mov.
15	THE MUFFIN MAN	54	TURKISH MARCH (MOZART)
16	LONG LONG AGO	55	PIANO SONATA K.545 1st Mov.
17	ACH DU LIEBER AUGUSTIN	56	CHOPSTICKS
18	LONDON BRIDGE	57	JESUS BLEIBET MEINE FREUDE
19	SUR LE PONT D'AVIGNON	58	MINUET (J.S.BACH)
20	SIPPIN' CIDER THROUGH A STRAW	59	CANON (PACHELBEL)
21	GRANDFATHER'S CLOCK	60-64	User Songs / Canctones del usuario
22	MICHAEL ROW THE BOAT ASHORE		
23	DANNY BOY		
24	ANNIE LAURIE		
25	MY BONNIE		
26	IF YOU'RE HAPPY AND YOU KNOW IT, CLAP YOUR HANDS		
27	MY DARLING CLEMENTINE		
28	HOME SWEET HOME		
29	J'AI PERDU LE DO DE MA CLARINETTE		
30	I'VE BEEN WORKING ON THE RAILROAD		
31	LITTLE BROWN JUG		
32	AURA LEE		
33	SWANEE RIVER (OLD FOLKS AT HOME)		
34	YANKEE DOODLE		
35	RED RIVER VALLEY		
36	TURKEY IN THE STRAW		
37	HOME ON THE RANGE		
38	ALOHA OE		

Model **LK-70S** Version: 1.0
MIDI messages that can be sent and received using the USB port
Los mensajes MIDI pueden enviarse y recibirse usando el puerto USB

Function ...	Transmitted	Recognized	Remarks
Basic Channel Default Changed	1 1-16	1-16 1-16	
Mode Default Messages Altered	Mode 3 X *****	Mode 3 X *****	
Note Number True voice	36-96 *****	0-127 12-108*1	*1: See Tone List on page A-1. *1: Vea la lista de sonidos en la página A-1.
Velocity Note ON Note OFF	X 9nH V = 100 X 9nH V = 0	O 9nH V = 1-127 X 9nH V = 0, 8nH V = XX	XX: no relation XX: sin relación
After Touch Key's Ch's	X X	X X	
Pitch Bender	X	O	
Control Change 0, 32 1 6, 38 7 10 11	O X X X X X	O O O*2 O O O	Bank select Modulation Data entry Volume Pan Expression



11	X	X	Hold1 RPN LSB, MSB All sound off Reset all controller
64 100, 101 120 121	O X X X	O O*2 O O	
Program Change : True #	O 0-127 *****	O 0-127 *****	
System Exclusive	X	O*3	
System Common : Song Pos : Song Sel : Tune	X X X	X X X	
System Real Time : Clock : Commands	X X	X X	
Aux : Local ON/OFF : All notes OFF : Active Sense : Reset	X X X X	X O O X	
Remarks	*2 FINE TUNE, COARSE TUNE, PITCH BEND SENSE and RPN Null receive *2 FINE TUNE, COARSE TUNE, PITCH BEND SENSE y recepción nula RPN. *3 GM on/off GM ON : [F0] [7E] [7F] [09] [01] [F7] GM OFF : [F0] [7E] [7F] [09] [02] [F7] *3 Activación/desactivación GM: [F0] [7E] [7F] [09] [01] [F7] GM OFF: [F0] [7E] [7F] [09] [02] [F7]		

O : Yes
X : No

Mode 1 : OMNI ON, POLY
Mode 2 : OMNI ON, MONO
Mode 3 : OMNI OFF, POLY
Mode 4 : OMNI OFF, MONO



This recycle mark indicates that the packaging conforms to the environmental protection legislation in Germany.

Esta marca de reciclaje indica que el empaquetado se ajusta a la legislación de protección ambiental en Alemania.

CASIO®

CASIO COMPUTER CO.,LTD.
6-2, Hon-machi 1-chome
Shibuya-ku, Tokyo 151-8543, Japan

MA0406-B Printed in China
LK70S-ES-1

Free Manuals Download Website

<http://myh66.com>

<http://usermanuals.us>

<http://www.somanuals.com>

<http://www.4manuals.cc>

<http://www.manual-lib.com>

<http://www.404manual.com>

<http://www.luxmanual.com>

<http://aubethermostatmanual.com>

Golf course search by state

<http://golfingnear.com>

Email search by domain

<http://emailbydomain.com>

Auto manuals search

<http://auto.somanuals.com>

TV manuals search

<http://tv.somanuals.com>