

LK-73

USER'S GUIDE GUÍA DEL USUARIO



GUIDELINES LAID DOWN BY FCC RULES FOR USE OF THE UNIT IN THE U.S.A. (not applicable to other areas).

NOTICE

This equipment has been tested and found to comply with the limits for a Class B digital device, pursuant to Part 15 of the FCC Rules. These limits are designed to provide reasonable protection against harmful interference in a residential installation. This equipment generates, uses and can radiate radio frequency energy and, if not installed and used in accordance with the instructions, may cause harmful interference to radio communications. However, there is no guarantee that interference will not occur in a particular installation. If this equipment does cause harmful interference to radio or television reception, which can be determined by turning the equipment off and on, the user is encouraged to try to correct the interference by one or more of the following measures:

- Reorient or relocate the receiving antenna.
- Increase the separation between the equipment and receiver.
- Connect the equipment into an outlet on a circuit different from that to which the receiver is connected.
- Consult the dealer or an experienced radio/TV technician for help.

FCC WARNING

Changes or modifications not expressly approved by the party responsible for compliance could void the user's authority to operate the equipment.

■ Important!

Please note the following important information before using this product.

- ♦ Before using the optional AD-5 Adaptor to power the unit, be sure to check the AC Adaptor for any damage first. Carefully check the power cord for breakage, cuts, exposed wire and other serious damage. Never let children use an AC adaptor that is seriously damaged.
- ♦ Never attempt to recharge batteries.
- ♦ Do not use rechargeable batteries.
- ♦ Never mix old batteries with new ones.
- ♦ Use recommended batteries or equivalent types.
- ♦ Always make sure that positive (+) and negative (-) poles are facing correctly as indicated near the battery compartment.
- ♦ Replace batteries as soon as possible after any sign they are getting weak.
- ♦ Do not short-circuit the battery terminals.
- ♦ The product is not intended for children under 3 years.
- ♦ Use only CASIO AD-5 adaptor.
- ♦ The AC adaptor is not a toy.
- ♦ Be sure to disconnect the AC adaptor before cleaning the product.



CASIO ELECTRONICS CO., LTD.
Unit 6, 1000
North Circular Road
London NW2 7JD, U.K.



This mark is valid in the EU countries only.
Please keep all information for future reference.

Safety Precautions

Congratulations on your selection of the CASIO electronic musical instrument.

- Before using the instrument, be sure to carefully read through the instructions contained in this manual.
- Please keep all information for future reference.

Symbols Various symbols are used in this user's guide and on the product itself to ensure that the product is used safely and correctly, and to prevent injury to the user and other persons as well as damage to property. Those symbols along with their meanings are shown below.

 DANGER	This symbol indicates information that, if ignored or applied incorrectly, creates the danger of death or serious personal injury.
 WARNING	This indication stipulates matters that have the risk of causing death or serious injury if the product is operated incorrectly while ignoring this indication.
 CAUTION	This indication stipulates matters that have the risk of causing injury as well as matters for which there is the likelihood of occurrence of physical damage only if the product is operated incorrectly while ignoring this indication.

Symbol Examples





This triangle symbol () means that the user should be careful. (The example at left indicates electrical shock caution.)





This circle with a line through it () means that the indicated action must not be performed. Indications within or nearby this symbol are specifically prohibited. (The example at left indicates that disassembly is prohibited.)



The black dot () means that the indicated action must be performed. Indications within this symbol are actions that are specifically instructed to be performed. (The example at left indicates that the power plug must be unplugged from the electrical socket.)







 DANGER	
Alkaline Batteries	
Perform the following steps immediately if fluid leaking from alkaline batteries ever gets into your eyes.	
<ol style="list-style-type: none"> 1. Do not rub your eyes! Rinse them with water. 2. Contact your physician immediately. 	
Leaving alkaline battery fluid in your eyes can lead to loss of sight.	







 WARNING	
Smoke, Strange Odor, Overheating	
Continued use of the product while it is emitting smoke, a strange odor, or heat creates the risk of fire and electric shock. Take the following steps immediately.	
<ol style="list-style-type: none"> 1. Turn off power. 2. If you are using the AC adaptor for power, unplug it from the wall outlet. 3. Contact your original retailer or an authorized CASIO Service Provider. 	







AC Adaptor	
Misuse of the AC adaptor creates the risk of fire and electric shock. Always make sure you observe the following precautions.	
<ul style="list-style-type: none"> • Be sure to use only the AC adaptor that is specified for this product. • Use only a power source whose voltage is within the rating marked on the AC adaptor. • Do not overload electrical outlets and extension cords. 	 





AC Adaptor	
Misuse of the AC adaptor's electric cord can damage or break it, creating the risk of fire and electric shock. Always make sure you observe the following precautions.	
<ul style="list-style-type: none"> • Never place heavy objects on the cord or subject it to heat. 	

Safety Precautions

 WARNING	
<ul style="list-style-type: none"> • Never try to modify the cord or subject it to excessive bending. • Never twist or stretch the cord. • Should the electric cord or plug become damaged, contact your original retailer or authorized CASIO Service Provider. 	
AC Adaptor	
<p>Never touch the AC adaptor while your hands are wet. Doing so creates the risk of electric shock.</p>	
Batteries	
<p>Misuse of batteries can cause them to leak, resulting in damage to nearby objects, or to explode, creating the risk of fire and personal injury. Always make sure you observe the following precautions.</p> <ul style="list-style-type: none"> • Never try to take batteries apart or allow them to become shorted. • Never expose batteries to heat or dispose of them by incineration. • Never mix old batteries with new ones. • Never mix batteries of different types. • Do not charge the batteries. • Make sure the positive (+) and negative (-) ends of the batteries are facing correctly. 	
Do not incinerate the product	
<p>Never throw the product into fire. Doing so can cause it to explode, creating the risk of fire and personal injury.</p>	
Water and Foreign Matter	
<p>Water, other liquids, and foreign matter (such as pieces of metal) getting into the product create the risk of fire and electric shock. Take the following steps immediately.</p> <ol style="list-style-type: none"> 1. Turn off power. 2. If you are using the AC adaptor for power, unplug it from the wall outlet. 3. Contact your original retailer or an authorized CASIO Service Provider. 	

 WARNING	
Disassembly and Modification	
<p>Never try to take this product apart or modify it in any way. Doing so creates the risk of electric shock, burn injury, or other personal injury. Leave all internal inspection, adjustment, and maintenance up to your original retailer or authorized CASIO Service Provider.</p>	
Dropping and Impact	
<p>Continued use of this product after it has been damaged by dropping or subjecting it to strong impact creates the risk of fire and electric shock. Take the following steps immediately.</p> <ol style="list-style-type: none"> 1. Turn off power. 2. If you are using the AC adaptor for power, unplug it from the wall outlet. 3. Contact your original retailer or an authorized CASIO Service Provider. 	
Plastic Bags	
<p>Never place the plastic bag the product comes in over your head or in your mouth. Doing so creates the risk of suffocation. Particular care concerning this precaution is required where small children are present.</p>	
Keep off of the product and stand.*	
<p>Climbing onto the product or stand can cause it to tip over or become damaged. Particular care concerning this precaution is required where small children are present.</p>	
Location	
<p>Avoid locating the product on an unstable stand, on an uneven surface, or any other unstable location. An unstable location can cause the product to fall over, creating the risk of personal injury.</p>	

 CAUTION	
AC Adaptor	
Misuse of the AC adaptor creates the risk of fire and electric shock. Always make sure you observe the following precautions.	
<ul style="list-style-type: none"> Do not locate the electric cord near a stove or other sources of heat. Never pull on the cord when unplugging from the electrical outlet. Always grasp the AC adaptor when unplugging. 	
AC Adaptor	
Misuse of the AC adaptor creates the risk of fire and electric shock. Always make sure you observe the following precautions.	
<ul style="list-style-type: none"> Insert the AC adaptor into the wall outlet as far as it will go. Unplug the AC adaptor from the wall outlet during lightning storms or before leaving on a trip or other long-term absence. At least once a year, unplug the AC adaptor from the wall outlet and wipe away any dust that is built up in the area around the prongs of the plug. 	
Relocating the Product	
Before relocating the product, always unplug the AC adaptor from the wall outlet and disconnect all other cables and connecting cords. Leaving cords connected creates the risk of damage to the cords, fire, and electric shock.	
Cleaning	
Before cleaning the product, always unplug the AC adaptor from the wall outlet first. Leaving the AC adaptor plugged in creates the risk of damage to the AC adaptor, fire, and electric shock.	
Batteries	
Misuse of batteries can cause them to leak resulting in damage to nearby objects, or to explode, creating the risk of fire and personal injury. Always make sure you observe the following precautions.	
<ul style="list-style-type: none"> Use only batteries that are specified for use with this product. 	

 CAUTION	
<ul style="list-style-type: none"> Remove batteries from the product if you do not plan to use it for a long time. 	
Connectors	
Connect only the specified devices and equipment to the product's connectors. Connection of a non-specified device or equipment creates the risk of fire and electric shock.	
Location	
Avoid the following locations for this product. Such locations create the risk of fire and electric shock.	
<ul style="list-style-type: none"> Areas subject to high humidity or large amounts of dust. In food preparation areas or other areas subject to oil smoke. Near air conditioning equipment, on a heated carpet, in areas exposed to direct sunlight, inside of a vehicle parked in the sun, or any other area that subjects the product to high temperatures. 	
Display Screen	
<ul style="list-style-type: none"> Never push on the display screen's LCD panel or subject it to strong impact. Doing so can cause the LCD panel's glass to crack, creating the risk of personal injury. Should the LCD panel ever crack or break, never touch the liquid inside of the panel. LCD panel liquid can cause skin irritation. Should LCD panel liquid ever get inside your mouth, immediately wash out your mouth with water and contact your physician. Should LCD panel liquid ever get into your eyes or onto your skin, rinse with clear water for at least 15 minutes, and then contact a physician. 	
Sound Volume	
Do not listen to music at very loud volumes for long periods. Particular care concerning this precaution is required when using headphones. High volume settings can damage your hearing.	

Safety Precautions



CAUTION

Heavy Objects

Never place heavy object on top of the product.

Doing so can make the product top heavy, causing the product to tip over or the object to fall from it, creating the risk of personal injury.



Correct Stand* Assembly

An incorrectly assembled stand can tip over, causing the product to fall and creating the risk of personal injury.

Make sure you assemble the stand correctly, following the assembly instructions that come with it. Make sure you mount the product on the stand correctly.



* Stand is available as an option.

IMPORTANT!

When using batteries, be sure to replace them or shift to one of the alternate power sources whenever you notice any of the following symptoms.

- Dim power indicator
- Instrument does not turn on
- Display that is flickering, dim, or difficult to read
- Abnormally low speaker/headphone volume
- Distortion of sound output
- Occasional interruption of sound when playing at high volume
- Sudden power failure when playing at high volume
- Flickering or dimming of the display when playing at high volume
- Continued sound output even after you release a key
- A tone that is totally different from the one that is selected
- Abnormal rhythm pattern and Song Bank play
- Dimming of keyboard lights when notes sound
- Loss of power, sound distortion, or low volume when playing from a connected computer or MIDI device

Main Features



■ 137 tones

Everything from orchestra instruments to synthesized sounds, drum sets and more.

■ 100 rhythms

A selection of rhythms that cover rock, pops, jazz and just about any other musical style imaginable.

■ Auto Accompaniment

Simply specify a chord and the keyboard automatically plays the correct rhythm, bass, and chord parts.

■ 100 built-in tunes

A simple operation cuts out the melody part of any of the 100 Song Bank tunes so you can play along on the keyboard.

■ Key Light System with 3-step lesson

Use any of the 100 Song Bank tunes to learn to play as the keyboard keys light to teach you the correct notes. First practice the timing of the notes. Next, play along at your own pace. Soon you will be ready for step three, where you play along at normal speed.

- ♦ Note that key lights may be difficult to see under direct sunlight or under other very bright lighting.

■ Big display with a wealth of musical information

A big, informative display shows you which fingers to use, which keys to press, staff notation of the notes being played, and much more.

■ Memory function

Record up to two parts in memory for later playback. Realistic ensemble play can also be created using the Auto Accompaniment function.

■ General MIDI compatibility

General MIDI tones let you connect to a personal computer and enjoy “desktop music” capabilities. This keyboard can be used as a desktop music input device or as a sound source, and it’s just the thing for play back of commercially available pre-recorded General MIDI music software.

■ Keys light to show received MIDI messages

The keyboard can be set up so its keys light in accordance with the channels of commercially available General MIDI music software. You can even turn off the output of a channel and play along on the keyboard.



Contents

Safety Precautions E-1

Main Features E-5

Contents E-6

General Guide E-8

About the Display E-10

Quick Reference E-11

Power Supply E-13

Using batteries E-13

Using the AC Adaptor E-14

Auto Power Off E-14

Power On Alert E-14

Settings and Memory Contents E-15

Connections E-16

Phones/Output Terminal E-16

Sustain/Assignable
jack Terminal E-16

Accessories and Options E-17

Basic Operations E-18

Playing the Keyboard E-18

Selecting a Tone E-18

Turning the Key Light System
On and Off E-19

Using the Metronome E-19

**Auto
Accompaniment E-21**

Selecting a Rhythm E-21

Playing a Rhythm E-21

Adjusting the Tempo E-22

Using Auto Accompaniment E-22

Using an Intro Pattern E-25

Using a Fill-in Pattern E-25

Using a Rhythm Variation E-25

Using a Fill-in Pattern with
a Variation Rhythm E-26

Synchro Starting Accompaniment
with Rhythm Play E-26

Finishing with an Ending Pattern E-26

Adjusting the Accompaniment
Volume E-27

Song Bank E-28

Selecting a Tune E-28

Playing a Tune E-28

Adjusting the Tempo E-29

Pausing Playback E-29

Fasting Reverse E-30

Fasting Forward E-30

Changing the Melody Tone E-30

Playing All Song Bank Tunes
in Succession E-31

3-Step Lesson E-32

Step 1 – Master the timing. E-33

Step 2 – Master the melody. E-34

Step 3 – Play at normal speed. E-35

**Song Memory
Function E-36**

Tracks E-36

Real-time Recording to Track 1 E-37



Playing Back from Song Memory E-39

Real-time Recording to Track 2 E-39

Recording Chords with
Step Recording E-40

Step Recording Melody
to Track 2 E-43

Track 2 Contents After
Step Recording E-43

Editing Data While
Step Recording E-44

Deleting the Contents of
a Specific Track E-45

Drum Assignment List A-3

Fingered Chord Chart A-4

Rhythm List A-6

MIDI Implementation Chart

Keyboard Settings E-46

Using Layer E-46

Using Split E-47

Using Layer and Split Together E-48

Using Touch Response E-49

Transposing the Keyboard E-49

Tuning the Keyboard E-50

MIDI E-51

What is MIDI? E-51

General MIDI E-52

Changing MIDI Settings E-52

Messages E-56

Troubleshooting E-59

Specifications E-61

Care of your keyboard E-63

Appendix A-1

Note Table A-1

General Guide

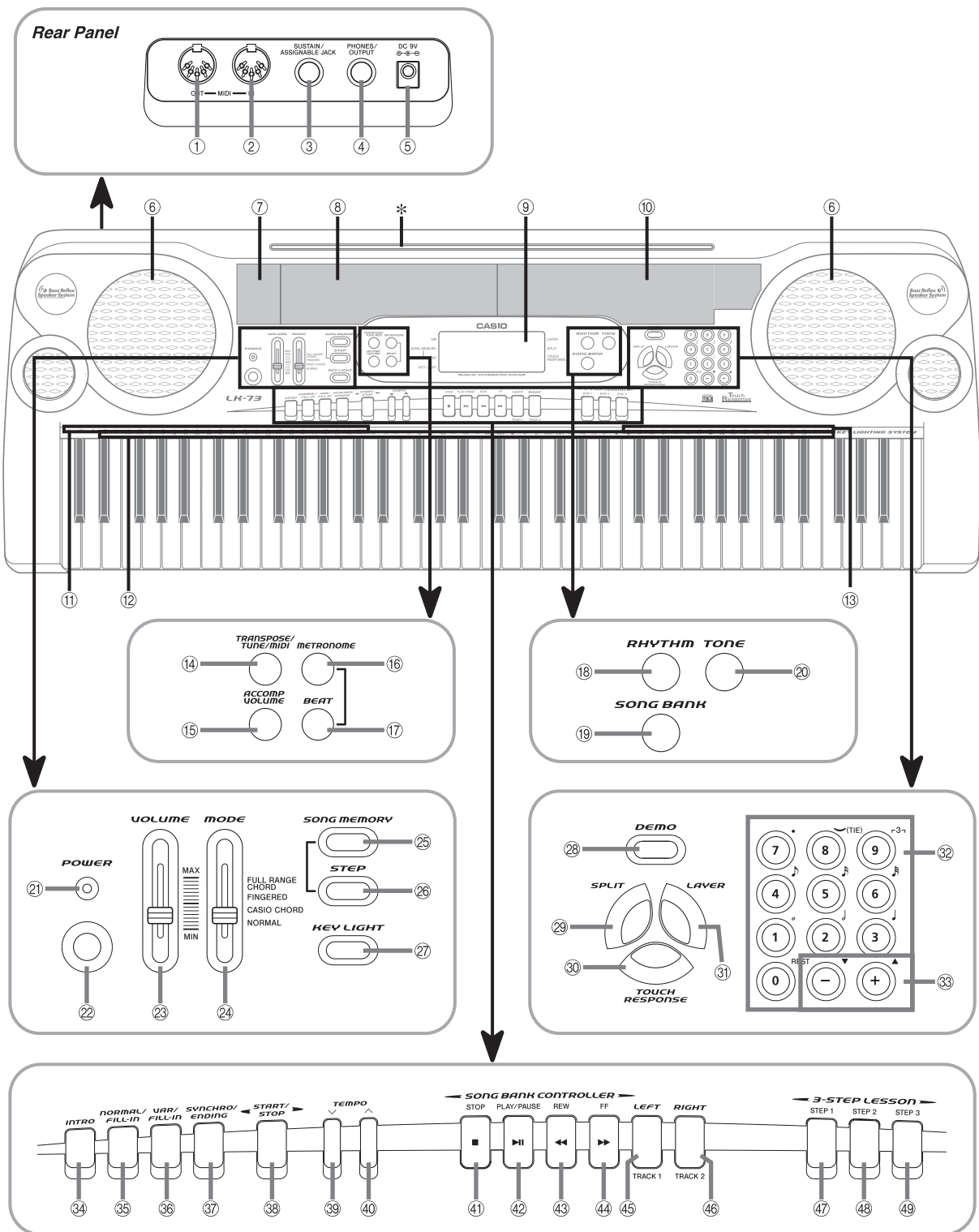



*** Attaching the Score Stand**

Insert the score stand into the slot at the keyboard as shown in the illustration.

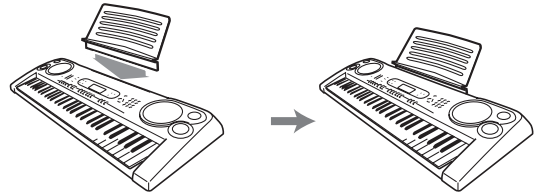

- ① MIDI OUT terminal
- ② MIDI IN terminal
- ③ SUSTAIN/ASSIGNABLE JACK terminal
- ④ PHONES/OUTPUT terminal
- ⑤ DC 9V jack
- ⑥ Speaker
- ⑦ Rhythm list
- ⑧ Tone list
- ⑨ Display
- ⑩ Song Bank list
- ⑪ Chord root names
- ⑫ Percussion instrument list
- ⑬ Chord types name
- ⑭ TRANSPOSE/TUNE/MIDI button
- ⑮ ACCOMP VOLUME button
- ⑯ METRONOME button
- ⑰ BEAT button
- ⑱ RHYTHM button
- ⑲ SONG BANK button
- ⑳ TONE button
- ㉑ POWER indicator
- ㉒ POWER button
- ㉓ VOLUME slider
- ㉔ MODE switch
- ㉕ SONG MEMORY button
- ㉖ STEP button
- ㉗ KEY LIGHT button

- ㉘ DEMO button

Playing a Demo Tune

Pressing the DEMO button starts demo tune play, which plays the 100 built-in tunes in sequence. To stop demo tune play, press the DEMO, START/STOP, or STOP button.

NOTE

- ◆ Pressing [+] (forward) or [-] (back) skips to the next demo tune.
- ◆ You can change the tone setting of the keyboard (page E-18) before starting demo play, and then use that tone to play along on the keyboard.
- ◆ MIDI, Layer, and Split are disabled while a demo tune is playing.

- ㉙ SPLIT button
- ㉚ TOUCH RESPONSE button
- ㉛ LAYER button
- ㉜ Number buttons
 - ◆ For input of numbers to change a displayed number or setting.
- ㉝ +/- buttons
 - ◆ Negative values cannot be input using the number buttons. Use [+] (increase) and [-] (decrease) instead.
- ㉞ INTRO button
- ㉟ NORMAL/FILL-IN button
- ㊱ VAR/FILL-IN button
- ㊲ SYNCHRO/ENDING button
- ㊳ START/STOP button
- ㊴ TEMPO ▼ button
- ㊵ TEMPO ▲ button
- ㊶ STOP button
- ㊷ PLAY/PAUSE button
- ㊸ REW button
- ㊹ FF button
- ㊺ LEFT/TRACK 1 button
- ㊻ RIGHT/TRACK 2 button
- ㊼ STEP 1 button
- ㊽ STEP 2 button
- ㊾ STEP 3 button

About the Display

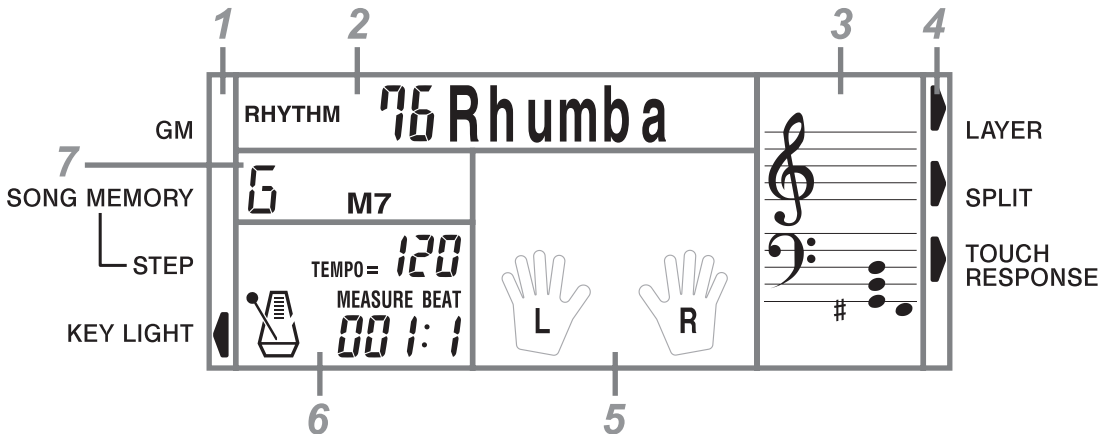

1. An indicator appears next to a function that is in use: GM (General MIDI Mode), SONG MEMORY (Song Memory), STEP (Step), KEY LIGHT (key light).
2. This area shows tone number and name, rhythm number and name, and tune number and name. It also shows other information when using the song memory function and other functions. Indicators also appear here to show what kind of data is displayed: TONE (tone data), RHYTHM (rhythm data), SONG BANK (Song Bank data).
3. This area is a staff notation display that shows notes being played on the keyboard or from song memory, chord forms, and MIDI receive data*. If you are using a pedal, a pedal mark (ped.) appears here whenever you press the pedal.
 - [Octave mark (*sva*)] (HIGH)
Appears when the note produced by the keyboard is one octave higher than the note indicated on the staff.
 - [Octave mark (*sva*)] (LOW)
Appears when the note produced by the keyboard is one octave lower than the note indicated on the staff.
 - * Received notes outside the range of C1 to C7 do not appear on the display.
4. An indicator appears next to a function that is in use: LAYER (layer), SPLIT (split), TOUCH RESPONSE (touch response).
5. This area shows fingerings, dynamic marks, finger crossing techniques, and other finger information during 3-step lesson and Song Bank play. The letters "L" (left) and "R" (right) appear to indicate left and right hand Auto Accompaniment parts and memory tracks.
6. This area shows measure number, beat number, a graphic metronome, and tempo value (beats per minute) during rhythm and Auto Accompaniment play, and when using song memory. It also shows the step number when using the 3-step lesson.
7. This area shows chord names during Auto Accompaniment and Song Bank play.

NOTE

- Display examples shown in this User's Guide are intended for illustrative purposes only. The actual text and values that appear on the display may differ from the examples shown in this User's Guide.

Quick Reference

- If you selected lesson Step 2
 - ◆ Play the correct notes on the keyboard.



- ◆ Press the keyboard key that lights. Note that with tunes 70 through 99, the keyboard key light turns off as soon as you press the key.
- ◆ The keyboard key for the next note you will need to play flashes.
- ◆ A sub-melody (obligato) plays in time with the melody, as long as you press the correct keyboard keys.

Power Supply

This keyboard can be powered by current from a standard household wall outlet (using the specified AC adaptor) or by batteries. Always make sure you turn the keyboard off whenever you are not using it.

Using batteries

Always make sure you turn off the keyboard before loading or replacing batteries.

To load batteries

1. Remove the battery compartment cover.

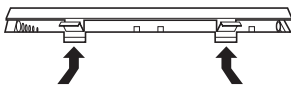

2. Load 6 D-size batteries into the battery compartment.

- Make sure that the positive (+) and negative (-) ends are facing correctly.

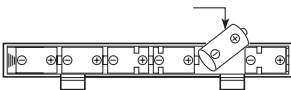

3. Insert the tabs on the battery compartment cover into the holes provided and close the cover.

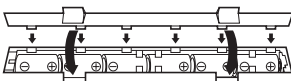

The keyboard may not function correctly if you load or replace batteries with power turned on. If this happens, turning the keyboard off and then back on again should return functions back to normal.

Important Battery Information

- The following shows the approximate battery life.
 - Manganese batteries 5 hours*
- * The above value is standard battery life at normal temperature, with the keyboard volume at medium setting. Temperature extremes or playing at very loud volume settings can shorten battery life.

- Any of the following symptoms indicate low battery power. Replace batteries as soon as possible whenever any of the following occurs.
 - Dim power indicator
 - Instrument does not turn on
 - Display that is flickering, dim, or difficult to read
 - Abnormally low speaker/headphone volume
 - Distortion of sound output
 - Occasional interruption of sound when playing at high volume
 - Sudden power failure when playing at high volume
 - Flickering or dimming of the display when playing at high volume
 - Continued sound output even after you release a key
 - A tone that is totally different from the one that is selected
 - Abnormal rhythm pattern and Song Bank play
 - Dimming of keyboard lights when notes sound
 - Loss of power, sound distortion, or low volume when playing from a connected computer or MIDI device

! WARNING

Misuse of batteries can cause them to leak, resulting in damage to nearby objects, or to explode, creating the risk of fire and personal injury. Always make sure you observe the following precautions.

- Never try to take batteries apart or allow them to become shorted. 
- Never expose batteries to heat or dispose of them by incineration.
- Never mix old batteries with new ones.
- Never mix batteries of different types.
- Do not charge the batteries.
- Make sure the positive (+) and negative (-) ends of the batteries are facing correctly.

! CAUTION

Misuse of batteries can cause them to leak resulting in damage to nearby objects, or to explode, creating the risk of fire and personal injury. Always make sure you observe the following precautions.

- Use only batteries that are specified for use with this product. 
- Remove batteries from the product if you do not plan to use it for a long time.

Using the AC Adaptor

Make sure that you use only the AC adaptor specified for this keyboard.

Specified AC Adaptor: AD-5

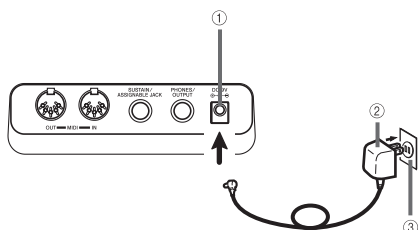





- ① DC 9V jack
- ② AC adaptor AD-5
- ③ AC outlet

Also note the following important warnings and precautions when using the AC adaptor.



⚠ WARNING

Misuse of the AC adaptor creates the risk of fire and electric shock. Always make sure you observe the following precautions.

- Be sure to use only the AC adaptor that is specified for this product. 
 - Use only a power source whose voltage is within the rating marked on the AC adaptor.
 - Do not overload electrical outlets and extension cords. 
 - Never place heavy objects on the cord or subject it to heat. 
 - Never try to modify the cord or subject it to excessive bending.
 - Never twist or stretch the cord.
 - Should the electric cord or plug become damaged, contact your original retailer or authorized CASIO Service Provider. 
 - Never touch the AC adaptor while your hands are wet. 
- Doing so creates the risk of electric shock.

⚠ CAUTION

Misuse of the AC adaptor creates the risk of fire and electric shock. Always make sure you observe the following precautions.

- Do not locate the electric cord near a stove or other sources of heat. 
- Never pull on the cord when unplugging from the electrical outlet. Always grasp the AC adaptor when unplugging.
- Insert the AC adaptor into the wall outlet as far as it will go. 
- Unplug the AC adaptor from the wall outlet during lightning storms or before leaving on a trip or other long-term absence.
- At least once a year, unplug the AC adaptor from the wall outlet and wipe away any dust that is built up in the area around the prongs of the plug.

IMPORTANT!

- Make sure that the keyboard is turned off before connecting or disconnecting the AC adaptor.
- Using the AC adaptor for a long time can cause it to become warm to the touch. This is normal and does not indicate malfunction.

Auto Power Off

When you are using battery power, keyboard power turns off automatically whenever you leave it on without performing any operation for about 6 minutes. When this happens, press the POWER button to turn power back on.

NOTE

- Auto Power Off is disabled (it does not function) when you are using the AC adaptor to power the keyboard.

Power On Alert

Keyboard keys light to alert you if you leave power on and do not perform any operation for about 6 minutes. Note that keys light only, and no sound is produced. When this happens, press any button or keyboard key to clear the power on alert.

NOTE

- Power on alert operates only when you are powering the keyboard using the AC adaptor. It does not operate when you are using batteries.



To disable Auto Power Off and power on alert

Hold down the TONE button while turning on the keyboard to disable Auto Power Off and power on alert.

- When these functions are turned off, the keyboard does not turn off automatically and no alert is performed no matter how long it is left with no operation being performed.
- Auto Power Off and power on alert are enabled again when you manually turn off power and then turn it back on again.

Settings and Memory Contents

Settings

Tone, rhythm, and other “main keyboard settings” in effect when power is turned off manually with the POWER button or automatically by Auto Power Off remain in effect when you next turn power back on.

Main Keyboard Settings

Main keyboard settings are: tone number, layer, split, split point, touch response, rhythm number, tempo, accompaniment volume, General MIDI mode on/off, accomp MIDI OUT on/off, Sustain/Assignable jack setting, keyboard channel, and Song Bank number.

Memory Contents

In addition to the above settings, data stored using the song memory function is also retained.

Electrical Power

The settings and memory data described above are retained as long as the keyboard is being supplied with electrical power. Unplugging the AC adaptor when batteries are not loaded or when loaded batteries are dead cuts off the keyboard's electrical power supply. This causes all settings to be initialized to their factory defaults and clears all data stored in memory.

Power Requirements

Note the following precautions whenever you want to ensure that current keyboard settings and memory contents are not lost.

- Make sure the keyboard is being supplied power through the AC adaptor before replacing its batteries.
- Before unplugging the AC adaptor, make sure that fresh batteries are loaded in the keyboard.
- Make sure that keyboard power is turned off before replacing batteries or unplugging the AC adaptor.

Connections

Phones/Output Terminal

Before connecting headphones or other external equipment, be sure to first turn down the volume settings of the keyboard and the connected equipment. You can then adjust volume to the desired level after connections are complete.

Rear Panel

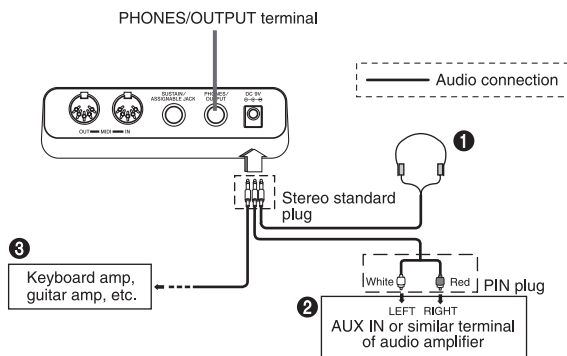

■ Connecting Headphones (Figure 1)

Connecting headphones cuts off output from the keyboard's built-in speakers, so you can play even late at night without disturbing anyone.

■ Audio Equipment (Figure 2)

Connect the keyboard to an audio equipment using a commercially available connecting cord with a standard plug on one end and two PIN plugs on the other end. Note that the standard plug you connect to the keyboard must be a stereo plug, otherwise you will be able to output only one of stereo channels. In this configuration, you normally set the input selector of the audio equipment to the terminal (usually marked AUX IN or something similar) where the cord from the keyboard is connected. See the user documentation that comes with your audio equipment for full details.

■ Musical Instrument Amplifier (Figure 3)

Use a commercially available connecting cord to connect the keyboard to a musical instrument amplifier.

NOTE

- Be sure to use a connecting cord that has a stereo standard plug on the end you connect to the keyboard, and a connector that provides dual channel (left and right) input to the amplifier to which you are connecting. The wrong type of connector at either end can cause one of the stereo channels to be lost.

When connected to a musical instrument amplifier, set the volume of the keyboard to a relatively low level and make output volume adjustments using the amplifier's controls.

Connection Example

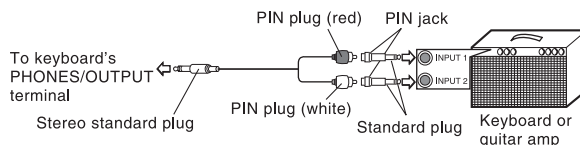

Sustain/Assignable Jack Terminal

You can connect an optional sustain pedal (SP-2, SP-10 or SP-20) to the SUSTAIN/ASSIGNABLE JACK terminal to enable the capabilities described below.

For details on how to select the pedal function you want, see "SUSTAIN/ASSIGNABLE JACK" on page E-55.

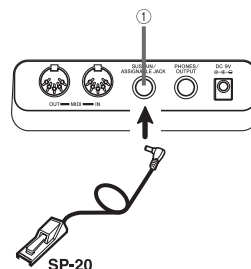

① SUSTAIN/ASSIGNABLE JACK Terminal

■ Sustain Pedal

- With piano tones, depressing the pedal causes notes to linger, much like a piano's damper pedal.
- With organ tones, depressing the pedal causes notes to continue to sound until the pedal is released.

■ Sostenuto Pedal

- As with the sustain pedal function described above, depressing the sostenuto pedal causes notes to be sustained.
- This difference between a sostenuto pedal and sustain pedal is the timing. With a sostenuto pedal, you press the keys and then depress the pedal before you release the keys. Only the notes that are sounding when the pedal is depressed are sustained.

■ Soft Pedal

Depressing the pedal softens the sound of the notes being played.



■ Rhythm Start/Stop Pedal

In this case, the pedal performs the same functions as the START/STOP button.

Accessories and Options

Use only the accessories and options specified for this keyboard. Use of non-authorized items creates the danger of fire, electric shock, and personal injury.

Basic Operations

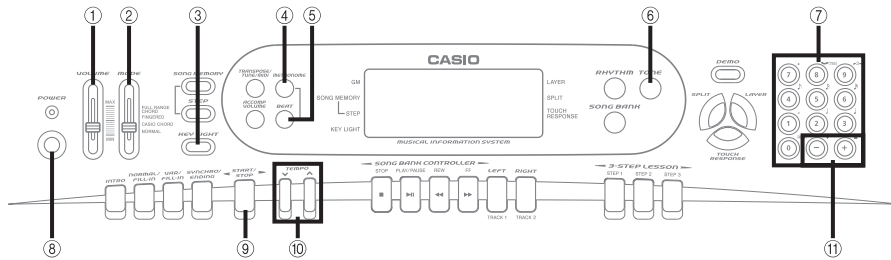

- | | | |
|------------------|-----------|--------------|
| ① VOLUME | ② MODE | ③ KEY LIGHT |
| ④ METRONOME | ⑤ BEAT | ⑥ TONE |
| ⑦ Number buttons | ⑧ POWER | ⑨ START/STOP |
| ⑩ TEMPO | ⑪ [+]/[-] | |

This section provides information on performing basic keyboard operations.

Playing the Keyboard

To play the keyboard

1. Press the POWER button to turn the keyboard on.
2. Set the MODE switch to NORMAL.
3. Use the VOLUME slider to set the volume to a relatively low level.
4. Play something on the keyboard.

Selecting a Tone

This keyboard comes with 137 built-in tones. Use the following procedure to select the tone you want to use.

To select a tone

1. Find the tone you want to use in the keyboard's tone list and note its tone number.
2. Press the TONE button.



①

- ① Indicator appears

3. Use the number buttons to input the three digit tone number for the tone you want to select.

Example:

To select "032 ACOUSTIC BASS", input 0, 3 and then 2.



NOTE

- Always input all three digits for the tone number, including leading zeros (if any). If you input one or two digits and stop, the display will automatically clear your input after a few seconds.
- You can also increment the displayed tone number by pressing [+] and decrement it by pressing [-].
- When one of the drum sets is selected (tone numbers 128 through 136), each keyboard key is assigned a different percussion sound. See page A-3 for details.

Polyphony

The term polyphony refers to the maximum number of notes you can play at the same time. The keyboard has 24-note polyphony, which includes the notes you play as well as the rhythms and auto-accompaniment patterns that are played by the keyboard. This means that when a rhythm or auto-accompaniment pattern is being played by the keyboard, the

number of notes (polyphony) available for keyboard play is reduced. Also note that some of the tones offer only 12-note polyphony.

- When rhythm or auto accompaniment is playing, the number of sounds simultaneously played is reduced.

Digital Sampling

A number of the tones that are available with this keyboard have been recorded and processed using a technique called digital sampling. To ensure a high level of tonal quality, samples are taken in the low, mid, and high ranges and then combined to provide you with sounds that are amazingly close to the originals. You may notice very slight differences in volume or sound quality for some tones when you play them at different positions on the keyboard. This is an unavoidable result of multiple sampling, and it is not a sign of malfunction.

Turning the Key Light System On and Off

Use the following procedure when you want to turn the key light system on or off.

To turn the key light system on and off

1. Press the KEY LIGHT button to toggle the key light system on and off.
 - The KEY LIGHT pointer disappears when the key light system is turned off.

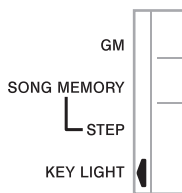

NOTE

- The key light system is turned on automatically whenever you turn on keyboard power.

Using the Metronome

The metronome feature of this keyboard produces a bell sound for the first beat of each measure, followed by click sounds for each successive beat of the measure. It is the perfect tool for practicing tunes without accompaniment (rhythm).

To start the metronome

1. Press the METRONOME button to start sounding the metronome.

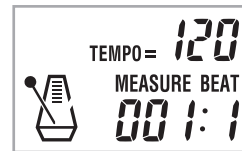

2. Press the BEAT button and then use the number buttons or [+] and [-] to change the number of beats per measure.
 - You can specify the number of beats per measure as a value from 1 to 6.

6 Beat

NOTE

- The bell (indicating the first beat of a measure) does not sound while one beat per measure is specified. All beats are indicated by a click sound. This setting lets you practice with a steady beat, without worrying about how many beats there are in each measure.

3. Use the TEMPO buttons to set the tempo.

- Press ▲ to increase the tempo (make it faster) or ▼ to decrease it (make it slower).

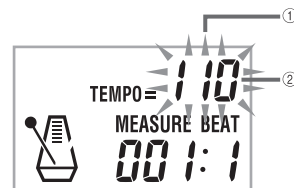

- ① Flash
- ② Tempo value



Basic Operations

NOTE

- While the tempo value is flashing, you can also use the number buttons or [+] and [-] to input a three-digit value. Note that you must input leading zeros, so 90 is input as 090.
- Pressing both the ▲ and ▼ TEMPO buttons at the same time automatically returns the currently selected rhythm to its default tempo.

4. To turn off the metronome, press the METRONOME or START/STOP button.

NOTE

- The metronome is disabled whenever you are using Step 1 or Step 2 of the 3-step lesson.
- Starting play of a two-hand tune (Song Bank tunes 70 through 99) or Step 3 of the 3-step lesson while the metronome is operating or activating the metronome while either of the two above operations is already in progress causes the metronome to sound in time with the Auto Accompaniment played by the keyboard. At this time, the tempo of the metronome beat changes to that of the default tempo for the Auto Accompaniment being played.

Auto Accompaniment

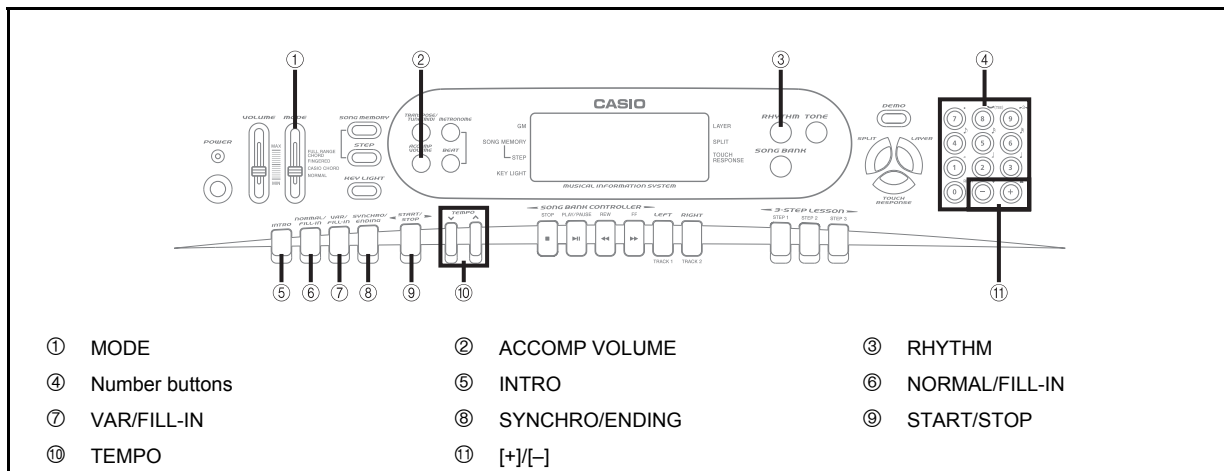

This keyboard automatically plays bass and chord parts in accordance with the chords you finger. The bass and chord parts are played using sounds and tones that are automatically selected to select the rhythm you are using. All of this means that you get full, realistic accompaniments for the melody notes you play with your right hand, creating the mood of an one-person ensemble.

NOTE

- You can also increment the displayed rhythm number by pressing [+] and decrement it by pressing [-].

Selecting a Rhythm

This keyboard provides you with 100 exciting rhythms that you can select using the following procedure.

To select a rhythm

- Find the rhythm you want to use in the "Rhythm List" (page A-6) and note its rhythm number.
- Press the RHYTHM button.



① Indicator appears

- Use the number buttons to input the two digit rhythm number for the rhythm you want to select.

Example:

To select "76 RHUMBA", input 7 and then 6.



Playing a Rhythm

Use the following procedure to start and stop rhythm play.

To play a rhythm

- Set the MODE switch to NORMAL.
- Press the START/STOP button to start play of the currently selected rhythm.
- To stop rhythm play, press the START/STOP button again.

NOTE

- All of the keyboard keys are melody keys while the MODE switch is set to NORMAL.

Adjusting the Tempo

The tempo (beats per minute) can be set to a value in the range of 40 to 255. The tempo value you set is used for Song Bank, 3-step lesson, and Auto Accompaniment chord play, as well as playback from memory and metronome operation.

To set the tempo

1. Use the TEMPO buttons to set the tempo.

- ▲ : Increases the tempo value.
- ▼ : Decreases the tempo value.

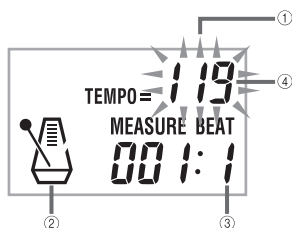

- ① Flash
- ② Metronome
- ③ Beat number
- ④ Tempo value

NOTE

- While the tempo value is flashing, you can also use the number buttons or [+] and [-] to input a three-digit value. Note that you must input leading zeros, so 90 is input as 090.
- Pressing both the ▲ and ▼ TEMPO buttons at the same time automatically returns the currently selected rhythm to its default tempo.

Using Auto Accompaniment

The following procedure describes how to use the keyboard's Auto Accompaniment feature. Before starting, you should first select the rhythm you want to use and set the tempo of the rhythm to the value you want.

To use Auto Accompaniment

- 1.** Set the MODE switch to CASIO CHORD, FINGERED, or FULL RANGE CHORD.
- 2.** Press the START/STOP button to start play of the currently selected rhythm.

3. Play a chord.

- The actual procedure you should use to play a chord depends on the current MODE switch position. Refer to the following pages for details on chord play.

CASIO CHORD	Page E-22
FINGERED	Page E-23
FULL RANGE CHORD	Page E-24

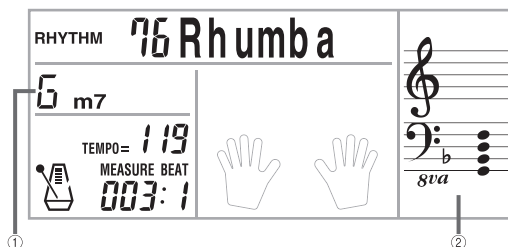

- ① Chord name
- ② Basic Chord Form
(The chord form that appears here may show notes that differ from those actually pressed on the keyboard.)

- 4.** To stop Auto Accompaniment play, press the START/STOP button again.

CASIO CHORD

This method of chord play makes it possible for anyone to easily play chords, regardless of previous musical knowledge and experience. The following describes the CASIO CHORD "Accompaniment keyboard" and "Melody keyboard", and tells you how to play CASIO CHORDs.



■ CASIO CHORD Accompaniment Keyboard and Melody Keyboard

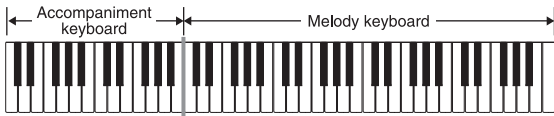

NOTE

- The accompaniment keyboard can be used for playing chords only. No sound will be produced if you try playing single melody notes on the accompaniment keyboard.

Chord Types

CASIO CHORD accompaniment lets you play four types of chords with minimal fingering.

Chord Types	Example
<p>Major chords Major chord names are marked above the keys of the accompaniment keyboard. Note that the chord produced when you press an accompaniment keyboard does not change octave, regardless of which key you use to play it.</p>	<p>C Major (C) C C D E E F F G A B B C C D E E F F G A B B</p>
<p>Minor chords (m) To play a minor chord, keep the major chord key depressed and press any other accompaniment keyboard key located to the right of the major chord key.</p>	<p>C minor (Cm) C C D E E F F G A B B C C D E E F F G A B B</p>
<p>Seventh chords (7) To play a seventh chord, keep the major chord key depressed and press any other two accompaniment keyboard keys located to the right of the major chord key.</p>	<p>C seventh (C7) C C D E E F F G A B B C C D E E F F G A B B</p>
<p>Minor seventh chords (m7) To play a minor seventh chord, keep the major chord key depressed and press any other three accompaniment keyboard keys located to the right of the major chord key.</p>	<p>C minor seventh (Cm7) C C D E E F F G A B B C C D E E F F G A B B</p>

NOTE

- It makes no difference whether you press black or white keys to the right of a major chord key when playing minor and seventh chords.

FINGERED

FINGERED provides you with a total of 15 different chord types. The following describes the FINGERED “Accompaniment keyboard” and “Melody keyboard”, and tells you how to play a C-root chord using FINGERED.

■ FINGERED Accompaniment Keyboard and Melody Keyboard



NOTE

- The accompaniment keyboard can be used for playing chords only. No sound will be produced if you try playing single melody notes on the accompaniment keyboard.

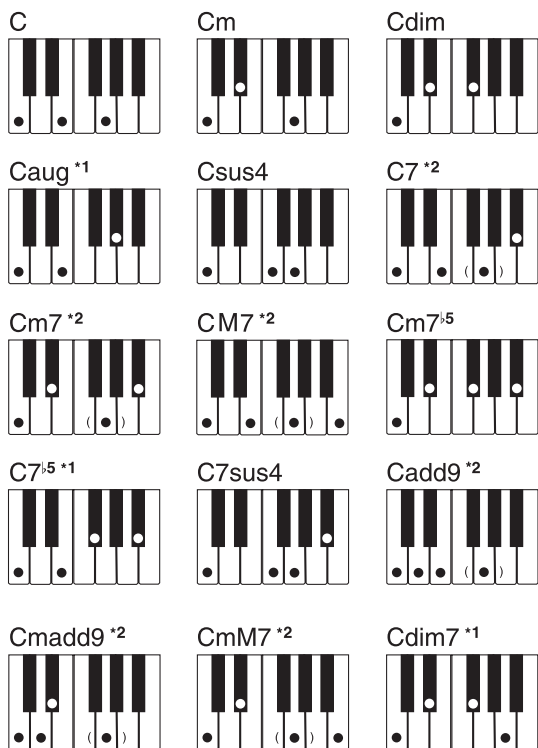

See the "Fingered Chord Chart" on page A-4 for details on playing chords with other roots.

- *1. Inverted fingerings cannot be used. The lowest note is the root.
- *2. The same chord can be played without pressing the 5th G.

NOTE

- Except for the chords specified in note *1 above, inverted fingerings (i.e. playing E-G-C or G-C-E instead of C-E-G) will produce the same chords as the standard fingering.
- Except for the exception specified in note *2 above, all of the keys that make up a chord must be pressed. Failure to press even a single key will not play the desired FINGERED chord.
- When the key light system is turned on, the keys of the accompaniment keyboard light to show the chord you played. Though the chord is the same, the form of the chord (the keys that light) may differ from the one you used (the keys you pressed). If you play C Major using the inverted chord form E-G-C, for example, the keys for C-E-G will light.

FULL RANGE CHORD

This accompaniment method provides a total of 38 different chord types: the 15 chord types available with FINGERED plus 23 additional types. The keyboard interprets any input of three or more keys that matches a FULL RANGE CHORD pattern to be a chord. Any other input (that is not a FULL RANGE CHORD pattern) is interpreted as melody play. Because of this, there is no need for a separate accompaniment keyboard, so the entire keyboard, from end to end, can be used for both melody and chords.

FULL RANGE CHORD Accompaniment Keyboard and Melody Keyboard



Chords Recognized by This Keyboard

Chord Types	Number of Types
Corresponding FINGERED Chord	15 (page E-23)
Other Chords	23 The following are examples of chords that use C as the bass note. $C_6 \cdot C_{m6} \cdot C_{69}$ $\frac{C\#}{C} \cdot \frac{D}{C} \cdot \frac{E}{C} \cdot \frac{F}{C} \cdot \frac{G}{C} \cdot \frac{A\flat}{C} \cdot \frac{B\flat}{C}$ $\frac{B}{C} \cdot \frac{C\sharp m}{C} \cdot \frac{Dm}{C} \cdot \frac{Fm}{C} \cdot \frac{Gm}{C} \cdot \frac{Am}{C} \cdot \frac{B\sharp m}{C}$ $\frac{Dm\sharp 5}{C} \cdot \frac{A\flat 7}{C} \cdot \frac{F7}{C} \cdot \frac{Fm7}{C} \cdot \frac{Gm7}{C} \cdot \frac{A\flat add9}{C}$

Example:

To play the chord C major.

Any of the fingerings shown in the illustration below will produce C major.

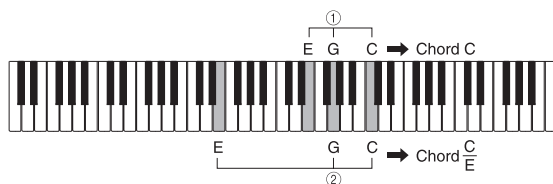

NOTE

- As with the FINGERED mode (page E-23), you can play the notes that form a chord in any combination (①).



- When the composite notes of a chord are separated by 6 or more notes, the lowest sound becomes the bass (②).

Music Example

Tone: 016, Rhythm: 05, Tempo: 070

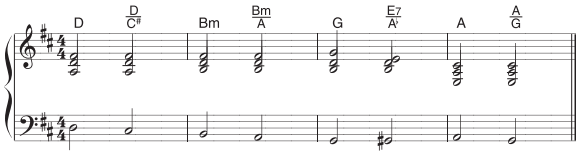

Using an Intro Pattern

This keyboard lets you insert a short intro into a rhythm pattern to make startup smoother and more natural.

The following procedure describes how to use the Intro feature. Before starting, you should first select the rhythm you want to use, and set the tempo.

To insert an intro

1. Press the INTRO button to start the selected rhythm with an intro pattern.
 - With the above setup, the intro pattern is played and the auto accompaniment with intro pattern starts as soon as you play chords on the accompaniment keyboard.

NOTE

- The standard rhythm pattern starts to play after the intro pattern is complete.
- Pressing the VAR/FILL-IN button while an intro pattern is playing causes the variation pattern to sound after the intro pattern is complete.
- Pressing the SYNCHRO/ENDING button while an intro pattern is playing causes the ending pattern to sound after the intro pattern is complete.

Using a Fill-in Pattern

Fill-in patterns let you momentarily change the rhythm pattern to add some interesting variation to your performances.

The following procedure describes how to use the Fill-in feature.

To insert a fill-in

1. Press the START/STOP button to start rhythm play.
2. Press the NORMAL/FILL-IN button to insert a fill-in pattern for the rhythm you are using.

NOTE

- The fill-in pattern does not play if you press the NORMAL/FILL-IN button while an intro pattern is playing.

Using a Rhythm Variation

In addition to the standard rhythm pattern, you can also switch to a secondary "variation" rhythm pattern for a bit of variety.

To insert the variation rhythm pattern

1. Press the START/STOP button to start rhythm play.
2. Press the VAR/FILL-IN button to switch to the variation pattern for the rhythm you are using.

NOTE

- To switch back to the standard rhythm pattern, press the NORMAL/FILL-IN button.

Using a Fill-in Pattern with a Variation Rhythm

You can also insert a fill-in pattern while a variation rhythm pattern is playing.

To insert a fill-in into a rhythm variation

1. While a variation rhythm pattern is playing, press the VAR/FILL-IN button to insert a fill-in pattern for the variation rhythm you are using.

Synchro Starting Accompaniment with Rhythm Play

You can set up the keyboard to start rhythm play at the same time you play the accompaniment on the keyboard.

The following procedure describes how to use synchro start. Before starting, you should first select the rhythm you want to use, set the tempo, and use the MODE switch to select the chord play method you want to use (NORMAL, CASIO CHORD, FINGERED, FULL RANGE CHORD).

To use synchro start

1. Press the SYNCHRO/ENDING button to put the keyboard into synchro start standby.

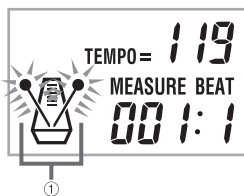

① Flash

2. Play a chord and the rhythm pattern starts to play automatically.

NOTE

- If the MODE switch is set to NORMAL, only the rhythm plays (without a chord) when you play on the accompaniment keyboard.
- If you press the INTRO button before playing anything on the keyboard, the rhythm starts automatically with an intro pattern when you play something on the accompaniment keyboard.
- Pressing the VAR/FILL-IN button before playing anything on the keyboard causes play to start with the variation pattern when something is played on the keyboard.
- To cancel synchro start standby, press the SYNCHRO/ENDING button one more time.

Finishing with an Ending Pattern

You can end your performances with an ending pattern that brings the rhythm pattern you are using to a natural-sounding conclusion.

The following procedure describes how to insert an ending pattern. Note that the actual ending pattern played depends on the rhythm pattern you are using.

To finish with an ending pattern

1. While the rhythm is playing, press the SYNCHRO/ENDING button.
 - This causes the ending pattern to play which brings rhythm accompaniment to an end.
 - The timing when the ending pattern starts depends on when you press the SYNCHRO/ENDING button. If you press the button before the second beat of the current measure, the ending pattern starts playing immediately. Pressing the button at any point in the measure after the second beat results in the ending pattern playing from the beginning of the following measure.



Adjusting the Accompaniment Volume

You can adjust the volume of the accompaniment parts as a value in the range of 000 (minimum) to 127.

1. Press the ACCOMP VOLUME button.



- ① Current accompaniment volume setting

2. Use the number buttons or the [+]/[-] buttons to change the current volume setting value.

Example:

110



NOTE

- The current accompaniment volume value that appears in Step 1 automatically clears from the display if you do not input anything within about five seconds.
- Pressing [+] and [-] buttons at the same time automatically sets an accompaniment volume of 088.

Song Bank

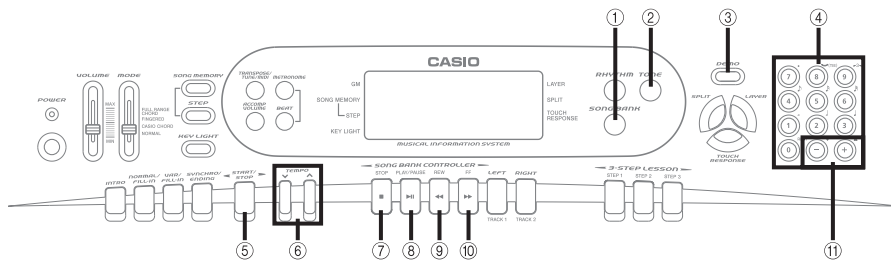

- | | | |
|------------------|--------------|---------|
| ① SONG BANK | ② TONE | ③ DEMO |
| ④ Number buttons | ⑤ START/STOP | ⑥ TEMPO |
| ⑦ STOP | ⑧ PLAY/PAUSE | ⑨ REW |
| ⑩ FF | ⑪ [+]/[-] | |

This keyboard features a built-in Song Bank of 100 tunes that can be used for Auto Accompaniment playback. You can select a song simply to enjoy listening to it, or you can cut out its melody part and play along on the keyboard using the 3-step lesson. Melody and accompaniment fingerings and notes appear on the keyboard's display, and the keys you should press light up on the keyboard to help you on your way to keyboard mastery.

Playing a Tune

To play a tune

1. Select the tune you want to play.
2. Press the PLAY/PAUSE button to start play of the tune.
 - The current measure and beat numbers are shown on the display.

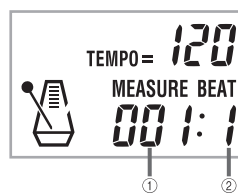

- ① Measure number
- ② Beat number

3. To stop play, press the STOP button.
 - The tune you select continues to play until you stop it.

NOTE

- While a tune is playing, you can use the number buttons or [+] and [-] to change to another tune. The change is made as soon as you input a different number, even if the current tune is not finished playing.

Selecting a Tune

To select a tune

1. Find the tune you want to play in the Song Bank List, and note its number.
2. Press the SONG BANK button.
 - This causes the number and name of the currently selected Song Bank tune to appear on the display.
3. Use the number buttons to input the two-digit tune number.

Example:

To select "16 TWINKLE TWINKLE LITTLE STAR", input 1 and then 6.



NOTE

- You can also change the displayed song number using [+] (increase) and [-] (decrease).



Key Lighting System Operation and Display Contents During Song Bank Play

Keyboard keys light to show the keys that should be pressed to play along with Song Bank tunes as they play back. At the same time, the display shows fingerings, chord names, notes, tempo and other information.

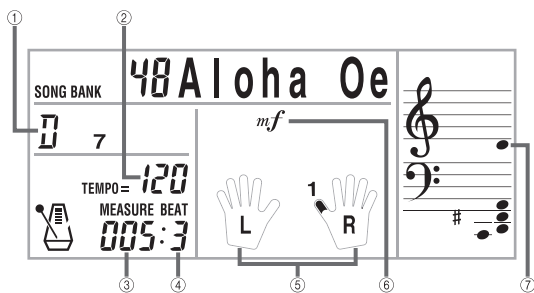

- ① Chord name
- ② Tempo value
- ③ Measure number
- ④ Beat number
- ⑤ Fingering
- ⑥ Dynamic mark
- ⑦ Note pitch

NOTE

- While the tempo value is flashing, you can also use the number buttons or [+] and [-] to input a three-digit value. Note that you must input leading zeros, so 90 is input as 090.
- Pressing both the ▲ and ▼ TEMPO buttons at the same time automatically returns the currently selected tune to its default tempo.
- Tunes 70 to 99 have tempo changes part way through in order to produce specific musical effects. Note that the tempo setting automatically returns to the default whenever a tempo change occurs within one of these tunes.

Pausing Playback

To pause playback

1. Press the PLAY/PAUSE button while a tune is playing to pause it.
2. Pressing the PLAY/PAUSE button again resumes play from the point where it was paused.

NOTE

- After you press the STOP button to stop playback, pressing the PLAY/PAUSE button restarts play from the beginning of the tune.

Adjusting the Tempo

Each tune has a preset default tempo (beats per minute) that is set automatically whenever you select a tune. While the tune is playing, you can change the tempo setting to a value in the range of 40 to 255.

To set the tempo

1. Use the TEMPO buttons to set the tempo.
 - ▲ : Increases the tempo value.
 - ▼ : Decreases the tempo value.

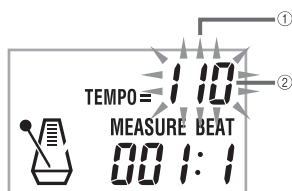

- ① Flash
- ② Tempo value

Fasting Reverse

To fast reverse

1. While a tune is playing or paused, hold down the REW button to skip in a reverse direction at high speed.
 - The fast reverse operation skips back one measure at a time.
 - The measure and beat numbers on the display change while the fast reverse operation is being performed.

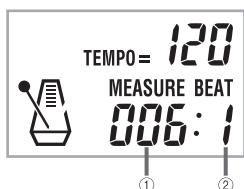

- ① Measure number
- ② Beat number

2. Releasing the REW button starts song playback from the measure whose number is shown on the display.

NOTE

- Fast reverse does not work while Song Bank play is stopped.

Fasting Forward

To fast forward

1. While a tune is playing or paused, hold down the FF button to skip forward at high speed.
 - The fast forward operation skips forward one measure at a time.
 - The measure and beat numbers on the display change while the fast forward operation is being performed.

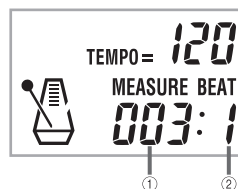

- ① Measure number
- ② Beat number

2. Releasing the FF button starts song playback from the measure whose number is shown on the display.

NOTE

- Fast forward does not work while Song Bank play is stopped.

Changing the Melody Tone

To change the melody tone

1. While a tune is playing or paused, press the TONE button.



- ① Indicates TONE was pressed.

2. Find the tone you want in the Tone List, and then use the number buttons to input its three-digit number.

Example:

To select "040 VIOLIN", input 0, then 4, then 0.

- You can select any one of the keyboard's 137 built-in tones.



NOTE

- You can also use the [+] and [-] buttons to change the melody tones.
- For two-hand tunes (Song Bank tunes 70 through 99), the same tone is applied for both the left and right hand parts.



- Specifying the tune number for the same tune that is currently selected returns the melody tone to the default setting for that tune.

Playing All Song Bank Tunes in Succession

To play all Song Bank tunes in succession

1. Press the DEMO button.
 - Song Bank tune play starts from tune number 00, and continues with each tune in numeric sequence.
2. To stop Song Bank tune play, press the DEMO, STOP, or START/STOP button.

NOTE

- While a tune is playing, you can use the number buttons or [+] and [-] to change to another tune.
- You can play along with the tunes on the keyboard.

Free Manuals Download Website

<http://myh66.com>

<http://usermanuals.us>

<http://www.somanuals.com>

<http://www.4manuals.cc>

<http://www.manual-lib.com>

<http://www.404manual.com>

<http://www.luxmanual.com>

<http://aubethermostatmanual.com>

Golf course search by state

<http://golfingnear.com>

Email search by domain

<http://emailbydomain.com>

Auto manuals search

<http://auto.somanuals.com>

TV manuals search

<http://tv.somanuals.com>