

DATA PROJECTOR

XJ-A146/XJ-A246/XJ-A256

Data Projector USB Function Guide

- Be sure to read the precautions in the separate Setup Guide.
- Be sure to keep all user documentation handy for future reference.

- Microsoft, Windows, Windows Vista and PowerPoint are registered trademarks or trademarks of Microsoft Corporation in the United States and other countries.
- ArcSoft and the ArcSoft logo are trademarks or registered trademarks of ArcSoft, Inc. in the United States and other countries.
- Macintosh, Mac OS and QuickTime are trademarks or registered trademarks of Apple, Inc. in the United States and other countries.
- Other company and product names may be registered product names or trademarks of their respective owners.

- The contents of this manual are subject to change without notice.
- Copying of this manual, either in part or its entirety, is forbidden. You are allowed to use this manual for your own personal use. Any other use is forbidden without the permission of CASIO COMPUTER CO., LTD.
- CASIO COMPUTER CO., LTD. shall not be held liable for any lost profits or claims from third parties arising out of the use of this product, the included software or this manual.
- CASIO COMPUTER CO., LTD. shall not be held liable for any loss or lost profits due to loss of data due to malfunction or maintenance of this product, or any other reason.
- The sample screens shown in this manual are for illustrative purposes only, and may differ somewhat from the screens actually produced by the product.

Contents

About this manual.....	4
Terms and Conventions.....	4
About the Data Projector's USB Functions	5
Connecting a USB Device to the Data Projector	7
Installing the Software.....	8
Minimum System Requirements.....	8
To install EZ-Converter FA.....	9
To install ArcSoft MediaConverter 3 for CASIO Projector	10
Installing Multi Projection Camera Update Software.....	11
Projecting the Contents of Files on a Memory Device.....	12
Using EZ-Converter FA to Convert PowerPoint Files to ECA or PtG Files.....	12
Starting Up and Exiting EZ-Converter FA.....	13
Converting a PowerPoint File to an ECA File or PtG File	14
Using ArcSoft MediaConverter 3 for CASIO Projector.....	17
Using Viewer to Project the Contents of a File on a Memory Device	19
Connecting a Memory Device to the Data Projector	19
Starting Projection with Viewer.....	21
Projecting an ECA File or PtG File	23
Projecting an Image File	26
Projecting a Slideshow	27
Projecting a Movie File.....	28
File Menu Operations.....	31
Configuring Viewer Settings	34
Autorun.....	37
Viewer Troubleshooting.....	38
Memory Devices	38
File Display and Playback.....	39
Viewer Error Messages.....	40

**Performing a Presentation Using the
YC-400/YC-430 Document Camera..... 41**

YC Camera Application Function and Operation Overview41

Connecting the Document Camera to the Data Projector..... 41

YC Camera Application Operations44

YC Camera Application Projection Operations 44

Configuring YC Camera Application Setup Menu Settings 48

**Projecting the Screen Image of a
Graphing Calculator..... 52**

To project the screen image of a graphing calculator 52

About this manual...

This manual explains function and operations when any one of the following devices is connected to the USB port of the CASIO Data Projector.

- USB memory device
- CASIO Multi Projection Camera (YC-400/YC-430)
- CASIO Graphing Calculator



Note

- Use of a memory device (page 5) requires separate purchase of commercially available USB memory or other memory.
- Use of a CASIO Multi Projection Camera or graphic scientific calculator requires separate purchase of the required device by you. Note that these products may not be available in some geographic areas. For full details, contact the retailer where you purchased this Data Projector or authorized CASIO dealer.

Terms and Conventions

In this manual, there are many procedures that require parallel operations on the Data Projector and your computer. The following are special terms and conventions used in this manual to differentiate between the Data Projector and computer.

- **Projection area**

This is the entire rectangular area that is projected by the Data Projector. Certain Data Projector operations will cause messages and menus to appear within the projection area.

- **Computer screen**

This is the physical display device of your computer.

About the Data Projector's USB Functions

The USB port built into the Data Projector lets you connect an external USB device and use it as an input source for image projection.

USB Memory Device or Memory Card

After you connect a memory device to the Data Projector's USB port, you can playback (project) the following types of files.

- ECA files (special projector presentation files)
The EZ-Converter FA software that comes with the Data Projector can be used to convert PowerPoint files to ECA (.ECA) files for playback.
Note that unconverted PowerPoint files cannot be played back.
- PtG file (MobiShow presentation file)
PtG is a presentation file format that is compatible with AWIND's MobiShow. Your Data Projector supports playback of PtG files, only if they have been converted using EZ-Converter FA software.
- Image files
Playback is supported for JPEG (jpg, jpeg, jpe; excluding progressive format) format or BMP (bmp) format image files up to about 8 MB in size.
- Movie files
Playback is supported for the following types of movie files, up to a maximum file size of approximately 4GB.
 - Motion JPEG format (.avi)
 - Resolution: 1280 × 720, 640 × 480, 320 × 240
 - Maximum Data rate: 15 Mbps
 - Maximum frame rate: 24 fps for 1280 × 720, 30fps for 640 × 480 and 320 × 240
- Audio Format: ADPCM

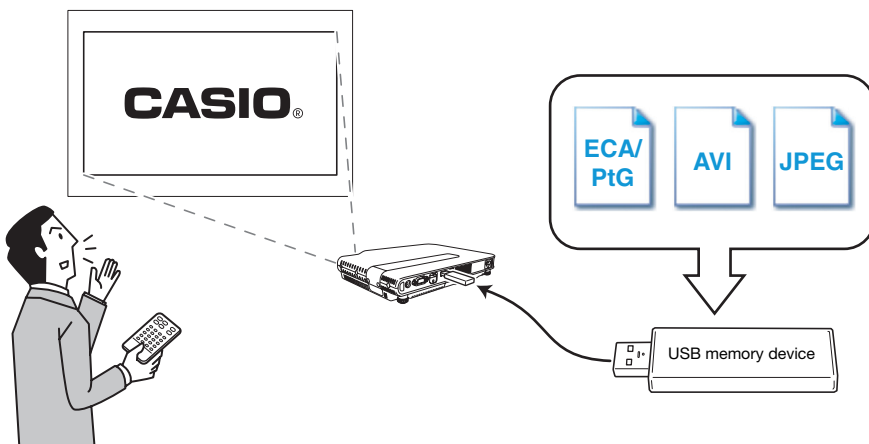

Refer to the following for details.

For more information about this:	Refer to this section of this manual:
Converting PowerPoint files to files that can be played back with the Data Projector	"Using EZ-Converter FA to Convert PowerPoint Files to ECA or PtG Files" (page 12)
Memory devices that can be connected to the Data Projector's USB port	"Connecting a Memory Device to the Data Projector" (page 19)
Operations for projecting the contents of files on a memory device	"Using Viewer to Project the Contents of a File on a Memory Device" (page 19)

Document Camera (CASIO YC-400/YC-430)

You can connect a CASIO Document Camera to the Data Projector's USB port and project the images of documents placed on the document stage of the YC-400/YC-430.

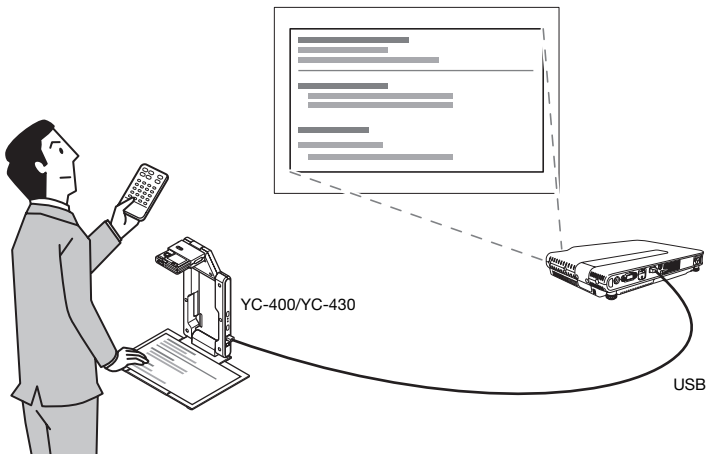

For more information, see “Performing a Presentation Using the YC-400/YC-430 Document Camera” on page 41.

Graphing Calculator

You can connect a CASIO graphing calculator to the Data Projector's USB port and project calculator screen images with the projector.

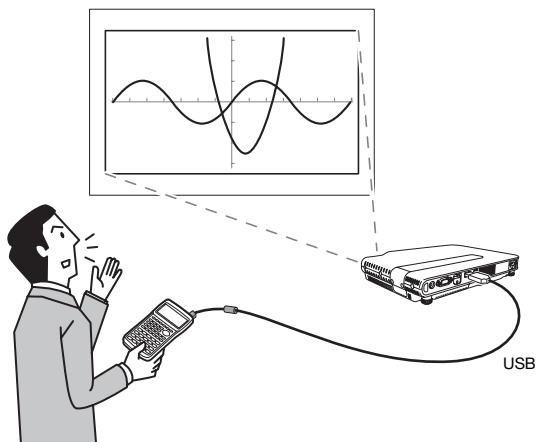

For details, see “Projecting the Screen Image of a Graphing Calculator” (page 52).

Connecting a USB Device to the Data Projector

What happens when you connect a USB device while the Data Projector is turned on depends on the current configuration of the Data Projector's plug-and-play setting. Plug-and-play is enabled under the Data Projector's initial default settings. For more details about the plug-and-play setting, see "Setup Menu Contents" in the User's Guide.

If you connect a USB device to the Data Projector's USB port while it is turned on, it will perform one of the following operations (depending on its current plug-and-play setting).

When plug-and-play is enabled:

When this type of device is connected:	The Data Projector does this automatically:
USB memory device or USB card reader with memory card loaded	Starts up Viewer (page 19) and projects the Viewer screen.
YC-400/YC-430 Document Camera	Starts up the YC Camera application (page 41) when the Document Camera is turned on and projects the YC Camera application screen.

When plug-and-play is disabled:

In this case, the image that is currently being projected does not change. However, Viewer, or the YC Camera Application will start up in the background, depending upon the type of USB device that is connected to the Data Projector.

Installing the Software

The following USB expansion function software is included on the CD-ROM that comes with the projector.

Software Name	Description
EZ-Converter FA	Software for converting a PowerPoint file to an ECA file or PtG file that can be played back on the projector.
ArcSoft MediaConverter 3 for CASIO Projector	Software for converting movie files.
Multi Projection Camera Update Software	Software for updating the firmware of the YC-400 Multi Projection Camera.



Important!

The latest version of the computer software included on the CD-ROM that comes with this product is available for download at the CASIO website URL below:

<http://www.casio.com/support/driverdownloads/>

Be sure to download and use the latest version of the software.

[Home – Support – Drivers/Downloads – Projectors]

Minimum System Requirements

- Operating System: Microsoft® Windows® 7, Windows Vista® SP2, or Windows® XP SP3
- Computer : IBM PC/AT or compatible that conforms to the following conditions
 - Windows® 7, Windows Vista®, or Windows® XP pre-installed
 - PowerPoint 2003, 2007 or 2010 installed (to use EZ-Converter FA)
 - **CPU:** Pentium® M 1.6GHz or higher; CPU recommended for your computer's operating system
 - **Memory:** The amount of memory recommended for operating system being run
 - **Display:** Full-color display with resolution of at least 1024 × 768 that is supported by above operating systems and the computer being used.
 - **Input Device:** Keyboard or other pointing device (mouse supported by the above operating system or equivalent device)
- Any other requirements as recommended by the operating system you are using.
- Normal operation may not be possible under certain hardware configurations.
- Operation is not supported on a computer running Windows® 2000, NT, Me, 98SE, 98, 95, or 3.1, or on a Macintosh or Mac OS computer.
- Operation on a computer upgraded to Windows® 7, Windows Vista®, or Windows® XP from another operating system is not supported.
- Operation on a computer running Windows® XP Professional x64 Edition is not supported.

To install EZ-Converter FA

- 1. Place the CD-ROM that comes with the projector into your computer's CD-ROM drive.**
 - This will automatically display the CD-ROM menu screen.
- 2. On the menu screen, click the [Install] button to the right of "EZ-Converter FA".**
 - Follow the instructions on the dialog boxes that appear on the screen.
 - If you are running Windows 7 and the "User Account Control" message appears while installing, click [Yes].
 - If you are running Windows Vista and the "User Account Control" message appears while installing, click [Allow].
 - If you are running Windows XP and the message shown below appears while installing, click [Continue Anyway].



To install ArcSoft MediaConverter 3 for CASIO Projector

1. Place the CD-ROM that comes with the projector into your computer's CD-ROM drive.
 - This will automatically display the CD-ROM menu screen.
2. On the menu screen, click the [Install] button to the right of "ArcSoft MediaConverter 3 for CASIO Projector".
 - Follow the instructions on the dialog boxes that appear on the screen.
 - If you are running Windows 7 and the "User Account Control" message appears while installing, click [Yes].
 - If you are running Windows Vista and the "User Account Control" message appears while installing, click [Continue].
 - If you are running Windows XP and the message shown below appears while installing, click [Continue Anyway].



Installing Multi Projection Camera Update Software

A YC-400 Multi Projection Camera can be connected to the Data Projector only if it is running firmware version 1.1 or higher. For information about how to check the firmware version of a camera, see the file named “YC-Update_Guide_English.pdf” in the “English” folder inside the “User’s Guide” folder on the CD-ROM that comes with the projector.

To install Multi Projection Camera Update Software

- 1. Place the CD-ROM that comes with the projector into your computer’s CD-ROM drive.**
 - This will automatically display the CD-ROM menu screen.
- 2. On the menu screen, click the [Open Folder] button to the right of “Multi Projection Camera Update Software”.**
 - This will open the folder on the CD-ROM that contains the file named “YC-400.exe”.
- 3. Double-click “YC-400.exe”.**
 - Follow the instructions that appear on your computer screen.



Note

Completing the above steps will create a file named “YC-400.bin” in the folder you specify. For information about how to use the file to update the firmware version of a camera, see the file named “YC-Update_Guide_English.pdf” in the “English” folder inside the “User’s Guide” folder on the CD-ROM that comes with the projector.

Projecting the Contents of Files on a Memory Device

This section explains how to perform the following operations.

- How to use EZ-Converter FA computer software to convert PowerPoint files to files that can be played back with the Data Projector's Viewer function.
- How to use ArcSoft MediaConverter 3 for CASIO Projector computer software to convert movie files to files that can be played back with the Data Projector's Viewer function.
- How to project the contents of files stored on a memory device with the Data Projector's Viewer function.

Viewer is one of the Data Projector's built-in applications. It lets you play back and project the contents of files from a memory device connected to the Data Projector.

Using EZ-Converter FA to Convert PowerPoint Files to ECA or PtG Files

EZ-Converter FA is computer software for converting PowerPoint files to ECA or PtG files that can be played back and projected by the Data Projector. EZ-Converter FA supports conversion of file created with Microsoft Office PowerPoint 2003, 2007 and 2010. Save for certain exceptions (described below), playback and projection of an ECA file or PtG file normally should be able to reproduce transitions, animations, and other special effects of the original PowerPoint file.

- Conversion of OLE objects (movies, audio, etc.) and VBA objects in a PowerPoint file is not supported.
- Conversion of timer and repeat operations in a PowerPoint file animation is not supported.
- An animation in a PowerPoint file is converted up to the time specified by "Max Animation Display Time" (page 16), and everything after that is cut. When the point up to which the animation was converted is reached during playback of the converted file, playback will pause, and you will have to press the [ENTER] key to advance to the next step.
- The source PowerPoint file plays when you convert a file with EZ-Converter FA. If there is no change on the screen for about three consecutive seconds during this playback, say between Points A and B, for example, the effect at Point B in the original file is ignored and not converted. When Point B is reached during playback of the converted file, playback will pause, and you will have to press the [ENTER] key to advance to the next step.



Important!

In order to perform the procedures in this section, you will first need to install the EZ-Converter FA software from the CD-ROM that comes with the Data Projector onto your computer. For more information, see "Installing the Software" (page 8).

Starting Up and Exiting EZ-Converter FA

To start up EZ-Converter FA

Perform either of the following operations to start up EZ-Converter FA on the computer.

- Double-click the  icon on your Windows desktop.
- On your computer's Windows Start menu, select [All Programs] - [CASIO] - [EZ-Converter FA].



Important!

If your computer is running Windows Vista or Windows 7, starting up EZ-Converter FA may cause the "User Account Control" message to appear. If it does, click [Allow] or [Yes].

EZ-Converter FA Window

The following shows the window that appears while EZ-Converter FA is running.

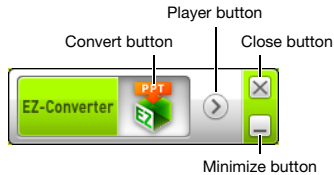

To display EZ-Converter FA help

Right-click the left side of the window and then select "Help" on the menu that appears.

To display EZ-Converter FA version information

Right-click the left side of the window and then select "About" on the menu that appears.

To close EZ-Converter FA

Click the close button in the upper right corner of the EZ-Converter FA window.

Converting a PowerPoint File to an ECA File or PtG File



Important!

- Before performing any of the operations here, you will need to have a file created using Microsoft Office PowerPoint 2003, 2007 or 2010 on hand.
- Conversion of a PowerPoint file to an ECA file or PtG file requires playback of the original file from beginning to end. Note that the time required for conversion will roughly correspond to the time required for playback.



Note

- Starting a conversion operation with EZ-Converter FA will temporarily change the screen settings of your computer as shown below. Screen settings will revert back to what they were after the conversion operation is complete.

Operating System:	Changes:
Windows XP	<ul style="list-style-type: none">● Screen resolution changes to 800 × 600, 1024 × 768, 1280 × 768 or 1280 × 800.● Display card hardware acceleration is disabled.
Windows Vista or Windows 7	<ul style="list-style-type: none">● Screen resolution changes to 800 × 600, 1024 × 768, 1280 × 768 or 1280 × 800.● Windows changes to the Basic mode (Windows Aero™ disabled).

- The screen resolution of the ECA file or PtG file will be the resolution specified by the EZ-Converter FA setting (800 × 600, 1024 × 768, 1280 × 768 or 1280 × 800) when the file conversion operation starts. For information about configuring this setting, see “To specify the screen resolution of the ECA file or PtG file” (page 16).

To convert a PowerPoint file to an ECA file or PtG file

1. Turn on your computer and start up Windows.

2. Connect the USB memory (or memory card) where you want to store the converted ECA file or PtG file to your computer.

- You can skip this step if you want to save the ECA file or PtG file to your computer’s local hard disk.

3. On your computer, start up EZ-Converter FA.

- If your computer is running Windows Vista or Windows 7, starting up EZ-Converter FA will cause the “User Account Control” message to appear. When it does, click [Allow] or [Yes].
- This will display the EZ-Converter FA window.



4. Configure the following settings as required.

- Specify the ECA file or PtG file screen display resolution. See “To specify the screen resolution of the ECA file or PtG file” (page 16).
- If the original file contains an animation, specify the maximum animation display time. See “To specify the maximum animation display time” (page 16).

5. Click the button at the top of the EZ-Converter FA window.

- This displays a dialog box for opening files.

6. Select the PowerPoint file you want to convert from and then click the [Open] button.

- This will display a dialog box like the one shown below for specifying the file settings.

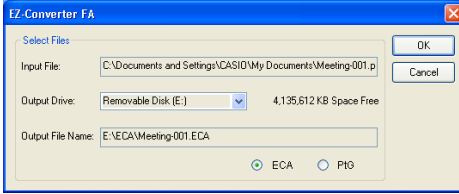

7. Configure the settings as required on the dialog box.

- The following describes the meanings and settings of each of the items that appear on the dialog box.

Dialog Box Item	Description
Input File	Shows the name of the PowerPoint file selected in step 6. The setting of this item cannot be changed.
Output Drive	Shows the drive name of the removable disk (USB memory or memory card) connected to the computer in step 2. When you have multiple removable disks connected to your computer, you can click the [▼] button and select the name of the drive where you want to save the converted file. A converted file is stored in the folder named ECA (in the case of an ECA file) or PtG (in the case of a PtG file) on the drive you specify here. Under initial default settings, if there are no removable disks connected to the computer, the resulting file will be saved in the same location (drive and folder) as the original PowerPoint file. Click the [Browse] button and change the save destination, if you want.
Output File Name	Shows the file name of the converted file, along with the path from the drive name. Except for the extension, the file name is the same as the PowerPoint file name. The setting of this item cannot be changed.
ECA/PtG	Specifies the format of the converted file (Default: ECA). For details about ECA and PtG files, see “About the Data Projector’s USB Functions” (page 5) of this manual.

8. After configuring all the settings you want, click [OK].

- This will start playback of the PowerPoint file and start converting it to an ECA file or PtG file.
- The “Conversion complete.” message will appear when file conversion is complete.
- If you have other PowerPoint files you want to convert, repeat steps 4 through 7.
- To check the contents of an ECA file or PtG file, perform the procedure under “To play back an ECA file or PtG file on your computer” (page 16).

9. After you are finished converting all the files you want, click the close button in the upper right corner of the EZ-Converter FA window.

To specify the screen resolution of the ECA file or PtG file

1. Right-click the left side of the EZ-Converter FA window.
2. On the menu that appears, click “Output Resolution”.
3. On the sub-menu that appears, select the resolution you want.
 - The following shows the resolution settings that should be used for each Data Projector model.

Model	Resolution
XJ-A146	1024 × 768, 800 × 600*1
XJ-A246/XJ-A256	1280 × 800, 1280 × 768, 1024 × 768*2

*1 If you cannot select the 1024 × 768 resolution, select 800 × 600.

*2 If you cannot select the 1280 × 800 or 1280 × 768 resolution, select 1024 × 768.

- For a PtG file, select 1024 × 768 or 800 × 600.
- The setting you select here remains in effect until you change it.

To specify the maximum animation display time

1. Right-click the left side of the EZ-Converter FA window.
2. On the menu that appears, click “Max Animation Display Time”.
3. On the sub-menu that appears, select a maximum animation display time value (in seconds).
 - Available sub-menu options are 10 seconds, 20 seconds, 30 seconds, and 60 seconds.
 - The option you select remains in effect until you change it.

To play back an ECA file or PtG file on your computer

1. On your computer, start up EZ-Converter FA.
 - This will display the EZ-Converter FA window.



2. Click the  button at the top of the EZ-Converter FA window.
 - This will display two more buttons as shown below.



3. Click the  button.
 - This displays a dialog box for opening files.

4. Select the ECA file or PtG file you want to play back and then click the [Open] button.

- This will display a control panel at the top of the screen.

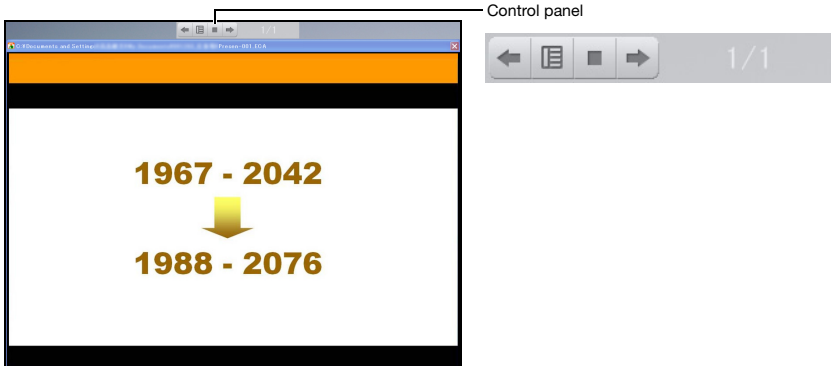

- During file playback, you can use the control panel buttons to perform the operations described below.

To do this:	Perform this operation:
Go to the previous page	Click the ◀ button.
Go to the next page	Click the ▶ button.
Jump to a specific page	1. Click the [List] button and then click "Slide Viewer" on the menu that appears. 2. On the page menu that appears, click the thumbnail of the destination page and then click [OK].
Display help	Click the [List] button and then click "Help" on the menu that appears.
Exit file playback	Click the [Square] button, or click the [List] button and then click "Exit" on the menu that appears. You could also press the [ESC] button on your computer keyboard to stop playback.

Using ArcSoft MediaConverter 3 for CASIO Projector

ArcSoft MediaConverter 3 for CASIO Projector is computer software that converts an MP4, MOV*, AVI, or WMV format file to a Motion JPEG format AVI file that can be played by the projector's Viewer function. For details about file formats, see page 5.

* QuickTime Player 7 or greater is required to convert from a MOV file.



Important!

In order to perform the procedures in this section, you will first need to install ArcSoft MediaConverter 3 for CASIO Projector from the CD-ROM that comes with the Data Projector onto your computer. For more information, see "Installing the Software" (page 8).

To convert a movie file to a format that can be played by Viewer

1. Double-click the icon on your computer desktop.

- This starts up ArcSoft MediaConverter 3 for CASIO Projector and displays a window like the one shown below.

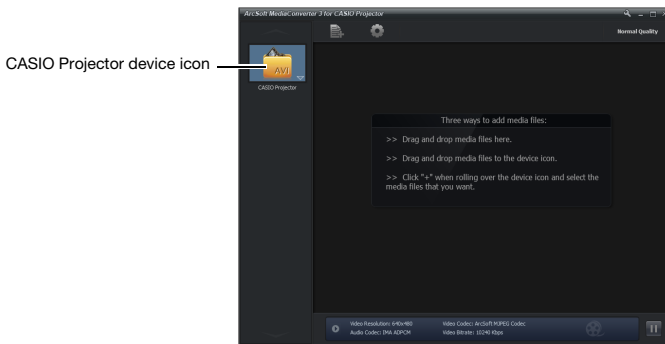

2. Drop the original movie file into the ArcSoft MediaConverter 3 for CASIO Projector window or onto the CASIO Projector device icon.

- This will start the conversion, and display a progress bar like the one shown below in the window. The progress bar will disappear automatically after conversion is complete.

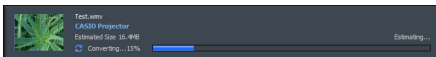

- You can open the folder where the converted file is stored by clicking “Local disk” at the bottom of the window.

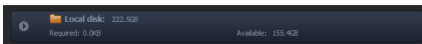

If you don't see “Local disk” at the bottom of the window, click  to display it.

3. Repeat steps 1 and 2 as many times as necessary to convert all of the movie files you want.

- Selecting and dragging multiple files is also supported in the above operation.

4. After you are finished, click the button in the upper right corner of the ArcSoft MediaConverter 3 for CASIO Projector window to exit.



Note

- For details about the settings and operations of ArcSoft MediaConverter 3 for CASIO Projector, see help. To display help, click the  button in the upper right corner of the ArcSoft MediaConverter 3 for CASIO Projector window. On the menu that appears, click “Help”.
- For details about the operation to play back a converted movie file with the projector's Viewer function, see “Projecting a Movie File” (page 28).

Using Viewer to Project the Contents of a File on a Memory Device

Use the Data Projector's Viewer application to project the contents of a file on a memory device. Viewer starts up automatically whenever you connect a memory device that is supported by the Data Projector into the Data Projector's USB port.

Connecting a Memory Device to the Data Projector

The Data Projector's USB port supports connection of a FAT/FAT32 format memory device supported by the USB interface. The following are supported memory devices.

- USB memory
- Memory cards
A commercially available USB card reader is required to connect a memory card to the Data Projector.
- USB storage class (USB Mass Storage Class) compatible digital cameras



Important!

The Data Projector does not support connection of all commercially available USB memory devices, memory cards, and digital cameras. For details about specific supported memory devices, contact your original retailer or your nearest authorized CASIO dealer.

To connect USB memory to the Data Projector

Connect USB memory to the Data Projector's USB port as shown below.

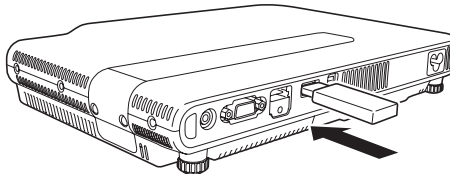

To connect a memory card to the Data Projector

- 1. Load the memory card into a USB card reader's card slot.**
 - For details about how to load a memory card into the USB card reader, see the user documentation that comes with the reader.
- 2. Connect the USB card reader to the Data Projector's USB port.**

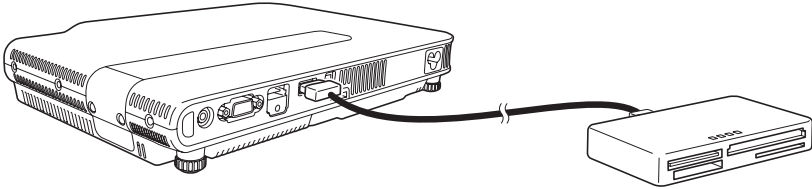

To connect a digital camera to the Data Projector

- 1. If necessary, configure the digital camera's USB mass storage class setting.**
- 2. Turn off the digital camera and connect a USB cable to it.**
- 3. Connect the other end of the USB cable (Type A connector) to the Data Projector's USB port.**
- 4. Turn on the digital camera.**



Note

For details about steps 1, 2, and 4, see the user documentation that comes with your digital camera.

Starting Projection with Viewer

If the Data Projector is already turned on when you perform the procedure under “Connecting a Memory Device to the Data Projector” (page 19) to connect USB memory to the Data Projector, the main Viewer window shown below will be projected.



Menu Item	Function	Refer to:
Presentation	Enters the Presentation Mode for projection of ECA or PtG files.	“Projecting an ECA File or PtG File” (page 23) “Converting a PowerPoint File to an ECA File or PtG File” (page 14)
Slides	Enters the Slide Mode for projection of images files.	“Projecting an Image File” (page 26)
Movie	Enters the Movie Mode for projection of movie files.	“Projecting a Movie File” (page 28)
Viewer Setup	Displays the Viewer setup menu.	“Configuring Viewer Settings” (page 34)



Note

If Viewer projection does not start automatically at this time, perform the following steps to select “USB” as the input source.

- 1. Press the [INPUT] key.**
 - This displays the input source selection screen.
- 2. Use the [▲] and [▼] keys to move the highlighting to “USB” and then press the [ENTER] key.**

Drive Menu

Entering the Presentation Mode, Slide Mode, or Movie Mode while there are multiple memory devices connected to the Data Projector (multiple USB memory devices connected via a USB hub, multiple memory cards loaded in the memory card reader connected to the Data Projector, etc.) will cause a menu like the one shown below to appear on the projection screen.



When this happens, use the cursor keys to move the highlighting to the drive you want to use and then press the [ENTER] key. This will display a menu of files for the mode you are entering.



Note

The Data Projector can recognize up to four drives.

Projecting an ECA File or PtG File

Use the Viewer Presentation Mode to project ECA or PtG files.

To project an ECA file or PtG file

1. Connect the memory device where the ECA file or PtG file you want to project is stored to the Data Projector.

- This will project the main Viewer window. If the main Viewer window does not appear, press the [INPUT] key and select “USB” as the input source.

2. Use the cursor keys to move the highlighting to “Presentation” and then press the [ENTER] key.

- This will project a file menu like the one shown below.

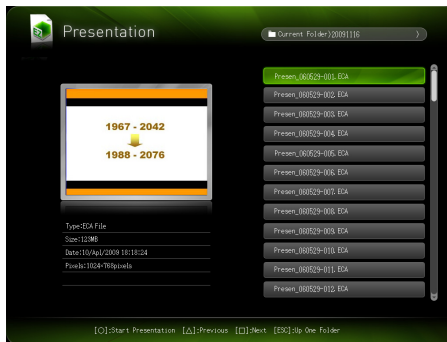

- If the ECA file or PtG file you want to play back is located in a particular folder, use the cursor keys to move the highlighting to that folder and then press the [ENTER] key.

3. Use the cursor keys to move the highlighting to the ECA file or PtG file you want to play back and then press the [ENTER] key (or the [O] key).

- This will start playback of the selected ECA file or PtG file.

4. Perform page change and other operations as required.

- For details about operations you can perform during projection of an ECA file or PtG file, see “Operations during ECA File or PtG File Projection” (page 24).
- To stop ECA file or PtG file playback and return to the file menu, press the [ESC] key.

Operations during ECA File or PtG File Projection

The operations described below can be performed while an ECA file or PtG file is playing.

To do this:	Perform this operation:
Go to the previous page	Press the [◀] key.
Go to the next page	Press the [▶] key.
Pause ECA file or PtG file playback	<ol style="list-style-type: none">1. Press the [FUNC] key.2. On the function menu that appears, use the cursor keys to move the highlighting to "Pause" and then press the [ENTER] key.
Jump to a specific page	<ol style="list-style-type: none">1. Press the [○] key to display a page menu.2. Use the cursor keys to move the highlighting to the thumbnail of the page where you want to start playback of the presentation and then press the [ENTER] key. <ul style="list-style-type: none">● For information about the other operations you can perform while the page menu is displayed, see "Page Menu Operations" (page 25).
Stop playback and return to the file menu	Press the [ESC] key.

The operations described below can be performed while ECA file or PtG file playback is paused.

To do this:	Perform this operation:
Resume ECA file or PtG file playback from where it was paused	Press the [ENTER] key.

Page Menu Operations

Pressing the [O] key while an ECA file or PtG file is being played will project a page menu like the one shown below.



The operations described below can be performed while the page menu is being projected.

To do this:	Perform this operation:
Re-start file playback from a particular page	Use the cursor keys to move the highlighting to the thumbnail of the page where you want to start playback of the presentation and then press the [ENTER] key.
Scroll to the next screen	Press the [□] key.
Scroll to the previous screen	Press the [Δ] key.
Stop playback and return to the file menu	Press the [ESC] key.

Projecting an Image File

Use the Viewer Slide Mode to project image files. You can also group image files and project them in a specific sequence as a slideshow.

To project an image file

1. Connect the memory device where the image file you want to project is stored to the Data Projector.

- This will project the main Viewer window. If the main Viewer window does not appear, press the [INPUT] key and select “USB” as the input source.

2. Use the cursor keys to move the highlighting to “Slides” and then press the [ENTER] key.

- This will project a file menu like the one shown below.

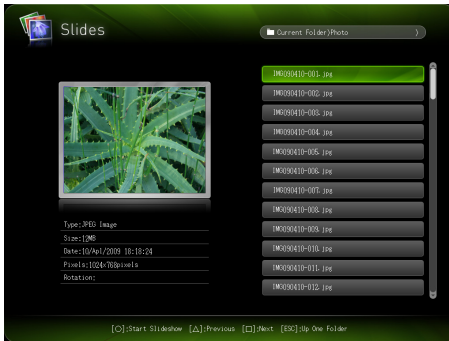

- If the image file you want to project is located in a particular folder, use the cursor keys to move the highlighting to that folder and then press the [ENTER] key.

3. Use the cursor keys to move the highlighting to the image file you want to project and then press the [ENTER] key.

- This will project the selected image file.

4. Perform the operations described below as required.

To do this:	Press this key:
Scroll back to the previous image	[◀]
Scroll forward to the next image	[▶]
Rotate the image right 90 degrees	[△]
Rotate the image left 90 degrees	[◻]
Start a slideshow from the image file	[○]

5. To stop image projection and return to the file menu, press the [ESC] key.

Projecting a Slideshow

The Data Projector's Slide Mode lets you group multiple image files and project them in sequence as a slideshow. You can select either manual playback or auto playback for slideshow image display. The initial default setting is manual playback.

To prepare image files for slideshow play

Note the following points when preparing your slideshow on your computer.

- All of the image files in the slideshow must be in the same folder.
- Images will appear during a slideshow in the file name sequence the image files are arranged in the folder. To display images in a specific sequence, adjust their file names so they are listed in the folder in the sequence you want.
- Copy the folder with the slideshow images to a memory device.

To project image files as a slideshow

- 1. Connect the memory device where the image files of the slideshow are stored to the Data Projector.**
 - This will project the main Viewer window. If the main Viewer window does not appear, press the [INPUT] key and select "USB" as the input source.
- 2. Select either manual or auto scroll, and configure other slideshow settings.**
 - For more information, see "Configuring Viewer Settings" (page 34).
- 3. Use the cursor keys to move the highlighting to "Slides" and then press the [ENTER] key.**
 - This will project a file menu.
- 4. Use the cursor keys to move the highlighting to the folder that contains the image files that make up your slideshow and then press the [ENTER] key.**
- 5. Use the cursor keys to move the highlighting to the image file you want to start the slideshow from and then press the [O] key.**
 - This will project the selected image file and start the slideshow.

6. Perform the operations described below as required.

To do this:	Perform this operation:
Scroll back to the previous image	Press the [◀] key.
Scroll forward to the next image	Press the [▶] key.
Pause the slideshow (This option is available only when "Auto" is specified for the "Image Switching" setting on the setup menu.)	1. Press the [FUNC] key. 2. On the function menu that appears, use the cursor keys to move the highlighting to "Pause" and then press the [ENTER] key.
Rotate the image right 90 degrees	Press the [△] key.
Rotate the image left 90 degrees	Press the [□] key.

- The following operations can be performed while a slideshow is paused.

To do this:	Press this key:
Scroll back to the previous image	[◀]
Scroll forward to the next image	[▶]
Rotate the image right 90 degrees	[△]
Rotate the image left 90 degrees	[□]
Resume the slideshow	[○]

7. To return to the file menu after the slideshow is complete, press the [ESC] key.

Projecting a Movie File

Use the Viewer Movie Mode to project movie files.



Note

- Viewer supports playback of Motion JPEG format AVI movie files (see page 5 for details). Playback of other format movie files is not supported.
- The CD-ROM that comes with the Data Projector contains software (ArcSoft MediaConverter 3 for CASIO Projector) for converting some movie file formats to the format supported by the projector. For information about installing the software, see "Installing the Software" (page 8). For information about movie file formats that can be converted and about the conversion process, see "Using ArcSoft MediaConverter 3 for CASIO Projector" (page 17).

To project a movie file

- 1. Connect the memory device where the movie file you want to project is stored to the Data Projector.**
 - This will project the main Viewer window. If the main Viewer window does not appear, press the [INPUT] key and select “USB” as the input source.
- 2. Use the cursor keys to move the highlighting to “Movie” and then press the [ENTER] key.**

- This will project a file menu like the one shown below.

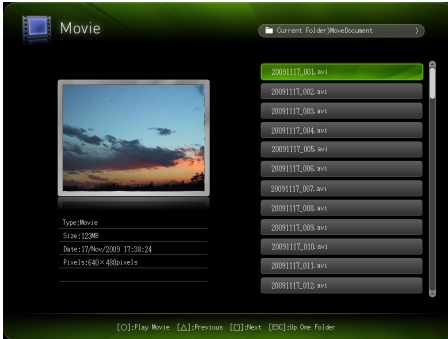

- If the movie file you want to play back is located in a particular folder, use the cursor keys to move the highlighting to that folder and then press the [ENTER] key.
- 3. Use the cursor keys to move the highlighting to the movie file you want to play back and then press the [ENTER] key (or the [O] key).**
 - This will start playback of the selected movie file.
 - 4. Perform pause and other operations as required.**
 - For details about operations you can perform during projection of a movie file, see “Operations during Movie File Projection” (page 30).
 - To stop movie file playback and return to the file menu, press the [ESC] key.
 - When playback reaches the end of the movie file, the projection image will show a still image of the final movie frame.
 - 5. To return to the file menu after movie playback is complete, press the [ESC] key.**

Operations during Movie File Projection

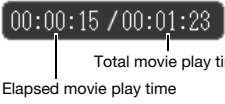

The operations described below can be performed while a movie file is playing or paused.







To do this:	Perform this operation:
Pause and resume movie playback	Press the [ENTER] key. <ul style="list-style-type: none"> A pause icon () is displayed in the upper left corner of the projection screen while movie projection is paused.
Re-play the file from the beginning	1. Press the [FUNC] key. 2. On the function menu that appears, use the cursor keys to move the highlighting to "Play from Beginning" and then press the [ENTER] key.
Display the play time in the upper left corner of the projection screen 	Press the [O] key. <ul style="list-style-type: none"> Each press of the [O] key toggles the time indicator between show and hide.
Fast forward*	Press the [▶▶] key.
Fast reverse*	Press the [◀◀] key.
Stop movie file playback and return to the file menu	Press the [ESC] key.

* For details about fast forward and fast reverse, see "To perform fast forward and fast reverse during movie playback", below.

To perform fast forward and fast reverse during movie playback

1. Perform steps 1 through 3 under "To project a movie file" (page 29) to start playback of the movie file.
2. Press the [▶▶] key for fast forward or the [◀◀] key for fast reverse.

- This starts the corresponding operation and displays an icon ( for fast forward,  for fast reverse) in the upper left corner of the projection screen.
- Each press of the [▶▶] or [◀◀] key cycles the corresponding operation between three speeds.

This icon:	Indicates this:
	Fast forward (10-second increment)
	6X fast forward (60-second increment)
	60X fast forward (10-minute increment)
	Fast reverse (10-second increment)
	6X fast reverse (60-second increment)
	60X fast reverse (10-minute increment)

- Movie playback stops automatically when a fast forward or fast reverse operation reaches the last or the first frame of the movie file.

3. Perform the operations described below as required.

To do this:	Press this key:
Quit a fast forward or fast reverse operation and resume normal playback	[ENTER]
Stop playback and return to the file menu	[ESC]

File Menu Operations

This section explains operations you can perform while the file list is displayed in the Presentation, Slide, or Movie Mode.

List View and Icon View

There are two different views for the Viewer file menu: a list view and an icon view.

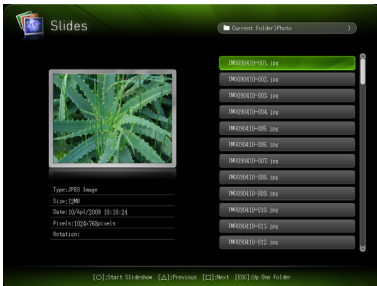

List view

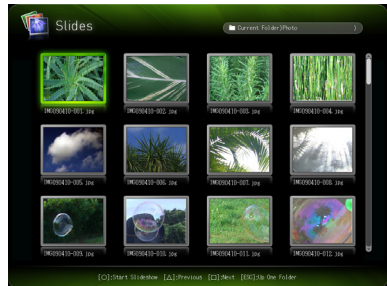

Icon view

List view:

This view lists the names of the folders and files on a memory device. This is the initial default view for the Presentation, Slide, or Movie Mode.

Icon view:

This view shows both icons and names for the folders and files on a memory device. Thumbnails are displayed for all of the files that can be played back by the Viewer.

To toggle the file menu between the list view and icon view

Press the [FUNC] key and then the [ENTER] key.



Note

You can specify either the list view or icon view as the default view. For more information, see “Configuring Viewer Settings” on page 34.

To scroll the file menu

Press the [□] key to scroll forward, and the [△] key to scroll back.

To open a folder

Use the cursor keys to move the highlighting to the folder you want to open and then press the [ENTER] key.

To exit the current folder and move up to the next level

Press the [ESC] key.

To view file properties

1. Display the file menu list view.
2. Use the [▼] and [▲] keys to move the highlighting to the file whose properties you want to view.

- A thumbnail and the properties of the currently highlighted file will appear on the left side of the file menu.



- The following explains the information that appears in file properties.

Presentation Mode

This item:	Shows this:
Type	“ECA File” or “PtG File” (Presentation file converted with EZ-Converter FA)
Size	File size
Date	Date and time the file was last modified
Pixels	Number of pixels in the file

Slide Mode

This item:	Shows this:
Type	Image type (“JPEG Image” or “BMP Image”)
Size	File size
Date	Date and time the file was last modified
Pixels	Number of pixels in image data included in the file
Rotation	This item appears only for image files that include Exif format orientation information. “Right side - Top” indicates 90-degree rotation right, while “Left side - Bottom” indicates 90-degree rotation left.

Movie Mode

This item:	Shows this:
Type	“Movie”
Size	File size
Date	Date and time the file was last modified
Pixels	Number of movie pixels in the file

To return to the main Viewer window

1. Press the [FUNC] key.
2. On the function menu that appears, use the cursor keys to move the highlighting to “Back to Viewer Selection” and then press the [ENTER] key.

Configuring Viewer Settings

You can use the Viewer setup menu to configure the Viewer function settings described below. The initial default setting for each item is indicated by an asterisk (*).

Setting Name	Description
Image Zoom	Zoom*: Causes images to be projected in the Data Projector’s maximum possible size while maintaining the aspect ratio of the image file. No Zoom: Causes images to be projected in the actual size.
Display Sequence Setup	Specifies the sequence of images in the file menu. File Names (Ascending)*: Displays files in file name ascending order. File Names (Descending): Displays files in file name descending order Time (New-to-Old): Displays files by the time they were last modified, from the newest to the oldest. Time (Old-to-New): Displays files by the time they were last modified, from the oldest to the newest.
Startup Mode	Specifies whether the default view when a mode is entered from the main Viewer window is the list view or icon view. List View*: Specifies list view as the default view. Icon View: Specifies icon view as the default view.
Image Switching	Manual*: Specifies manual image scrolling. Auto: Specifies auto image scrolling.
Slideshow Display Interval	Specifies how long each image will remain displayed during a slideshow. 5 seconds*, 10 seconds, 30 seconds, 1 minute, 5 minutes
Slideshow Repeat	Repeat: Loops playback of a slideshow or movie. No Repeat*: Automatically stop playback when the end of a slideshow or movie is reached.
Movie Display	Zoom*: Causes movies to be played back at the Data Projector’s maximum possible size while maintaining the aspect ratio of the movie file. No Zoom: Causes movie files to be played back at their original sizes.
Initialize Viewer Setup	Returns all Viewer settings to their initial factory defaults.

To display the Viewer setup menu



Perform either of the following operations.

Operation 1

1. Project the main Viewer window.

- If you are playing a file in the Presentation, Slide, or Movie Mode, pause playback and return to the file menu. Next, press [FUNC], then [▼], then [ENTER].

2. Use the cursor keys to move the highlighting to “Viewer Setup” and then press the [ENTER] key.

Operation 2

1. While the Viewer is being projected, press the [MENU] key.

- If you are playing a file in the Presentation, Slide, or Movie Mode, pause playback before pressing the [MENU] key.

2. Use the [▼] key to move the highlighting to “USB” and then press the [ENTER] key.

3. Use the [▼] key to move the highlighting to “Setup” and then press the [ENTER] key.

To configure Viewer settings

1. Display the Viewer setup menu.
2. Use the [▼] and [▲] keys to move the highlighting to the item whose setting you want to change.
3. Use the [◀] and [▶] keys to display the available settings.
4. After configuring all the settings you want, press the [ESC] key (or press the [FUNC] key and then the [ENTER] key).
 - This will return to the main Viewer window.

To return Viewer settings to their initial defaults

1. Display the Viewer setup menu.
2. Use the [▼] key to move the highlighting to “Initialize Viewer Setup” and then press the [ENTER] key.
 - This will cause a “Do you want to restore defaults for the Viewer setup?” confirmation dialog box to appear.
3. Use the [▲] key to move the highlighting to “Yes” and then press the [ENTER] key.
 - This will return Viewer settings to their initial factory defaults.
 - For information about the Viewer initial factory default settings, see “Configuring Viewer Settings” (page 34).

Autorun

Autorun automatically starts projection of still image files or movie files stored in connected USB memory when the Projector is turned on.



Important!

The Projector's Plug and Play setting must be turned on (enabled) in order to use Autorun. For details about how to change the Plug and Play setting, see "Setup Menu Contents" in the User's Guide (UsersGuide_English.pdf).

To use Autorun for automatic projection of still image or movie files

- 1. In the root directory of the USB memory to be used, create a folder named AUTORUNC.**
 - Be sure to use only upper-case characters when inputting the folder name (AUTORUNC).
- 2. Insert all of the still image or movie files you want to project with Autorun into the AUTORUNC folder you created in step 1.**
 - Place either still image files or movie files into the AUTORUNC folder. If you place both still image and movie files into the folder, only the still image files will be projected by Autorun.
 - If you put more than one still image or movie file into the AUTORUNC folder, they will be projected in the sequence specified by the "Display Sequence Setup" item of the Viewer setup menu (page 34).
- 3. With the Projector turned off, connect the USB memory to it.**
- 4. Turn on the Projector.**
 - This will automatically start up the viewer and start projecting the files you put in the AUTORUNC folder in step 2.
 - Operations after Autorun projection starts are the same as during normal projection.



Note

- Autorun projection of the still image or movie files is performed in accordance with the current settings of the Viewer setup menu (page 34).
- Note that Autorun does not support automatic projection of ECA files or PtG files.

Viewer Troubleshooting

Refer to the following whenever Viewer operations are not what you expect.

Memory Devices

Problem	Cause and Required Action
Viewer does not appear when I connect USB memory to the Data Projector's USB port.	<ul style="list-style-type: none">● The USB memory you are connecting may have a format that cannot be recognized by the Data Projector. Connect the USB memory to your computer to check if its file system is FAT or FAT32. If it isn't, reformat the USB memory to FAT or FAT32. Note that doing so will delete all of the data currently in USB memory. If the Data Projector cannot recognize the USB memory even though its file system is FAT or FAT32, the USB memory itself may be incompatible. Try using different USB memory.● "Off" may be selected for the Data Projector's "Plug and Play" setting. Use the procedure in the "Configuring Advanced Projector Settings" section of the User's Guide on the CD-ROM to change the "Plug and Play" setting to "On".
Some folders and/or files are not displayed in the file menu.	All the folders and/or files contained in a folder will not be displayed if there are more than 999 folder and/or files inside the folder. If this happens, reduce the number of folders and/or files in the folder.
There are multiple devices connected to the Data Projector via a USB hub or USB card reader, but some of the devices are not recognized.	The Data Projector can recognize up to four drives. If the number of connected drives is greater than four, the Data Projector will not recognize the fifth and subsequent drives. Connect memory devices while ensuring that no more than four drives are connected.
When I connect my digital camera to the Data Projector via USB, digital camera memory contents do not appear.	<ul style="list-style-type: none">● The digital camera's USB mass storage class setting may not be configured correctly, or you may need to perform some operation on the camera. Consult the user documentation for your digital camera for information about the required settings and operations.● The digital camera may not support USB mass storage class. If it does not, you will not be able to use Viewer to view digital camera memory contents.

File Display and Playback

Problem	Cause and Required Action
ECA or PtG files converted from PowerPoint files using EZ-Converter FA do not appear in the file menu.	Viewer may be in a mode other than the Presentation Mode. To enter the Presentation Mode, highlight "Presentation" on the main Viewer window (page 21) and then press the [ENTER] key.
Image files do not appear in the file menu.	<ul style="list-style-type: none"> ● Viewer may be in a mode other than the Slide Mode. To enter the Slide Mode, highlight "Slides" on the main Viewer window (page 21) and then press the [ENTER] key. ● The files may not be of a format that can be recognized by the Data Projector. Image files require the following file name extensions: .jpg, .jpeg, .jpe, or .bmp. For details about image file formats supported for Data Projector playback, see "About the Data Projector's USB Functions" (page 5).
Movie files do not appear in the file menu.	<ul style="list-style-type: none"> ● Viewer may be in a mode other than the Movie Mode. To enter the Movie Mode, highlight "Movie" on the main Viewer window (page 21) and then press the [ENTER] key. ● The files may not be of a format that can be recognized by the Data Projector. Movie files require the file name extensions .avi. For details about the movie file format supported for Data Projector playback, see "About the Data Projector's USB Functions" (page 5).
On the Slide Mode file menu, question marks (?) appear in place of thumbnails.	Question marks are displayed in place of thumbnails of images that cannot be projected by Viewer (JPEG files larger than 8MB, etc.).
I cannot play ECA or PtG files I select on the Presentation Mode file menu.	The file you are trying to play may be corrupted. Re-convert the PowerPoint files using the procedure under "To convert a PowerPoint file to an ECA file or PtG file" (page 14).
I cannot play image files I select on the Slide Mode file menu.	<ul style="list-style-type: none"> ● The file you are trying to play may be corrupted. If you have the original file on your computer, check to see if it is normal. If it is, copy the original file to the memory device and try playing it again. ● If the message "Cannot display an image file." appears, refer to "Viewer Error Messages" (page 40).
I cannot play movie files I select on the Movie Mode file menu.	<ul style="list-style-type: none"> ● The file you are trying to play may be corrupted. If you have the original file on your computer, check to see if it is normal. If it is, copy the original file to the memory device and try playing it again. ● If the message "This movie file cannot be played back." appears, refer to "Viewer Error Messages" (page 40).

Viewer Error Messages

Problem	Cause and Required Action
Folder does not contain any image files.	There is no displayable folder, ECA file or PtG file, image file, or movie file in the folder you are trying to access with Viewer. Use your computer to check the contents of the folder. For details about file formats supported for Data Projector playback, see "About the Data Projector's USB Functions" (page 5).
This ECA/PtG file cannot be played back.	There may be an error in the ECA file or PtG file itself. Play back the ECA file or PtG file using the EZ-Converter FA on your computer and check it.
Cannot display an image file.	<ul style="list-style-type: none"> ● The image file may be too large to play back. Use image files that are no larger than 8MB. ● The image file may be a progressive JPEG file. The Data Projector does not support playback of progressive JPEG files. Use normal (non-progressive) JPEG format files. ● There may be an error in the image file itself. Open the image file on your computer and check it.
This movie file cannot be played back.	<ul style="list-style-type: none"> ● The movie file may be a format that is not supported for Data Projector playback. For details about the movie file format supported for Data Projector playback, see "About the Data Projector's USB Functions" (page 5). Some movie file formats can be converted to a format supported for Data Projector playback using software (ArcSoft MediaConverter 3 for CASIO Projector) included on the CD-ROM that comes with the Data Projector. ● There may be an error in the movie file itself. Open the movie file on your computer and check it.

Performing a Presentation Using the YC-400/YC-430 Document Camera

This section explains how to connect the CASIO YC-400/YC-430 Multi Projection Camera (document camera) to the Data Projector in order to project the images of documents placed on the document stage of the document camera. The Data Projector's built-in application named YC Camera is used to project document images.



Important!

A YC-400 document camera can be connected to the Data Projector only if it is running firmware version 1.1 or higher. Firmware updating software is included on the CD-ROM that comes with the projector. For more information, see "Installing the Software" (page 8).

YC Camera Application Function and Operation Overview

YC Camera is an application built into the Data Projector that makes it possible to control the YC-400/YC-430 document camera from the Data Projector. With the YC Camera application you can project the image of documents placed on the document stage of the document camera. Connecting the document camera to the Data Projector's USB port and turning on the document camera will cause the YC Camera application to start up automatically.

Connecting the Document Camera to the Data Projector

This section provides the basic steps you need to perform in order to connect the document camera to the Data Projector and project the image of documents placed onto the document camera's document stage.



Important!

- The procedure below assumes that the Data Projector's plug-and-play feature is turned on (which is the initial default setting). If you have turned off plug-and-play, turn it back on before performing the procedure below. For more details about the plug-and-play setting, see "Setup Menu Contents" in the User's Guide.
- The resolution of recorded images is fixed at 4 megapixels when a YC-400/YC-430 Document Camera is connected to the Data Projector. The resolution setting cannot be changed in this case.

To connect the document camera to the Data Projector and project the image of a document

1. Turn on the Data Projector.

- Wait until the Data Projector's POWER/STANDBY indicator is lit green.

2. Connect the document camera to the Data Projector using the USB cable that comes bundled with the document camera.

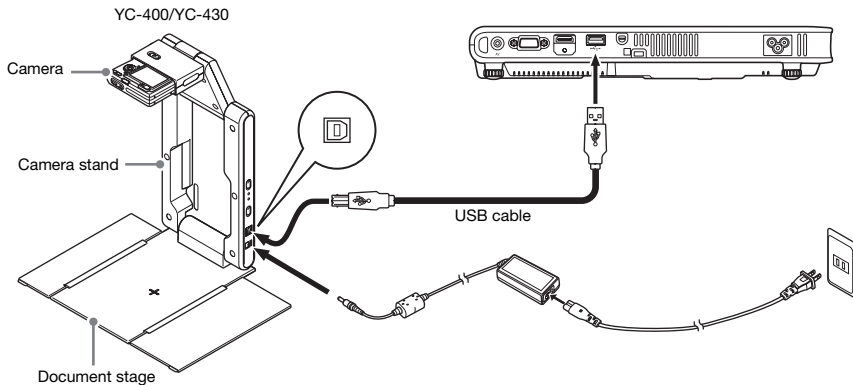

3. With nothing on the document stage, press the [⏻] (power) button on the camera stand.

- This will turn on the document camera, which will cause its lens to extend.
- The Data Projector will recognize the document camera and start up the YC Camera application automatically. When the YC Camera application starts up, the Data Projector will project an image of the document stage along with a dialog box for adjusting the document camera position.

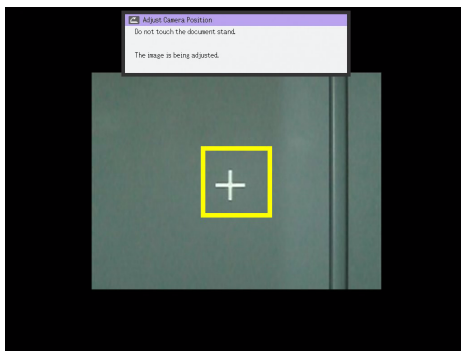

- If the document camera is positioned correctly, position adjustment will end automatically and the dialog box will close. At this time the monitor screen (the image being picked up by the document camera) will be projected.
- If the document camera is not positioned correctly, a message prompting you to adjust the document camera position will appear. Follow the instructions shown in the message to adjust the document camera position.

4. Place the document whose image you want to project onto the document camera's document stage.

- Be sure to place the document in the center of the stage, and do not let any part of the document extend off the edges of the stage.
- When placing a landscape orientation document onto the document stage, the top of the page should face towards the camera stand.
- Initially the monitor image will be projected, and so the image will appear a bit fuzzy.

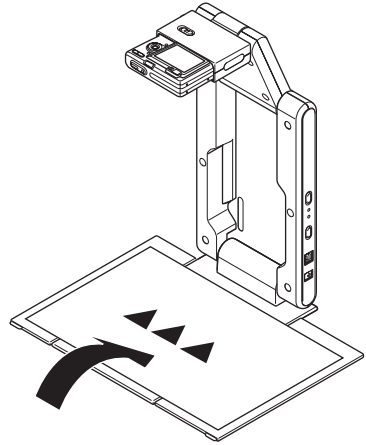
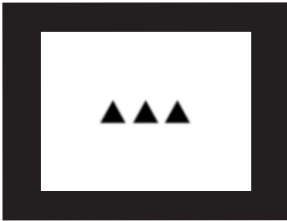

- When the document camera senses that the document on the stage is not being moved, it will record its image and switch from the fuzzy monitor image to a high-resolution image (recorded image) automatically.



Rough (Monitor) Image

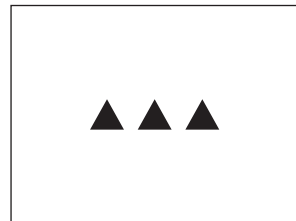

Recorded Image

5. Now you can replace the document currently on the stage with another one.

- This will switch to the recorded image of the next document automatically.



Note

Step 5 above is what happens while the Data Projector's YC Camera application is configured with its initial default settings. The recorded image will not switch automatically if you have changed the "Operation Mode" setting of the YC Camera application to "Manual Capture". For more information, see "YC Camera Application Setup Menu Contents" on page 50.

YC Camera Application Operations

This section explains the various types of projection operations you can perform with the YC Camera application and how to configure YC Camera application settings.



Important!

The procedures in this section assume that you have already connected the Document Camera to the Data Projector as explained under “Connecting the Document Camera to the Data Projector” (page 41), and that the Data Projector’s YC Camera application is running.

YC Camera Application Projection Operations

The operations in this section are performed using the YC Camera function menu, which appears when you press the [FUNC] key while the YC Camera application is running.

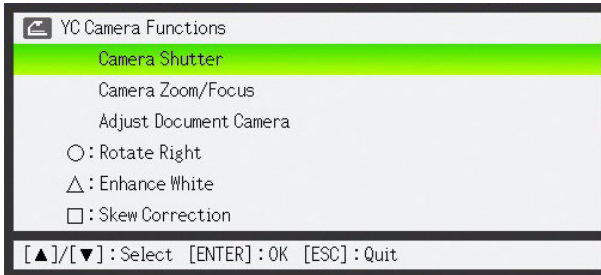

Some operations can be performed using the remote controller’s [○], [△], and [□] keys.

To release the document camera shutter manually

- 1. Press the [FUNC] key to display the YC Camera application function menu.**
 - The “Camera Shutter” item should be highlighted by default.
- 2. Press the [ENTER] key to release the document camera shutter.**
 - This will cause the image recorded with the document camera to be projected.



Note

While a rough monitor image or recorded image is projected, you can release the shutter manually by pressing the [ENTER] key, without pressing the [FUNC] key.

To adjust the document camera's zoom setting

1. Press the [FUNC] key to display the YC Camera application function menu.
2. Use the [▼] key to move the highlighting to “Camera Zoom/Focus” and then press the [ENTER] key.
 - This causes the YC Camera Zoom/Focus dialog box to appear in the projection area. The “Optical Zoom” item should be highlighted by default.

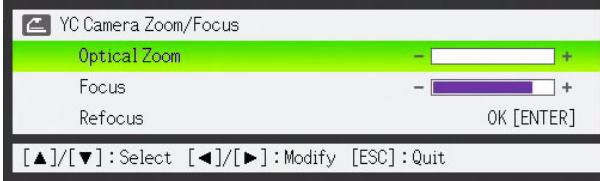

3. Use the [▶] and [◀] keys to adjust the document camera's zoom setting.
4. After the zoom setting is the way you want, press the [ESC] key.
 - This will close the YC Camera Zoom/Focus dialog box.

To adjust document focus manually

1. Press the [FUNC] key to display the YC Camera application function menu.
2. Use the [▼] key to move the highlighting to “Camera Zoom/Focus” and then press the [ENTER] key.
 - This causes the YC Camera Zoom/Focus dialog box to appear in the projection area.

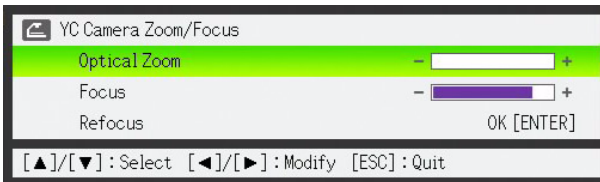

3. Press the [▼] key to move the highlighting to “Focus”.
4. Use the [▶] and [◀] keys to adjust the document camera's focus.
5. After the focus is the way you want, press the [ESC] key.
 - This will close the YC Camera Zoom/Focus dialog box.

To adjust the camera position

1. Remove all documents and objects from the document stage.
2. Press the [FUNC] key to display the YC Camera application function menu.
3. Use the [▼] key to move the highlighting to “Adjust Camera Position” and then press the [ENTER] key.
 - This displays the camera position adjustment dialog box.
4. Point the document camera downwards so the lens is pointed towards the document stage.
 - Aim the camera as instructed by the text that appears in the projection area.

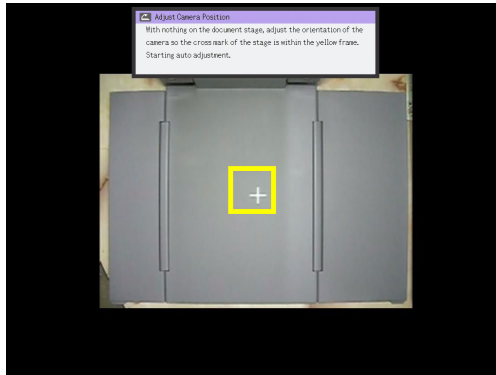

- When the document camera is positioned correctly, position adjustment will end and the dialog box will close. At this time the monitor screen (the image being picked up by the document camera) will be projected.

To rotate the currently projected image

1. Press the [FUNC] key to display the YC Camera application function menu.
2. Use the [▼] key to move the highlighting to “Rotate Right” and then press the [ENTER] key.
 - This will rotate the projected image 90 degrees to the right.
 - Instead of steps 1 and 2 above, you can also rotate the projected image by pressing the [O] key.



Note

This operation will affect only the image that is currently being projected. The projection image produced the next time you release the shutter will be projected in accordance with the settings on the YC Camera Application Setup Menu (page 48).

To perform white enhancement on the currently projected image



Note

- White enhancement causes the background of the projected image to be white enhanced, which helps to make the text on a document easier to read.
- This operation will affect only the image that is currently being projected. The projection image produced the next time you release the shutter will be projected in accordance with the settings on the YC Camera Application Setup Menu (page 48).



Important!

You can perform white enhancement only on a projected image that has been skew corrected. For more information, see the note under “To perform manual skew correction on the currently projected image” (page 47).

- 1. Press the [FUNC] key to display the YC Camera application function menu.**
- 2. Use the [▼] key to move the highlighting to “Enhance White” and then press the [ENTER] key.**
 - This will enhance the white of the projected image.
 - Instead of steps 1 and 2 above, you can also white enhance the projected image by pressing the [△] key.

To perform manual skew correction on the currently projected image



Note

- Skew correction automatically straightens the image of a document that is misaligned on the document stage of the document camera. Under its initial defaults, the YC Camera application is configured to perform skew correction automatically. You can also turn off auto skew correction. If you do, you can use the following procedure to adjust image alignment manually.
- This operation will affect only the image that is currently being projected. The projection image produced the next time you release the shutter will be projected in accordance with the settings on the YC Camera Application Setup Menu (page 48).

- 1. Press the [FUNC] key to display the YC Camera application function menu.**
- 2. Use the [▼] key to move the highlighting to “Skew Correction” and then press the [ENTER] key.**
 - This will straighten the projected image.
 - Instead of steps 1 and 2 above, you can also perform skew correction of the projected image by pressing the [□] key.

Configuring YC Camera Application Setup Menu Settings

You can use the YC Camera setup menu to configure various YC Camera application operation settings.

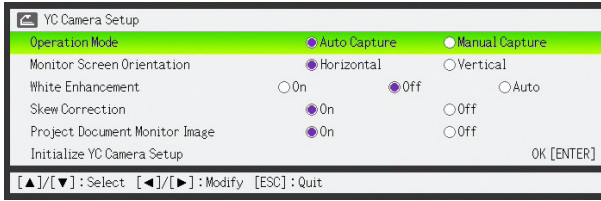

To configure YC Camera application setup menu settings

1. Press the [MENU] key to display the setup menu.
2. Press the [▼] key to move the highlighting to “USB” and then press the [ENTER] key.
3. Press the [▼] key once to move the highlighting to “Setup” and then press the [ENTER] key.
 - This will display the YC Camera application setup menu.
4. Use the [▼] and [▲] keys to select the menu item whose setting you want to change.
5. Press the [◀] or [▶] key to select the setting you want (so its button is ●).
6. Repeat steps 4 and 5 to configure other settings, if you want.
7. After you are finished, press the [ESC] key to exit the setup menu.



Note

Anytime you change the “White Enhancement” or “Skew Correction” setting, the new setting goes into effect from the next image you record with the document camera after exiting the setup menu. Other settings go into effect as soon as you exit the setup menu.

To restore all settings on the YC Camera application setup menu to their initial factory defaults

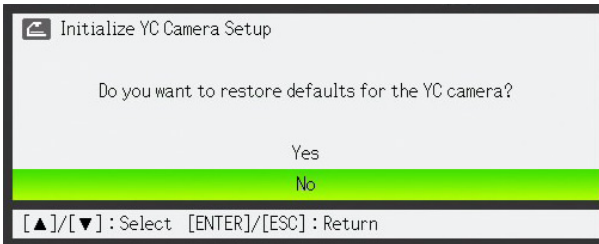

1. Press the [MENU] key to display the setup menu.
2. Press the [▼] key to move the highlighting to “USB” and then press the [ENTER] key.
3. Press the [▼] key once to move the highlighting to “Setup” and then press the [ENTER] key.
 - This will display the YC Camera application setup menu.
4. Press the [▼] key to move the highlighting to “Initialize YC Camera Setup” and then press the [ENTER] key.
 - This displays the dialog box shown below.



5. Use the [▲] key to select “Yes”.
6. To restore all the settings to their initial defaults, press the [ENTER] key.
 - To exit the operation without doing anything, press the [ESC] key instead of the [ENTER] key.
7. After you are finished, press the [ESC] key to exit the setup menu.

YC Camera Application Setup Menu Contents

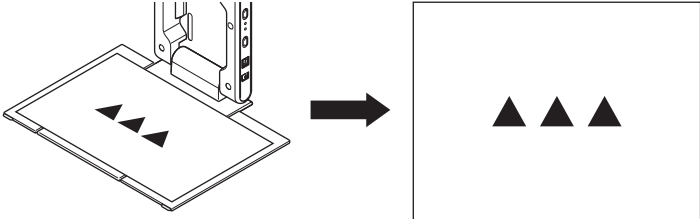
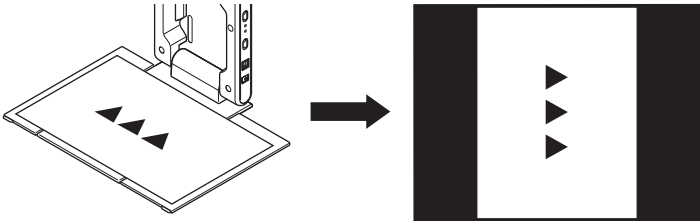
This section provides detailed explanations of all of the items included on the YC Camera application setup menu. The initial default setting for each item is indicated by an asterisk (*).

Setting Name	Description
Operation Mode	<p>Specifies whether recording of documents placed on the document stage of the document camera should be performed automatically or manually.</p> <p>Auto Capture*: Automatically records the image of a document whenever it is placed on the document stage.</p> <p>Manual Capture: Requires manual release of the shutter each time a document is placed on the document stage.</p>
Monitor Screen Orientation	<p>Switches the monitor screen orientation.</p> <p>Horizontal*: Records the document on the document stage horizontally.</p>  <p>Vertical: Records the document on the document stage vertically.</p> 
White Enhancement	<p>Specifies whether or not white enhancement should be performed on the projected image.</p> <p>Off*: Turns off white enhancement.</p> <p>On: Turns on white enhancement.</p> <p>Auto: The decision whether or not to perform white enhancement is made automatically in accordance with the image being recorded.</p> <p> Important! _____ White enhancement cannot be performed while the “Skew Correction” setting is “Off”.</p>

Setting Name	Description
Skew Correction	<p>Specifies whether or not skew correction should be performed automatically on the projected image.</p> <p>On*: Turns on automatic skew correction.</p> <p>Off: Turns off automatic skew correction.</p>
Project Document Monitor Image	<p>Specifies whether or not the camera's monitor image should be projected when a document is removed from the document stage.</p> <p>On*: Displays the monitor image.</p> <p>Off: Does not display the monitor image.</p>
Initialize YC Camera Setup	<p>Returns all YC Camera application setup menu items to their initial default settings. For details, see "To restore all settings on the YC Camera application setup menu to their initial factory defaults" on page 49.</p>

Projecting the Screen Image of a Graphing Calculator

You can connect a CASIO graphing calculator to the Data Projector using a USB cable and project the calculator's screen image with the Data Projector. USB connection of the following CASIO graphing calculators is supported.

- fx-9860G Series
- fx-9860GII Series
- fx-CG10, fx-CG20
- ClassPad 330 PLUS

To project the screen image of a graphing calculator



Note

The procedure below uses a CASIO fx-9860G Series graphing calculator. When using any other CASIO graphing calculator model, see the chapter titled "Data Communication" in its User's Guide.

1. Set the graphing calculator up for data communication.

Enter the LINK Mode, and configure the "Wakeup" and "Capture" settings as shown below.



- Be sure to configure these communication settings before you connect the calculator to the Data Projector.
- See the user documentation that comes with your calculator for details about configuring these settings.

2. Turn on the Data Projector.

3. Use the USB cable that came with the graphing calculator to connect it to the Data Projector as illustrated below.

- This will project an image of the graphing calculator from the Data Projector.

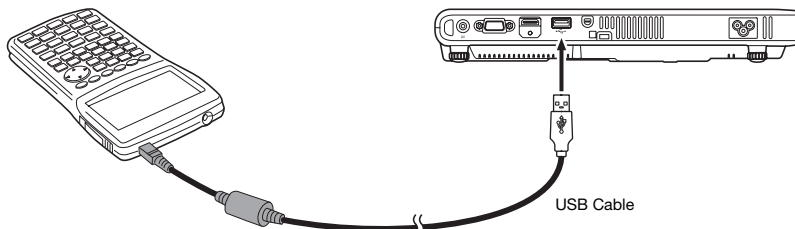

* The illustration shows the fx-9860G as an example.



Important!

- If an hourglass figure appears in the image projected from the Data Projector when you connect the calculator, perform some operation on the calculator. This should cause the hourglass to disappear and enable normal projection.
- If the calculator does not operate properly after you connect it to the Data Projector, try disconnecting the USB cable from the calculator and then reconnecting it. If this does not correct the problem, disconnect the USB cable from both the Data Projector and the calculator. Turn the Data Projector off and then back on again, and then re-connect the calculator.

GPL and LGPL

- (1) This product uses software (This Software) that comes under the GNU General Public License (GPL) and GNU Lesser General Public License (LGPL). In accordance with the GPL and LGPL, the source code of This Software is open source code. Anyone who wishes to view the open source code can do so by downloading it from the CASIO Projector download site. Whenever copying, modifying, or distributing This Software, be sure to do so in accordance with the terms and conditions of the GPL and LGPL.
- (2) This Software is provided “as is” without expressed or implied warranty of any kind. However, this disclaimer does not affect the terms and conditions of the warranty of the product itself (including malfunctions due to This Software).
- (3) The following are the GPL and LGPL that This Software comes under.

GNU GENERAL PUBLIC LICENSE

Version 2, June 1991

Copyright (C) 1989, 1991 Free Software Foundation, Inc.
51 Franklin Street, Fifth Floor, Boston, MA 02110-1301, USA

Everyone is permitted to copy and distribute verbatim copies
of this license document, but changing it is not allowed.

Preamble

The licenses for most software are designed to take away your freedom to share and change it. By contrast, the GNU General Public License is intended to guarantee your freedom to share and change free software--to make sure the software is free for all its users. This General Public License applies to most of the Free Software Foundation's software and to any other program whose authors commit to using it. (Some other Free Software Foundation software is covered by the GNU Lesser General Public License instead.) You can apply it to your programs, too.

When we speak of free software, we are referring to freedom, not price. Our General Public Licenses are designed to make sure that you have the freedom to distribute copies of free software (and charge for this service if you wish), that you receive source code or can get it if you want it, that you can change the software or use pieces of it in new free programs; and that you know you can do these things.

To protect your rights, we need to make restrictions that forbid anyone to deny you these rights or to ask you to surrender the rights. These restrictions translate to certain responsibilities for you if you distribute copies of the software, or if you modify it.

For example, if you distribute copies of such a program, whether gratis or for a fee, you must give the recipients all the rights that you have. You must make sure that they, too, receive or can get the source code. And you must show them these terms so they know their rights.

We protect your rights with two steps: (1) copyright the software, and (2) offer you this license which gives you legal permission to copy, distribute and/or modify the software.

Also, for each author's protection and ours, we want to make certain that everyone understands that there is no warranty for this free software. If the software is modified by someone else and passed on, we want its recipients to know that what they have is not the original, so that any problems introduced by others will not reflect on the original authors' reputations.

Finally, any free program is threatened constantly by software patents. We wish to avoid the danger that redistributors of a free program will individually obtain patent licenses, in effect making the program proprietary. To prevent this, we have made it clear that any patent must be licensed for everyone's free use or not licensed at all.

The precise terms and conditions for copying, distribution and modification follow.

TERMS AND CONDITIONS FOR COPYING, DISTRIBUTION AND MODIFICATION

0. This License applies to any program or other work which contains a notice placed by the copyright holder saying it may be distributed under the terms of this General Public License. The “Program”, below, refers to any such program or work, and a “work based on the Program” means either the Program or any derivative work under copyright law: that is to say, a work containing the Program or a portion of it, either verbatim or with modifications and/or translated into another language. (Hereinafter, translation is included without limitation in the term “modification”.) Each licensee is addressed as “you”.

Activities other than copying, distribution and modification are not covered by this License; they are outside its scope. The act of running the Program is not restricted, and the output from the Program is covered only if its contents constitute a work based on the Program (independent of having been made by running the Program). Whether that is true depends on what the Program does.

1. You may copy and distribute verbatim copies of the Program’s source code as you receive it, in any medium, provided that you conspicuously and appropriately publish on each copy an appropriate copyright notice and disclaimer of warranty; keep intact all the notices that refer to this License and to the absence of any warranty; and give any other recipients of the Program a copy of this License along with the Program.

You may charge a fee for the physical act of transferring a copy, and you may at your option offer warranty protection in exchange for a fee.

2. You may modify your copy or copies of the Program or any portion of it, thus forming a work based on the Program, and copy and distribute such modifications or work under the terms of Section 1 above, provided that you also meet all of these conditions:
- a) You must cause the modified files to carry prominent notices stating that you changed the files and the date of any change.
 - b) You must cause any work that you distribute or publish, that in whole or in part contains or is derived from the Program or any part thereof, to be licensed as a whole at no charge to all third parties under the terms of this License.
 - c) If the modified program normally reads commands interactively when run, you must cause it, when started running for such interactive use in the most ordinary way, to print or display an announcement including an appropriate copyright notice and a notice that there is no warranty (or else, saying that you provide a warranty) and that users may redistribute the program under these conditions, and telling the user how to view a copy of this License. (Exception: if the Program itself is interactive but does not normally print such an announcement, your work based on the Program is not required to print an announcement.)

These requirements apply to the modified work as a whole. If identifiable sections of that work are not derived from the Program, and can be reasonably considered independent and separate works in themselves, then this License, and its terms, do not apply to those sections when you distribute them as separate works. But when you distribute the same sections as part of a whole which is a work based on the Program, the distribution of the whole must be on the terms of this License, whose permissions for other licensees extend to the entire whole, and thus to each and every part regardless of who wrote it.

Thus, it is not the intent of this section to claim rights or contest your rights to work written entirely by you; rather, the intent is to exercise the right to control the distribution of derivative or collective works based on the Program.

In addition, mere aggregation of another work not based on the Program with the Program (or with a work based on the Program) on a volume of a storage or distribution medium does not bring the other work under the scope of this License.

3. You may copy and distribute the Program (or a work based on it, under Section 2) in object code or executable form under the terms of Sections 1 and 2 above provided that you also do one of the following:
 - a) Accompany it with the complete corresponding machine-readable source code, which must be distributed under the terms of Sections 1 and 2 above on a medium customarily used for software interchange; or,
 - b) Accompany it with a written offer, valid for at least three years, to give any third party, for a charge no more than your cost of physically performing source distribution, a complete machine-readable copy of the corresponding source code, to be distributed under the terms of Sections 1 and 2 above on a medium customarily used for software interchange; or,
 - c) Accompany it with the information you received as to the offer to distribute corresponding source code. (This alternative is allowed only for noncommercial distribution and only if you received the program in object code or executable form with such an offer, in accord with Subsection b above.)

The source code for a work means the preferred form of the work for making modifications to it. For an executable work, complete source code means all the source code for all modules it contains, plus any associated interface definition files, plus the scripts used to control compilation and installation of the executable. However, as a special exception, the source code distributed need not include anything that is normally distributed (in either source or binary form) with the major components (compiler, kernel, and so on) of the operating system on which the executable runs, unless that component itself accompanies the executable.

If distribution of executable or object code is made by offering access to copy from a designated place, then offering equivalent access to copy the source code from the same place counts as distribution of the source code, even though third parties are not compelled to copy the source along with the object code.

4. You may not copy, modify, sublicense, or distribute the Program except as expressly provided under this License. Any attempt otherwise to copy, modify, sublicense or distribute the Program is void, and will automatically terminate your rights under this License. However, parties who have received copies, or rights, from you under this License will not have their licenses terminated so long as such parties remain in full compliance.

5. You are not required to accept this License, since you have not signed it. However, nothing else grants you permission to modify or distribute the Program or its derivative works. These actions are prohibited by law if you do not accept this License. Therefore, by modifying or distributing the Program (or any work based on the Program), you indicate your acceptance of this License to do so, and all its terms and conditions for copying, distributing or modifying the Program or works based on it.
6. Each time you redistribute the Program (or any work based on the Program), the recipient automatically receives a license from the original licensor to copy, distribute or modify the Program subject to these terms and conditions. You may not impose any further restrictions on the recipients' exercise of the rights granted herein. You are not responsible for enforcing compliance by third parties to this License.
7. If, as a consequence of a court judgment or allegation of patent infringement or for any other reason (not limited to patent issues), conditions are imposed on you (whether by court order, agreement or otherwise) that contradict the conditions of this License, they do not excuse you from the conditions of this License. If you cannot distribute so as to satisfy simultaneously your obligations under this License and any other pertinent obligations, then as a consequence you may not distribute the Program at all. For example, if a patent license would not permit royalty-free redistribution of the Program by all those who receive copies directly or indirectly through you, then the only way you could satisfy both it and this License would be to refrain entirely from distribution of the Program.

If any portion of this section is held invalid or unenforceable under any particular circumstance, the balance of the section is intended to apply and the section as a whole is intended to apply in other circumstances.

It is not the purpose of this section to induce you to infringe any patents or other property right claims or to contest validity of any such claims; this section has the sole purpose of protecting the integrity of the free software distribution system, which is implemented by public license practices. Many people have made generous contributions to the wide range of software distributed through that system in reliance on consistent application of that system; it is up to the author/donor to decide if he or she is willing to distribute software through any other system and a licensee cannot impose that choice.

This section is intended to make thoroughly clear what is believed to be a consequence of the rest of this License.

8. If the distribution and/or use of the Program is restricted in certain countries either by patents or by copyrighted interfaces, the original copyright holder who places the Program under this License may add an explicit geographical distribution limitation excluding those countries, so that distribution is permitted only in or among countries not thus excluded. In such case, this License incorporates the limitation as if written in the body of this License.
9. The Free Software Foundation may publish revised and/or new versions of the General Public License from time to time. Such new versions will be similar in spirit to the present version, but may differ in detail to address new problems or concerns.

Each version is given a distinguishing version number. If the Program specifies a version number of this License which applies to it and "any later version", you have the option of following the terms and conditions either of that version or of any later version published by the Free Software Foundation. If the Program does not specify a version number of this License, you may choose any version ever published by the Free Software Foundation.

10.If you wish to incorporate parts of the Program into other free programs whose distribution conditions are different, write to the author to ask for permission. For software which is copyrighted by the Free Software Foundation, write to the Free Software Foundation; we sometimes make exceptions for this. Our decision will be guided by the two goals of preserving the free status of all derivatives of our free software and of promoting the sharing and reuse of software generally.

NO WARRANTY

11.BECAUSE THE PROGRAM IS LICENSED FREE OF CHARGE, THERE IS NO WARRANTY FOR THE PROGRAM, TO THE EXTENT PERMITTED BY APPLICABLE LAW. EXCEPT WHEN OTHERWISE STATED IN WRITING THE COPYRIGHT HOLDERS AND/OR OTHER PARTIES PROVIDE THE PROGRAM "AS IS" WITHOUT WARRANTY OF ANY KIND, EITHER EXPRESSED OR IMPLIED, INCLUDING, BUT NOT LIMITED TO, THE IMPLIED WARRANTIES OF MERCHANTABILITY AND FITNESS FOR A PARTICULAR PURPOSE. THE ENTIRE RISK AS TO THE QUALITY AND PERFORMANCE OF THE PROGRAM IS WITH YOU. SHOULD THE PROGRAM PROVE DEFECTIVE, YOU ASSUME THE COST OF ALL NECESSARY SERVICING, REPAIR OR CORRECTION.

12.IN NO EVENT UNLESS REQUIRED BY APPLICABLE LAW OR AGREED TO IN WRITING WILL ANY COPYRIGHT HOLDER, OR ANY OTHER PARTY WHO MAY MODIFY AND/OR REDISTRIBUTE THE PROGRAM AS PERMITTED ABOVE, BE LIABLE TO YOU FOR DAMAGES, INCLUDING ANY GENERAL, SPECIAL, INCIDENTAL OR CONSEQUENTIAL DAMAGES ARISING OUT OF THE USE OR INABILITY TO USE THE PROGRAM (INCLUDING BUT NOT LIMITED TO LOSS OF DATA OR DATA BEING RENDERED INACCURATE OR LOSSES SUSTAINED BY YOU OR THIRD PARTIES OR A FAILURE OF THE PROGRAM TO OPERATE WITH ANY OTHER PROGRAMS), EVEN IF SUCH HOLDER OR OTHER PARTY HAS BEEN ADVISED OF THE POSSIBILITY OF SUCH DAMAGES.

END OF TERMS AND CONDITIONS

How to Apply These Terms to Your New Programs

If you develop a new program, and you want it to be of the greatest possible use to the public, the best way to achieve this is to make it free software which everyone can redistribute and change under these terms.

To do so, attach the following notices to the program. It is safest to attach them to the start of each source file to most effectively convey the exclusion of warranty; and each file should have at least the "copyright" line and a pointer to where the full notice is found.

```
one line to give the program's name and an idea of what it does.  
Copyright (C) yyyy name of author
```

```
This program is free software; you can redistribute it and/or  
modify it under the terms of the GNU General Public License  
as published by the Free Software Foundation; either version 2  
of the License, or (at your option) any later version.
```

```
This program is distributed in the hope that it will be useful,  
but WITHOUT ANY WARRANTY; without even the implied warranty of  
MERCHANTABILITY or FITNESS FOR A PARTICULAR PURPOSE. See the  
GNU General Public License for more details.
```

```
You should have received a copy of the GNU General Public License  
along with this program; if not, write to the Free Software  
Foundation, Inc., 51 Franklin Street, Fifth Floor, Boston, MA 02110-1301, USA.
```

Also add information on how to contact you by electronic and paper mail.

If the program is interactive, make it output a short notice like this when it starts in an interactive mode:

```
Gnomovision version 69, Copyright (C) year name of author  
Gnomovision comes with ABSOLUTELY NO WARRANTY; for details  
type 'show w'. This is free software, and you are welcome  
to redistribute it under certain conditions; type 'show c'  
for details.
```

The hypothetical commands 'show w' and 'show c' should show the appropriate parts of the General Public License. Of course, the commands you use may be called something other than 'show w' and 'show c'; they could even be mouse-clicks or menu items--whatever suits your program.

You should also get your employer (if you work as a programmer) or your school, if any, to sign a "copyright disclaimer" for the program, if necessary. Here is a sample; alter the names:

```
Yoyodyne, Inc., hereby disclaims all copyright  
interest in the program 'Gnomovision'  
(which makes passes at compilers) written  
by James Hacker.
```

```
signature of Ty Coon, 1 April 1989  
Ty Coon, President of Vice
```

This General Public License does not permit incorporating your program into proprietary programs. If your program is a subroutine library, you may consider it more useful to permit linking proprietary applications with the library. If this is what you want to do, use the GNU Lesser General Public License instead of this License.

GNU LESSER GENERAL PUBLIC LICENSE

Version 2.1, February 1999

Copyright (C) 1991, 1999 Free Software Foundation, Inc.
51 Franklin Street, Fifth Floor, Boston, MA 02110-1301 USA
Everyone is permitted to copy and distribute verbatim copies
of this license document, but changing it is not allowed.

[This is the first released version of the Lesser GPL. It also counts
as the successor of the GNU Library Public License, version 2, hence
the version number 2.1.]

Preamble

The licenses for most software are designed to take away your freedom to share and change it. By contrast, the GNU General Public Licenses are intended to guarantee your freedom to share and change free software--to make sure the software is free for all its users.

This license, the Lesser General Public License, applies to some specially designated software packages--typically libraries--of the Free Software Foundation and other authors who decide to use it. You can use it too, but we suggest you first think carefully about whether this license or the ordinary General Public License is the better strategy to use in any particular case, based on the explanations below.

When we speak of free software, we are referring to freedom of use, not price. Our General Public Licenses are designed to make sure that you have the freedom to distribute copies of free software (and charge for this service if you wish); that you receive source code or can get it if you want it; that you can change the software and use pieces of it in new free programs; and that you are informed that you can do these things.

To protect your rights, we need to make restrictions that forbid distributors to deny you these rights or to ask you to surrender these rights. These restrictions translate to certain responsibilities for you if you distribute copies of the library or if you modify it.

For example, if you distribute copies of the library, whether gratis or for a fee, you must give the recipients all the rights that we gave you. You must make sure that they, too, receive or can get the source code. If you link other code with the library, you must provide complete object files to the recipients, so that they can relink them with the library after making changes to the library and recompiling it. And you must show them these terms so they know their rights.

We protect your rights with a two-step method: (1) we copyright the library, and (2) we offer you this license, which gives you legal permission to copy, distribute and/or modify the library.

To protect each distributor, we want to make it very clear that there is no warranty for the free library. Also, if the library is modified by someone else and passed on, the recipients should know that what they have is not the original version, so that the original author's reputation will not be affected by problems that might be introduced by others.

Finally, software patents pose a constant threat to the existence of any free program. We wish to make sure that a company cannot effectively restrict the users of a free program by obtaining a restrictive license from a patent holder. Therefore, we insist that any patent license obtained for a version of the library must be consistent with the full freedom of use specified in this license.

Most GNU software, including some libraries, is covered by the ordinary GNU General Public License. This license, the GNU Lesser General Public License, applies to certain designated libraries, and is quite different from the ordinary General Public License. We use this license for certain libraries in order to permit linking those libraries into non-free programs.

When a program is linked with a library, whether statically or using a shared library, the combination of the two is legally speaking a combined work, a derivative of the original library. The ordinary General Public License therefore permits such linking only if the entire combination fits its criteria of freedom. The Lesser General Public License permits more lax criteria for linking other code with the library.

We call this license the “Lesser” General Public License because it does Less to protect the user’s freedom than the ordinary General Public License. It also provides other free software developers Less of an advantage over competing non-free programs. These disadvantages are the reason we use the ordinary General Public License for many libraries. However, the Lesser license provides advantages in certain special circumstances.

For example, on rare occasions, there may be a special need to encourage the widest possible use of a certain library, so that it becomes a de-facto standard. To achieve this, non-free programs must be allowed to use the library. A more frequent case is that a free library does the same job as widely used non-free libraries. In this case, there is little to gain by limiting the free library to free software only, so we use the Lesser General Public License.

In other cases, permission to use a particular library in non-free programs enables a greater number of people to use a large body of free software. For example, permission to use the GNU C Library in non-free programs enables many more people to use the whole GNU operating system, as well as its variant, the GNU/Linux operating system.

Although the Lesser General Public License is Less protective of the users’ freedom, it does ensure that the user of a program that is linked with the Library has the freedom and the wherewithal to run that program using a modified version of the Library.

The precise terms and conditions for copying, distribution and modification follow. Pay close attention to the difference between a “work based on the library” and a “work that uses the library”. The former contains code derived from the library, whereas the latter must be combined with the library in order to run.

TERMS AND CONDITIONS FOR COPYING, DISTRIBUTION AND MODIFICATION

0. This License Agreement applies to any software library or other program which contains a notice placed by the copyright holder or other authorized party saying it may be distributed under the terms of this Lesser General Public License (also called “this License”). Each licensee is addressed as “you”.

A “library” means a collection of software functions and/or data prepared so as to be conveniently linked with application programs (which use some of those functions and data) to form executables.

The “Library”, below, refers to any such software library or work which has been distributed under these terms. A “work based on the Library” means either the Library or any derivative work under copyright law: that is to say, a work containing the Library or a portion of it, either verbatim or with modifications and/or translated straightforwardly into another language. (Hereinafter, translation is included without limitation in the term “modification”).

“Source code” for a work means the preferred form of the work for making modifications to it. For a library, complete source code means all the source code for all modules it contains, plus any associated interface definition files, plus the scripts used to control compilation and installation of the library.

Activities other than copying, distribution and modification are not covered by this License; they are outside its scope. The act of running a program using the Library is not restricted, and output from such a program is covered only if its contents constitute a work based on the Library (independent of the use of the Library in a tool for writing it). Whether that is true depends on what the Library does and what the program that uses the Library does.

1. You may copy and distribute verbatim copies of the Library’s complete source code as you receive it, in any medium, provided that you conspicuously and appropriately publish on each copy an appropriate copyright notice and disclaimer of warranty; keep intact all the notices that refer to this License and to the absence of any warranty; and distribute a copy of this License along with the Library.

You may charge a fee for the physical act of transferring a copy, and you may at your option offer warranty protection in exchange for a fee.

2. You may modify your copy or copies of the Library or any portion of it, thus forming a work based on the Library, and copy and distribute such modifications or work under the terms of Section 1 above, provided that you also meet all of these conditions:
- a) The modified work must itself be a software library.
 - b) You must cause the files modified to carry prominent notices stating that you changed the files and the date of any change.
 - c) You must cause the whole of the work to be licensed at no charge to all third parties under the terms of this License.

- d) If a facility in the modified Library refers to a function or a table of data to be supplied by an application program that uses the facility, other than as an argument passed when the facility is invoked, then you must make a good faith effort to ensure that, in the event an application does not supply such function or table, the facility still operates, and performs whatever part of its purpose remains meaningful.

(For example, a function in a library to compute square roots has a purpose that is entirely well-defined independent of the application. Therefore, Subsection 2d requires that any application-supplied function or table used by this function must be optional: if the application does not supply it, the square root function must still compute square roots.)

These requirements apply to the modified work as a whole. If identifiable sections of that work are not derived from the Library, and can be reasonably considered independent and separate works in themselves, then this License, and its terms, do not apply to those sections when you distribute them as separate works. But when you distribute the same sections as part of a whole which is a work based on the Library, the distribution of the whole must be on the terms of this License, whose permissions for other licensees extend to the entire whole, and thus to each and every part regardless of who wrote it.

Thus, it is not the intent of this section to claim rights or contest your rights to work written entirely by you; rather, the intent is to exercise the right to control the distribution of derivative or collective works based on the Library.

In addition, mere aggregation of another work not based on the Library with the Library (or with a work based on the Library) on a volume of a storage or distribution medium does not bring the other work under the scope of this License.

3. You may opt to apply the terms of the ordinary GNU General Public License instead of this License to a given copy of the Library. To do this, you must alter all the notices that refer to this License, so that they refer to the ordinary GNU General Public License, version 2, instead of to this License. (If a newer version than version 2 of the ordinary GNU General Public License has appeared, then you can specify that version instead if you wish.) Do not make any other change in these notices.

Once this change is made in a given copy, it is irreversible for that copy, so the ordinary GNU General Public License applies to all subsequent copies and derivative works made from that copy.

This option is useful when you wish to copy part of the code of the Library into a program that is not a library.

4. You may copy and distribute the Library (or a portion or derivative of it, under Section 2) in object code or executable form under the terms of Sections 1 and 2 above provided that you accompany it with the complete corresponding machine-readable source code, which must be distributed under the terms of Sections 1 and 2 above on a medium customarily used for software interchange.

If distribution of object code is made by offering access to copy from a designated place, then offering equivalent access to copy the source code from the same place satisfies the requirement to distribute the source code, even though third parties are not compelled to copy the source along with the object code.

5. A program that contains no derivative of any portion of the Library, but is designed to work with the Library by being compiled or linked with it, is called a “work that uses the Library”. Such a work, in isolation, is not a derivative work of the Library, and therefore falls outside the scope of this License.

However, linking a “work that uses the Library” with the Library creates an executable that is a derivative of the Library (because it contains portions of the Library), rather than a “work that uses the library”. The executable is therefore covered by this License. Section 6 states terms for distribution of such executables.

When a “work that uses the Library” uses material from a header file that is part of the Library, the object code for the work may be a derivative work of the Library even though the source code is not. Whether this is true is especially significant if the work can be linked without the Library, or if the work is itself a library. The threshold for this to be true is not precisely defined by law.

If such an object file uses only numerical parameters, data structure layouts and accessors, and small macros and small inline functions (ten lines or less in length), then the use of the object file is unrestricted, regardless of whether it is legally a derivative work. (Executables containing this object code plus portions of the Library will still fall under Section 6.)

Otherwise, if the work is a derivative of the Library, you may distribute the object code for the work under the terms of Section 6. Any executables containing that work also fall under Section 6, whether or not they are linked directly with the Library itself.

6. As an exception to the Sections above, you may also combine or link a “work that uses the Library” with the Library to produce a work containing portions of the Library, and distribute that work under terms of your choice, provided that the terms permit modification of the work for the customer’s own use and reverse engineering for debugging such modifications.

You must give prominent notice with each copy of the work that the Library is used in it and that the Library and its use are covered by this License. You must supply a copy of this License. If the work during execution displays copyright notices, you must include the copyright notice for the Library among them, as well as a reference directing the user to the copy of this License. Also, you must do one of these things:

- a) Accompany the work with the complete corresponding machine-readable source code for the Library including whatever changes were used in the work (which must be distributed under Sections 1 and 2 above); and, if the work is an executable linked with the Library, with the complete machine-readable “work that uses the Library”, as object code and/or source code, so that the user can modify the Library and then relink to produce a modified executable containing the modified Library. (It is understood that the user who changes the contents of definitions files in the Library will not necessarily be able to recompile the application to use the modified definitions.)
- b) Use a suitable shared library mechanism for linking with the Library. A suitable mechanism is one that (1) uses at run time a copy of the library already present on the user’s computer system, rather than copying library functions into the executable, and (2) will operate properly with a modified version of the library, if the user installs one, as long as the modified version is interface-compatible with the version that the work was made with.
- c) Accompany the work with a written offer, valid for at least three years, to give the same user the materials specified in Subsection 6a, above, for a charge no more than the cost of performing this distribution.
- d) If distribution of the work is made by offering access to copy from a designated place, offer equivalent access to copy the above specified materials from the same place.
- e) Verify that the user has already received a copy of these materials or that you have already sent this user a copy.

For an executable, the required form of the “work that uses the Library” must include any data and utility programs needed for reproducing the executable from it. However, as a special exception, the materials to be distributed need not include anything that is normally distributed (in either source or binary form) with the major components (compiler, kernel, and so on) of the operating system on which the executable runs, unless that component itself accompanies the executable.

It may happen that this requirement contradicts the license restrictions of other proprietary libraries that do not normally accompany the operating system. Such a contradiction means you cannot use both them and the Library together in an executable that you distribute.

7. You may place library facilities that are a work based on the Library side-by-side in a single library together with other library facilities not covered by this License, and distribute such a combined library, provided that the separate distribution of the work based on the Library and of the other library facilities is otherwise permitted, and provided that you do these two things:
 - a) Accompany the combined library with a copy of the same work based on the Library, uncombined with any other library facilities. This must be distributed under the terms of the Sections above.
 - b) Give prominent notice with the combined library of the fact that part of it is a work based on the Library, and explaining where to find the accompanying uncombined form of the same work.
8. You may not copy, modify, sublicense, link with, or distribute the Library except as expressly provided under this License. Any attempt otherwise to copy, modify, sublicense, link with, or distribute the Library is void, and will automatically terminate your rights under this License. However, parties who have received copies, or rights, from you under this License will not have their licenses terminated so long as such parties remain in full compliance.
9. You are not required to accept this License, since you have not signed it. However, nothing else grants you permission to modify or distribute the Library or its derivative works. These actions are prohibited by law if you do not accept this License. Therefore, by modifying or distributing the Library (or any work based on the Library), you indicate your acceptance of this License to do so, and all its terms and conditions for copying, distributing or modifying the Library or works based on it.
10. Each time you redistribute the Library (or any work based on the Library), the recipient automatically receives a license from the original licensor to copy, distribute, link with or modify the Library subject to these terms and conditions. You may not impose any further restrictions on the recipients' exercise of the rights granted herein. You are not responsible for enforcing compliance by third parties with this License.
11. If, as a consequence of a court judgment or allegation of patent infringement or for any other reason (not limited to patent issues), conditions are imposed on you (whether by court order, agreement or otherwise) that contradict the conditions of this License, they do not excuse you from the conditions of this License. If you cannot distribute so as to satisfy simultaneously your obligations under this License and any other pertinent obligations, then as a consequence you may not distribute the Library at all. For example, if a patent license would not permit royalty-free redistribution of the Library by all those who receive copies directly or indirectly through you, then the only way you could satisfy both it and this License would be to refrain entirely from distribution of the Library.

If any portion of this section is held invalid or unenforceable under any particular circumstance, the balance of the section is intended to apply, and the section as a whole is intended to apply in other circumstances.

It is not the purpose of this section to induce you to infringe any patents or other property right claims or to contest validity of any such claims; this section has the sole purpose of protecting the integrity of the free software distribution system which is implemented by public license practices. Many people have made generous contributions to the wide range of software distributed through that system in reliance on consistent application of that system; it is up to the author/donor to decide if he or she is willing to distribute software through any other system and a licensee cannot impose that choice.

This section is intended to make thoroughly clear what is believed to be a consequence of the rest of this License.

- 12.If the distribution and/or use of the Library is restricted in certain countries either by patents or by copyrighted interfaces, the original copyright holder who places the Library under this License may add an explicit geographical distribution limitation excluding those countries, so that distribution is permitted only in or among countries not thus excluded. In such case, this License incorporates the limitation as if written in the body of this License.
- 13.The Free Software Foundation may publish revised and/or new versions of the Lesser General Public License from time to time. Such new versions will be similar in spirit to the present version, but may differ in detail to address new problems or concerns.

Each version is given a distinguishing version number. If the Library specifies a version number of this License which applies to it and “any later version”, you have the option of following the terms and conditions either of that version or of any later version published by the Free Software Foundation. If the Library does not specify a license version number, you may choose any version ever published by the Free Software Foundation.

- 14.If you wish to incorporate parts of the Library into other free programs whose distribution conditions are incompatible with these, write to the author to ask for permission. For software which is copyrighted by the Free Software Foundation, write to the Free Software Foundation; we sometimes make exceptions for this. Our decision will be guided by the two goals of preserving the free status of all derivatives of our free software and of promoting the sharing and reuse of software generally.

NO WARRANTY

- 15.BECAUSE THE LIBRARY IS LICENSED FREE OF CHARGE, THERE IS NO WARRANTY FOR THE LIBRARY, TO THE EXTENT PERMITTED BY APPLICABLE LAW. EXCEPT WHEN OTHERWISE STATED IN WRITING THE COPYRIGHT HOLDERS AND/OR OTHER PARTIES PROVIDE THE LIBRARY “AS IS” WITHOUT WARRANTY OF ANY KIND, EITHER EXPRESSED OR IMPLIED, INCLUDING, BUT NOT LIMITED TO, THE IMPLIED WARRANTIES OF MERCHANTABILITY AND FITNESS FOR A PARTICULAR PURPOSE. THE ENTIRE RISK AS TO THE QUALITY AND PERFORMANCE OF THE LIBRARY IS WITH YOU. SHOULD THE LIBRARY PROVE DEFECTIVE, YOU ASSUME THE COST OF ALL NECESSARY SERVICING, REPAIR OR CORRECTION.
- 16.IN NO EVENT UNLESS REQUIRED BY APPLICABLE LAW OR AGREED TO IN WRITING WILL ANY COPYRIGHT HOLDER, OR ANY OTHER PARTY WHO MAY MODIFY AND/OR REDISTRIBUTE THE LIBRARY AS PERMITTED ABOVE, BE LIABLE TO YOU FOR DAMAGES, INCLUDING ANY GENERAL, SPECIAL, INCIDENTAL OR CONSEQUENTIAL DAMAGES ARISING OUT OF THE USE OR INABILITY TO USE THE LIBRARY (INCLUDING BUT NOT LIMITED TO LOSS OF DATA OR DATA BEING RENDERED INACCURATE OR LOSSES SUSTAINED BY YOU OR THIRD PARTIES OR A FAILURE OF THE LIBRARY TO OPERATE WITH ANY OTHER SOFTWARE), EVEN IF SUCH HOLDER OR OTHER PARTY HAS BEEN ADVISED OF THE POSSIBILITY OF SUCH DAMAGES.

END OF TERMS AND CONDITIONS

How to Apply These Terms to Your New Libraries

If you develop a new library, and you want it to be of the greatest possible use to the public, we recommend making it free software that everyone can redistribute and change. You can do so by permitting redistribution under these terms (or, alternatively, under the terms of the ordinary General Public License).

To apply these terms, attach the following notices to the library. It is safest to attach them to the start of each source file to most effectively convey the exclusion of warranty; and each file should have at least the “copyright” line and a pointer to where the full notice is found.

```
one line to give the library's name and an idea of what it does.  
Copyright (C) year name of author
```

```
This library is free software; you can redistribute it and/or  
modify it under the terms of the GNU Lesser General Public  
License as published by the Free Software Foundation; either  
version 2.1 of the License, or (at your option) any later version.
```

```
This library is distributed in the hope that it will be useful,  
but WITHOUT ANY WARRANTY; without even the implied warranty of  
MERCHANTABILITY or FITNESS FOR A PARTICULAR PURPOSE. See the GNU  
Lesser General Public License for more details.
```

```
You should have received a copy of the GNU Lesser General Public  
License along with this library; if not, write to the Free Software  
Foundation, Inc., 51 Franklin Street, Fifth Floor, Boston, MA 02110-1301 USA
```

Also add information on how to contact you by electronic and paper mail.

You should also get your employer (if you work as a programmer) or your school, if any, to sign a “copyright disclaimer” for the library, if necessary. Here is a sample; alter the names:

```
Yoyodyne, Inc., hereby disclaims all copyright interest in  
the library 'Frob' (a library for tweaking knobs) written  
by James Random Hacker.
```

```
signature of Ty Coon, 1 April 1990  
Ty Coon, President of Vice
```

That's all there is to it!

CASIO®

CASIO COMPUTER CO., LTD.
6-2, Hon-machi 1-chome
Shibuya-ku, Tokyo 151-8543, Japan

MA1111-A

© 2012 CASIO COMPUTER CO., LTD.

Free Manuals Download Website

<http://myh66.com>

<http://usermanuals.us>

<http://www.somanuals.com>

<http://www.4manuals.cc>

<http://www.manual-lib.com>

<http://www.404manual.com>

<http://www.luxmanual.com>

<http://aubethermostatmanual.com>

Golf course search by state

<http://golfingnear.com>

Email search by domain

<http://emailbydomain.com>

Auto manuals search

<http://auto.somanuals.com>

TV manuals search

<http://tv.somanuals.com>