

# COBY®

## HIGH-RESOLUTION 5.1 CHANNEL DVD PLAYER

# USER'S GUIDE

MODEL NO. : DVD505



Please read carefully before operation

## Accessories included

Please verify that the following items are included within the DVD carton. If items are missing, please promptly return this unit to the retailer for an exchange

### Remote Control Unit

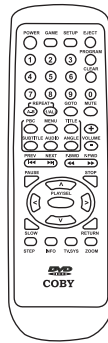

x1

### AAA Batteries

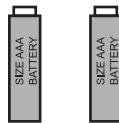

AAA [NM4]x2

### Video & Audio (L/R) Cable (three jacks)



x1

### User Manual

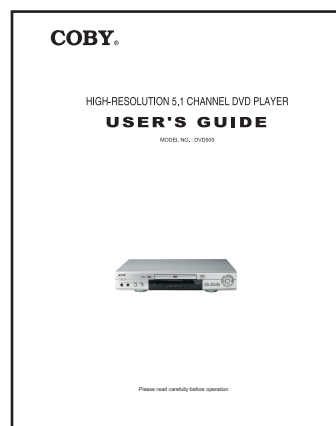

x1

## Dear Customers

May we take this opportunity to thank you for purchasing this DVD/VIDEO CD/CD player. We strongly recommend that you carefully study the operating instructions before attempting to operate the unit and that you note the listed precautions.

## Safety information

---

### ● Note:

This unit can be used only where the power supply is AC 110V/60Hz ~ AC 240V/50Hz .It cannot be used elsewhere.

### ● CAUTION:

1. DVD PLAYER IS A CLASS 1LASER PRODUCT:

HOWEVER THIS PLAYER USES A VISIBLE LASER BEAM WHICH COULD CAUSE HAZARDOUS RADIATION EXPOSURE IF DIRCETED. BE SURE TO OPERATE THE PLAYER CORRECTLY AS INSTRUCTED.

2. WHEN THIS PLAYER IS PLUGGED TO THE WALL OUTLET, DO NOT PACE YOUR EYES CLOSE TO THE OPENINGS TO LOOK INTO THE INSIDE OF THIS PLYER.

3. USE OF CONTROLS OR ADJUSTMENTS OTHER THAN THOSE SPECIFIED HEREIN MAY RESULT ON HAZARDOUS RADIATION RXPOSURE.

DO NOT OPEN COVER OR ATTEMPT TO REPAIR THIS PRODUCT BY YOURSELF. ALWAYS REFER SERVICING TO QUALIFIED PERSONNEL.

### ● WARNING:

1. TO REDUCE THE RISK OF FIRED OR ELECTRIC SHOCK, DO NOT EXPOSE THIS EQUIPMENT TO RAIN OR MOISTURE.
2. TO REDUCE THE RISK OF FIRE ELECTRIC SHOCK OR PICTURE & SOUND INTERFERENCE, USE THE RECOMMENDED ACCESSORIES ONLY.

Manufactured under license from Dolby Laboratories. "Dolby" and the double-D symbol are trademarks of Dolby laboratories, Confidential Unpublished Works, © 1992-1997 Dolby laboratories Inc. All rights reserved.

## Precaution

---

Please read these precautions before operating this unit.

### ● Power cord protection

To avoid a malfunction of this product and to protect against electric shock .fire or personal injury, please observe the following.

1. Hold the plug firmly when connecting or disconnecting the AC power supply to this unit.
2. Do not connect or disconnect the AC power supply when your hands are wet.
3. Keep the AC power cord away from heating appliances.
4. Never put heavy Objects on the power cord
5. Do not attempt to repair or reconstruct the power cord in any way.

### ● Placement

Avoid placing the unit in areas of:

1. Direct sunlight.
2. High temperature (over 35°C ) or high humidity (over 90%)
3. High levels of dust

The internal parts may be damaged as a result.

### ● Non-use Periods

When not in use, switch off the unit.

When left unused for a long period of time, the unit should be unplugged from the household AC supply.

### ● Foreign Objects

1. Touching internal parts of this unit is dangerous and may damage the player. Never attempt to disassemble the unit.
2. Do not put any foreign objects on the disc tray.

### ● Keep away from water / magnetic fields

1. Keep the unit away from flower vases, tubs, sinks, etc. if liquids are spilled into the unit , serious damage will occur.
2. Do not magnetic objects (such as speakers) close to this unit

### ● Stacking

1. Place the unit in a horizontal position. Do not place anything heavy on top of it.
2. DO not place the unit on amplifiers or other appliances which may generate heat.

### ● Condensation

Moisture may form on the lens in the following conditions:-

1. Immediately after a heater has been turned on.
2. In a steamy or very humid room.
3. When the unit is moved from a cold environment to a warm one .if moisture forms inside this unit, it may not operate properly. In this case, turn o the power and wait about one hour for the moisture to evaporate.

### ● If there is noise interference on your TV channels

Depending on the reception conditions of the broadcast, interference may appear on the TV while you are watching a channel with the DVD player on. This is not a malfunction of the unit or the TV. Should this occur, simply switch off the DVD player.

### IMPORTANT:

**AS SOON AS THE EQUIPMENT HAS BEEN CONNECTED, PLEASE REFER TO THE INITIAL SETTINGS CHAPTER AT PAGE 17.**

## Features

- **DVD: a completely new dimension in video entertainment**

1. Subtitles may be displayed in one of a maximum of 32 languages.
2. The audio soundtrack can be heard in up to 8 languages.
3. The multi-angle function allows you to choose the viewing angle of which scenes were shot from many different angles (limited to DVD discs recorded with multiple camera angles). The number of the languages recorded is dependent on the software.

- **High quality digital audio**

1. The Dolby Digital / MPEG2 audio/Linear PCM decoder is built into the player which makes it possible to enjoy Multi-channel surround sound.
2. With linear PCM sound of a 48 kHz/16 bit through 96 kHz/24 bit, audio quality exceeding that of Audio CD becomes possible.
3. The unit has a built-in MP3 audio file decoder

- **May convenient features**

1. Direct access of favorite scenes (title/chapter/time/track search).
2. Programming of up to 3 scenes in memory (marker) [DVD only]
3. Parental lock setting to prevent play of discs unsuitable for some audiences. [DVD only]

- **Compatible with PLA DVD/VCD and NTSC DVD/VCD**

1. This player can play discs recorded in either PAL or NTSC format however, the player must be connected to a Multi-system TV to play both PLA DVD/VCD and NTSC DVD/VCD.  
The use of Multi-system TV is recommended.

- **Compatible with video CDs (VCD) and audio CDs as well as DVD.**

Disc formats supported by this player

# MP3

CD recorded in MP3 file



DVD  
(8cm disc/12cm disc)



VCD  
(8cm disc/12cm disc)



CD  
(8cm disc/12cm disc)

## Selecting the type of disc compatible with your TV

Both DVD discs and Video CDs (VCDs) have material recorded in either PAL or NTSC format. Refer to the table below to select the disc type compatible with your TV.

The type of connected TV	Disc	TV Monitor
Multi-system	PAL	Played in the PAL system
	NTSC	Played in the NTSC system
NTSC	PAL	No clear images are showed on the screen
	NTSC	Played in the NTSC system
PAL	PAL	Played in the PAL system
	NTSC	No clear images are showed on the screen

## Table of contents

---

### Getting Started:

Safety information . . . . .	1
Features . . . . .	2
Selecting the type of disc compatible with your TV . . . . .	2
Table of contents . . . . .	3
Control reference guide . . . . .	4
Main unit . . . . .	4
Remote control unit . . . . .	4
Connection to TV & Audio Players(inc.Advanced Setup). 5	
Audio connections. . . . .	6
Digital audio connections. . . . .	7
Remote control preparation. . . . .	8
Connecting headphones . . . . .	8

### Basic operation:

Basic play. . . . .	9
Basic play. . . . .	9
Stopping play. . . . .	10
Prev/Next. . . . .	10
Fast FWD/RWD. . . . .	10
Pause/Step picture. . . . .	11
MENU and TITLE. . . . .	11
Changing SUBTITLE language. . . . .	12
Change audio soundtrack ANGLE. . . . .	12
Viewing from another ANGLE. . . . .	13
Control the VOLUME of voice. . . . .	13
On screen DISPLAY. . . . .	13
How to use CLEAR button. . . . .	14
PAL/NTSC Setting. . . . .	14
REPEAT. . . . .	14
RANDOM. . . . .	14
PROGRAM . . . . .	14
Repeat A-B. . . . .	15
GOTO function. . . . .	16
RETURN function . . . . .	16
ZOOM picture. . . . .	16
VOLUME CONTROL. . . . .	16
Playback of MP3 files. . . . .	16

### Initial setting

LANGUAGE SETUP. . . . .	17
SCREEN SETUP. . . . .	17
TV TYPE . . . . .	17
SCRN SAVER. . . . .	17
TV STSTEM. . . . .	17
BRIGHTNESS. . . . .	18
CONTRAST. . . . .	18
VIDEO OUT. . . . .	18
AUDIO SETUP. . . . .	18
OUTPUT. . . . .	18
DNR. . . . .	18
KARAOKE. . . . .	18
CUSTOM SETUP. . . . .	19
PARENTAL CONTROL. . . . .	19
CHNGEPASSWORD. . . . .	19
ANGLE MARK. . . . .	19
DEFAULT. . . . .	19

### For your reference:

Disc handing and maintenance. . . . .	20
Troubleshooting . . . . .	21
Definition of terms. . . . .	23
Specifications. . . . .	23

## Control reference guide

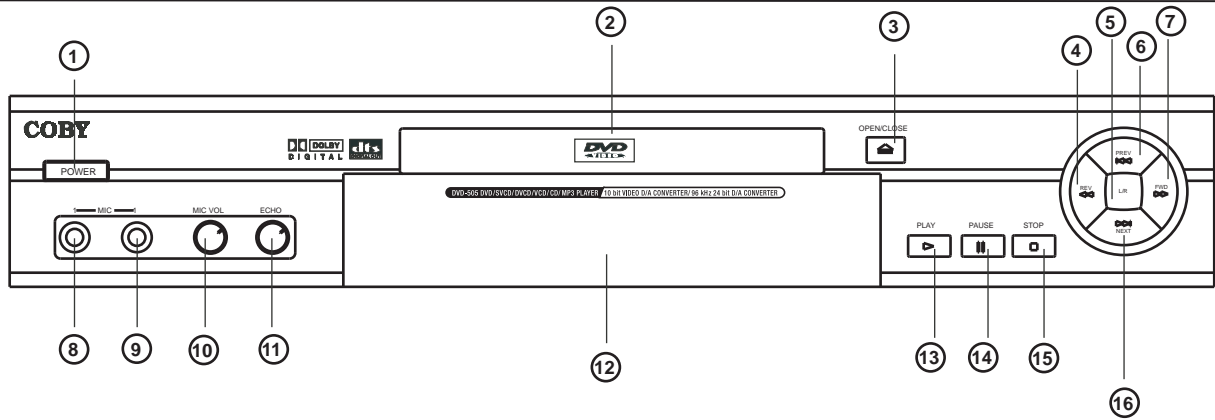

### Main unit

1. POWER ON/OFF
2. DISC TRAY
3. OPEN/CLOSE
4. FAST REWIND
5. CHANNEL SELECT
6. PREVIOUS TRACK
7. FAST FORWARD
8. MIC INPUT1
9. MIC INPUT 2
10. MIC VOL
11. MIC ECHO
12. VFD DISPLAY
13. PLAY
14. PAUSE
15. STOP
16. NEXT TRACK

### Remote control unit

1. POWER button
2. NUMERIC buttons
3. Repeat 1/ALL
4. Repeat A-B
5. MENU button
6. PBC buttons
7. SUBTITLE buttons
8. AUDIO button
9. SKIP button (◀▶)
10. PAUSE button
11. CURSOR buttons
12. SLOW button
13. STEP button
14. INFO buttons
15. GAME button
16. SETUP button
17. EJECT button
18. PROGRAM button
19. CLEAR button
20. GOTO button
21. MUTE button
22. TITLE button
23. VOLUME button
24. ANGLE button
25. FAST FORWARD/FAST BACKWARD button
26. STOP button
27. PLAY/SEL button
28. RETURN button
29. ZOOM button
30. TV.SYS button

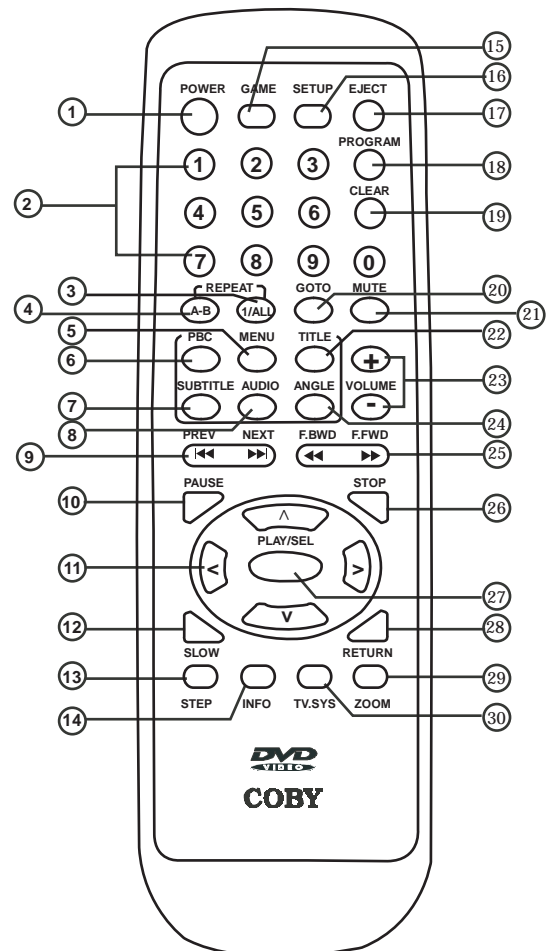

## Connection to TV and Audio players

- IMPORTANT! Ensure that ALL equipment to be connected is SWITCHED OFF before proceeding
- We also recommend that you consult with the connecting instructions of any equipment to be connected before you proceed.

### Connecting to Stereo TV (configuration [A])

1. TV set
2. DVD player
3. L/R (Front ) Audio Output
4. S-video Output (Video option 1 )
5. To Audio In on Stereo Amp
6. To S-video input connector on TV (Video option 1 )
7. Video In on TV (Video option 2)
8. Video Out on DVD (Video option 2)

#### S-video output connector

The S(separate) video output connector separates the color (C) and luminance (Y) signals before transmitting them to the TV set in order to achieve a sharper picture.

Use the S-video cord when connecting the player to a TV set equipped with an S-video input connector for optimum picture clarity.

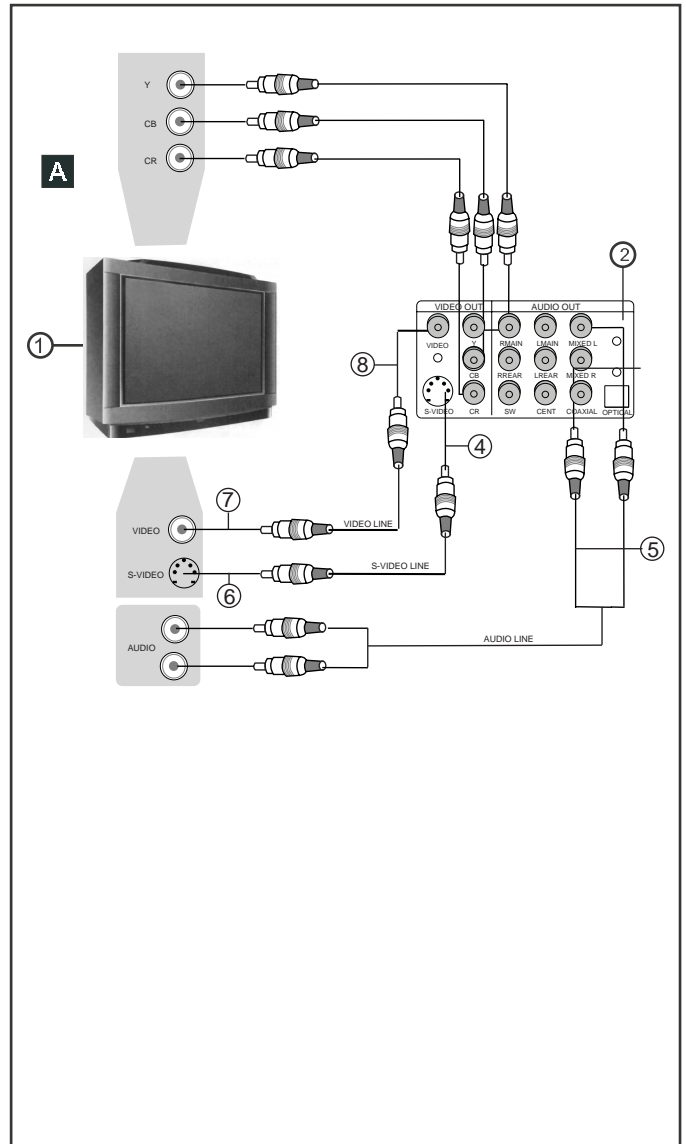

## Audio connections

### Connecting to a TV amplifier with 5.1ch input connector supporting Dolby Digital decoder

This player contains Dolby Digital decoder. This enables the playback of DVDs recorded in Dolby Digital surround without the need for an external decoder with Dolby Digital processing.

When the player is connected to an AV amplifier with 5.1ch input connectors you can enjoy cinema quality audio in your home when playing discs recorded Digital Surround Sound.

1. TV set
2. DVD/VCD/CD player
3. Video connector
4. Amplifier with 5.1ch input connector
5. Audio cords (optional)

- The surround speakers should be installed at an equal distance to (or further away from) the front speakers relative to the listening position.

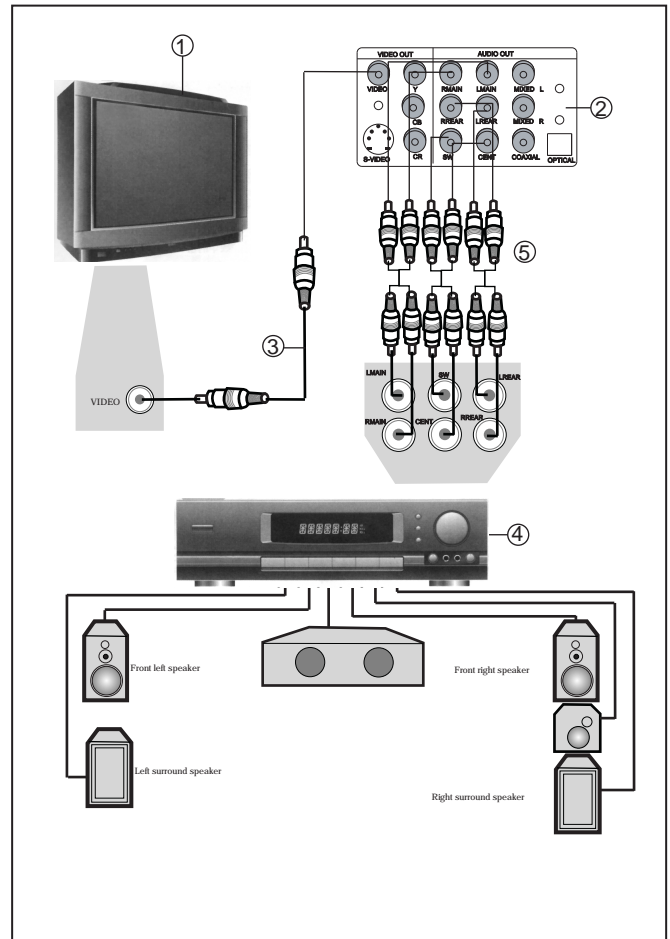



## Digital audio connections

### Connecting to a decoder with Dolby Digital processing or MPEG processing A

When DVDs recorded in Dolby Digital or MPEG audio are played, Dolby Digital bitstream or MPEG audio bitstream is sent to the player's OPTICAL digital audio output connector or COAXIAL digital audio output connector. When the player is connected to a Dolby Digital or MPEG audio decoder via one of these output sockets, you can enjoy theater quality audio in your home. An optical digital cable or coaxial audio cable (both optional) is required when a Dolby Digital decoder or MPEG audio decoder is used.

#### Audio output from the optical/coaxial digital audio output connectors:

Disc	Sound recording format	Optical/coaxial digital audio output from connector
DVD	Dolby Digital	Dolby Digital bitstream(2-5.1ch) or PCM(2ch)(48kHz/16bit)
	Linear PCM (48/96 kHz 16/20/24 bit)	Linear PCM(2ch) (48/kHz sampling/16 bit only) <sup>2</sup> or no output <sup>1</sup>
	MPEG 1 MPEG2	MPEG2 audio bitstream or PCM(2ch)(16 bit) <sup>1</sup>
VCD	MPEG1	PCM (44.1kHz sampling)
CD	Linear PCM	Linear PCM (44.1kHz sampling)

\*1. The type of audio output from the connector can be selected by the initial settings.

\*2. Audio having 96kHz sampling is converted into 48kHz sampling when it is output from the player's optical/coaxial digital audio output connector.

#### For your reference :

- Dolby Digital is a digital sound compression technique developed by the Dolby Laboratories Licensing Corporation. Supporting 5.1-channel surround sound, as well as stereo (2-channel) sound, this technique enables a large quantity of sound data to be efficiently recorded on a disc.

- Linear PCM is a signal recording format used in CDs. While CDs are recorded in 44.1 kHz/16 bit, DVDs are recorded in 48kHz/16 bit up to 96kHz/24 bit .

- If you have a Dolby Pro Logic Surround decoder, you will obtain the full benefit of Pro Logic from the same DVD movies that provide full 5.1 channel Dolby Digital soundtracks, as well as from titles with the Dolby Surround mark.

#### Caution for the optical/coaxial digital audio output connector:

- Do not connect an amplifier (with an optical/coaxial digital input connector) which does not contain the Dolby Digital or MPEG audio decoder.
- An attempt to play DVDs through an amplifier without the correct or MPEG decoder, may produce extreme levels of noise. This could damage both your ears & your loudspeakers.
- VCD and Audio CDs can be played as normal.

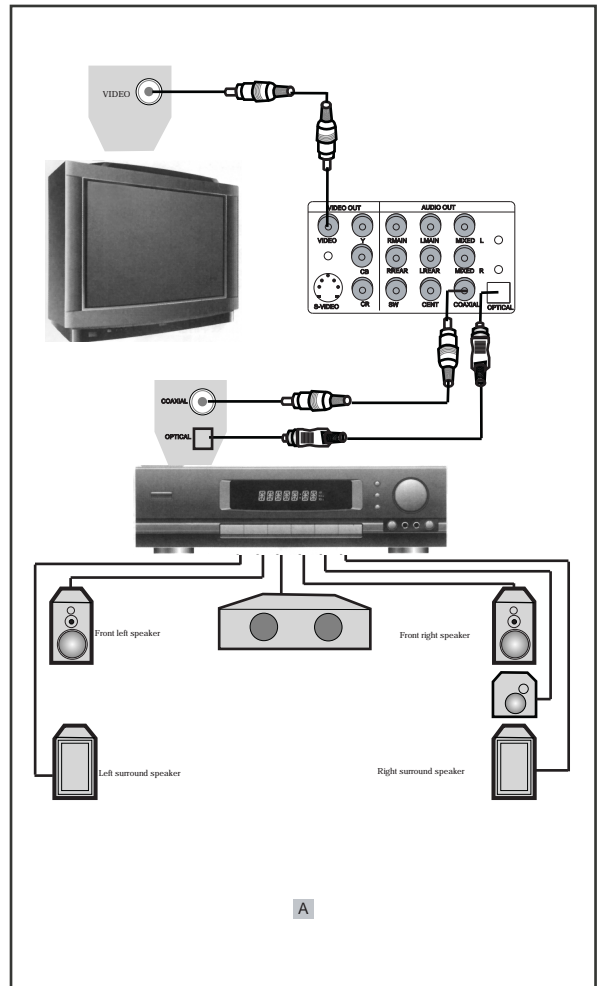

## Remote control preparation

A

Insert the batteries while observing the correct (+) and (-) polarities as illustrated.

Service life of batteries

- The batteries normally last for about one year although this depends on how often and for what operations the remote control is used.
- If the remote control unit fails to work even when it is operated near the player, replace the batteries.
- Use 2\*AAA' type batteries.

Notes:

- Do not use rechargeable (Ni-cd) batteries.
- Do not attempt to recharge, short-circuit or disassemble batteries. Never place batteries close to a heat source such as radiators or heaters.
- Dispose of batteries in a responsible manner. Never throw batteries on a fire.
- Do not drop or step on the remote control unit. This may damage the parts or lead to malfunction.
- Do not mix old and new batteries.
- If the remote control unit is not going to be used for long time, always remove the batteries to prevent leakage.

### Remote control operation range ( B )

Point the remote control unit no more than about 7 m from the remote control sensor and within 60° from the front of the unit.

- The operating distance may vary according to the brightness of the room.

Notes:

- Do not point bright lights at the remote control sensor.
- Do not place objects between the remote control unit and the remote control sensor.
- Do not use this remote control unit while simultaneously operating the remote control unit of any other equipment.

### Before enjoying DVD/Video CD/CD

The On-Screen menu language of your player has been factory pre-set to English. There is another available OSD language selected.

### Playing Audio CD's

- Press the Power button then the OPEN/CLOSE button to open the CD drawer. Place the audio CD on the tray with the label facing up. Press the OPEN/CLOSE button once again to close the CD drawer.
- The player will read the disc contents and automatically play.
- To view the CD information such as track number and track time on the TV (OSD), press the STOP button twice on the remote control. Press the ENTER button again to play.
- You should use PREV/NEXT to choose next or previous song, also you could use number key to select song directly.

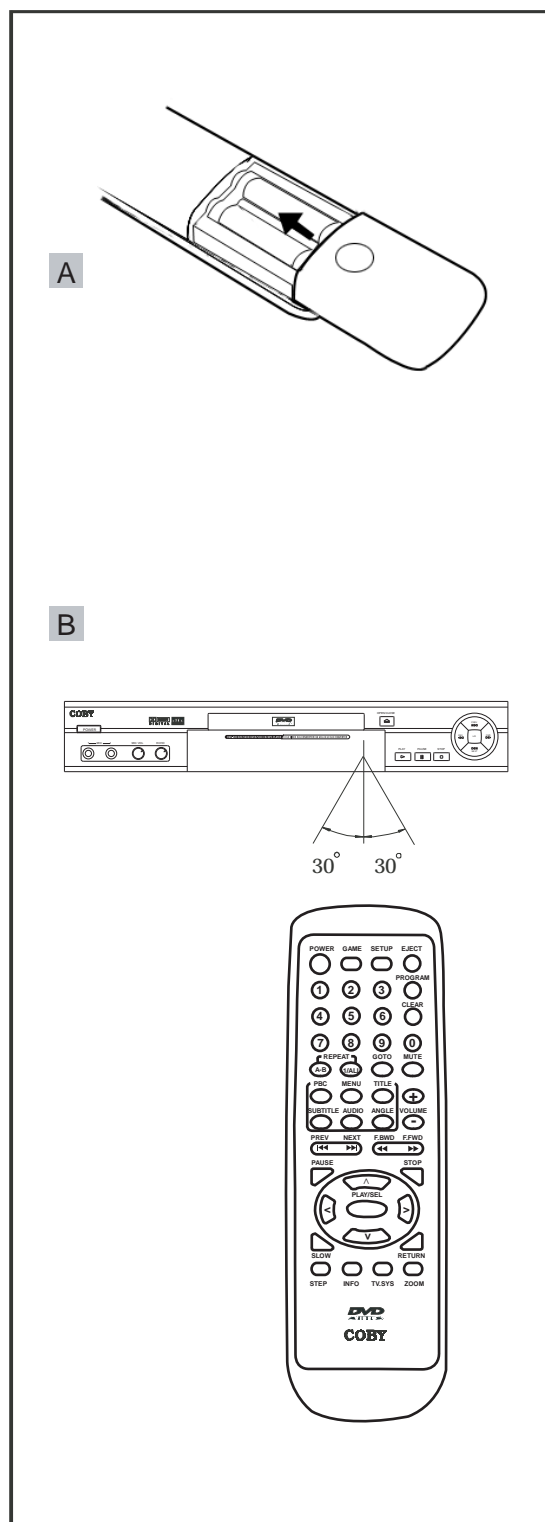

## Basic operation

### Preparations

- Switch the on the TV and select "Video" as the input source.
- Switch on the stereo system if the player has been connected to a stereo audio amplifier.

### Basic play

1. Press POWER by the main unit to switch on the power.
2. Press OPEN/CLOSE by the main unit or EJECT on the remote control unit to open the disc tray.



3. Place a disc onto the disc tray.  
Hold the disc without touching either of its surfaces, position it with the printed side facing up, align it with the guides and place it on the disc tray.
  - (1) 8cm disc
  - (2) 12cm disc

4. Press the OPEN/CLOSE button again or PLAY on the main unit or remote control will close the disc tray and display:



The player will automatically play.

When a menu screen appears on the TV monitor:-

In case of interactive DVDs or VCDs with playback control, a menu screen appears on the TV. With DVDs, you can use CURSOR to select which item you want to enjoy and press ENTER. With VCDs, you will need to press the NUMERIC key, then press ENTER.

- Press POWER button on the front panel or remote control to switch the unit from ON to STANDBY mode (or vice versa). In standby mode, the unit is still consuming a small amount of power.

### Note:

- The disc continues to rotate while the menu is displayed even after the player has finished playing a particular item. When no further selections are to be played, be sure to press the STOP button to clear the menu display.
- If the disc is placed in the tray upside down (and it is a single sided disc), the DVD display will indicate "NO DISC".

### For your reference:

When appears while a button is being operated, it means that the corresponding operation is prohibited by the player or the disc.

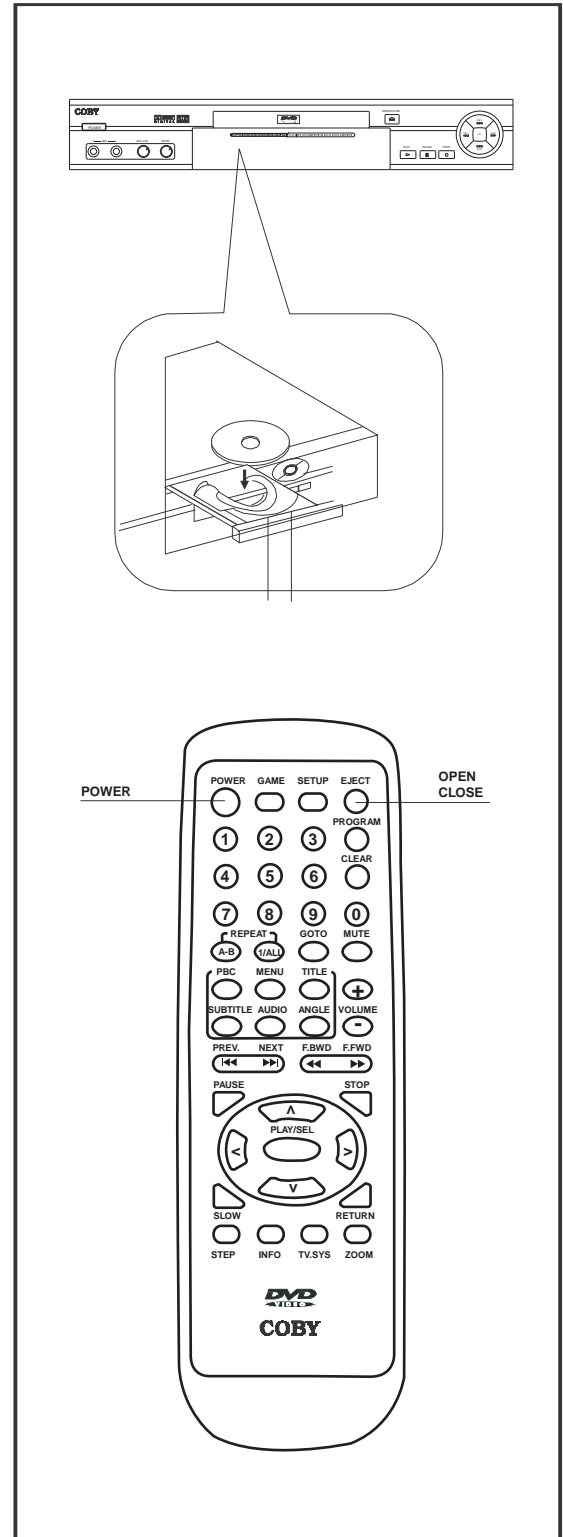

## Stopping play

Press STOP

For you convenience;

Memory Stop DVDs and VCDs (without PBC), can utilize a function called Memory Stop. This allows you to temporarily stop a movie and restart it from the same point later. While playing a disc, pressing STOP once will set the player into Memory Stop mode. At this point, pressing PLAY re-starts the movie from the same point. Pressing STOP a second time will stop the disc completely (i.e. the Stop Memory is lost). Note that some DVD discs will not allow the use of Memory Stop.

## PREV/NEXT

### NEXT

press NEXT during play.

A chapter (DVD) or a track (VCD / CD) is skipped each time the button is pressed.

### PREV

Press PREV during play.

When the button is pressed once midway through a chapter/track, play returns to the start of that chapter/track. When it is pressed again, a chapter/track is skipped each time the button is pressed.

For your reference:

- When PREV/NEXT is pressed during menu play of VCD, a menu screen may sometimes be recalled

## Fast FWD/BWD

Using either the Remote Control or the Front Panel controls, press FAST FWD(▶▶)or FAST BWD(◀◀)during play.

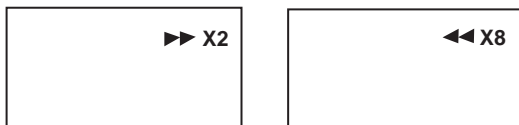

For you reference:

Press FAST FWD or FAST RWD button once, the disc will be played forward or backward at double (x 2) speed. With each subsequent press, the disc will be played back at x4, x8, x16 or x32 speed and PLAY. Press PLAY button to return to normal play.

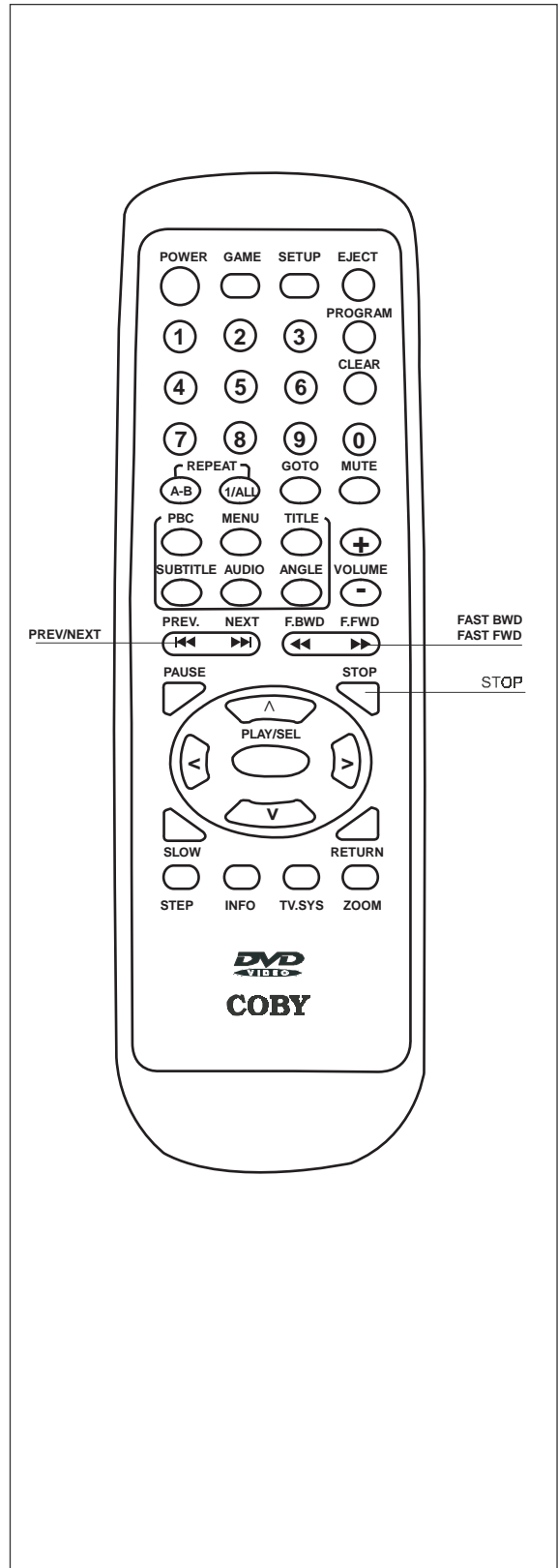

## Pause picture

Press PAUSE during play

### For your reference:

- When playing, pressing the PAUSE button pause playback. Press the PAUSE button again to enter step status. The picture will go ahead frame by frame. To return to normal play, press the PLAY button.

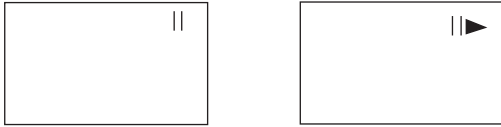

## Step picture

Press STEP during play

### For your reference:

- When playing, pressing the STEP button step playback. Press PLAY button to return to normal play.

## SLOW PLAY

Press SLOW button when playing, you can play the disc at 1/2, 1/4, 1/8, 1/16, 1/32 of normal speed. If you want stop it, you can press PLAY button to play normally again.

## MENU and TITLE

Press MENU or TITLE by the remote control unit

- DVD discs usually are divided into several titles and subdivided into chapters. VCD / CD discs are divided into tracks.
- Press TITLE on the remote and the disc playing will automatically return to the title program. Press the CURSOR buttons on the remote to select the option, then press ENTER button to play it. Note it is possible that some DVD discs will not have this function
- Press MENU button on the remote, the disc playing will automatically return to the chapter menu. Press CURSOR buttons on the controller to select chapter and then press the ENTER button to play,
- For and VCD with PBC, pressing MENU will turn the PBC function off. Pressing MENU again turns the PBC back on.

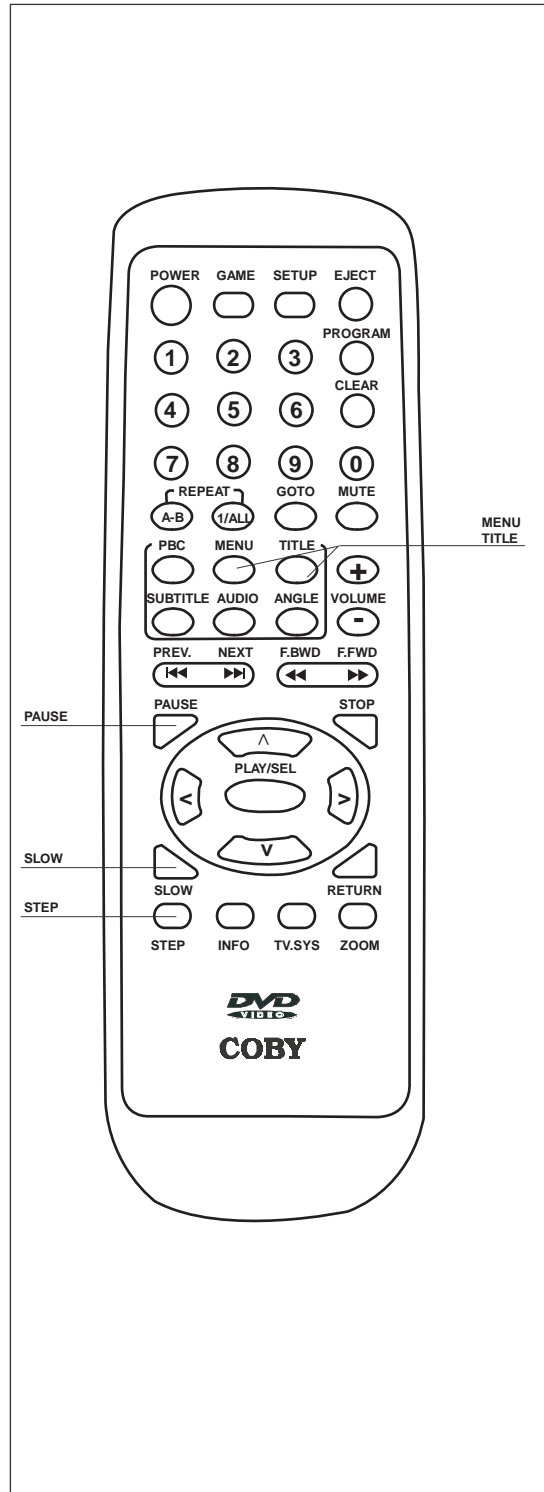

## Changing SUBTITLE language [DVDs only]

- it is possible to change the subtitle language from the one selected, if available This operation works only with discs on which multiple subtitle languages have been recorded).
- Press the SUBTITLE button on the remote. The alternative language subtitle will appear wffh each press, <SUBTILE 1>, <SUBTILE 2>, (The different disc have different display.)

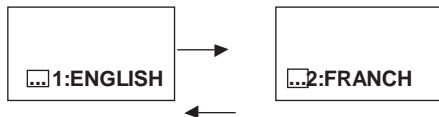

- When no subtitles are recorded, " " will be displayed on the TV screen

### For your reference:

- If the power is reset or the disc is removed, subtitles will appear in the default language set by the DVD player. If this language is not recorded on the disc, they will appear in the disc's default language.

## Changing the audio soundtrack language

- It is possible to change the audio soundtrack language from the default standard to another, if available. This operation works only with discs on which different audio soundtrack languages are recorded.

### ■ DVD:

Some DVDs have multi-audio output function. Pressing the AUDIO button on the controller repeatedly selects the available audio tracks.

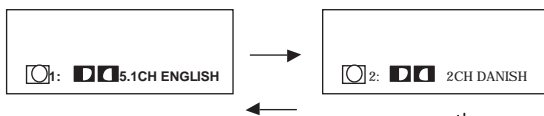

When no audio soundtrack language are recorded, " " will be displayed on the TV screen.

### ■ VCD,CD, MP3:

For VCD pressing the AUDIO button on the controller repeatedly selects the available audio tracks.

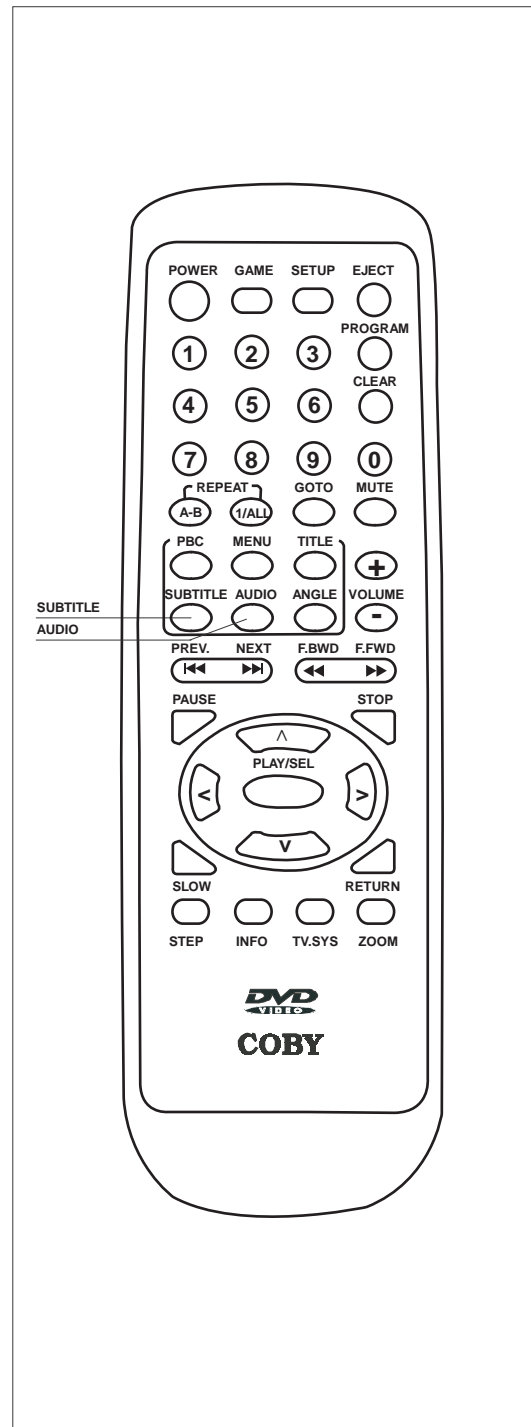
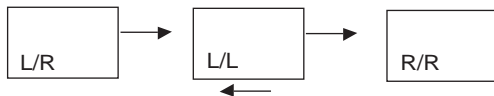

## Viewing from another ANGLE [DVDs only]

- Some DVDs may contain scenes that have been shot simultaneously from a number of different angles. For these discs, the same scene can be viewed from each of these different angles using the ANGLE button. The recorded angles will differ depending on the disc being played.
- When playing a DVD with multi-angle viewing, " / " will appear on the screen. For example, if the disc has two angles available, pressing the ANGLE button on the controller will step you through all available views. The screen OSD will show 1/3 then 2/3 then 3/3 and then back to 1/3 again etc.

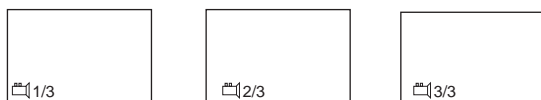

- When no multi-angle are recorded, " " will be displayed on the TV screen.

## On screen DISPLAY

During playback, you can press the INFO button on the remote to show the various information available.

- For DVDs, the INFO function button will allow you to view: Press INFO on the remote once, you will see three lines on the 'IV screen: At the first line they are disc type, subtitle and audio playing from left to right; at the second line it is playing time; at third line they are TITLE and CHAPTER playing,

Press INFO twice, you will see more information on the TV screen: At the first line are TITLE and CHAPTER (numbers of playing/total); at the second line it is playing time; at the third line the output TV format of DVD and AUDIO (numbers of playing/total); at the fourth line the SUBTITLE and ANGLE (numbers of playing/total); at the fifth line it is output audio format.

Press the INFO button to no display and cancel this function.

- For VCD & CD discs, the DISPLAY functions allows you to view on the screen: at the first line is disc type and track(numbers of playing/total); at the second line is playing time; at the third line is output TV format.

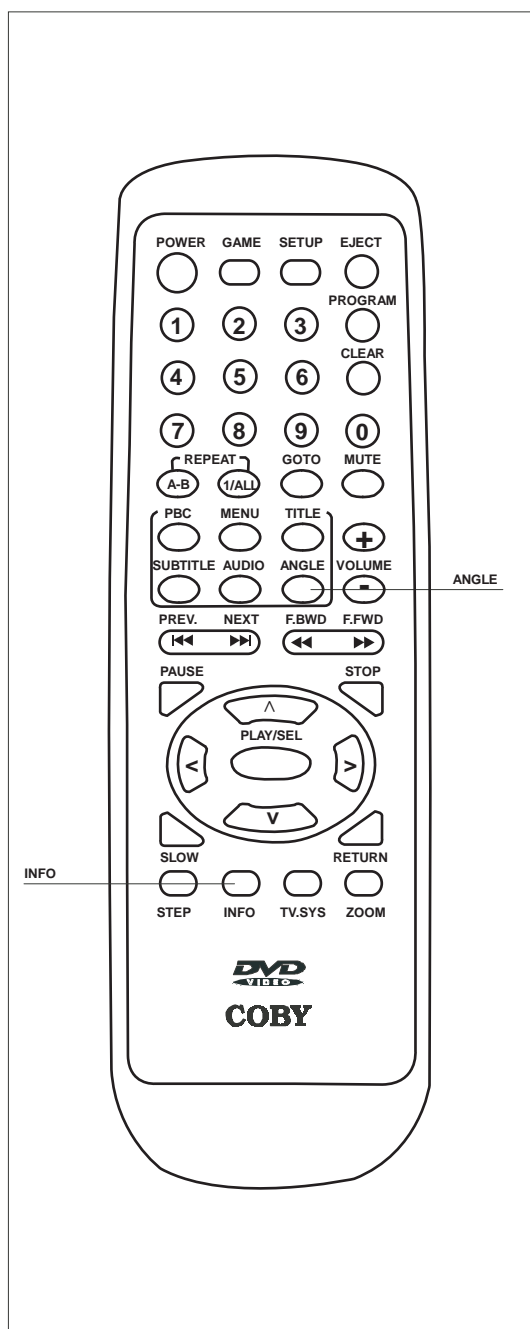

## How to use CLEAR button

■ If you enter a wrong number in selecting a track, title, or passwords etc, you can press CLEAR to delete the number you have entered.

## TV.SYS setting

■ This function is TV TYPE If you press this button it will allow you to select three TV types:



## REPEAT

If you play a DVD disc, the screen will display:

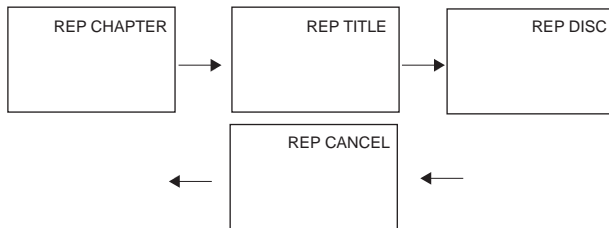

If you play a VCD(PBD OFF) or CD disc, the screen will display:



## Program

To the VCD & CD, if you want to play songs such as 5, 6, 3, etc, press PROGRAM button on the remote, and then number key 5, 6, 3, you'll see on the TV screen like:

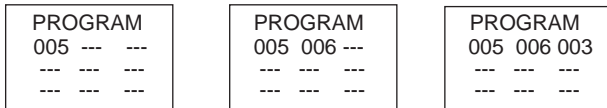

etc.

Up to 9 tracks can be programmed, and at last press ENTER to start program play,

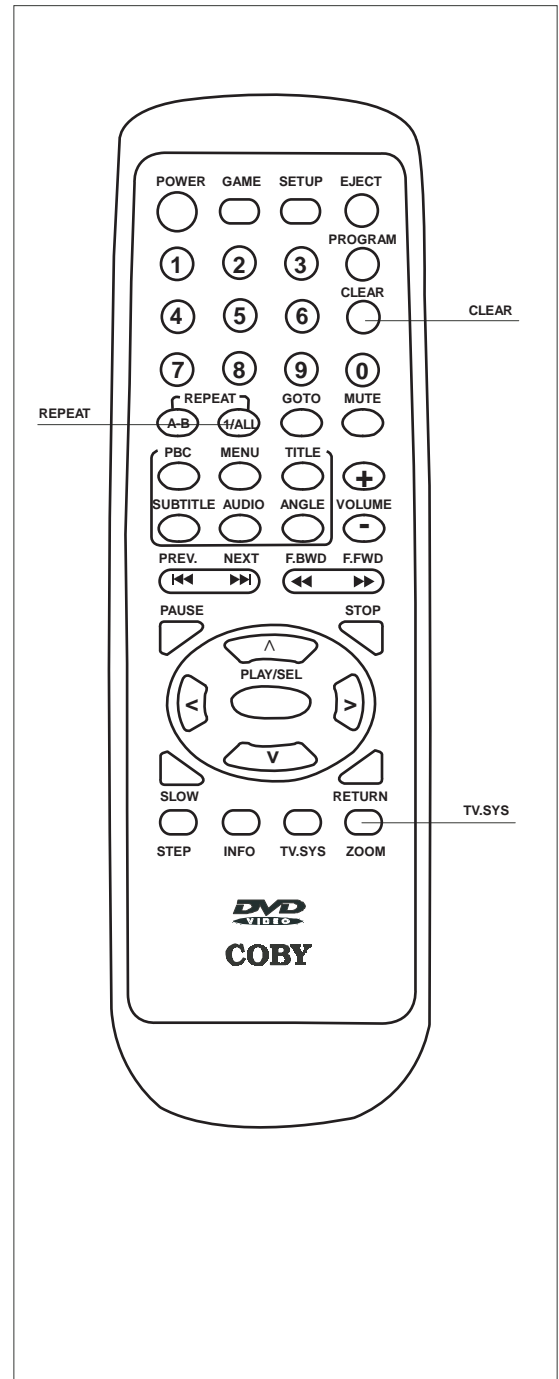



## Repeat A-B (allows you to play a small section of the disc repeatedly)

- press the A-B button on the remote at the point where you wish the repeat play to start. The display will show REP A. Press A-B button again at the point where you wish the repeat play to finish. The display will show REP A-B. The A-B segment will now repeat continuously until the A-B button is pressed for a third time.



## GOTO function

You may directly enter a time, title or chapter number to search fast on a disc, the player plays from that point.

- For DVD discs, press GOTO button on the remote, the display will show the following:

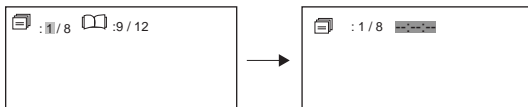

1.GO to a title or a chapter. For example, to chapter 6 in title 2.

- Press GOTO on the remote, the screen shows:



- Press the CURSOR (left or right) button and move. The cursor to illuminate the title number. Press button 2 to select title 2, the screen shows:



Repeat the steps above, select chapter 6, and then press ENTER to selected point.

### 2. TIME SEARCH

- Press GOTO button twice on the remote until the screen shows:

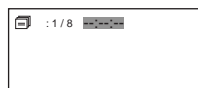

- Press number buttons to enter hour, minute and second. For example, enter 1,2,2,2,2.then press ENTER, After setting, the disc is played from 1:22:22

NOTE: some DVD disc will not TIME SEARCH.

- For VCD(PBC off status) & CD discs, press GOTO button on the controller, the following will be displayed: -



For the GOTO option, enter the digits on the remote for the required start time, Press ENTER button to start playback.

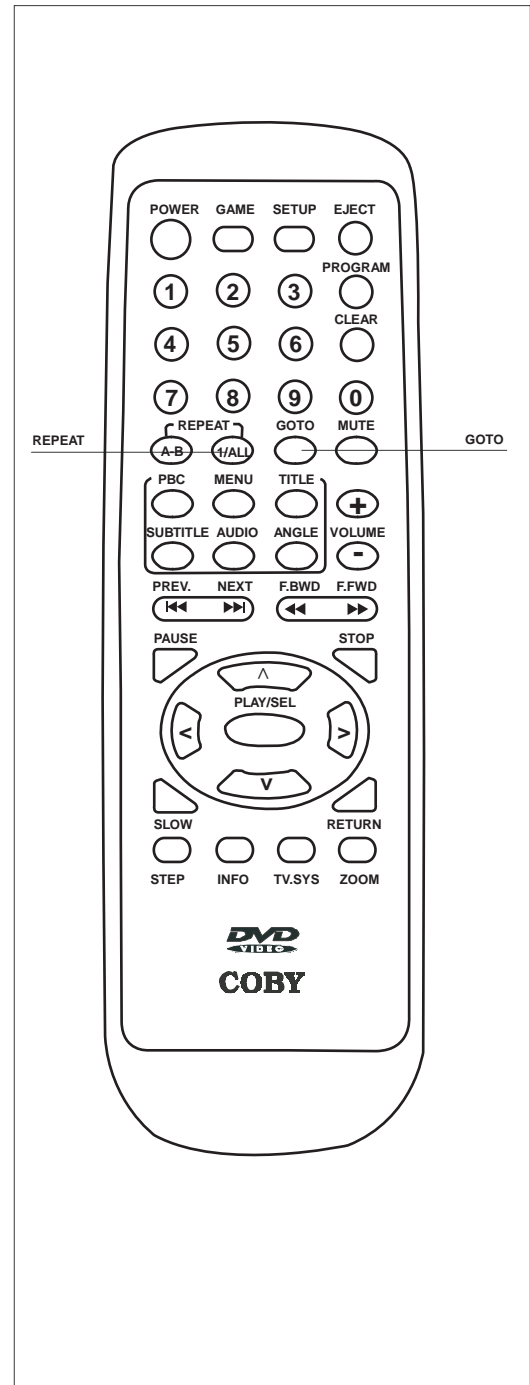

## RETURN function

- For Video CD with PBC and multiple menus, press RETURN button on the controller, playback will return to the previous menu automatically.

## ZOOM picture

- Depending on the disc being played, you can press the ZOOM button repeatedly allowing the picture to increase accordingly: ZOOM1.5, ZOOM2 and ZOOM OFF,

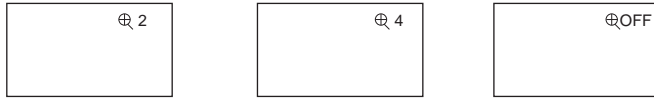

- In the ZOOM mode, you can use CURSOR buttons to move the picture for optimum viewing.

## VOLUME control

- Press VOLUME + on the controller continuously to increase volume. Press VOLUME - continuously to decrease volume.

**Note:** This is the line level output to TV or connected Amplifier

## Playback of MP3 Files

This unit is compatible for the reproduction of recorded pieces in MP3 format. Refer to the following instructions for a correct use:

- 1) Press the Power button and then the OPEN/CLOSE button to open the drawer. Insert the disc containing the recorded passages in MP3 format with the label facing upwards. Press the OPEN/CLOSE button again to close the drawer. After some seconds, on the TV screen will appear **MP3 LIST** menu
- 2) In this menu, the first line is current page/total pages of current directory; the second line is current directory name and the numbers current directory/total directories; the third line is the number of current song/total songs of disc and time of current song; next five lines are the name of 10 songs.
- 3) Press the CURSOR button you can move the highlight to the song you want and press ENTER to play it. You can use UP and DOWN CURSOR to gate previous or next page You can also press PREV/NEXT button to play the previous or next song.
- 4) Another way to select songs is acting directly on the numerical keyboard of the remote control. Input number and press play button.
- 5) Press RETURN button you can gate **MP3 FOLDER** menu. In this menu, the first line is current page/total page of the folders; the second line is the song's number of the disc; next five lines is the name of the folder, you can operate it as at MP3 LIST menu. If you select one folder you may enter **MP3 LIST** menu.

### NOTE:

Some button could not be used when playing MP3 disc, they are FAST BWD, FAST FWD, MENU, GOTO, SLOW, TITLE, A-B, PROGRAM, DISPLAY etc.

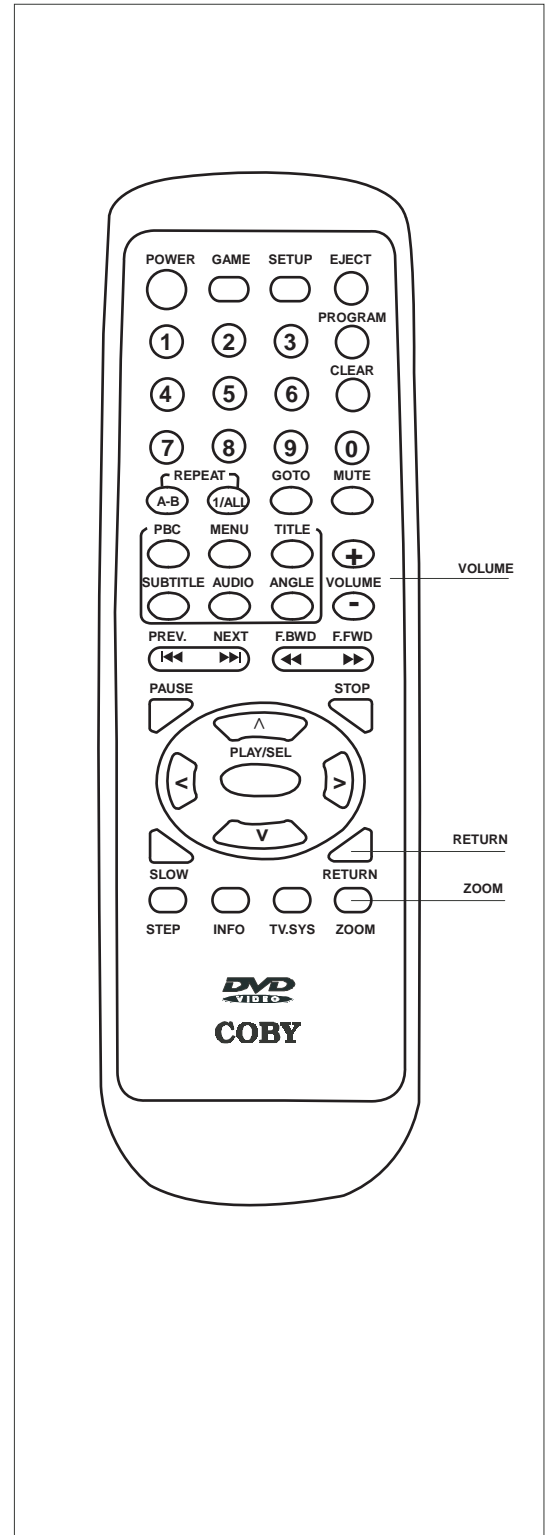

## Initial settings

Once the initial setting have been set, the player will always operate with the same parameters. The setting will be retained in the memory even after switching off the power.

- Initial settings must be in the setup mode, but function can be set in all mode.
- Using the setup menu, you may choose the play mode setting, the various outputs, etc.
- During STOP or PLAY mode, press SETUP button on the remote, you will see on the screen like picture 1. In the PLAY mode or different disc some item could not be choosed.
- Select the menu item desired by using up/down CURSOR button, and then press the ENTER button. You should see such as picture 2. In each menu page, the menu items are showed on the left. Use the right CURSOR button on the remote to the option list or setting on the right. Use the left CURSOR button to go back to the left menu item.
- Press the button SETUP to leave the setup menu and return to the TV DISPLAY.

### NOTE:

When you select the function on the Menu, the notation of the function is showed at left bottom.

### LANGUAGE SETUP

Press SETUP on the remote control, the screen shows SETUP MENU-MAIN PAGE. Press LANGUAGE SETUP to select OSD, MENU, AUDIO, SUBTITLE setup menu(picture 2). If you choose one language, the OSD, MENU, AUDIO, SUBTITLE's language will be this one first. If the disc has not it, the DVD player will use default language of the disc.

### SCREEN SETUP

TV TYPE(picture 3)

- 4:3 PS~4X3 Pan Scan

Choose this setting you will see the movie fill the entire screen of your TV, But you won't see part of the picture (particularly the right and left edge).



- 4:3 LB--4x3 Letterbox

Choose this setting if you want to see movies in their original aspect ratio. You will see the entire frame of the movie, but it will occupy a smaller portion of the screen.



- 16:9 --16x9 Wide screen

Choose this setting if your DVD player is connected to a widescreen TV.



### SCRN SAVER (picture 4)

You can choose turn on or off the screen saver.

### TV SYSTEM (picture 5)

According to the system of TV to be connected, set the type of the video output to match the TV:

1. If the TV used is PAL, select PAL output signal;
2. If it is NTSC, select NTSC output signal;
3. Or select AUTO if TV is multi-system

### Note:

To obtain the best DVD picture, it is strongly recommended to use Multi-system TV to play DVD movie at 'Auto' mode

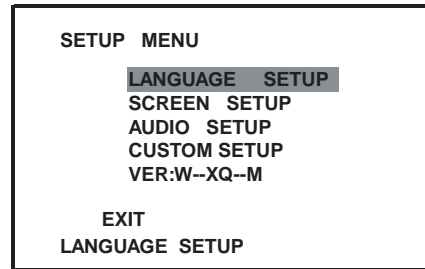

PICTURE 1

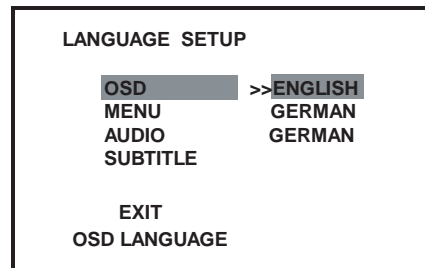

PICTURE 2

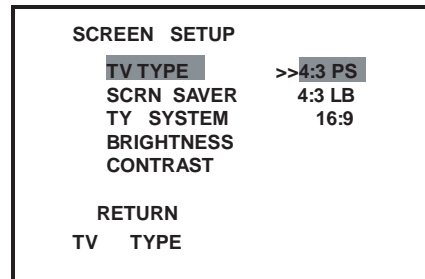

PICTURE 3

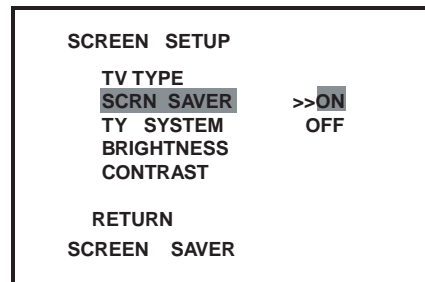

PICTURE 4

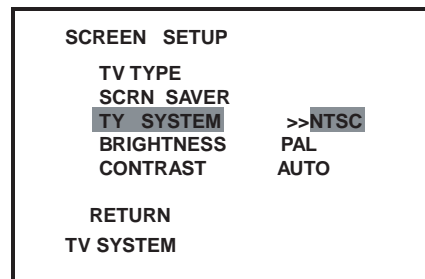

Picture 5

### BRIGHTNESS (picture 6)

You can choose the brightness of the video output.

### CONTRAST (picture 7)

You can choose the contrast of the video output. 0 is normal.

## AUDIO SETUP

### OUTPUT (picture 8)

**2 CH** : the output signal is Analogue 2 ch format. You should select this when you are playing the disc through the AUDIO OUT Right & Left jacks on your DVD player. In this format CENTRE, REAR and SUBWOOFER will not be heard.

**5.1 CH**: the output signal is ANALIGUE 5.1 CH format. When you play a disc with Dolby Digital, you should choose this in this format, you can turn CENTRE, REAR and SUBWOOFER on or off.

**SPDIF/RAW**: select this when the DVD player is connected with a power amplifier though DIGITAL OUT coaxial or optical port. The power amplifier to be connected must have Dolby Digital decoding.

**SPDIF/PCM**: Select this when the DVD player is connected with a 2-CHANNEL DIGITAL MODE OR STEREO AMPLIFIER. When a Dolby Digital or MPEG disc is played, the coaxial port will output in PCM 2-channel format. These program features an uncompressed digital stereo sound track for improved fidelity, when played, discrete stereo sound will be heard from the front right and left speakers.

### KARAOKE (picture 9)

Press CURSOR button on the remote to select KARAOKE, you can choose turn off KARAOKE (select OFF item),or turn on KARAOKE (select KARAOLE item).If you turn on KARAOKE function, insert MIC1 MIC2 and adjust MIC VOLUME or MIC ECHO button on the front panel, you can enjoy yourself now.

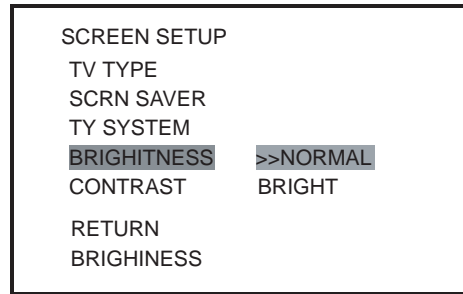

PICTURE 6

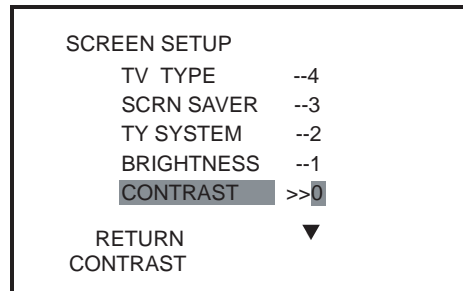

PICTURE 7

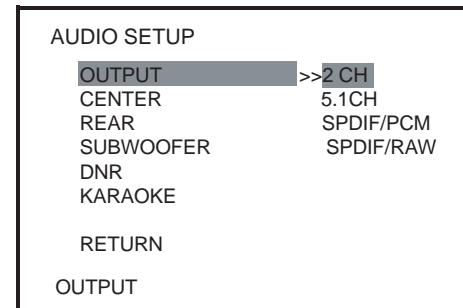

PICTURE 8

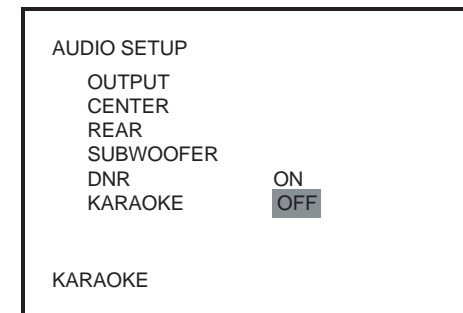

PICTURE 9

## CUSTOM SETUP

### PARENTAL CONTROL (picture 10)

When selecting PARENTAL CONTL items, the screen will be changed to the PASSWORD INPUT page. Input the correct password, you will enter PARENTAL CHANGE page (picture 11). When playing

disc with parent lock function, you may select an age control grade according to grade of disc and your desired. For example: Select PG13, and then you cannot play DVD video disc rate higher the PG13 grade. Parental control grades are listed from low to high, 1 is lowest grade adults is the highest grade.

INPUT PASSWORD  
THEN PRESS ENTER

— — — —  
CANCEL: RETURN KEY

### CUSTOM SETUP

PARENTAL CONTL8  
CHANGE PASSWORD  
ANGLE MARK  
DEFAULT

RETURN

PARENTAL CONTROL

PICTURE 10

### CHANGE PASSWORD (the default password is 8888) (picture 12)

Select CHANGE PASSWORD item, you will see picture like right, you enter old password first and press ENTER, and then you will see another picture, input new password and press ENTER. Now you change the password.

INPUT PASSWORD  
THEN PRESS ENTER

— — — —  
CANCEL: RETURN KEY

### CUSTOM SETUP

LEVEL >>3: PG  
4: PG13  
RETURN 5  
6: R  
7: NC17  
8

LEVEL

PICTURE 11

### Notes:

The original password is 8888 when the unit is first time turned on.

INPUT NEW PASSWORD  
WITH NUMBERS

— — — —  
CANCEL: RETURN KEY

### CUSTOM SETUP

PARENTAL CONTL8  
CHANGE PASSWORD  
ANGLE MARK >> ON  
DEFAULT OFF

RETURN

ANGLE MARK DISPLAY

PICTURE 12

### ANGLE MARK (picture 12)

You can choose display ANGLE character or not.

### DEFAULT (picture 13)

If you select the READ, each function setting returns to the initial status setting by the factory.

### CUSTOM SETUP

PARENTAL CONTL8  
CHANGE PASSWORD  
ANGLE MARK  
DEFAULT >> READ

RETURN

DEFAULT VALUE

PICTURE 13

## For Your Reference:

### Disc handling and maintenance

#### Handling precautions

- Hold the disc by the edges so the surface will not soiled with fingerprints. (A)
- Fingerprints, dirt and scratches can cause skipping and distortion.
- Do not write on the label side with a ballpoint pen or other writing utensils
- Do not use record cleaning sprays, benzine, thinner, static electricity prevention liquids or any other solvent.
- Be careful not to drop or bend the disc.
- Do not install more than 1 disc on the disc tray.
- Do not try to close the disc tray when the disc is not installed properly. (B)
- Be sure to store the disc in its exclusive case when not in use .

#### If the surface is soiled ( C )

Wipe gently with a soft, damp (water only ) cloth.

When wiping discs, always move the cloth from the center hole toward the outer edge.

(if the wipe the discs using a circular motion, circular scratches are likely to occur, which will cause noise.)

If the disc is brought from a cold to a warm environment, moisture may form on the disc.

Wipe this moisture off with a soft, dry, lint-free cloth before using the disc.

#### Improper disc storage

- You can damage discs if you store them in the following places:
- Areas exposed to direct sunlight
- Humid or dusty areas
- Areas directly exposed to a heat outlet or heating appliance

- Do not try to play Photo CD best

#### Maintenance

- Be sure to turn the unit off and disconnect the AC power cord before maintaining the unit.
- Wipe this unit with a dry soft cloth.
- If the surfaces are extremely dirty, wipe clean with a cloth, which has been dipped in a weak soap-and-water solution and wrung out thoroughly. Then wipe again with a dry cloth.
- Never use alcohol, benzine, thinner, cleaning fluid or other chemicals.
- Do not use compressed air to remove dust.

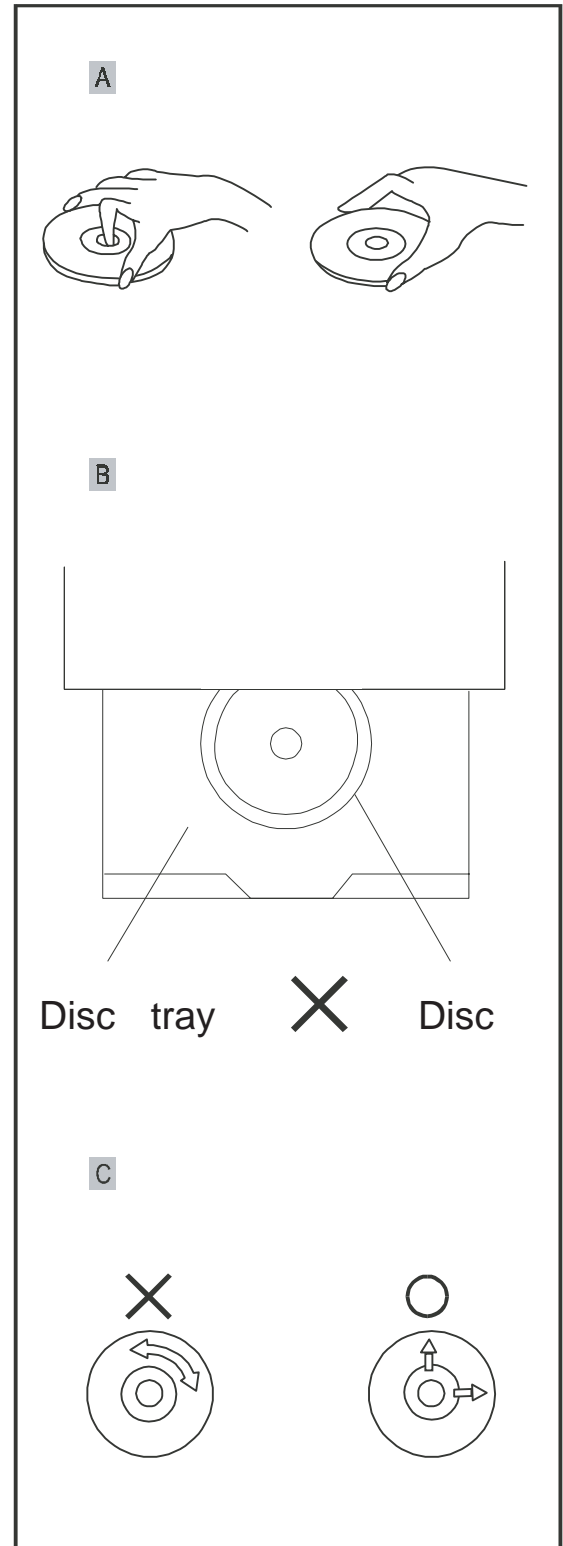

## Troubleshooting

Before requesting service for this unit, check the chart below for a possible cause of the problem you are experiencing. Some simple checks or a minor adjustment on your part may eliminate the problem and restore proper operation.

Symptom (common)	Remedy
No power	Insert the power plug securely into the power outlet.
<ul style="list-style-type: none"> <li>● Play fails to start even when PLAY is pressed.</li> <li>● Play commences but then stops immediately.</li> </ul>	<ul style="list-style-type: none"> <li>● Condensation has formed: wait about 1 to 2 hours to allow the player to dry out.</li> <li>● This player cannot play discs other than DVDs, Video CDs and CDs.</li> <li>● This disc may be dirty and may require cleaning.</li> <li>● Ensure that the disc is installed with the label side up.</li> </ul>
	<ul style="list-style-type: none"> <li>● Ensure that the equipment is connected properly.</li> <li>● Ensure that the input setting for the TV is "Video".</li> </ul>
<ul style="list-style-type: none"> <li>● No sound.</li> <li>● Distorted sound.</li> </ul>	<ul style="list-style-type: none"> <li>● Ensure that the equipment is connected properly.</li> <li>● Ensure that the input setting for the TV and stereo system are properly made.</li> <li>● Adjust the master volume using the buttons on the remote control.</li> </ul>
Picture is distorted during rapid advance or rapid reverse.	The picture will be somewhat distorted at times: this is normal.
No rapid advance (or rapid reverse) play.	Some discs may have sections, which prohibit rapid advance (or rapid reverse).
No 4:3 (16:9) picture.	Choose the correct setup "TV TYPE" item that matches the TV set used.
No surround sound.	<ul style="list-style-type: none"> <li>● Choose the correct setup at the "Audio Output" which matches your stereo system.</li> </ul>
No operations can be performed with the remote control.	<ul style="list-style-type: none"> <li>● Check the batteries are installed with the correct polarities (+/-).</li> <li>● The batteries are depleted: replace them with new ones.</li> <li>● Point the remote control unit at the remote sensor and operate.</li> <li>● Operate the remote control unit at a distance of not more than 7 meters from the remote control sensor.</li> </ul>
No key operation (either front panel and/or remote control).	<ul style="list-style-type: none"> <li>● Remove the obstacles between the remote control unit and remote control sensor. Turn the unit off and then back to on. Alternatively, turn off the unit, disconnect the AC power cord and then reconnect it (The player may not be operating properly due to lightning, static electricity or some other external factor.)</li> </ul>
OSD menu not displayed or only partially displayed on the TV Screen.	Select the appropriate TV screen type by consulting the operation manual of the TV.

Symptom (DVD)	Remedy
Play does not commence even when title is selected.	Confirm the "Ratings" setting.
Audio soundtrack and/or subtitle language is not the one selected at the initial settings.	If the audio soundtrack and/or subtitle language does not exist on the disc, the language selected at the initial settings will not be seen/head
The menu is displayed in French(for example).	The setup "Menus" of "Disc Languages" is set to French: select English
No subtitles.	<ul style="list-style-type: none"> <li>● Subtitles appear only with discs, which contain them. Subtitles are cleared from the TV monitor. Press "SUBTITLE" button to display the subtitles.</li> </ul>
Alternative audio soundtrack (or subtitle) languages fail to be selected.	<ul style="list-style-type: none"> <li>● An alternative language is not selected with discs, which do not contain more than one language.</li> <li>● In the case of some discs, the alternative language cannot be selected by operating the AUDIO or SUBTITLE button. Try selecting it from the DVD menu if one is available.</li> </ul>
Angle cannot be changed	This function is dependent on software availability. Even if a disc has a number of angles recorded, these angles may be recorded for specific scenes only (when the ANGLE indicator on the unit illuminates.)

Symptom(Video CD)	Remedy
No menu.	This function work only for Video CDs with playback control.



## Definition of terms

### Angle

Recorded onto some DVD discs are scenes, which have been simultaneously shot from a number of different angles (the same scene is shot from the front, from the left side, from the right side, etc.). With such discs, the ANGLE button can be used to view the scene from different angles.

### Chapter number

These numbers are recorded on DVD discs. A title is subdivided into many sections, each of which is numbered, and specific parts of video presentations can be searched quickly using these numbers.

### DVD

This refers to a high-density optical disc on which high-quality pictures and sound have been recorded by means of digital signals. Incorporating a new video compression technology (MPEG) and high-density recording technology, DVD enables esthetically pleasing full-motion video to be recorded over long periods of time (for instance, a whole movie can be recorded).

### PBC(playback control)

This is recorded on a video CD (VERSION 2.0). The scenes or information to be viewed (or listened to) can be selected interactively with the TV monitor by looking at the menu shown on the TV monitor.

### Subtitle

These are the printed lines appearing at the bottom of the screen, which translate or transcribe the dialogue. They are recorded on DVD discs.

### Time number

This indicates the playtime recorded on DVD discs. When a disc contains two or more movies, these movies are numbered as title 1, title 2, etc.

### Track number

These numbers are assigned to the tracks which are recorded on video CDs and CDs. They enable specific tracks to be located quickly.

### Video CD

This contains recordings of pictures and sound whose quality is on a par with that of videotape. This player also supports video CDs with playback control (version 2.0).

## Specifications

Power Requirements: AC 110V/220V, 60Hz/50Hz Power Consumption: 25w(approx.3.5W when power is OFF by the power button or the remote control)
--

**Signal system:** PAL/NTSC

**Weight:**

**Dimensions:** 290(W)X430(D)X95(H)mm(excluding protrusions)

**Operating temperature range:** +5 to 35 °C

**Operating humidity range:** 5 to 90%(no condensation)

**Discs played :**

(1) DVD-VIDEO disc

12cm single-sided, single-layer

12cm single-sided, double-layer

12cm double-sided, double-layer(one layer per side)

8cm single-sided, single-layer

8cm single-sided, double-layer

8cm double-sided, double-layer (one layer per side)

(2) compact disc (CD-DA, VIDEO CD)

12cm disc

8cm disc

**S-video output:**

Y output level: 1 Vp-p(75Ω)

C output level: 0.300Vp-p(75Ω)(PAL)

0.286 Vp-p(75Ω)(NTSC)

Output connector: S terminal (1 system)

**Video output:** Output level: 1 Vp-p(75 Ω)

Output connector: pin jack (2 systems)

**Audio output:** Output level: 2 Vrms (1kHz, 0dB)

Output connector: Pin jack

5.1ch mixed output: 1 system (2ch)

5.1ch discrete output: 1 system (5.1ch.)

**Audio signal output characteristics:**

(1) Frequency response :

DVD (linear audio);

4Hz-22kHz(48kHz sampling)

● 4Hz-22kHz(96kHz sampling)

CD audio:

2Hz-20kHz(EIAJ)

(2) S/N ratio:

CD audio: 115dB(EIAJ)

(3) Dynamic range:

● DVD(linear audio): 102dB

CD audio: 99dB(EIAJ)

(4) Total harmonic distortion:

CD audio: 0.0025%(EIAJ)

**Digital audio output:**

Optical digital output: Optical connector

Coaxial digital output: Pin jack

**Pickup:** Wave length: 655nm

**Phone Jack :** Stereo, 3.5jack

**Laser power:** CLASS1

Specifications are subject to change without notice

Weight and dimensions approximate.

## COBY® 90 DAYS LIMITED WARRANTY

COBY ELECTRONICS CORP. ("COBY") warrants this product to the original purchaser to be free from defects in material or workmanship under normal use for 90 days from the date of original purchase. COBY agrees under this warranty, to repair or replace it with a new or reconditioned product at no additional charge. Our warranty does not cover any product which has been subject to neglect, unreasonable use, accident, violation of operating instruction or any product that has been repaired or modified by an unauthorized service agent. To obtain factory service, return this unit freight-prepaid to the address shown below within the duration of this warranty. Enclose \$6.00 for each item in the form of money order made payable to COBY ELECTRONICS CORP. to cover the cost of shipping and handling. Also, include a copy of the sales receipt to show proof of purchase and a detailed description of the problem. The unit(s) must be packaged in such a way as to reasonably protect it from possible shipping damage. For further information write to.

COBY ELECTRONICS CORP.  
Customer Service Dept.  
56-65 Rust Street  
Maspeth, N.Y. 11378

COBY'S liability under any legal theory for any loss damage in any way related to this product shall not exceed the sales price of this product. In no event shall COBY be liable for any incidental or consequential damages resulting from the use of this product, or inability to use this product. Repair or replacement as provided under this warranty is the exclusive right of the consumer.

Except to the extent prohibited by law, no express or implied warranty of merchant ability or fitness for a particular purpose on this product shall be extended beyond the period of this warranty. Some States prohibit the exclusion or limitation of incidental or consequential damages, so that the above limitation or exclusion may not apply to you. This warranty gives you specific rights, and you may also have other rights which may vary from State to State.

## Free Manuals Download Website

<http://myh66.com>

<http://usermanuals.us>

<http://www.somanuals.com>

<http://www.4manuals.cc>

<http://www.manual-lib.com>

<http://www.404manual.com>

<http://www.luxmanual.com>

<http://aubethermostatmanual.com>

Golf course search by state

<http://golfingnear.com>

Email search by domain

<http://emailbydomain.com>

Auto manuals search

<http://auto.somanuals.com>

TV manuals search

<http://tv.somanuals.com>