

COBY®

DVD/CD/MPE PLAYER WITH REMOTE CONTROL



DVD-404

Instruction manual

Safety Precautions



The lightning flash with an arrowhead symbol within an equilateral triangle is intended to alert the user to the presence of uninsulated "dangerous voltage" within the product's enclosure that may be of sufficient magnitude to constitute a risk of electric shock to persons.



The exclamation point within an equilateral triangle is intended to alert the user to the presence of important operating and maintenance (servicing) instructions in the literature accompanying the appliance.

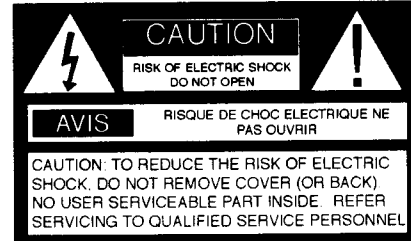

WARNING:

DO NOT EXPOSE THIS APPLIANCE TO RAIN OR MOISTURE, DUE TO THE HIGH RISK OF FIRE OR ELECTRIC SHOCK, DO NOT OPEN THE CABINET DANGEROUS HIGH VOLTAGES ARE PRESENT INSIDE THE ENCLOSURE. ONLY QUALIFIED SERVICE PERSONNEL SHOULD ATTEMPT THIS.

CAUTION:

TO PREVENT ELECTRIC SHOCK, MATCH WIDE BLADE OF PLUG TO WIDE SLOT, AND FULLY INSERT.

CAUTION:

This Digital Video Disc Player employs a Laser System. To prevent direct exposure to the laser beam, do not try to open the enclosure. Visible laser radiation when open and interlocks defeated. Use of controls or adjustments or performance of procedures other than those specified herein may result in hazardous radiation exposure. **DO NOT STARE INTO BEAM.**

To ensure proper use of this product, please read this owner's manual carefully and retain for future reference. Should the unit require maintenance, contact an authorized service location. Only qualified service personnel should remove the cover.

FCC NOTICE:

This equipment has been tested and found to comply with the limits for a Class B digital device. Pursuant with the FCC Rules, Part 15. These limits are designed to provide reasonable protection against harmful interference in a residential installation.

This equipment generates, uses and can radiate radio frequency energy and, if not installed and used in accordance with the instructions, may cause harmful interference to radio communication. However, this is no guarantee that interference will not occur in a particular installation. If this equipment does cause harmful interference to radio or television reception, which can be determined by turning the equipment off and on, the user is encouraged to try to correct the interference by one of the following measures:

- Reorient or relocate the receiving antenna.
- Increase the separation between the equipment and receiver.
- Connect the equipment into an outlet on a circuit different from that to which the receiver is connected.
- Consult the dealer or an experienced radio/TV technician for help.

FCC Caution: To assure continued compliance, (example-use only shielded interface cables when connecting to computer or peripheral devices). Any changes or modifications not expressly approved by the party responsible for compliance could void the user's authority to operate this equipment.

WARNING:

Changes or modifications made to this equipment, not expressly approved by manufacturer will void all the manufacture warranties.

THE REGION CODE FOR THE UNIT IS 1.

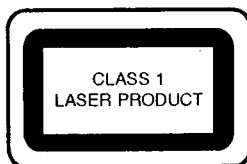

Since it is very usual for DVD movies to be released at different times in different regions of the world, all players have region codes and disks can have an optional region code. If you load a disk of a different region code to your player, you will see the region code notice on the screen. The disk will not play, and should be unloaded.

Safety Information

CAUTION: Use of controls or adjustments or performance of procedures other than those specified herein may result in hazardous radiation exposure.

Please carefully study this manual and always keep it available. There are, however, some installation and operation precautions which you should be aware of.

1. Read Instructions - All the safety and operating instructions should be read before the product is operated.
2. Retain Instructions - The safety and operating instructions should be retained for future reference.
3. Heed Warnings - All warnings on the product and in the operating instructions should be adhered to.
4. Follow Instructions - All operating and use instructions should be followed.
5. Cleaning - Unplug this product from the wall outlet before cleaning. Do not use liquid cleaners or aerosol cleaners. Clean only with a dry cloth.

Exception: A product that is meant for uninterrupted service and that for some specific reason, such as the possibility of the loss of an authorization code for a CATV converter, is not intended to be unplugged by the user for cleaning or any other purpose, may exclude the reference to unplugging the product in the cleaning description otherwise required in 131.8(5).

6. Attachments - Do not use attachments not recommended by the product manufacturer as they may cause hazards.
7. Water and Moisture - Do not use this product near water - for example, near a bath tub, wash bowl, kitchen sink, or laundry tub; in a wet basement; or near a swimming pool; and the like.
8. Accessories - Do not place this product on an unstable cart, stand, tripod, bracket, or table. The product may fall, causing serious injury to a child or adult, and serious damage to the product. Use only with a cart, stand, tripod, bracket, or table recommended by the manufacturer, or sold with the product. Any mounting of the product should follow the manufacturer's instructions, and should use a mounting accessory recommended by the manufacturer.



9. A product and cart combination should be moved with care. Quick stops, excessive force, and uneven surfaces may cause the product and cart combination to overturn.
10. Ventilation - Slots and openings in the cabinet are provided for ventilation and to ensure reliable operation of the product and to protect it from overheating, and these openings must not be blocked or covered. The openings should never be blocked by placing the product on a bed, sofa, rug, or other similar surface. This product should not be placed in a built-in installation such as a bookcase or rack unless proper ventilation is provided or the manufacturer's instructions have been adhered to.
11. Power Sources - This product should be operated only from the type of power source indicated on the marking label. If you are not sure of the type of power supply to your home, consult your product dealer or local power company. For products intended to operate from battery power, or other sources, refer to the operating instructions.
12. Grounding or Polarization - This product may be equipped with a polarized alternating-current line plug (a plug having one blade wider than the other). This plug will fit into the power outlet only one way. This is a safety feature. If you are unable to insert the plug fully into the outlet, try reversing the plug. If the plug should still fail to fit, contact your electrician to replace your obsolete outlet. Do not defeat the safety purpose of the polarized plug.

Alternate Warnings - This product is equipped with a three-wire grounding-type plug, a plug having a third (grounding) pin. This plug will only fit into a grounding-type power outlet. This is a safety feature. If you are unable to insert the plug into the outlet, contact your electrician to replace your obsolete outlet. Do not defeat the safety purpose of the grounding-type plug.

13.Power-Cord Protection - Power-supply cords should be routed so that they are not likely to be walked on or pinched by items placed upon or against them, paying particular attention to cords at plugs, convenience receptacles, and the point where they exit from the product.

14.Protective Attachment Plug - The product is equipped with an attachment plug having overload protection. This is a safety feature. See Instruction Manual for replacement or resetting of protective device. If replacement of the plug is required, be sure the service technician has used a replacement plug specified by the manufacturer that has the same overload protection as the original plug.

15.Outdoor Antenna Grounding - If an outside antenna or cable system is connected to the product, be sure the antenna or cable system is grounded so as to provide some protection against voltage surges and built-up static charges. Article 810 of the National Electrical Code, ANSI/NFPA 70, provides information with regard to proper grounding of the mast and supporting structure, grounding of the lead-in wire to an antenna discharge unit, size or grounding conductors, location of antenna-discharge unit, connection to grounding electrodes, and requirements for the grounding electrode. See Figure 131.1.

16.Lightning - For added protection for this product during a lightning storm, or when it is left unattended and unused for long periods of time, unplug it from the wall outlet and disconnect the antenna or cable system. This will prevent damage to the product due to lightning and power-line surges.

17.Power Lines - An outside antenna system should not be located in the vicinity of overhead power lines or other electric light or power circuits, or where it can fall into such power lines or circuits. When installing an outside antenna system, extreme care should be taken to keep from touching such power lines or circuits as contact with them might be fatal.

18.Overloading - Do not overload wall outlets, extension cords, or integral convenience receptacles as this can result in a risk of fire or electric shock.

19.Object and Liquid Entry - Never push objects of any kind into this product through openings as they may touch dangerous voltage points or short-out parts that could result in a fire or electric shock. Never spill liquid of any kind on the product.

20.Servicing - Do not attempt to service this product yourself as opening or removing covers may expose you to dangerous voltage or other hazards. Refer all servicing to qualified service personnel.

21.Damage Requiring Service - Unplug this product from the wall outlet and refer servicing to qualified service personnel under the following conditions:

- a. When the power-supply cord or plug is damaged.
- b. If liquid has been spilled, or objects have fallen into the product.
- c. If the product has been exposed to rain or water.

d. If the product does not operate normally by following the operating instructions. Adjust only those controls that are covered by the operating instructions as an improper adjustment of other controls may result in damage and will often require extensive work by a qualified technician to restore the product to its normal operation.

e. If the product has been dropped or damaged in any way.

f. When the product exhibits a distinct change in performance - this indicates a need for service.

22. Replacement Parts - When replacement parts are required, be sure the service technician has used replacement parts specified by the manufacturer or have the same characteristics as the original part. Unauthorized substitutions may result in fire, electric shock, or other hazards.

23. Safety Check - Upon completion of any service or repairs to this product, ask the service technician to perform safety checks to determine that the product is in proper operating condition.

24. Wall or Ceiling Mounting - The product should be mounted to a wall or ceiling only as recommended by the manufacturer.

25. Heat - The product should be situated away from heat sources such as radiators, heat registers, stoves or other products (including amplifiers) that produce heat.

Accessories included

Please verify that the following items are included within the DVD carton. If items are missing, please promptly return this unit to the retailer for an exchange.

Remote Control Unit

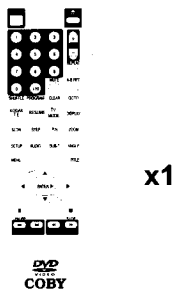

AA Batteries



Video & Audio (L/R) Cable (three jacks) (One set of Video wire and two sets of Audio wires)

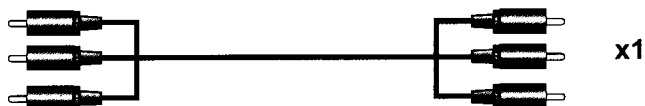

User Manual

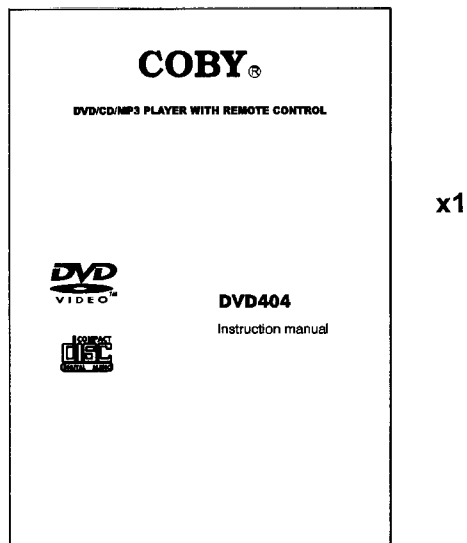

Features

- **DVD: a completely new dimension in video entertainment**

- Subtitles may be displayed in one of a maximum of 32 languages.
- The audio soundtrack can be heard up to 8 languages. The number of the languages recorded is dependent on the software.
- The multi-angle function allows you to choose the viewing angle of which scenes were shot from many different angles (limited to DVD discs recorded with multiple camera angles).

The number of the languages recorded is dependent on the software.

- **High quality digital audio**

- The Dolby Digital / MPEG2 audio/Linear PCM decoder is built into the player which makes it possible to enjoy Multi-Channel Surround sound.
- With linear PCM sound of a 48 kHz/16 bit through 96 kHz/24 bit, audio quality exceeding that of Audio CD becomes possible.
- The unit has a built-in MP3 audio file decoder

- **Many convenient features**

- Direct access of favorite scenes (title/chapter/time/track search).
- Programming of up to 3 scenes in memory (marker) **【DVD only】**
- Parental lock setting to prevent play of discs unsuitable for some audiences. **【DVD only】**

- **Compatible with PAL DVD and NTSC DVD**

- This player can play discs recorded in either PAL or NTSC format. However, the player must be connected to a Multi-system TV to play both PAL DVD /and NTSC DVD.

The use of a Multi-system TV is recommended.

- **Compatible with audio CDs as well as DVD.**

Disc formats supported by this player: -

MP3

CD recorded in MP3 file



DVD

(8cm disc/12cm disc)



CD

(8cm Disc/12cm Disc)

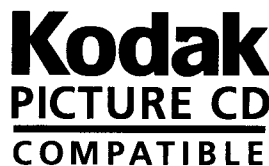

KODAK CD

12cm Disc

The product complies with the KODAK Picture CD format and will display KODAK Picture CDs. The "KODAK Picture CD Compatible" logo is a trademark of Eastman Kodak Company and is used with permission.

Selecting the type of disc compatible with your TV

Both DVD discs have material recorded in either PAL or NTSC format.

Refer to the table below to select the disc type compatible with your TV.

The type of Connected TV	Disc	TV Monitor
Multi-system	PAL	Played in the PAL system.
	NTSC	Played in the NTSC system.
NTSC	PAL	No clear images are showed on the screen.
	NTSC	Played in the NTSC system.
PAL	PAL	Played in PAL system.
	NTSC	No clear images are showed on the screen.

Manufactured under license from Dolby Laboratories. "Dolby", "Pro Logic" and the double-D symbol are trademarks of Dolby Laboratories. Confidential Unpublished Works, Copyright 1992-1997 Dolby Laboratories, Inc. All rights reserved.

This product incorporates copyright protection technology that is protected by method claims of certain U.S. patents and other intellectual property rights owned by Macrovision Corporation and other rights owners. Use of this copyright protection technology must be authorized by Macrovision Corporation, and is intended for home and other limited viewing uses only unless otherwise authorized by Macrovision Corporation. Reverse engineering or disassembly is prohibited.

Table of contents

Safety precautions	(1)
Safety information	(2) ~ (4)
Accessories included	1
Features	2
Selecting the type of disc compatible with your TV	2
Table of contents	3
Control reference guide	4
Main unit	4
Remote control unit	4
Connection to TV	5
Audio Players (inc. Advanced Setup)	6
Digital audio connections	7
Remote control preparation	8

Reset to Factory set	18
OSD Language setup	18
VIDEO SETUP	18
AUDIO SETUP	19
RATING SETUP	19

Disc handling and maintenance	20
Troubleshooting	21
Definition of terms	23
Specifications	23
COBY 90 day limited warranty	24

Basic play	9
Basic play	9
Stopping play	10
Skipping +/-	10
Fast FWD/RWD	10
Pause/Step picture	11
MENU and TITLE	11
Changing SUBTITLE language	12
Change audio soundtrack language	12
Viewing from another ANGLE	13
Control the VOLUME of voice	13
On screen DISPLAY	13
PAL/NTSC Setting	14
MUTE	14
TV MODE	14
SHUFFLE	14
REPEAT	14
PROGRAM	14
Repeat A-B	15
GOTO function	15
ZOOM picture	16
VOLUME CONTROL	16
Playback of MP3 files	16
KODAK T.E	17

Control reference guide

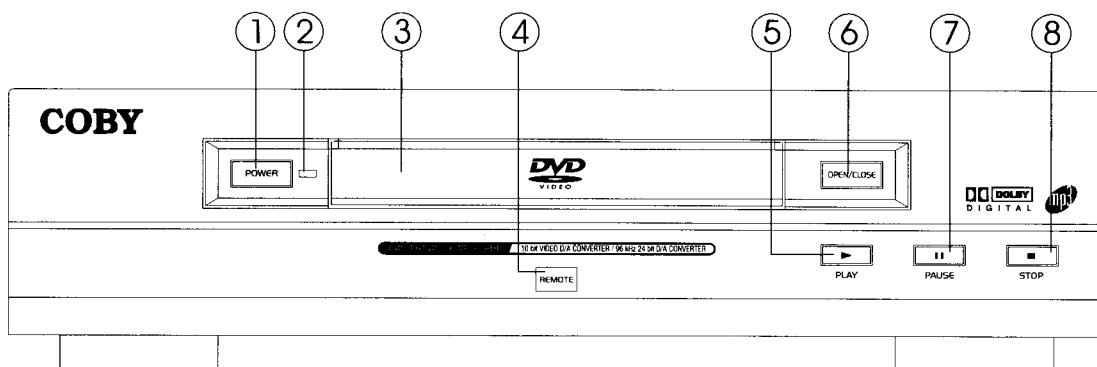

- (1) POWER SWITCH
- (2) POWER SWITCH INDICATOR
- (3) DISC TRAY
- (4) REMOTE CONTROL SIGNAL SENSOR

- (5) PLAY button
- (6) OPEN/CLOSE button
- (7) PAUSE/STEP button
- (8) STOP button

- (1) POWER button (⏻)
- (2) NUMERIC buttons
- (3) SHUFFLE button
- (4) PROGRAM button
- (5) KODAK T.E button
- (6) RESUME button
- (7) SLOW button
- (8) STEP button
- (9) SETUP button
- (10) AUDIO button
- (11) MENU button
- (12) CURSOR (joystick) / ENTER buttons
- (13) PAUSE button
- (14) SKIP buttons (⏮ ⏭)
- (15) OPEN/CLOSE button
- (16) VOLUME buttons (⏪ ⏩)
- (17) REPEAT button
- (18) A-B REPEAT button
- (19) MUTE button
- (20) GOTO button
- (21) CLEAR button
- (22) DISPLAY button
- (23) TV MODE button
- (24) ZOOM button
- (25) PAL/NTSC button
- (26) ANGLE button
- (27) SUBTITLE button
- (28) TITLE button
- (29) STOP button (■)
- (30) FAST RWD / FWD (⏮ ⏭) buttons

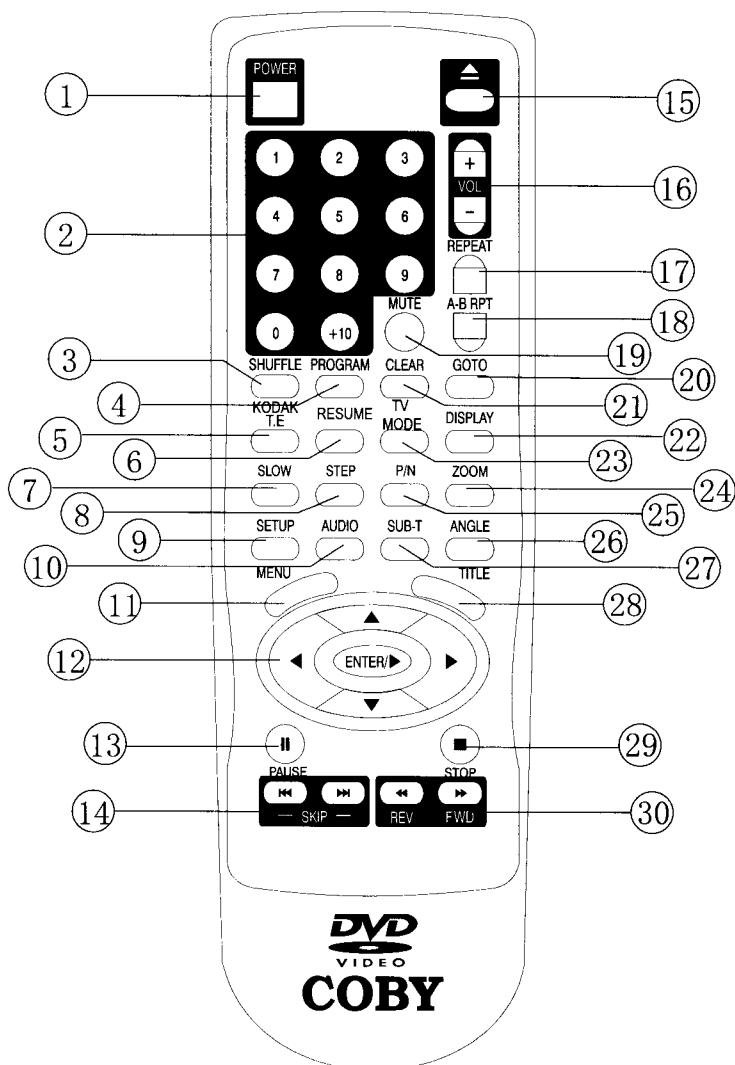

WARNING

NEVER MAKE OR CHANGE ANY CONNECTIONS WITH THE POWER ON.

CAUTIONS

1. To avoid distortion connect your DVD player directly to your TV, not the VCR for example.
2. Do not connect the AUDIO OUT signals from the DVD player to the PHONO IN inputs on your amplifier or receiver.
3. Never connect the digital output signal (COAXIAL) from the DVD to the analogue inputs of an amplifier, receiver, audio system or TV.

Connecting the DVD Player to a TV

Option 1 (VIDEO)

Using a video lead.

The lead will need a connector to mate with the video input connector on the TV set. A standard RCA socket is used for the video output on the DVD player.

To connect the audio signals to the TV set, use a stereo audio lead from the L and R connectors on the DVD to the AUDIO IN connectors on the TV. Alternatively, the audio can be fed to an Audio System as described later. See diagram -Option 1.

VIDEO OPTION 1

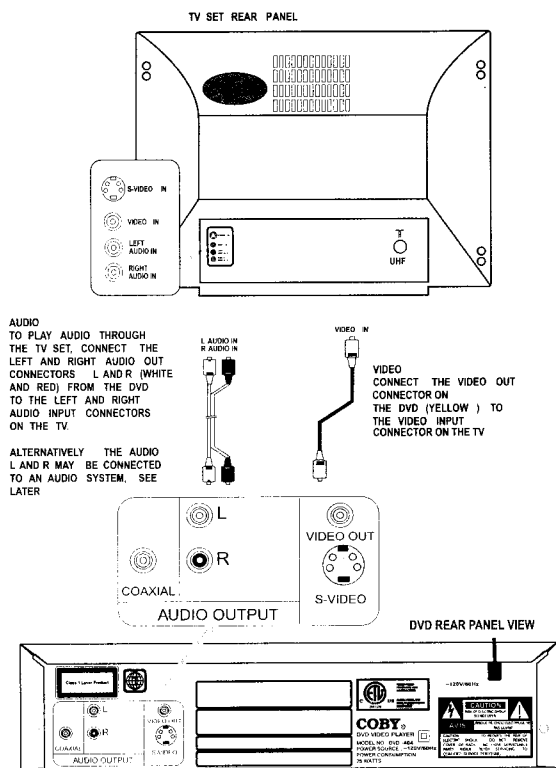

Option 2 (S-VIDEO)

The final option requires a special S-VIDEO lead (not supplied). This is a video cable terminated at both ends with mini 4-pin D-type plug. This is readily available.

Plug this cable into the S-VIDEO output on the DVD player rear panel, and to the S-VIDEO input on the TV. See diagram - Option 2.

VIDEO OPTION 2

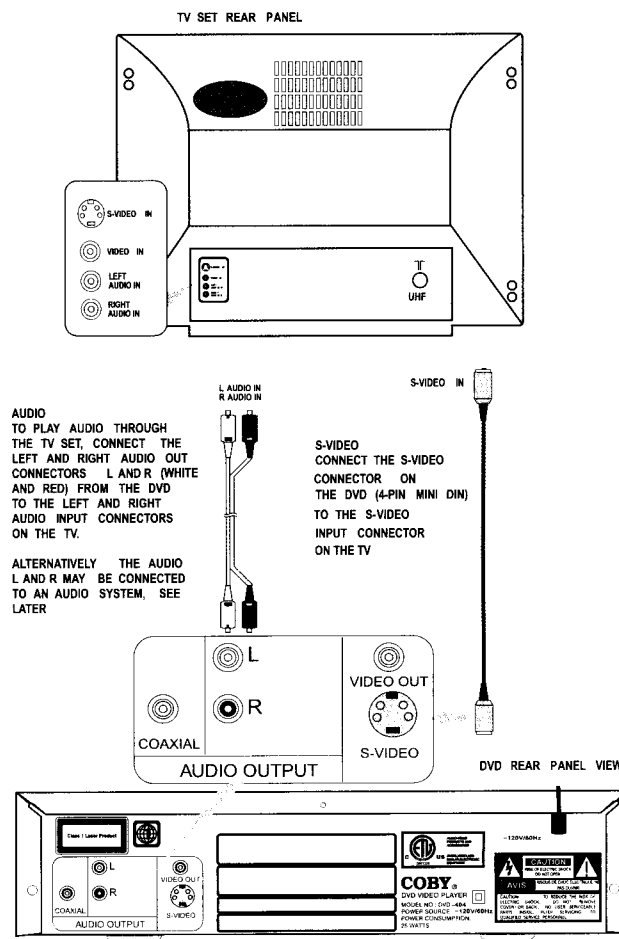

Use only ONE of the above options to avoid picture interference.

Connecting the DVD Player to an audio system

Your DVD can be connected to an audio system to give stereo sound, surround sound (if the necessary equipment is present), and other audio effects. You can also listen to CDs and DVD video discs when the DVD player is connected to an Audio System.

The audio lead will need a connector to mate with the audio input connector on the audio system. A pair of standard RCA sockets are used for the AUDIO OUT channels on the DVD player.

Connect the AUDIO OUT Left and Right channels from the DVD player to the Left and Right channels of the AUDIO IN on the audio system.

Refer to the diagram below.

Connecting the DVD Player to a Receiver having an MPEG 2 or a Dolby Digital decoder

Equipment with a built-in MPEG 2 decoder or a Dolby Digital decoder allows you to enjoy the "surround-sound" sensation. This simulates the effect of being in a movie theatre or a concert hall using the information contained on the DVD disc.

The DVD player outputs the surround-sound signals from the COAXIAL DIGITAL AUDIO OUT connector, and can be connected to your decoder equipment as shown in the illustration shown next page.

NOTES

If the audio format of the digital output does not match the capabilities of your receiver, the receiver will produce a strong, distorted sound or no sound at all. To see the selected format of the current DVD, see Setup Menu in the Operation section of this User Guide.

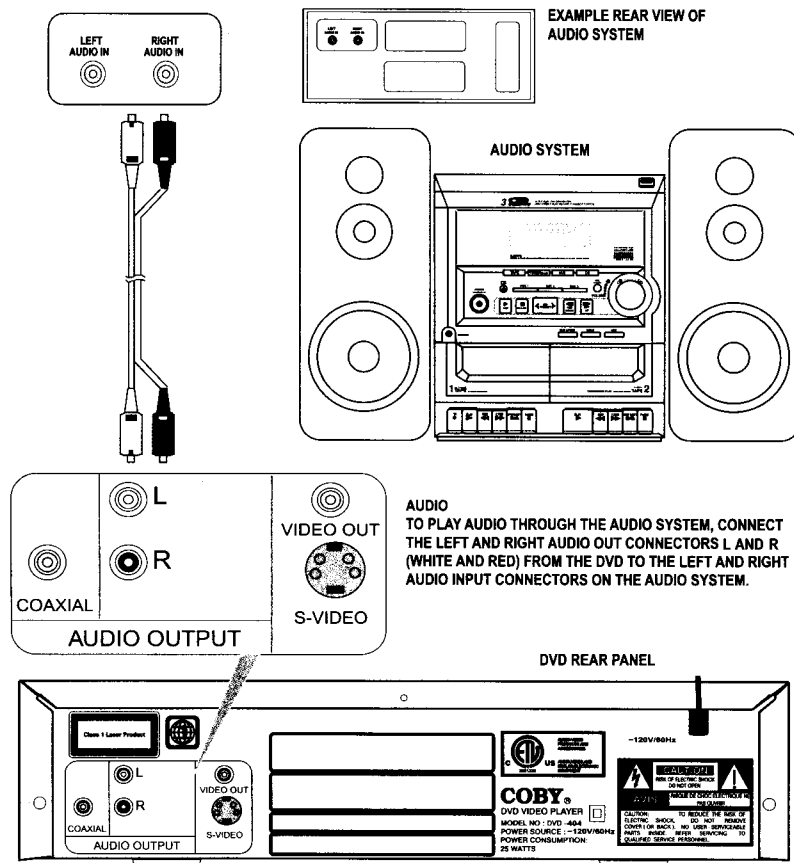

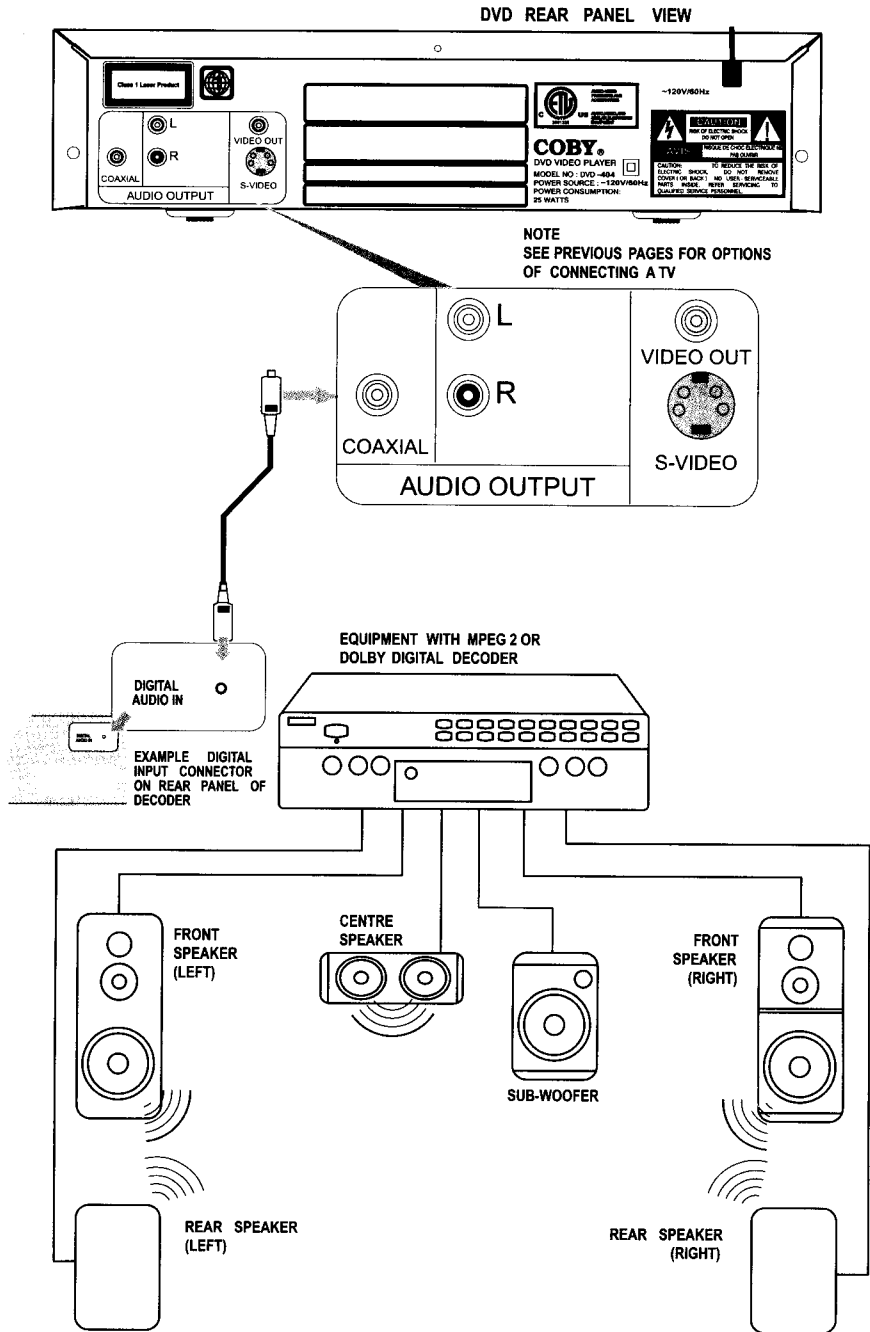

Remote control preparation

Insert the batteries while observing the correct (+) and (-) polarities as illustrated.

Service life of batteries

- The batteries normally last for about one year although this depends on how often and for what operations the remote control is used.
- If the remote control unit fails to work even when it is operated near the player, replace the batteries.
- Use 2 x 'AA' type batteries.

Notes:

- Do not use rechargeable (Ni-Cd) batteries.
- Do not attempt to recharge, Short-circuit or disassemble batteries. Never place batteries close to a heat source such as radiators or heaters.
- Dispose of batteries in a responsible manner. Never throw batteries in a fire.
- Do not drop or step on the remote control unit. This may damage the parts or lead to malfunction.
- Do not mix old and new batteries.
- If the remote control unit is not going to be used for long time, always remove the batteries to prevent leakage.

Point the remote control unit no more than 7 meters from the remote control sensor and within 60° from the front of the unit.

- The operating distance may vary according to the brightness of the room.

Notes:

- Do not point bright lights at the remote control sensor.
- Do not place objects between the remote control unit and the remote control sensor.
- Do not use this remote control unit while simultaneously operating the remote control unit of any other equipment.

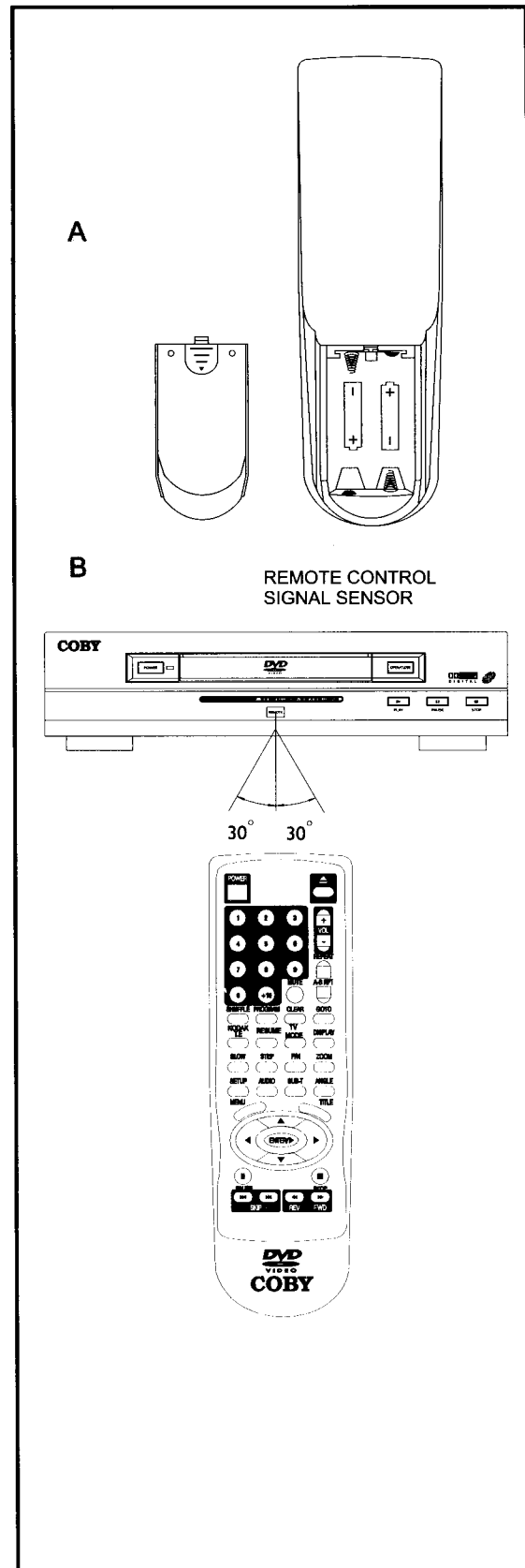

Basic operation

Preparations

- Switch ON the TV and select "Video" as the input source.
- Switch on the stereo system if the player has been connected to a stereo audio amplifier.

1. Press **POWER** on the main unit to turn the power on.

2. Press the **OPEN/CLOSE** by the main unit or remote control unit to open the disc tray.

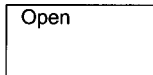

3. Place a disc onto the disc tray.

Hold the disc without touching either of its surfaces, position it with the printed side facing up, align it with the guides and place it on the disc tray.

- (1) 8cm disc
- (2) 12cm disc

4. Press the **OPEN/CLOSE** button again or **PLAY** on the main unit or remote control. The tray will close and display the following:

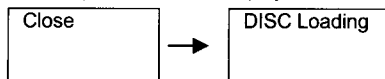

The player will automatically play.

When a menu screen appears on the TV monitor:-

In case of interactive DVDs with playback control, a menu screen appears on the TV. With DVDs, you can use **CURSOR** to select which item you want to enjoy and press **ENTER**.

- Press **POWER** button on the front panel or remote control to switch the unit from ON to **STANDBY** mode (or vice versa). In standby mode, the unit is still consuming a small amount of power.

Note:

- The disc continues to rotate while the menu is displayed even after the player has finished playing a particular item. When no further selections are to be played, be sure to press the **STOP** button to clear the menu display.
- If the disc is placed in the tray upside down (and it is a single sided disc), the DVD display will indicate "NO DISC".

For your reference:

When  appears while a button is being operated, it means that the corresponding operation is prohibited by the player or the disc.

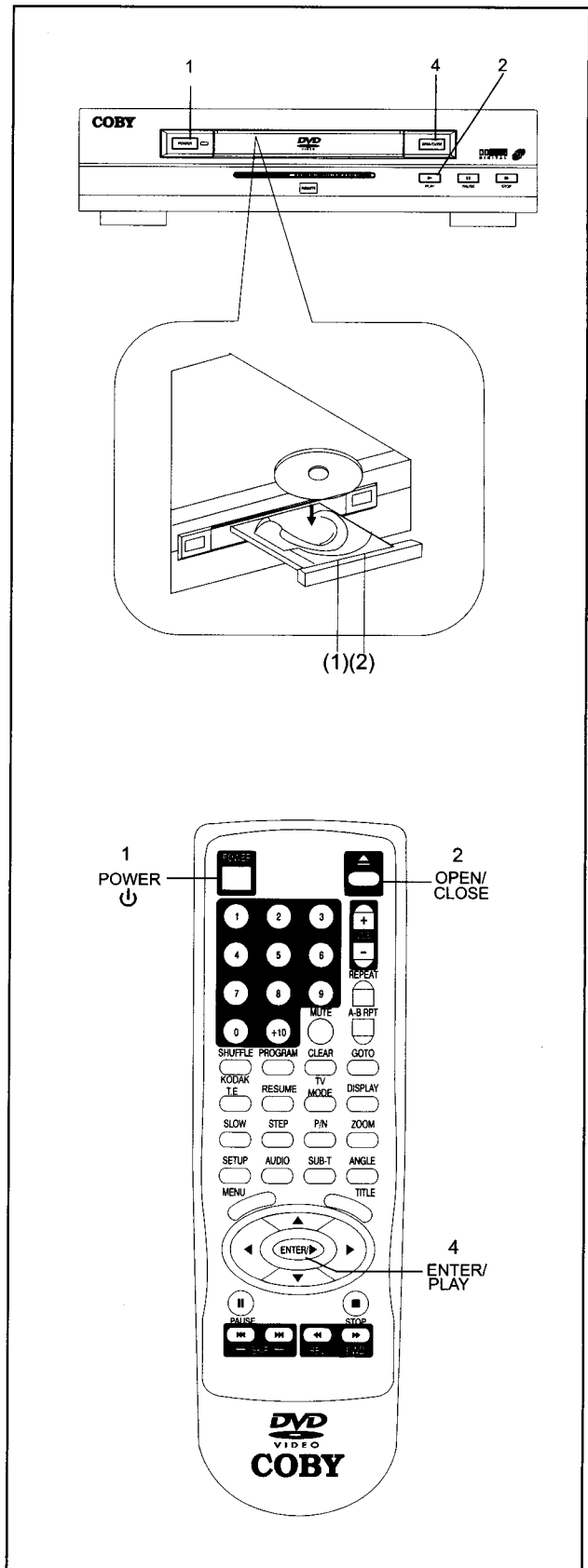

Press STOP

For you convenience:

Memory Stop. DVDs can utilize a function called Memory Stop. This allows you to temporarily stop a movie and restart it from the same point later. While playing a disc, pressing STOP once will set the player into Memory Stop mode. At this point, pressing PLAY re-starts the movie from the same point. Pressing STOP a second time will stop the disc completely (i.e. the Stop Memory is lost). Note that some DVD discs will not allow the use of Memory Stop.

Skipping +

Press SKIP+ during play.

A chapter (DVD) or a track (CD) is skipped each time the button is pressed.

Skipping -

Press skip- during play.

The chapter/track will be skipped to previous chapter/track by press "skip-" button each time.

Fast FWD/RWD

Using either the Remote Control or the Front Panel controls, press **FAST FWD**(▶▶) or **FAST RWD**(◀◀) during play.

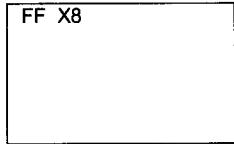
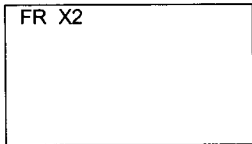

For you reference:

Press FAST FWD or FAST RWD button once, the disc will be played forward or backward at double (×2) speed. With each subsequent press, the disc will be played back at ×2, ×4, ×8 or ×20 speed and PLAY. Press PLAY button to return to normal play.

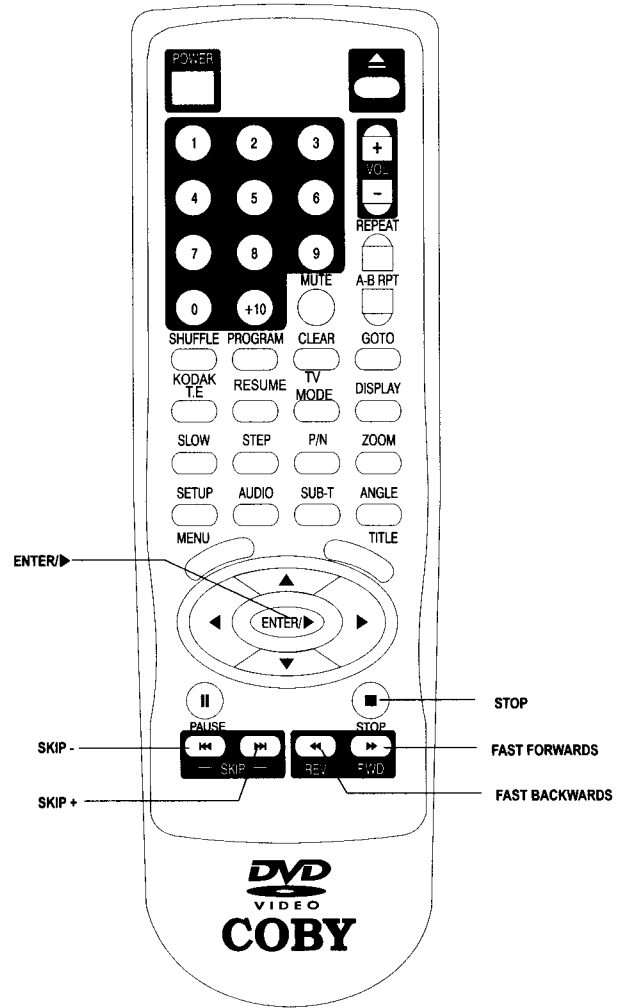

Pause/Step picture

Press PAUSE/STEP during play.

For your reference:

1. During play, pressing the PAUSE button will suspend playback. Press PAUSE again (or press the ENTER/PLAY button) return to normal play.
2. Repeatedly Press the STEP button. The picture advances forward frame-by-frame for each subsequent press of STEP. To return to normal play, press the ENTER/PLAY button.

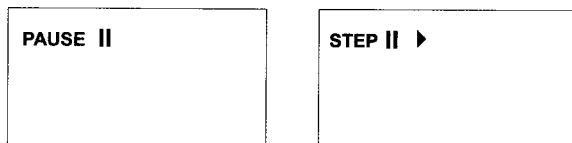

SLOW PLAY (DVDs only)

Press SLOW button when playing, you can play the disc at 1/2, 1/4, 1/6, 1/8 of normal speed. If you want stop it, you can press PLAY button to play normally again.

MENU and TITLE

Press MENU or TITLE by the remote control unit

- DVD discs usually are divided into several titles and subdivided into chapters. CD discs are divided into tracks.
- Press TITLE on the remote and the disc playing will automatically return to the title program. Press the CURSOR buttons on the remote to select the option, then press ENTER button to play it. Note it is possible that some DVD discs will not have this function.
- Press MENU button on the remote, the disc playing will automatically return to the chapter menu. Press CURSOR buttons on the remote to select chapter and then press the ENTER button to play.

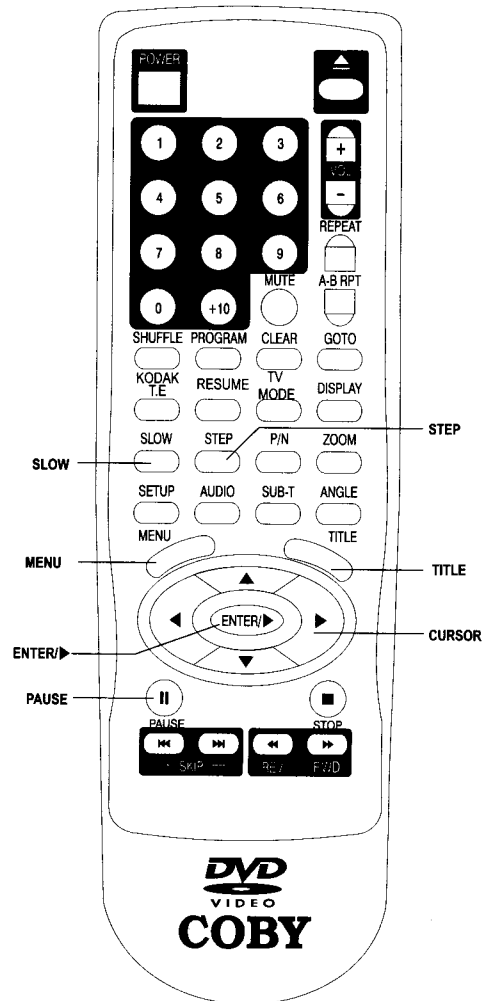

Changing SUBTITLE language [DVDs only]

- It is possible to change the subtitle language from the one selected, if available. This operation works only with discs on which multiple subtitle languages have been recorded).
- Press the SUBTITLE button on the remote. The alternative language subtitle will appear with each press, <SUBTITLE 1>, <SUBTITLE 2>, <SUBTITLE 3> <SUBTITLE OFF> (The different disc have different display.)

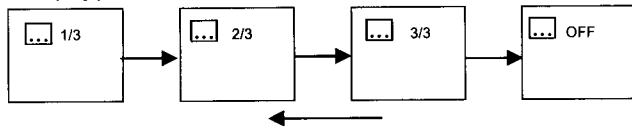

- When no subtitles are recorded, "Ⓢ" will be displayed on the TV screen.

For your reference:

- If the power is reset or the disc is removed, subtitles will appear in the default language set by the DVD player. If this language is not recorded on the disc, they will appear in the disc's default language.

Changing the audio soundtrack language

- It is possible to change the audio soundtrack language from the default standard to another, if available. This operation works only with discs on which different audio soundtrack languages are recorded.
- **DVD:**

Some DVDs have multi-audio output function. Pressing the AUDIO button on the controller repeatedly selects the available audio tracks.

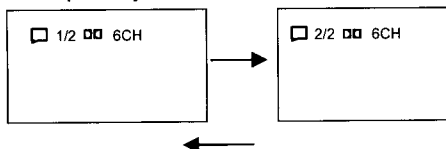

When no audio soundtrack language are recorded, "Ⓢ" will be displayed on the TV screen.

- **CD:**

For CD pressing the AUDIO button on the controller repeatedly selects the available audio tracks.

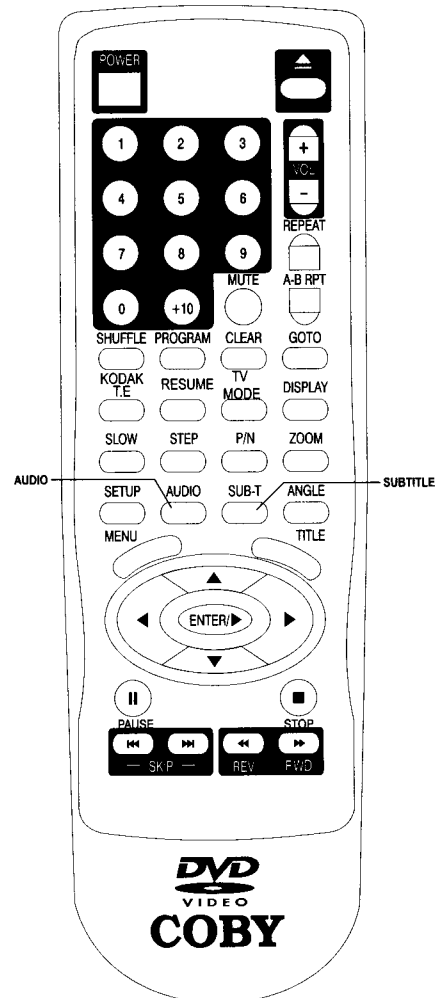
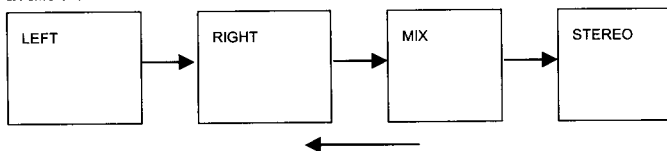

Viewing from another ANGLE [DVDs only]

- Some DVDs may contain scenes that have been shot simultaneously from a number of different angles. For these discs, the same scene can be viewed from each of these different angles using the ANGLE button. The recorded angles will differ depending on the disc being played.
- When playing a DVD with multi-angle viewing, " / " will appear on the screen. For example, if the disc has three angles available, pressing the ANGLE button on the controller will step you through all available views. The screen will show 1/3 then 2/3 then 3/3 and then back to 1/3 again etc.

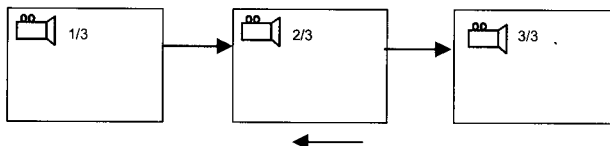

- When no multi-angle are recorded, "⊘" will be displayed on the TV screen.

On screen DISPLAY

During playback, you can press the DISPLAY button on the remote to show the various information available.

- For DVDs, the DISPLAY function button will allow you to view:

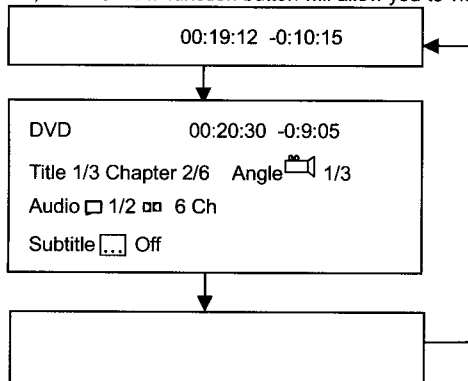

Press the DISPLAY button to cancel this function.

- For CD discs, the DISPLAY functions allows you to view the following:

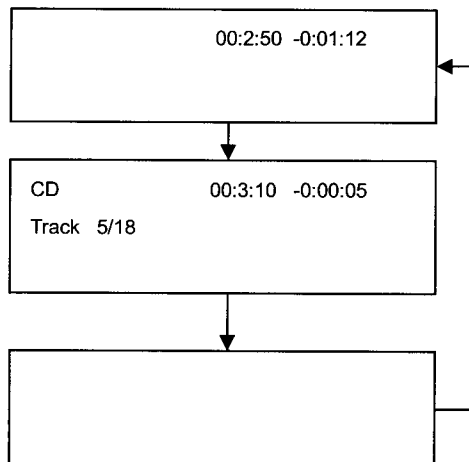

Elapsed play & remain times of the present program

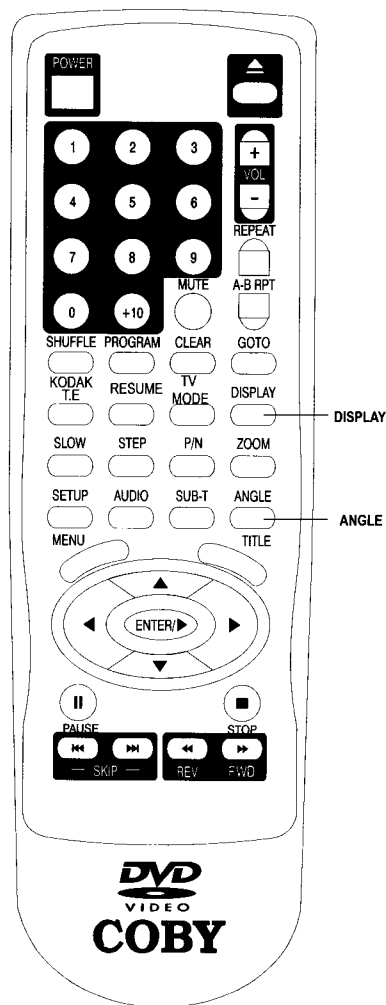

PAL/NTSC setting

● This function is TV TYPE. If you press this button it will allow you to select three TV types (The DVD player must be in the stop mode or have the DVD door open to use the P/N button.):

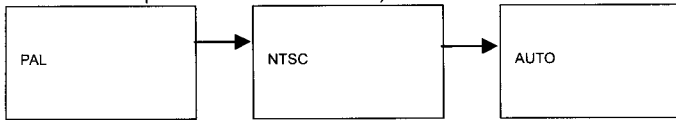

MUTE

Press MUTE button on the remote control unit to mute as the program is still playing. The TV screen displays , press MUTE again to resume sound play.

TV MODE

The TV mode button is used to switch display mode among **Fullscreen** or **Letterbox** or **Widescreen**.

“” When displayed on TV, function is not operational on the disc.

SHUFFLE

Press the SHUFFLE button.

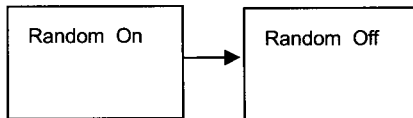

The DVD video player will now start random playback and normal playback.

REPEAT

If you play a DVD disc, the screen will display:

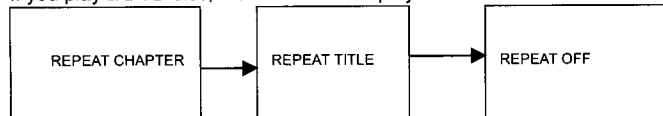

If you play a CD disc, the screen will display:

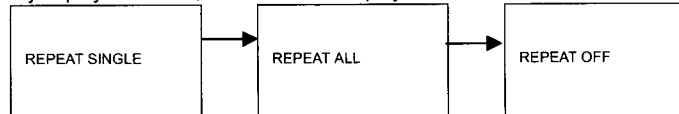

Program

You can press the PROGRAM button on the remote control unit, the screen will display program menu.

For DVD disc will show the following:

Program Input	Title/Chapter
1 _ _ _ 4 _ _ _ 7 _ _ _ 10 _ _ _	
2 _ _ _ 5 _ _ _ 8 _ _ _ 11 _ _ _	
3 _ _ _ 6 _ _ _ 9 _ _ _ 12 _ _ _	
Play Program	Clear All

CD

For CD disc will show the following:

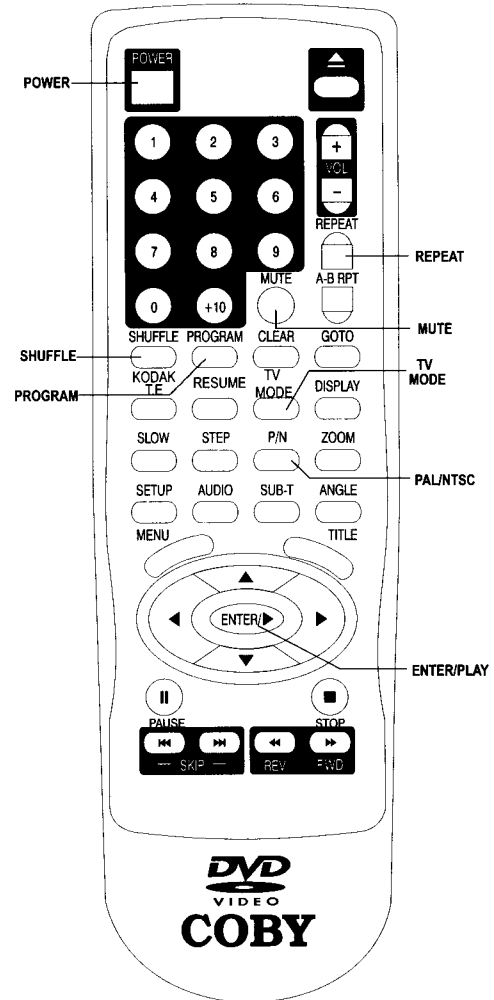

PROGRAM : INPUT

1. ---	4 ---	7 ---	10 ---
2. ---	5 ---	8 ---	11 ---
3. ---	6 ---	9 ---	12 ---

Play Program Clear All

Press CURSOR and NUMERIC button on the remote control unit. To enter the Title/Chapter digit (DVD) or Track digit (CD) needed. Then select Play Program and press ENTER to begin program playback. It will automatically stop when finished.

In order to cancel Program playback status, press PROGRAM button on the remote control unit, select “Clear All” and press ENTER, then press PROGRAM to exit.

Repeat A-B (allows you to play a small section of the disc repeatedly)

- Press the A-B button on the remote at the point where you wish the repeat play to start. The display will show Rep A-. Press A-B button again at the point where you wish the repeat play to finish. The display will show Rep A-B SET. The A-B segment will now repeat continuously until the A-B button is pressed for a third time.

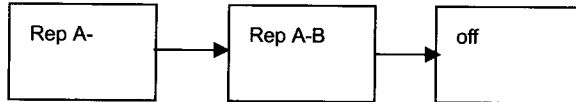

GOTO function

You may directly enter a time, title or chapter number to search fast on a disc, the player plays from that point.

- For DVD discs, press GOTO button on the remote, the display will show the following:-

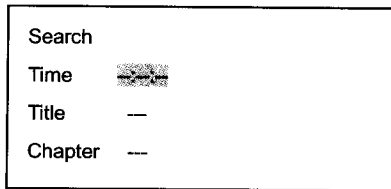

Press the CURSOR (UP,DOWN,LEFT,RIGHT) button and move. The cursor to illuminate the Time, Title or chapter number. Press NUMERIC to button enter the digits on the remote control unit for start time, or Title/Chapter digits you wanted, then press the ENTER button to start playback.

- For CD discs, press GOTO button on the controller, the following will be displayed: -

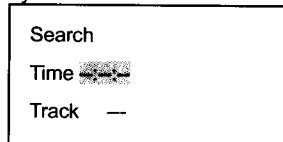

You can operate by pressing CURSOR, NUMERIC and ENTER button.

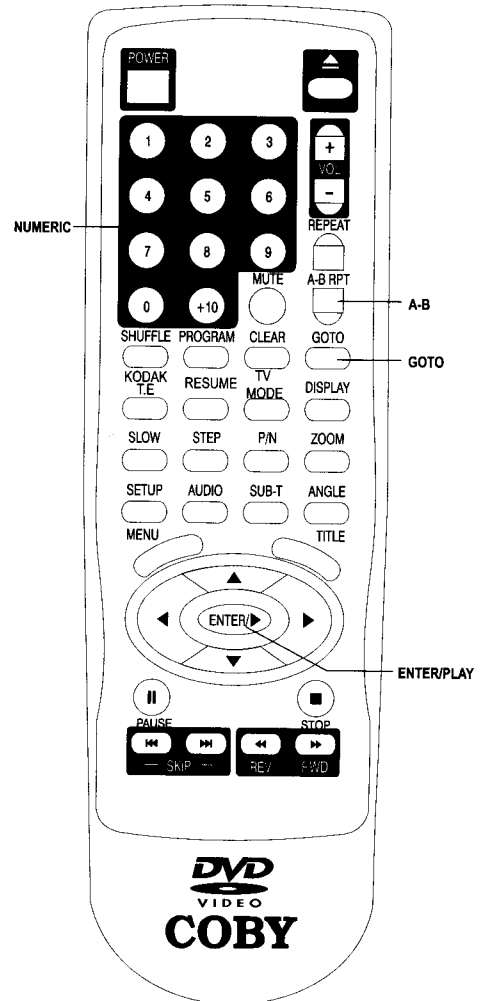

ZOOM picture

- Depending on the disc being played, you can press the ZOOM button repeatedly allowing the picture to increase accordingly: ZOOM1, ZOOM2 and ZOOM OFF. (The different disc have different display.)

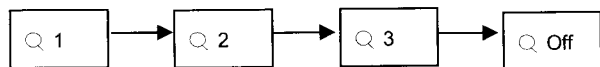

- In the ZOOM mode, you can use CURSOR buttons to move the picture for optimum viewing

VOLUME control

The volume of the audio track can be changed using the VOL + and VOL- buttons.

- Continuously press VOL+ to progressively increase the volume. Release the button when the required volume is reached.
- Continuously press VOL- to progressively decrease the volume. Release the button when the required volume is reached.

Playback of MP3 Files

When playing MP3 disc, the screen displays the menu. Press MENU button on the remote control unit, the main menu appears. Use CURSOR to move the cursor. Press ENTER to select the item and enter the next menu. After using CURSOR and ENTER to select the music, playback begins.

- When one song is playing, press SKIP+, - button to play previous or next song.
- Using CURSOR and ENTER button to select the last song of current group menu to play. Press skip+ to enter the next group menu.
- Using CURSOR and ENTER button to select the first song of one groupmenu, press SKIP- to return to the previous groupmenu.
- Press the Number button on the remote control unit to directly select the track to play.
- Press REPEAT button on the remote control unit, select repeating playing Single or All songs or REPEAT OFF.

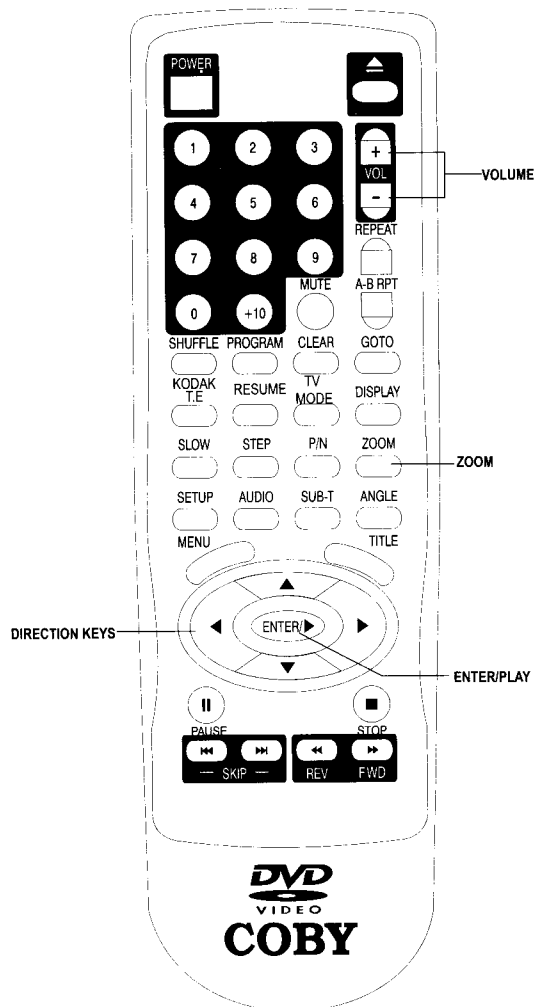

Playing Back Your Kodak Picture CD

When a Kodak Picture CD is inserted, an automated slide show is launched. Each picture in the current directory will be displayed consecutively in a slide-show fashion and will be scaled to fit most of the TV screen. Six slideshow transition modes are provided. Use "KODAK T.E" key to select: **Customers can set "transition" effects for every picture at any time during the slideshow.**

If you press the "KODAK T.E" key continuously, you can select from 1/6 to 6/6.

- 1: WIPE FROM TOP TO BOTTOM
- 2: WIPE FROM BOTTOM TO TOP
- 3: WIPE FROM EDGE TO CENTER
- 4: WIPE FROM CENTER TO EDGE
- 5: WIPE FROM TOP TO CENTER AND WIPE FROM CENTER TO BOTTOM
- 6: RANDOW (by default)

Note: When you have completed viewing your photos, press stop, then "Open/close" button to open tray and pick up the P-CD. Otherwise images will remain on the screen indefinitely.

During the slideshow, in order to view the NEXT or Previous picture press the **SKIP FORWARD** or **BACK** keys. To resume press the **ENTER** key. You can also use number key directly to select the picture you want.

STOP

If you press the STOP button during the slideshow or at the end of your picture slideshow, you can see a menu like:

PictureCD		20/20	
PICTURES			
1	001-1	7	007-7
2	002-2	8	008-8
3	003-3	9	009-9
4	004-4	10	010-10
5	005-5	11	011-11
6	006-6	12	012-12

You can use UP/DOWN/LEFT/RIGHT button to select the picture you like.

MENU

The **MENU** key is used to display thumbnail pictures from the stop position. After it is enabled, up to twelve scaled-down thumbnail picture will be displayed on the screen. The **SKIP FORWARD/BACK** keys can be used to display the **NEXT** and **PREVIOUS** twelve picture in the current directory.

ZOOM

If you press the ZOOM button continuously, you can see:

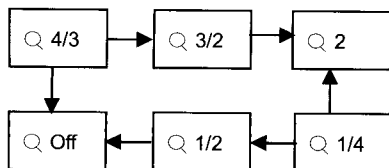

You can use CURSOR buttons to move the picture for optimum viewing in the ZOOM mode, i.e. 4/3, 3/2 or 2.

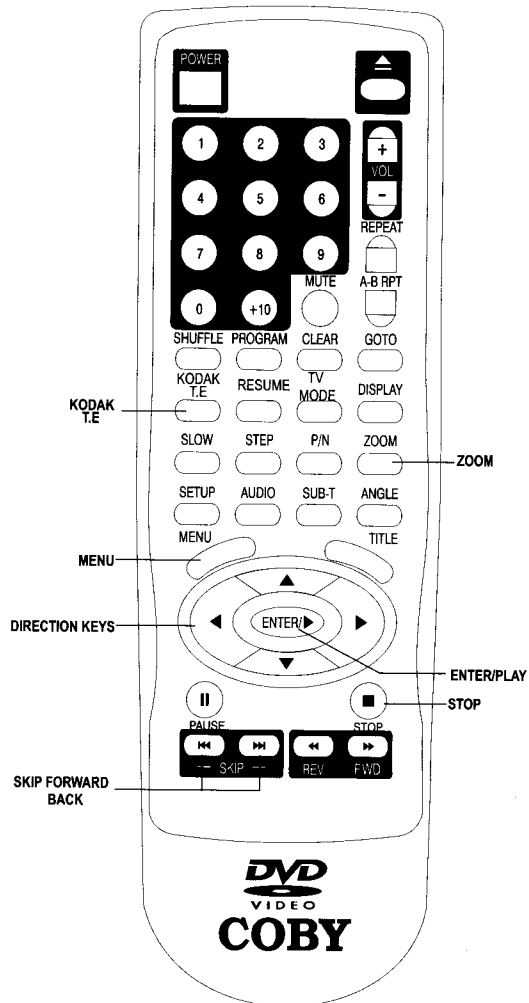

Initial settings

Once the initial settings have been set, the player will always operate with the same parameters. The setting will be retained in the memory even after switching off the power.

- Initial settings must be in the setup mode, but function can be set in all mode.
- Using the setup menu, you may choose the play mode setting the various outputs by remote control unit.
- During STOP mode, press SETUP button on the remote, you will see main menu on the screen (picture 1).
- Select the menu item desired by using Left /Right CURSOR button, and then press the ENTER button. You should see next menu. Use Up/Down CURSOR button select the option list, press ENTER to choose or enter next menu to choose again.
- After choosing, press the Up CURSOR button, return to previous menu to change others.
- Press the SETUP button to leave the setup menu and return to the TV DISPLAY.

Reset to Factory set

Select Language in main menu, press ENTER to Language setup menu, see (picture2). Select Restore Default : Yes, press ENTER, the unit automatically reset and then re-read the disc and play. so it is reset to the factory setup.

OSD Language setup (picture 2)

Select language item of main menu. Press ENTER to language setup menu:

- Select OSD menu and press ENTER button, the sub-menu shows the optional languages.
- Select SUBTITLE menu and press ENTER button, the submenu shows the optional languages and AUTO, OFF item.
- Select AUDIO menu and press ENTER button, the submenu shows the optional languages.
- Select DVD menu and press ENTER button, the sub-menu shows the optional languages.

VIDEO setup (picture 3)

Select video in the main menu, press ENTER to the video setup menu.

- Select TV Aspect and press ENTER, the submenu as follows:

This setup decides the display shape of the TV set.

Fullscreen

Choose this setting you will see the movie fill the entire screen of your TV. But you won't see part of the picture (particularly the right and left edge).



Letterbox

Choose this setting if you want to see movies in their original aspect ratio. You will see the entire frame of the movie, but it will occupy a smaller portion of the screen.



Widescreen

Choose this setting if your DVD player is connected to a widescreen TV.



- Select TV system and press ENTER, the submenu appears on screen. According to the system of TV to be connected, set the type of the video output to match the TV.

1. If the TV used is PAL, select PAL output signal;
2. If it is NTSC, select NTSC output signal;
3. Or select AUTO if TV is multi-system.

Note:

To obtain the best DVD picture, it is strongly recommended to use Multi-system TV to play DVD movie at 'Auto' mode.

Language	Video	Audio	Rating

(picture 1)

Language	Video	Audio	Rating
OSD Menu	English		
Subtitle	Off		
Audio	English		
DVD Menu	English		
Restore Default	Yes		

(picture 2)

Language	Video	Audio	Rating
TV Aspect	Fullscreen		
TV system	NTSC		

(picture 3)

AUDIO setup (picture 4)

Select Audio in main menu, press ENTER to the audio setup menu.

Dolby D: The Analog out is only 2 channel. There are PCM/Bitstream/Off three options for choosing in Digital out. The default setting by factory is PCM.

DTS: It's only has Digital out. There are Bitstream/Off two options for choosing in Digital out. The default setting by factory is Bitstream

MP3 : The Analog out is only 2 channel. There are PCM/Off two options for choosing in Digital out. The default setting by factory is PCM.

CD/VCD: The Analog out is only 2 channel. There are PCM/Bitstream/Off three options for choosing in Digital out. The default setting by factory is PCM.

NOTE:

- **OFF:** You should select this when you are playing the disc through the SPDIF OUTPUT Right & Left jacks on your DVD player. No signal output from the coaxial port when selecting this function.
- **Bitstream:** Select this when the DVD player is connected with a power amplifier through DIGITAL OUT coaxial port. The power amplifier to be connected must have Dolby Digital decoding.
- **PCM:** Select this when the DVD player is connected with a 2-CHANNEL DIGITAL MODE OR STEREO AMPLIFIER. When a Dolby Digital or MPEG disc is played, the coaxial port will output in PCM 2-channel format. These program features an uncompressed digital stereo sound track for improved fidelity, when played, discrete stereo sound will be heard from the front right and left speakers.

Language	Video	Audio	Rating
	Analog out	Digital out	
Dolby D	2 channel	PCM	
DTS		Bitstream	
MP3	2 channel	PCM	
CD/VCD	2 channel	PCM	

(picture 4)

RATING setup (picture 5)

Select Rating in main menu. Press ENTER to rating setup menu.

The unit is shipped from the factory without password. You can change the Rating setup. Press ENTER, change the rating lever form 1 to 8. Finish the setup, then return to the password item. enter the 4 digit password you decide ,press ENTER to lock the rating setup. Next time for Rating setup, you should enter the password first to unlock it.

Language	Video	Audio	Rating
Password	_____		
Rating	8 Adult		

(picture 5)

For Your Reference:

Disc handling and maintenance

Handling precautions

- Hold the disc by the edges so the surface will not be soiled with fingerprints. (A)
- Fingerprints, dirt and scratches can cause skipping and distortion.
- Do not write on the label side with a ballpoint pen or other writing utensils.
- Do not use record cleaning sprays, benzine, thinner, static electricity prevention liquids or any other solvent.
- Be careful not to drop or bend the disc.
- Do not install more than 1 disc on the disc tray.
- Do not try to close the disc tray when the disc is not installed properly. (B)
- Be sure to store the disc in its exclusive case when not in use.

If the surface is soiled (C)

Wipe gently with a soft, damp (water only) cloth.

When wiping discs, always move the cloth from the center hole toward the outer edge.

(If you wipe the discs using a circular motion, circular scratches are likely to occur, which will cause noise.)

If the disc is brought from a cold to a warm environment, moisture may form on the disc.

Wipe this moisture off with a soft, dry, lint-free cloth before using the disc.

Improper disc storage

You can damage discs if you store them in the following places:

- Areas exposed to direct sunlight
- Humid or dusty areas
- Areas directly exposed to a heat outlet or heating appliance

Maintenance

- Be sure to turn the unit off and disconnect the AC power cord before maintaining the unit.
- Wipe this unit with a dry soft cloth.
If the surfaces are extremely dirty, wipe clean with a cloth, which has been dipped in a weak soap-and-water solution and wrung out thoroughly. Then wipe again with a dry cloth.
- Never use alcohol, benzine, thinner, cleaning fluid or other chemicals.
Do not use compressed air to remove dust.

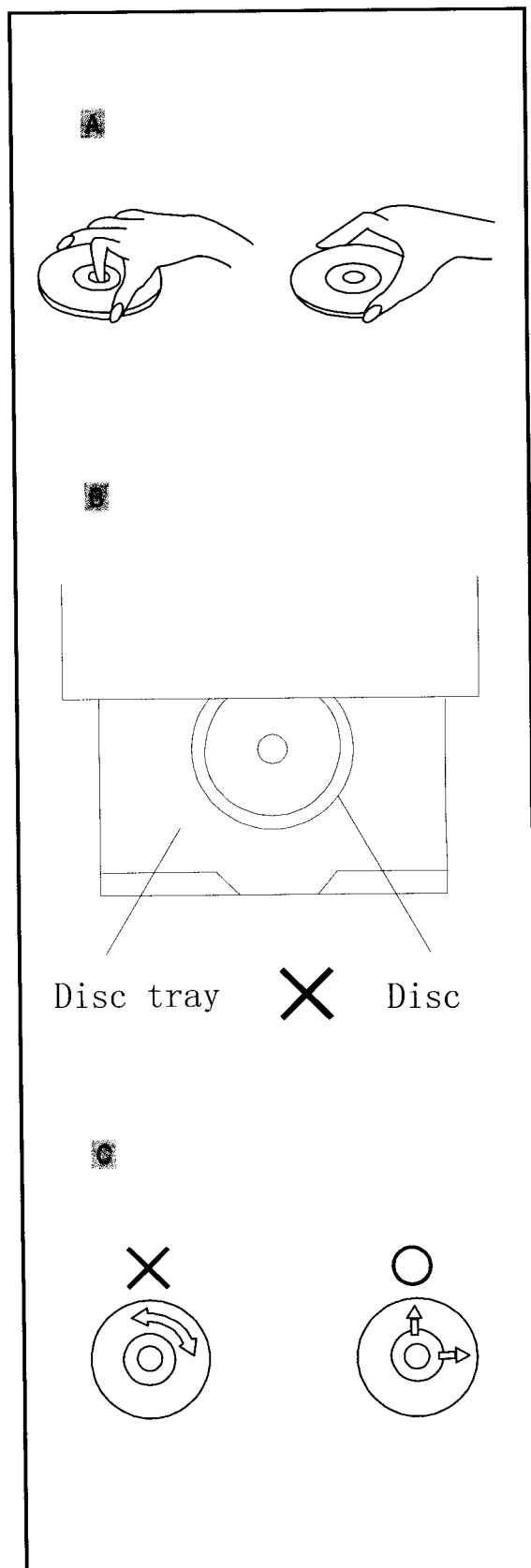

Troubleshooting

Before requesting service for this unit, check the chart below for a possible cause of the problem you are experiencing. Some simple checks or a minor adjustment on your part may eliminate the problem and restore proper operation.

No power	Insert the power plug securely into the power outlet. Make sure you have turned the power ON from the main unit.
<ul style="list-style-type: none"> ● Play fails to start even when PLAY is pressed. ● Play commences but then stops immediately. 	<ul style="list-style-type: none"> ● Condensation has formed: wait about 1 to 2 hours to allow the player to dry out. ● This player cannot play discs other than DVDs, and CDs. ● This disc may be dirty and may require cleaning. ● Ensure that the disc is installed with the label side up.
No picture.	<ul style="list-style-type: none"> ● Ensure that the equipment is connected properly. ● Ensure that the input setting for the TV is "Video".
<ul style="list-style-type: none"> ● No sound. ● Distorted sound. 	<ul style="list-style-type: none"> ● Ensure that the equipment is connected properly. ● Ensure that the input settings for the TV and stereo system are proper. ● Adjust the master volume using the buttons on the remote control.
Picture is distorted during rapid advance or rapid reverse.	The picture will be somewhat distorted at times: this is normal.
No rapid advance (or rapid reverse) play.	Some discs may have sections, which prohibit rapid advance (or rapid reverse).
No 4:3 (16:9) picture.	Choose the correct setup "TV Display" item that matches the TV set used.
No on-screen display.	The "Off" setting is selected for "On-screen Messages": select "On".
No surround sound.	<ul style="list-style-type: none"> ● Choose the correct setup at the "Audio Output" which matches your stereo system.
No operations can be performed with the remote control.	<ul style="list-style-type: none"> ● Check the batteries are installed with the correct polarities(+ / -) ● The batteries are depleted: replace them with new ones. ● Point the remote control unit at the remote sensor and operate. ● Operate the remote control unit at a distance of not more than 7 meters from the remote control sensor.
No key operation (either front panel and/or remote control).	<ul style="list-style-type: none"> ● Remove the obstacles between the remote control unit and remote control sensor. Turn the unit off and then back to on. Alternatively, turn off the unit, disconnect the AC power cord and then reconnect it. (The player may not be operating properly due to lightning, static electricity or some other external factor.)
OSD menu not displayed or only partially displayed on the TV Screen.	Select the appropriate TV screen type by consulting the operation manual of the TV.

Play does not commence even when title is selected.	Confirm the "Ratings" setting.
Audio soundtrack and/or subtitle language is not the one selected at the initial settings.	If the audio soundtrack and/or subtitle language does not exist on the disc, the language selected at the initial settings will not be seen/heard.
The menu is displayed in French (for example).	The setup "Menus" of "Disc Languages" is set to French: select English.
No subtitles.	<ul style="list-style-type: none"> ● Subtitles appear only with discs, which contain them. Subtitles are cleared from the TV monitor. Press "SUBTITLES" button to display the subtitles.
Alternative audio soundtrack (or subtitle) languages fail to be selected.	<ul style="list-style-type: none"> ● An alternative language is not selected with discs, which do not contain more than one language. ● In the case of some discs, the alternative language cannot be selected by operating the AUDIO or SUBTITLE button. Try selecting it from the DVD menu if one is available.
Angle cannot be changed.	This function is dependent on software availability. Even if a disc has a number of angles recorded, these angles may be recorded for specific scenes only (when the ANGLE indicator on the unit lights up.)

Definition of terms

Angle

Recorded onto some DVD discs are scenes, which have been simultaneously shot from a number of different angles (the same scene is shot from the front, from the left side, from the right side, etc.). With such discs, the ANGLE button can be used to view the scene from different angles.

Chapter number

These numbers are recorded on DVD discs. A title is subdivided into many sections, each of which is numbered, and specific parts of video presentations can be searched quickly using these numbers.

DVD

This refers to a high-density optical disc on which high-quality pictures and sound have been recorded by means of digital signals. Incorporating a new video compression technology (MPEG) and high-density recording technology, DVD enables esthetically pleasing full-motion video to be recorded over long periods of time (for instance, a whole movie can be recorded).

Subtitle

These are the printed lines appearing at the bottom of the screen, which translate or transcribe the dialogue. They are recorded on DVD discs.

Time number

This indicates the playtime recorded on DVD discs. When a disc contains two or more movies, these movies are numbered as title 1, title 2, etc.

Track number

These numbers are assigned to the tracks which are recorded on CDs. They enable specific tracks to be located quickly.

Specifications

Power Requirements: AC 120 V, 60Hz

Power Consumption: 25W(approx. 3.5W when power is OFF by the power button or the remote control)

Signal system: PAL/NTSC

Weight: 5kg

Dimensions: 320(W)x330(D)x80(H)mm (excluding protrusions)

Operating temperature range: +5 to +35°C

Operating humidity ranger: 5 to 90% (no condensation)

Discs played:

- (1) DVD-VIDEO disc
 - 12cm single-sided, single-layer
 - 12cm single-sided, double-layer
 - 12cm double-sided, double-layer (one layer per side)
 - 8cm single-sided, single-layer
 - 8cm single-sided, double-layer
 - 8cm double-sided, double-layer (one layer per side)
- (2) compact disc (CD-DA)
 - 12cm disc
 - 8cm disc

S-video output:

Y output level: 1 Vp-p (75 Ω)

C output level: 0.300 Vp-p (75 Ω)(PAL)

0.286 Vp-p (75 Ω)(NTSC)

Output connector: S terminal (1 system)

Video output: Output level: 1 Vp-p (75 Ω)

Output connector: Pin jack (2 systems)

Audio output: Output level: 2 Vrms (1kHz, 0dB)

Output connector: Pin jack

5.1ch mixed output: 1 system (2ch)

Audio signal output characteristics:

- (1) Frequency response:
 - DVD (linear audio):
 - 4Hz-22kHz (48kHz sampling)
 - 4Hz-22kHz (96kHz sampling)
 - CD audio:
 - 2Hz-20kHz (EIAJ)
- (2) S/N ratio:
 - CD audio: 115dB (EIAJ)
- (3) Dynamic range:
 - DVD (linear audio): 102dB
 - CD audio: 99dB (EIAJ)
- (4) Total harmonic distortion:
 - CD audio: 0.0025% (EIAJ)

Digital audio output:

Coaxial digital output: Pin jack

Phone jack: Stereo, 6.35mm jack

Pickup: Wave length: 655nm

Laser power: CLASS 1

Specifications are subject to changer without notice.

Weight and dimensions are approximate.

COBY.

90 DAY LIMITED WARRANTY

COBY ELECTRONICS CORP (“**COBY**”) warrants this Product to the original purchaser to be free from defects in Material or workmanship under normal use for **90 DAYS** from the date of original purchase. **COBY** agrees under this warranty, to repair or replace it with a new or reconditioned product at no additional charge. Our warranty does not cover any product which has been subject to neglect, unreasonable use, accident, violation of operating instructions, or any product that has been repaired or modified by an unauthorized service agent

To obtain factory service, return this unit freight-prepaid to the address shown below within the duration of this warranty. Enclose \$6.00 for each item in form of money order made payable to **COBY ELECTRONICS CORP.** to cover the cost of shipping and handling. Also include a copy of the sales receipt to show proof of purchase and a detailed description of the problem. The unit(s) must be packaged in such as way as to reasonably protect it from possible shipping damages.

All parts and materials **MUST** be included in box

For further information contact :

COBY ELECTRONICS CORP.
Customer Service Dept.
56-65 Rust street
MASPETH, NY 11378
www.cobyusa.com

COBY's liability under any legal theory for any loss or damage In any way related to this product shall not be exceed the Sales price of this product. In no event shall COBY be liable for any incidental or consequential damages resulting from the use of this product, or inability to use this product. Repair of replacement as provided under this warranty is the exclusive right of consumer.

Except to extent prohibited by law, no express or implied Warranty of merchant ability or fitness for a particular purpose on this product shall be extended beyond the period of this incidental or consequential damages, so that the above limitations or exclusion may not apply to you. This warranty gives you specific rights, and you may also have other rights that may vary from State to State.

094-E0182R-001

Free Manuals Download Website

<http://myh66.com>

<http://usermanuals.us>

<http://www.somanuals.com>

<http://www.4manuals.cc>

<http://www.manual-lib.com>

<http://www.404manual.com>

<http://www.luxmanual.com>

<http://aubethermostatmanual.com>

Golf course search by state

<http://golfingnear.com>

Email search by domain

<http://emailbydomain.com>

Auto manuals search

<http://auto.somanuals.com>

TV manuals search

<http://tv.somanuals.com>