



DVD9000UK



USER'S MANUAL

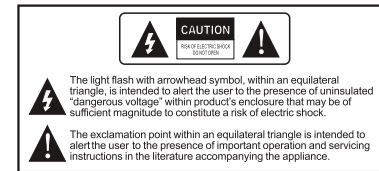

Table Of Contents

Safety Precaution	1
Package	2
Main Features	2
Main Unit Controls	3
System Connection	4
The Remote Control	7
Basic operation	9
Connecting with USB and SD/MMC/MS card	14
System Setup	15
Specification	18
Troubleshooting	19

Safety Precaution

Thank you for choosing our portable DVD player. It includes a 9" wide screen and a DVD player. The unit applies the latest state of art electronics and is designed for use at home, in hotels and in offices etc for relaxation. The compact size makes carrying easier as well as installation. Please read the manual carefully prior to use and keep it well for later consultation.



Warning: To reduce the risk of fire or electric shock, do not expose this apparatus to rain or moisture.

- 1) Please read the instruction manual carefully and follow all the requirements of safe operation to operate the device.
- 2) Do not use this unit near water. Do not place over the unit any container with liquid inside.
- 3) Do not install near any heat sources such as radiators, heat registers, stoves, or other apparatus (including amplifiers) that produce heat.
- 4) Unplug this unit during lightning storms or when unused for long time.
- 5) About Cleaning: Unplug the system, use only wet cloth to clean. Do not use liquid detergent or aerosol.
- 6) Only use accessories specified by the manufacturer.
- 7) Refer all servicing to qualified service personnel, servicing is required when the unit has been damaged in any way, such as power supply cord or plug is damaged, liquid has been spilled or objects have fallen into the unit, exposed to moisture, does not operate normally. Don't try to repair the machine by yourself because of the danger of high voltage and electric shock.
- 8) Do not use irregular shaped discs such as heart or star-shaped discs as they may cause the unit to malfunction.

Package

DVD Player	1
Remote Control with battery	1
Audio/Video Cable	1
AC/DC Power Adapter	1
Cigarette Lighter Adapter	1
User's Manual	1
Earphone	1

Main Features

- High brightness color 9" LCD screen
- Compatible with disc of DVD, VCD, MP3, MPEG4, CD, JPEG, etc.
- Built-in stereo speaker
- Built-in rechargeable Lithium polymer battery
- Support PAL or NTSC system
- Support Multi-language OSD, speed forward/backward, repeat function
- Zoom in/out function

Main Unit Controls

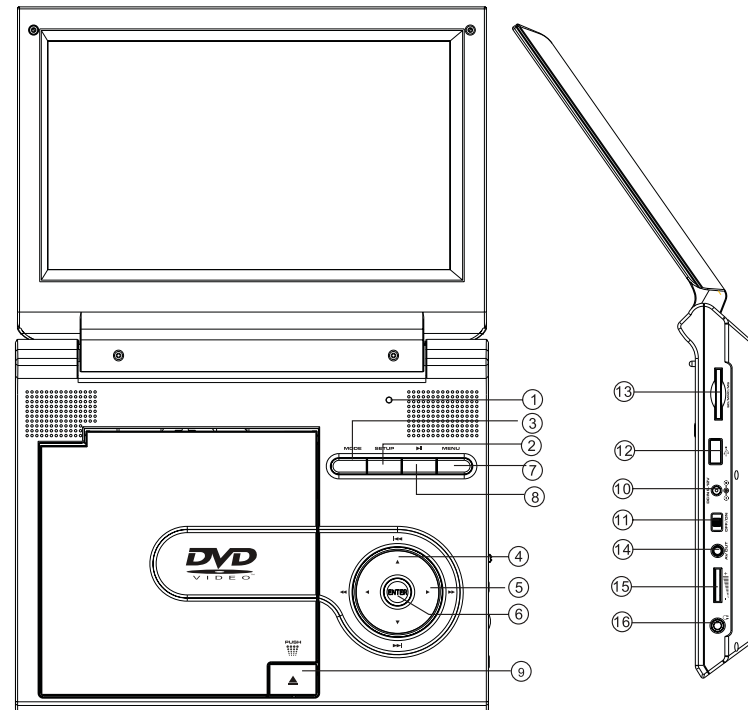

1. LCD switch
2. Setup button
3. MODE button
4. ⏪ ⏩ / ▲ ▼
5. ⏮ ⏭ / ⏪ ⏩
6. ENTER button
7. MENU button
8. Play/Pause ▶||

9. Open knob
10. DC IN 9-12V
11. Power ON/OFF switch
12. USB port
13. SD/MMC/MS card slot
14. AV OUT
15. Volume knob
16. Earphone jack

System Connection

Powering and installation

Plug one end of the AC/DC power adaptor into the DC IN 9-12V jack on the right of the machine, then plug the other end into the AC power receptacle. Please refer to the following illustration

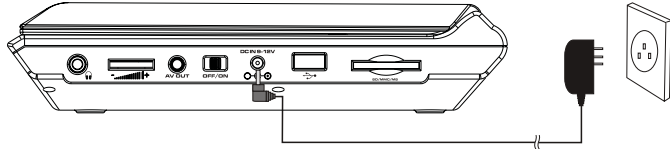

If using car cigarette lighter adaptor to connect to the power: Plug one end of the cigarette lighter adaptor into the DC IN 9-12V jack on the unit, plug the other end into the car cigarette lighter socket. See illustration below.

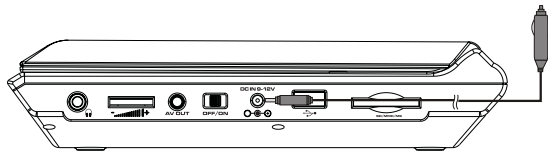

Notice:

1. Car cigarette lighter adaptor can't be used to recharge the battery.
2. Car cigarette lighter adaptor is available to use only when the car power supply is 9-12V.

Connecting to TV

You can also connect the unit to a TV to enjoy high quality picture and stereo sound. Please refer to the following illustration:

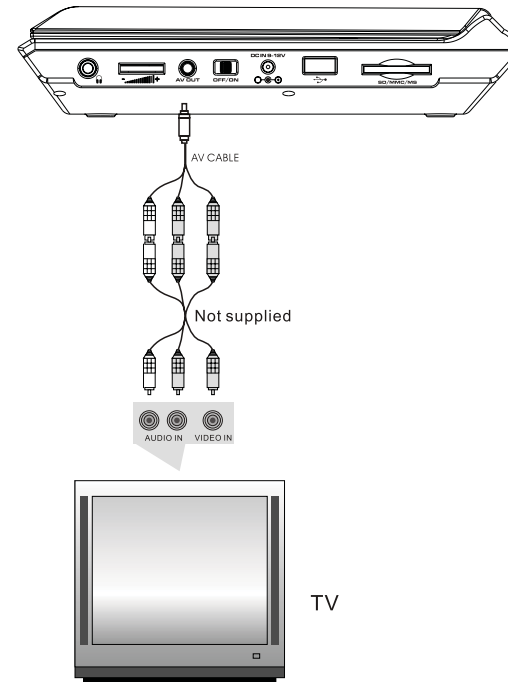

Please use AV cable to connect the machine and the TV. Make sure it is connected correctly.

Connecting with external Speaker

The unit can be connected with external speaker. Please see the following illustration

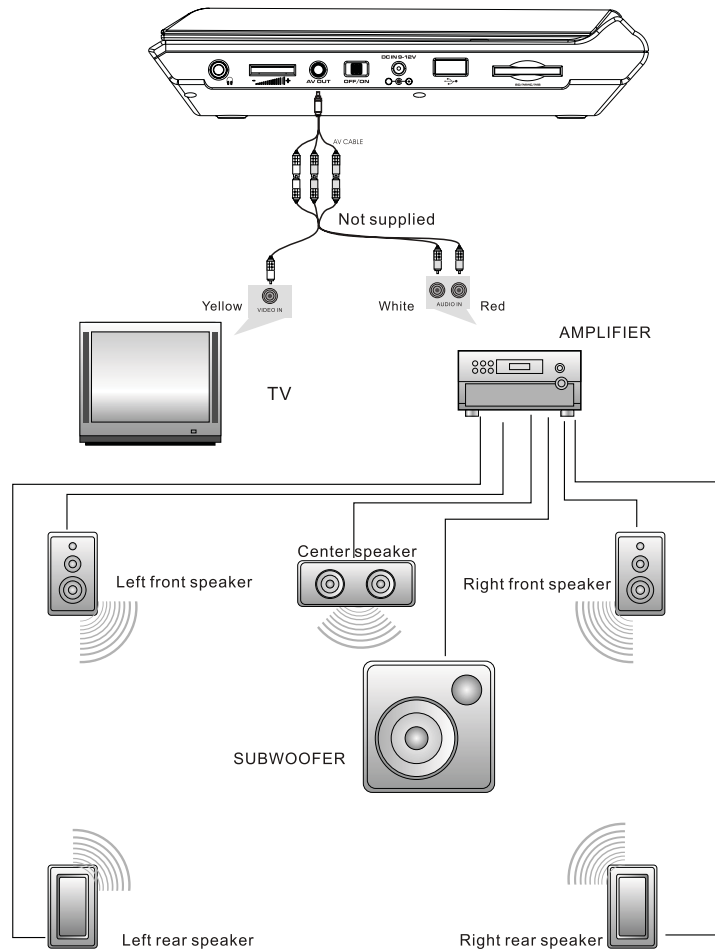

Notice: There is no 5.1 channel in the unit, however, after connecting to APM it is available to output audio in 5.1 channel

The Remote Control

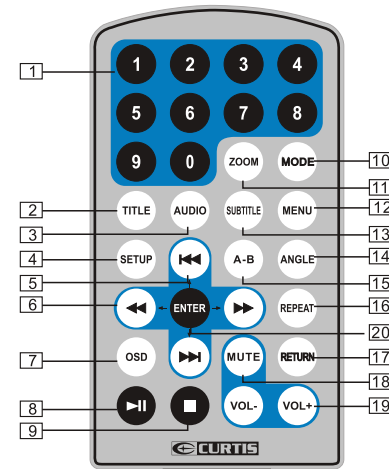

- | | |
|---|--|
| 1. Number button | 11. ZOOM (To zoom in/out the image during the playback) |
| 2. TITLE (To display title information) | 12. Menu (To enter or exit menu root) |
| 3. AUDIO (To select audio language) | 13. Subtitle (To select subtitle language when playing DVD disc) |
| 4. SETUP (To go to or exit setup menu) | 14. Angle (To change viewing angle when playing disc with multi-angle) |
| 5. Previous/Next button (To go to previous/next chapter or scene during playing) | 15. A-B (Repeat a specific portion from point A to B, press it again to cancel repeat playing) |
| 6. Fast forward/backward button (To scan forward/backward at 2, 4, 8, 16, or 32 times) | 16. Repeat (To repeat playing title, chapter or track) |
| 7. OSD (To display disc information during playing such as elapsed and remaining time) | 17. Return (To return to the main menu) |
| 8. Play/pause | 18. MUTE (To turn to mute) |
| 9. Stop (press once to stop playback, then press ► to resume playback from the point where you stopped; press stop button twice to stop playback completely) | 19. VOL +/- (To adjust the volume) |
| 10. MODE (To select the source) | 20. Enter (To confirm) |

The Use of Remote Control

Please put the battery into the remote control as per below illustration

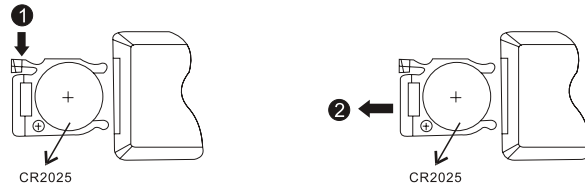

When using remote control, make sure the infrared window is pointed to infrared receiving window of the machine. The distance between machine and remote control must be within 3 metres. Please refer to the following illustration

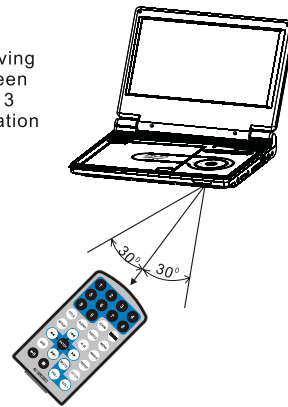

Notice

1. To avoid falling off or place near damp environment.
2. To avoid infrared receiving window of the unit being under direct sunlight
3. Please use a new battery to replace old one if the remote control doesn't work.

8

Basic Operation



Playing disc of DVD, MPEG4, SVCD, VCD, CD, MP3, Xvid

1. After connecting power to the unit, turn on the unit by sliding the ON/OFF switch to ON, the source menu will be displayed on the screen:

DVD
MEDIA

Press ◀▶ to enter DVD mode or Media mode and press ENTER button to confirm. When selecting "Media", ensure to insert USB or SD/MMC/MS card properly.

2. Open the disc door and insert a disc into the door with the label side facing up.
3. Close the disc door. The unit will load the disc and start playing.
4. Press ■ once to stop playback; then press ▶ to resume playback from the point where you stopped; press ■ twice to stop playback completely.
5. During playback, press ▶ to pause; press it again to resume playback.
6. When the playing is finished, please turn off the power by sliding ON/OFF switch to OFF.
7. For some DVD disc with Title or Chapter menu, press "MENU" button to enter menu page, and use ◀▶◀▶ to select. Press ENTER to confirm.

Note: Please do not disconnect USB devices or plug out SD/MMC/MS cards while they are working with the unit. Functional failure may occur in case of wrong operations.

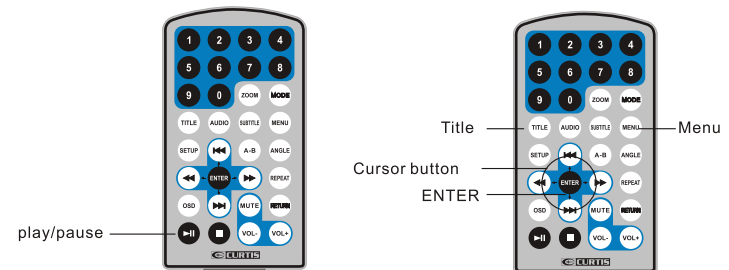

9

Fast forward and fast backward



When playing disc of DVD, MPEG4, SVCD, VCD, CD, the unit can search forward or backward.

1. Press **▶▶**, the unit will search forward. Press it repeatedly, the unit will play at 2, 4, 8, 16, 32 times of speed.

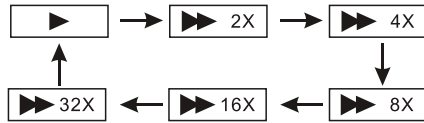

2. Press **◀◀**, the unit will search backward. Press it repeatedly, the unit will play at 2, 4, 8, 16, 32 times of speed.

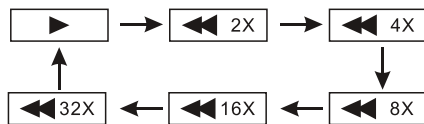

Repeat playing



When playing disc of DVD, MPEG4, SVCD, VCD, CD, user can repeat playing one chapter, title or all the whole disc.

For DVD disc, press "repeat" button, user can repeat playing one Chapter; press it again to repeat playing Title; press it the third time to repeat playing the whole disc.

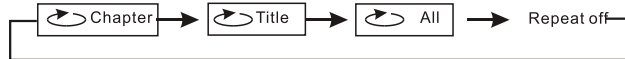

For MP3 disc, press "repeat" to repeat playing present file; press it again to repeat playing the folder; press it the third time to cancel repeat playing.

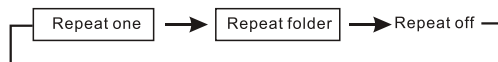

Repeat playing of favorite scene



When playing disc of DVD, MPEG4, SVCD, VCD, CD, Mp3, user can repeatedly play a specific section.

During playback, press "A-B" button at a point A, then press this button again in point B, the unit will automatically repeat playing the part between A-B

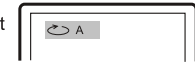

Press it the third time, the unit will return to normal playback.

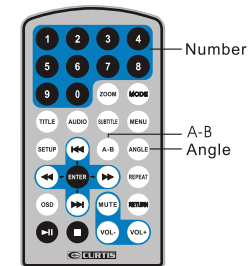

Angle

During playing DVD disc with multi-angle, press "Angle" button, the followings will be displayed on screen:



Press number buttons to select the angle you desire



To return to normal playing, please press "Angle". The unit will play the disc in the default angle.



Notice

The function is available only for discs with multi-angle.



Zoom in/ out

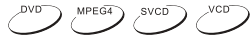

When playing disc of DVD, MPEG4, SVCD, VCD, user can zoom in or zoom out the image .

During playback, press "Zoom " button, the image will be enlarged; press it again the image will be enlarged again; press it fourth time, the image will zoom out, press it repeatedly and the image will return to normal status.

When the image is enlarged, user can press◀▶ to move the image



Zoom in/out

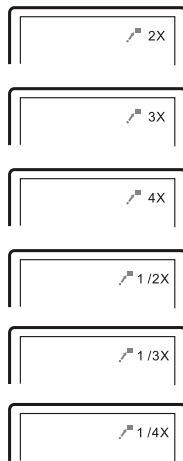

Playing JPG file

1. Place a JPG disc into the tray, the unit will start reading and play.
2. Press "MENU" to browse JPG files.
3. Press ▲▼ to select a JPG file and press "ENTER" button to confirm.
Note: you can press MENU to return to the folder list. Press ▶◀ or "ENTER" to preview the file selected.
4. To rotate the picture counter-clockwise, press"◀"; Press"▶" to rotate the picture clockwise .
5. Press OSD button when viewing pictures, you can select different refresh mode as follows:
 - 1). from top to bottom
 - 2). from bottom to top
 - 3). from left side to right side
 - 4). from right side to left side
 - 5). from left top to right bottom
 - 6). from right top to left bottom
 - 7). from left bottom to right top
 - 8). from right bottom to left top
 - 9). from horizontal center to both sides
 - 10). from vertical center to both sides
 - 11). from top and bottom to center.
 - 12). from right and left to center.
 - 13). from four window's top side to bottom side.
 - 14). from four window's left side to right side.
 - 15). from 4 edges to center.
6. During viewing files, "⊗" may appear when pressing"Angle"or "Subtitle" or "Audio" or "A-B" or "Title" etc; in this situation these options are unavailable to operate.
7. When viewing JPG files, press "■", pictures will be displayed in thumbnail mode, press ▲▼◀▶ and "ENTER" button to select one picture to view .

Playing MP3 files

- 1.Place MP3 disc into the disc door or insert USB disc, SD/MMC/MS card to USB port or SD/MMC/MS card slot.
Press "▲/▼" and "ENTER" button to choose a MP3 file; Press "ENTER" button to play the file selected.

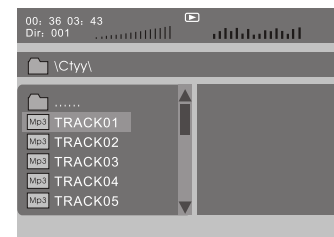

Connecting with USB and SD/MMC/MS card

USB

You can play video/audio/picture files stored in an USB by inserting it into the USB slot.(USB cable not included)

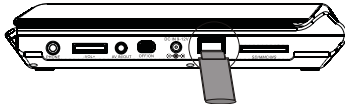

SD/MMC/MS card

You can play video/audio/picture files stored in SD/MMC/MS card by inserting it into the SD/MMC/MS card slot with label side upward.(SD/MMC/MS card not included)

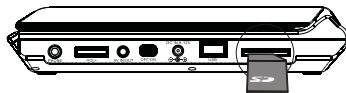

Note: Please do not disconnect USB devices or plug out SD/MMC/MS cards while they are working with the unit. Functional failure may occur in case of wrong operations.

System Setup

	<p>Press "Setup" button, the main menu will be displayed on the screen In the General Setup Page, Press ◀▶ button to highlight this item. Press ENTER button to access. Press ▲▼ button to select the setting. Press ENTER button to confirm your selection. Press ◀ button to exit.</p>
--	--

General Setup Page

	<p>TV display: Enter this option, user can set screen display format (Normal/PS, Normal/LB, Wide) The default is "Wide" Note: ☆ The function depends on the display ratio with which the DVD disc is recorded. ☆ Please choose "Wide(16:9)" when using a 16:9 wide screen TV set</p>
	<p>Angle Mark: Enter this option to set the angle during playback. Optional setting: ON, OFF The default is: ON</p>
	<p>TV Type: Enter this option to select TV type(PAL, NTSC) The default is PAL.</p>
	<p>Screen Saver: Enter this option to set whether to activate the screen saver function. The default is ON.</p>

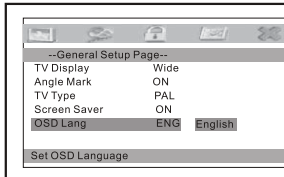

OSD Language:
In the option user can set OSD menu language(English).
The default:English

Video Setup Page

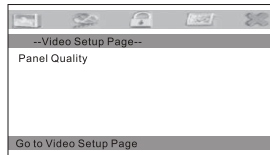

Enter this option, user can adjust picture quality of video output. There are four items available to be adjusted: Brightness, Contrast, Hue and Saturation.
For all these items the default is 00

Password Setup Page

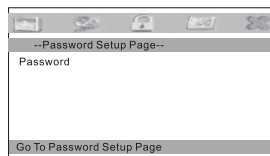

Enter this option, you can set a password(four numbers).
All parental Control features are password protected.

The default is 8888.

Preference Page

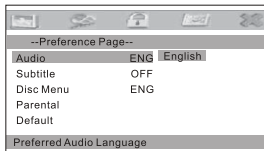

Audio:
The default is English.

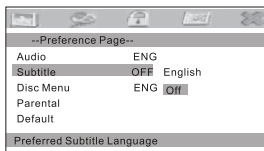

Subtitle:
The default is OFF
The subtitle languages depend on the information available on each disc.

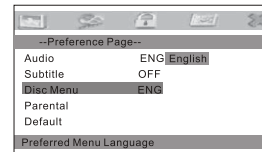

Disc Menu:
This function allows you to choose the menu language stored on the disc.
The default is English.
Note: the disc menu languages depend on the information available on the disc.

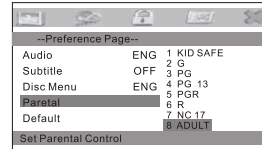

Parental:
Enter this option to set the parental control level to some unsuitable disc scenes being watched by the children.
Optional parental control levels: KID SAFE, G, PG, PG 13, PGR, R, Nc17, ADULT.

The default of this option is ADULT.

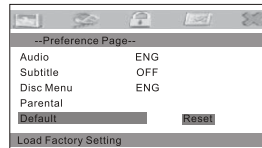

Default:
Select this item and press OK button to reset all settings to the original factory settings.

Specification

Compatible disc: DVD/VCD/CD/MP3/MPEG4
 Signal system: PAL/NTSC
 Panel size: 9 inch
 Picture resolution: 640x234(RGB)
 Frequency response: 20 Hz to 20 kHz
 Video output: 1 Vp-p/75 Ohm, unbalanced
 Audio output: 1.4Vrms/10kOhm
 Audio S/N: Better than 80 dB
 Dynamic range: Better than 85 dB
 USB: support USB 1.1
 Laser: Semiconductor Laser, Wave Length: 650 nm/795 nm
 Power source: DC 9-12V
 Power consumption: 10 W
 Operating temperature: 0~40°C
 Weight: 0.99kg
 Dimensions (W x D x H): 234 x 185 x 42 mm
 Battery Type: Li Polymer

Rechargeable battery use

The unit utilizes long-life Li polymer battery for portable power supply. The battery has no "Memory Effect" and thus can be recharged safely regardless of whether the battery is fully or partially discharged. It's enough to recharge no longer than 6H each time, fully recharged battery can last about 2 hours.

Precautions related to Battery Recharge

The battery can be only recharged when turning power to OFF state, and keep continuous power supply, the red light will be on, and the light will turn yellow when it's fully charged.

Using and Maintaining Rechargeable Battery

1. The normal working temperature is: 0°C ~40°C ;
2. Always unplug AC/DC power supply for the unit when not in use;
3. Heat will create during playing, it's normal, while avoid long time playing and unattended;
4. Avoid having the unit collide with any objects, and place away from all possible heat sources or damp areas.

Troubleshooting

PROBLEM	SOLUTION
No sound or distorted sound	Make sure the machine is connected properly. Make sure all cables are securely inserted into the appropriate jacks.
Can't advance through a movie	You can't advance through the opening credits and warning information that appears at the beginning of movies because the disc is programmed to prohibit that action.
The icon  appears on screen	The feature or action cannot be completed at this time because: 1. The disc's software restricts it. 2. The disc's software doesn't support the feature (e.g., angles) 3. The feature is not available at the moment. 4. You've requested a title or chapter number that is out of range.
Picture is distorted	The disc might be damaged. Try another disc; It is normal for some distortion to appear during forward or reverse scan.
No forward or reverse scan	Some discs have sections that prohibit rapid scanning or chapter skip; If you try to skip through the warning information and credits at the beginning of a movie, you won't be able to. This part of the movie is often programmed to prohibit skipping through it.

Owing to continuous improvement, no prior notice will be given regarding changes on above feature and spec.

Free Manuals Download Website

<http://myh66.com>

<http://usermanuals.us>

<http://www.somanuals.com>

<http://www.4manuals.cc>

<http://www.manual-lib.com>

<http://www.404manual.com>

<http://www.luxmanual.com>

<http://aubethermostatmanual.com>

Golf course search by state

<http://golfingnear.com>

Email search by domain

<http://emailbydomain.com>

Auto manuals search

<http://auto.somanuals.com>

TV manuals search

<http://tv.somanuals.com>