



Dell™ D1920 monitor

User Manual

- English
- Deutsch
- Français
- Italiano
- Español
- Português
- Русский
- Svenska
- Suomi
- Dansk
- Polski
- Nederlands
- 简体中文
- 繁體中文
- 日本語
- 한국어
- Norsk

Model: D1920f



PRECAUTIONS

Information for users applicable in United States of America	1
Installation	1
Power connection	1
Maintenance	1
Transporting the monitor	1

GETTING STARTED

Package contents	2
Monitor installation	2
Identifying parts and controls	3
Working with OSD Group	3
Customizing Your Monitor	3
Hotkeys	4
Function Keys Operation	4
OSD Icon List	5

Troubleshooting	6
-----------------------	---

Technical Features and Specifications	7
---	---



PRECAUTIONS

Information for users applicable in United States of America



LAMP(S) INSIDE THIS PRODUCT CONTAIN MERCURY AND MUST BE RECYCLED OR DISPOSED OF ACCORDING TO LOCAL, STATE OR FEDERAL LAWS. FOR MORE INFORMATION, CONTACT THE ELECTRONIC INDUSTRIES ALLIANCE AT WWW.EIAE.ORG. FOR LAMP SPECIFIC DISPOSAL INFORMATION CHECK WWW.LAMPRECYCLE.ORG.

Installation

1. Do not cover or block the ventilation ports on the rear of the monitor.
2. Do not install the monitor close to heat sources such as radiators or air ducts, or in a location exposed to direct sunlight, excessive dust, mechanical vibration, or shock.
3. The apparatus shall only be used between 5° tilted forward and 15° tilted backward as normal operation position. If the tilt angle exceeds 15°, it shall be used for wall mounting or packaging only.

Power connection

1. Use the correct power cord for your local voltage.
2. Use an accessible outlet close to the monitor.
3. Do not allow anything to rest on the power cable.
4. Only use the power adapter attached to the monitor.
5. Disconnect the power cable from the power supply if:
 - 5.1 You will not use the monitor for an extended period.
 - 5.2 The cable is damaged or frayed.
 - 5.3 The monitor has been dropped or the cabinet damaged.
 - 5.4 A distinct change in performance indicates a need for servicing.

Maintenance

1. Clean the cabinet and controls with a soft cloth lightly moistened with a mild detergent solution. Do not use any abrasive materials or solvents such as alcohol or benzene.
2. Do not rub, touch, or tap the surface of the screen with sharp or abrasive items such as pens or screwdrivers, as the screen may scratch.
3. Do not insert objects or spill liquids into the ventilation ports on the monitor's rear, as fire, electric shock, and / or unit failure may result.

Transporting the monitor



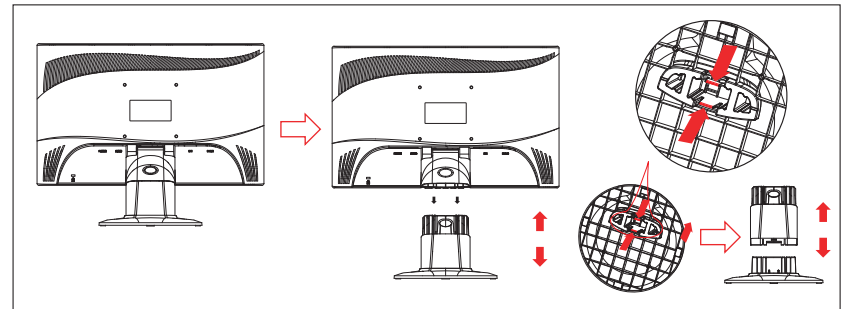

1. When carrying the display for repair or service, disassemble the monitor and pack in its original packing. To disassemble the neck and base, press the "release button" located on the back of the neck and detach the neck/base, then remove the base from the neck by pressing the "release tabs" located under the base plate and pull the neck off the base, finally use the original carton and packing materials to wrap the display and its accessories.

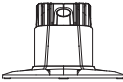

GETTING STARTED

Package contents

Before beginning, ensure that the carton contains the following items:

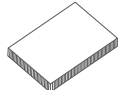
	1. LCD Monitor
	2. Monitor Base and Neck (the shape of base may vary according to the monitor model)
	3. Power Cord (plug may vary according to the electrical standards for your area)
	4. Analog Signal Cable
	5. CD-ROM (contains user manual)
	6. Quick Installation Guide

Monitor installation

1. Setting up the monitor

- 1.1 Take out the monitor, stand and monitor base from the package.
- 1.2 Place the monitor base on the desk and then slide the neck into the slots of base. (Make sure the direction of the neck is correct.)
- 1.3 Hold the monitor and then slide the monitor into the neck. (Make sure the direction of the neck is correct)

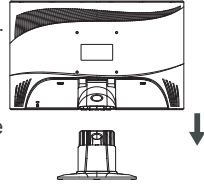

2. Connecting signal cable

- 2.1 Switch off your computer
- 2.2 Connect the signal cable to the D-SUB port at the rear of the monitor and tighten the connector screws
- 2.3 Connect the other end of signal cable to the computer's VGA port and tighten the connector screws.
- 2.4 Note: Ensure the display setting does not exceed 1366 X 768 @ 60Hz.

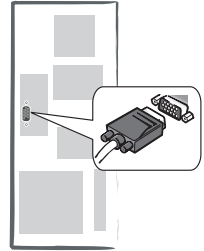

3. Connecting power

Connect one end of the power cable to the monitor and the other end to a power outlet.

4. Switching on

Switch on your computer.

You should now be able to see the picture. If not, see the troubleshooting section of this guide.

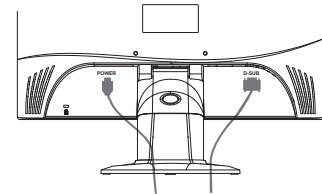

Identifying parts and controls

1. The color of the LED light on the power button  determines the monitor state. The LED light is bright blue when the monitor is fully operational, and it is orange when inactive.
2. The function keys are used to adjust the settings of your monitor. For more information on function keys, see "**Function Keys Operation**" on page 4.

Working with OSD Group

You can identify the function of a button through the corresponding icon displayed on the pop-up window of OSD. The following images show that the buttons on the monitor can be used for multiple tasks.



First Level

1. Press  button to start.
2. Press any of the rest 4 buttons to activate the OSD menu.
3. Press the corresponding function icon button on the pop-up window of the OSD.

Customizing Your Monitor

The On Screen Display (OSD) system provides a full range of customizable tools to optimize your display.

Important:

Although you could perform comprehensive customization, we strongly recommend that you use the "AUTO ADJUSTMENT" function.

It can utilize the default values to thoroughly optimize the performance of the display. Activate the OSD menu.

Select the first button on the left  to activate the "AUTO ADJUSTMENT" function.

Important:

In addition, we have also prepared other relatively simple methods to change the display modes. There are 4 modes, which include: GENERAL, MOVIE, PICTURE, GAME.



Hotkeys

1.Auto Adjustment

When the OSD functions are displayed, press the first button on the left **AUTO** , and then you can automatically optimize the image performance.

2.Theme Mode Menu

When the OSD functions are displayed, press the second button on the left **+** to shift the mode. You may press **←** and **→** to make adjustments between 4 modes. Press **EXIT** , and then you can leave automatically.

3.Main Menu

When the OSD functions are displayed, press the second button on the right **MEM** to enter the main menu. And then press **←** or **→** to select the option. Press **OK** to enter into the option. Press **↶** or **EXIT** to leave.

Function Keys Operation







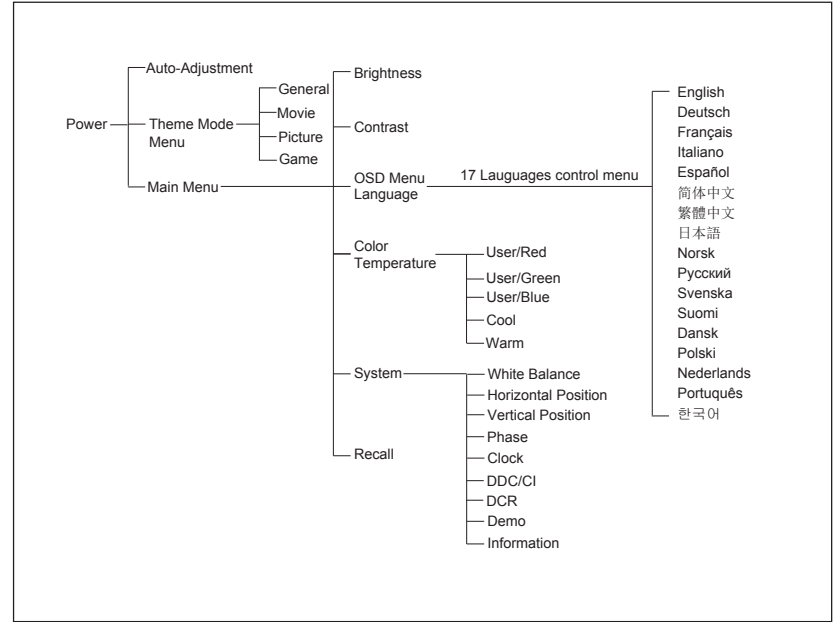



The following illustration shows the options that can be accessed through the OSD main menu.







To navigate through the OSD menu:

1. Activate the OSD main menu: Under the energized condition, press any function key to execute the function.
2. Confirm the selection: Press the **OK** button.
3. Browse the previous or next option: Press **←** and **→** .
4. Adjust the option value: Press **+** and **-** to adjust the value.
5. Return to the higher level menu. Press **↶** to return to the higher level.
6. Exit: Press **EXIT** to exit OSD menu; Or if you do not press any button, it will automatically disappear after 30 seconds.



OSD Icon List

Icon	Functions	Detail
	AUTO ADJUSTMENT	* Optimize the picture performance automatically.
	THEME MODE	* Activate the built-in color engine to enhance the graphic effects according to the different situations of the display contents
	BRIGHTNESS	* Adjust the luminance level of the screen.
	CONTRAST	* Adjust the contrast level of the screen.
	OSD MENU LANGUAGE	* Select your own preference of language of OSD menu.
	COLOR TEMPERATURE	* Select the setting of screen color-Cool, Warm or User. * Cool: Select the setting of screen color to be bluish white. * Warm: Select the setting of screen color to be reddish white.
	SYSTEM	* Adjust the mechanical specifications regarding the display. (White Balance, Clock, Phase, DDC/CI, DCR, DEMO, Horizontal Position, Vertical Position, Information)
	WHITE BALANCE	* Adjust the balance of the input signal.
	HORIZONTAL POSITION	* Shift the screen left or right
	VERTICAL POSITION	* Shift the screen up or down
	DYNAMIC CONTRAST RATIO	* Display high dynamic contrast ratio, and present more colorful screen.

Icon	Functions	Detail
	PHASE	* Adjust the monitor internal signal phase
	CLOCK	* Adjust the monitor internal sampling clock rate
	DDC/CI	* Select turn on or turn off DDC/CI function
	DEMO	* 2 seconds after activation of this function, some of the menus will stimulate feature-grading effects 2 times over.
	INFORMATION	* Show the frequency, resolution, input interface and other operating details about this display.
	RECALL	* Reset monitor parameters back to factory preset values.



Troubleshooting

Symptom	Check Items
1.No picture 2.LED indicator is not lit.	1. Check if the monitor is turned on (press the button  again). 2. Check if the power cord is properly connected to the monitor and power outlet. 3 .Check if there is electricity coming from the power outlet (use another device to check for power).
1.No picture 2.LED indicator is orange	1 Check if your computer is turned on. 2 Ensure the computer is not in power saving mode (move the mouse or press a key on the keyboard to wake up the computer). 3 Check if the video signal cable is properly connected to the monitor and computer.
1.Picture shows " NO SIGNAL INPUT "	1 Check if your computer is turned on. 2 Check if the video signal cable is properly connected to the monitor and computer.
1.Picture shows " INPUT SIGNAL OUT OF RANGE "	1. Ensure that the resolution and/or refresh rate is set correctly.

Important

Make sure your display setup is under VESA 1366 X 768 at 60Hz



Technical Features and Specifications

Item		Description
Panel	Display Size	409.8(H) x 230.4(V) mm
	Pixel Pitch	0.300(H) x 0.300(V) mm
Connector	Analog	D-sub
Tilt	Tilt Angle	-5° ~ 15°
Dimensions (W x H x D)	Net	About 440.4(W) x 353.6(H) x 200.0 (D) mm
	Weight	Net About 3.3 kg
Power	AC	AC 100~240V, 50Hz/60Hz, 1.2A
	Consumption	Active:<25W / Standby:<1W
Interface Frequency	Horizontal	30 ~ 83KHz
	Vertical	50 ~ 75Hz
Operating Condition	Temperature	0°C to 40°C
	Humidity	10% to 90% (No Condensation)
	Altitude	0 ~ 10,000 ft.
Storage Condition	Temperature	-20°C to 60°C
	Humidity	10% to 90% (No Condensation)
	Altitude	0 ~ 40,000 ft.



Free Manuals Download Website

<http://myh66.com>

<http://usermanuals.us>

<http://www.somanuals.com>

<http://www.4manuals.cc>

<http://www.manual-lib.com>

<http://www.404manual.com>

<http://www.luxmanual.com>

<http://aubethermostatmanual.com>

Golf course search by state

<http://golfingnear.com>

Email search by domain

<http://emailbydomain.com>

Auto manuals search

<http://auto.somanuals.com>

TV manuals search

<http://tv.somanuals.com>