

Dell™ U2413/U2713H Monitor

[User's Guide](#)

[Setting the display resolution](#)

Information in this document is subject to change without notice.

© 2012 Dell Inc. All rights reserved.

Reproduction of these materials in any manner whatsoever without the written permission of Dell Inc. is strictly forbidden.

Trademarks used in this text: *Dell* and the *DELL* logo are trademarks of Dell Inc.; *Microsoft* and *Windows* are either trademarks or registered trademarks of Microsoft Corporation in the United States and/or other countries, *Intel* is a registered trademark of Intel Corporation in the U.S. and other countries; and *ATI* is a trademark of Advanced Micro Devices, Inc. has determined that this product meets the ENERGY STAR guidelines for energy efficiency.

Other trademarks and trade names may be used in this document to refer to either the entities claiming the marks and names or their products. Dell Inc. disclaims any proprietary interest in trademarks and trade names other than its own.

Model U2413f / U2713Hb

November 2012 Rev. A00

Dell™ U2413/U2713H Monitor User's Guide

[About Your Monitor](#)

[Setting Up the Monitor](#)

[Operating the Monitor](#)

[Troubleshooting](#)

[Appendix](#)

Notes, Cautions, and Warnings



NOTE: A NOTE indicates important information that helps you make better use of your computer.



CAUTION: A CAUTION indicates potential damage to hardware or loss of data if instructions are not followed.



WARNING: A WARNING indicates a potential for property damage, personal injury, or death.

Information in this document is subject to change without notice.

© 2012 Dell Inc. All rights reserved.

Reproduction of these materials in any manner whatsoever without the written permission of Dell Inc. is strictly forbidden.

Trademarks used in this text: *Dell* and the *DELL* logo are trademarks of Dell Inc; *Microsoft* and *Windows* are either trademarks or registered trademarks of Microsoft Corporation in the United States and/or other countries, *Intel* is a registered trademark of Intel Corporation in the U.S. and other countries; and *ATI* is a trademark of Advanced Micro Devices, Inc. ENERGY STAR is a registered trademark of the U.S. Environmental Protection Agency. As an ENERGY STAR partner, Dell Inc. has determined that this product meets the ENERGY STAR guidelines for energy efficiency.

Other trademarks and trade names may be used in this document to refer to either the entities claiming the marks and names or their products. Dell Inc. disclaims any proprietary interest in trademarks and trade names other than its own.

Model U2413f / U2713Hb

November 2012 Rev. A00

About Your Monitor

Dell™ U2413/U2713H Monitor User's Guide

- [Package Contents](#)
- [Product Features](#)
- [Identifying Parts and Controls](#)
- [Monitor Specifications](#)
- [Plug and Play Capability](#)
- [Universal Serial Bus \(USB\) Interface](#)
- [Card Reader Specifications](#)
- [LCD Monitor Quality and Pixel Policy](#)
- [Maintenance Guidelines](#)

Package Contents

Your monitor ships with the components shown below. Ensure that you have received all the components and [contact Dell](#) if something is missing.

 **NOTE:** Some items may be optional and may not ship with your monitor. Some features or media may not be available in certain countries.

 **NOTE:** To set up with any other stand, please refer to the respective stand setup guide for setup instructions.

	<ul style="list-style-type: none">• Monitor

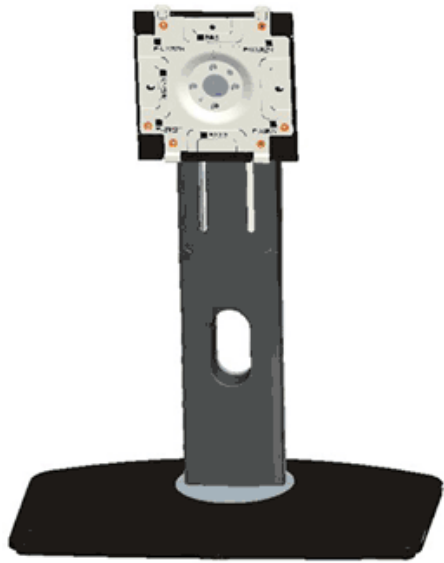

- Stand





- Power cable (varies by countries)



- DisplayPort cable (Mini-DP to DP)



- U2413: DVI-D cable (Single Link)
U2713H: DVI-D cable (Dual Link)

	USB 3.0 upstream cable (enables the USB ports on the monitor)
	<ul style="list-style-type: none"> • Velcro cable tie
	<ul style="list-style-type: none"> • <i>Product and Safety Information Guide</i> • <i>Quick Setup Guide</i> • <i>Factory Calibration Report</i> • <i>Drivers and Documentation media</i>

Product Features

The **Dell U2413/U2713H** flat panel display has an active matrix, Thin-Film Transistor (TFT), Liquid Crystal Display (LCD) and LED backlight. The monitor features include:

- **U2413:** 60.96 cm (24.0-inch) viewable area display (measured diagonally). 1920 x 1200 resolution, plus full-screen support for lower resolutions.
- **U2713H:** 68.47 cm (27.0-inch) viewable area display (measured diagonally). 2560 x 1440 resolution, plus full-screen support for lower resolutions.
- Wide viewing angle to allow viewing from a sitting or standing position, or while moving from side-to-side.
- Tilt, swivel, vertical extension and rotate adjustment capability.
- Removable stand and Video Electronics Standards Association (VESA™) 100 mm mounting holes for flexible mounting solutions.
- Plug and play capability if supported by your system.
- On-Screen Display (OSD) adjustments for ease of set-up and screen optimization.
- Software and documentation media includes an Information File (INF), Image Color Matching File (ICM), Dell Display Manager software application, Color Calibration Software and product documentation.
- Security lock slot.
- Stand lock.
- Asset Management Capability.
- Capability to switch from wide aspect to standard aspect ratio while maintaining the image quality.
- TCO-Certified Displays.
- Dell Display Manager software included (comes in the CD shipped with the monitor).
- Arsenic-Free glass and Mercury-Free for the panel only.
- High Dynamic Contrast Ratio (2,000,000:1).
- BFR/PVC-reduced.
- Energy Gauge shows the energy level being consumed by the monitor in real time.

- EPEAT Gold Rating.
- Energy Saver feature for Energy Star compliance.
- Compatible with Adobe and sRGB color standards.
- Factory calibrated sRGB and Adobe RGB input source for brand new Dell U2413/U2713H monitor. Dedicated Custom Color Mode (6-axis Color-control) for Saturation , Hue, Gain (RGB) and offset (RGB).
- 12-bit internal processing which tested HDMI with deep color (12-bit).
- 12-bit internal processing with 14-bit LUT.
- USB 3.0 Card Reader (SD/Mini SD, MS/HSMD/MSPRO, MMC).
- Supports DVI-D, DisplayPort, Mini DisplayPort, HDMI, DP1.1a, DP 1.2 MST (also known as DP Daisy Chain) and HBR2 (Default out of factory setting is DP1.1a. To enable MST and HBR2, refer to instruction on section "[Connecting the Monitor for DP MST Function](#)").
- Supports Picture by Picture (PBP) and Picture in Picture (PIP) Select mode.

Identifying Parts and Controls

Front View

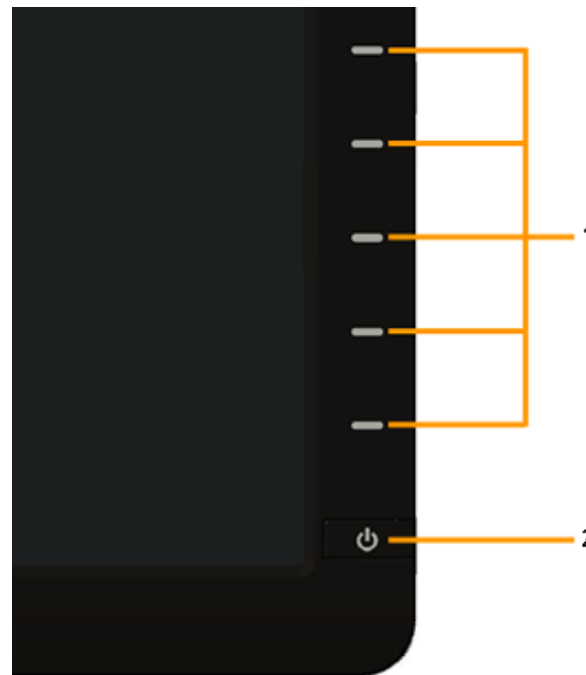

Front panel controls

Label	Description
1	Function buttons (For more information, see Operating the Monitor)
2	Power On/Off button (with LED indicator)

Back View

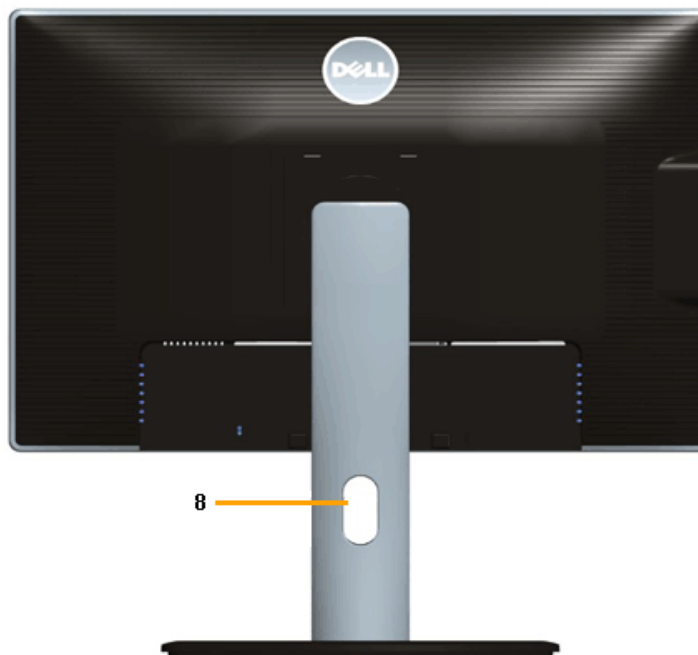

Back View with monitor stand

Label	Description	Use
1	VESA mounting holes (100 mm x 100 mm - behind attached VESA Plate)	Wall mount monitor using VESA-compatible wall mount kit (100 mm x 100 mm).
2	Regulatory label	List the regulatory approvals.
3	Stand release button	Release stand from monitor.
4	Connector label	Indicate the connector locations.
5	Security lock slot	Secure monitor with security cable lock.
6	Dell Soundbar mounting brackets	Attach the optional Dell Soundbar.
7	Barcode serial number label	Refer to this label if you need to contact Dell for technical support.
8	Cable management slot	For cable management. Route cables through the slot.

Side View

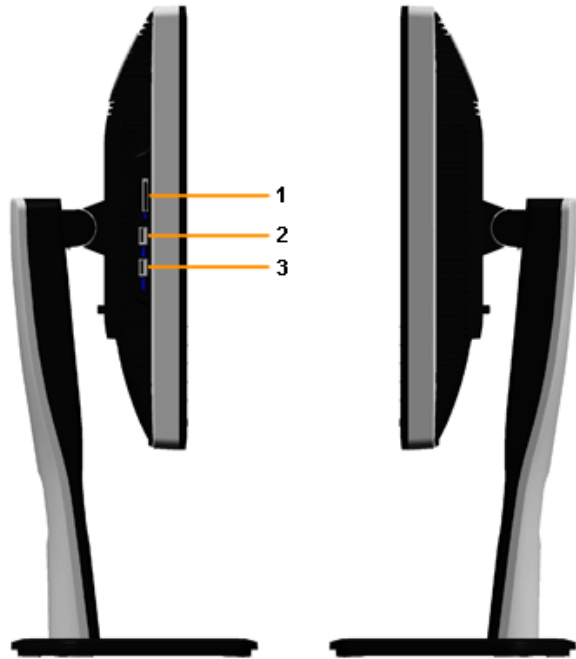

Label	Description	Use
1	Card Reader	See Card Reader Specifications for more information.
2	USB Down Stream Port	Connect your USB devices.
3	USB Down Stream Port	Connect your USB devices. This USB port supports BC 1.2 compliance charging devices, at 1.5A max for fast charging.

Bottom View

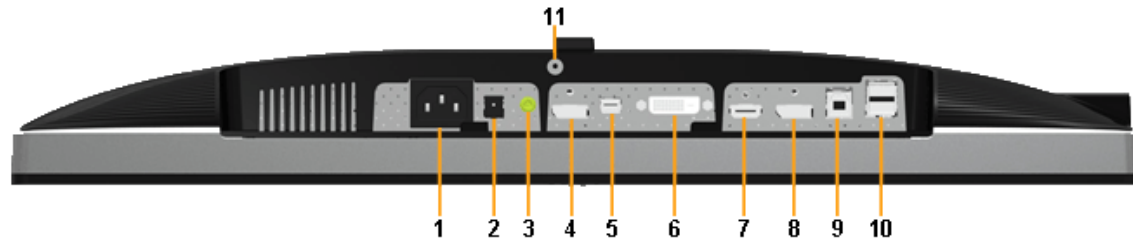

Bottom view without monitor stand

Label	Description	Use
1	AC power cord connector	Connect the power cable.
2	DC power connector for Dell Soundbar	Connect the power cord for the soundbar (optional).
3	Audio Out	Connect the soundbar mini stereo plug (Support two channel output).
4	DisplayPort in connector	Connect your computer with DP cable.
5	Mini DisplayPort in connector	Connect your computer with Mini DP to DP cable
6	DVI connector	Connect your computer with DVI cable. For U2713H, use only DVI dual-link cable provided in box (or other certified dual-link cable) for this connection only.
7	HDMI connector	Connect your computer with HDMI cable.
8	DisplayPort out (MST) connector	DisplayPort output for MST (Multi-Stream Transport) capable monitor. DP 1.1 monitor can only be connected as the last monitor in the MST chain. To enable MST, refer to instruction on section " Connecting the Monitor for DP MST Function ".
9	USB upstream port	Connect the USB cable that came with your monitor to the computer. Once this cable is connected, you can use the USB connectors on the monitor.
10	USB downstream port	Connect your USB device. You can only use this connector after you have connected the USB cable to the computer and USB upstream connector on the monitor.
11	Stand lock feature	To lock the stand to the monitor using a M3 x 6 mm screw (the screw is not provided).

 **NOTE:** Headphone usage is not supported for the audio line out connector.

Monitor Specifications

Flat Panel Specifications

Model	U2413	U2713H
Screen type	Active matrix - TFT LCD	Active matrix - TFT LCD
Panel type	AH In-plane switching	AH In-plane switching
Screen dimensions	609.6 mm (24-inches diagonal viewable image size)	684.7 mm (27-inches diagonal viewable image size)
Preset display area:		
Horizontal	518.4 mm (20.4 inches)	596.7 mm (23.49 inches)
Vertical	324.0 mm (12.8 inches)	335.7 mm (13.21 inches)
Pixel pitch	0.27 mm	0.231 mm
Viewing angle	178° (vertical) typical 178° (horizontal) typical	178° (vertical) typical 178° (horizontal) typical
Luminance output	350 cd/m ² (typical), 50 cd/m ² (minimum)	350 cd/m ² (typical), 50 cd/m ² (minimum)
Contrast ratio	1000 to 1 (typical) 2M to 1 (typical Dynamic Contrast On)	1000 to 1 (typical) 2M to 1 (typical Dynamic Contrast On)
Faceplate coating	Antiglare with hard-coating 3H	Antiglare with hard-coating 3H
Backlight	LED edgelight system	LED edgelight system
Response time	6 ms gray-to-gray (typical)	6 ms gray-to-gray (typical)
Color depth	1.07 billion colors	1.07 billion colors
Color gamut	103%* (CIE 1931), 120% (CIE 1976)	103%* (CIE 1931), 120% (CIE 1976)
Backlight Life (to half initial brightness)	30K hours (typical)	30K hours (typical)

*[U2413/U2713H] sRGB coverage is 100% (based on CIE 1931 and CIE 1976), AdobeRGB coverage is 99%(based on CIE 1931 and CIE 1976) .

Resolution Specifications

Model	U2413	U2713H
Horizontal scan range	30 kHz to 81 kHz (automatic)	29 kHz to 113 kHz (automatic)
Vertical scan range	56 Hz to 76 Hz (automatic)	49 Hz to 86 Hz (automatic)
Maximum preset resolution	1920 x 1200 at 60 Hz	2560 x 1440 at 60 Hz

Supported Video Modes

Model	U2413/U2713H
Video display capabilities (DVI & DP & HDMI playback)	480p, 480i, 576p, 576i, 720p, 1080p, 1080i

Preset Display Modes

U2413

Display Mode	Horizontal Frequency (kHz)	Vertical Frequency (Hz)	Pixel Clock (MHz)	Sync Polarity (Horizontal/Vertical)
VESA, 640 x 480	31.5	60.0	25.2	-/-
VESA, 640 x 480	37.5	75.0	31.5	-/-
VESA, 720 x 400	31.5	70.0	28.3	-/+
VESA, 800 x 600	37.9	60.3	40.0	+/+
VESA, 800 x 600	46.9	75.0	49.5	+/+
VESA, 1024 x 768	48.4	60.0	65.0	-/-
VESA, 1024 x 768	60.0	75.0	78.8	+/+
VESA, 1152 x 864	67.5	75.0	108.0	+/+
VESA, 1280 x 1024	80.0	75.0	135.0	+/+
VESA, 1280 x 1024	64.0	60.0	108.0	+/+
VESA, 1600 x 1200	75.0	60.0	162.0	+/+
VESA, 1920 x 1200	74.0	60.0	154.0	+/-

U2713H

Display Mode	Horizontal Frequency (kHz)	Vertical Frequency (Hz)	Pixel Clock (MHz)	Sync Polarity (Horizontal/Vertical)
VESA, 640 x 480	31.5	60.0	25.2	-/-
VESA, 640 x 480	37.5	75.0	31.5	-/-
VESA, 720 x 400	31.5	70.0	28.3	-/+
VESA, 800 x 600	46.9	75.0	49.5	+/+
VESA, 1024 x 768	48.4	60.0	65.0	-/-
VESA, 1024 x 768	60.0	75.0	78.8	+/+
VESA, 1152 x 864	67.5	75.0	108.0	+/+
VESA, 1280 x 800	49.7	60.0	83.5	-/+
VESA, 1280 x 1024	64.0	60.0	108.0	+/+

VESA, 1280 x 1024	80.0	75.0	135.0	+/+
VESA, 1600 x 1200	75.0	60.0	162.0	+/+
VESA, 1680 x 1050	65.3	60.0	146.3	-/+
VESA, 1920 x 1080	67.5	60.0	148.5	+/+
VESA, 1920 x 1200	74.6	60.0	193.3	-/+
VESA, 2560 x 1440	88.8	60.0	241.5	+/-

Electrical Specifications

Model	U2413	U2713H
Video input signals	<ul style="list-style-type: none"> Digital DVI-D TMDS, 600 mV for each differential line, positive polarity at 50 ohm input impedance DisplayPort*, 600mV for each differential line, 100 ohm input impedance per differential pair HDMI, 600mV for each differential line, 100 ohm input impedance per differential pair 	
AC input voltage/frequency/current	100 VAC to 240 VAC / 50 Hz or 60 Hz \pm 3 Hz / 1.5 A (typical)	
Inrush current	<ul style="list-style-type: none"> 120 V: 42 A (Max.) at 0 °C 220 V: 80 A (Max.) at 0 °C 	

* Support DP1.2 (CORE) specification, include HBR2, MST and DP audio.

Physical Characteristics

Model	U2413	U2713H
Connector type	<ul style="list-style-type: none"> DVI-D, white connector DP, black connector (include DP in and DP out) Mini DP HDMI USB 3.0 	
Signal cable type	<ul style="list-style-type: none"> DVI-D Mini DP to DP HDMI USB 3.0 	
Dimensions (with stand)		
Height (extended)	530.9 mm (20.90 inches)	538.4 mm (21.20 inches)
Height (compressed)	415.9 mm (16.37 inches)	423.4 mm (16.67 inches)
Width	556.0 mm (21.89 inches)	639.3 mm (25.17 inches)
Depth	200.5 mm (7.89 inches)	200.5 mm (7.89 inches)
Dimensions (without stand)		

Height	361.6 mm (14.24 inches)	378.2 mm (14.89 inches)
Width	556.0 mm (21.89 inches)	639.3 mm (25.17 inches)
Depth	67.1 mm (2.64 inches)	74.1 mm (2.92 inches)
Stand dimensions		
Height (extended)	418.4 mm (16.47 inches)	418.4 mm (16.47 inches)
Height (compressed)	372.3 mm (14.66 inches)	372.3 mm (14.66 inches)
Width	314.8 mm (12.39 inches)	314.8 mm (12.39 inches)
Depth	200.5 mm (7.89 inches)	200.5 mm (7.89 inches)
Weight		
Weight with packaging	20.57 lb (9.35 kg)	24.09 lb (10.95 kg)
Weight with stand assembly and cables	16.10 lb (7.32 kg)	19.25 lb (8.75 kg)
Weight without stand assembly (For wall mount or VESA mount considerations - no cables)	11.02 lb (5.01 kg)	13.86 lb (6.30 kg)
Weight of stand assembly	3.92 lb (1.78 kg)	4.22 lb (1.92 kg)
Front frame gloss	Black Frame - 5.0 gloss unit (max.)	

Environmental Characteristics

Model	U2413	U2713H
Temperature		
Operating	0 °C to 40 °C (0 °F to 104 °F)	
Non-operating	<ul style="list-style-type: none"> Storage: -20 °C to 60 °C (-4 °F to 140 °F) Shipping: -20 °C to 60 °C (-4 °F to 140 °F) 	
Humidity		
Operating	10% to 80% (non-condensing)	
Non-operating	<ul style="list-style-type: none"> Storage: 5% to 90% (non-condensing) Shipping: 5% to 90% (non-condensing) 	
Altitude		
Operating	5,000 m (16,500 ft) max	
Non-operating	12,192 m (40,000 ft) max	
Thermal dissipation	<ul style="list-style-type: none"> 409.56 BTU/hour (maximum) 204.78 BTU/hour (typical) 	<ul style="list-style-type: none"> 443.58 BTU/hour (maximum) 204.73 BTU/hour (typical)

Power Management Modes

If you have VESA's DPM™ compliance display card or software installed in your PC, the monitor can automatically reduce its power consumption when not in use. This is referred to as *Power Save Mode**. If the computer detects input from the keyboard, mouse, or other input devices, the monitor automatically resumes functioning. The following table shows the power consumption and signaling of this automatic power saving feature:

VESA Modes	Horizontal Sync	Vertical Sync	Video	Power Indicator	Power Consumption	
					U2413	U2713H
Normal operation	Active	Active	Active	White	120 W (maximum) ** 60 W (typical)	130 W (maximum) ** 60 W (typical)
Active-off mode	Inactive	Inactive	Blanked	White (fade in and fade out)	Less than 0.5 W	Less than 0.5 W
Switch off	-	-	-	Off	Less than 0.5 W	Less than 0.5 W

The OSD functions only in the normal operation mode. When any button is pressed in the Active-off mode, one of the following messages will be displayed:

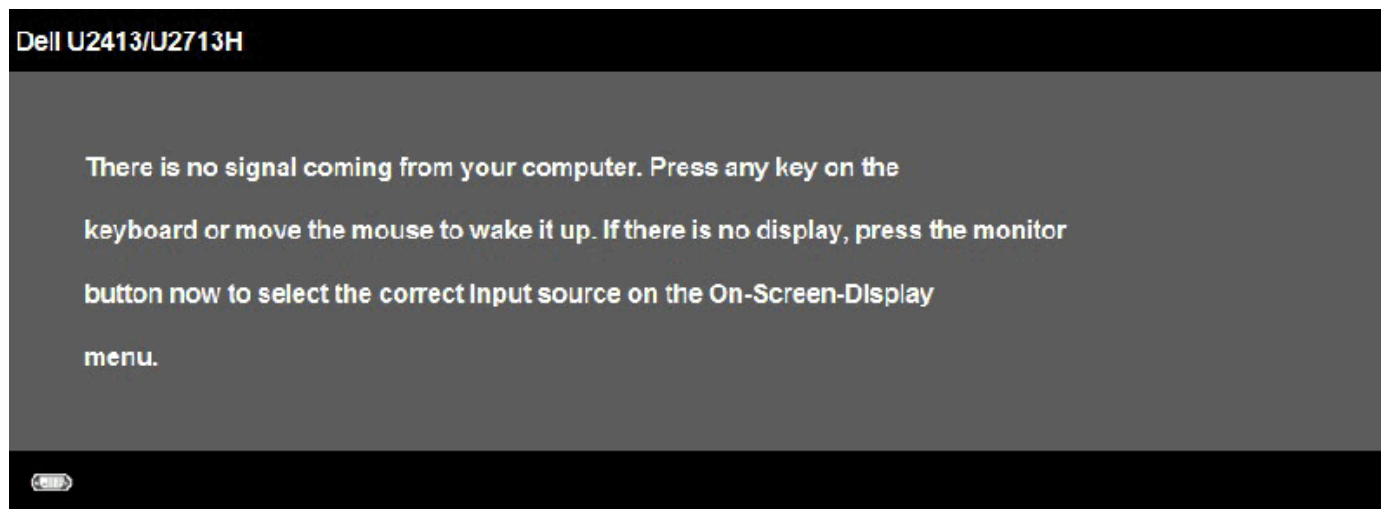

Activate the computer and the monitor to gain access to the OSD.



 **NOTE:** This monitor is **ENERGY STAR**®-compliant.

* Zero power consumption in OFF mode can only be achieved by disconnecting the power cord from the monitor.

** Maximum power consumption with max luminance, Dell Soundbar, and USB active.

Pin Assignments

U2413 DVI Connector

U2713H DVI (Dual link) Connector

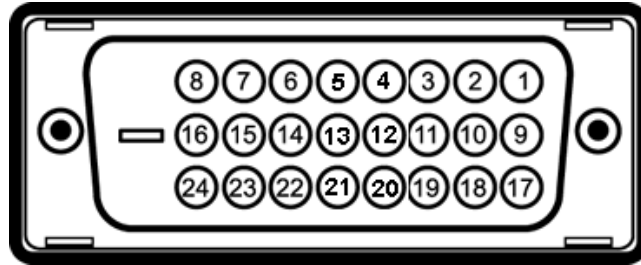

Pin Number	24-pin Side of the Connected Signal Cable
1	TMDS RX2-
2	TMDS RX2+
3	TMDS Ground
4	No Connection
5	No Connection
6	DDC Clock
7	DDC Data
8	No Connection
9	TMDS RX1-
10	TMDS RX1+
11	TMDS Ground
12	No Connection
13	No Connection
14	+5 V power
15	Self test
16	Hot Plug Detect
17	TMDS RX0-
18	TMDS RX0+
19	TMDS Ground
20	No Connection
21	No Connection
22	TMDS Ground
23	TMDS Clock+

Pin Number	24-pin Side of the Connected Signal Cable
1	TMDS RX2-
2	TMDS RX2+
3	TMDS Ground
4	TMDS RX4-
5	TMDS RX4+
6	DDC Clock
7	DDC Data
8	No Connection
9	TMDS RX1-
10	TMDS RX1+
11	TMDS Ground
12	TMDS RX3-
13	TMDS RX3+
14	+5 V power
15	Self test
16	Hot Plug Detect
17	TMDS RX0-
18	TMDS RX0+
19	TMDS Ground
20	TMDS RX5-
21	TMDS RX5+
22	TMDS Ground
23	TMDS Clock+

DisplayPort Connector (DP in and DP out)

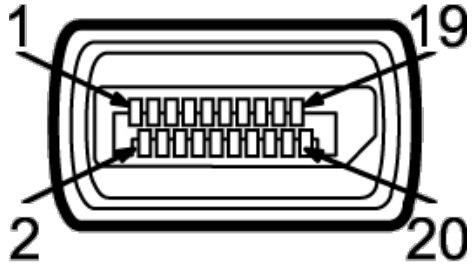

Pin Number	20-pin Side of the Connected Signal Cable
1	ML0(p)
2	GND
3	ML0(n)
4	ML1(p)
5	GND
6	ML1(n)
7	ML2(p)
8	GND
9	ML2(n)
10	ML3(p)
11	GND
12	ML3(n)
13	GND
14	GND
15	AUX(p)
16	GND
17	AUX(n)
18	HPD
19	DP_PWR_Return
20	+3.3 V DP_PWR

Mini DisplayPort Connector

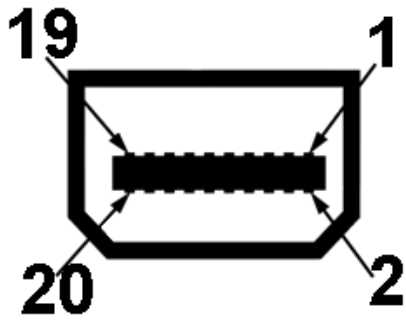

Pin Number	20-pin Side of the Connected Signal Cable
1	GND
2	Hot Plug Detect
3	ML3(n)
4	GND
5	ML3(n)
6	GND
7	GND
8	GND
9	ML2(n)
10	ML0(p)
11	ML2(p)
12	ML0(p)
13	GND
14	GND
15	ML1(n)
16	AUX(p)
17	ML1(p)
18	AUX(n)
19	GND
20	+3.3 V DP_PWR

HDMI Connector

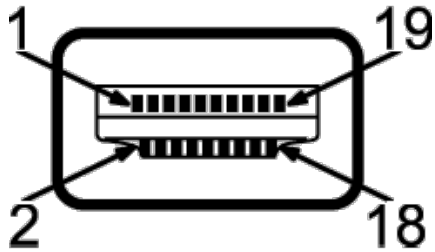

Pin Number	19-pin Side of the Connected Signal Cable
1	TMDS DATA 2+
2	TMDS DATA 2 SHIELD
3	TMDS DATA 2-
4	TMDS DATA 1+
5	TMDS DATA 1 SHIELD
6	TMDS DATA 1-
7	TMDS DATA 0+
8	TMDS DATA 0 SHIELD
9	TMDS DATA 0-
10	TMDS CLOCK
11	TMDS CLOCK SHIELD
12	TMDS CLOCK-
13	No Connection
14	No Connection
15	DDC CLOCK (SDA)
16	DDC DATA (SDA)
17	GROUND
18	+5 V POWER
19	HOT PLUG DETECT

Plug and Play Capability

You can install the monitor in any Plug and Play-compatible system. The monitor automatically provides the computer system with its Extended Display Identification Data (EDID) using Display Data Channel (DDC) protocols so the system can configure itself and optimize the monitor settings. Most monitor installations are automatic; you can select different settings if desired. For more information about changing the monitor settings, see [Operating the Monitor](#).

Universal Serial Bus (USB) Interface

This section gives you information about the USB ports that are available on the monitor.

 **NOTE:** This monitor is Super-Speed USB 3.0 compatible.

Transfer Speed	Data Rate	Power Consumption*
Super-Speed	5G bps	4.5W (Max, each port)
High speed	480M bps	4.5W (Max, each port)
Full speed	12M bps	4.5W (Max, each port)

 **NOTE** *: Up to 1.5A on USB downstream port (port with  lightning icon) with BC1.2 compliance devices.

USB Upstream Connector

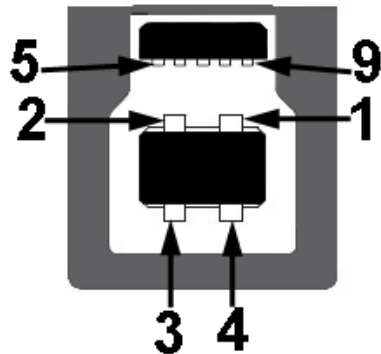

Pin Number	9-pin Side of the Connector
1	VCC
2	D-
3	D+
4	GND
5	SSTX-
6	SSTX+
7	GND
8	SSRX-
9	SSRX+

USB Downstream Connector



Pin Number	9-pin Side of the Connector
1	VCC
2	D-
3	D+
4	GND
5	SSTX-
6	SSTX+
7	GND
8	SSRX-
9	SSRX+

USB Ports

- 1 upstream - back
- 4 downstream - 2 on back; 2 on left side
- Power Charging Port- the lower one of two USB ports on left side (port with  lightning icon) ; supports fast current charging capability if the device is BC1.2 compatible.

 **NOTE:** USB 3.0 functionality requires a USB 3.0-capable computer.

 **NOTE:** The monitor's USB interface works only when the monitor is On or in the power save mode. If you turn Off the monitor and then turn it On, the attached peripherals may take a few seconds to resume normal functionality.

Card Reader Specifications

Overview

- The Flash Memory Card Reader is a USB storage device that allows users to read and write information from and into the memory card.
- The Flash Memory Card Reader is automatically recognized by Microsoft® Windows® Vista and Windows® 7.
- Once installed and recognized, memory card(slot) appears drive letter.
- All standard file operations (copy, delete, drag-and-drop, etc.) can be performed with this drive.

Features

The Flash Memory Card Reader has the following features:

- Supports Microsoft® Windows® Vista and Windows® 7 operating systems
- Mass Storage Class device (No drivers are required under Microsoft® Windows® Vista and Windows® 7)
- Supports various memory card media

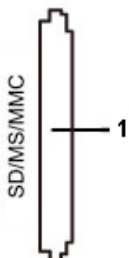

The following table lists the memory cards supported:

Slot Number	Flash memory cards type
1	MS Pro HG, High Speed Memory Stick (HSMS), Memory Stick PRO (MSPRO), Memory Stick Duo(w Adapter), MS Duo Secure Digital (Mini-SD), Secure Digital Card, Mini Secure Digital (w Adaptor), TransFlash (SD, including SDHC), MultiMediaCard (MMC),

Maximum Card Capacity Supported by the U2413/U2713H card reader

Card type	Support Specification	Support Maximum Capacity by Spec	U2413/U2713H
MS Pro HG	Memory Stick Pro-HG Support USB 3.0 speed	32 GB	Supported
MS Duo	Memory Stick Duo Specification	32 GB	Supported
SD	SD Memory Card support USB 3.0 speed	32 GB	Supported
MMC	Multi Media Card System Specification	32 GB	Supported

General

Connection type	USB 2.0/3.0 High Speed Device (USB High Speed Device compatible)
Supported OS	Microsoft® Windows® Vista and Windows® 7

LCD Monitor Quality and Pixel Policy

During the LCD Monitor manufacturing process, it is not uncommon for one or more pixels to become fixed in an unchanging state which are hard to see and do not affect the display quality or usability. For more information on Dell Monitor Quality and Pixel Policy, see Dell Support site at: www.dell.com/support/monitors.

Maintenance Guidelines

Cleaning Your Monitor

 **CAUTION:** Read and follow the [safety instructions](#) before cleaning the monitor.

 **WARNING:** Before cleaning the monitor, unplug the monitor power cable from the electrical outlet.

For best practices, follow the instructions in the list below while unpacking, cleaning, or handling your monitor:

- To clean your anti-static screen, lightly dampen a soft, clean cloth with water. If possible, use a special screen-cleaning tissue or solution suitable for the anti-static coating. Do not use benzene, thinner, ammonia, abrasive cleaners, or compressed air.
- Use a lightly-dampened, warm cloth to clean the monitor. Avoid using detergent of any kind as some detergents leave a milky film on the monitor.
- If you notice white powder when you unpack your monitor, wipe it off with a cloth.
- Handle your monitor with care as a darker-colored monitor may get scratched and show white scuff marks more than a lighter-colored monitor.
- To help maintain the best image quality on your monitor, use a dynamically changing screen saver and turn off your monitor when not in use.

[Back to Contents Page](#)

Setting Up the Monitor

Dell™ U2413/U2713H Monitor User's Guide

- [Attaching the Stand](#)
 - [Connecting the Monitor](#)
 - [Organizing Your Cables](#)
 - [Attaching Dell Soundbar AX510/AY511 \(Optional\)](#)
 - [Removing the Monitor Stand](#)
 - [Wall Mounting \(Optional\)](#)
-

Attaching the Stand

- ✎ **NOTE:** The stand is detached when the monitor is shipped from the factory.
- ✎ **NOTE:** This is applicable for a monitor with a stand. When any other stand is bought, please refer to the respective stand setup guide for the set up instructions.

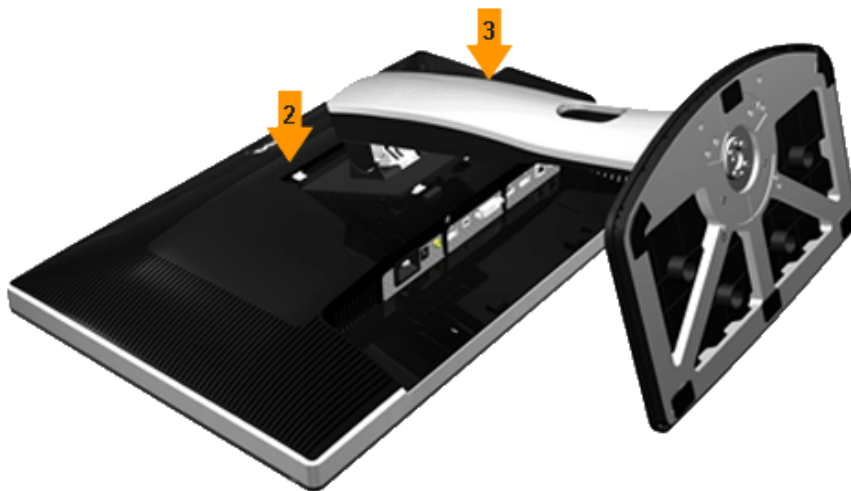

To attach the monitor stand:

1. Remove the cover and place the monitor on it.
 2. Fit the two tabs on the upper part of the stand to the groove on the back of the monitor.
 3. Press the stand till it snaps into place.
-

Connecting Your Monitor

⚠ WARNING: Before you begin any of the procedures in this section, follow the [Safety Instructions](#).

To connect your monitor to the computer:

1. Turn Off your computer and disconnect the power cable.
2. Connect the white (digital DVI-D) or the black (DisplayPort/Mini DP/HDMI) display connector cable to the corresponding video port on the back of your computer.
Do not use the four cables on the same computer. Use all cables only when they are connected to four different computers with appropriate video systems.

Connecting the white DVI cable

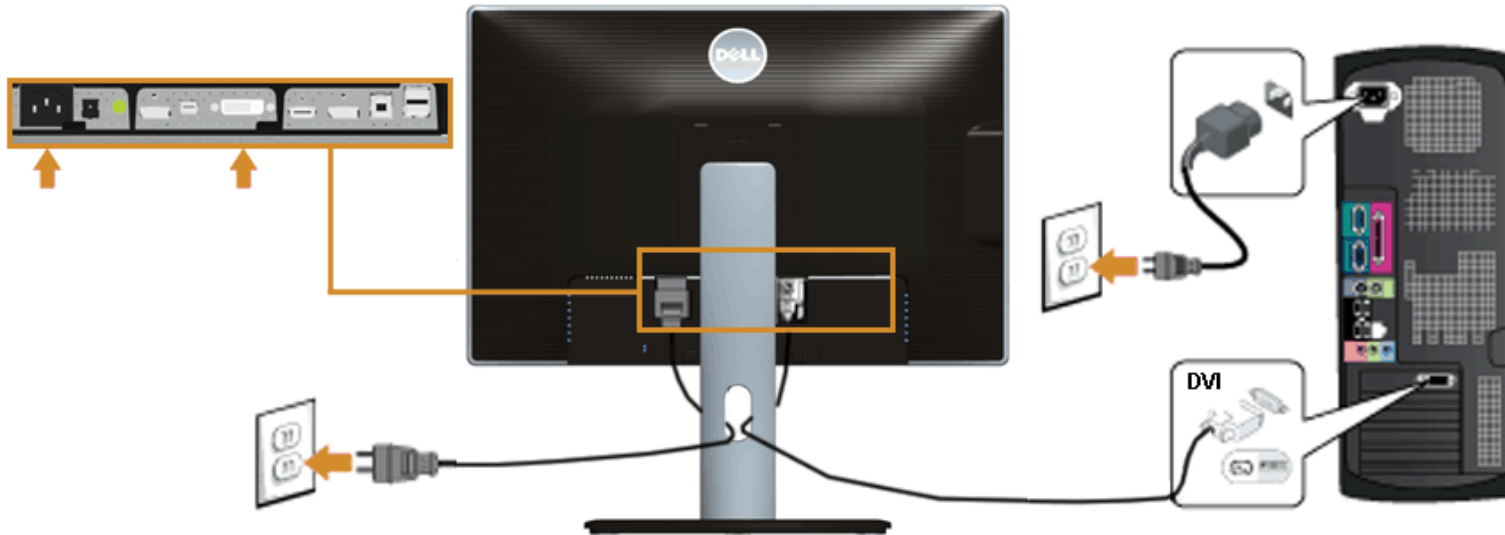

Connecting the black DisplayPort (Mini DP to DP) cable

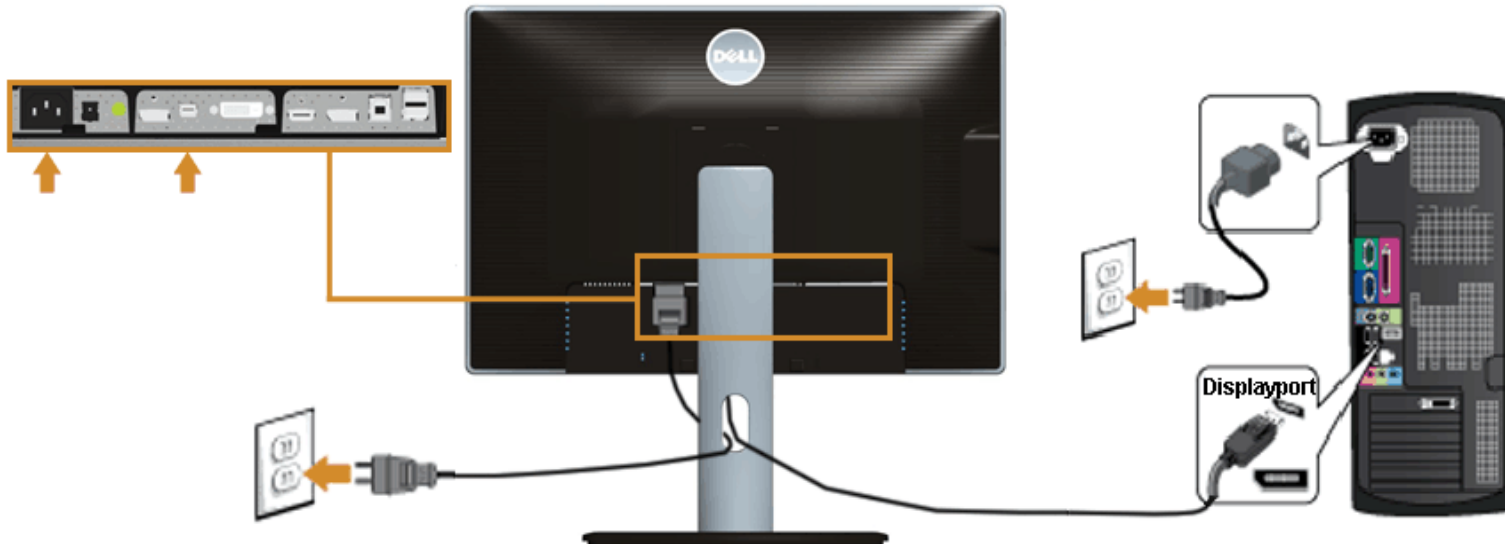

Connecting the black DisplayPort (DP to DP) cable

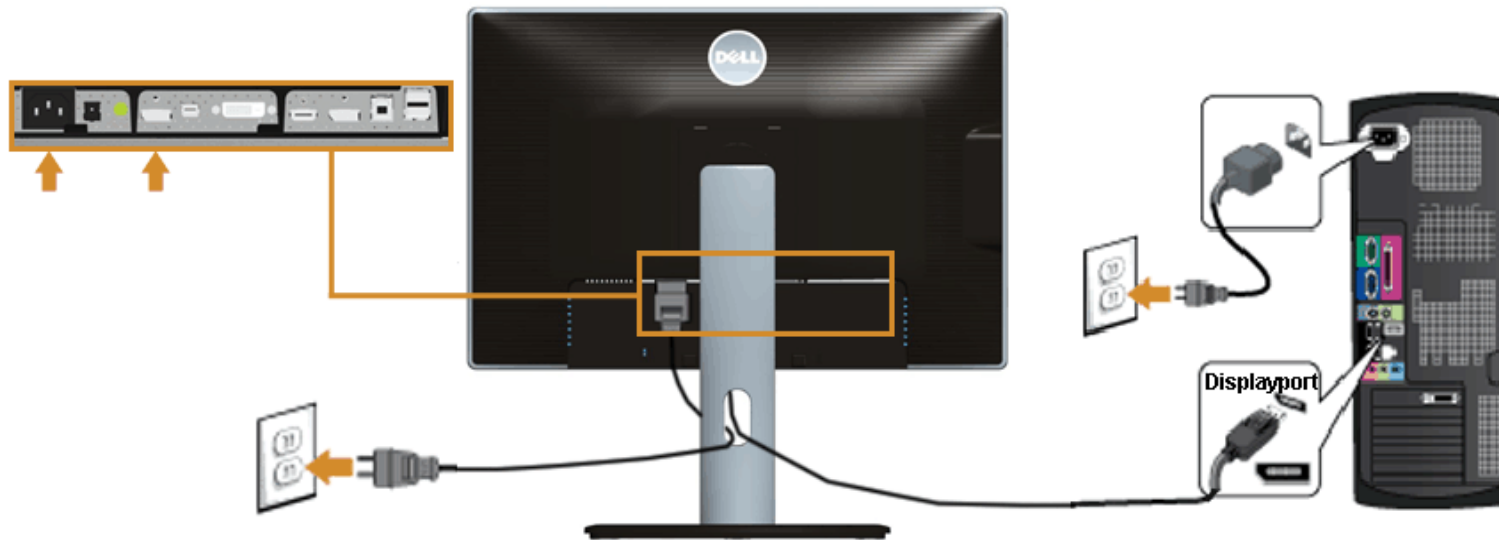

Connecting the black HDMI cable

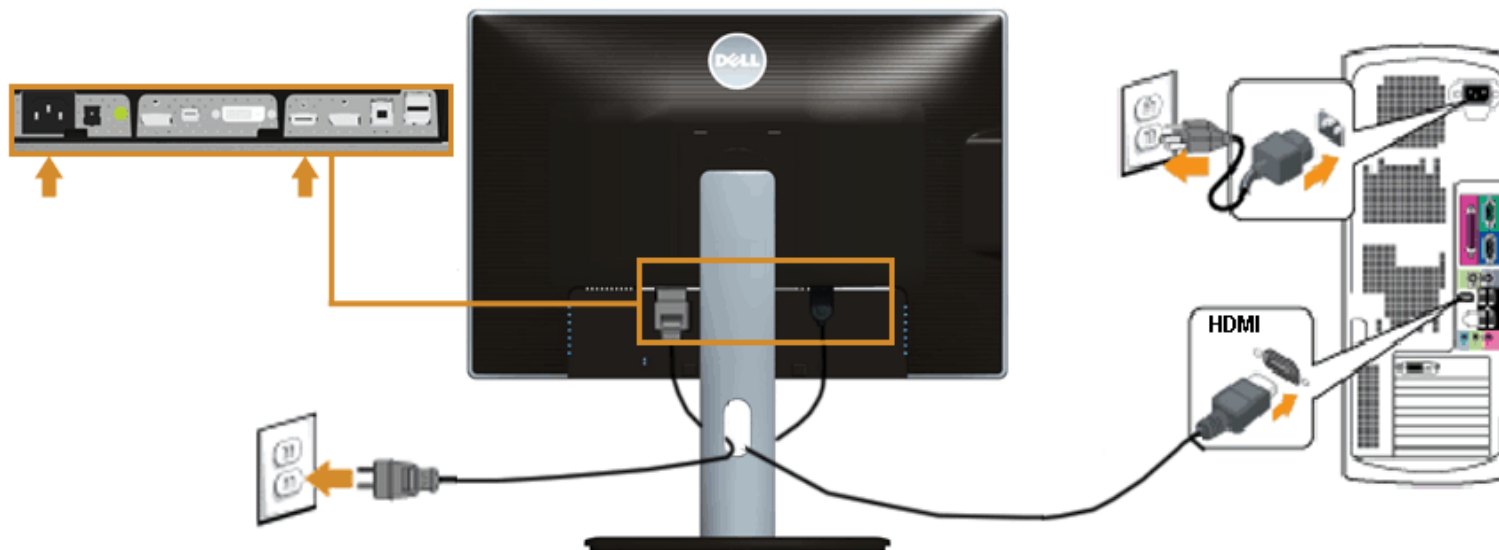

Connecting the Monitor for DP Multi-Stream Transport (MST) function

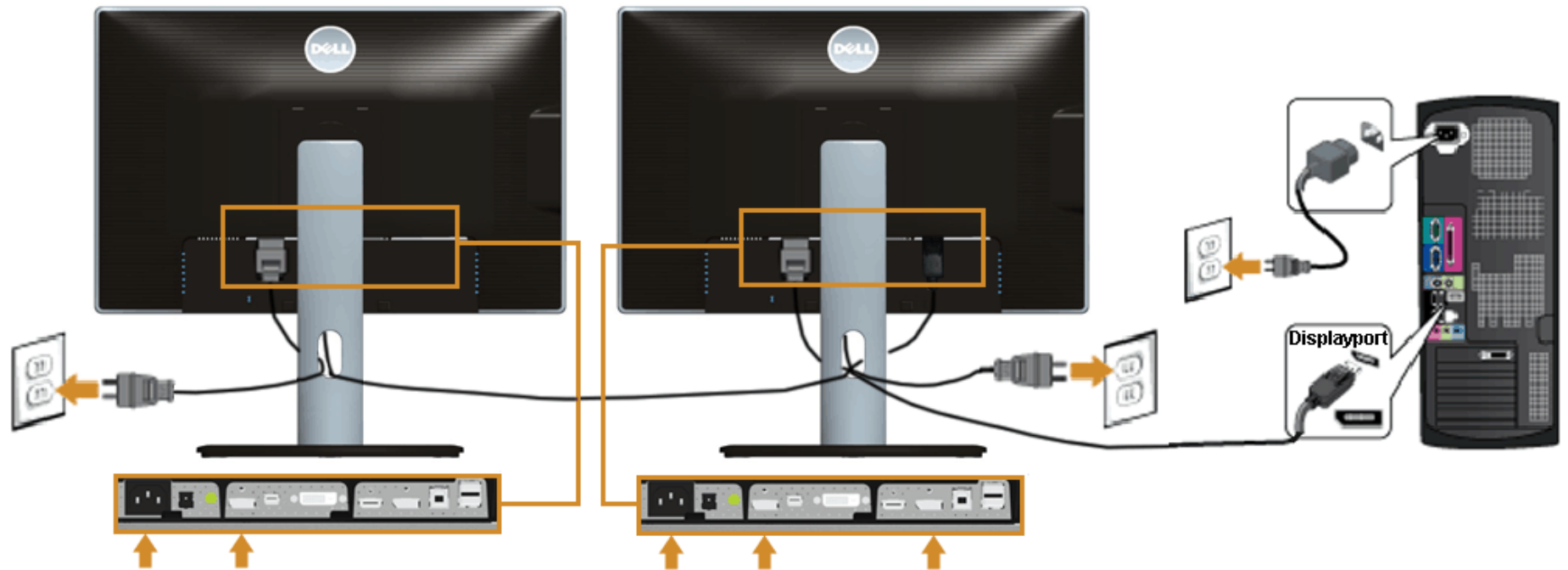

NOTE: U2413/U2713H support the DP MST feature. To make use of this feature, your PC Graphics Card must be certified to DP1.2 with MST option.







The default out of factory setting in the U2413/U2713H is DP1.1a.

To enable MST connection please use only DP cable as provided in box (or other DP1.2 certified cable) and change the DP setting to DP1.2 by performing the below steps:

A) Monitor is able to show content

1. Use OSD button to navigate to Display Settings

Dell U2413 Energy Use 

 Brightness / Contrast	Aspect Ratio ▶ Wide 16:10
 Input Source	Sharpness ▶ 50
 Color Settings	Noise Reduction
 Display Settings	Dynamic Contrast
 PIP Settings	Uniformity Compensation ▶ Off
 Other Settings	Smart Video Enhance ▶ Movie
 Personalize	DisplayPort 1.2 ▶ Disable
	Display Info
	Reset Display Settings

 **Resolution: 1920 x 1200 @ 60Hz**



2. Go to DisplayPort 1.2 selection
3. Select Enable or Disable accordingly
4. Follow the screen message to confirm selection of DP1.2 or DP1.1a

Dell U2413/U2713H

Please ensure your Graphics Card can support DP MST(Daisy Chain)/HBR2(High Bit Rate) before changing the monitor setting to DP1.2.

Incorrect setting may result in blank screen on monitor.

DP MST/HBR2 will be disabled for DP1.1a.



Confirm

Exit

B) Monitor fails to show any content (blank screen)

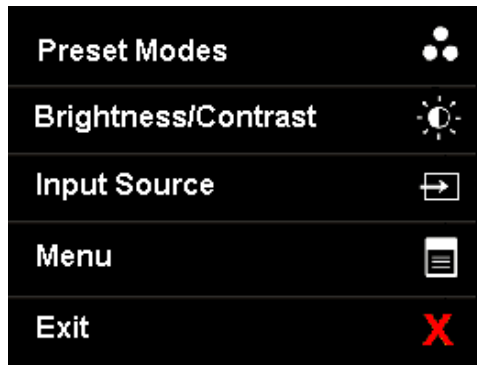
1. Press OSD button to invoke the Input Source OSD menu



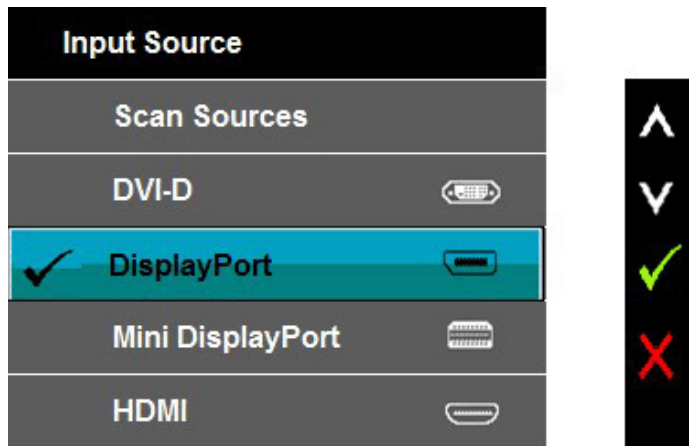

2. Use the  or  button to highlight "DisplayPort" or "Mini DisplayPort"

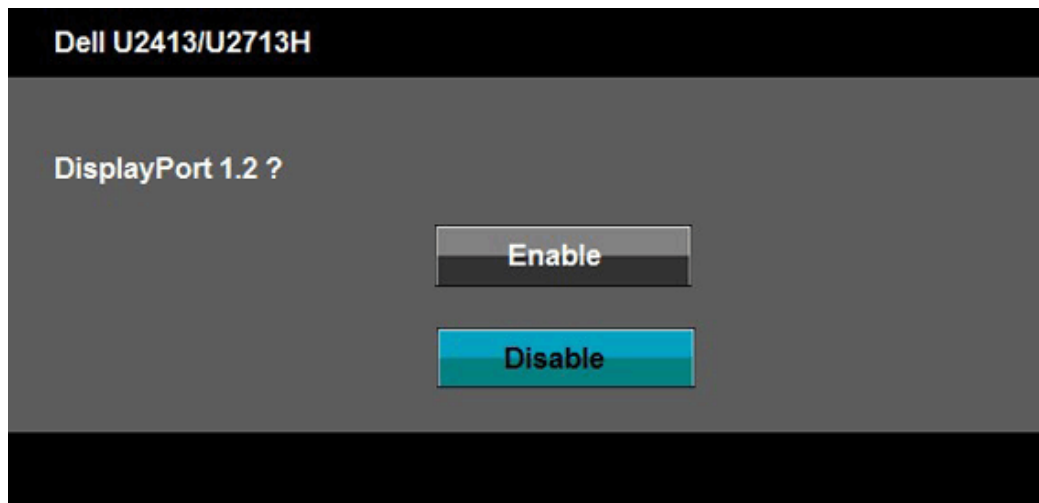

3. Press and hold the  key for approximately 8 sec.
4. The DisplayPort configuration message will appear:



5. Use the  button to enable DP1.2 or  button to exit without making any changes
Repeat the above steps to change the setting back to DP 1.1a if necessary.

 **CAUTION:** The graphics are used for the purpose of illustration only. Appearance of the computer may vary.

Connecting the USB 3.0 cable

After you have completed connecting the DVI/Mini DP/DP/HDMI cable, follow the procedures below to connect the USB 3.0 cable to the computer and complete your monitor setup:

1. Connect the upstream USB 3.0 port (cable supplied) to an appropriate USB 3.0 port on your computer. (See [bottom](#) view for details.)
2. Connect the USB 3.0 peripherals to the downstream USB 3.0 ports on the monitor.
3. Plug the power cables for your computer and monitor into a nearby outlet.
4. Turn On the monitor and the computer.
If your monitor displays an image, installation is complete. If it does not display an image, see [Solving Problems](#).
5. Use the cable slot on the monitor stand to organize the cables.

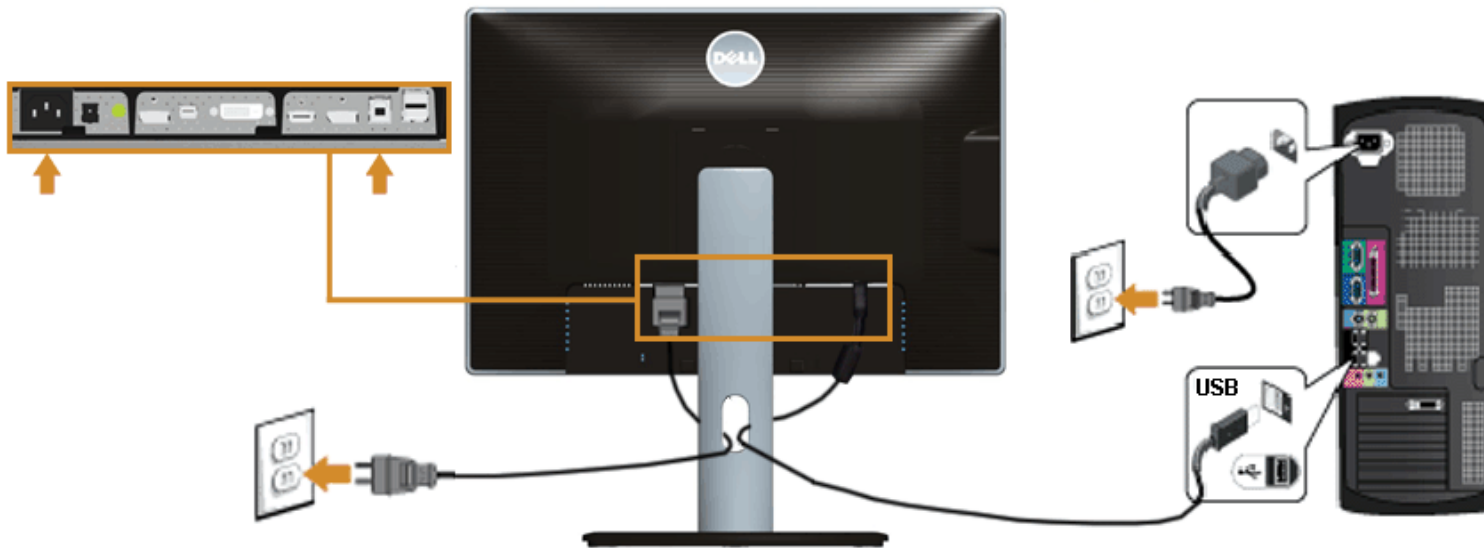

Organizing Your Cables



After attaching all necessary cables to your monitor and computer, (See [Connecting Your Monitor](#) for cable attachment,) organize all cables as shown above.

Attaching Dell Soundbar AX510/AY511 (Optional)



CAUTION: Do not use with any device other than the Dell Soundbar.



NOTE: The Soundbar power connector (+12 V DC output) is for the optional Dell Soundbar only.

To attach the Soundbar:

1. At the back of the monitor, attach the Soundbar by aligning the two slots with the two tabs along the bottom of the monitor.
2. Slide the Soundbar to the left until it snaps into place.
3. Connect the Soundbar with the DC power connector.
4. Insert the mini stereo plug from the back of the Soundbar into the computer's audio output port.

For HDMI/DP, you can insert the mini stereo plug into the monitor's audio output port. If there is no sound, check your PC if the Audio output is configured to HMDI/DP output.

Removing the Monitor Stand

-  **NOTE:** To prevent scratches on the LCD screen while removing the stand, ensure that the monitor is placed on a soft, clean surface.
-  **NOTE:** This is applicable for a monitor with a stand. When any other stand is bought, please refer to the respective stand setup guide for the set-up instructions.

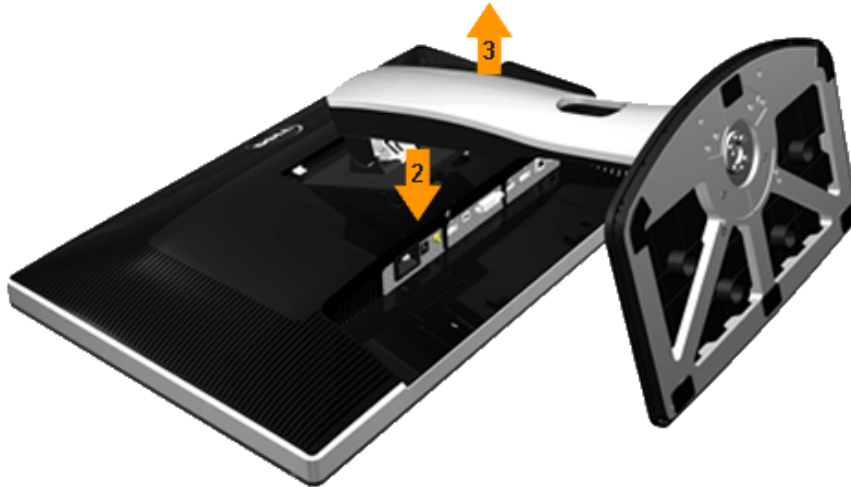

To remove the stand:

1. Place the monitor on a flat surface.
 2. Press and hold the stand release button.
 3. Lift the stand up and away from the monitor.
-

Wall Mounting (Optional)

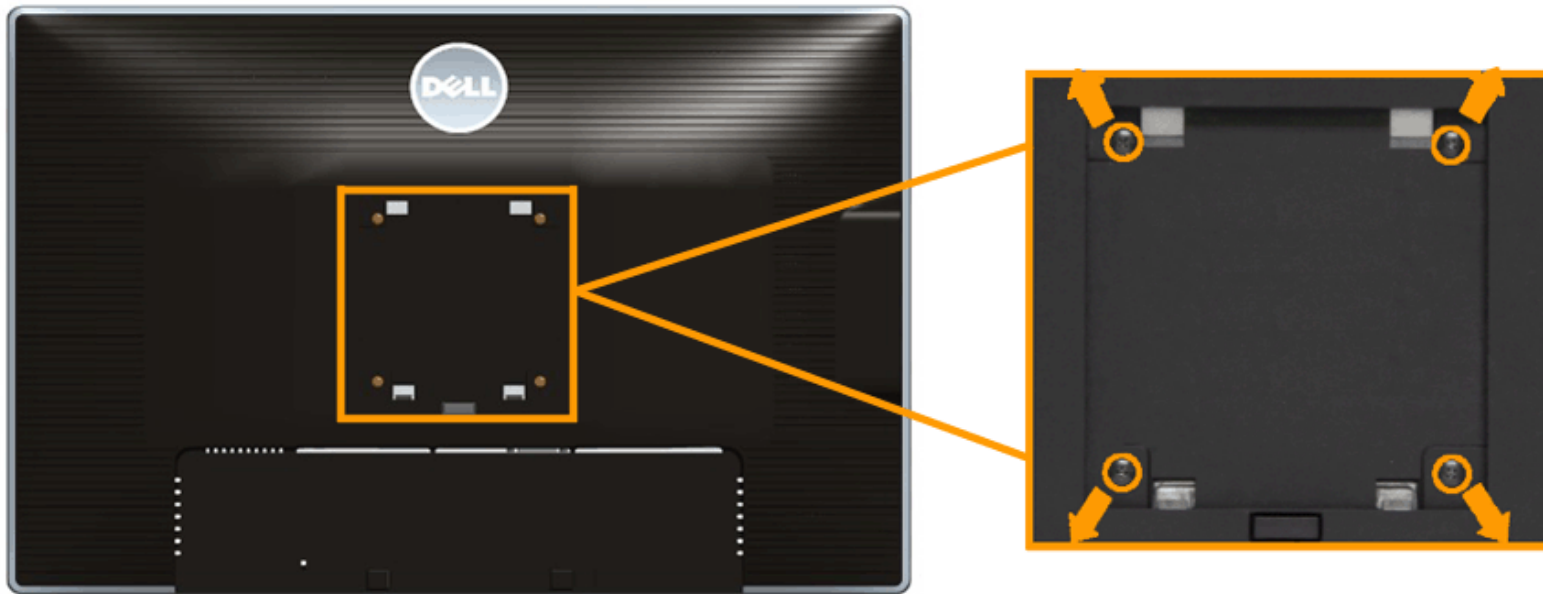

(Screw dimension: M4 x 10 mm).

Refer to the instructions that come with the VESA-compatible wall mounting kit.

1. Place the monitor panel on a soft cloth or cushion on a stable, flat table.
2. Remove the stand.
3. Use a Philips crosshead screwdriver to remove the four screws securing the plastic cover.
4. Attach the mounting bracket from the wall mounting kit to the monitor.
5. Mount the monitor on the wall by following the instructions that comes with the wall mounting kit.

 **NOTE:** For use only with UL-listed wall mount bracket with minimum weight/load bearing capacity of 6.30 kg.

[Back to Contents Page](#)

Operating the Monitor

Dell™ U2413/U2713H Monitor User's Guide

- [Power On the Monitor](#)
 - [Using the Front Panel Controls](#)
 - [Using the On-Screen Display \(OSD\) Menu](#)
 - [Setting the Maximum Resolution](#)
 - [Using Dell Soundbar](#)
 - [Using the Tilt, Swivel, and Vertical Extension](#)
 - [Rotating the Monitor](#)
 - [Adjusting the Rotation Display Settings of Your System](#)
-

Power On the Monitor

Press the  button to turn On the monitor







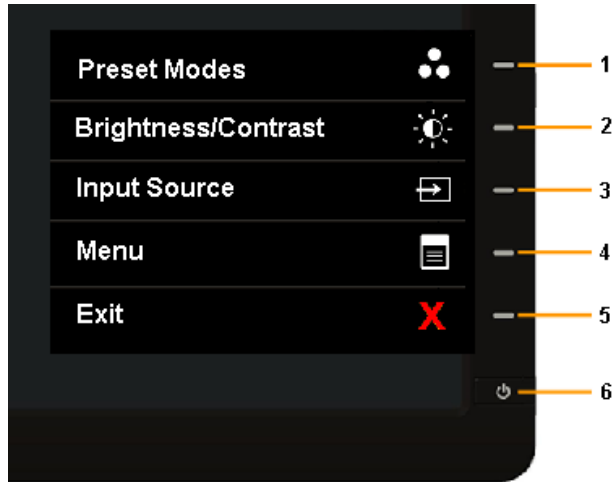



Using the Front Panel Controls

Use the control buttons on the front of the monitor to adjust the characteristics of the image being displayed. As you use these buttons to adjust the controls, an OSD shows the numeric values of the features as they change.



The following table describes the front panel buttons:



Shortcut Key	Front Panel Icon	Description
1	 <p>Shortcut key/Preset Modes</p>	Use the Preset Modes key to choose from a list of preset color modes.
2	 <p>Shortcut key/Brightness/Contrast</p>	Use the Brightness / Contrast key to directly access the Brightness/ Contrast control menu.
3	 <p>Shortcut key/Input Source</p>	<p>Use Input Source key to select between different video signals that may be connected to your monitor.</p> <ul style="list-style-type: none"> • DVI-D input • DisplayPort input • Mini DisplayPort input • HDMI input <p>Displays the source selection bar. Press  and  keys to move between the setting options and press  to select the input source you want.</p>

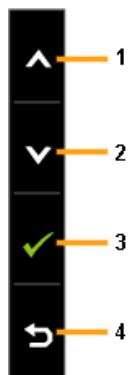

4	 Menu	Use the Menu key to launch the On-Screen Display (OSD) and select the OSD Menu. See Accessing the Menu System .
5	 Exit	Use the Exit key to go back to the main menu or exit the OSD main menu.
6	 Power (with power light indicator)	Use the Power key to turn the monitor On and Off. The white LED indicates the monitor is On and fully functional. A glowing LED indicates the U2413/U2713H is in DPMS power save mode.

Front Panel Button

[Use the buttons](#) on the front of the monitor to adjust the image settings.



Shortcut Key	Front Panel Icon	Description
1	 Up	Use the Up key to adjust (increase ranges) items in the OSD menu.
2	 Down	Use the Down key to adjust (decrease ranges) items in the OSD menu.
		Download from Www.Somanuals.com . All Manuals Search And Download.

3	 OK	Use the OK key to confirm your selection.
4	 Back	Use the Back key to go back to the previous menu.

Using the On-Screen Display (OSD) Menu

Accessing the Menu System

NOTE: If you change the settings and then either proceed to another menu or exit the OSD menu, the monitor automatically saves those changes. The changes are also saved if you change the settings and then wait for the OSD menu to disappear.

1. Press the  key to launch the OSD menu and display the main menu.

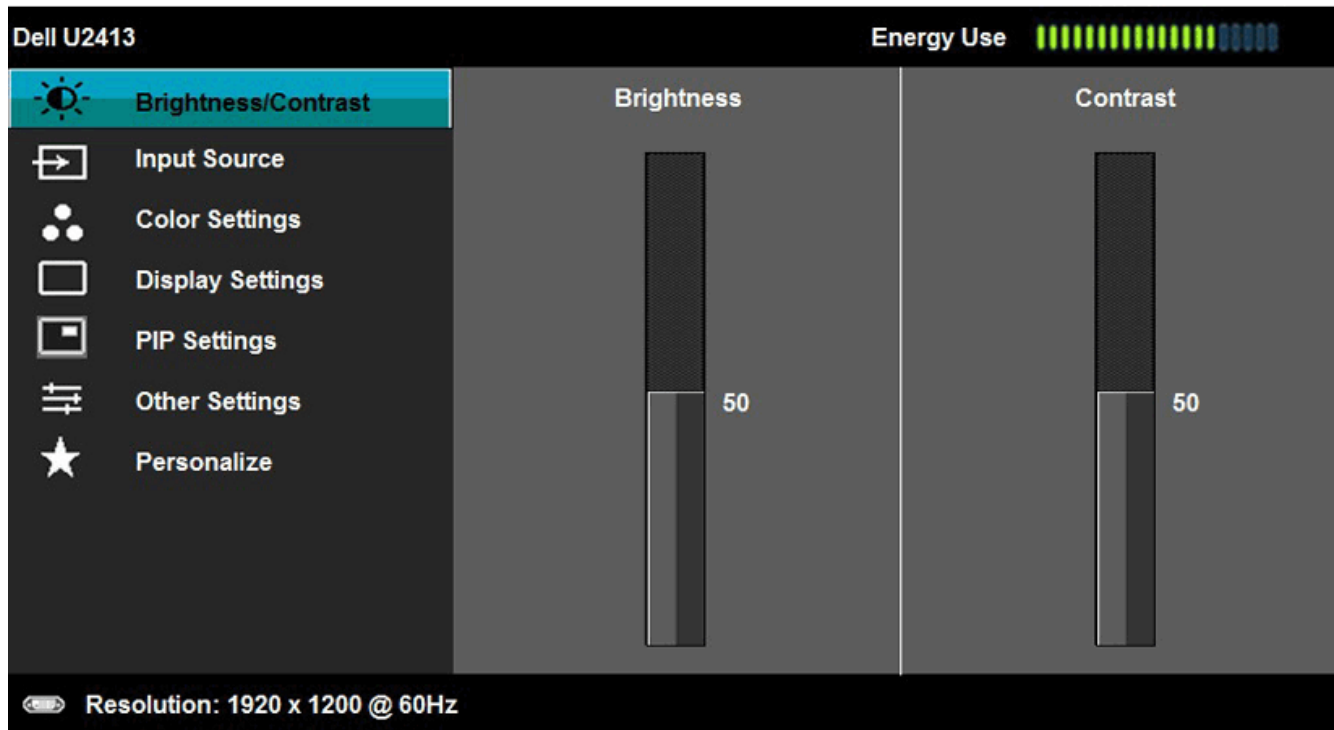



Dell U2413

Energy Use 

 **Brightness/Contrast**

 Input Source

 Color Settings

 Display Settings

 PIP Settings

 Other Settings

 Personalize

Brightness









50





Contrast

50

Resolution: 1920 x 1200 @ 60Hz

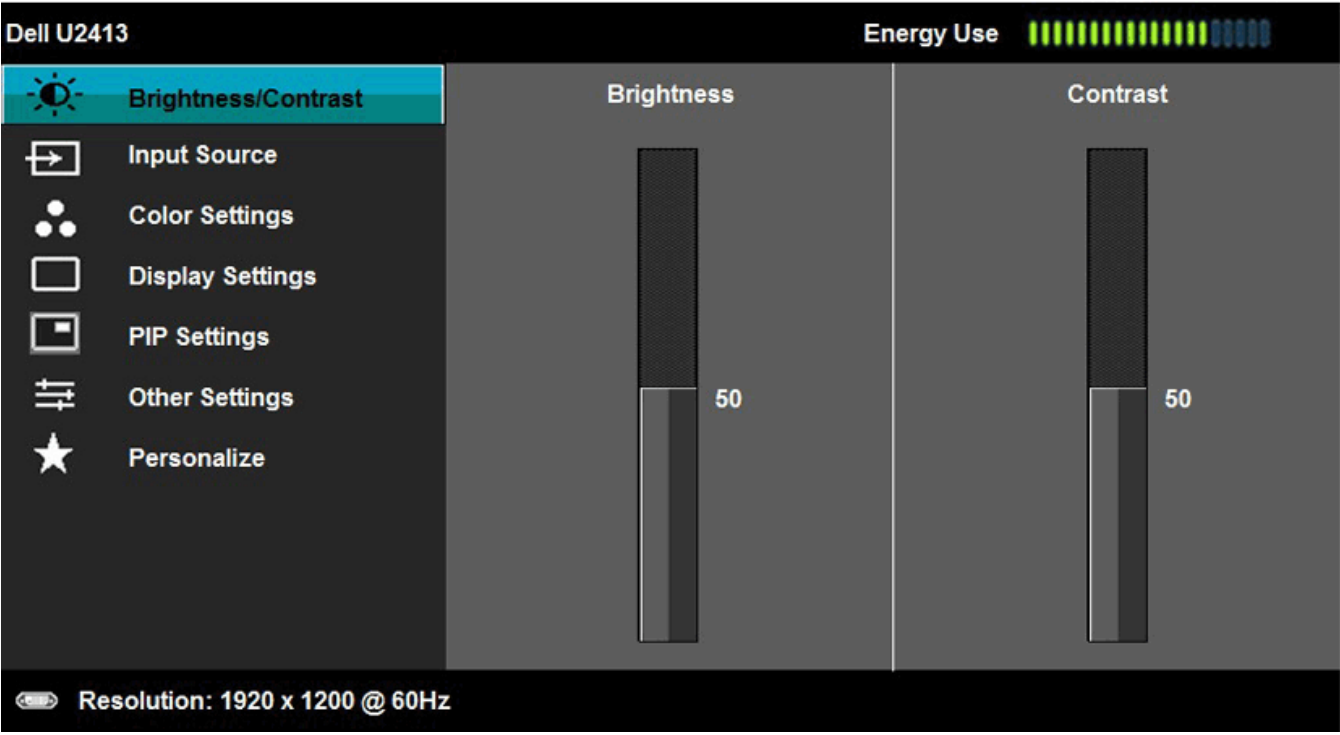
NOTE: For U2413, the maximum resolution is 1920 x 1200 @ 60Hz. For U2713H, the maximum resolution is 2560 x 1440 @ 60Hz.

- Press the  and  keys to move between the setting options. As you move from one icon to another, the option name is highlighted. See the following table for a complete list of all the options available for the monitor.
- Press the  key once to activate the highlighted option.
- Press  and  keys to select the desired parameter.
- Press  key to enter the slide bar and then use the  and  keys, according to the indicators on the menu, to make your changes.
- Press  key to return to the main menu.

Icon	Menu and Submenus	Description
	Brightness/Contrast	<p>Use this menu to activate Brightness/Contrast adjustment.</p> 
	Brightness	<p>Brightness adjusts the luminance of the backlight.</p> <p>Use the  key to increase the brightness and the  key to decrease the brightness (min 0 / max 100). NOTE: Manual adjustment of Brightness is disabled when Energy Smart or Dynamic Contrast is switched On.</p>
	Contrast	<p>Adjust the Brightness first, and then adjust the Contrast only if further adjustment is necessary.</p> <p>Use the  key to increase the contrast and the  key to decrease the contrast (min 0 / max 100). The Contrast function adjusts the degree of difference between darkness and lightness on the monitor screen.</p>



Input Source

Use the **Input Source** menu to select between the different video signals that may be connected to your monitor.

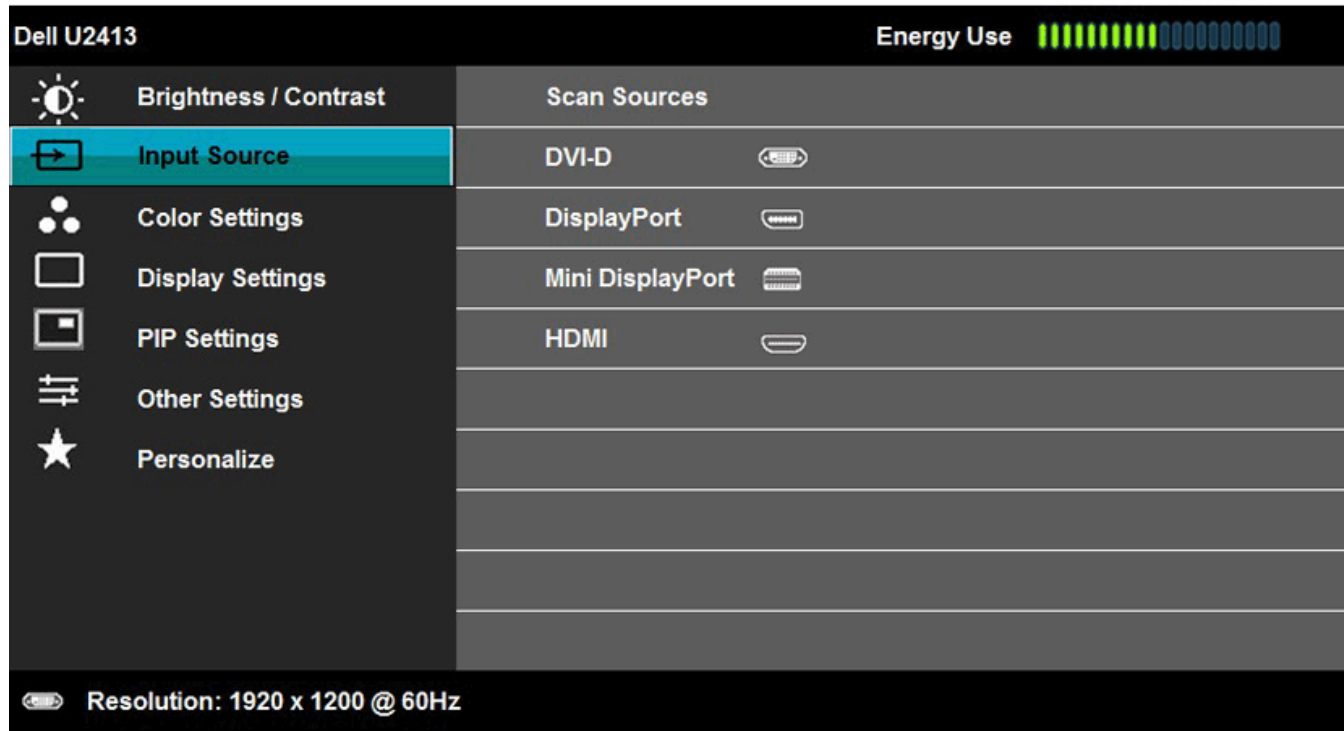

Scan Sources

Press to select **Scan Sources**, the monitor auto detects either the DVI-D input or DisplayPort input or Mini DisplayPort input or HDMI input.

DVI-D

Select the **DVI-D** input when you are using the Digital (DVI) connector. Press to select the DVI input source.

DisplayPort

Select the **DisplayPort** input when you are using the DisplayPort (DP) connector. Press to select the DisplayPort input source.

Mini DisplayPort

Select the **Mini DisplayPort** input when you are using the Mini DisplayPort (Mini DP) connector. Press to select the Mini DisplayPort input source.

HDMI

Select **HDMI** input when you are using HDMI connector. Press to select the HDMI input source.

Color Settings

Use **Color Settings** to adjust the color setting mode.

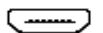
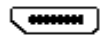

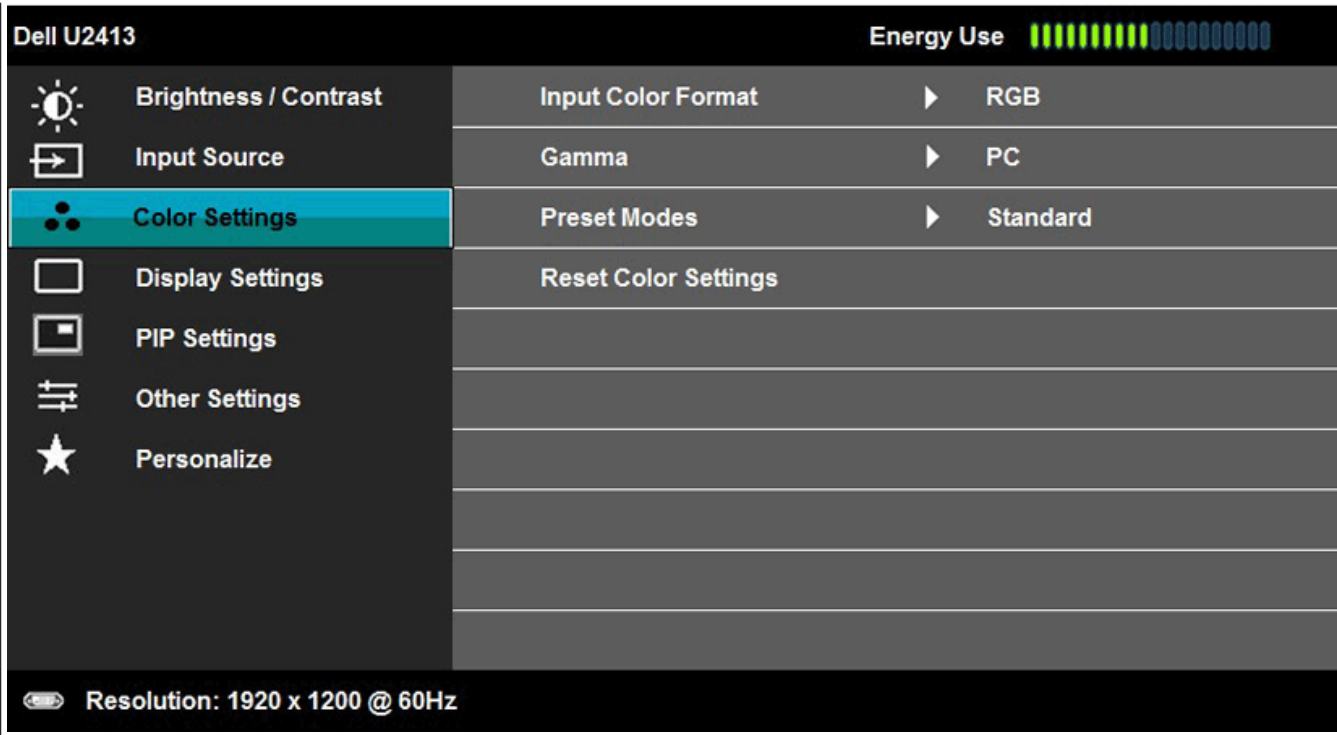









Input Color Format

Allows you to set the video input mode to:

RGB: Select this option if your monitor is connected to a computer or DVD player using the DVI cable.

YPbPr: Select this option if your monitor is connected to a DVD player by YPbPr to DVI cable; or if the DVD color output setting is not RGB.

Dell U2413 Energy Use 

 Brightness / Contrast	Input Color Format	<input checked="" type="checkbox"/> RGB
 Input Source	Gamma	YPbPr
 Color Settings	Preset Modes	
 Display Settings	Reset Color Settings	
 PIP Settings		
 Other Settings		
 Personalize		







 Resolution: 1920 x 1200 @ 60Hz

↑
↓
✓
↺

Gamma

Allows you to set the **Gamma** to PC or MAC.

Dell U2413 Energy Use 

 Brightness / Contrast	Input Color Format	
 Input Source	Gamma	<input checked="" type="checkbox"/> PC
 Color Settings	Preset Modes	MAC
 Display Settings	Reset Color Settings	
 PIP Settings		
 Other Settings		
 Personalize		

 Resolution: 1920 x 1200 @ 60Hz

↑
↓
✓
↺

Preset Modes

When you select **Preset Modes**, you can choose **Standard**, **Multimedia**, **Movie**, **Game**, **Paper**, **Color Temp.**, **Color Space** or **Custom Color** from the list.

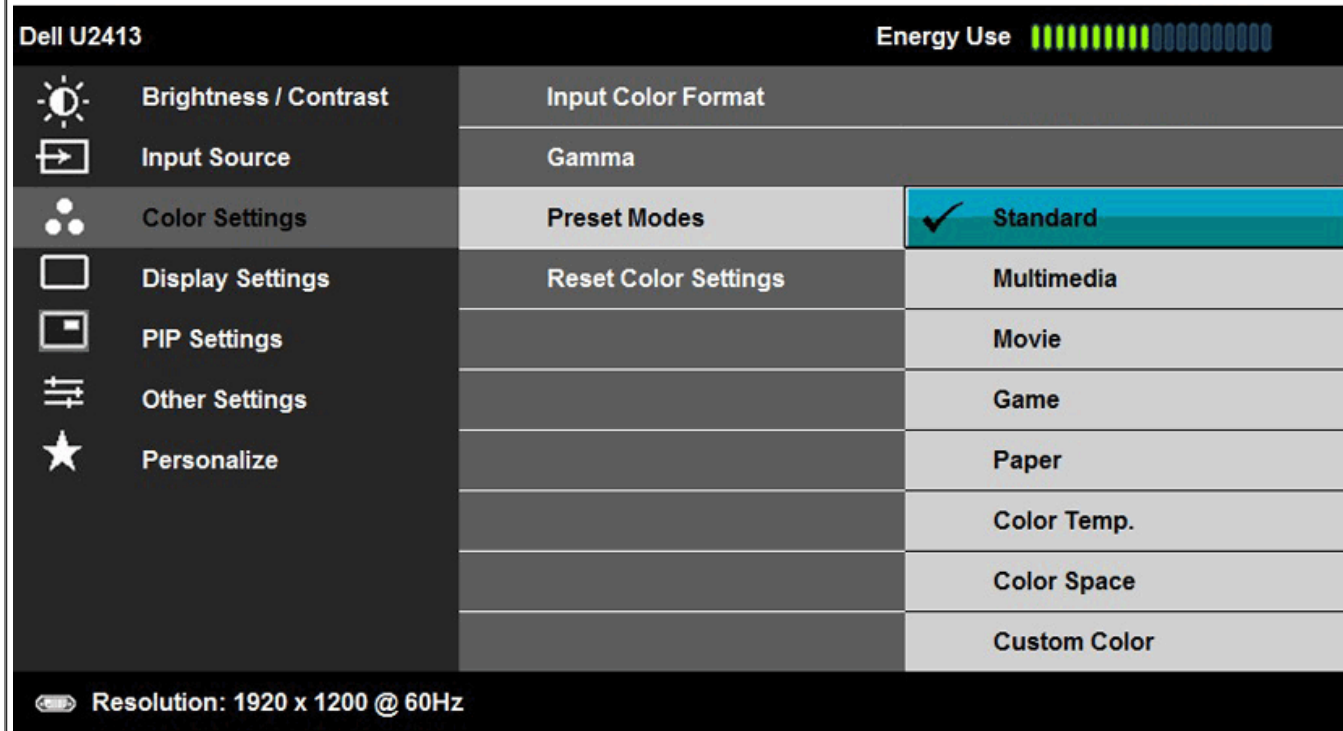

- **Standard:** Loads the monitor's default color settings. This is the default preset mode.
- **Multimedia:** Loads color settings ideal for multimedia applications.
- **Movie:** Loads color settings ideal for movies.
- **Game:** Loads color settings ideal for most gaming applications.
- **Paper:** Loads brightness and sharpness settings ideal for viewing text. Blend the text background to simulate paper media without affecting color images.
- **Color Temp.:** Allows users to select the color temperature: 5000K, 5700K, 6500K, 7500K, 9300K and 10000K.
- **Color Space:** Allows users to select the color Space: Adobe RGB, sRGB, CAL1, CAL2.

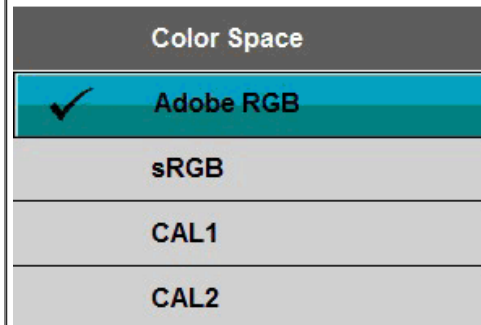

Adobe RGB: This mode is compatible with Adobe RGB (99 % coverage).



sRGB: Emulates 72 % NTSC color.

CAL1 / CAL2: User calibrated preset mode using Dell Ultrasharp Color Calibration Software or other Dell approved software.



Dell Ultrasharp Color Calibration Software works with the X-rite colorimeter i1Display Pro. The i1Display Pro can be purchased from the Dell Electronics, Software and Accessories website.

NOTE: Accuracy of sRGB, Adobe RGB, CAL1, CAL2 depends on the calibration software used.

For optimal color accuracy of sRGB and AdobeRGB, turn **Uniformity Compensation** to Off.

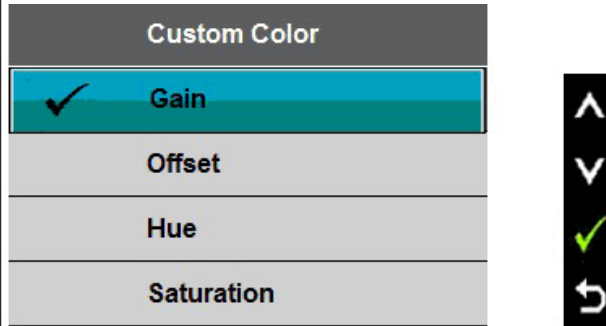
- **Custom Color:** Allows you to manually adjust the color settings. Press the  and  keys to adjust the three colors (R, G, B) values and create your own preset color mode.



Use the  or  keys to select the **Gain, Offset, Hue, Saturation**.



Gain: Select it to adjust input RGB signal gain level (default value are 100).

Offset: Select it to adjust RGB black-level offset value (default value are 50) to control your monitor base color.

Hue: Select it to adjust RGBCMY hue value individually (default value are 50).

Saturation: Select it to adjust RGBCMY saturation value individually (default value are 50).

Hue



This feature can shift the color of the video image to green or purple. This is used to adjust the desired flesh tone color. Use  or  to adjust the hue from '0' to '100'.

Press  to increase the green shade of the video image.

Press  to increase the purple shade of the video image.

NOTE: Hue adjustment is available only when you select **Movie** or **Game** preset mode.

Saturation

This feature can adjust the color saturation of the video image. Use  or  to adjust the saturation from '0' to '100'.

Press  to increase the monochrome appearance of the video image.

Press  to increase the colorful appearance of the video image.

NOTE: Saturation adjustment is available only when you select **Movie** or **Game** preset mode.

Reset Color Settings

Reset your monitor color settings to the **Factory Settings**.



Display Settings

Use the **Display Settings** to adjust image.

Aspect Ratio

Adjust the image ratio to Wide 16: 10, 16:9, Auto Resize, 4:3 or 1:1.

NOTE: Wide 16: 10 is not available in U2713H.

Sharpness

This feature can make the image look sharper or softer. Use  or  to adjust the sharpness from '0' to '100'.

Noise Reduction

Improve the motion picture quality by reducing noise on image edge.

Dynamic Contrast

Dynamic Contrast adjusts the contrast ratio to 2M to 1.

Press the  key to select the Dynamic Contrast "On" or "Off" .

NOTE: **Dynamic Contrast** provides higher contrast if you select Game or Movie preset mode.

Uniformity Compensation

Select screen brightness and color uniformity compensation settings. **Calibrated** is factory calibrated setting by default. **User** is reserved for Dell approved user calibration software settings. **Uniformity Compensation** adjusts different areas of the screen with respect to the center to achieve uniform brightness and color over the entire screen. For optimal screen performance, Brightness and Contrast for some preset modes (Standard, Color Temp.) will be disabled when **Uniformity Compensation** is turned On. When **Uniformity Compensation** is turned On, Energy Smart cannot be activated.

NOTE: Screen Uniformity performance is optimized at default out of factory luminance setting.

Smart Video Enhance

Press the  key to select the **Smart Video Enhance** "Movie" or "Advance" or "Off" .

Smart Video Enhance automatically detects video (motion) in any window on the screen, and applies enhancements to the video. Only the video window is enhanced. Two different enhancement settings are available:

- **Movie** - suitable for movie or multimedia video clips.
- **Advance** - User adjustable setting.

NOTE: Smart Video Enhance (SVE) enhances one of the video windows (typically the largest), if multiple video windows are active on the screen.
DisplayPort 1.2 Download from www.somanuals.com. All Manuals Search And Download.

DisplayPort 1.2

Press the  key to enable or disable DisplayPort 1.2
To use the DP MST (Daisy Chain) or HBR2 feature, enable DP1.2.

NOTE: Ensure your Graphics Card can support these features before selecting DP1.2. Wrong setting may result in blank screen.

Display Info

Displays the monitor's current settings.

Reset Display Settings

Select this option to restore default display settings.

**PIP Settings**

This function brings up a window displaying image from another input source.

U2413

U2713H

Main Window	Sub-Window				Main Window	Sub-Window			
	DVI-D	DP	Mini DP	HDMI		DVI-D	DP	Mini DP	HDMI
DVI-D	X	✓	✓	✓	DVI-D	X	✓	✓	X
DP	✓	X	X	✓	DP	✓	X	X	✓
Mini DP	✓	X	X	✓	Mini DP	✓	X	X	✓
HDMI	✓	✓	✓	X	HDMI	X	✓	✓	X





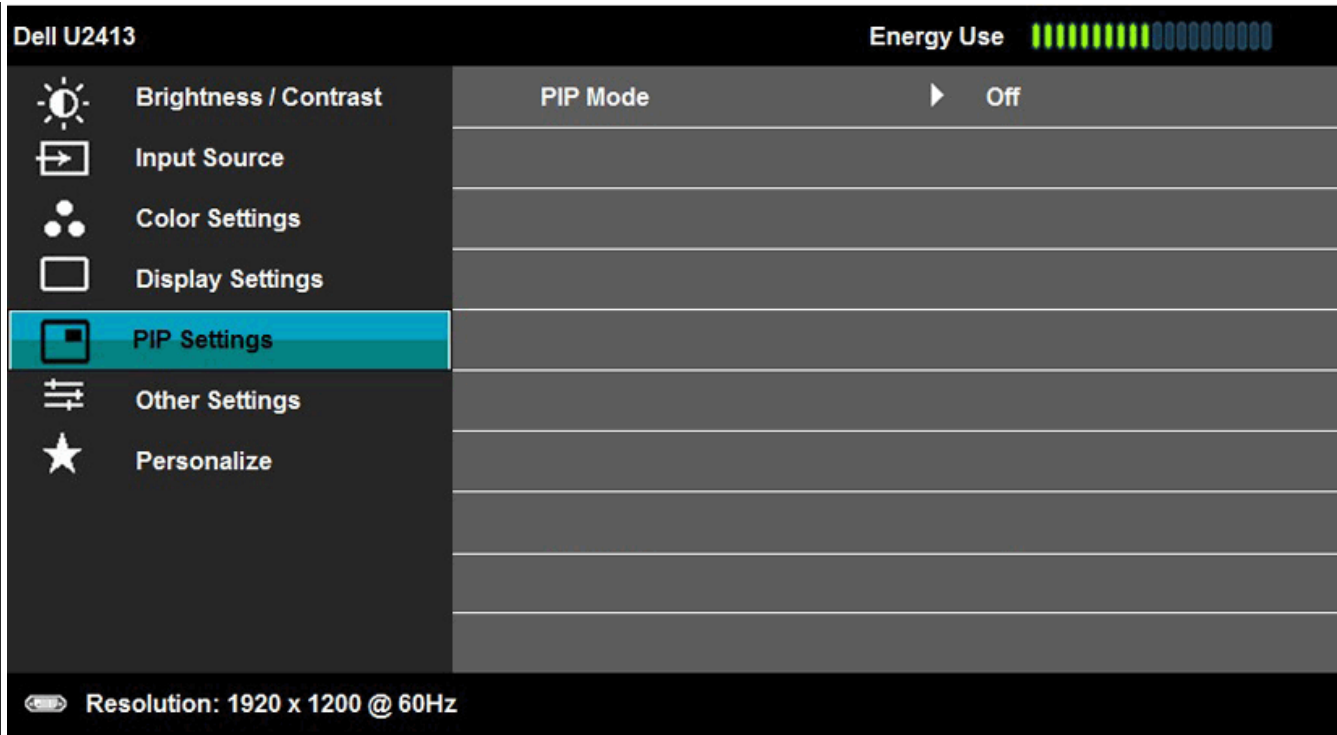



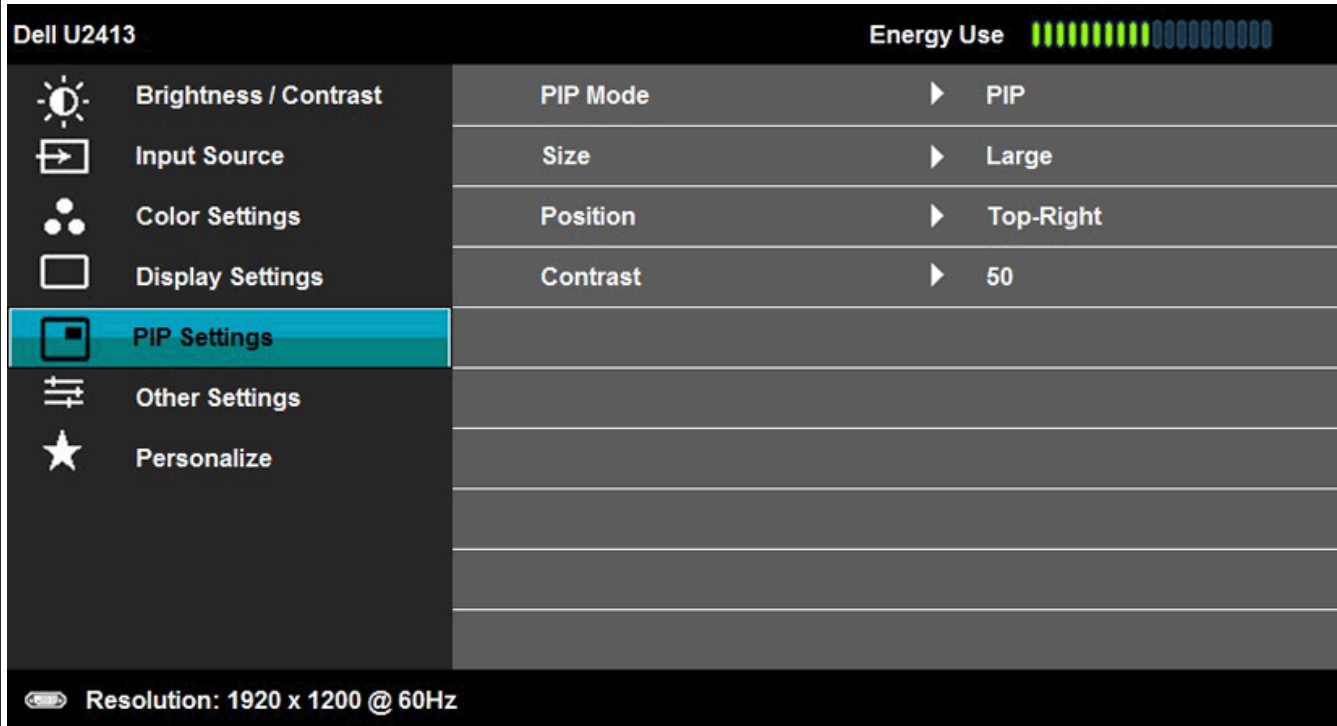

NOTE: The images under PBP will be displayed at the center of the screen, not full screen.

PIP/PBP submenu when PIP/PBP Off



PIP/PBP submenu when PIP/PBP On









PIP Mode	<p>There are three modes: Picture in Picture (PIP) and Picture by Picture (PBP) and Off.</p> <p>Use  and  to browse and  to select "Off", "PIP" or "PBP".</p>
Size	<p>Select PIP window size.</p> <p>Use  and  to browse and  to select "Small" or "Large".</p>
Position	<p>Select PIP window position.</p> <p>Use  and  to browse and  to select "Top-Left", "Top-Right", "Bottom-Right" or "Bottom-Left".</p>
Contrast	<p>Adjust the contrast level of the picture in PIP/PBP Mode.</p> <p> reduces the contrast</p> <p> increases the contrast</p>











Other Settings Select this option to adjust the settings of the OSD, such as, the languages of the OSD, the amount of time the menu remains on screen, and so on.

Dell U2413 Energy Use 

 Brightness / Contrast	Language ▶ English
 Input Source	Menu Transparency ▶ 20
 Color Settings	Menu Timer ▶ 20 s
 Display Settings	Menu Lock ▶ Unlock
 PIP Settings	Menu Button Sound ▶ Off
 Other Settings	Auto Rotate ▶ On
 Personalize	Energy Smart ▶ Off
	Menu Location ▶ Bottom-Right
	Power Save Audio
	DDC/CI ▶ Enable
	LCD Conditioning ▶ Disable
	Factory Reset Reset All Settings

Resolution: 1920 x 1200 @ 60Hz





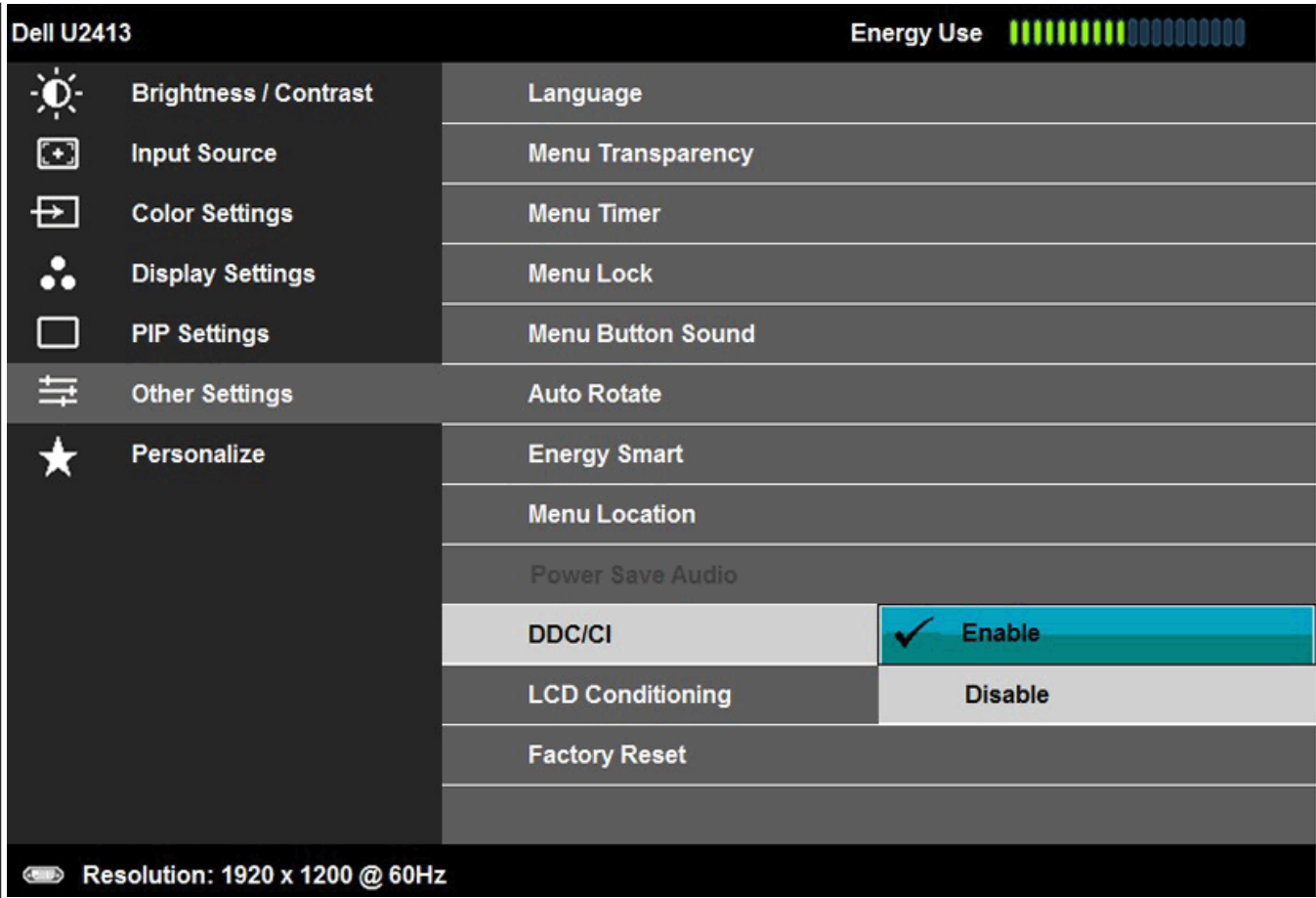

Language	Language options set the OSD display to one of the eight languages (English, Spanish, French, German, Brazilian Portuguese, Russian, Simplified Chinese or Japanese).
Menu Transparency	Select this option to change the menu transparency by pressing the  and  keys (Minimum: 0 ~ Maximum: 100).
Menu Timer	OSD Hold Time: sets the length of time the OSD will remain active after the last time you pressed a button. Use  or  to adjust the slider in 1 second increments, from 5 to 60 seconds.
Menu Lock	Controls user access to adjustments. When Lock is selected, no user adjustments are allowed. All buttons are locked. NOTE: <ul style="list-style-type: none"> • Lock function – Either soft lock (through the OSD menu) or hard lock (press and hold the button above the power button for 10 seconds) • Unlock function– Only hard unlock (press and hold the button above the power button for 10 seconds)
Menu Button Sound	The monitor beeps everytime a new option is selected in the menu. This button enables or disables the sound.
Auto Rotate	This display is equipped with a orientation sensor. Rotating the display from Landscape to Pivot (or back) will automatically trigger the OSD to be rotated accordingly. If Dell Display Manager (DDM) is installed and with suitable PC graphics card, the screen content will also be rotated accordingly. Select Auto Rotate to Off to disable this feature. NOTE: Auto Rotate is not available when PIP/PBP is On.
Energy Smart	To turn On or Off dynamic dimming. The dynamic dimming feature automatically reduces the screen's brightness level when the displayed image contains a high proportion of bright areas.
Menu Location	Select OSD Menu window position.
Power Save Audio	To turn On or Off Audio Power during Power Save mode.
DDC/CI	DDC/CI (Display Data Channel/Command Interface) allows your monitor parameters (brightness, color balance, and etc.) to be adjustable via the software on your computer. You can disable this feature by selecting "Disable". Enable this feature for best user experience and optimum performance of your monitor.

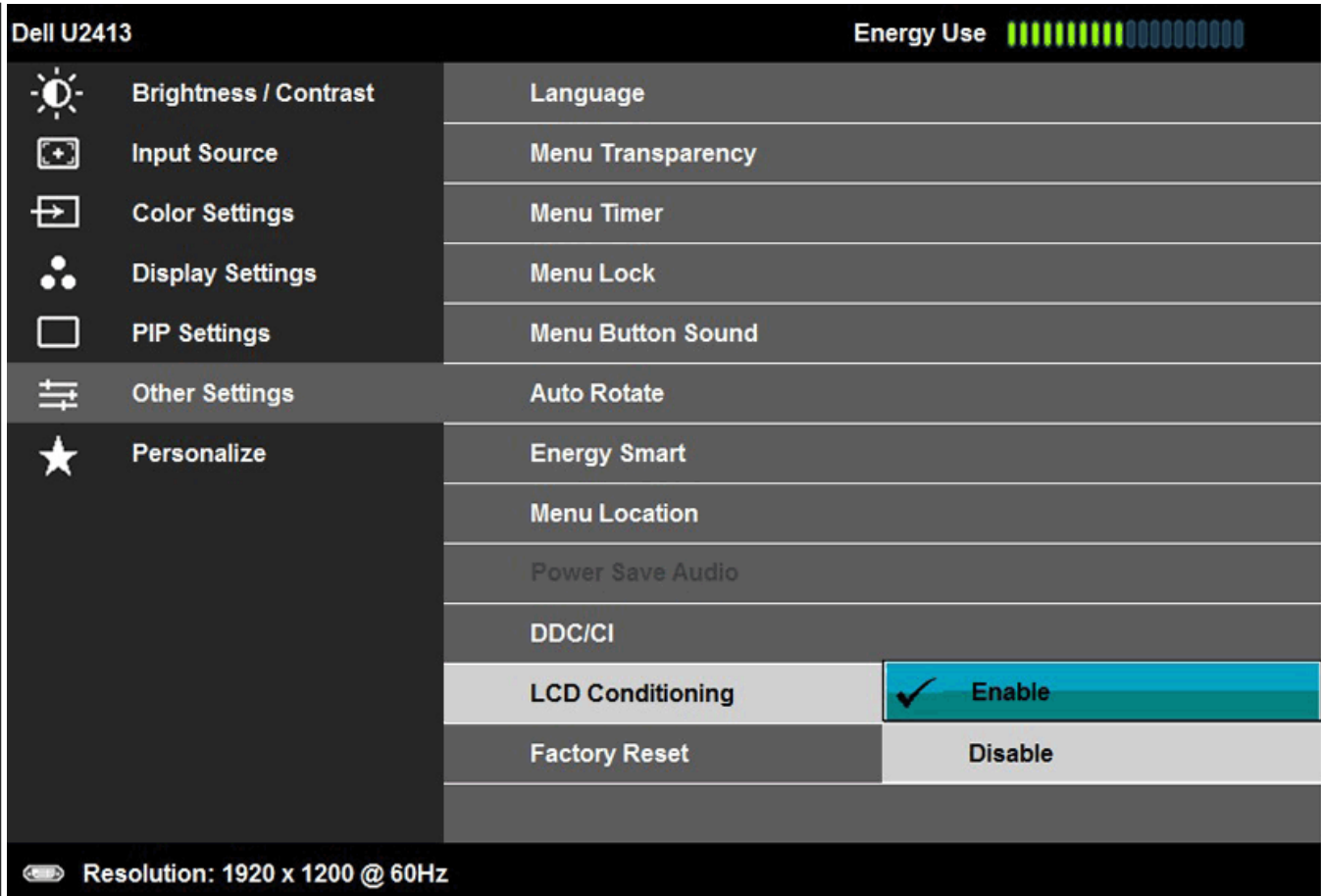

LCD Conditioning

Helps reduce minor cases of image retention. Depending on the degree of image retention, the program may take some time to run. You can enable this feature by selecting "Enable".



Factory Reset Reset all OSD settings to the **factory preset** values.



Personalize User can select from "Preset Modes", "Brightness/Contrast", "Input Source", "Aspect Ratio", and "PIP Mode" set as shortcut key.

Dell U2413

Energy Use 



Brightness / Contrast

Shortcut Key 1



Preset Modes



Input Source

Shortcut Key 2



Brightness/Contrast



Color Settings

Shortcut Key 3



Input Source



Display Settings

Reset Personalize



PIP Settings



Other Settings



Personalize



Resolution: 1920 x 1200 @ 60Hz



OSD Warning Messages

When the **Energy Smart** or **Dynamic Contrast** feature is enabled (in these preset modes: Game or Movie), the manual brightness adjustment is disabled.

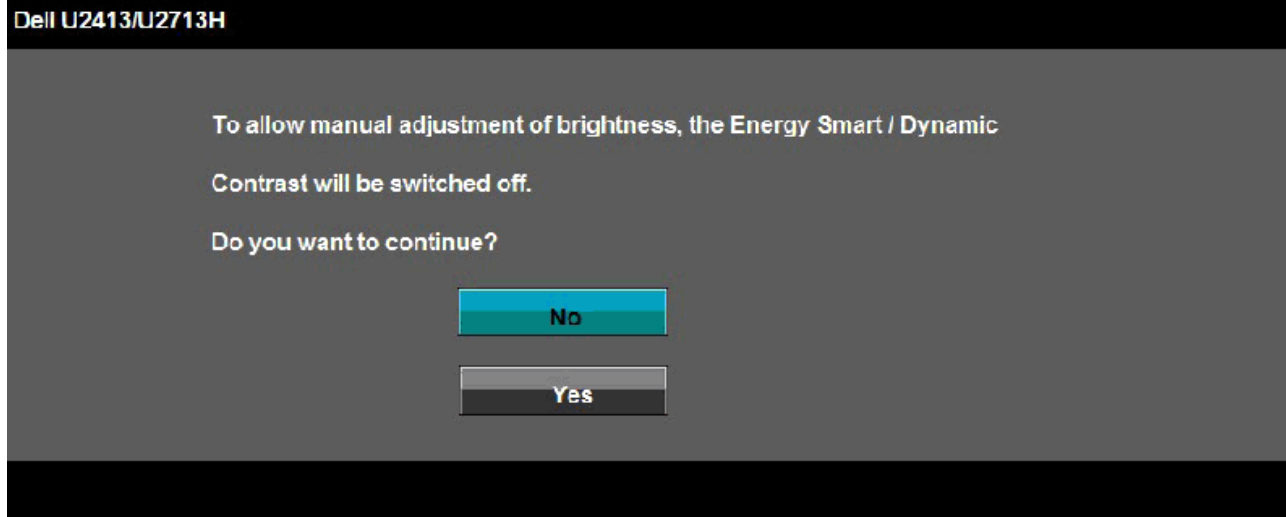

When the monitor does not support a particular resolution mode, you will see the following message:

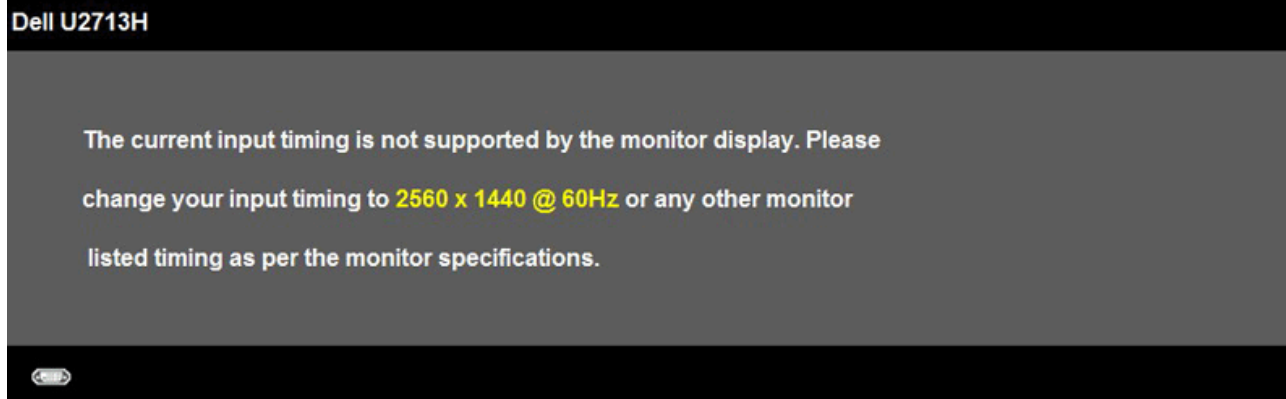
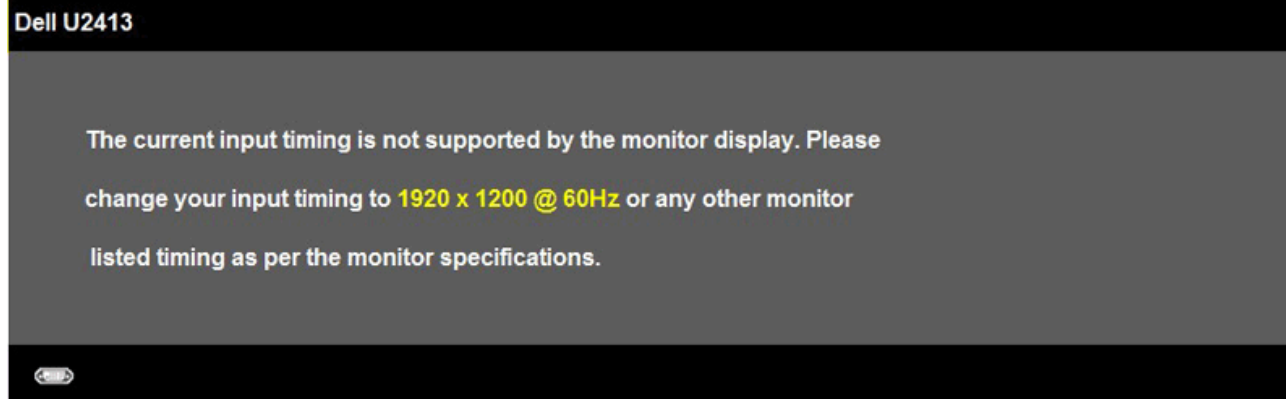

This means that the monitor cannot synchronize with the signal that it is receiving from the computer. See [Monitor Specifications](#) for the Horizontal and Vertical frequency ranges addressable by this monitor. Recommended mode is 1920 x 1200 (for the U2413)/2560 x 1440 (for the U2713H).

You will see the following message before the DDC/CI function is disabled:

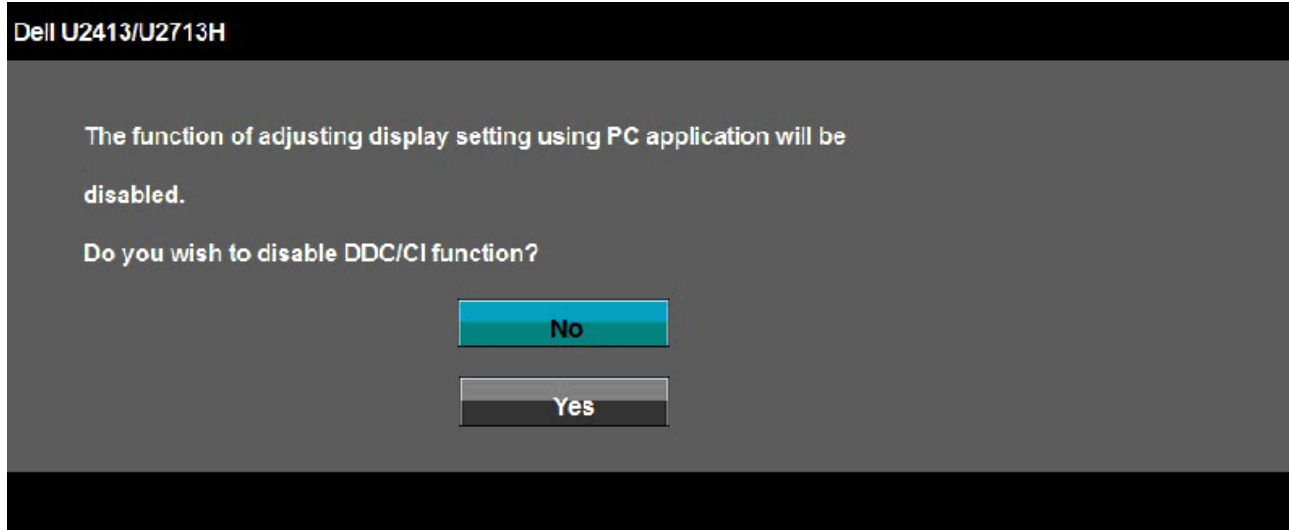

When the monitor enters the **Power Save** mode, the following message appears:



Activate the computer and wake up the monitor to gain access to the [OSD](#).

If you press any button other than the power button, one of the following messages will appear depending on the selected input:

DVI-D/DP/Mini DP/HDMI input

Dell U2413/U2713H

There is no signal coming from your computer. Press any key on the keyboard or move the mouse to wake it up. If there is no display, press the monitor button now to select the correct Input source on the On-Screen-Display menu.



When **Uniformity Compensation** is set to "Calibrated" or "User", the manual brightness / contrast adjustment is disabled.

Dell U2413/U2713H

To allow manual adjustment of brightness / Contrast ,
the Uniformity Compensation will be switched off.
Do you want to continue?

No

Yes

If either DVI-D or DP or Mini DP or HDMI input is selected and both DVI-D or HDMI or DP cables are not connected, a floating dialog box as shown below appears.

Dell U2413/U2713H



No DVI-D Cable

The display will go into Power Save Mode in 5 minutes.



Dell U2413/U2713H

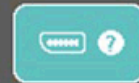

No DisplayPort Cable

The display will go into Power Save Mode in 5 minutes.



or

or

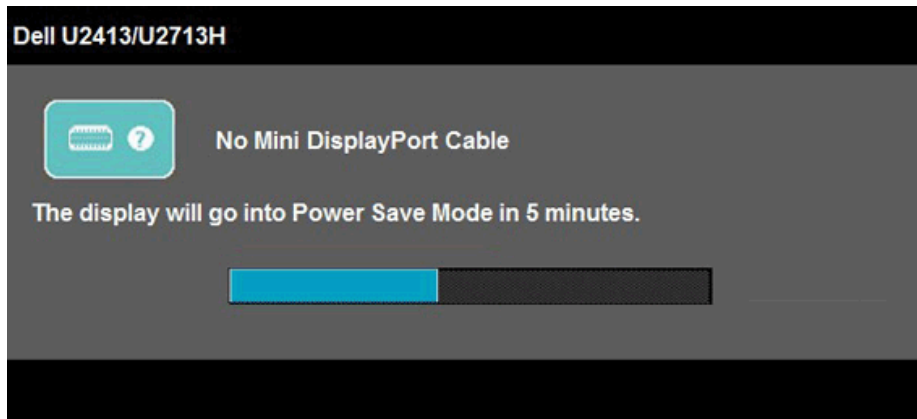

or

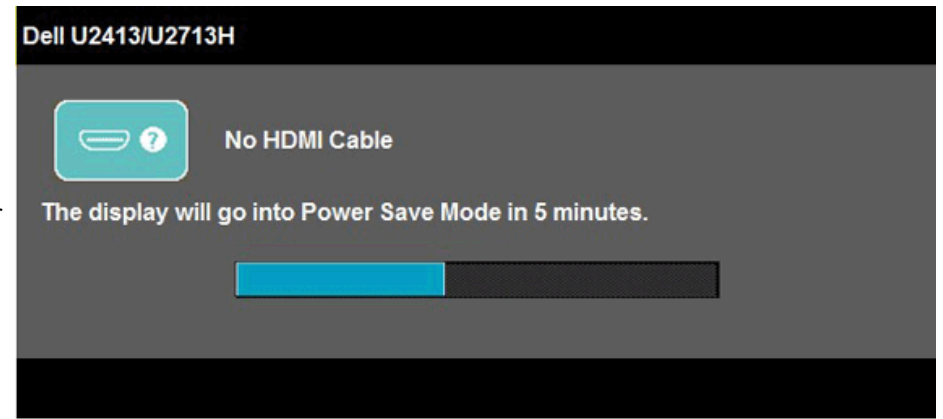

See [Solving Problems](#) for more information.

Setting the Maximum Resolution

To set the maximum resolution for the monitor:

In Windows Vista®, Windows® 7 , Windows® 8:

1. For Windows® 8 only, select the **Desktop** tile to switch to classic desktop.
2. Right-click on the desktop and click **Screen resolution**.
3. Click the Dropdown list of the Screen resolution and select **1920 x 1200** (U2413) or **2560 x 1440** (U2713H).
4. Click **OK**.

If you do not see the recommended resolution as an option, you may need to update your graphics driver. Depending on your computer, complete one of the following procedures:

If you have a Dell desktop or portable computer:

- Go to <http://support.dell.com>, enter your service tag, and download the latest driver for your graphics card.

If you are using a non-Dell computer (portable or desktop):

- Go to the support site for your computer and download the latest graphic drivers.
- Go to your graphics card website and download the latest graphic drivers.

Using Dell Soundbar

The soundbar has an On/Off power and rotary volume control to adjust the overall sound system, a LED for power indication and two audio headset jacks.

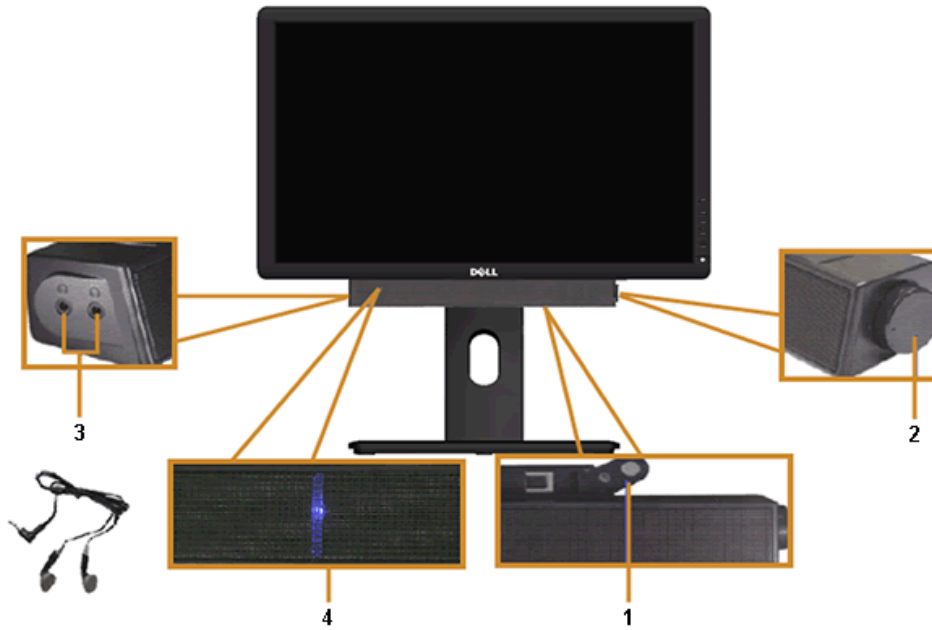

- 1 Attach mechanism
- 2 Power/Volume control
- 3 Headphone jacks
- 4 Power indicator

Using the Tilt, Swivel, and Vertical Extension

 **NOTE:** This is applicable for a monitor with a stand. When any other stand is bought, please refer to the respective stand setup guide for set up instructions.

Tilt, Swivel

With the stand attached to the monitor, you can tilt and swivel the monitor for the most comfortable viewing angle.

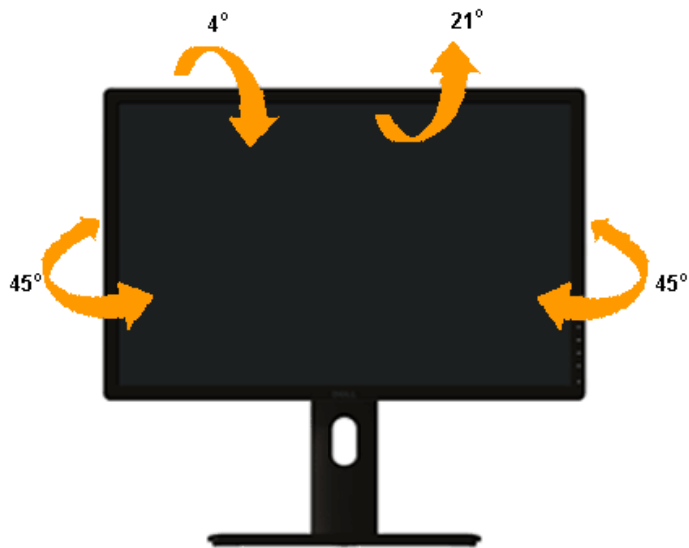

 **NOTE:** The stand is detached when the monitor is shipped from the factory.

Vertical Extension

 **NOTE:** The stand extends vertically up to 115 mm. The figure below illustrates how to extend the stand vertically.



Rotating the Monitor

Before you rotate the monitor, your monitor should be fully vertically extended ([Vertical Extension](#)) and fully tilted ([Tilt](#)) up to avoid hitting the bottom edge of the monitor.

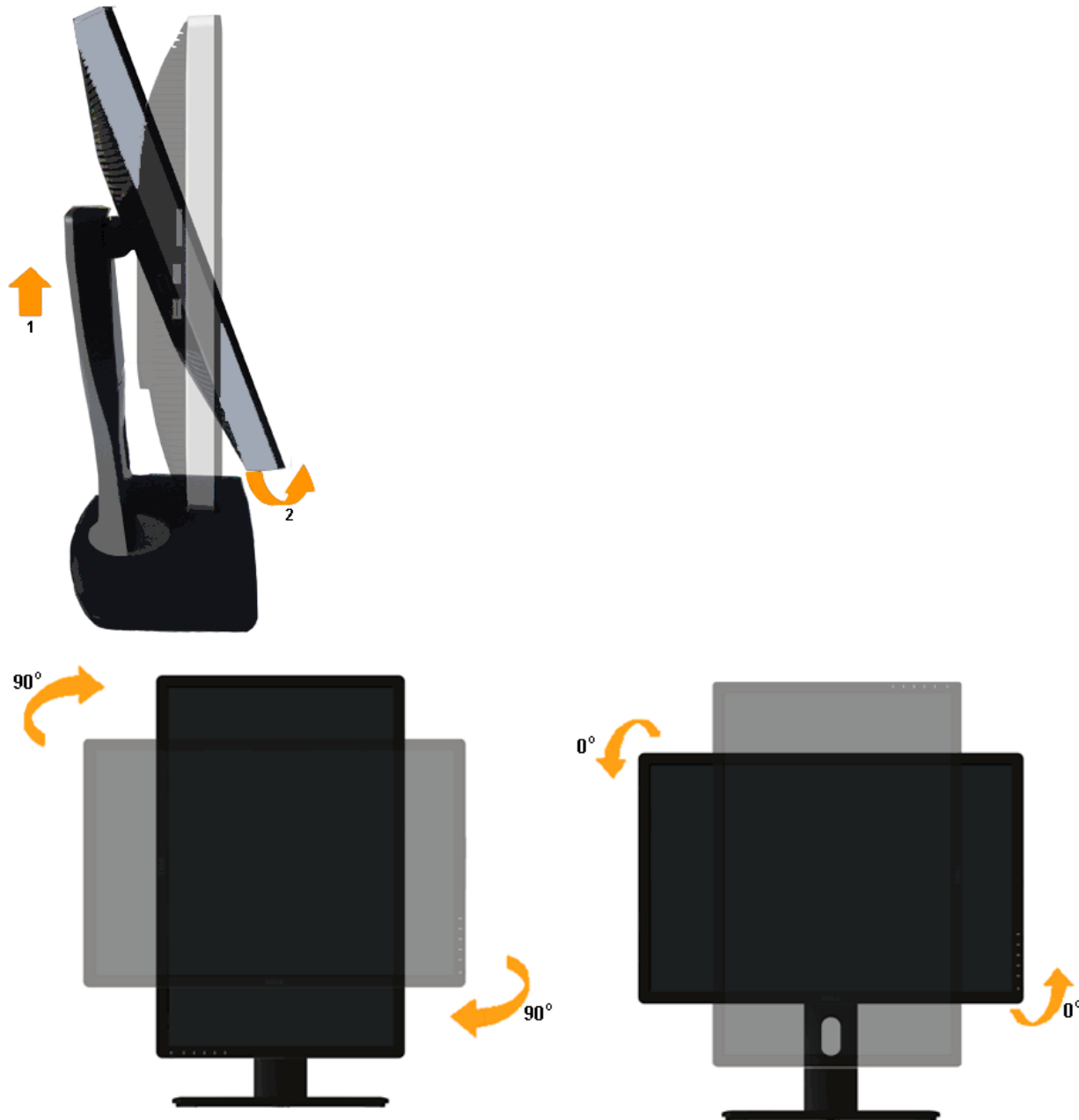

NOTE: To use the Display Rotation function (Landscape versus Portrait view) with your Dell computer, you require an updated graphics driver that is not included with this monitor. To download the graphics driver, go to <http://support.dell.com> and see the **Download** section for **Video Drivers** for latest driver updates.

NOTE: When in the *Portrait View Mode*, you may experience performance degradation in graphic-intensive applications (3D Gaming and etc.).

Adjusting the Rotation Display Settings of Your System

After you have rotated your monitor, you need to complete the procedure below to adjust the Rotation Display Settings of your system.

 **NOTE:** If you are using the monitor with a non-Dell computer, you need to go the graphics driver website or your computer manufacturer website for information on rotating the 'contents' on your display.

To adjust the Rotation Display Settings:

1. Right-click on the desktop and click **Properties**.
2. Select the **Settings** tab and click **Advanced**.
3. If you have an ATI graphics card, select the **Rotation** tab and set the preferred rotation.
If you have an nVidia graphics card, click the **nVidia** tab, in the left-hand column select **NVRotate**, and then select the preferred rotation.
If you have an Intel[®] graphics card, select the **Intel** graphics tab, click **Graphic Properties**, select the **Rotation** tab, and then set the preferred rotation.

 **NOTE:** If you do not see the rotation option or it is not working correctly, go to <http://support.dell.com> and download the latest driver for your graphics card.

[Back to Contents Page](#)

Troubleshooting

Dell™ U2413/U2713H Monitor User's Guide

- [Self-Test](#)
- [Built-in Diagnostics](#)
- [Common Problems](#)
- [Product Specific Problems](#)
- [Universal Serial Bus \(USB\) Specific Problems](#)
- [Dell™ Soundbar Problems](#)
- [Card Reader Troubleshooting](#)

⚠ WARNING: Before you begin any of the procedures in this section, follow the [Safety Instructions](#).

Self-Test

Your monitor provides a self-test feature that allows you to check whether your monitor is functioning properly. If your monitor and computer are properly connected but the monitor screen remains dark, run the monitor self-test by performing the following steps:

1. Turn Off both your computer and the monitor.
2. Unplug the video cable from the back of the computer. To ensure proper self-test operation, remove all video cables from the back of computer.
3. Turn On the monitor.

The floating dialog box should appear on-screen (against a black background), if the monitor cannot sense a video signal and is working correctly. While in self-test mode, the power LED remains white. Also, depending upon the selected input, one of the dialogs shown below will continuously scroll through the screen.

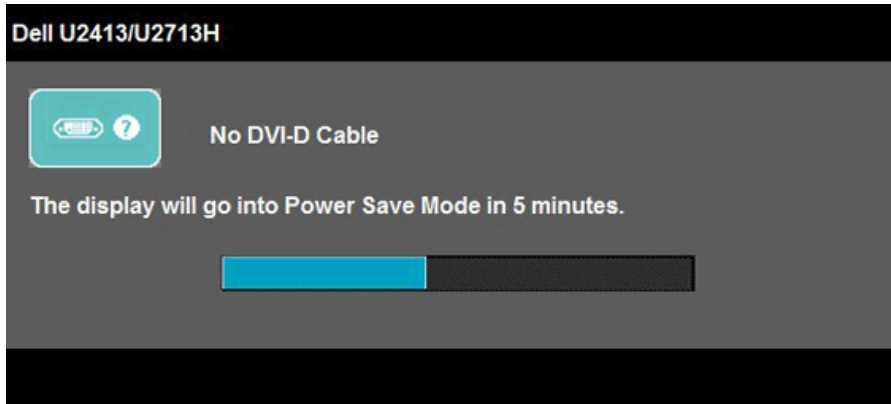

or

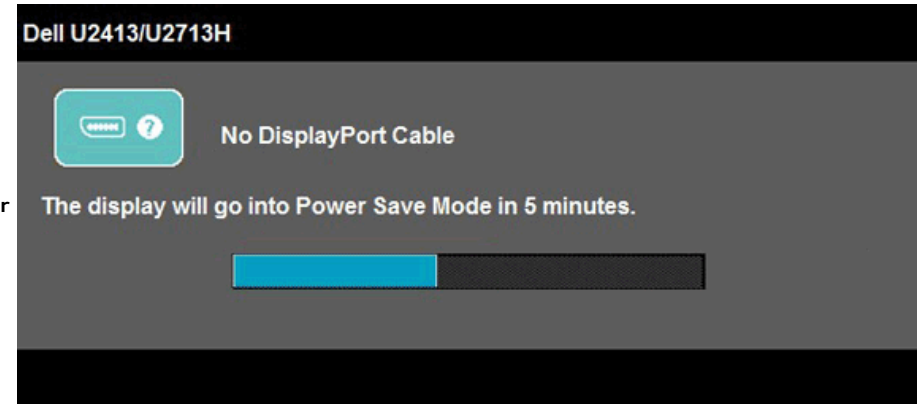

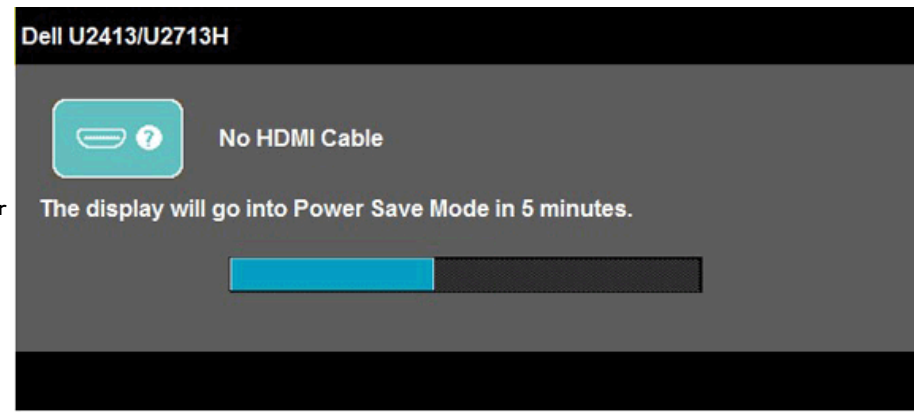
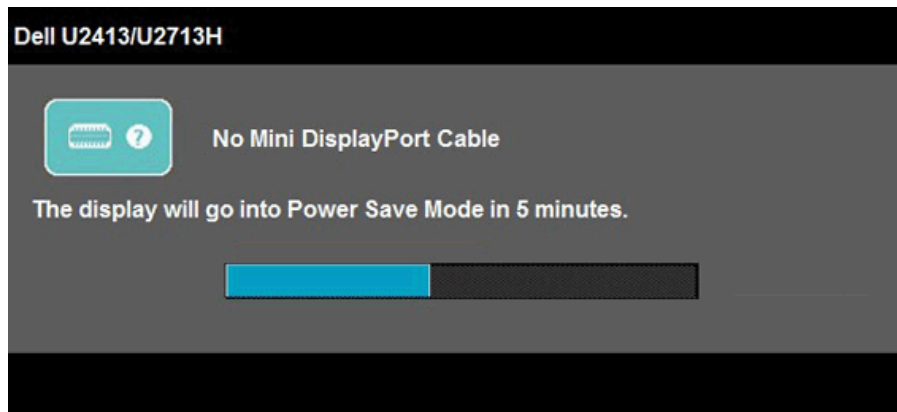

4. This box also appears during normal system operation, if the video cable becomes disconnected or damaged.
5. Turn Off your monitor and reconnect the video cable; then turn On both your computer and the monitor.

If your monitor screen remains blank after you use the previous procedure, check your video controller and computer, because your monitor is functioning properly.

Built-in Diagnostics

Your monitor has a built-in diagnostic tool that helps you determine if the screen abnormality you are experiencing is an inherent problem with your monitor, or with your computer and video card.

 **NOTE:** You can run the built-in diagnostics only when the video cable is unplugged and the monitor is in *self-test mode*.

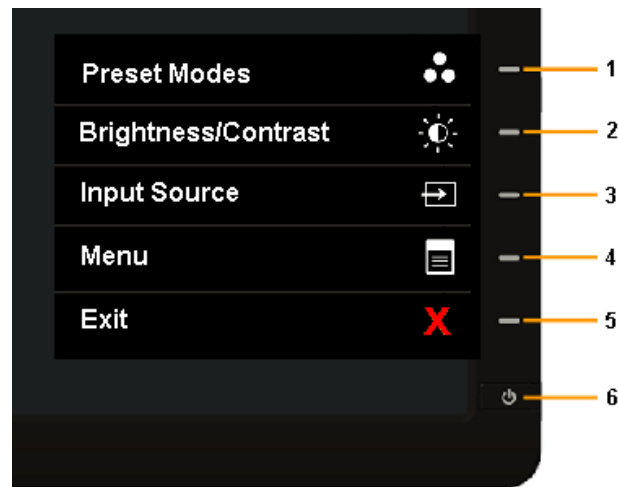

To run the built-in diagnostics:

1. Ensure that the screen is clean (no dust particles on the surface of the screen).
2. Unplug the video cable(s) from the back of the computer or monitor. The monitor then goes into the self-test mode.
3. Press and hold **Button 1** and **Button 4** on the front panel simultaneously for 2 seconds. A gray screen appears.
4. Carefully inspect the screen for abnormalities.
5. Press **Button 4** on the front panel again. The color of the screen changes to red.
6. Inspect the display for any abnormalities.
7. Repeat steps 5 and 6 to inspect the display in green, blue, black, white and text screens.

The test is complete when the white screen appears. To exit, press **Button 4** again.

If you do not detect any screen abnormalities upon using the built-in diagnostic tool, the monitor is functioning properly. Check the video card and computer.

Common Problems

The following table contains general information about common monitor problems you might encounter and the possible solutions:

Common Symptoms	What You Experience	Possible Solutions
No Video/Power LED Off	No picture	<ul style="list-style-type: none"> • Ensure that the video cable connecting the monitor and the computer is properly connected and secure. • Verify that the power outlet is functioning properly using any other electrical equipment. • Ensure that the power button is depressed fully. • Ensure that the correct input source is selected via the Input Source Select button.
No Video/Power LED On	No picture or no brightness	<ul style="list-style-type: none"> • Increase brightness & contrast controls via OSD. • Perform monitor self-test feature check. • Check for bent or broken pins in the video cable connector. • Run the built-in diagnostics. • Ensure that the correct input source is selected via the Input Source Select button.
Poor Focus	Picture is fuzzy, blurry, or ghosting	<ul style="list-style-type: none"> • Eliminate video extension cables. • Reset the monitor to Factory Settings. • Change the video resolution to the correct aspect ratio.
Shaky/Jittery Video	Wavy picture or fine movement	<ul style="list-style-type: none"> • Reset the monitor to Factory Settings. • Check environmental factors. • Relocate the monitor and test in another room. • For U2713H: If you're using DVI connection, ensure that a Dual Link DVI cable is used (Supplied together with the monitor). • Check for loose connection. Unplug & reconnect if required.
Missing Pixels	LCD screen has spots	<ul style="list-style-type: none"> • Cycle power On-Off. • Pixel that is permanently Off is a natural defect that can occur in LCD technology. • For more information on Dell Monitor Quality and Pixel Policy, see Dell Support site at: www.dell.com/support/monitors.
Stuck-on Pixels	LCD screen has bright spots	<ul style="list-style-type: none"> • Cycle power On-Off. • Pixel that is permanently On is a natural defect that can occur in LCD technology. • For more information on Dell Monitor Quality and Pixel Policy, see Dell Support site at: www.dell.com/support/monitors.
Brightness Problems	Picture too dim or too bright	<ul style="list-style-type: none"> • Reset the monitor to Factory Settings. • Adjust brightness & contrast controls via OSD.
Geometric Distortion	Screen not centered correctly	<ul style="list-style-type: none"> • Reset the monitor to Factory Settings.
Horizontal/Vertical Lines	Screen has one or more lines	<ul style="list-style-type: none"> • Reset the monitor to Factory Settings. • Perform monitor self-test feature check and determine if these lines are also in self-test mode. • Check for bent or broken pins in the video cable connector. • Run the built-in diagnostics. • For U2713H: If you're using DVI connection, ensure that a Dual Link DVI cable is used (Supplied together with the monitor). • Check for loose connection. Unplug & reconnect if required.
Synchronization Problems	Screen is scrambled or appears torn	<ul style="list-style-type: none"> • Reset the monitor to Factory Settings. • Perform monitor self-test feature check to determine if the scrambled screen appears in self-test mode. • Check for bent or broken pins in the video cable connector. • Restart the computer in the <i>safe mode</i>. • For U2713H: If you're using DVI connection, ensure that a Dual Link DVI cable is used (Supplied together with the monitor). • Check for loose connection. Unplug & reconnect if required.
Safety Related Issues	Visible signs of smoke or sparks	<ul style="list-style-type: none"> • Do not perform any troubleshooting steps. • Contact Dell immediately.
Intermittent Problems	Monitor malfunctions on & off	<ul style="list-style-type: none"> • Ensure that the video cable connecting the monitor to the computer is connected properly and is secure. • Reset the monitor to Factory Settings. • Perform monitor self-test feature check to determine if the intermittent problem occurs in self-test mode.
Missing Color	Picture missing color	<ul style="list-style-type: none"> • Perform monitor self-test feature check. • Ensure that the video cable connecting the monitor to the computer is connected properly and is secure. • Check for bent or broken pins in the video cable connector.

Wrong Color	Picture color not good	<ul style="list-style-type: none"> Change the Color Setting Mode in the Color Settings OSD to Graphics or Video depending on the application. Try different Color Preset Settings in Color Settings OSD. Adjust R/G/B value in Color Settings OSD if the Color Management is turned Off. Change the Input Color Format to PC RGB or YPbPr in the Advance Setting OSD. Run the built-in diagnostics.
Image retention from a static image left on the monitor for a long period of time	Faint shadow from the static image displayed appears on the screen	<ul style="list-style-type: none"> Use the Power Management feature to turn Off the monitor at all times when not in use (for more information, see Power Management Modes). Alternatively, use a dynamically changing screensaver.

Product Specific Problems

Specific Symptoms	What You Experience	Possible Solutions
Screen image is too small	Image is centered on screen, but does not fill entire viewing area	<ul style="list-style-type: none"> Check the Scaling Ratio setting in the Image Setting OSD. Reset the monitor to Factory Settings.
Cannot adjust the monitor with the buttons on the front panel	OSD does not appear on the screen	<ul style="list-style-type: none"> Turn Off the monitor, unplug the power cord, plug it back, and then turn On the monitor. Check whether the OSD menu is locked. If yes, press and hold the button above the Power button for 10 seconds to unlock (for more information, see Menu Lock).
No Input Signal when user controls are pressed	No picture, the LED light is white.	<ul style="list-style-type: none"> Check the signal source. Ensure the Computer is not in the power saving mode by moving the mouse or pressing any key on the keyboard. Check whether the signal cable is plugged in properly. Re-plug the signal cable if necessary. Reset the computer or video player.
The picture does not fill the entire screen.	The picture cannot fill the height or width of the screen	<ul style="list-style-type: none"> Due to different video formats (aspect ratio) of DVDs, the monitor may display in full screen. Run the built-in diagnostics.
No image when using DP connection to the PC	Black screen	<ul style="list-style-type: none"> Verify which DP standard (DP 1.1a or DP 1.2) is your Graphics Card certified to. Download and install the latest Graphics Card driver. Some DP 1.1a Graphics Card cannot support DP 1.2 monitors. Change the monitor DP setting to match your Graphics Card by following instruction found in section "Connecting the Monitor For DP MST Function".

Universal Serial Bus (USB) Specific Problems

Specific Symptoms	What You Experience	Possible Solutions
USB interface is not working	USB peripherals are not working	<ul style="list-style-type: none"> Check that your monitor is turned On. Reconnect the upstream cable to your computer. Reconnect the USB peripherals (downstream connector). Switch Off and then turn On the monitor again. Reboot the computer. Some USB devices like external portable HDD require higher electric current; connect the device directly to the computer system.
High Speed USB 3.0 interface is slow.	High Speed USB 3.0 peripherals working slowly or not working at all	<ul style="list-style-type: none"> Check that your computer is USB 3.0-capable. Some computers have both USB 3.0, USB 2.0 and USB 1.1 ports. Ensure that the correct USB port is used. Reconnect the upstream cable to your computer. Reconnect the USB peripherals (downstream connector). Reboot the computer.

Dell™ Soundbar Problems

Common Symptoms	What You Experience	Possible Solutions
No Sound	No power to Soundbar - the power indicator is off	<ul style="list-style-type: none"> Turn the Power/Volume knob on the soundbar clockwise to the middle position; check if the power indicator (Blue LED) on the front of the soundbar is illuminated. Confirm that the power cable from the soundbar is plugged into the adapter.
No Sound	Soundbar has power - power indicator is on	<ul style="list-style-type: none"> Plug the audio line-in cable into the computer's audio out jack.

		<ul style="list-style-type: none"> • Play some audio content on the computer (i.e. audio CD, or MP3). • Turn the Power/Volume knob on the soundbar clockwise to a higher volume setting. • Clean and reseal the audio line-in plug. • Test the soundbar using another audio source (i.e. portable CD player).
Distorted Sound	Computer's sound card is used as the audio source	<ul style="list-style-type: none"> • Clear any obstructions between the soundbar and the user. • Confirm that the audio line-in plug is completely inserted into the jack of the sound card. • Set all Windows volume controls to their midpoints. • Decrease the volume of the audio application. • Turn the Power/Volume knob on the soundbar counter-clockwise to a lower volume setting. • Clean and reseal the audio line-in plug. • Troubleshoot the computer's sound card. • Test the Soundbar using another audio source (i.e. portable CD player).
Distorted Sound	Other audio source is used	<ul style="list-style-type: none"> • Clear any obstructions between the soundbar and the user. • Confirm that the audio line-in plug is completely inserted into the jack of the audio source. • Decrease the volume of the audio source. • Turn the Power/Volume knob on the soundbar counter-clockwise to a lower volume setting. • Clean and reseal the audio line-in plug.
Unbalanced Sound Output	Sound from only one side of Soundbar	<ul style="list-style-type: none"> • Clear any obstructions between the soundbar and the user. • Confirm that the audio line-in plug is completely inserted into the jack of the sound card or audio source. • Set all Windows audio balance controls (L-R) to their midpoints. • Clean and reseal the audio line-in plug. • Troubleshoot the computer's sound card. • Test the soundbar using another audio source (i.e. portable CD player).
Low Volume	Volume is too low	<ul style="list-style-type: none"> • Clear any obstructions between the soundbar and the user. • Turn the Power/Volume knob on the soundbar clockwise to the maximum volume setting. • Set all Windows volume controls to their maximum. • Increase the volume of the audio application. • Test the soundbar using another audio source (i.e. portable CD player).

Troubleshooting the Card Reader

 **CAUTION:** Do not remove the device while reading or writing media. Doing so may cause loss of data or malfunction in the media.

Problem	Cause	Solution
Drive letter is not assigned. (Windows® XP only)	Conflict with network drive letter.	<p>A. Right-click My Computer on the desktop, and then click Manage. Under Computer Management, click Desk Management.</p> <p>B. In the list of drives in the right panel, right-click Removable Device and then click Change Drive Letter and Paths.</p> <p>C. Click Change, and in the drop-down box, specify a drive letter for the Removable Device, choosing one that is not assigned to the mapped network drives.</p> <p>D. Click OK, then click OK again</p>
Drive letter is assigned, but the media is not accessible	The media needs reformatting.	Right-click the drive in Explorer and choose Format from the resulting menu.
The media has been ejected during writing or erasing.	Displays the error message, "Error copying file or folder." Displays the error message, "Cannot write folder (folder name) or file (file name)," during writing, or, "Cannot remove folder (folder name) or file(file name)," while erasing, you cannot write or erase in the same folder or file name.	<p>Reinsert the media and write or erase again.</p> <p>Format the media for writing or erasing the same folder or file name.</p>
Despite the disappearance of the pop-up window, the media has been ejected while the LED was blinking.	Although the pop-up window disappears during writing, if you eject your media while the LED is still blinking, then you cannot complete your action on the media.	Format the media for writing or erasing the same folder or file name.
Cannot format or write on the media.	Write protect switch is enabled.	Verify that the write-protect switch of the media is unlocked.
Card reader is not working	USB interface is not working. Download from www.Somanuals.com . All Manuals Search And Download.	Check that your monitor is powered On. load.

Reconnect the upstream cable from your computer to the monitor.

Reinsert the media.

Switch Off and then turn On the monitor again.

Reboot the computer.

[Back to Contents Page](#)

Appendix

Dell™ U2413/U2713H Monitor User's Guide

- [Safety Instructions](#)
 - [FCC Notice \(U.S. Only\) and Other Regulatory Information](#)
 - [Contacting Dell](#)
-



WARNING: Safety Instructions

WARNING: Use of controls, adjustments, or procedures other than those specified in this documentation may result in exposure to shock, electrical hazards, and/or mechanical hazards.

For information on safety instructions, see the *Product Information Guide*.

FCC Notices (U.S. Only) and Other Regulatory Information

For FCC notices and other regulatory information, see the regulatory compliance website located at www.dell.com/regulatory_compliance.

Contacting Dell

For customers in the United States, call 800-WWW-DELL (800-999-3355).

 **NOTE:** If you do not have an active Internet connection, you can find contact information on your purchase invoice, packing slip, bill, or Dell product catalog.

Dell provides several online and telephone-based support and service options. Availability varies by country and product, and some services may not be available in your area.

To get online monitor support content:

1. Visit www.dell.com/support/monitors

To contact Dell for sales, technical support, or customer service issues:

1. Visit support.dell.com
 2. Verify your country or region in the **Choose A Country/Region** drop-down menu at the bottom of the page.
 3. Click **Contact Us** on the left side of the page.
 4. Select the appropriate service or support link based on your need.
 5. Choose the method of contacting Dell that is convenient for you.
-

Setting Up Your Monitor

Dell™ U2413/U2713H Monitor User's Guide

Setting the display resolution

For maximum display performance with Microsoft® Windows® operating systems, set the display resolution to **1920 x 1200** (for U2413) or **2560 x 1440** (for U2713H) pixels by performing the following steps:

In Windows Vista®, Windows® 7 or Windows® 8:

1. For Windows® 8 only, select the **Desktop** tile to switch to classic desktop.
2. Right-click on the desktop and click **Screen resolution**.
3. Click the Dropdown list of the Screen resolution and select **1920 x 1200** (for U2413) or **2560 x 1440** (for U2713H).
4. Click **OK**.

If you do not see the recommended resolution as an option, you may need to update your graphics driver. Please choose the scenario below that best describes the computer system you are using, and follow the given steps.

1: [If you have a Dell™ desktop or a Dell™ portable computer with internet access.](#)

2: [If you have a non Dell™ desktop, portable computer, or graphics card.](#)

Setting Up Your Monitor

Dell™ U2413/U2713H Monitor User's Guide

If you have a Dell™ desktop or a Dell™ portable computer with internet access

1. Go to <http://support.dell.com> , enter your service tag, and download the latest driver for your graphics card.
2. After installing the drivers for your Graphics Adapter, attempt to set the resolution to **1920 x 1200** (for U2413) **or 2560 x 1440** (for U2713H) again.

 **NOTE:** If you are unable to set the resolution to 1920 x 1200/2560 x 1440, please contact Dell™ to inquire about a Graphics Adapter that supports these resolutions.

Setting Up Your Monitor

Dell™ U2413/U2713H Monitor User's Guide

If you have a non Dell™ desktop, portable computer, or graphics card

In Windows Vista® , Windows® 7 or Windows® 8:

1. For Windows® 8 only, select the **Desktop** tile to switch to classic desktop.
2. Right-click on the desktop and click **Personalization**.
3. Click **Change Display Settings**.
4. Click **Advanced Settings**.
5. Identify your graphics controller supplier from the description at the top of the window (e.g. NVIDIA, ATI, Intel etc.).
6. Refer to the graphic card provider website for updated driver (for example, <http://www.ATI.com> OR <http://www.NVIDIA.com>).
7. After installing the drivers for your Graphics Adapter, attempt to set the resolution to **1920 x 1200** (for U2413) **or 2560 x 1440** (for U2713H) again.

 **NOTE:** If you are unable to set the recommended resolution, please contact the manufacturer of your computer or consider purchasing a graphics adapter that will support the video resolution.

Free Manuals Download Website

<http://myh66.com>

<http://usermanuals.us>

<http://www.somanuals.com>

<http://www.4manuals.cc>

<http://www.manual-lib.com>

<http://www.404manual.com>

<http://www.luxmanual.com>

<http://aubethermostatmanual.com>

Golf course search by state

<http://golfingnear.com>

Email search by domain

<http://emailbydomain.com>

Auto manuals search

<http://auto.somanuals.com>

TV manuals search

<http://tv.somanuals.com>