

XPS 8700

Owner's Manual

Computer model: XPS 8700

Regulatory model: D14M

Regulatory type: D14M001



Notes, Cautions, and Warnings



NOTE: A NOTE indicates important information that helps you make better use of your computer.



CAUTION: A CAUTION indicates potential damage to hardware or loss of data if instructions are not followed.



WARNING: A WARNING indicates a potential for property damage, personal injury, or death.

© 2013 Dell Inc.

Trademarks used in this text: Dell™, the DELL logo, and XPS™ are trademarks of Dell Inc.; Microsoft® and Windows® are registered trademarks of Microsoft Corporation in the United States and/or other countries; Bluetooth® is a registered trademark owned by Bluetooth SIG, Inc. and is used by Dell under license; Intel® and Intel SpeedStep® are registered trademarks of Intel Corporation in the U.S. and/or other countries.

2013 - 04

Rev. A00

Contents

Before You Begin	9
Turn Off Your Computer and Connected Devices.	9
Safety Instructions.	10
Recommended Tools.	10
After Working Inside Your Computer	11
Technical Overview	12
Inside View of Your Computer.	12
System-Board Components	13
Removing the Computer Cover	15
Procedure	15
Replacing the Computer Cover	16
Procedure	16
Postrequisites.	16
Removing the Memory Module(s)	17
Prerequisites.	17
Procedure	17
Replacing the Memory Module(s)	18
Procedure	18
Postrequisites.	20
Removing the Front Bezel	21
Prerequisites.	21
Procedure	22
Replacing the Front Bezel	23
Procedure	23
Postrequisites.	23

Removing the Graphics-Card Bracket (optional)	24
Prerequisites.	24
Procedure	24
Replacing the Graphics-Card Bracket (optional)	25
Procedure	25
Postrequisites.	25
Removing the Graphics Card	26
Prerequisites.	26
Procedure	27
Replacing the Graphics Card	29
Procedure	29
Postrequisites.	29
Removing the Wireless Mini-Card	30
Prerequisites.	30
Procedure	30
Replacing the Wireless Mini-Card	32
Procedure	32
Postrequisites.	32
Removing the mSATA Drive.	33
Prerequisites.	33
Procedure	33
Replacing the mSATA Drive.	34
Procedure	34
Postrequisites.	34
Removing the Primary Hard-Drive	35
Prerequisites.	35
Procedure	36

Replacing the Primary Hard-Drive	37
Procedure	37
Postrequisites.	37
Removing the Hard-Drive Cage	38
Prerequisites	38
Procedure	38
Replacing the Hard-Drive Cage	39
Procedure	39
Postrequisites.	39
Removing the Secondary Hard-Drive (optional)	40
Prerequisites	40
Procedure	40
Replacing the Secondary Hard-Drive (optional)	41
Procedure	41
Postrequisites.	41
Installing a third Hard-Drive (optional)	42
Prerequisites	42
Procedure	42
Postrequisites.	44
Removing the Optical Drive	45
Prerequisites	45
Procedure	45
Replacing the Optical Drive	46
Procedure	46
Postrequisites.	46
Removing the Top Cover.	47
Prerequisites	47
Procedure	47

Replacing the Top Cover	48
Procedure	48
Postrequisites.	48
Removing the Media-Card Reader	49
Prerequisites.	49
Procedure	49
Replacing the Media-Card Reader	50
Procedure	50
Postrequisites.	50
Removing the Top I/O Panel	51
Prerequisites.	51
Procedure	51
Replacing the Top I/O Panel	53
Procedure	53
Postrequisites.	53
Removing the Front USB Panel	54
Prerequisites.	54
Procedure	54
Replacing the Front USB Panel	56
Procedure	56
Postrequisites.	56
Removing the Power Button Module	57
Prerequisites.	57
Procedure	57
Replacing the Power Button Module	59
Procedure	59
Postrequisites.	59
Removing the Chassis Fan	60
Prerequisites.	60
Procedure	60

Replacing the Chassis Fan	61
Procedure	61
Postrequisites.	61
Removing the Processor Fan and Heat-Sink	62
Procedure	62
Replacing the Processor Fan and Heat-Sink	64
Procedure	64
Postrequisites.	64
Removing the Processor	65
Prerequisites	65
Procedure	65
Replacing the Processor	67
Procedure	68
Postrequisites.	68
Removing the Coin-Cell Battery	69
Prerequisites	69
Procedure	69
Replacing the Coin-Cell Battery	70
Procedure	70
Postrequisites.	70
Removing the Power-Supply Unit	71
Prerequisites	71
Procedure	71
Replacing the Power-Supply Unit	72
Procedure	72
Postrequisites.	72
Removing the System Board	73
Prerequisites	73
Procedure	74

Replacing the System Board	75
Procedure	75
Postrequisites.	75
Entering the Service Tag in system setup.	75
System Setup	76
Overview	76
Entering System Setup	76
Changing Boot Sequence.	82
Clearing Forgotten Passwords.	83
Clearing CMOS Settings.	84
Flashing the BIOS.	85
More Information.	86

Before You Begin

Turn Off Your Computer and Connected Devices



CAUTION: To avoid losing data, save and close all open files and exit all open programs before you turn off your computer.

- 1 Save and close all open files and exit all open programs.
- 2 Move your mouse pointer to the upper-right or lower-right corner of the screen to open the Charms sidebar, and then click **Settings**→ **Power**→ **Shut down**.











NOTE: If you are using a different operating system, see the documentation of your operating system for shut-down instructions.

- 3 Disconnect your computer and all attached devices from their electrical outlets.
- 4 Disconnect all telephone cables, network cables, and attached devices from your computer.
- 5 Press and hold the power button for 5 seconds after the computer is unplugged to ground the system board.

Safety Instructions

Use the following safety guidelines to protect your computer from potential damage and ensure your personal safety.

-  **WARNING:** Before working inside your computer, read the safety information that shipped with your computer. For additional safety best practices information, see the Regulatory Compliance Homepage at dell.com/regulatory_compliance.
-  **WARNING:** Disconnect all power sources before opening the computer cover or panels. After you finish working inside the computer, replace all covers, panels, and screws before connecting to the power source.
-  **CAUTION:** To avoid damaging the computer, ensure that the work surface is flat and clean.
-  **CAUTION:** To avoid damaging the components and cards, handle them by their edges and avoid touching pins and contacts.
-  **CAUTION:** Only a certified service technician is authorized to remove the computer cover and access any of the components inside the computer. See the safety instructions for complete information about safety precautions, working inside your computer, and protecting against electrostatic discharge.
-  **CAUTION:** Before touching anything inside your computer, ground yourself by touching an unpainted metal surface, such as the metal at the back of the computer. While you work, periodically touch an unpainted metal surface to dissipate static electricity, which could harm internal components.
-  **CAUTION:** When you disconnect a cable, pull on its connector or on its pull-tab, not on the cable itself. Some cables have connectors with locking tabs or thumb-screws that you must disengage before disconnecting the cable. When disconnecting cables, keep them evenly aligned to avoid bending any connector pins. When connecting cables, ensure that the connectors and ports are correctly oriented and aligned.
-  **CAUTION:** To disconnect a network cable, first unplug the cable from your computer and then unplug the cable from the network device.
-  **CAUTION:** Press and eject any installed card from the media-card reader.

Recommended Tools

The procedures in this document may require the following tools:

- Phillips screwdriver
- Plastic scribe

After Working Inside Your Computer

After you complete the replacement procedures, ensure the following:

- Replace all screws and ensure that no stray screws remain inside your computer.
- Place the computer in an upright position.
- Connect any external devices, cables, cards, and any other part(s) you removed before working on your computer.
- Connect your computer and all attached devices to their electrical outlets.



CAUTION: Before turning on your computer, replace all screws and ensure that no stray screws remain inside the computer. Failure to do so may damage your computer.

Technical Overview



WARNING: Before working inside your computer, read the safety information that shipped with your computer and follow the steps in "Before You Begin" on page 9. After working inside your computer, follow the instructions in "After Working Inside Your Computer" on page 11. For additional safety best practices information, see the Regulatory Compliance Homepage at dell.com/regulatory_compliance.

Inside View of Your Computer

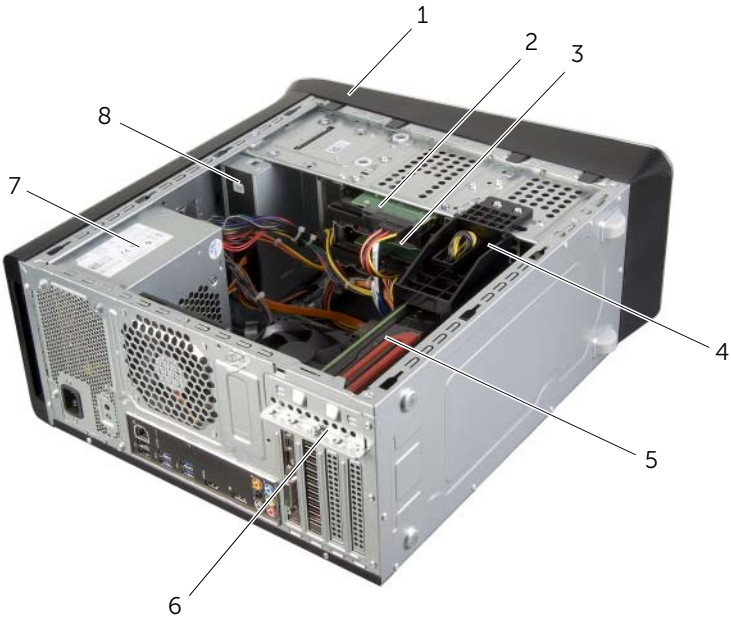

1	front bezel	2	primary hard-drive
3	secondary hard-drive	4	graphics-card bracket (optional)
5	graphics card	6	card retention bracket
7	power supply	8	optical drive

System-Board Components

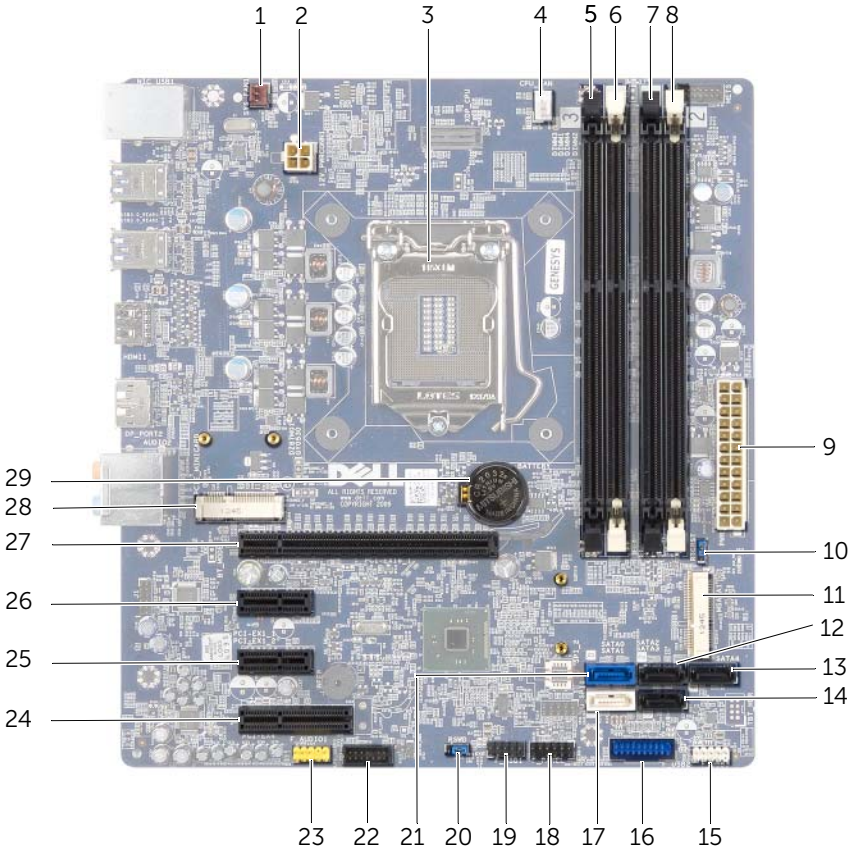

1	chassis fan connector (SYS_FAN 1)	2	power connector (PWRCONN1)
3	processor socket	4	processor fan connector (CPU_FAN)
5	memory module connector (DIMM3)	6	memory module connector (DIMM1)
7	memory module connector (DIMM4)	8	memory module connector (DIMM2)
9	main power connector (PWR1)	10	CMOS reset jumper (RTCST)

11	mSATA slot (MSATA1)	12	SATA 3.0 (6 Gb/s) drive connector (SATA 2)
13	SATA 3.0 (6 Gb/s) drive connector (SATA 4)	14	SATA 3.0 (6 Gb/s) drive connector (SATA 3)
15	front panel USB connector (F_USB3)	16	front panel USB connector (F_USB2)
17	SATA 3.0 (6 Gb/s) drive connector (SATA 1)	18	power button connector (F_PANEL)
19	front panel USB connector (F_USB1)	20	password reset jumper (PSWD)
21	SATA 3.0 (6 Gb/s) drive connector (SATA 0)	22	front panel USB connector (F_USB4)
23	front panel audio connector (F_AUDIO1)	24	PCI-Express x1 card slot (PCI-EX1_4)
25	PCI-Express x1 card slot (PCI-EX1_2)	26	PCI-Express x1 card slot (PCI-EX1_1)
27	PCI-Express x16 card slot (PCI-EX16_1)	28	Mini-Card slot (PCIE_MINICARD)
29	battery socket (BATTERY)		

Removing the Computer Cover

⚠ WARNING: Before working inside your computer, read the safety information that shipped with your computer and follow the steps in "Before You Begin" on page 9. After working inside your computer, follow the instructions in "After Working Inside Your Computer" on page 11. For additional safety best practices information, see the Regulatory Compliance Homepage at dell.com/regulatory_compliance.

Procedure

- 1 Lay the computer on its side with the computer cover facing up.
- 2 Remove the thumbscrew that secures the computer cover to the chassis, using a screw driver, if necessary.
- 3 Release the computer cover by sliding it away from the front of the computer.
- 4 Lift the cover away from the computer and set it aside in a secure location.



1 thumbscrew

2 computer cover

Replacing the Computer Cover



WARNING: Before working inside your computer, read the safety information that shipped with your computer and follow the steps in "Before You Begin" on page 9. After working inside your computer, follow the instructions in "After Working Inside Your Computer" on page 11. For additional safety best practices information, see the Regulatory Compliance Homepage at dell.com/regulatory_compliance.

Procedure

- 1 Connect all the cables and fold the cables out of the way.
- 2 Ensure that no tools or extra parts are left inside the computer.
- 3 Align the tabs at the bottom of the computer cover with the slots located along the edge of the chassis.
- 4 Press the computer cover down and slide it towards the front of the computer.
- 5 Replace the thumbscrew that secures the computer cover to the chassis.
- 6 Place the computer in an upright position.

Postrequisites

Follow the instructions in "After Working Inside Your Computer" on page 11.

Removing the Memory Module(s)

⚠ WARNING: Before working inside your computer, read the safety information that shipped with your computer and follow the steps in "Before You Begin" on page 9. After working inside your computer, follow the instructions in "After Working Inside Your Computer" on page 11. For additional safety best practices information, see the Regulatory Compliance Homepage at dell.com/regulatory_compliance.

Prerequisites

- 1 Remove the computer cover. See "Removing the Computer Cover" on page 15.
- 2 Remove the graphics card. See "Removing the Graphics Card" on page 26.

Procedure

⚠ WARNING: The memory module(s) may become hot during normal operation. Allow the memory module(s) to cool before touching them.

- 1 Press out the securing clip at each end of the memory-module connector.

🔧 NOTE: If the memory module is difficult to remove, gently ease the memory module back and forth to remove it from the connector.

- 2 Grasp the memory module and pull it upward.

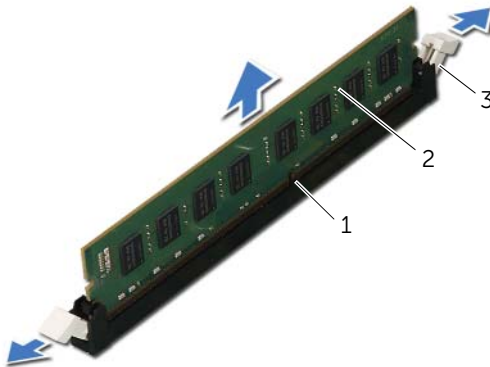

1	memory-module connector	2	memory module
3	securing clips (2)		

Replacing the Memory Module(s)

⚠ WARNING: Before working inside your computer, read the safety information that shipped with your computer and follow the steps in "Before You Begin" on page 9. After working inside your computer, follow the instructions in "After Working Inside Your Computer" on page 11. For additional safety best practices information, see the Regulatory Compliance Homepage at dell.com/regulatory_compliance.

Procedure

⚠ CAUTION: If the memory module is not installed correctly, your computer may not boot.

⚠ CAUTION: If you remove the original memory module(s) from your computer during a memory upgrade, keep them separate from any new module(s) that you may have, even if you purchased the new module(s) from Dell. If possible, do not pair an original memory module with a new memory module. Otherwise, your computer may not start properly.

The recommended memory configurations are:
matched memory modules installed in DIMM connectors 1 and 2 and another matched memory modules installed in DIMM connectors 3 and 4.

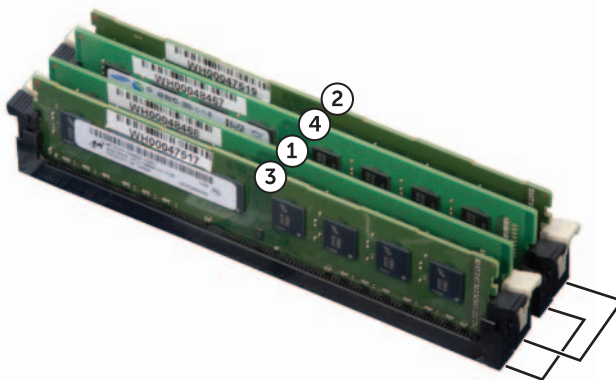

- 1 Press out the securing clip at each end of the memory-module connector.
- 2 Align the notch on the bottom of the memory module with the tab on the memory-module connector.

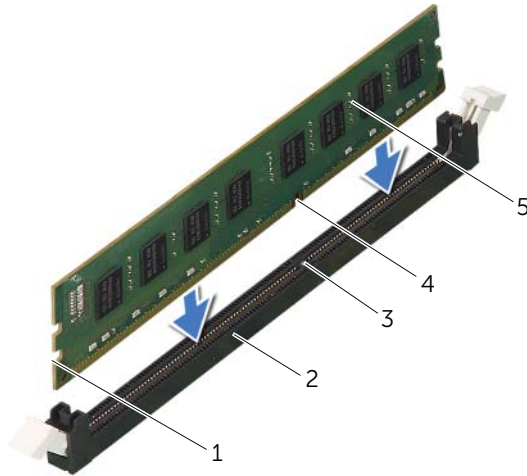

1	cutouts (2)	2	memory-module connector
3	tab	4	notch
5	memory module		

- 3 Insert the memory module into the memory-module connector until the memory module snaps into position.
If you insert the memory module correctly, the securing clips snap into the cutouts at each end of the memory module.

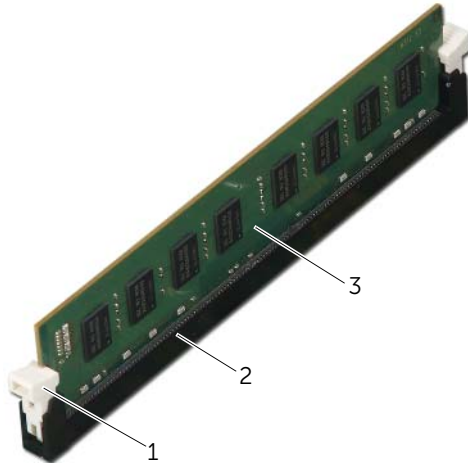

1	securing clip (snapped in position)	2	memory-module connector
3	memory module		

Postrequisites

- 1 Replace the graphics card. See "Replacing the Graphics Card" on page 29.
- 2 Replace the computer cover. See "Replacing the Computer Cover" on page 16.

Removing the Front Bezel



WARNING: Before working inside your computer, read the safety information that shipped with your computer and follow the steps in "Before You Begin" on page 9. After working inside your computer, follow the instructions in "After Working Inside Your Computer" on page 11. For additional safety best practices information, see the Regulatory Compliance Homepage at dell.com/regulatory_compliance.

Prerequisites

Remove the computer cover. See "Removing the Computer Cover" on page 15.

Procedure

- 1 Place the computer in an upright position.
- 2 Grasp and release the front bezel tabs sequentially, one at a time by moving them outward from the front panel.
- 3 Rotate and pull the front bezel away from the front of the computer to release the front bezel clamps from the front panel slots.



1	front bezel	2	front bezel tabs (4)
3	front bezel clamps (3)	4	front panel slots (3)
5	front panel		

Replacing the Front Bezel



WARNING: Before working inside your computer, read the safety information that shipped with your computer and follow the steps in "Before You Begin" on page 9. After working inside your computer, follow the instructions in "After Working Inside Your Computer" on page 11. For additional safety best practices information, see the Regulatory Compliance Homepage at dell.com/regulatory_compliance.

Procedure

- 1 Align and insert the front bezel clamps into the front panel slots.
- 2 Rotate the front bezel towards the computer until the front bezel tabs snap into place.

Postrequisites

Replace the computer cover. See "Replacing the Computer Cover" on page 16.

Removing the Graphics-Card Bracket (optional)

⚠ WARNING: Before working inside your computer, read the safety information that shipped with your computer and follow the steps in "Before You Begin" on page 9. After working inside your computer, follow the instructions in "After Working Inside Your Computer" on page 11. For additional safety best practices information, see the Regulatory Compliance Homepage at dell.com/regulatory_compliance.

Prerequisites

Remove the computer cover. See "Removing the Computer Cover" on page 15.

Procedure

- 1 Remove the screws that secure the graphics-card bracket to the chassis.
- 2 Lift the graphics-card bracket off the chassis.
- 3 Set the graphics-card bracket aside in a secure location.

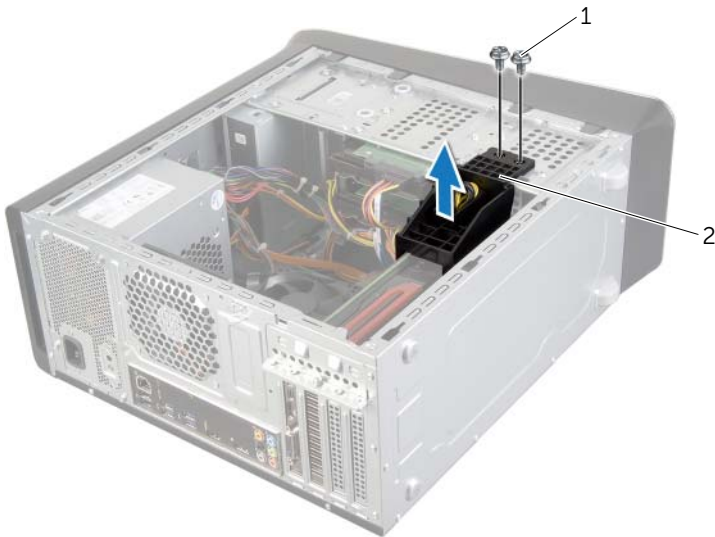

1 screws (2)

2 graphics-card bracket

Replacing the Graphics-Card Bracket (optional)



WARNING: Before working inside your computer, read the safety information that shipped with your computer and follow the steps in "Before You Begin" on page 9. After working inside your computer, follow the instructions in "After Working Inside Your Computer" on page 11. For additional safety best practices information, see the Regulatory Compliance Homepage at dell.com/regulatory_compliance.

Procedure

- 1 Align the screw holes on the graphics-card bracket with the screw holes on the chassis.
- 2 Replace the screws that secure the graphics-card bracket to the chassis..

Postrequisites

Replace the computer cover. See "Replacing the Computer Cover" on page 16.

Removing the Graphics Card



WARNING: Before working inside your computer, read the safety information that shipped with your computer and follow the steps in "Before You Begin" on page 9. After working inside your computer, follow the instructions in "After Working Inside Your Computer" on page 11. For additional safety best practices information, see the Regulatory Compliance Homepage at dell.com/regulatory_compliance.

The system board of your computer is equipped with one PCI-Express x16 connector to install graphics card. To locate the PCI-Express x16 connector on the system board, see "System-Board Components" on page 13.

Prerequisites

- 1 Remove the computer cover. See "Removing the Computer Cover" on page 15.
- 2 Remove the graphics-card bracket, if applicable. See "Removing the Graphics-Card Bracket (optional)" on page 24.

Procedure

- 1 Remove the screw that secures the card-retention bracket to the chassis.
 - 2 Lift the card-retention bracket and set it aside in a secure location.
-  **NOTE:** Your graphics card may have power-cable connectors.
- 3 Press the releasing clips on the power-cable connectors and disconnect the power cable from the graphics card, if applicable.

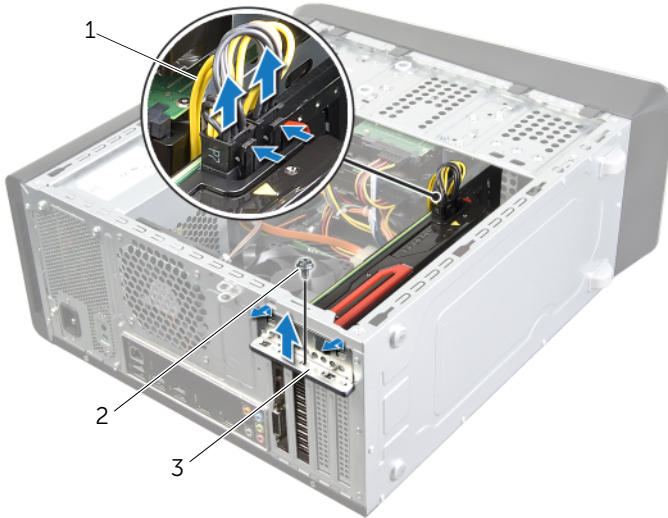

1	power cable	2	screw
3	card-retention bracket		

- 4 Locate the graphics card (PCI-Express x16 card) on the system board. See "System-Board Components" on page 13.
-  **NOTE:** The appearance of the securing tab may be different on your computer.

- 5 Press and hold the securing tab on the card connector, grasp the card by its top corners, and then ease the card out of the card connector.

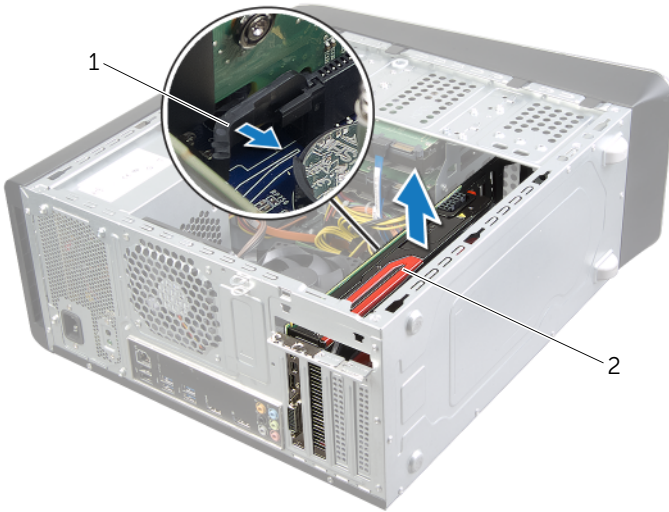

1 securing tab

2 graphics card

Replacing the Graphics Card



WARNING: Before working inside your computer, read the safety information that shipped with your computer and follow the steps in "Before You Begin" on page 9. After working inside your computer, follow the instructions in "After Working Inside Your Computer" on page 11. For additional safety best practices information, see the Regulatory Compliance Homepage at dell.com/regulatory_compliance.

Procedure

- 1 Align the graphics card with the PCI-Express x16 card connector on the system board.
- 2 Place the card in the connector and press down firmly. Ensure that the card is firmly seated in the slot.
- 3 Connect the power cable to the graphics card, if applicable.
- 4 Replace the card-retention bracket, ensuring that:
 - The guide clamp is aligned with the guide notch.
 - The top of all cards and filler brackets are flush with the alignment bar.
 - The notch on top of the card or filler bracket fits around the alignment guide.
- 5 Replace the screw that secures the card-retention bracket.

Postrequisites

- 1 Replace the graphics-card bracket, if applicable. See "Replacing the Graphics-Card Bracket (optional)" on page 25.
- 2 Replace the computer cover. See "Replacing the Computer Cover" on page 16.

Removing the Wireless Mini-Card

⚠ WARNING: Before working inside your computer, read the safety information that shipped with your computer and follow the steps in "Before You Begin" on page 9. After working inside your computer, follow the instructions in "After Working Inside Your Computer" on page 11. For additional safety best practices information, see the Regulatory Compliance Homepage at dell.com/regulatory_compliance.

Prerequisites

Remove the computer cover. See "Removing the Computer Cover" on page 15.

Procedure

- 1 Disconnect the antenna cables from the wireless mini-card.
- 2 Remove the screws that secure the wireless mini-card to the system board.

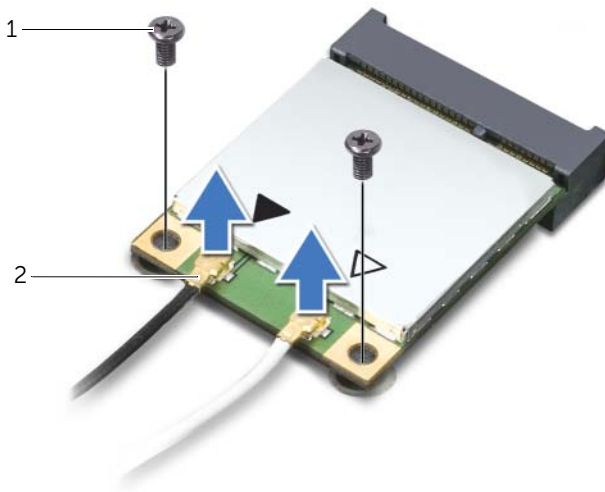

1 screws (2)

2 antenna cables (2)

3 Slide and remove the wireless mini-card out of the wireless mini-card connector.

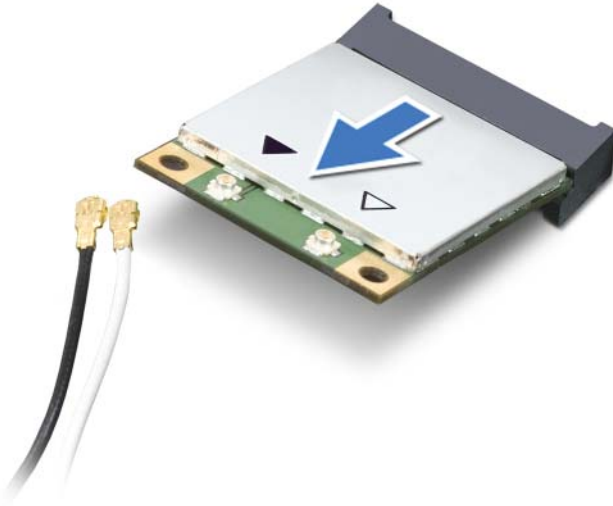

1 wireless mini-card connector

2 wireless mini-card

Replacing the Wireless Mini-Card

 **WARNING:** Before working inside your computer, read the safety information that shipped with your computer and follow the steps in "Before You Begin" on page 9. After working inside your computer, follow the instructions in "After Working Inside Your Computer" on page 11. For additional safety best practices information, see the Regulatory Compliance Homepage at dell.com/regulatory_compliance.

Procedure

 **CAUTION:** To avoid damage to the wireless mini-card, ensure that no cables are placed under the wireless mini-card.

- 1 Align the notch on the wireless mini-card with the tab on the wireless mini-card connector.
- 2 Insert the wireless mini-card at a 45-degree angle into the wireless mini-card connector.
- 3 Press the outer end of the wireless mini-card down and replace the screws that secure the wireless mini-card to the system board.
- 4 Connect the antenna cables to the wireless mini-card.

The following table provides the wireless-antenna cable color schemes for the wireless mini-cards supported by your computer.

Connectors on the mini-card	Wireless-antenna cable color schemes
WLAN + Bluetooth (two cables)	
Main WLAN + Bluetooth (white triangle)	white
Auxiliary WLAN + Bluetooth (black triangle)	black

Postrequisites

Replace the computer cover. See "Replacing the Computer Cover" on page 16.

Removing the mSATA Drive

⚠ WARNING: Before working inside your computer, read the safety information that shipped with your computer and follow the steps in "Before You Begin" on page 9. After working inside your computer, follow the instructions in "After Working Inside Your Computer" on page 11. For additional safety best practices information, see the Regulatory Compliance Homepage at dell.com/regulatory_compliance.

Prerequisites

Remove the computer cover. See "Removing the Computer Cover" on page 15.

Procedure

- 1 Remove the screws that secure the mSATA drive to the system board.
- 2 Lift the mSATA drive away from the system-board connector.

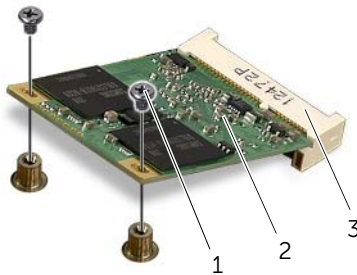

1	screws (2)	2	mSATA drive
3	mSATA-drive connector		

Replacing the mSATA Drive



WARNING: Before working inside your computer, read the safety information that shipped with your computer and follow the steps in "Before You Begin" on page 9. After working inside your computer, follow the instructions in "After Working Inside Your Computer" on page 11. For additional safety best practices information, see the Regulatory Compliance Homepage at dell.com/regulatory_compliance.

Procedure

- 1 Align the notch on the mSATA drive with the tab on the system-board connector.
- 2 Insert the mSATA drive at a 45-degree angle into the system-board connector.
- 3 Press the other end of the mSATA drive down and replace the screws that secure the mSATA drive to the systemboard.

Postrequisites

Replace the computer cover. See "Replacing the Computer Cover" on page 16.

Removing the Primary Hard-Drive

 **WARNING:** Before working inside your computer, read the safety information that shipped with your computer and follow the steps in "Before You Begin" on page 9. After working inside your computer, follow the instructions in "After Working Inside Your Computer" on page 11. For additional safety best practices information, see the Regulatory Compliance Homepage at dell.com/regulatory_compliance.

 **WARNING:** If you remove the hard drive from the computer when the drive is hot, do not touch the metal housing of the hard drive.

 **CAUTION:** To avoid data loss, do not remove the hard drive while the computer is on or in Sleep state.

 **CAUTION:** Hard drives are fragile. Exercise care when handling the hard drive.

Prerequisites

Remove the computer cover. See "Removing the Computer Cover" on page 15.

Procedure

- 1 Disconnect the power and data cables from the primary hard-drive.
- 2 Remove the screws that secure the hard drive to the chassis.
- 3 Slide the hard drive out towards the back of the computer.

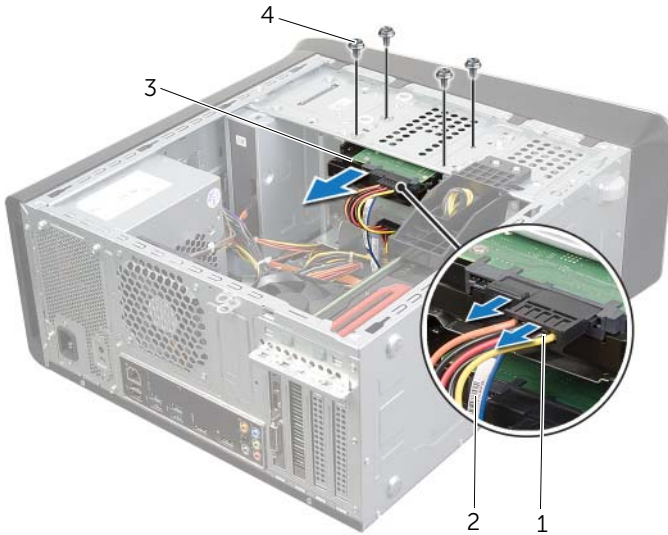

1	power cable	2	data cable
3	primary hard-drive	4	screws (4)

Replacing the Primary Hard-Drive



WARNING: Before working inside your computer, read the safety information that shipped with your computer and follow the steps in "Before You Begin" on page 9. After working inside your computer, follow the instructions in "After Working Inside Your Computer" on page 11. For additional safety best practices information, see the Regulatory Compliance Homepage at dell.com/regulatory_compliance.

Procedure

- 1 Slide the primary hard-drive into the hard-drive cage.
- 2 Align the screw holes on the primary hard-drive with the screw holes on the chassis.
- 3 Replace the screws that secure the primary hard-drive to the chassis.
- 4 Connect the power and data cables to the primary hard-drive.

Postrequisites

Replace the computer cover. See "Replacing the Computer Cover" on page 16.

Removing the Hard-Drive Cage

⚠ WARNING: Before working inside your computer, read the safety information that shipped with your computer and follow the steps in "Before You Begin" on page 9. After working inside your computer, follow the instructions in "After Working Inside Your Computer" on page 11. For additional safety best practices information, see the Regulatory Compliance Homepage at dell.com/regulatory_compliance.

Prerequisites

- 1 Remove the computer cover. See "Removing the Computer Cover" on page 15.
- 2 Remove the primary hard-drive. See "Removing the Primary Hard-Drive" on page 35.

Procedure

- 1 If applicable, disconnect the power and data cables from the secondary hard-drive.
- 2 Remove the screws that secure the hard-drive cage to the chassis.
- 3 Slide and lift the hard-drive cage away from the chassis.

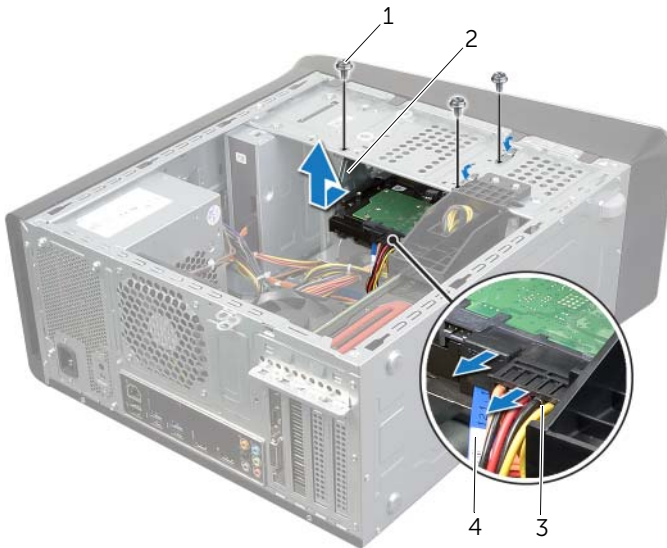

1 screws (3)

2 hard-drive cage

3 power cable

4 data cable

Replacing the Hard-Drive Cage



WARNING: Before working inside your computer, read the safety information that shipped with your computer and follow the steps in "Before You Begin" on page 9. After working inside your computer, follow the instructions in "After Working Inside Your Computer" on page 11. For additional safety best practices information, see the Regulatory Compliance Homepage at dell.com/regulatory_compliance.

Procedure

- 1 Align the screw holes on the hard-drive cage with the screw holes on the chassis.
- 2 Replace the screws that secure the hard-drive cage to the chassis.
- 3 If applicable, connect the power and data cables to the secondary hard-drive.

Postrequisites

- 1 Replace the primary hard-drive. See "Replacing the Primary Hard-Drive" on page 37.
- 2 Replace the computer cover. See "Replacing the Computer Cover" on page 16.

Removing the Secondary Hard-Drive (optional)

⚠ WARNING: Before working inside your computer, read the safety information that shipped with your computer and follow the steps in "Before You Begin" on page 9. After working inside your computer, follow the instructions in "After Working Inside Your Computer" on page 11. For additional safety best practices information, see the Regulatory Compliance Homepage at dell.com/regulatory_compliance.

⚠ WARNING: If you remove the hard drive from the computer when the drive is hot, do not touch the metal housing of the hard drive.

⚠ CAUTION: To avoid data loss, do not remove the hard drive while the computer is on or in Sleep state.

⚠ CAUTION: Hard drives are fragile. Exercise care when handling the hard drive.

Prerequisites

- 1 Remove the computer cover. See "Removing the Computer Cover" on page 15.
- 2 Remove the primary hard-drive. See "Removing the Primary Hard-Drive" on page 35.
- 3 Remove the hard-drive cage. See "Removing the Hard-Drive Cage" on page 38.

Procedure

- 1 Remove the screws that secure the secondary hard-drive to the hard-drive cage.
- 2 Slide the secondary hard-drive out from the hard-drive cage.

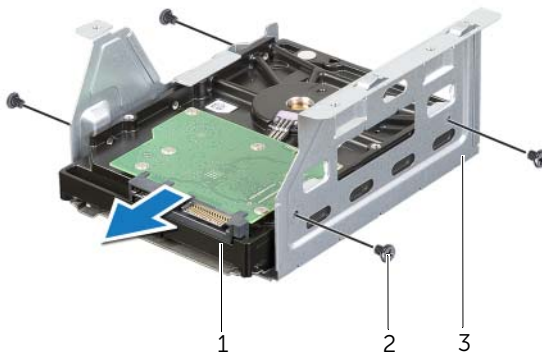

1 secondary hard-drive

2 screws (4)

3 hard-drive cage

Replacing the Secondary Hard-Drive (optional)



WARNING: Before working inside your computer, read the safety information that shipped with your computer and follow the steps in "Before You Begin" on page 9. After working inside your computer, follow the instructions in "After Working Inside Your Computer" on page 11. For additional safety best practices information, see the Regulatory Compliance Homepage at dell.com/regulatory_compliance.

Procedure

- 1 Slide the secondary hard-drive into the hard-drive cage.
- 2 Replace the screws that secure the secondary hard-drive to the hard-drive cage.

Postrequisites

- 1 Replace the hard-drive cage. See "Replacing the Hard-Drive Cage" on page 39.
- 2 Replace the primary hard-drive. See "Replacing the Primary Hard-Drive" on page 37.
- 3 Replace the computer cover. See "Replacing the Computer Cover" on page 16.

Installing a third Hard-Drive (optional)

⚠ WARNING: Before working inside your computer, read the safety information that shipped with your computer and follow the steps in "Before You Begin" on page 9. After working inside your computer, follow the instructions in "After Working Inside Your Computer" on page 11. For additional safety best practices information, see the Regulatory Compliance Homepage at dell.com/regulatory_compliance.

⚠ CAUTION: Hard drives are fragile. Exercise care when handling the hard drive.

Prerequisites

- 1 Remove the computer cover. See "Removing the Computer Cover" on page 15.
- 2 Remove the front bezel. See "Removing the Front Bezel" on page 21.

Procedure

- 1 Insert a screw driver and twist it to remove the break-away metal plate.
- 2 Pull the break-away metal plate away from the chassis.

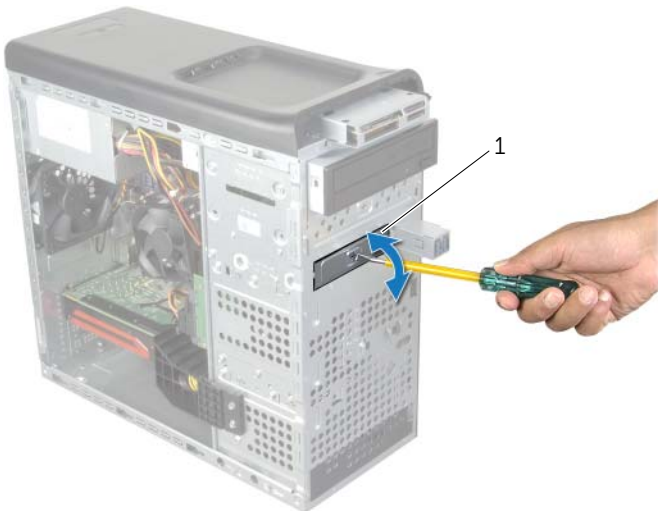

1 break-away metal plate

- 3 Gently slide the third hard-drive into the hard-drive bay through the front of the computer.

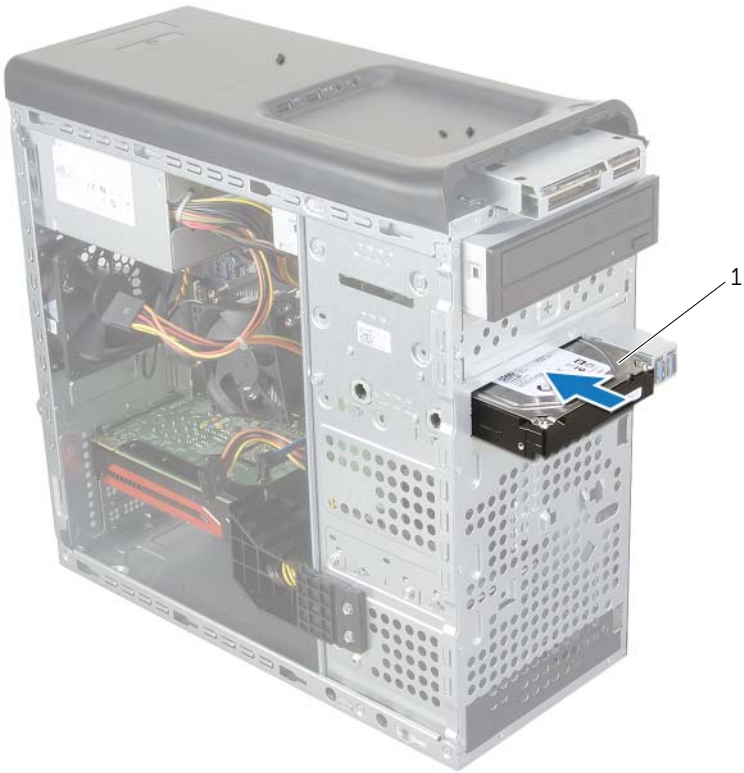

1 third hard-drive

- 4 Replace the screws that secure the third hard-drive to the chassis.
- 5 Connect the power and data cables to the third hard-drive.



1 power cable

2 data cable

3 screws (2)

Postrequisites

- 1 Replace the front bezel. See "Replacing the Front Bezel" on page 23.
- 2 Replace the computer cover. See "Replacing the Computer Cover" on page 16.

Removing the Optical Drive

⚠ WARNING: Before working inside your computer, read the safety information that shipped with your computer and follow the steps in "Before You Begin" on page 9. After working inside your computer, follow the instructions in "After Working Inside Your Computer" on page 11. For additional safety best practices information, see the Regulatory Compliance Homepage at dell.com/regulatory_compliance.

Prerequisites

- 1 Remove the computer cover. See "Removing the Computer Cover" on page 15.
- 2 Remove the front bezel. See "Removing the Front Bezel" on page 21.

Procedure

- 1 Disconnect the power and data cables from the optical drive.
- 2 Remove the screws that secure the optical drive to the chassis.
- 3 Push and slide the optical drive out through the front of the computer.

🔧 NOTE: Repeat steps 1 to 3 to remove secondary optical-drive, if applicable.

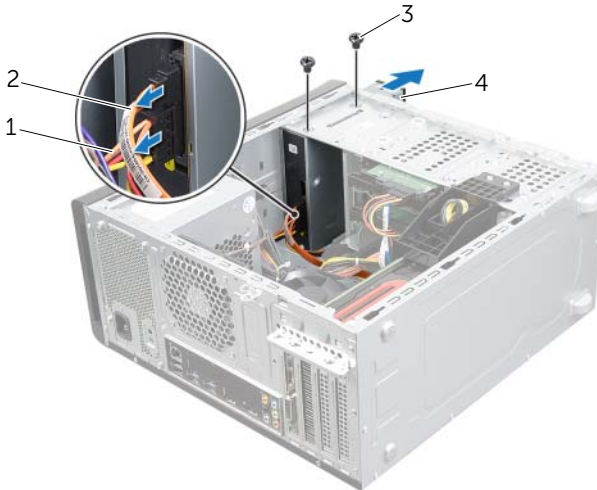

1	power cable	2	data cable
3	screws (2)	4	optical drive

- 4 Set aside the optical drive in a secure location.

Replacing the Optical Drive



WARNING: Before working inside your computer, read the safety information that shipped with your computer and follow the steps in "Before You Begin" on page 9. After working inside your computer, follow the instructions in "After Working Inside Your Computer" on page 11. For additional safety best practices information, see the Regulatory Compliance Homepage at dell.com/regulatory_compliance.

Procedure

- 1 Gently slide the optical drive into the optical-drive bay through the front of the computer.
- 2 Align the screw holes on the optical drive with the screw holes on the chassis.
- 3 Replace the screws that secure the optical drive to the chassis.
- 4 Connect the power and data cables to the optical drive.

Postrequisites

- 1 Replace the front bezel. See "Replacing the Front Bezel" on page 23.
- 2 Replace the computer cover. See "Replacing the Computer Cover" on page 16.

Removing the Top Cover

⚠ WARNING: Before working inside your computer, read the safety information that shipped with your computer and follow the steps in "Before You Begin" on page 9. After working inside your computer, follow the instructions in "After Working Inside Your Computer" on page 11. For additional safety best practices information, see the Regulatory Compliance Homepage at dell.com/regulatory_compliance.

Prerequisites

- 1 Remove the computer cover. See "Removing the Computer Cover" on page 15.
- 2 Remove the front bezel. See "Removing the Front Bezel" on page 21.

Procedure

- 1 Slide and lift the top cover away from top panel.
- 2 Set the top cover aside in a secure location.



1 top cover

Replacing the Top Cover



WARNING: Before working inside your computer, read the safety information that shipped with your computer and follow the steps in "Before You Begin" on page 9. After working inside your computer, follow the instructions in "After Working Inside Your Computer" on page 11. For additional safety best practices information, see the Regulatory Compliance Homepage at dell.com/regulatory_compliance.

Procedure

- 1 Align the tabs on the top cover with the slots on the top panel.
- 2 Press and slide the top cover towards the back of the computer, until it clicks into place.

Postrequisites

- 1 Replace the front bezel. See "Replacing the Front Bezel" on page 23.
- 2 Replace the computer cover. See "Replacing the Computer Cover" on page 16.

Removing the Media-Card Reader

⚠ WARNING: Before working inside your computer, read the safety information that shipped with your computer and follow the steps in "Before You Begin" on page 9. After working inside your computer, follow the instructions in "After Working Inside Your Computer" on page 11. For additional safety best practices information, see the Regulatory Compliance Homepage at dell.com/regulatory_compliance.

Prerequisites

- 1 Remove the computer cover. See "Removing the Computer Cover" on page 15.
- 2 Remove the front bezel. See "Removing the Front Bezel" on page 21.
- 3 Remove the top cover. See "Removing the Top Cover" on page 47.

Procedure

- 1 Remove the screws that secure the media-card reader to the front panel. The screws are located below the media-card reader.
- 2 Disconnect the media-card reader cable from the media-card reader.
- 3 Slide and lift the media-card reader to remove it from the top panel.



1	media-card reader cable
3	screws (2)

2	media-card reader
4	front panel

Replacing the Media-Card Reader



WARNING: Before working inside your computer, read the safety information that shipped with your computer and follow the steps in "Before You Begin" on page 9. After working inside your computer, follow the instructions in "After Working Inside Your Computer" on page 11. For additional safety best practices information, see the Regulatory Compliance Homepage at dell.com/regulatory_compliance.

Procedure

- 1 Gently slide the media-card reader guides into the slots in the top panel
- 2 Replace the screws that secure the media-card reader to the front panel
- 3 Connect the media-card reader cable to the media-card reader.

Postrequisites

- 1 Replace the top cover. See "Replacing the Top Cover" on page 48.
- 2 Replace the front bezel. See "Replacing the Front Bezel" on page 23.
- 3 Replace the computer cover. See "Replacing the Computer Cover" on page 16.

Removing the Top I/O Panel



WARNING: Before working inside your computer, read the safety information that shipped with your computer and follow the steps in "Before You Begin" on page 9. After working inside your computer, follow the instructions in "After Working Inside Your Computer" on page 11. For additional safety best practices information, see the Regulatory Compliance Homepage at dell.com/regulatory_compliance.

Prerequisites

- 1 Remove the computer cover. See "Removing the Computer Cover" on page 15.
- 2 Remove the front bezel. See "Removing the Front Bezel" on page 21.
- 3 Remove the top cover. See "Removing the Top Cover" on page 47.

Procedure

- 1 Disconnect the top I/O panel cables from the system board connectors, F_USB3 and F_AUDIO1. See "System-Board Components" on page 13.
- 2 Remove the screws that secure the top I/O panel to the top panel.
- 3 Slide and lift the top I/O panel from the top panel.

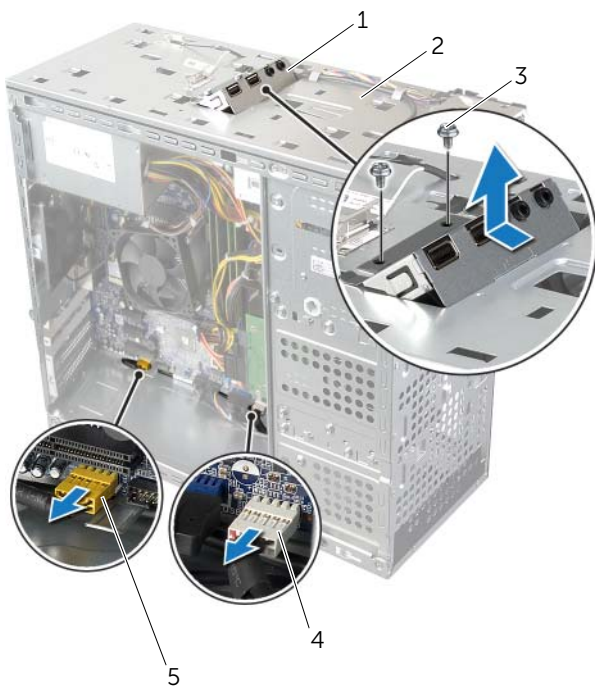

1	top I/O panel	2	top panel
3	screws (2)	4	USB cable connector (F_USB3)
5	Audio cable connector (F_AUDIO1)		

Replacing the Top I/O Panel



WARNING: Before working inside your computer, read the safety information that shipped with your computer and follow the steps in "Before You Begin" on page 9. After working inside your computer, follow the instructions in "After Working Inside Your Computer" on page 11. For additional safety best practices information, see the Regulatory Compliance Homepage at dell.com/regulatory_compliance.

Procedure

- 1 Align the screw holes on the top I/O panel with the screw holes on the top panel.
- 2 Replace the screws that secure the top I/O panel to the top panel.
- 3 Connect the top I/O panel cables to the system board connectors, F_USB3 and F_AUDIO1. See "System-Board Components" on page 13.

Postrequisites

- 1 Replace the top cover. See "Replacing the Top Cover" on page 48.
- 2 Replace the front bezel. See "Replacing the Front Bezel" on page 23.
- 3 Replace the computer cover. See "Replacing the Computer Cover" on page 16.

Removing the Front USB Panel



WARNING: Before working inside your computer, read the safety information that shipped with your computer and follow the steps in "Before You Begin" on page 9. After working inside your computer, follow the instructions in "After Working Inside Your Computer" on page 11. For additional safety best practices information, see the Regulatory Compliance Homepage at dell.com/regulatory_compliance.

Prerequisites

- 1 Remove the computer cover. See "Removing the Computer Cover" on page 15.
- 2 Remove the front bezel. See "Removing the Front Bezel" on page 21.

Procedure



CAUTION: When sliding the front USB panel out of the computer, be extremely careful. Carelessness may result in damage to the cable connectors and the cable routing clips.



NOTE: Note the routing of all cables as you remove them so that you can re-route them correctly after you replace the front USB panel.

- 1 Disconnect the front USB panel cables from the system board connector F_USB2. See "System-Board Components" on page 13.
- 2 Remove the screw that secures the front USB panel to the front panel.
- 3 Slide the front USB panel down and pull it away.



1 front USB panel

2 screw

3 USB panel cables

Replacing the Front USB Panel



WARNING: Before working inside your computer, read the safety information that shipped with your computer and follow the steps in "Before You Begin" on page 9. After working inside your computer, follow the instructions in "After Working Inside Your Computer" on page 11. For additional safety best practices information, see the Regulatory Compliance Homepage at dell.com/regulatory_compliance.

Procedure

- 1 Align and slide the front USB panel clamps into the front USB panel clamp slot.
- 2 Replace the screw that secures the front USB panel to the front panel.
- 3 Connect the front USB panel cables to the system board connector F_USB2. See "System-Board Components" on page 13.

Postrequisites

- 1 Replace the front bezel. See "Replacing the Front Bezel" on page 23.
- 2 Replace the computer cover. See "Replacing the Computer Cover" on page 16.

Removing the Power Button Module



WARNING: Before working inside your computer, read the safety information that shipped with your computer and follow the steps in "Before You Begin" on page 9. After working inside your computer, follow the instructions in "After Working Inside Your Computer" on page 11. For additional safety best practices information, see the Regulatory Compliance Homepage at dell.com/regulatory_compliance.

Prerequisites

- 1 Remove the computer cover. See "Removing the Computer Cover" on page 15.
- 2 Remove the front bezel. See "Removing the Front Bezel" on page 21.
- 3 Remove the top cover. See "Removing the Top Cover" on page 47.

Procedure

- 1 Disconnect the power button module cable from the system board connector F_PANEL. See "System-Board Components" on page 13.
- 2 Press the tabs on the power button module and lift the power button module to release it from the top panel.



1 power button module cable

2 power button module tabs (4)

3 power button module

Replacing the Power Button Module



WARNING: Before working inside your computer, read the safety information that shipped with your computer and follow the steps in "Before You Begin" on page 9. After working inside your computer, follow the instructions in "After Working Inside Your Computer" on page 11. For additional safety best practices information, see the Regulatory Compliance Homepage at dell.com/regulatory_compliance.

Procedure

- 1 Align and push the power button module tabs into the slots on the top panel.
- 2 Connect the power button module cable from the system board connector F_PANEL. See "System-Board Components" on page 13.

Postrequisites

- 1 Replace the top cover. See "Replacing the Top Cover" on page 48.
- 2 Replace the front bezel. See "Replacing the Front Bezel" on page 23.
- 3 Replace the computer cover. See "Replacing the Computer Cover" on page 16.

Removing the Chassis Fan

⚠ WARNING: Before working inside your computer, read the safety information that shipped with your computer and follow the steps in "Before You Begin" on page 9. After working inside your computer, follow the instructions in "After Working Inside Your Computer" on page 11. For additional safety best practices information, see the Regulatory Compliance Homepage at dell.com/regulatory_compliance.

Prerequisites

Remove the computer cover. See "Removing the Computer Cover" on page 15.

Procedure

- 1 Disconnect the chassis fan cable from the system board connector SYS_FAN1. See "System-Board Components" on page 13.
- 2 Remove the screws that secure the chassis fan to the chassis.
- 3 Slide and lift the chassis fan away from the computer.

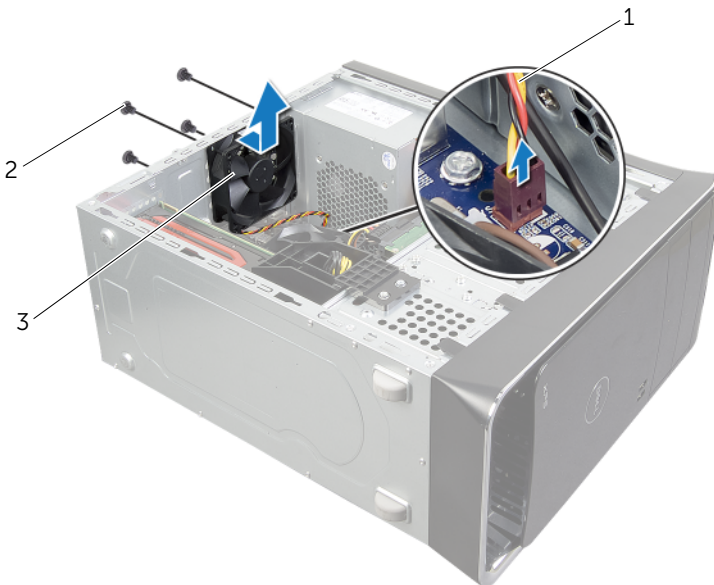

1 chassis fan cable

2 screws (4)

3 chassis fan

Replacing the Chassis Fan



WARNING: Before working inside your computer, read the safety information that shipped with your computer and follow the steps in "Before You Begin" on page 9. After working inside your computer, follow the instructions in "After Working Inside Your Computer" on page 11. For additional safety best practices information, see the Regulatory Compliance Homepage at dell.com/regulatory_compliance.

Procedure

- 1 Align the screw holes on the chassis fan with the screw holes on the chassis.
- 2 Replace the screws that secure the chassis fan to the chassis.
- 3 Connect the chassis fan cable to the system board connector SYS_FAN1. See "System-Board Components" on page 13.

Postrequisites

Replace the computer cover. See "Replacing the Computer Cover" on page 16.

Removing the Processor Fan and Heat-Sink

 **WARNING:** Before working inside your computer, read the safety information that shipped with your computer and follow the steps in "Before You Begin" on page 9. After working inside your computer, follow the instructions in "After Working Inside Your Computer" on page 11. For additional safety best practices information, see the Regulatory Compliance Homepage at dell.com/regulatory_compliance.

 **WARNING:** The heat sink may be hot during normal operation. Provide sufficient time for the heat-sink to cool before you touch it.

 **CAUTION:** To ensure maximum cooling for the processor, do not touch the heat transfer areas on the processor fan and heat-sink assembly. The oils in your skin can reduce the heat transfer capability of the thermal grease.

 **CAUTION:** The processor fan and heat-sink assembly is a single unit. Do not try to remove the fan separately.

Prerequisites

Remove the computer cover. See "Removing the Computer Cover" on page 15.

Procedure

- 1 Disconnect the processor fan cable from the system board connector CPU_FAN. See "System-Board Components" on page 13.
- 2 Using a flat-blade screwdriver loosen the four captive screws that secure the processor fan and heat-sink assembly to the system board.
- 3 Lift the processor fan and heat-sink assembly out of the computer.

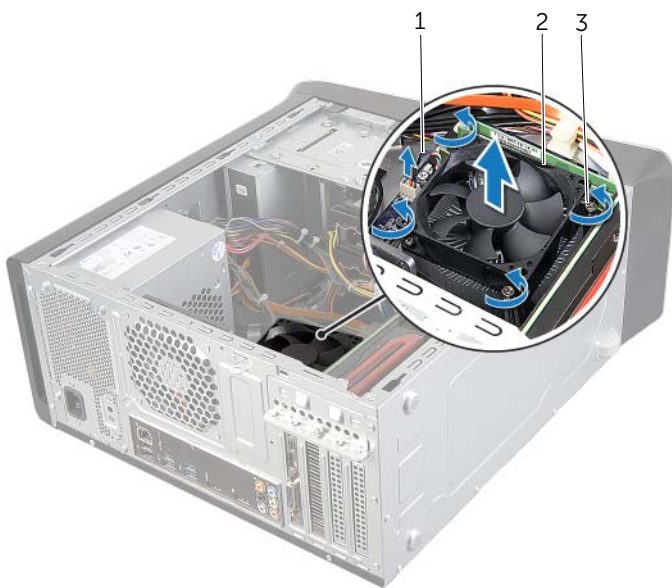

1 processor fan cable

2 processor fan and heat-sink assembly

3 captive screws (4)

Replacing the Processor Fan and Heat-Sink



WARNING: Before working inside your computer, read the safety information that shipped with your computer and follow the steps in "Before You Begin" on page 9. After working inside your computer, follow the instructions in "After Working Inside Your Computer" on page 11. For additional safety best practices information, see the Regulatory Compliance Homepage at dell.com/regulatory_compliance.

Procedure

- 1 Clean the thermal grease from the bottom of the heat-sink.
- 2 Apply new thermal grease to the top of the processor, if applicable.
- 3 Place the processor fan and heat-sink assembly over the processor.
- 4 Align the captive screws on the processor fan and heat-sink assembly with the screw holes on the system board.
- 5 Tighten the captive screws that secure the processor fan and heat-sink assembly to the system board
- 6 Connect the processor fan cable to the system board connector CPU_FAN. See "System-Board Components" on page 13.

Postrequisites

Replace the computer cover. See "Replacing the Computer Cover" on page 16.

Removing the Processor

 **WARNING:** Before working inside your computer, read the safety information that shipped with your computer and follow the steps in "Before You Begin" on page 9. After working inside your computer, follow the instructions in "After Working Inside Your Computer" on page 11. For additional safety best practices information, see the Regulatory Compliance Homepage at dell.com/regulatory_compliance.

 **CAUTION:** Processors are fragile. Handle the processor only by the edges and do not touch the metal pins.

Prerequisites

- 1 Remove the computer cover. See "Removing the Computer Cover" on page 15.

 **WARNING:** Despite having a plastic shield, the processor fan and heat-sink assembly may be very hot during normal operation. Ensure that it has had sufficient time to cool before you touch it.

 **NOTE:** Unless a new processor fan and heat-sink assembly is required for the new processor, reuse the original processor fan and heat-sink assembly when you replace the processor.

- 2 Remove the processor fan and heat-sink. See "Removing the Processor Fan and Heat-Sink" on page 62.

Procedure

- 1 Press the release-lever down and then pull it outwards to release it from the securing tab.
- 2 Extend the release-lever completely to open the processor cover.

3 Gently lift the processor and remove it from the processor socket.

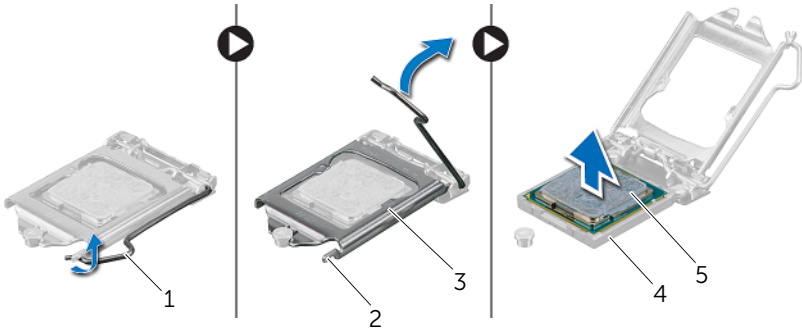

1	release lever	2	securing tab
3	processor cover	4	socket
5	processor		

Replacing the Processor



WARNING: Before working inside your computer, read the safety information that shipped with your computer and follow the steps in "Before You Begin" on page 9. After working inside your computer, follow the instructions in "After Working Inside Your Computer" on page 11. For additional safety best practices information, see the Regulatory Compliance Homepage at dell.com/regulatory_compliance.



NOTE: The original thermal grease can be reused if the original processor and processor heat-sink are reinstalled together. If either the processor or the processor heat-sink is replaced, use the thermal grease provided in the kit to ensure that thermal conductivity is achieved. Ensure that the release lever on the processor socket is fully extended in the open position.

Procedure

- 1 Ensure that the release lever on the processor socket is fully extended in the open position.

⚠ **CAUTION: You must position the processor correctly in the processor socket to avoid permanent damage to the processor.**

- 2 Align the notches on the processor with the tabs on the processor socket.
- 3 Align the pin-1 corner on the processor with the pin-1 corner on the processor socket, and then place the processor in the processor socket.

⚠ **CAUTION: Ensure that the processor-cover notch is positioned underneath the alignment post.**

- 4 When the processor is fully seated in the socket, close the processor cover.
- 5 Pivot the release-lever down and place it under the tab on the processor cover.

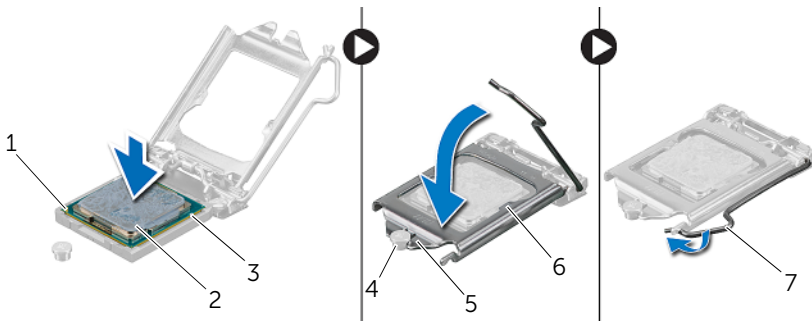

1 processor pin-1 indicator

2 processor

3 alignment tabs (2)

4 alignment post

5 processor-cover notch

6 processor cover

7 release lever

Postrequisites

- 1 Replace the processor fan and heat-sink. See "Replacing the Processor Fan and Heat-Sink" on page 64.
- 2 Replace the computer cover. See "Replacing the Computer Cover" on page 16.

Removing the Coin-Cell Battery

! **WARNING:** Before working inside your computer, read the safety information that shipped with your computer and follow the steps in "Before You Begin" on page 9. After working inside your computer, follow the instructions in "After Working Inside Your Computer" on page 11. For additional safety best practices information, see the Regulatory Compliance Homepage at dell.com/regulatory_compliance.

△ **CAUTION:** Removing the coin-cell battery resets the BIOS settings to default. It is recommended that you note the BIOS settings before removing the coin-cell battery.

Prerequisites

Remove the computer cover. See "Removing the Computer Cover" on page 15.

Procedure

- 1 Locate the battery socket on the system board. See "System-Board Components" on page 13.
- 2 Press the securing clip away from the coin-cell battery until the coin-cell battery pops out.
- 3 Lift the coin-cell battery out of its socket.



1 coin-cell battery

2 securing clip

Replacing the Coin-Cell Battery

 **WARNING:** Before working inside your computer, read the safety information that shipped with your computer and follow the steps in "Before You Begin" on page 9. After working inside your computer, follow the instructions in "After Working Inside Your Computer" on page 11. For additional safety best practices information, see the Regulatory Compliance Homepage at dell.com/regulatory_compliance.

 **WARNING:** The battery may explode if installed incorrectly. Replace the battery only with the same or equivalent type. Discard used batteries according to the manufacturer's instructions.

Procedure

Insert a new coin-cell battery (CR2032) into the battery socket with the positive side facing up, and press the battery into place.

Postrequisites

Replace the computer cover. See "Replacing the Computer Cover" on page 16.

Removing the Power-Supply Unit

⚠ WARNING: Before working inside your computer, read the safety information that shipped with your computer and follow the steps in "Before You Begin" on page 9. After working inside your computer, follow the instructions in "After Working Inside Your Computer" on page 11. For additional safety best practices information, see the Regulatory Compliance Homepage at dell.com/regulatory_compliance.

Prerequisites

Remove the computer cover. See "Removing the Computer Cover" on page 15.

Procedure

- 1 Disconnect the DC power cables from the system board and the drives. See "System-Board Components" on page 13.
- 2 Remove the screws that secure the power-supply unit to the chassis.
- 3 Press the power-supply clamps to release the power-supply unit from the chassis.
- 4 Slide and lift the power-supply unit away from the chassis

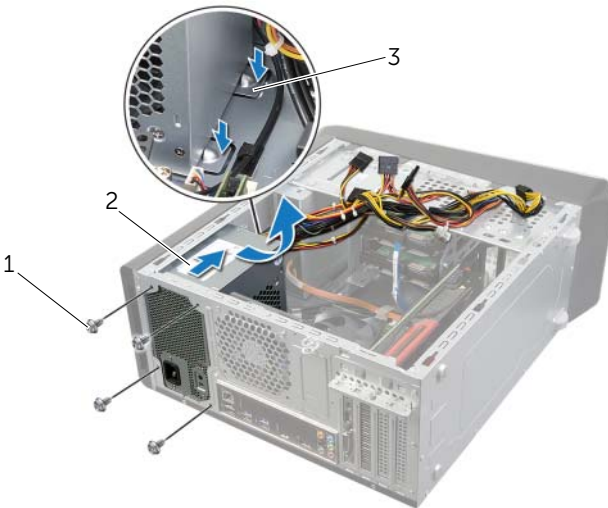

1 screws (4)

2 power supply

3 power-supply clamps (2)

Replacing the Power-Supply Unit



WARNING: Before working inside your computer, read the safety information that shipped with your computer and follow the steps in "Before You Begin" on page 9. After working inside your computer, follow the instructions in "After Working Inside Your Computer" on page 11. For additional safety best practices information, see the Regulatory Compliance Homepage at dell.com/regulatory_compliance.

Procedure

- 1 Slide the power supply towards the back of the chassis.
- 2 Align the screw holes on the power-supply unit with the screw holes on the chassis.
- 3 Replace the screws that secure the power-supply unit to the chassis.
- 4 Connect the DC power cables to the system board and the drives. See "System-Board Components" on page 13.

Postrequisites

Replace the computer cover. See "Replacing the Computer Cover" on page 16.

Removing the System Board





WARNING: Before working inside your computer, read the safety information that shipped with your computer and follow the steps in "Before You Begin" on page 9. After working inside your computer, follow the instructions in "After Working Inside Your Computer" on page 11. For additional safety best practices information, see the Regulatory Compliance Homepage at dell.com/regulatory_compliance.

Prerequisites

- 1 Remove the computer cover. See "Removing the Computer Cover" on page 15.
- 2 Remove the wireless mini-card, if applicable. See "Removing the Wireless Mini-Card" on page 30.
- 3 Remove the memory module(s). See "Removing the Memory Module(s)" on page 17.
- 4 Remove the graphics card. See "Removing the Graphics Card" on page 26.
- 5 Remove the processor fan and heat-sink assembly. See "Removing the Processor Fan and Heat-Sink" on page 62.
- 6 Remove the processor. See "Removing the Processor" on page 65.

Procedure

 **NOTE:** Your computer's service tag is stored in the system board. You must enter the service tag in the BIOS after you replace the system board.

 **NOTE:** Before disconnecting the cables from the system board, note the location of the connectors, so that you can reconnect them correctly after you replace the system board.

- 1 Disconnect all the cables connected to the system board.
- 2 Make note of the cable routing and remove the cables from the routing guides.
- 3 Remove the screws that secure the system board to the chassis.

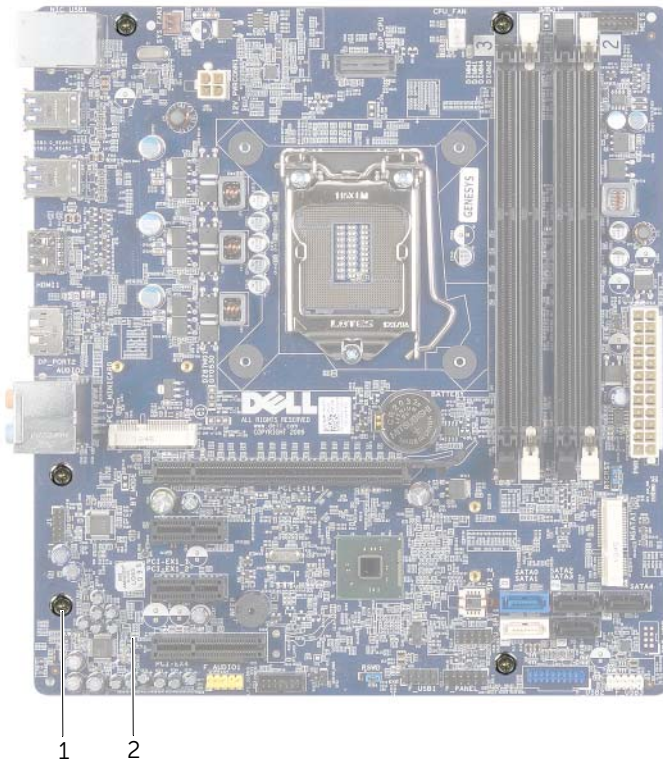

1 screws (5)

2 system board

- 4 Lift the system board up and out of the chassis.

Replacing the System Board



WARNING: Before working inside your computer, read the safety information that shipped with your computer and follow the steps in "Before You Begin" on page 9. After working inside your computer, follow the instructions in "After Working Inside Your Computer" on page 11. For additional safety best practices information, see the Regulatory Compliance Homepage at dell.com/regulatory_compliance.

Procedure

- 1 Gently place the system board into the chassis and slide it towards the back of the computer.
- 2 Replace the screws that secure the system board to the chassis.
- 3 Route and connect the cables that you disconnected from the system board.



NOTE: For information on system board connectors, See "System-Board Components" on page 13.

Postrequisites

- 1 Replace the processor. See "Replacing the Processor" on page 67.
- 2 Replace the processor fan and heat-sink assembly. See "Replacing the Processor Fan and Heat-Sink" on page 64.
- 3 Replace the graphics card. See "Replacing the Graphics Card" on page 29.
- 4 Replace the memory module(s). See "Replacing the Memory Module(s)" on page 18.
- 5 Replace the wireless mini-card, if applicable. See "Replacing the Wireless Mini-Card" on page 32.
- 6 Replace the computer cover. See "Replacing the Computer Cover" on page 16.

Entering the Service Tag in system setup

- 1 Turn on the computer.
- 2 Press <F2> during POST to enter the system setup program.
- 3 Navigate to the Main tab and enter the Service Tag in the Service Tag Input field. See "System Setup" on page 76.

System Setup

Overview

Use system setup to:

- Get information about the hardware installed in your computer, such as the amount of RAM, the size of the hard drive, and so on
- Change the system configuration information
- Set or change a user-selectable option, such as the user password, type of hard drive installed, enabling or disabling base devices, and so on



CAUTION: Unless you are an expert computer user, do not change the settings in the system setup program. Certain changes can make your computer work incorrectly.



NOTE: Before you change system setup, it is recommended that you write down the system setup screen information for future reference.

Entering System Setup

- 1 Turn on (or restart) your computer.
- 2 During POST, when the DELL logo is displayed, watch for the F2 prompt to appear and then press <F2> immediately.



NOTE: The F2 prompt indicates that the keyboard has initialized. This prompt can appear very quickly, so you must watch for it, and then press <F2>. If you press <F2> before the F2 prompt, this keystroke is lost. If you wait too long and the operating system logo appears, continue to wait until you see the operating system's desktop. Then, turn off your computer and try again.

System Setup Screens

The system setup screen displays current or changeable configuration information for your computer. Information on the screen is divided into three areas: the **setup item**, active **help screen**, and **key functions**.

<p>Setup Item — This field appears on the left side of the system setup window. This field is a scrollable list containing features that define the configuration of your computer, including installed hardware, power conservation, and security features.</p> <p>Scroll up and down the list with the up- and down-arrow keys. As an option is highlighted, the Help Screen displays more information about that option and available settings.</p>	<p>Help Screen — This field appears on the right side of the system setup window and contains information about each option listed in the Setup Item. In this field you can view information about your computer and make changes to your current settings.</p> <p>Press the up- and down-arrow keys to highlight an option. Press <Enter> to make that selection active and return to the Setup Item.</p> <p>NOTE: Not all settings listed in the Setup Item are changeable.</p>
<p>Key Functions — This field appears below the Help Screen and lists keys and their functions within the active system setup field.</p>	

System Setup Options



NOTE: Depending on your computer and installed devices, the items listed in this section may appear, or may not appear exactly as listed.

Main→ System Information

BIOS Revision	Display the BIOS revision.
BIOS Build Date	Displays the BIOS release date.
System Name	Displays the system name.
System Time (hh:mm:ss)	Displays the current date.
System Date (mm:dd:yy)	Displays the current time.
Service Tag	Displays the Service Tag of your computer.
Service Tag Input	Allows you to enter the Service Tag of your computer only if the Service Tag is not present.
Asset Tag	Displays the Asset Tag of the computer.

Main→ Processor Information

Processor Type	Displays the processor type.
Processor ID	Displays the processor identification code.
Processor Core Count	Displays the number of processor cores in your computer.
Processor L1 Cache	Displays the processor's total L1 cache size.
Processor L2 Cache	Displays the processor's total L2 cache size.
Processor L3 Cache	Displays the processor's total L3 cache size.

Main→ Memory Information

Memory Installed	Displays the total memory (RAM) installed in your computer.
Memory Available	Displays the amount of memory (RAM) available on your computer.
Memory Running Speed	Displays the running speed of the memory (RAM) in your computer.
Memory Technology	Displays the type of memory (RAM) technology used in your computer.

Main→ SATA Information

SATA 0

Device Type	Displays the type of device connected.
Device ID	Displays the device identification code.
Device Size	Displays the size of the SATA device present in your computer.

SATA 1

Device Type	Displays the type of device connected.
Device ID	Displays the device identification code.
Device Size	Displays the size of the SATA device present in your computer.

SATA 2

Device Type	Displays the type of device connected.
Device ID	Displays the device identification code.
Device Size	Displays the size of the SATA device present in your computer.

SATA 3

Device Type	Displays the type of device connected.
Device ID	Displays the device identification code.
Device Size	Displays the size of the SATA device present in your computer.

mSATA Device

Device Type	Displays the type of device connected.
Device ID	Displays the device identification code.
Device Size	Displays the size of the mSATA device present in your computer.

Advanced → Processor Configuration

Intel(R) Hyper-Threading Technology	If enabled, each physical processor core appears as two logical processor cores.
Intel(R) SpeedStep Technology	If enabled, the processor clock speed and core voltage are adjusted dynamically based on the processor load.
Intel(R) Virtualization Technology	If enabled, a Virtual Machine Monitor (VMM) can access your computer.
CPU XD Support	If enabled, allows your computer to use Executive Display (XD) to hinder software that exploits buffer overflows. NOTE: Windows 8 enables this feature even if this feature is set to disabled.
Limit CPUID Value	If enabled, limits the maximum value the processor CPUID function supports.
Multi Core Support	If enabled, allows your computer to use all cores available in the processor.
Intel(R) Turbo Boost Technology	If enabled, allows your computer to use turbo boost when required.

Advanced → USB Configuration

Front USB Ports	Allows you to enable or disable the USB ports at the front of your computer.
Rear USB Ports	Allows you to enable or disable the USB ports at the back of your computer.
Top USB Ports	Allows you to enable or disable the USB ports at the top of your computer.

Advanced→ Onboard Device Configuration

Onboard Audio Controller	Allows you to enable or disable the onboard audio controller.
SATA Mode	Allows you to configure the integrated hard drive controller to ATA or AHCI.
Onboard LAN Controller	Allows you to enable or disable the onboard LAN controller.
Onboard LAN Boot ROM	Allows you to enable or disable the ROM of the onboard LAN controller.

Boot→ Boot Settings Configuration

Numlock Key	Select power-on state for numlock.
Keyboard Errors	Displays keyboard-related errors during boot.
USB Boot Support	Allows you to enable or disable booting from USB mass-storage devices.
Boot Mode	Allows you to select the type of boot.
Secure Boot Control	Allows you to enable or disable the secure boot control. NOTE: To enable this feature, the computer must be in the UEFI boot mode and the Load Legacy OPROM must be set to never.
Secure Boot Mode	Allows you to select custom (clear secure boot database) or standard (fixed secure boot policy) secure boot mode.

Boot→ Clear Secure Boot Database

Manage All Keys (PK, KEK, db, dbx)	Displays the keys in the database.
Delete All Keys	Allows you to delete all the keys.
Reset All Keys	Allows you to reset all the keys.
Load Legacy OPROM	Allows you to load the legacy OPROM when in the UEFI boot mode.
1st Boot	Displays the first boot device.
2nd Boot	Displays the second boot device.
3rd Boot	Displays the third boot device.
4th Boot	Displays the fourth boot device.
5th Boot	Displays the fifth boot device.

Power

Wake Up by Integrated LAN/WLAN	If enabled, will wake the system using a network message.
AC Recovery	Allows you to select the action the computer takes when power is restored.
DeepSx Power Policies	Allows you to configure the DeepSx mode.
Auto Power On	Allows the computer to start up automatically at a pre-configured time.
Auto Power On Mode	Allows you to set the auto power-on mode.
Auto Power On Date	Allows you to set the auto power-on date.
Auto Power On Time	Allows you to set the auto power-on time.
Intel Smart Connect Technology	Allows you to disable or enable the Intel Smart Connect Technology.

Security

Unlock Setup	If the supervisor password is set, enter the password to display the setup options.
Supervisor Password	Displays the status of the supervisor password.
User Password	Displays the status of the user password.
Set Supervisor Password	Allows you to set a supervisor password.
User Access Level	Allows you to set the user-access level.
Set User Password	Allows you to set a user password.
Password Check	Allows you to configure when the computer prompts for passwords. (When entering system setup or at every boot.)

Security→TPM Security

TPM Security Support	Allows you to enable or disable the TPM (Trusted Platform Module) security.
TPM Status	Allows you to activate or deactivate the TPM security support.
Clear TPM	If enabled, clears the TPM module settings.
TPM ACPI Support	Allows you to enable or disable the TPM ACPI support.
TPM PPI Provision Override	Allows you to enable or disable TPM PPI provision override.

TPM PPI Deprovision Override	Allows you to enable or disable TPM PPI deprovision override.
Exit	
Save Changes and Reset	Allows you to save the changes.
Discard Changes and Reset	Allows you to discard the changes.
Load Default	Allows you to load the default BIOS settings.

Changing Boot Sequence

Changing Boot Sequence for the Current Boot

You can use this feature to change the current boot sequence, for example, to boot from the optical drive to run Dell Diagnostics from the *Drivers and Utilities* disc. The previous boot sequence is restored at the next boot.

- 1 If you are booting from a USB device, connect the USB device to a USB port.
- 2 Turn on (or restart) your computer.
- 3 When **F2 Setup**, **F12 Boot Options** appears in the lower-right corner of the screen, press <F12>.



NOTE: If you wait too long and the operating system logo appears, continue to wait until you see the operating system's desktop. Then shut down your computer and try again.

The **Boot Device Menu** appears, listing all available boot devices.

- 4 On the Boot Device Menu choose the device you want to boot from. For example, if you are booting to a USB memory key, highlight **USB Storage Device** and press <Enter>.

Changing Boot Sequence for Future Boots

- 1 Enter system setup. See "Entering System Setup" on page 76.
 - 2 Use the arrow keys to highlight the **Boot** menu option and press <Enter> to access the menu.
-  **NOTE:** Write down your current boot sequence in case you want to restore it.
- 3 Press the up- and down-arrow keys to move through the list of devices.
 - 4 Press plus (+) or minus (-) to change the boot priority of the device.

Clearing Forgotten Passwords

⚠ WARNING: Before working inside your computer, read the safety information that shipped with your computer and follow the steps in "Before You Begin" on page 9. After working inside your computer, follow the instructions in "After Working Inside Your Computer" on page 11. For additional safety best practices information, see the Regulatory Compliance Homepage at dell.com/regulatory_compliance.

- 1 Remove the computer cover. See "Removing the Computer Cover" on page 15.
- 2 Locate the password jumper (PSWD) on the system board. See "System-Board Components" on page 13.
- 3 Remove the 2-pin jumper plug from pins 2 and 3 and fix it on pins 1 and 2.



- 4 Wait for approximately five seconds to clear the password setting.
- 5 Remove the 2-pin jumper plug from pins 1 and 2 and replace it on pins 2 and 3.
- 6 Replace the computer cover. See "Replacing the Computer Cover" on page 16.

Clearing CMOS Settings

⚠ WARNING: Before working inside your computer, read the safety information that shipped with your computer and follow the steps in "Before You Begin" on page 9. After working inside your computer, follow the instructions in "After Working Inside Your Computer" on page 11. For additional safety best practices information, see the Regulatory Compliance Homepage at dell.com/regulatory_compliance.

- 1 Remove the computer cover. See "Removing the Computer Cover" on page 15.
- 2 Locate the CMOS jumper (RTCRST) on the system board. See "System-Board Components" on page 13.
- 3 Remove the 2-pin jumper plug from pins 2 and 3 and fix it on pins 1 and 2.



- 4 Wait for approximately five seconds to clear the CMOS setting.
- 5 Remove the 2-pin jumper plug from pins 1 and 2 and replace it on pins 2 and 3.
- 6 Replace the computer cover. See "Replacing the Computer Cover" on page 16.

Flashing the BIOS

The BIOS may require flashing when an update is available or when replacing the system board. To flash the BIOS:

- 1 Turn on the computer.
- 2 Go to **dell.com/support**.
- 3 If you have your computer's Service Tag, type your computer's Service Tag and click **Submit**.

If you do not have your computer's Service Tag, click **Detect Service Tag** to allow automatic detection of your computer's Service Tag.



NOTE: If the Service Tag cannot be detected automatically, select your product under the product categories.

- 4 Click **Drivers & Downloads**.
- 5 In the **Operating System** drop-down, select the operating system installed on your computer.
- 6 Click **BIOS**.
- 7 Click **Download File** next to the latest version of the BIOS for your computer.
- 8 On the next page, select **Single-file download** and click **Continue**.
- 9 Save the file and once the download is complete, navigate to the folder where you saved the BIOS update file.
- 10 Double-click the BIOS update file icon and follow the instructions on the screen.

More Information

To learn about Windows 8:

- 1 Turn on the computer.
- 2 Go to **dell.com/support**.
- 3 Type `Windows 8` in the search box and click **Search**.
- 4 Click the links to learn about the Windows 8 features.

To learn about your computer features:

- 1 Follow the instructions from step 1 to step 3 in "Flashing the BIOS" on page 85.
- 2 Click **Manuals & Documentation** tab.
- 3 **View** or **Download** the following documents to learn about your computer features:
 - **Quick Start Guide:** provides information about setting up your computer.
 - **Specifications:** provides information about your computer specifications.
 - **Me and My Dell:** provides information about your computer features.

Free Manuals Download Website

<http://myh66.com>

<http://usermanuals.us>

<http://www.somanuals.com>

<http://www.4manuals.cc>

<http://www.manual-lib.com>

<http://www.404manual.com>

<http://www.luxmanual.com>

<http://aubethermostatmanual.com>

Golf course search by state

<http://golfingnear.com>

Email search by domain

<http://emailbydomain.com>

Auto manuals search

<http://auto.somanuals.com>

TV manuals search

<http://tv.somanuals.com>