

**XPS™ 625
SETUP GUIDE**



XPS™ 625 SETUP GUIDE

Model DCDR01

Notes, Cautions, and Warnings



NOTE: A NOTE indicates important information that helps you make better use of your computer.



CAUTION: A CAUTION indicates either potential damage to hardware or loss of data and tells you how to avoid the problem.



WARNING: A WARNING indicates a potential for property damage, personal injury, or death.

If you purchased a Dell™ n Series computer, any references in this document to Microsoft® Windows® operating systems are not applicable.

Information in this document is subject to change without notice.

© 2008 Dell Inc. All rights reserved.

Reproduction of these materials in any manner whatsoever without the written permission of Dell Inc. is strictly forbidden.

Trademarks used in this text: *Dell*, the *DELL* logo, *YOURS IS HERE*, *XPS*, *Dell On Call*, and *DellConnect* are trademarks of Dell Inc.; *AMD*, *AMD Athlon*, and *AMD Phenom* are trademarks of Advanced Micro Devices, Inc; *Microsoft*, *Windows*, *Windows Vista*, and *Windows Vista Start button logo* are either trademarks or registered trademarks of Microsoft Corporation in the United States and/or other countries.; *Blu-ray Disc* is a trademark of the Blu-ray Disc Association; *Bluetooth* is a registered trademark owned by Bluetooth SIG, Inc. and is used by Dell under license.

Other trademarks and trade names may be used in this document to refer to either the entities claiming the marks and names or their products. Dell Inc. disclaims any proprietary interest in trademarks and trade names other than its own.

December 2008

P/N KW082

Rev. A00

Contents

Setting Up Your XPS™ 625	5	Solving Problems	22
Before Setting Up Your Computer	5	Network Problems	22
Connect the Display	6	Power Problems	23
Connect the Video Cable to the Display	6	Memory Problems	25
Connect the Keyboard and Mouse	8	Lockups and Software Problems	26
Connect the Network Cable (Optional)	8	Using Support Tools	28
Connect the Power Cables for Your Display and Computer	9	Dell Support Center	28
Windows Vista® Setup	10	System Messages	29
Connect to the Internet (Optional)	10	Hardware Troubleshooter	30
Using Your XPS™ 625	14	Dell Diagnostics	31
Front View Features	14	System Recovery Options	33
Back View Features	16	System Restore	33
Back Panel Connectors	18	Dell Factory Image Restore	34
Software Features	20	Operating System Reinstallation	36

Getting Help	38
Technical Support and Customer Service	39
DellConnect™	39
Online Services	39
AutoTech Service.....	40
Product Information.....	41
Returning Items for Repair Under Warranty or for Credit.....	41
Before You Call.....	42
Contacting Dell.....	43
Finding More Information and Resources	44
Specifications	46
Appendix	53
Macrovision Product Notice.....	53
Index	54

Setting Up Your XPS™ 625

This section provides information about setting up your XPS 625 and connecting peripherals.

Before Setting Up Your Computer

When positioning your computer, ensure that you allow easy access to a power source, adequate ventilation, and a level surface to place your computer.

Restricting airflow around your computer may cause it to overheat. To prevent overheating ensure that you leave at least 10.2 cm (4 inches) at the back of the computer and a minimum of 5.1 cm (2 inches) on all other sides. You should never put your computer in an enclosed space, such as a cabinet or drawer when it is powered on.









Connect the Display

Your computer does not have an integrated video connector. You can use the connector available on the video card in the expansion slot to connect to the display.

Connect the Video Cable to the Display

Check your TV or monitor to see which type of connectors are available. Refer to the following table when identifying the connectors on your display to select the connection type you will use.

VGA		
HDMI		
DVI		

Connect the display using either the VGA connector, the HDMI connector, or the DVI connector.

The HDMI connector is a high-performance digital connector that carries both video and audio signals for displays such as TVs and monitors with integrated speakers. The VGA connector carries only video signals for displays such as monitors and projectors.

Connect Using the VGA Connector

Connect the display using a VGA cable (which usually has blue connectors at both ends).

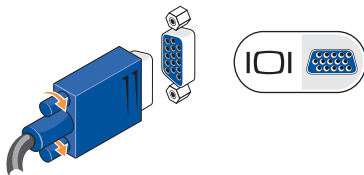

If your display has a DVI connector, use the VGA cable (with blue connectors at both ends) with a DVI-to-VGA adapter.

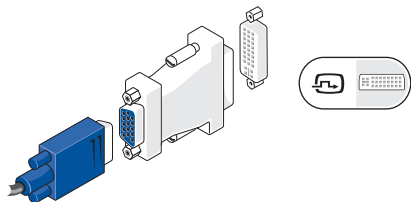

NOTE: You can purchase a DVI-to-VGA adapter from the Dell website at dell.com.

Connect Using an HDMI Connector

Connect the display using an HDMI cable.

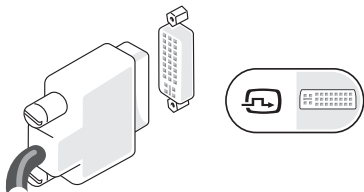

NOTE: You can purchase additional HDMI and DVI cables from the Dell website at dell.com.

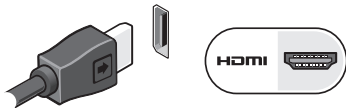

Connect Using a DVI Connector

Connect the display using a DVI cable.

A network connection is not required to complete your computer setup, but if you have an existing network or Internet connection that uses a cable connection (such as a home cable modem or Ethernet jack), you can connect it now. Use only an Ethernet cable (RJ45 connector). Do not plug a telephone cable (RJ11 connector) into the network connector.



To attach your computer to a network or broadband device, connect one end of the network cable to either a network port or a broadband device. Connect the other end of the network cable to the network adapter connector on the back panel of your computer. A click indicates that the network cable has been securely attached.

Connect the Power Cables for Your Display and Computer

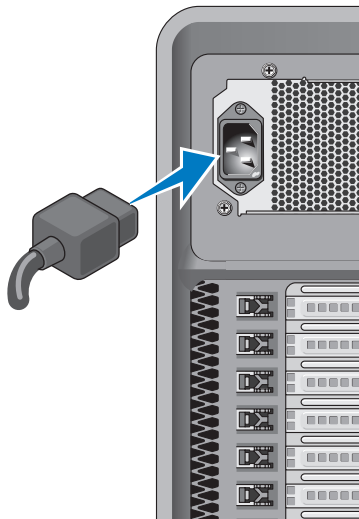

Press the Power Buttons on Your Computer and Display



Windows Vista® Setup

To set up Windows Vista for the first time follow the instructions on the screen. These steps are mandatory and may take up to 15 minutes to complete. The screens will take you through several procedures including accepting license agreements, setting preferences, and setting up an Internet connection.

CAUTION: Do not interrupt the operating system's setup process. Doing so may render your computer unusable.

Connect to the Internet (Optional)

NOTE: ISPs and ISP offerings vary by country.

To connect to the Internet, you need an external modem or network connection and an Internet service provider (ISP). Your ISP will offer one or more of the following Internet connection options:

- DSL connections that provide high-speed Internet access through your existing telephone line or cellular telephone service. With a DSL connection, you can access the Internet and use your telephone on the same line simultaneously.
- Cable modem connections that provide high-speed Internet access through your local cable TV line.
- Satellite modem connections that provide high-speed Internet access through a satellite television system.
- Dial-up connections that provide Internet access through a telephone line. Dial-up connections are considerably slower than DSL and cable (or satellite) modem connections. Your computer does not have an integrated modem. An optional USB modem must be used for dialup service with this computer.
- Wireless LAN (WLAN) connections that provide Internet access using WiFi 802.11 technology. Wireless LAN support requires optional internal components that may or may not be installed in your computer based on decisions made at the time of purchase.



NOTE: If an external USB modem or WLAN adapter is not part of your original order, you can purchase one from the Dell website at **dell.com**.

Setting Up a Wired Internet Connection

If you are using a dial-up connection, connect the telephone line to the external USB modem (optional) and to the telephone wall jack before you set up your Internet connection. If you are using a DSL or cable/satellite modem connection, contact your ISP or cellular telephone service for setup instructions.

Setting Up a Wireless Connection

Before you can use your wireless Internet connection, you need to connect to your wireless router. To set up your connection to a wireless router:

1. Save and close any open files, and exit any open programs.
2. Click **Start**  → **Connect To**.
3. Follow the instructions on the screen to complete the setup.

Setting Up Your Internet Connection

To set up an Internet connection with a provided ISP desktop shortcut:

1. Save and close any open files, and exit any open programs.
2. Double-click the ISP icon on the Microsoft® Windows® desktop.
3. Follow the instructions on the screen to complete the setup.

If you do not have an ISP icon on your desktop or if you want to set up an Internet connection with a different ISP, perform the steps in the following section.

 **NOTE:** If you cannot connect to the Internet but have successfully connected in the past, the ISP might have a service outage. Contact your ISP to check the service status, or try connecting again later.

 **NOTE:** Have your ISP information ready. If you do not have an ISP, the **Connect to the Internet** wizard can help you get one.

1. Save and close any open files, and exit any open programs.
2. Click **Start**  → **Control Panel**.
3. Under **Network and Internet**, click **Connect to the Internet**.

The **Connect to the Internet** window appears.

4. Click either **Broadband (PPPoE)** or **Dial-up**, depending on how you want to connect:

- a. Choose **Broadband** if you will use a DSL, satellite modem, cable TV modem, or Bluetooth® wireless technology connection.
- b. Chose **Dial-up** if you will use an optional USB dial-up modem or ISDN.

 **NOTE:** If you do not know which type of connection to select, click **Help me choose** or contact your ISP.

5. Follow the instructions on the screen and use the setup information provided by your ISP to complete the setup.





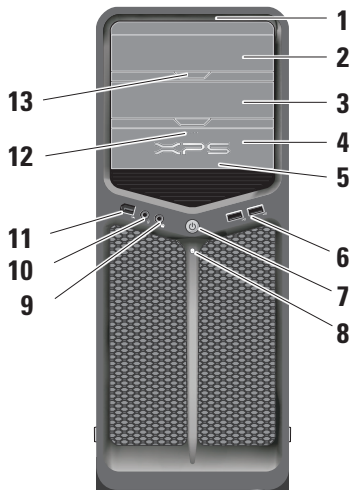

Using Your XPS™ 625

Your computer has indicators, buttons, and features that provide information at-a-glance and time-saving shortcuts for common tasks.

Front View Features

- 1 Front-panel LEDs (3)** — Multi-colored lights provide illumination for the front of the computer.
- 2 Optical drive panel** — This panel covers the optical drive. Use the optical drive to play a CD/DVD/Blu-ray Disc™.
- 3 Optional optical-drive bay** — Supports an optical drive.
- 4 FlexBay drive** — Supports a floppy drive, a Media Card Reader, or an additional hard drive.



- 5 Service Tag (located on a label inside the FlexBay door)** — Use the Service Tag to identify your computer when you access the Dell Support website or call technical support.
- 6  USB 2.0 connectors (2)** — Connects to USB devices that are connected occasionally such as memory keys, digital cameras, and MP3 players.
- 7  Power button** — Turns the power on or off when pressed.
- 8 Power light** — The power light illuminates or remains solid to indicate different states:
- No light — the computer is turned off.
 - Solid white — the computer is in a normal operating state.
 - Blinking white light — the computer is in a power-saving state.
- 9  Line-in or microphone connector** — Connects to a microphone for voice or to an audio cable for audio input.
- 10  Headphone connector** — Connects to headphones.
-  NOTE:** To connect to a powered speaker or sound system, use the audio out or S/PDIF connector on the back of your computer.
- 11  IEEE 1394 connector** — Connects to high-speed serial multimedia devices such as digital video cameras.
- 12 FlexBay drive eject button** — Press to open or close the floppy/media card reader panel.
- 13 Optical drive panel eject button (2)** — Press to open or close the optical drive.



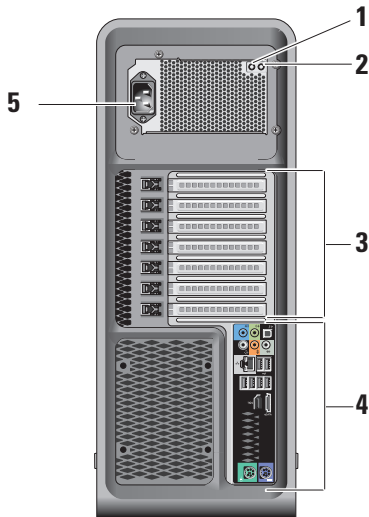

Back View Features



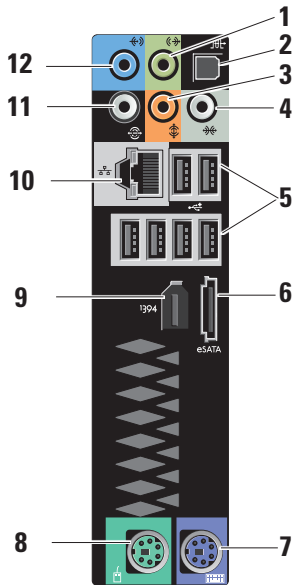





- 1 Power supply test switch** — Used to test the power supply.
- 2 Power supply diagnostic LED** — Indicates power availability for power supply.
 - Green light — Indicates power availability for power supply.
 - No light — Indicates no power available for the power supply or the power supply is not working.
- 3 Expansion card slots** — Access connectors for any installed PCI and PCI express cards.
- 4 Back panel connectors** — Plug USB, audio, and other devices into the appropriate connector.
- 5 Power connector** — Insert the power cable. The appearance of this connector may differ from what is shown in the illustration.

Back Panel Connectors



-  **Front L/R line-out connector** — Connects to headphones and speakers with integrated amplifiers. On computers with a sound card, use the connector on the card.
-  **S/PDIF connector** — Connects to amplifiers or TVs for digital audio through optical digital cables. This format carries an audio signal without going through an analog audio conversion process.
-  **Center/subwoofer connector** — Connects to a subwoofer.
-  **Side L/R surround connector** — Connects to surround sound speakers. On computers with a sound card, use the connector on the card.

- 5  **USB 2.0 connectors (6)** — Connects to USB devices, such as a mouse, keyboard, printer, external drive, or MP3 player.
- 6  **eSATA connector** — Connects to eSATA compatible storage devices (such as external hard disk drives or optical drives).
- 7  **Keyboard connector** — Plug a standard PS/2 keyboard into the purple keyboard connector. Turn off the computer and any attached devices before you connect a keyboard to the computer. If you have a USB keyboard, plug it into a USB connector.
- 8  **Mouse connector** — Plug a standard PS/2 mouse into the green mouse connector. Turn off the computer and any attached devices before you connect a mouse to the computer. If you have a USB mouse, plug it into a USB connector.
- 9  **IEEE 1394 connector** — Connects to high-speed serial multimedia devices such as digital video cameras.
- 10  **Network connector and light** — Connects your computer to a network or broadband device. The network activity light flashes when the computer is transmitting or receiving data. A high volume of network traffic may make this light appear to be in a steady “on” state.
- 11  **Back L/R surround connector** — Connects to multichannel capable speakers.
- 12  **Line-in connector** — Connects to a microphone for voice or audio input into a sound or telephony program. On computers with a sound card, use the connector on the card.

Software Features

 **NOTE:** For more information about the features described in this section, see the *Dell Technology Guide* available on your hard drive or on the Dell Support website at support.dell.com.

Productivity and Communication

You can use your computer to create presentations, brochures, greeting cards, fliers, and spreadsheets. You can also edit and view digital photographs and images. Check your purchase order for software installed on your computer.

After connecting to the Internet, you can access websites, setup an e-mail account, upload and download files, and so on.

Entertainment and Multimedia

You can use your computer to watch videos, play games, create your own CDs, listen to music and radio stations. Your optical disc drive may support multiple disc media formats

including CDs, Blu-ray Discs™ (if the option is selected at the time of purchase), and DVDs.

You can download or copy pictures and video files from portable devices, such as digital cameras and cell phones. Optional software applications enable you to organize and create music and video files that can be recorded to a disc, saved on portable products such as MP3 players and handheld entertainment devices, or played and viewed directly on connected TVs, projectors, and home theater equipment.

Customizing the Desktop

You can customize your desktop to change the appearance, resolution, wallpaper, screensaver, and so on by accessing the **Personalize appearance and sounds** window.

To access the display properties window:

1. Right-click an open area of the desktop.
2. Click **Personalize**, to open the **Personalize appearance and sounds** window and learn more about your customization options.

Customizing Your Energy Settings

You can use the power options in your operating system to configure the power settings on your computer. Microsoft® Windows Vista® provides three default options:

- **Balanced** — This power option offers full performance when you need it and saves power during periods of inactivity.
- **Power saver** — This power option saves power on your computer by reducing system performance to maximize the life of the computer and by reducing the amount of energy consumed by your computer over its lifetime.
- **High performance** — This power option provides the highest level of system performance on your computer by adapting processor speed to your activity and by maximizing system performance.

Backing Up Your Data

It is recommended that you periodically back up files and folders on your computer. To back up files:

1. Click **Start**  → **Control Panel** → **System and Maintenance** → **Welcome Center** → **Transfer files and settings**.
2. Click **Back up files** or **Back up computer**.

Click **Continue** on your **User Account Control** dialog box and follow the instructions in the Back up Files wizard.

Solving Problems

This section provides troubleshooting information for your computer. If you are unable to solve your problem using the following guidelines, see “Using Support Tools” on page 28 or “Contacting Dell” on page 43.

 **WARNING:** Only trained service personnel should remove the computer cover. See the *Service Manual* on the Dell Support website at support.dell.com for advanced service and troubleshooting instructions.

 **WARNING:** Before working inside your computer, read the safety information that shipped with your computer. For additional safety best practice information, see the Regulatory Compliance Homepage at www.dell.com/regulatory_compliance.

Network Problems

Wireless Connections

If the network connection is lost — The wireless router is offline or wireless has been disabled on the computer.

- Check your wireless router to ensure it is powered on and connected to your data source (cable modem or network hub).
- Re-establish your connection to the wireless router:
 - a. Save and close any open files, and exit any open programs.
 - b. Click **Start**  → **Connect To**.
 - c. Follow the instructions on the screen to complete the setup.

Wired Connections

If the network connection is lost — The cable is loose or damaged.

- Check the cable to ensure it is plugged in and not damaged.

The link and activity integrity lights on the integrated network connector let you verify that your connection is working and provide information on the status:

Link integrity light

- Off (no light) — The computer is not detecting a physical connection to the network.
- Green light — A good connection exists between a 10-Mbps network and the computer.
- Orange light — A good connection exists between a 100-Mbps network and the computer.

- Yellow light — A good connection exists between a 1-GB (1000-Mbps) network and the computer.

Activity light

- Yellow blinking light — Indicates activity on the network.
- Off (no light) — Indicates no activity on the network.

 **NOTE:** The link integrity light on the network connector is only for the wired cable connection. The link integrity light does not provide status for wireless connections.

Power Problems

If the power light is off — The computer is either turned off or is not receiving power.

- Reseat the power cable into both the power connector on the computer and the electrical outlet.

Solving Problems

- If the computer is plugged into a power strip, ensure that the power strip is plugged into an electrical outlet and that the power strip is turned on. Also bypass power protection devices, power strips, and power extension cables to verify that the computer turns on properly.
- Ensure that the electrical outlet is working by testing it with another device, such as a lamp.
- Ensure that the power supply light on the back of the system is on. If the light is off there may be a possible problem with the power supply or the power cable.

If the power light is solid white and the computer is not responding — The display may not be connected or powered on. Ensure that the display is properly connected and then turn it off, then back on.

If the power light is blinking white — The computer is in sleep state. Press a key on the keyboard, move the pointer on the trackpad or a connected mouse, or press the power button to resume normal operation.

If you encounter interference that hinders reception on your computer — An unwanted signal is creating interference by interrupting or blocking other signals. Some possible causes of interference are:

- Power, keyboard, and mouse extension cables.
- Too many devices connected to a power strip.
- Multiple power strips connected to the same electrical outlet.

Memory Problems

If you receive an insufficient memory message —

- Save and close any open files and exit any open programs you are not using to see if that resolves the problem.
- See the software documentation for minimum memory requirements. If necessary, install additional memory (see the *Service Manual* on the Dell Support website at **support.dell.com**).
- Reseat the memory modules (see the *Service Manual* on the Dell Support website at **support.dell.com**) to ensure that your computer is successfully communicating with the memory.

If you experience other memory problems —

- Ensure that you are following the memory installation guidelines (see the *Service Manual* on the Dell Support website at **support.dell.com**).
- Check if the memory module is compatible with your computer. Your computer supports DDR2 memory. For more information about the type of memory supported by your computer, see “Specifications” on page 46.
- Run the Dell Diagnostics (see “Dell Diagnostics” on page 31).
- Reseat the memory modules (see the *Service Manual* on the Dell Support website at **support.dell.com**) to ensure that your computer is successfully communicating with the memory.

Lockups and Software Problems

If the computer does not start up — Ensure that the power cable is firmly connected to the computer and to the electrical outlet.

If a program stops responding — End the program:

1. Press <Ctrl><Shift><Esc> simultaneously.
2. Click **Applications**.
3. Click the program that is no longer responding
4. Click **End Task**.

If a program crashes repeatedly — Check the software documentation. If necessary, uninstall and then reinstall the program.

 **NOTE:** Software usually includes installation instructions in its documentation or on CD.

If the computer stops responding —

 **CAUTION:** You might lose data if you are unable to perform an operating system shutdown.

Turn the computer off. If you are unable to get a response by pressing a key on your keyboard or moving your mouse, press and hold the power button for at least 8 to 10 seconds until the computer turns off. Then restart your computer.

If a program is designed for an earlier Microsoft® Windows® operating system —

Run the Program Compatibility Wizard. The Program Compatibility Wizard configures a program so that it runs in an environment similar to non-Windows Vista® operating system environments.

1. Click **Start**  → **Control Panel** → **Programs** → **Use an older program with this version of Windows**.
2. In the welcome screen, click **Next**.
3. Follow the instructions on the screen.

If a solid blue screen appears — Turn the computer off. If you are unable to get a response by pressing a key on your keyboard or moving your pointer or mouse, press and hold the power button for at least 8 to 10 seconds until the computer turns off. Then restart your computer.

If you have other software problems —

- Back up your files immediately.
- Use a virus-scanning program to check the hard drive or CDs.
- Save and close any open files or programs and shut down your computer through the **Start**  menu.
- Check the software documentation or contact the software manufacturer for troubleshooting information:
 - Ensure that the program is compatible with the operating system installed on your computer.
 - Ensure that your computer meets the minimum hardware requirements needed to run the software. See the software documentation for information.
 - Ensure that the program is installed and configured properly.
 - Verify that the device drivers do not conflict with the program.
 - If necessary, uninstall and then reinstall the program.

Using Support Tools

Dell Support Center

The Dell Support Center helps you find the service, support, and system-specific information you need. For more information about Dell Support Center and available support tools, click the **Services** tab at **support.dell.com**.



Click the  icon in the taskbar to run the application. The home page provides links to access:

- Self Help (Troubleshooting, Security, System Performance, Network/Internet, Backup/Recovery, and Windows Vista®)
- Alerts (technical support alerts relevant to your computer)
- Assistance from Dell (Technical Support with DellConnect™, Customer Service, Training

and Tutorials, How-To Help with Dell on Call™, and Online Scan with PCCheckUp)

- About Your System (System Documentation, Warranty Information, System Information, Upgrades & Accessories)

The top of the Dell Support Center home page displays your system's model number along with its Service Tag and Express Service Code.

For more information about the Dell Support Center, see the *Dell Technology Guide* on your hard drive or on the Dell Support website at **support.dell.com**.



WARNING: To guard against the likelihood of electric shock, laceration by moving fan blades or other unexpected injuries, always unplug your computer from the electrical outlet before removing the cover.

System Messages

If your computer has an issue or error, it may display a System Message that will help you identify the cause and action needed to resolve the issue.

 **NOTE:** If the message you received is not listed in the following examples, see the documentation for either the operating system or the program that was running when the message appeared. Alternatively you could see the *Service Manual* on the Dell Support website at support.dell.com or see “Contacting Dell” on page 43 for assistance.

Alert! Previous attempts at booting this system have failed at checkpoint [nnnn]. For help in resolving this problem, please note this checkpoint and contact Dell Technical Support — The computer failed to complete the boot routine three consecutive times for the same error (see “Contacting Dell” on page 43 for assistance).

CMOS checksum error — Possible motherboard failure or RTC battery low. Battery needs replacement. See the *Service Manual* on the Dell Support website at support.dell.com or see “Contacting Dell” on page 43 for assistance.

CPU fan failure — CPU fan has failed. CPU fan needs replacement. See the *Service Manual* on the Dell Support website at support.dell.com.

Hard-disk drive failure — Possible hard disk drive failure during HDD POST (see “Contacting Dell” on page 43 for assistance).

Hard-disk drive read failure — Possible hard disk drive failure during HDD boot test (see “Contacting Dell” on page 43 for assistance).

Keyboard failure — Replace keyboard or check the cable for loose connection.

No boot device available — No bootable partition on hard disk drive, the hard disk drive cable is loose, or no bootable device exists.

Using Support Tools

- If the hard drive is your boot device, ensure that the cables are connected and that the drive is installed properly and partitioned as a boot device.
- Enter system setup and ensure that the boot sequence information is correct (see the *Service Manual* on the Dell Support website at support.dell.com).

No timer tick interrupt — A chip on the system board might be malfunctioning or motherboard failure (see the *Service Manual* on the Dell Support website at support.dell.com or see “Contacting Dell” on page 43 for assistance).

USB over current error — Disconnect the USB device. Your USB device needs more power for it to function properly. Use an external power source to connect the USB device, or if your device has two USB cables, connect both of them.

NOTICE - Hard Drive SELF MONITORING SYSTEM has reported that a parameter has exceeded its normal operating range. Dell

recommends that you back up your data regularly. A parameter out of range may or may not indicate a potential hard drive problem — S.M.A.R.T error, possible hard disk drive failure. This feature can be enabled or disabled in the BIOS setup (see “Contacting Dell” on page 43 for assistance).

Hardware Troubleshooter

If a device is either not detected during the operating system setup or is detected but incorrectly configured, you can use the **Hardware Troubleshooter** to resolve the incompatibility.

To start the Hardware Troubleshooter:

1. Click **Start**  → **Help and Support**.
2. Type `hardware troubleshooter` in the search field and press <Enter> to start the search.
3. In the search results, select the option that best describes the problem and follow the remaining troubleshooting steps.

Dell Diagnostics

If you experience a problem with your computer, perform the checks in “Lockups and Software Problems” on page 26 and run the Dell Diagnostics before you contact Dell for technical assistance.

It is recommended that you print these procedures before you begin.

 **NOTE:** Dell Diagnostics works only on Dell computers.

 **NOTE:** The *Drivers and Utilities* media is optional and may not ship with your computer.

See the System Setup section in the *Service Manual* to review your computer’s configuration information, and ensure that the device that you want to test displays in the system setup program and is active.

Start the Dell Diagnostics from your hard drive or from the *Drivers and Utilities* media.

Starting Dell Diagnostics From Your Hard Drive

The Dell Diagnostics is located on a hidden diagnostic utility partition on your hard drive.

 **NOTE:** If your computer cannot display a screen image, see “Contacting Dell” on page 43.

1. Ensure that the computer is connected to an electrical outlet that is known to be working properly.
2. Turn on (or restart) your computer.
3. When the DELL™ logo appears, press <F12> immediately. Select **Diagnostics** from the boot menu and press <Enter>.

 **NOTE:** If you wait too long and the operating system logo appears, continue to wait until you see the Microsoft® Windows® desktop; then, shut down your computer and try again.

 **NOTE:** If you see a message stating that no diagnostics utility partition has been found, run the Dell Diagnostics from the *Drivers and Utilities* media.

Using Support Tools

4. Press any key to start the Dell Diagnostics from the diagnostics utility partition on your hard drive.

Starting Dell Diagnostics From the Drivers and Utilities Media

1. Insert the *Drivers and Utilities* media.
2. Shut down and restart the computer. When the DELL logo appears, press <F12> immediately.

 **NOTE:** If you wait too long and the operating system logo appears, continue to wait until you see the Microsoft® Windows® desktop; then, shut down your computer and try again.

 **NOTE:** The next steps change the boot sequence for one time only. On the next start-up, the computer boots according to the devices specified in the system setup program.

3. When the boot device list appears, highlight **CD/DVD/CD-RW** and press <Enter>.

4. Select the **Boot from CD-ROM** option from the menu that appears and press <Enter>.

5. Type 1 to start the CD menu and press <Enter> to proceed.

6. Select **Run the 32 Bit Dell Diagnostics** from the numbered list. If multiple versions are listed, select the version appropriate for your computer.

7. When the Dell Diagnostics **Main Menu** appears, select the test you want to run.

System Recovery Options

You can restore your operating system in the following ways:

- System Restore returns your computer to an earlier operating state without affecting data files. Use System Restore as the first solution for restoring your operating system and preserving data files.
- Dell Factory Image Restore returns your hard drive to the operating state it was in when you purchased the computer. This procedure permanently deletes all data on the hard drive and remove any programs installed after you received the computer. Use Dell Factory Image Restore only if System Restore did not resolve your operating system problem.
- If you received an Operating System disc with your computer, you can use it to restore your operating system. However, using the Operating System disc also deletes all data on the hard

drive. Use the disc only if System Restore did not resolve your operating system problem.

System Restore

The Windows operating systems provide a System Restore option which allows you to restore your computer to an earlier operating state (without affecting data files) if changes to the hardware, software, or other system settings have left the computer in an undesirable operating state. Any changes that System Restore makes to your computer are completely reversible.

 **CAUTION:** Make regular backups of your data files. System Restore does not monitor your data files or recover them.

 **NOTE:** The procedures in this document were written for the Windows default view, so they may not apply if you set your Dell™ computer to the Windows Classic view.

Starting System Restore

1. Click **Start**  .
2. In the **Start Search** box, type *System Restore* and press <Enter>.

 **NOTE:** The **User Account Control** window may appear. If you are an administrator on the computer, click **Continue**; otherwise, contact your administrator to continue the desired action.

3. Click **Next** and follow the remaining prompts on the screen.

In the event that System Restore did not resolve the issue, you may undo the last system restore.

Undoing the Last System Restore

 **NOTE:** Before you undo the last system restore, save and close all open files, and exit any open programs. Do not alter, open, or delete any files or programs until the system restoration is complete.

1. Click **Start**  .
2. In the **Start Search** box, type *System Restore* and press <Enter>.
3. Click **Undo my last restoration** and click **Next**.

Dell Factory Image Restore

 **CAUTION:** Using Dell Factory Image Restore permanently deletes all data on the hard drive and removes any programs or drivers installed after you received your computer. If possible, back up the data before using these options. Use Dell Factory Image Restore only if System Restore did not resolve your operating system problem.

 **NOTE:** Dell Factory Image Restore may not be available in certain countries or on certain computers.

Use Dell Factory Image Restore only as the last method to restore your operating system.

These options restore your hard drive to the operating state it was in when you purchased the computer. Any programs or files added since you received your computer—including data files—are permanently deleted from the hard drive. Data files include documents, spreadsheets, e-mail messages, digital photos, music files, and so on. If possible, back up all data before using Factory Image Restore.

Dell Factory Image Restore

1. Turn on the computer. When the Dell logo appears, press <F8> several times to access the **Vista Advanced Boot Options** window.
2. Select **Repair Your Computer**.
3. The **System Recovery Options** window appears.
4. Select a keyboard layout and click **Next**.
5. To access the recovery options, log on as a local user. To access the command prompt, type `administrator` in the **User name** field, then click **OK**.

6. Click **Dell Factory Image Restore**. The **Dell Factory Image Restore** welcome screen appears.

 **NOTE:** Depending upon your configuration, you may need to select **Dell Factory Tools**, then **Dell Factory Image Restore**.

7. Click **Next**. The **Confirm Data Deletion** screen appears.

 **CAUTION:** If you do not want to proceed with Factory Image Restore, click **Cancel**.

8. Click the checkbox to confirm that you want to continue reformatting the hard drive and restoring the system software to the factory condition, then click **Next**.

The restore process begins and may take five or more minutes to complete. A message appears when the operating system and factory-installed applications have been restored to factory condition.

9. Click **Finish** to reboot the system.

Operating System Reinstallation

Before you Begin

If you are considering reinstalling the Microsoft® Windows® operating system to correct a problem with a newly installed driver, first try using Windows Device Driver Rollback. If Device Driver Rollback does not resolve the problem, then use System Restore to return your operating system to the operating state it was in before you installed the new device driver. See “Using Microsoft Windows System Restore” on page 33.

 **CAUTION:** Before performing the installation, back up all data files on your primary hard drive. For conventional hard drive configurations, the primary hard drive is the first drive detected by the computer.

To reinstall Windows, you need the following items:



- *Dell Operating System* media
- *Dell Drivers and Utilities* media

 **NOTE:** The *Dell Drivers and Utilities* media contains drivers that were installed during the assembly of the computer. Use the Dell Drivers and Utilities media to load any required drivers. Depending on the region from which you ordered your computer, or whether you requested the media, the *Dell Drivers and Utilities* media and *Operating System* media may not ship with your computer.

Reinstalling Windows Vista®

The reinstallation process can take 1 to 2 hours to complete. After you reinstall the operating system, you must also reinstall the device drivers, virus protection program, and other software.

1. Save and close any open files and exit any open programs.
2. Insert the *Operating System* disc.
3. Click **Exit** if the **Install Windows** message appears.

4. Restart the computer.
5. When the DELL logo appears, press <F12> immediately.
 -  **NOTE:** If you wait too long and the operating system logo appears, continue to wait until you see the Microsoft® Windows® desktop; then, shut down your computer and try again.
 -  **NOTE:** The next steps change the boot sequence for one time only. On the next start-up, the computer boots according to the devices specified in the system setup program.
6. When the boot device list appears, highlight **CD/DVD/CD-RW Drive** and press <Enter>.
7. Press any key to **Boot from CD-ROM**. Follow the instructions on the screen to complete the installation.

Getting Help

If you experience a problem with your computer, you can complete the following steps to diagnose and troubleshoot the problem:

1. See “Solving Problems” on page 22 for information and procedures that pertain to the problem your computer is experiencing.
2. See “Dell Diagnostics” on page 31 for procedures on how to run Dell Diagnostics.
3. Fill out the “Diagnostic Checklist” on page 42.
4. Use Dell’s extensive suite of online services available at Dell Support (support.dell.com) for help with installation and troubleshooting procedures. See “Online Services” on page 39 for a more extensive list of Dell Support online.
5. If the preceding steps have not resolved the problem, see “Contacting Dell” on page 43.

 **NOTE:** Call Dell Support from a telephone near or at the computer so that the support staff can assist you with any necessary procedures.

 **NOTE:** Dell’s Express Service Code system may not be available in all countries.

When prompted by Dell’s automated telephone system, enter your Express Service Code to route the call directly to the proper support personnel. If you do not have an Express Service Code, open the **Dell Accessories** folder, double-click the **Express Service Code** icon, and follow the directions.

 **NOTE:** Some of the following services are not always available in all locations outside the continental U.S. Call your local Dell representative for information on availability.

Technical Support and Customer Service

Dell's support service is available to answer your questions about Dell hardware. Our support staff uses computer-based diagnostics to provide fast, accurate answers.

To contact Dell's support service, see "Before You Call" on page 42 and then see the contact information for your region or go to **support.dell.com**.

DellConnect™

DellConnect is a simple online access tool that allows a Dell service and support associate to access your computer through a broadband connection, diagnose your problem, and repair it all under your supervision. For more information, go to **support.dell.com** and click **DellConnect**.

Online Services

You can learn about Dell products and services on the following websites:

- **www.dell.com**
- **www.dell.com/ap** (Asian/Pacific countries only)
- **www.dell.com/jp** (Japan only)
- **www.euro.dell.com** (Europe only)
- **www.dell.com/la** (Latin American and Caribbean countries)
- **www.dell.ca** (Canada only)

You can access Dell Support through the following websites and e-mail addresses:

Dell Support websites

- **support.dell.com**
- **support.jp.dell.com** (Japan only)
- **support.euro.dell.com** (Europe only)

Getting Help

Dell Support e-mail addresses

- **mobile_support@us.dell.com**
- **support@us.dell.com**
- **la-techsupport@dell.com** (Latin America and Caribbean countries only)
- **apsupport@dell.com** (Asian/Pacific countries only)

Dell Marketing and Sales e-mail addresses

- **apmarketing@dell.com** (Asian/Pacific countries only)
- **sales_canada@dell.com** (Canada only)

Anonymous file transfer protocol (FTP)

- **ftp.dell.com**

Log in as user: `anonymous`, and use your e-mail address as your password.

AutoTech Service

Dell's automated support service—AutoTech—provides recorded answers to the questions

most frequently asked by Dell customers about their portable and desktop computers.

When you call AutoTech, use your touch-tone telephone to select the subjects that correspond to your questions. For instructions on accessing the telephone number to call your region, see “Contacting Dell” on page 43.

Automated Order-Status Service

To check on the status of any Dell products that you have ordered, you can go to **support.dell.com**, or you can call the automated order-status service. A recording prompts you for the information needed to locate and report on your order. For the telephone number to call your region, see “Contacting Dell” on page 43.

If you have a problem with your order, such as missing parts, wrong parts, or incorrect billing, contact Dell for customer assistance. Have your invoice or packing slip handy when you call. For the telephone number to call for your region, see “Contacting Dell” on page 43.

Product Information

If you need information about additional products available from Dell, or if you would like to place an order, visit the Dell website at **www.dell.com**. For the telephone number to call for your region or to speak to a sales specialist, see “Contacting Dell” on page 43.

Returning Items for Repair Under Warranty or for Credit

Prepare all items being returned, whether for repair or credit, as follows:

1. Call Dell to obtain a Return Material Authorization Number, and write it clearly and prominently on the outside of the box.
2. For the telephone number to call for your region, see “Contacting Dell” on page 43.
3. Include a copy of the invoice and a letter describing the reason for the return.
4. Include a copy of the Diagnostics Checklist (see “Diagnostic Checklist” on page 42), indicating the tests that you have run and any error messages reported by the Dell Diagnostics (see “Dell Diagnostics” on page 31).
5. Include any accessories that belong with the item(s) being returned (power cables, software, guides, and so on) if the return is for credit.
6. Pack the equipment to be returned in the original (or equivalent) packing materials.
7. You are responsible for paying shipping expenses. You are also responsible for insuring any product returned, and you assume the risk of loss during shipment to Dell. Collect On Delivery (C.O.D.) packages are not accepted.
8. Returns that are missing any of the preceding requirements will be refused at Dell’s receiving dock and returned to you.

Before You Call

 **NOTE:** Have your Express Service Code ready when you call. The code helps Dell's automated-support telephone system direct your call more efficiently. You may also be asked for your Service Tag (located on the top of your computer).

Remember to fill out the following Diagnostics Checklist. If possible, turn on your computer before you call Dell for assistance and call from a telephone at or near the computer. You may be asked to type some commands at the keyboard, relay detailed information during operations, or try other troubleshooting steps possible only at the computer itself. Ensure that the computer documentation is available.

Diagnostic Checklist

- Name:
- Date:
- Address:
- Phone number:
- Service Tag (bar code on the back or bottom of the computer):
- Express Service Code:
- Return Material Authorization Number (if provided by Dell support technician):
- Operating system and version:
- Devices:
- Expansion cards:
 - Are you connected to a network? Yes /No
 - Network, version, and network adapter:
 - Programs and versions:

See your operating system documentation to determine the contents of the computer's start-up files. If the computer is connected to

a printer, print each file. Otherwise, record the contents of each file before calling Dell.

- Error message, beep code, or diagnostic code:
- Description of problem and troubleshooting procedures you performed:

Contacting Dell

For customers in the United States, call 800-WWW-DELL (800-999-3355).



NOTE: If you do not have an active Internet connection, you can find contact information on your purchase invoice, packing slip, bill, or Dell product catalog.

Dell provides several online and telephone-based support and service options. Availability varies by country and product, and some services may not be available in your area.

To contact Dell for sales, technical support, or customer service issues:

1. Visit **support.dell.com**.
2. Verify your country or region in the **Choose A Country/Region** drop-down menu at the bottom of the page.
3. Click **Contact Us** on the left side of the page.
4. Select the appropriate service or support link based on your need.
5. Choose the method of contacting Dell that is convenient for you.

Finding More Information and Resources

If you need to:

See:

reinstall your operating system.

your *Operating System* disc.

find your system model number.

the back of your computer.

run a diagnostic program for your computer, reinstall desktop system software, or update drivers for your computer, and readme files.

the *Drivers and Utilities* disc.



NOTE: Drivers and documentation updates can be found on the Dell™ Support website at **support.dell.com**.

learn more about your operating system, maintaining peripherals, RAID, Internet, Bluetooth®, networking, and e-mail.

the *Dell Technology Guide* available on your hard drive.

upgrade your computer with new or additional memory, or a new hard drive.

the *Service Manual* on the Dell Support website at **support.dell.com**.

reinstall or replace a worn or defective part.



NOTE: In some countries, opening and replacing parts of your computer may void your warranty. Check your warranty and return policies before working inside your computer.

If you need to:

find safety best practices information for your computer.

review Warranty information, Terms and Conditions (U.S. only), Safety instructions, Regulatory information, Ergonomics information, and End User License Agreement.

find your Service Tag/Express Service Code— You must use the Service Tag to identify your computer on **support.dell.com** or to contact technical support.

find drivers and downloads.

access technical support and product help.

check on your order status for new purchases.

find solutions and answers to common questions.

locate information for last-minute updates about technical changes to your computer or advanced technical-reference material for technicians or experienced users.

See:

Before working inside your computer, read the safety information that shipped with your computer. For additional safety best practices information, see the Regulatory Compliance Homepage at **www.dell.com/regulatory_compliance**.

the top of your computer.



the Dell Support website at **support.dell.com**.

Specifications

Computer Model

Dell™ XPS™ 625

This section provides information that you may need when setting up, updating drivers for, and upgrading your computer.

 **NOTE:** Offerings may vary by region. For more information regarding the configuration of your computer, click **Start**  → **Help and Support** and select the option to view information about your computer.

Processor

Type	AMD Athlon™ X2 Black AMD Phenom™ X3 Black AMD Phenom X4 Black AMD Phenom II X4 Black
L1 cache	2x64 KB
L2 cache	512 KB
L3 cache (Phenom and Phenom II only)	up to 2 MB

Drives

Externally accessible	two 5.25-inch drive bays for SATA DVD+/-RW Super Multi Drive or Blu-ray Disc™ combo or Blu-ray Disc RW optical drive one 3.5 inch bay for a FlexBay drive
Internally accessible	four 3.5-inch drive bays for SATA hard drives

Memory

Connectors	four internally-accessible DDR2 DIMM sockets
Capacities	1 GB and 2 GB

Memory

Memory type	800-MHz DDR2 DIMM; non-ECC memory only
Minimum	2 GB (2x1 GB DIMMs)
Maximum	8 GB (4x2 GB DIMMs)

 **NOTE:** For instructions on upgrading your memory, see the *Service Manual* on the Dell Support website at support.dell.com.

Computer Information

System chipset	AMD 790X
Data bus width	64-bit
DRAM bus width	128-bit across 2 DIMMs
Processor address bus width	40-bit physical, 48-bit virtual

Specifications

Computer Information

RAID support (internal SATA drives only)	RAID 0 (striped array) RAID 1 (mirrored array) RAID 5 (striped array with parity) RAID 10 (striped array of mirrored volumes)
BIOS chip (NVRAM)	16 Mb

Expansion Bus

PCI Express	<ul style="list-style-type: none">• Gen2 x1 slot bi-directional speed - 500 MB/s• Gen2 x8 slot bi-directional speed - 2 GB/s• Gen2 x16 slot bi-directional speed - 4 GB/s
-------------	---

Expansion Bus

PCI	32-bit speed - 33 MHz
SATA 2.0	1.5 Gbps and 3.0 Gbps
USB 2.0	480 Mbps high speed, 12 Mbps full speed, and 1.2 Mbps low speed

Expansion Slots

PCI Express x1	
Connectors	one
Connector size	36-pin connector
Connector data width (maximum)	1 PCI Express lane

Expansion Bus

 PCI Express x8 (electrically configured for x4)

Connectors	one
Connector size	98-pin connector
Connector data width (maximum)	4 PCI Express lanes

PCI Express x16 (electrically configured for x8)

Connectors	two
Connector size	164-pin connectors
Connector data width (maximum)	8 PCI Express lanes

Video

 Discrete PCI Express x16 card
Audio

Type	Realtek ALC888S integrated 7.1 channel, High Definition Audio with S/PDIF support
------	---

System Board Connectors

Memory	four 240-pin connectors
PCI	two 124-pin connectors
PCI Express x1	one 36-pin connector
PCI Express x8	one 98-pin connector
PCI Express x16	two 164-pin connectors
Power (System board)	one 24-pin EPS12V connector (ATX-compatible)
Power (Processor)	one 8-pin EPS12V connector

Specifications

System Board Connectors

Processor	one AM2/AM2+ connector
Processor fan	one 4-pin (12V, PWM and tachometer) connector
Chipset fan	one 4-pin (12V, PWM and tachometer) connector
LCS fan	one 4-pin (12V, PWM and tachometer) connector
Reserved fan	one 4-pin (12V, PWM and tachometer) connector
Front USB header	one 9-pin connector, supports two USB ports
Master I/O board USB header	one 9-pin connector, supports one USB port

System Board Connectors

Flexbay USB connector	one 9-pin connector, supports two USB ports
Front audio connector	one 9-pin connector, for 2-channel stereo sound and microphone
IDE	one 44-pin ATA-66/100/133 connector
Serial ATA	five 7-pin connectors
Floppy drive	one 34-pin connector
S/PDIF out	5-pin header
Front IEEE 1394 header	9-pin header

Physical

Height	48.8 cm (19.2 inches)
Width	19.5 cm (7.7 inches)
Depth	56 cm (22 inches)
Weight	starting at 17.7 kg (39 lb)

External connectors

Network adapter	RJ45 connector
USB	two front-panel and six back-panel USB 2.0-compliant connectors
Audio	five connectors for 5.1 support and one connector for line input
S/PDIF	one S/PDIF connector
eSATA	one back-panel connector

External connectors

IEEE 1394	one front-panel and one back-panel 4-pin serial connector
-----------	---

Power

DC Power Supply

Wattage	750 W
Maximum heat dissipation	2559.1 BTU/hr

 **NOTE:** Heat dissipation is calculated by using the power supply wattage rating.

Voltage	115/230 V ac. 50/60 Hz, 10.0 A/5.0 A
Coin-cell battery	3-V CR2032 lithium coin cell

Specifications

Computer Environment

Temperature ranges:

Operating 10° to 35° C (50° to 95° F)

Storage -40° to 65° C (-40° to 149° F)

Relative humidity: 20% to 80% (non condensing)

Maximum vibration (using a random-vibration spectrum that simulates user environment):

Operating 5 to 350 Hz at 0.0002 G2/Hz

Storage 5 to 500 Hz at 0.001 to 0.01 G2/Hz

Maximum shock (measured with hard drive in head-parked position and a 2-ms half-sine pulse):

Operating 40 G +/- 5% with pulse duration of 2 msec +/- 10% (equivalent to 20 inches/ sec [51 cm/sec])

Computer Environment

Storage 105 G +/- 5% with pulse duration of 2 msec +/- 10% (equivalent to 50 inches/ sec [127 cm/sec])

Altitude (maximum):

Operating -15.2 to 3048 m (-50 to 10,000 ft)

Storage -15.2 to 10,668 m (-50 to 35,000 ft)

Airborne G2 or lower as defined by contaminant level ISA-S71.04-1985

Appendix

Macrovision Product Notice

This product incorporates copyright protection technology that is protected by method claims of certain U.S. patents and other intellectual property rights owned by Macrovision Corporation and other rights owners. Use of this copyright protection technology must be authorized by Macrovision Corporation, and is intended for home and other limited viewing uses only unless otherwise authorized by Macrovision Corporation. Reverse engineering or disassembly is prohibited.

Index

A

AutoTech **40**

B

backups
 creating **21**

C

calling Dell **42**
CDs, playing and creating **20**
chipset **47**
computer capabilities **20**
connect(ing)
 displays **6**
 optional network cable **8**
 to the Internet **10**
 using dial-up **11**

conserving energy **21**
Contacting Dell online **43**
customer service **39**
customizing
 your desktop **20**
 your energy settings **21**

D

data, backing up **21**
DellConnect **39**
Dell Diagnostics **31**
Dell Factory Image Restore **33**
Dell Support Center **28**
Dell support website **45**
Dell Technology Guide
 for further information **44**

Diagnostic Checklist **42**
drivers and downloads **45**
DVDs, playing and creating **20**

E

email addresses
 for technical support **40**
energy
 conserving **21**
expansion bus **48**

F

finding more information **44**
front-side connectors **14**
FTP login, anonymous **40**

H

hard drive
 type **47**

hardware problems
 diagnosing **30**
Hardware Troubleshooter **30**

HDMI

display **6**

headphone

front connector **15**

help

getting assistance and support **38**

I

IEEE 1394 connector **15, 19**

Internet connection **10**

ISP

Internet Service Provider **10**

L

line-in connector **15**

M

- memory problems
 - solving **25**
- memory support **47**
- microphone connector **15**

N

- network connection
 - fixing **23**
- network connector
 - location **19**
- network speed
 - testing **22**

O

- optical audio connector
 - S/PDIF connection **18**
- order status **40**

P

- power button and light **15**
- power problems, solving **23**
- problems, solving **22**
- processor **46**
- products
 - information and purchasing **41**

R

- reinstalling Windows **33**
- resources, finding more **44**
- restoring factory image **34**

S

- shipping products
 - for return or repair **41**
- software features **20**
- software problems **26**
- solving problems **22**

S/PDIF connector **18**
specifications **46**
support email addresses **40**
support sites
 worldwide **39**
system board connectors **49**
System Messages **29**
system reinstall options **33**
System Restore **33**

T

technical support **39**
temperature
 operating and storage ranges **52**

U

USB 2.0
 back connectors **19**
 front connectors **15**

W

warranty returns **41**
Windows, reinstalling **33**
Windows Vista®
 Program Compatibility Wizard **26**
 reinstalling **36**
 setup **10**
wireless network connection **22**



Printed in the U.S.A.

www.dell.com | support.dell.com



OKW082A00

Free Manuals Download Website

<http://myh66.com>

<http://usermanuals.us>

<http://www.somanuals.com>

<http://www.4manuals.cc>

<http://www.manual-lib.com>

<http://www.404manual.com>

<http://www.luxmanual.com>

<http://aubethermostatmanual.com>

Golf course search by state

<http://golfingnear.com>

Email search by domain

<http://emailbydomain.com>

Auto manuals search

<http://auto.somanuals.com>

TV manuals search

<http://tv.somanuals.com>