

1x9 Bi-Directional Transceiver Module for Fast Ethernet, ATM, SONET OC-3/SDH STM-1



FEATURES

- RoHS compliant
- Industry Standard 1 x 9 Footprint
- Single Mode Fiber, Bi-Directional Transmission with 1310nm Transmitter and 1550nm Receiver
- Link Distance up to 15km
- Single +5V power supply and PECL logic interface
- Wave Solderable and Aqueous Washable
- Bellcore GR-468 compliant
- Laser Class 1 Product which comply with the requirements of IEC 60825-1 and IEC 60825-2

Description

DELTA's 1x9 Bi-Directional transceiver is designed for point-to-point Bi-Directional Optical Network transmission. The module consists 1310nm FP laser, InGaAs PIN, Preamplifier and WDM filter in a high-integrated optical sub-assembly, and it receives up to 155Mbps of continuous data at 1550nm, and transmits 155Mbps of continuous data at 1310nm.

The module is contained in a 1x9 industry standard package with a SC receptacle connector, and support PECL electrical signal Interface and receiver signal detect output.

Application

- TTC TS-1000
- ITU-T G.985
- IEEE 802.3ah 100BASE-BX/ Fast Ethernet
- SONET OC-3/SDH STM-1/ ATM Network
- FTTx Broadband Access System

Performance

- OPBD-E1J1R data link up to 15km in 9/125um single mode fiber.

1. Absolute Maximum Ratings

Parameter	Symbol	Min.	Typ.	Max.	Unit	Note
Storage Temperature	T _s	-40		85	°C	
Operating Ambient Temperature	T _a	-10		80	°C	
Storage Ambient Humidity	HA	5		95	%	
Power Supply Voltage	V _{CC}	-0.5		6	V	
Signal Input Voltage		-0.3		V _{CC} +0.3	V	
Optical Input Power (Peak)				0	dBm	
Lead Soldering Temperature	T _{SOLD}			260	°C	
Lead Soldering Time	t _{SOLD}			10	sec	

2. Recommended Operating Conditions

Parameter	Symbol	Min.	Typ.	Max.	Unit	Note
Ambient Operating Temperature	T _A	0		70	°C	Without air flow
Ambient Humidity	HA	5		85	%	Non-condensing
Power Supply Voltage	V _{CC}	4.75	5	5.25	V	
Power Supply Current	I _{CC}			250	mA	
Power Supply Noise Rejection				100	mVp-p	100Hz to 1MHz
Data Rate		10		155.52	Mbps	
Transmission Distance				15	km	

3. Optical Specification of Transmitter

Parameter	Symbol	Min.	Typ.	Max.	Unit	Note
Average Launched Power	P _O	-14	-11	-8	dBm	Note (1)
Launched power (Peak.)				-5	dBm	
Extinction Ratio	ER	8.5			dB	
Center Wavelength	λ _c	1260	1310	1360	nm	FP Laser
Spectrum Width (RMS)	σ			6	nm	
Optical Rise/Fall Time	t _r /t _f			1.3	ns	Note (2)
Total Jitter	t _J			1	ns	Note (3)
Optical Return Loss Tolerance	ORLT			14	dB	
Relative Intensity Noise	RIN			-116	dB/Hz	
Output Eye Mask	Compliant with Bellcore TR-NWT-000253 and ITU recommendation G.957					Note (4)

Note (1). Launched power (avg.) is power coupled into a single mode fiber.

Note (2). These are unfiltered 20-80% values.

Note (3). Measure at 2²³-1 NRZ PRBS pattern

Note (4). Eye Mask definition

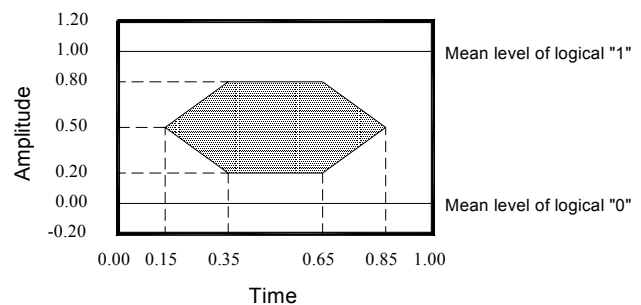

Optical Pulse Mask with Bessel Filter Specified in ITU-T G.957

4. Optical Specification of Receiver

Parameter	Symbol	Min.	Typ.	Max.	Unit	Note
Input Optical Wavelength	λ_{IN}	1480		1600	nm	PIN-PD
Receiver Sensitivity	P_{IN}			-30	dBm	Note (1)
Input Saturation Power (Overload)	P_{SAT}	-3			dBm	
Signal Detect -Assert Power	P_A	-		-30	dBm	
Signal Detect -Deassert Power	P_D	-44			dBm	Note (2)
Signal Detect Hysteresis	P_A-P_D	0.5	2.5	6	dB	
Optical Receiver Reflectance				-14	dB	Note (3)
Output Data Rise/Fall time	t_r/t_f			1.5	ns	Note (4)
S/X Endurance				10	dB	Note (5)
Optical Isolation		25			dB	Note (6)

Note (1). Measured with 1520nm, ER=10dB; BER =10^{-10}@PRBS=2²³-1 NRZ

Note (2). When SD deasserted, the data output is Low-level (fixed)

Note (3). When the terminal is viewed from the optical path, the reflection toward the optical path of the optical signal with a central wavelength of 1480nm to 1580nm transmitted to terminal.

Note (4). These are 20%~80% values

Note (5). X=10 MHz, Rectangular BER =10⁻¹⁰

Note (6). Receiver isolation between 1260nm ~1360nm

5. Electrical Interface Characteristics

Parameter	Symbol	Min.	Typ.	Max.	Unit	Note
Transmitter						
Total Supply Current	I_{CC}			A	mA	Note (1)
Differential line input Impedance	R_{IN}	80	100	120	Ohm	
Differential Data Input Swing	VDT	300		1600	mV _{p-p}	
Data Input Voltage- High	$V_{IH}-V_{CC}$	-1.165		-0.880	V	PECL
Data Input Voltage- Low	$V_{IL}-V_{CC}$	-1.810		-1.475	V	
Receiver						
Total Supply Current	I_{CC}			B	mA	Note (1)
Differential Data Output Swing	VDR	400		2000	mV _{p-p}	
Data Output Voltage-High	$V_{OH}-V_{CC}$	-1.085		-0.880	V	PECL
Data Output Voltage-Low	$V_{OL}-V_{CC}$	-1.830		-1.555	V	
Signal Detect Output Voltage-High	$V_{OH}-V_{CC}$	-1.085		-0.880	V	
Signal Detect Output Voltage-Low	$V_{OL}-V_{CC}$	-1.830		-1.555	V	

Note (1). A (TX)+ B (RX) = 250mA

(A: Not include termination circuit; B: using a resistor of 270Ω between Data-output and ground)

6. Pin Description

Tx/Rx	Pin No.	I/O	Pin Name	Description
Rx	1		VeeR	Receiver Ground
	2	O	RD(n)	Inverted Receiver Data Output
	3	O	RD(p)	Non-Inverted Receiver Data Output
	4	O	SD	Normal Optical Input indicated by logic "High", and No Optical Input indicated by logic "Low".
	5		VccR	+5V Receiver Power Supply
Tx	6		VccT	+5V Transmitter Power Supply
	7	I	TD(p)	Non-Inverted Transmitter Data Input
	8	I	TD(n)	Inverted Transmitter Data Input
	9		VeeT	Transmitter Ground
			MS	Mounting studs/ connect this pin to Chassis ground

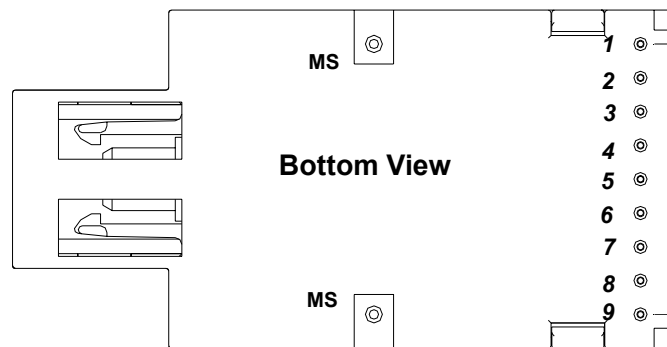

7. Recommended Interface Circuit (AC Coupling)

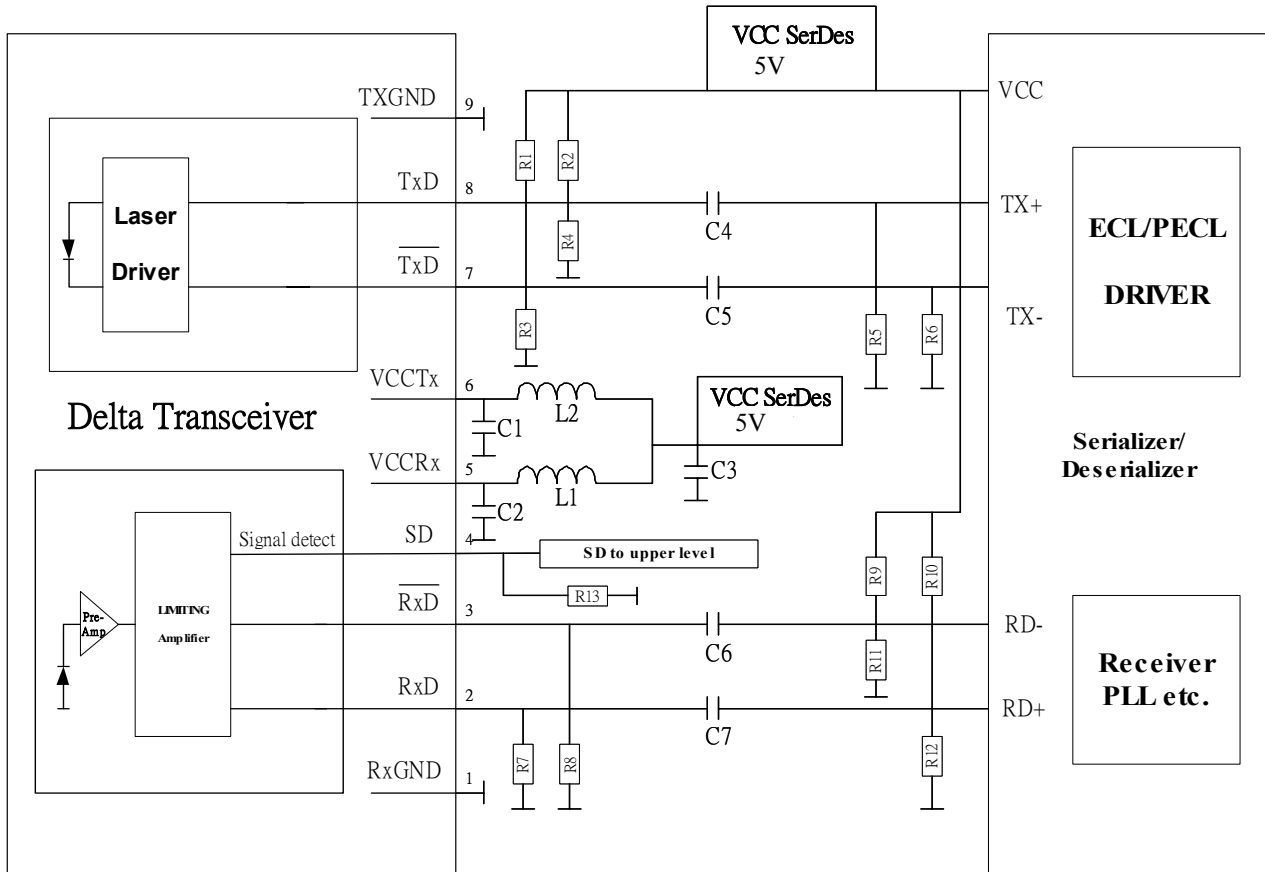

C1/2/3 = 4.7 uF

C4/5/6/7 = 100 nF

L1/2 = 1 uH

R1/2 = 68 Ω (If C4/5=0, then R1/2 = 82 Ω , it is for DC-coupled.)

R3/4 = 180 Ω (If C4/5=0, then R3/4 = 130 Ω , it is for DC-coupled.)

R7/8 = 270 Ω

WR5/6/9/10/11/12 Depend on SerDes chip used

R13 = 510 Ω

Value of R5/6/9/10/11/12 may vary as long as proper 50 Ω termination or differential 100 Ω is provided. For good EMI performance, the power supply filter is required. Use shorter tracks from the inductor L1/2 to the module VccTx/VccRx .

8. Outline Dimensions

Parameter	Unit	Description	Note
Mechanical Dimensions	mm	50.4x25.4x10.8	
Connector Type	-	SC Receptacle Connector	IEC-61754-4

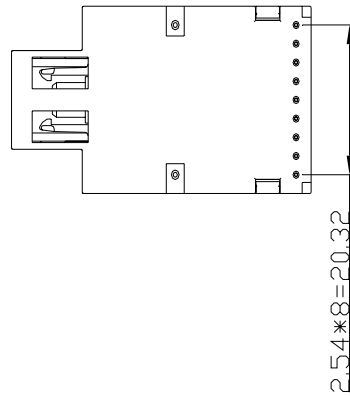
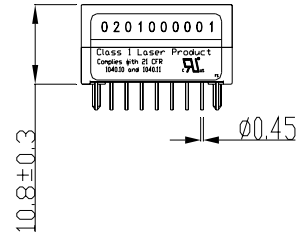
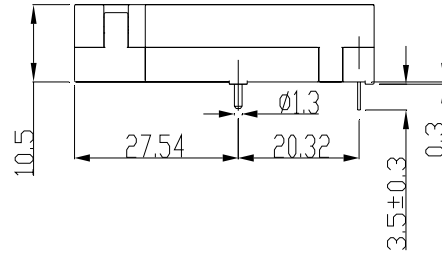
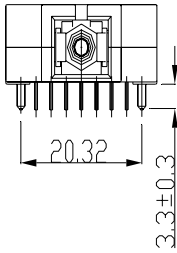
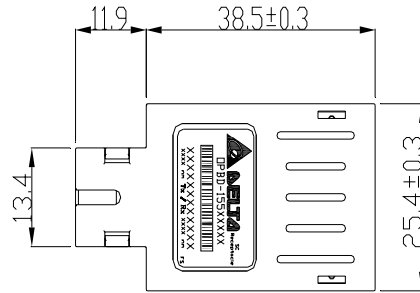

NOTE:
 1.Units in mm
 2.Dimensional tolerances ±0.2mm

S/N

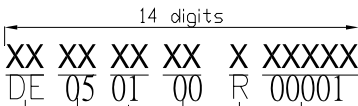

S/N :(00001~99999)
 Rework : Rework=R or No-rework=0
 Vender NOTE : Free or 00
 Week (52Weeks/Year) : 1月2日=01
 Year : 2005=05
 Vender CODE : DELTA=DE

9. Regulatory Compliance

Feature	Test Method	Reference	Performance
Electrostatic Discharge (ESD) to the Electrical Pins	Human Body Model (HBM)	MIL-STD-883E Method 3015.7 EIA-JESD22-A114	(1) Satisfied with electrical characteristics of product spec. (2) No physical damage
	Machine Model (MM)	EIA-JESD22-A115	
Electrostatic Discharge (ESD) to the Simplex Receptacle	Contact Discharge	IEC/EN 61000-4-2	
	Air Discharge	IEC/EN 61000-4-2	
Radio Frequency Electromagnetic Field Immunity		IEC/EN 61000-4-3	
Electromagnetic Interference (EMI)		FCC Part 15 Class B EN 55022 Class B (CISPR 22A)	
Laser Eye Safety	FDA/CDRH	FDA 21CFR 1040.10, 1040.11	CDRH File # 0420993
	TUV	IEC/EN 60825-1 IEC/EN 60825-2	TUV Certificate # R50032471
Component Recognition	TUV	IEC/EN 60950	
	UL/CSA	UL 60950	UL File # E239394

Appendix B. Document Revision

Version No.	Date	Description
S0	2006-07-20	Preliminary datasheet
S1	2006-09-12	Add barcode on product label
S2	2007-03-09	Change the module height from 9.7±0.3mm to 10.8±0.3mm

Free Manuals Download Website

<http://myh66.com>

<http://usermanuals.us>

<http://www.somanuals.com>

<http://www.4manuals.cc>

<http://www.manual-lib.com>

<http://www.404manual.com>

<http://www.luxmanual.com>

<http://aubethermostatmanual.com>

Golf course search by state

<http://golfingnear.com>

Email search by domain

<http://emailbydomain.com>

Auto manuals search

<http://auto.somanuals.com>

TV manuals search

<http://tv.somanuals.com>