

DENON

DVD AUDIO-VIDEO/SUPER AUDIO CD PLAYER

DVD-A1XV

OPERATING INSTRUCTIONS

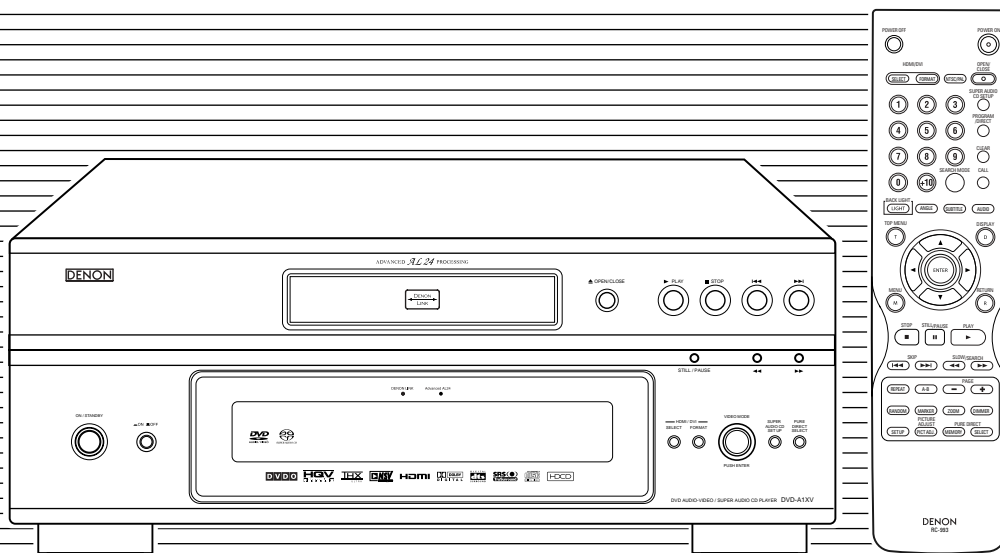

IMPORTANT TO SAFETY

WARNING:

TO PREVENT FIRE OR SHOCK HAZARD, DO NOT EXPOSE THIS APPLIANCE TO RAIN OR MOISTURE.

CAUTION:

1. Handle the power supply cord carefully

Do not damage or deform the power supply cord. If it is damaged or deformed, it may cause electric shock or malfunction when used. When removing from wall outlet, be sure to remove by holding the plug attachment and not by pulling the cord.

2. Do not open the top cover

In order to prevent electric shock, do not open the top cover. If problems occur, contact your DENON DEALER.

3. Do not place anything inside

Do not place metal objects or spill liquid inside the DVD audio-video/Super audio CD player. Electric shock or malfunction may result.

Please, record and retain the Model name and serial number of your set shown on the rating label.

Model No. DVD-A1XV Serial No. _____



CAUTION:

TO REDUCE THE RISK OF ELECTRIC SHOCK, DO NOT REMOVE COVER (OR BACK). NO USER SERVICEABLE PARTS INSIDE. REFER SERVICING TO QUALIFIED SERVICE PERSONNEL.



The lightning flash with arrowhead symbol, within an equilateral triangle, is intended to alert the user to the presence of uninsulated "dangerous voltage" within the product's enclosure that may be of sufficient magnitude to constitute a risk of electric shock to persons.



The exclamation point within an equilateral triangle is intended to alert the user to the presence of important operating and maintenance (servicing) instructions in the literature accompanying the appliance.

NOTE:

This DVD audio-video/Super audio CD player uses the semiconductor laser. To allow you to enjoy music at a stable operation, it is recommended to use this in a room of 5 °C (41 °F) ~ 35 °C (95 °F).

CAUTION:

USE OF CONTROLS OR ADJUSTMENTS OR REFORMATION OF PROCEDURES OTHER THAN THOSE SPECIFIED HEREIN MAY RESULT IN HAZARDOUS RADIATION EXPOSURE.

THE COMPACT DISC PLAYER SHOULD NOT BE ADJUSTED OR REPAIRED BY ANYONE EXCEPT PROPERLY QUALIFIED SERVICE PERSONNEL.

• Copyrights

It is prohibited by law to reproduce, broadcast, rent or play discs in public without the consent of the copyright holder.

• Urheberrechte

Die Reproduktion, Ausstrahlung, der Verleih sowie die öffentliche Wiedergabe von Discs erfordern die Zustimmung des Urheberrechtinhabers.

• Droits d'auteur

La reproduction, la diffusion, la location, le prêt ou la lecture publique de ces disques sont interdits sans le consentement du détenteur des droits d'auteur.

• Copyright

La duplicazione, la trasmissione, il noleggio e la riproduzione dei dischi in pubblico senza l'autorizzazione scritta del titolare dei diritti di copyright sono vietati dalla legge.

• Derechos de Autor

De acuerdo con las leyes está prohibido reproducir, emitir, alquilar o interpretar discos en público sin la autorización del propietario de los derechos de autor.

• Auteursrechten

Het zonder toestemming van de auteursrechthebbenden reproduceren, uitzenden, verhuren of in het openbaar afspelen van discs is wettelijk verboden.

• Upphovsrätt

Enligt lagen är det förbjudet att återge, utsända, hyra ut eller spela skivor för allmän publik med mindre tillstånd från ägaren till upphovsrätten först har inhämtats.

A NOTE ABOUT RECYCLING:

This product's packaging materials are recyclable and can be reused. Please dispose of any materials in accordance with the local recycling regulations.

When discarding the unit, comply with local rules or regulations.

Batteries should never be thrown away or incinerated but disposed of in accordance with the local regulations concerning chemical waste.

This product and the accessories packed together constitute the applicable product according to the WEEE directive except batteries.



• DECLARATION OF CONFORMITY

We declare under our sole responsibility that this product, to which this declaration relates, is in conformity with the following standards: EN60065, EN55013, EN55020, EN61000-3-2 and EN61000-3-3. Following the provisions of 73/23/EEC, 89/336/EEC and 93/68/EEC Directive.

• ÜBEREINSTIMMUNGSERKLÄRUNG

Wir erklären unter unserer Verantwortung, daß dieses Produkt, auf das sich diese Erklärung bezieht, den folgenden Standards entspricht: EN60065, EN55013, EN55020, EN61000-3-2 und EN61000-3-3. Entspricht den Verordnungen der Direktive 73/23/EEC, 89/336/EEC und 93/68/EEC.

• DECLARATION DE CONFORMITE

Nous déclarons sous notre seule responsabilité que l'appareil, auquel se réfère cette déclaration, est conforme aux standards suivants: EN60065, EN55013, EN55020, EN61000-3-2 et EN61000-3-3. D'après les dispositions de la Directive 73/23/EEC, 89/336/EEC et 93/68/EEC.

• DICHIARAZIONE DI CONFORMITÀ

Dichiaro con piena responsabilità che questo prodotto, al quale la nostra dichiarazione si riferisce, è conforme alle seguenti normative: EN60065, EN55013, EN55020, EN61000-3-2 e EN61000-3-3. In conformità con le condizioni delle direttive 73/23/EEC, 89/336/EEC e 93/68/EEC.

• DECLARACIÓN DE CONFORMIDAD

Declaramos bajo nuestra exclusiva responsabilidad que este producto al que hace referencia esta declaración, está conforme con los siguientes estándares: EN60065, EN55013, EN55020, EN61000-3-2 y EN61000-3-3. Siguiendo las provisiones de las Directivas 73/23/EEC, 89/336/EEC y 93/68/EEC.

• EENVORMIGHEIDSVERKLARING

Wij verklaren uitsluitend op onze verantwoordelijkheid dat dit product, waarop deze verklaring betrekking heeft, in overeenstemming is met de volgende normen: EN60065, EN55013, EN55020, EN61000-3-2 en EN61000-3-3. Volgens de bepalingen van de Richtlijnen 73/23/EEC, 89/336/EEC en 93/68/EEC.

• ÖVERENSSTÄMMELSESTYPT

Härmed intygas helt på eget ansvar att denna produkt, vilken detta intyg avser, uppfyller följande standarder: EN60065, EN55013, EN55020, EN61000-3-2 och EN61000-3-3. Enligt stadgarna i direktiv 73/23/EEC, 89/336/EEC och 93/68/EEC.

CLASS 1 LASER PRODUCT
LUOKAN 1 LASERLAITE
KLASS 1 LASERAPPARAT

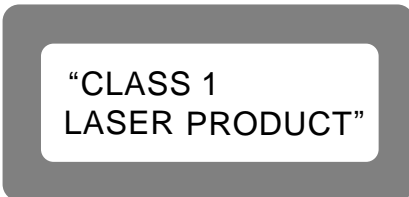

ADVARSSEL: USYNLIG LASERSTRÅLING VED ÅBNING, NÅR SIKKERHEDSAFBRYDERE ER UDE AF FUNKTION. UNGDÅ UDSAETTELSE FOR STRÅLING.
VAROITUS! LAITTEEN KÄYTTÄMINEN MUULLA KUIN TÄSSÄ KÄYTTÖOHJEESSA MAINITULLA TAVALLA SAATTAA ALTISTAA KÄYTTÄJÄN TURVALLISUUSLUOKAN 1 YLITTÄVÄLLE NÄKYMÄMÄTTÖMÄLLE LASERSÄTEILYLLE.
VARNING- OM APPARATEN ANVÄNDS PÅ ANNAT SÄTT ÄN I DENNA BRUKSANVISNING SPECIFICERATS, KAN ANVÄNDAREN UTSÄTTAS FÖR OSYNLIG LASERSTRÅLNING SOM ÖVERSKRIDER GRÄNSEN FÖR LASERKLASS 1.

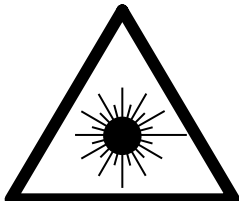

CAUTION:

- The ventilation should not be impeded by covering the ventilation openings with items, such as newspapers, table-cloths, curtains, etc.
- No naked flame sources, such as lighted candles, should be placed on the apparatus.
- Please be care the environmental aspects of battery disposal.
- The apparatus shall not be exposed to dripping or splashing for use.
- No objects filled with liquids, such as vases, shall be placed on the apparatus.

ACHTUNG:

- Die Belüftung sollte auf keinen Fall durch das Abdecken der Belüftungsöffnungen durch Gegenstände wie beispielsweise Zeitungen, Tischtücher, Vorhänge o. Ä. behindert werden.
- Auf dem Gerät sollten keinerlei direkten Feuerquellen wie beispielsweise angezündete Kerzen aufgestellt werden.
- Bitte beachten Sie bei der Entsorgung der Batterien die geltenden Umweltbestimmungen.
- Das Gerät sollte keinerlei Flüssigkeit, also keinem Tropfen oder Spritzen ausgesetzt werden.
- Auf dem Gerät sollten keinerlei mit Flüssigkeit gefüllten Behälter wie beispielsweise Vasen aufgestellt werden.

ATTENTION:

- La ventilation ne doit pas être gênée en recouvrant les ouvertures de la ventilation avec des objets tels que journaux, rideaux, tissus, etc.
- Aucune flamme nue, par exemple une bougie, ne doit être placée sur l'appareil.
- Veillez à respecter l'environnement lorsque vous jetez les piles usagées.
- L'appareil ne doit pas être exposé à l'eau ou à l'humidité.
- Aucun objet contenant du liquide, par exemple un vase, ne doit être placé sur l'appareil.

PRECAUZIONI:

- Le aperture di ventilazione non devono essere ostruite coprendole con oggetti, quali giornali, tovaglie, tende e così via.
- Non posizionare sull'apparecchiatura fiamme libere, come ad esempio le candele accese.
- Prestare attenzione agli aspetti legati alla tutela dell'ambiente quando si smaltisce la batteria.
- L'apparecchiatura non deve essere esposta a gocciolii o spruzzi.
- Non posizionare sull'apparecchiatura nessun oggetto contenete liquidi, come ad esempio i vasi.

PRECAUCIÓN:

- La ventilación no debe quedar obstruida por hacere cubierto las aperturas con objetos como periódicos, manteles, cortinas, etc.
- No debe colocarse sobre el aparato ninguna fuente inflamable sin protección, como velas encendidas.
- A la hora de deshacerse de las pilas, respete la normativa para el cuidado del medio ambiente.
- No se expondrá el aparato al goteo o salpicaduras cuando se utilice.
- No se colocarán sobre el aparato objetos llenos de líquido, como jarros.

WAARSCHUWING:

- De ventilatie mag niet worden belemmerd door de ventilatieopeningen af te dekken met bijvoorbeeld kranten, een tafelkleed, gordijnen, enz.
- Plaats geen open vlammen, bijvoorbeeld een brandende kaars, op het apparaat.
- Houd u steeds aan de milieuvoorschriften wanneer u gebruikte batterijen wegdoet.
- Stel het apparaat niet bloot aan druppels of spatten.
- Plaats geen voorwerpen gevuld met water, bijvoorbeeld een vaas, op het apparaat.

OBSERVERA:

- Ventilationen bör inte förhindras genom att täcka för ventilationsöppningarna med föremål såsom tidningar, bordsdukar, gardiner osv.
- Inga blottade brandkällor, såsom tända ljus, bör placeras på apparaten.
- Tänk på miljöaspekterna när du bortskaffar batteri.
- Apparaten får inte utsättas för vätska.
- Inga objekt med vätskor, såsom vaser, får placeras på apparaten.

ATTENZIONE: QUESTO APPARECCHIO E' DOTATO DI DISPOSITIVO OTTICO CON RAGGIO LASER. L'USO IMPROPRIO DELL'APPARECCHIO PUO' CAUSARE PERICOLOSE ESPOSIZIONI A RADIAZIONI!

**NOTE ON USE / HINWEISE ZUM GEBRAUCH /
OBSERVATIONS RELATIVES A L'UTILISATION / NOTE SULL'USO
NOTAS SOBRE EL USO / ALVORENS TE GEBRUIKEN / OBSERVERA**

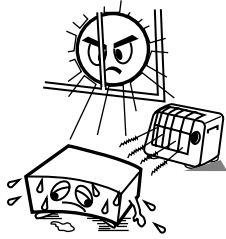

- Avoid high temperatures. Allow for sufficient heat dispersion when installed on a rack.
- Vermeiden Sie hohe Temperaturen. Beachten Sie, daß eine ausreichend Luftzirkulation gewährleistet wird, wenn das Gerät auf ein Regal gestellt wird.
- Éviter des températures élevées. Tenir compte d'une dispersion de chaleur suffisante lors de l'installation sur une étagère.
- Evitate di esporre l'unità a temperature alte. Assicuratevi che ci sia un'adeguata dispersione del calore quando installate l'unità in un mobile per componenti audio.
- Evite altas temperaturas. Permite la suficiente dispersión del calor cuando está instalado en la consola.
- Vermijd hoge temperaturen. Zorg voor een degelijk hitteafvoer indien het apparaat op een rek wordt geplaatst.
- Undvik höga temperaturer. Se till att det finns möjlighet till god värmeavledning vid montering i ett rack.

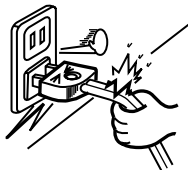

- Handle the power cord carefully. Hold the plug when unplugging the cord.
- Gehen Sie vorsichtig mit dem Netzkabel um. Halten Sie das Kabel am Stecker, wenn Sie den Stecker herausziehen.
- Manipuler le cordon d'alimentation avec précaution. Tenir la prise lors du débranchement du cordon.
- Maneggiare il filo di alimentazione con cura. Agite per la spina quando scollegate il cavo dalla presa.
- Maneje el cordón de energía con cuidado. Sostenga el enchufe cuando desconecte el cordón de energía.
- Hanteer het netsnoer voorzichtig. Houd het snoer bij de stekker vast wanneer deze moet worden aan- of losgekoppeld.
- Hantera nätkabeln varsamt. Håll i kabeln när den kopplas från el-uttaget.

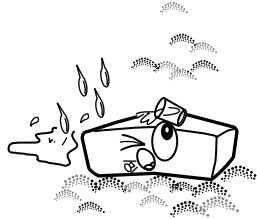

- Keep the set free from moisture, water, and dust.
- Halten Sie das Gerät von Feuchtigkeit, Wasser und Staub fern.
- Protéger l'appareil contre l'humidité, l'eau et la poussière.
- Tenete l'unità lontana dall'umidità, dall'acqua e dalla polvere.
- Mantenga el equipo libre de humedad, agua y polvo.
- Laat geen vochtigheid, water of stof in het apparaat binnendringen.
- Utsätt inte apparaten för fukt, vatten och damm.

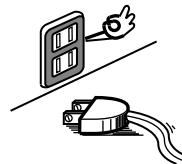

- Unplug the power cord when not using the set for long periods of time.
- Wenn das Gerät eine längere Zeit nicht verwendet werden soll, trennen Sie das Netzkabel vom Netzstecker.
- Débrancher le cordon d'alimentation lorsque l'appareil n'est pas utilisé pendant de longues périodes.
- Disinnestate il filo di alimentazione quando avete l'intenzione di non usare il filo di alimentazione per un lungo periodo di tempo.
- Desconecte el cordón de energía cuando no utilice el equipo por mucho tiempo.
- Neem altijd het netsnoer uit het stopcontact wanneer het apparaat gedurende een lange periode niet wordt gebruikt.
- Koppla ur nätkabeln om apparaten inte kommer att användas i lång tid.

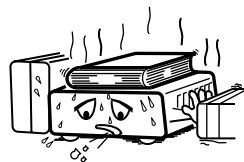

* (For sets with ventilation holes)

- Do not obstruct the ventilation holes.
- Die Belüftungsöffnungen dürfen nicht verdeckt werden.
- Ne pas obstruer les trous d'aération.
- Non coprite i fori di ventilazione.
- No obstruya los orificios de ventilación.
- De ventilatieopeningen mogen niet worden geblokkeerd.
- Täpp inte till ventilationsöppningarna.

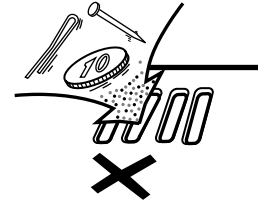

- Do not let foreign objects in the set.
- Keine fremden Gegenstände in das Gerät kommen lassen.
- Ne pas laisser des objets étrangers dans l'appareil.
- E' importante che nessun oggetto è inserito all'interno dell'unità.
- No deje objetos extraños dentro del equipo.
- Laat geen vreemde voorwerpen in dit apparaat vallen.
- Se till att främmande föremål inte tränger in i apparaten.

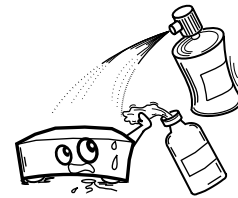

- Do not let insecticides, benzene, and thinner come in contact with the set.
- Lassen Sie das Gerät nicht mit Insektiziden, Benzin oder Verdünnungsmitteln in Berührung kommen.
- Ne pas mettre en contact des insecticides, du benzène et un diluant avec l'appareil.
- Assicuratevi che l'unità non venga in contatto con insetticidi, benzolo o solventi.
- No permita el contacto de insecticidas, gasolina y diluyentes con el equipo.
- Laat geen insectenverdelgende middelen, benzine of ververdunner met dit apparaat in contact komen.
- Se till att inte insektsmedel på spraybruk, bensen och thinner kommer i kontakt med apparatens hölje.



- Never disassemble or modify the set in any way.
- Versuchen Sie niemals das Gerät auseinander zu nehmen oder auf jegliche Art zu verändern.
- Ne jamais démonter ou modifier l'appareil d'une manière ou d'une autre.
- Non smontate mai, nè modificate l'unità in nessun modo.
- Nunca desarme o modifique el equipo de ninguna manera.
- Nooit dit apparaat demonteren of op andere wijze modificieren.
- Ta inte isär apparaten och försök inte bygga om den.

About the operating instructions on the CD-ROM [ENGLISH]

1. Check the computer environment.

- **Adobe Acrobat Reader® 5.0 or later is required to view the text.**
- If Adobe Acrobat Reader® is not installed on the computer, install it from the included CD-ROM. (Adobe Reader 6.0)

[Windows] AdbeRdr60_ece.exe

- Adobe Reader 6.0 system requirements

[Windows]

- Intel® Pentium® processor
- Microsoft® Windows 98 Second Edition, Windows Millennium Edition, Windows NT® 4.0 with Service Pack 6, Windows 2000 with Service Pack 2, Windows XP Professional or Home Edition, Windows XP Tablet PC Edition
- 32MB of RAM (64MB recommended)
- 60MB of available hard-disk space
- Internet Explorer 5.01, 5.5, 6.0, or 6.1

2. Open the operating instructions' file.

- Open the file "DVDA1XV_ENGLISH.pdf".

[If you cannot view the contents of the CD-ROM]

- Contact one of the sales agents shown on the included "Service Station" list. The operating instructions in the requested language will be sent to you in writing (copy).

A propos du mode d'emploi fourni sur le CD-ROM [FRANCAIS]

1. Vérifier l'équipement de l'ordinateur.

- **Adobe Acrobat Reader® 5.0 ou ultérieur est nécessaire pour lire le texte.**
- Si Adobe Acrobat Reader® n'est pas installé sur l'ordinateur, installez-le à partir du CD-ROM fourni. (Adobe Reader 6.0)

[Windows] AdbeRdr60_fra_full.exe

- Configuration requise pour Adobe Reader 6.0

[Windows]

- Processeur Intel® Pentium®
- Microsoft® Windows 98 Deuxième Edition, Windows Millennium Edition, Windows NT® 4.0 avec Service Pack 6, Windows 2000 avec Service Pack 2, Windows XP Edition Professionnelle ou Familiale, Windows XP Edition Tablet PC
- 32 Mo de RAM (64 Mo recommandés)
- 60 Mo d'espace disque disponible
- Microsoft Internet Explorer 5.01, 5.5, 6.0 ou 6.1

2. Ouvrez le fichier du mode d'emploi.

- Ouvrez le fichier "DVDA1XV_FRANCAIS.pdf".

[Si vous ne pouvez pas lire le contenu du CD-ROM]

- Contactez un des revendeurs figurant dans la liste "Service Station" fournie. Le mode d'emploi dans la langue requise vous sera envoyé sur papier (copie).

Wissenswertes über die Bedienungsanleitung auf der CD-ROM [DEUTSCH]

1. Überprüfen Sie die Computer-Umgebung.

- **Adobe Acrobat Reader 5.0® oder neuer ist für das Lesen des Textes erforderlich.**
- Falls Adobe Acrobat Reader® nicht auf dem Computer installiert ist, installieren Sie das Programm bitte von der im Lieferumfang enthaltenen CD-ROM aus. (Adobe Reader 6.0)

[Windows] AdbeRdr60_deu_full.exe

- Adobe Reader 6.0 Systemanforderungen

[Windows]

- Intel® Pentium®-Prozessor
- Microsoft® Windows 98 Second Edition, Windows Millennium Edition, Windows NT® 4.0 mit Service Pack 6, Windows 2000 mit Service Pack 2, Windows XP Professional oder Home, Windows XP Tablet PC Edition
- 32 MB RAM (64 MB empfohlen)
- 60 MB freier Festplattenspeicher
- Internet Explorer 5.01, 5.5, 6.0 oder 6.1

2. Öffnen Sie die Datei mit der Bedienungsanleitung.

- Öffnen Sie die Datei "DVDA1XV_DEUTSCH.pdf".

[Falls Sie den Inhalt der CD-ROM nicht lesen können]

- Konsultieren Sie eine der in der im Lieferumfang enthaltenen "Kundenservice-Stellen" aufgelisteten Verkaufsstellen. Die in der gewünschten Sprache verfasste Bedienungsanleitung wird Ihnen dann als Schriftdokument (Kopie) zugestellt.

Informazioni sul Manuale delle istruzioni incluso nel CD-ROM [ITALIANO]

1. Controllare l'ambiente informatico.

- **È necessario disporre di Adobe Acrobat Reader 5.0® o versione successiva per visualizzare il testo.**
- Se Adobe Acrobat Reader® non è installato sul computer in uso, installarlo dal CD-ROM incluso. (Adobe Reader 6.0)

[Windows] AdbeRdr60_ita_full.exe

- Requisiti di sistema per Adobe Reader 6.0

[Windows]

- Processore Intel® Pentium®
- Microsoft® Windows 98 Second Edition, Windows Millennium Edition, Windows NT® 4.0 con Service Pack 6, Windows 2000 con Service Pack 2, Windows XP Professional o Home Edition, Windows XP Tablet PC Edition
- 32 MB di RAM (64 MB consigliati)
- 60 MB di spazio disponibile su disco rigido
- Internet Explorer 5.01, 5.5, 6.0 o 6.1

2. Aprire il file del Manuale delle istruzioni.

- Aprire il file "DVDA1XV_ITALIANO.pdf".

[Se non è possibile visualizzare il contenuto del CD-ROM]

- Rivolgersi a un agente di vendita presente nell'elenco "Stazione di servizio" incluso. Il Manuale delle istruzioni nella lingua richiesta verrà inviato per posta (copia).

Acerca de las instrucciones de funcionamiento del CD-ROM [ESPAÑOL]

1. Compruebe el entorno del ordenador.

- Se necesita la versión del Adobe Acrobat Reader® 5.0 o una superior para ver el texto.
- Si la versión del Adobe Acrobat Reader® no está instalada en el ordenador, instálela desde el CD-ROM suministrado. (Adobe Reader 6.0)

[Windows] AdbeRdr60_esp_full.exe

- Requisitos del sistema de Adobe Reader 6.0

[Windows]

- Procesador Intel® Pentium®
- Microsoft® Windows 98 Second Edition, Windows Millennium Edition, Windows NT® 4.0 con Service Pack 6, Windows 2000 con Service Pack 2, Windows XP Professional o Home Edition, Windows XP Tablet PC Edition
- 32 MB de RAM (se recomiendan 64 MB)
- 60 MB de espacio disponible en el disco duro
- Internet Explorer 5.01, 5.5, 6.0 ó 6.1

2. Abra el archivo de las instrucciones de funcionamiento.

- Abra el archivo "DVDA1XV_ESPANOL.pdf".

[Si no puede visualizar el contenido del CD-ROM]

- Póngase en contacto con uno de los agentes de venta que aparecen en la lista "Estación de servicio" suministrada. Se le enviarán las instrucciones de funcionamiento en el idioma solicitado por escrito (copia).

Om bruksanvisningarna på CD-ROM-skivan [SVENSKA]

1. Kontrollera datormiljön.

- Adobe Acrobat Reader® 5.0 eller senare behövs för att visa texten.
- Om Adobe Acrobat Reader® inte är installerad på datorn, ska du installera det från den medföljande CD-ROM-skivan. (Adobe Reader 6.0)

[Windows] AdbeRdr60_sve_full.exe

- Adobe Reader 6.0 – systemkrav

[Windows]

- Intel® Pentium® processor
- Microsoft® Windows 98 Second Edition, Windows Millennium Edition, Windows NT® 4.0 med Service Pack 6, Windows 2000 med Service Pack 2, Windows XP Professional eller Home Edition, Windows XP Tablet PC Edition
- 32 MB RAM (64 MB rekommenderas)
- 60 MB ledigt hårddiskutrymme
- Internet Explorer 5.01, 5.5, 6.0 eller 6.1

2. Öppna filen med instruktioner.

- Öppna filen "DVDA1XV_SVENSKA.pdf".

[Om du inte kan visa innehållet på CD-ROM-skivan]

- Kontakta en av försäljningsagenterna i "Service Station"-listan. Bruksanvisningarna på nödvändigt språk kommer att skickas till dig skriftligt (kopia).

Over de gebruiksaanwijzing op de CD-ROM [NEDERLANDS]

1. Controleer de computeromgeving.

- Om de tekst te bekijken, is Adobe Acrobat Reader® 5.0 of hoger vereist.
- Als Adobe Acrobat Reader® niet geïnstalleerd is op de computer, installeert u dit programma vanaf de bijgeleverde CD-ROM. (Adobe Reader 6.0)

[Windows] AdbeRdr60_nld_full.exe

- Adobe Reader 6.0 – Systeemvereisten

[Windows]

- Intel® Pentium®-processor
- Microsoft® Windows 98 Second Edition, Windows Millennium Edition, Windows NT® 4.0 met Service Pack 6, Windows 2000 met Service Pack 2, Windows XP Professional of Home Edition, Windows XP Tablet PC Edition
- 32 MB RAM (64 MB aanbevolen)
- 60 MB vrije schijfruimte
- Internet Explorer 5.01, 5.5, 6.0 of 6.1

2. Open het bestand van de gebruiksaanwijzing.

- Open het bestand "DVDA1XV_NEDERLANDS.pdf".

[Als u de inhoud van de CD-ROM niet kunt bekijken]

- Neem contact op met een van de verkooppunten die staan vermeld in de bijgevoegde lijst van "Onderhoudscentra". U zal dan een gedrukt exemplaar van de gebruiksaanwijzing in de gewenste taal ontvangen.

— TABLE OF CONTENTS —

| | |
|--|---|
| 1 Features.....8, 9 | 14 Playing Repeatedly71, 72 |
| 2 Discs10 | 15 Playing Tracks in the Desired Order73 |
| 3 Cautions on Handling Discs.....11 | 16 Playing Tracks in the Random Order74 |
| 4 Connections12 ~ 22 | 17 Using the On-screen Display75 |
| 5 Part Names and Functions.....23 ~ 26 | 18 Using the Multiple Audio, Subtitle and Angle Functions..76 ~ 78 |
| 6 Remote Control Unit.....27 ~ 29 | 19 Using the Menus.....79, 80 |
| 7 Loading Discs30 | 20 Marking Scenes you want to see again81 |
| 8 Changing the Default Settings.....31 ~ 56 | 21 Playing in the Zoom Mode82 |
| 9 Using the Pure Direct Mode.....57, 58 | 22 Playing MP3.....83, 84 |
| 10 Using the Super Audio CD Setup.....58 | 23 Playing WMA.....85 |
| 11 Adjusting the Picture Quality59 ~ 62 | 24 Playing Still Picture Files (JPEG format).....86 ~ 88 |
| 12 Using the Video Setup63 ~ 65 | 25 Troubleshooting89, 90 |
| 13 Playback66 ~ 70 | 26 Main Specifications.....91 |

• **ACCESSORIES**

Please check to make sure the following items are included with the main unit in the carton:

| | |
|--------------------------------------|--|
| ① Audio cord1 | ⑥ DENON LINK cord.....1 |
| ② Video cord.....1 | ⑦ IEEE 1394 cord.....1 |
| ③ Remote control unit (RC-993).....1 | ⑧ CD-ROM (Operating instructions)1 |
| ④ R6P/AA batteries3 | ⑨ Operating instructions1 |
| ⑤ Power supply cord.....1 | ⑩ Service station list1 |

1 FEATURES

1. Newly developed high performance 10 bit I/P converter performing all processing with a precision of 10 bits

A high precision film/video source detection function not only makes the DVD-A1XV compatible with 30 frame film sources, but also achieves high quality images with smooth, natural pictures and little jaggy noise even when playing images that presented problems during editing. In addition, a large number of picture quality adjustment functions, including noise reduction and digital gamma correction, enables output of not only progressive but also HDMI/DVI signals, so fine adjustments can be made according to the display you are using.

2. Newly developed 10-bit scaler for high definition pixel conversion

The DVD-A1XV is equipped with a newly developed scaler that uses an original algorithm to conduct pixel conversion of the video output signals which have been given optimum progressive processing with the I/P converter into higher definition 720P or 1080i signals with 10-bit precision. This in conjunction with the high performance 10-bit I/P converter makes for effective high picture quality playback, and enables output for digital signals via the HDMI/DVI connectors without reduction in picture quality due to analog conversion.

In addition, the signals are optimized for output to the independent HDMI and DVI transmitters, so two digital video signals can be output at the same time.

3. DPI (DENON Pixel Image) correction function for more natural outline correction

DENON has developed an outline correction circuit using a new algorithm that samples the image data of pixels adjacent to the perceived pixels and processes them. The image is detected and processed in units of pixels in the vertical, horizontal and diagonal directions, thereby generating more natural outlines.

In addition, other processing is performed in ways optimum for the images, for example brightness signals and color signals are processed with independent algorithms, ringing that tends to occur when images are enhanced is restrained, etc., thereby achieving more natural images with no reduction in picture quality.

4. 14-bit/216 MHz video D/A converter (NOTE 1)

The DVD-A1XV uses a video D/A converter that conducts D/A conversion of all video signals at 14 bits and allows 8X oversampling in the progressive mode to achieve the high quality picture that DVDs are meant to provide. In addition, NSV technology reduces noise upon D/A conversion.

5. HDMI/DVI digital video interface (NOTE 2)

HDMI Ver. 1.1 enables digital transfer of the video and audio signals of DVD audio discs that are copyright-protected by CPPM, something that was not possible with HDMI Ver. 1.0. The DVD-A1XV is HDMI Ver. 1.1 compatible.

(1) HDMI connector

Digital video signals are transferred in Y Cb Cr or RGB.

The audio signals can be transferred simultaneously, so both audio and video signals can be transferred with a single cable.

(2) DVI-D connector

Digital video signals are transferred in RGB.

6. Advanced AL24 Processing

“Advanced AL24 Processing” which greatly increases the amount of information in the time axis area using unique high speed signal detection and processing technology for the PCM signal (CD/DVD) playback circuitry is provided for 2-channel output. In addition to expansion of data to 24 bits, natural signal correction without marring the original data is performed with upconversion sampling.

In addition, DENON's original analog waveform reproduction technology, “AL24 Processing PLUS”, is used for the 5.1-channel audio output, resulting in high sound quality for all PCM signal sources.

7. High precision 24-bit D/A converter

The audio playback circuit includes an advanced segment type D/A converter with the high technical specifications in the business, manufactured by Burr-Brown, a company with an established reputation for D/A converters. This high performance D/A converter allows not only input of the 24-bit/192 kHz data of DVD-Audio discs, it also includes an analog pure FIR filter for ideal DSD playback of Super Audio CDs.

Furthermore, for mixed left and right channel signals, this D/A converter is used for independent monaural modes for both the left and right channels, a true luxury enabling playback of even high quality signals.

8. DENON LINK/IEEE1394 digital audio transfer connectors

Digital transfer is possible not only of the audio of DVD video discs but also of the multi-channel audio of DVD audio discs and Super Audio CDs.

(1) DENON LINK terminal (* for DENON LINK 3rd)

(2) IEEE 1394 terminal

9. THX® Ultra Certification, the symbol of excellent high quality (NOTE 3)

The DVD-A1XV meets THX® Ultra standards, a strict set of criteria advocated by Lucasfilm on the picture and sound quality of DVD video players and their operability with connected equipment. This makes it possible to achieve the high quality pictures and sound.

10. Super Audio CD multi-channel playback compatibility

In addition to playing DVD audio and video discs, the DVD-A1XV can play multi-channel Super Audio CDs with a playback frequency range covering 100 kHz and a dynamic range of 120 dB or greater within the audible frequency range, and a maximum of 5.1 channels can be output.

11. HDCD® (High Definition Compatible Digital®) decoder (NOTE 4)

HDCD is an encoding/decoding technology that greatly reduces the distortion occurring at the time of digital recording while maintaining compatibility with the conventional CD format. HDCD allows 20-bit data to be converted into the 16-bit data of current CDs with no loss in sound quality.

12. Dolby Digital/DTS decoder (NOTE 5, 6)

The DVD-A1XV is equipped with a built-in Dolby Digital/DTS decoder, allowing you to recreate the atmosphere of a movie theater or concert hall when using the DVD-A1XV in combination with an AV amplifier and speakers.

13. Thorough vibration-resistant design

- (1) Mechanism using a hybrid loader.
- (2) The pickup mechanism is positioned at the center to reduce the effects of external vibrations.
- (3) A heavyweight chassis and low center of gravity make for a low vibration design.
- (4) The six blocks (mechanism + control unit, audio unit, video unit, digital interface unit, analog power unit and digital power unit) are structurally isolated, in a design that eliminates mutual interference.

14. Multiple functions















- (1) Still picture playback function
Kodak Picture CD (NOTE 7) and Fujifilm Fujicolor CD (NOTE 8) can be played on the DVD-A1XV.
Still images stored in JPEG format on CD-R/RWs can also be played.
- (2) Windows Media™ playback function (NOTE 9)
Windows Media™ CDs can be played on the DVD-A1XV.
- (3) Multiple audio function
Selection of up to 8 audio languages.
(The number of languages offered differs from DVD to DVD.)
- (4) Multiple subtitle function
Selection of up to 32 subtitle languages.
(The number of languages offered differs from DVD to DVD.)
- (5) Multiple angle function
The angle of view can be changed.
(For DVDs on which multiple angles are recorded.)
- (6) GUI (Graphical User Interface) function
The DISPLAY button on the remote control unit can be used to display player and disc information on the TV screen.
- (7) Marker function
The positions of up to five scenes can be stored in the memory, so you can watch your favourite scenes whenever you want.
- (8) Playback disable function
This function can be used to disable playback of DVDs you do not want children to watch.

NOTES:

1. "NSV" is a trademark of Analog Devices, Inc.
2. HDMI, the HDMI logo and High-Definition Multimedia Interface are trademarks or registered trademarks of HDMI Licensing LLC.
3. Manufactured under license of Lucasfilm Ltd. Lucasfilm and THX® Ultra are registered trademarks of Lucasfilm Ltd.
4. ®, HDCD®, High Definition Compatible Digital® and Microsoft® are either registered trademarks or trademarks of Microsoft Corporation, Inc. in the United States and/or other countries. HDCD system manufactured under license from Microsoft Corporation, Inc. This product is covered by one or more of the following: In the USA: 5,479,168, 5,638,074, 5,640,161, 5,808,574, 5,838,274, 5,854,600, 5,864,311, 5,872,531, and in Australia: 669114. Other patents pending.
5. Manufactured under license from Dolby Laboratories. "Dolby" and the double-D symbol are trademarks of Dolby Laboratories.
6. "DTS" and "DTS Digital Surround" are registered trademarks of Digital Theater Systems, Inc.
7. "KODAK" is a trademark of Eastman Kodak Company.
8. "FUJICOLOR CD" is a trademark of Fuji Photo Film Co, Ltd.
9. "Windows Media™", "Windows®" are a trademarks of Microsoft Corporation, Inc.

2 DISCS

- The types of discs listed on the table below can be used on the DVD-A1XV.
The marks are indicated on the disc labels or jackets.

| Usable discs | Mark (logo) | Recorded signals | Disc size |
|--|---|---|-------------------|
| DVD video DVD audio (NOTE 1) |    | Digital audio + digital video (MPEG2) | 12 cm |
| DVD-R DVD-RW (NOTE 2) |   | | |
| DVD+R (NOTE 2, 3) DVD+RW (NOTE 2) |   | | 8 cm |
| Super audio CD |  | | |
| Video CD (NOTE 1) |  | Digital audio + digital video (MPEG1) | 12 cm 8 cm |
| CD CD-R CD-RW (NOTE 4) |    | Digital audio MP3 Digital picture (JPEG) | 12 cm 8 cm |
| Kodak Picture CD |  | JPEG | 12 cm |
| Fujicolor CD |  | JPEG | 12 cm |
| WMA (Windows Media Audio) |  | Digital audio | 12 cm |

■ The following types of discs cannot be played on the DVD-A1XV:

- For European model:
DVDs with region numbers other than "2" or "ALL"
- For Oceanian, South American model:
DVDs with region numbers other than "4" or "ALL"
- DVD-ROM/RAMs
- CD-ROMs (unless MP3, JPEG, WMA Files)
- CVD/VSDs/SVCD
- CDVs (Only the audio part can be played.)
- CD-Gs (Only the audio is output.)
- Photo CDs

NOTE:

- Some DVD audio, DVD video and video CD discs do not operate as described in this manual due to the intentions of the discs' producers.
- The DVD-A1XV cannot play DVD-R, -RW, +R and +RW discs recorded in the "VR" mode or with "CPRM".
If you wish to play images recorded using a DVD recorder on the DVD-A1XV, set the DVD recorder to the "Video mode" (to record in the DVD-Video format) and record on a DVD-R, -RW, +R or +RW disc.
Discs that have not be finalized cannot be played.
Depending on the disc's recording status, the disc may not be accepted or may not be played normally (the picture or sound may be not be smooth, etc.).
- DVD+R DL.(Dual Layer) cannot be played.
- According to recording quality, some CD-R/RW cannot be played.

NOTE:

- This DVD player is designed and manufactured to respond to the Region Management Information that is recorded on a DVD disc.
If the Region number described on the DVD disc does not correspond to the Region number of this DVD player, this DVD player cannot play this disc.

For European model:

The Region number for this DVD player is 2.



For Oceanian, South American model:

The Region number for this DVD player is 4.



■ Disc terminology

• Groups and tracks (DVD-audios)

DVD-audios are divided into several large sections called "groups" and smaller sections called "tracks".
Numbers are allotted to these sections. These numbers are called "group numbers" and "track numbers".

For example:

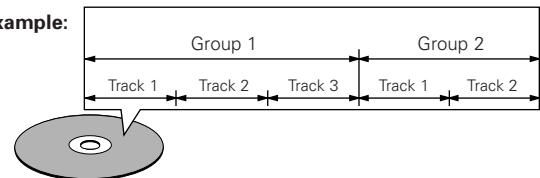

• Titles and chapters (DVD-videos)

DVD-videos are divided into several large sections called "titles" and smaller sections called "chapters".
Numbers are allotted to these sections. These numbers are called "title numbers" and "chapter numbers".

For example:

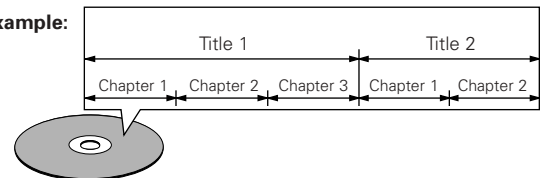

• Tracks (Super audio CDs, video and music CDs)

Super audio CDs, video and music CDs are divided into sections called "tracks".
Numbers are allotted to these sections. These numbers are called "track numbers".

For example:

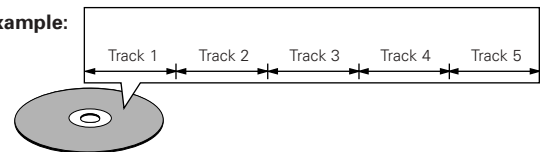

• Playback control (video CDs)

Video CDs including the words "playback control" on the disc or jacket are equipped with a function for displaying menus on the TV screen for selecting the desired position, displaying information, etc., in dialog fashion.
In this manual, playing video CDs using such menus is referred to "menu playback".
Video CDs with playback control can be used on the DVD-A1XV.

3 CAUTIONS ON HANDLING DISCS

Discs

Only the discs including the marks shown on page 10 can be played on the DVD-A1XV.

Note, however, that discs with special shapes (heart-shaped discs, hexagonal discs, etc.) cannot be played on the DVD-A1XV. Do not attempt to play such discs, as they may damage the player.

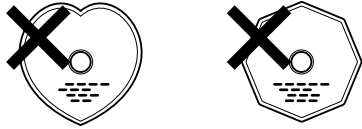

Holding Discs

Avoid touching the surface of discs when loading and unloading them.

Be careful not to get fingerprints on the signal surface (the side which shines in rainbow colors).



Cleaning Discs

■ Fingerprints or dirt on the disc may lower sound and picture quality or cause breaks in playback. Wipe off fingerprints or dirt.

■ Use a commercially available disc cleaning set or a soft cloth to wipe off fingerprints or dirt.

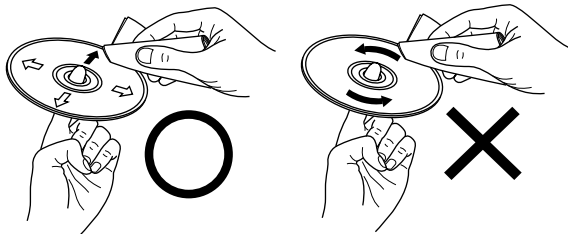

Wipe gently from the middle outwards.

Do not wipe with a circular motion.

NOTE:

- Do not use record spray or antistatic. Also do not use volatile chemicals such as benzene or thinner.

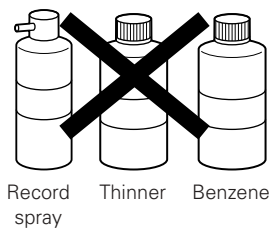

Record spray Thinner Benzene

Cautions on Handling Discs

- Do not get fingerprints, grease or dirt on discs.
- Be especially careful not to scratch discs when removing them from their cases.
- Do not bend discs.
- Do not heat discs.
- Do not enlarge the center hole.
- Do not write on the labeled (printed) side with a ball-point pen or a pencil.
- Water droplets may form on the surface if the disc is moved suddenly from a cold place to a warm one. Do not use a hairdryer, etc., to dry the disc.

Cautions on Storing Discs

- Always eject discs after playing them.
- Keep discs in their cases to protect them from dust, scratches and warping.
- Do not put discs in the following places:
 1. Places exposed to direct sunlight for long periods of time
 2. Humid or dusty places
 3. Places exposed to heat from heaters, etc.

Cautions on Loading Discs

- Only load one disc at a time. Loading one disc on top of another may result in damage or scratch the discs.
- Load 8 cm discs securely in the disc guide, without using an adapter. If the disc is not properly loaded, it may slip out of the guide and block the disc tray.
- Be careful not to let your fingers get caught when the disc tray is closing.
- Do not place anything but discs in the disc tray.
- Do not load cracked or warped discs or discs that have been fixed with adhesive, etc.
- Do not use discs on which the adhesive part of cellophane tape or glue used to attach the label is exposed, or discs with traces of tape or labels that have been peeled off. Such discs may get stuck inside the player, resulting in damage.

CAUTIONS ON INSTALLATION

Note:

For heat dispersal, do not install this equipment in a confined space such as a book case or similar unit.

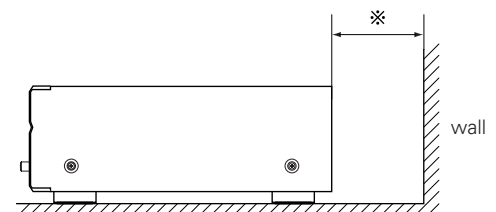
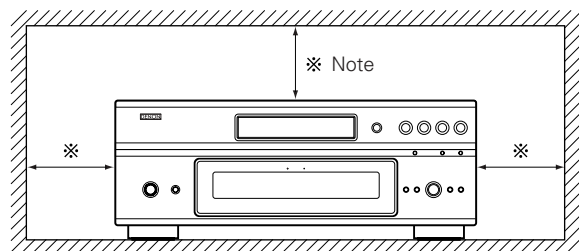

4 CONNECTIONS

NOTES:

- Read the manuals of all the components when making connections.
- Keep the power supply cord unplugged until all connections have been completed.
- If the power is on when connections are made, noise may be generated and damage the speakers.
- Be sure to connect the left and right channels properly, L (left) to L, R (right) to R.
- Plug the power supply cord securely into the power outlet. Incomplete connection may result in noise.
- Binding the power supply cord together with connection cords may result in humming or noise.

(1) Connecting to a TV

- Use the included audio video cord to connect the TV's video input connector and audio input connectors to the DVD-A1XV's VIDEO OUT or S-VIDEO OUT and AUDIO OUT.

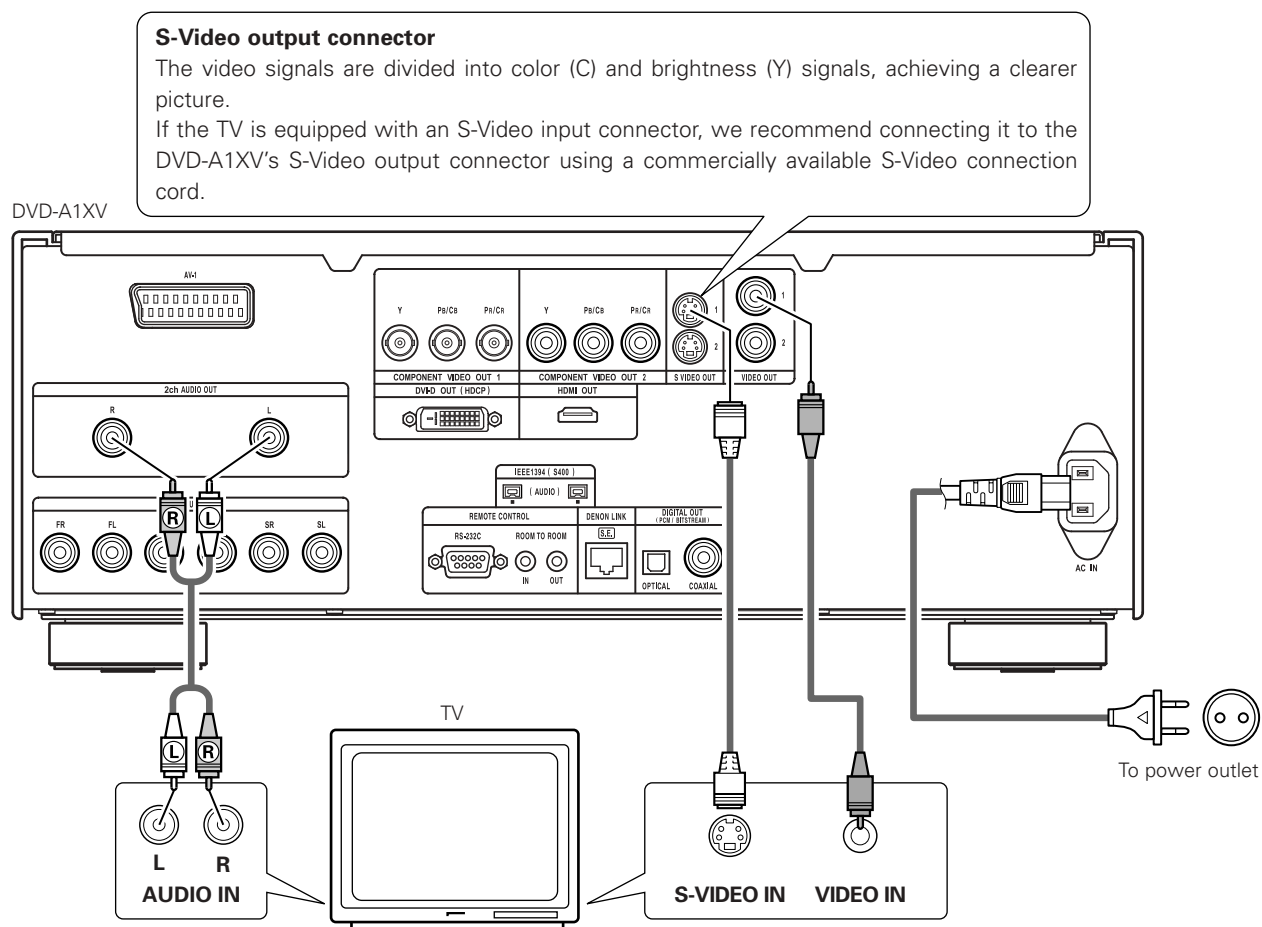

NOTES:

- Connect the DVD-A1XV's video outputs to the TV either directly or through an AV amplifier. Do not connect it via a VCR (video cassette recorder). Some discs contain copy prohibit signals. If such discs are played via a VCR, the copy prohibit system may cause disturbance in the picture.
- Set the "TV TYPE" in "VIDEO SETUP" in "SETUP" to comply with your TV's video format. When the TV is PAL formatted set to PAL. (See pages 43, 44.)
- Use the "2ch AUDIO OUT" connectors to connect a TV to the DVD-A1XV. To use with 5.1ch audio output, set "2CH (SRS OFF)" or "2CH (SRS ON)" under "AUDIO CHANNEL" in "AUDIO SETUP" on the "SETUP" menu to the initial settings. (See pages 46, 47.)
- Set the "TV ASPECT" in "VIDEO SETUP" in "SETUP" to comply with your TV's aspect. (See page 43.)
- To use with video out or s-video output, set "INTERLACED" in "TV SYSTEM" in "VIDEO SETUP" in "SETUP" at the initial settings. (See pages 43, 44.)

(2) Connecting to a TV or Monitor Equipped with Component Video Input Connectors

Component video output connectors (Pr/Cr, Pb/Cb and Y)

The red (Pr/Cr), blue (Pb/Cb) and brightness (Y) signals are output independently, achieving more faithful reproduction of the colors.

- The component video input connectors may be marked differently on some TVs or monitors (Pr, Pb and Y/R-Y, B-Y and Y/Cr, Cb and Y, etc.). For details, refer to the TV's operating instructions.
- **Connect in this way if your TV is compatible with Progressive Scan.**

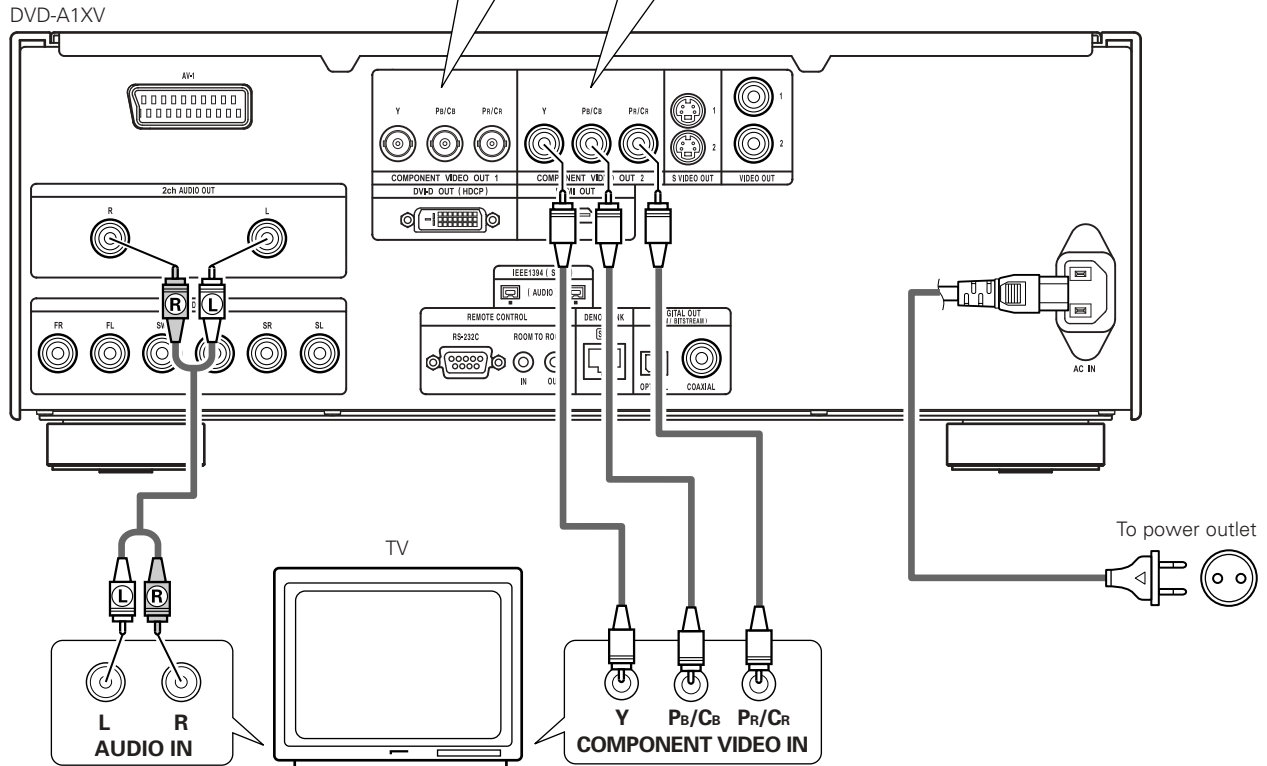

NOTES:

- Use the three commercially available video cords to connect the DVD-A1XV's component video output connectors to the TV or monitor.
- Set the "TV TYPE" in "VIDEO SETUP" in "SETUP" to comply with your TV's video format. When the TV is PAL formatted set to PAL. (See pages 43, 44.)
- Set the "COMPONENT VIDEO OUT" in "VIDEO SETUP" in "SETUP" to comply with Progressive TV.
- Use the "2ch AUDIO OUT" connectors to connect a TV to the DVD-A1XV. To use with 5.1ch audio output, set "2CH (SRS OFF)" or "2CH (SRS ON)" in "AUDIO CHANNEL" in "AUDIO SETUP" in "SETUP" at the initial settings. (See pages 46, 47.)
- Set the "TV ASPECT" in "VIDEO SETUP" in "SETUP" to comply with your TV's aspect. (See page 43.)

CONSUMERS SHOULD NOTE THAT NOT ALL HIGH DEFINITION TELEVISION SETS ARE FULLY COMPATIBLE WITH THIS PRODUCT AND MAY CAUSE ARTIFACTS TO BE DISPLAYED IN THE PICTURE. IN CASE OF 525 OR 625 PROGRESSIVE SCAN PICTURE PROBLEMS, IT IS RECOMMENDED THAT THE USER SWITCH THE CONNECTION TO THE "STANDARD DEFINITION" OUTPUT. IF THERE ARE QUESTIONS REGARDING OUR TV SET COMPATIBILITY WITH THIS MODEL 525p AND 625p DVD PLAYER, PLEASE CONTACT OUR CUSTOMER SERVICE CENTER.

(3) Connecting to a TV with 21-pin SCART Terminal

Use the commercially 21-pin SCART cable to connect the TV's 21-pin SCART terminal to the DVD-A1XV's 21-pin SCART terminal (AV1).

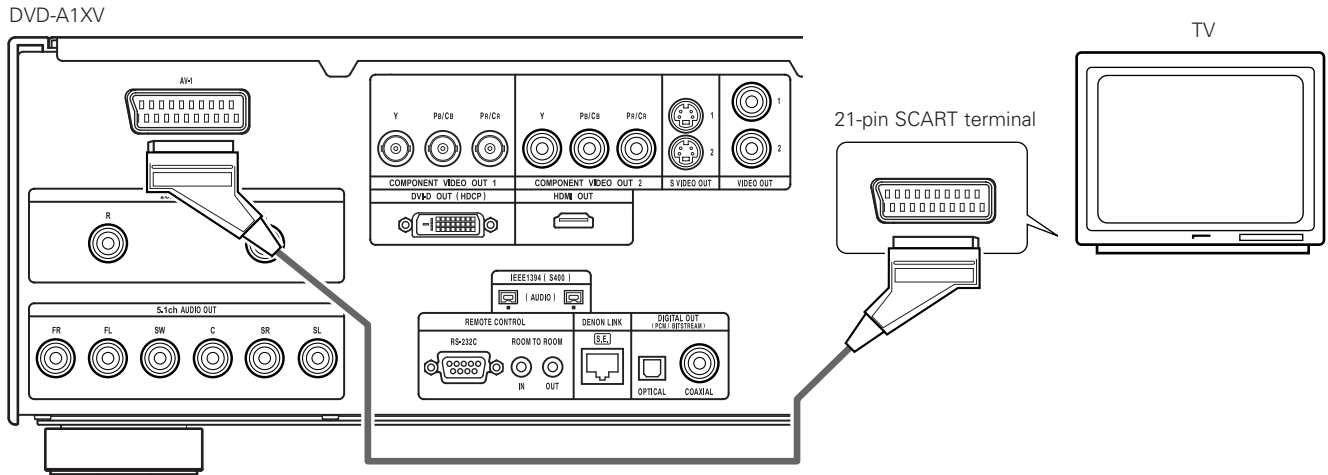

NOTE:

- Some discs contain copy prohibit signals. If such discs are played via a VCR, the copy prohibit system may cause disturbance in the picture.
- Set the "TV TYPE" in "VIDEO SETUP" in "SETUP" to comply with your TV's video format. When the TV is PAL formatted, set to PAL. (See pages 43, 44.)
- To improve picture quality, you can change the video signal output from the AV1 terminal from "Video" to either "S-Video" or "RGB" to suit the type of television you are using (See page 45.).

(4) Connecting to a AV amplifier with a built-in decoder

When DVDs recorded in Dolby Digital or DTS are played, Dolby Digital or DTS bitstream signals are output from the DVD player's digital audio output connectors. If a Dolby Digital or DTS decoder is connected, you can achieve sound with the power and sense of presence of a movie theater or concert hall.

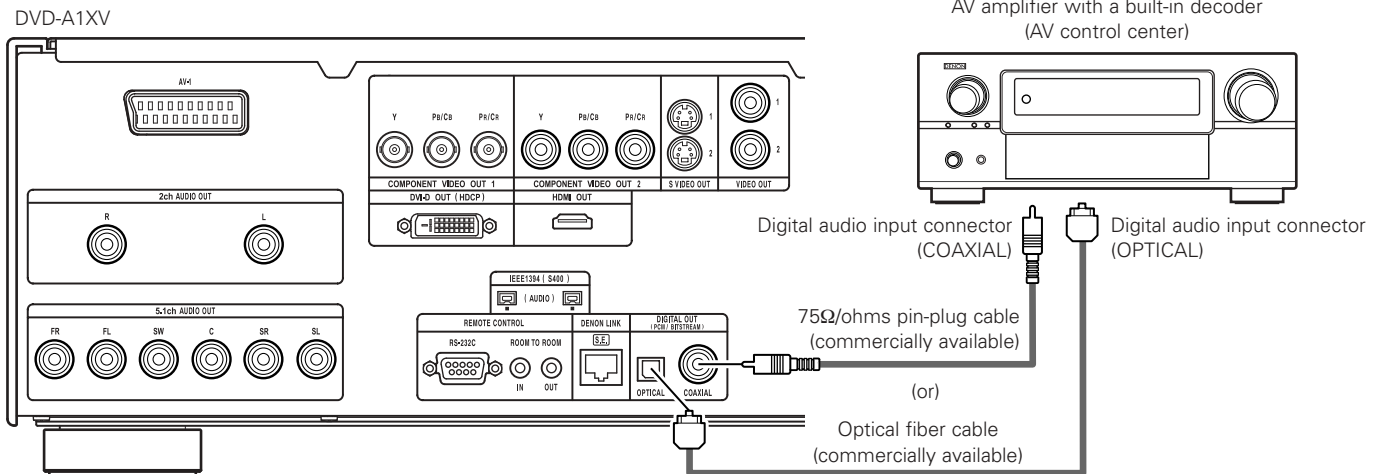

NOTE:

- Harsh noise that could harm your ears or damage the speakers is generated when a DVD recorded in DTS is played while using a decoder, etc., that is not DTS-compatible.

■ **Connecting an optical fiber cable (commercially available) to the digital audio input connector (OPTICAL)**

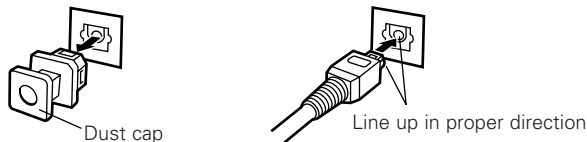

Remove the dust cap, line up the cable in the proper direction, then insert it securely as far as it goes.

NOTE:

- Store the dust cap in a safe place, and be careful not to lose it. When not using the terminal, attach the cap to protect the terminal from dust.

■ Sound output from the DVD-A1XV's digital audio output connectors

[In the case of bitstream output]

| | | Settings | |
|------------------------|---------------|----------------------------------|----------------------------------|
| | | DIGITAL OUTPUT | |
| Audio recording format | | NORMAL | PCM |
| DVD video | Dolby Digital | Dolby Digital bitstream | 2 channels PCM (48 kHz / 16 bit) |
| | DTS | DTS bitstream | 2 channels PCM (48 kHz / 16 bit) |
| | MPEG Audio | 2 channels PCM (48 kHz / 16 bit) | 2 channels PCM (48 kHz / 16 bit) |

[In the case of PCM output]

| | | Settings | | | |
|------------------------|--------------------------------|---------------------------|---------------------|----------------------------|-----------------------|
| | | LPCM (44.1 kHz / 48 kHz) | | | |
| Audio recording format | | OFF | | ON | |
| | | Copy protection ON | Copy protection OFF | | |
| DVD video | Linear PCM | 48 kHz / 16 ~ 24 bit | No output data (*1) | 48 kHz / 16 ~ 24 bit PCM | 48 kHz / 16 bit PCM |
| | | 96 kHz / 16 ~ 24 bit | No output data | 96 kHz / 16 ~ 24 bit PCM | 48 kHz / 16 bit PCM |
| DVD audio | Linear PCM or Packed PCM | 44.1 kHz / 16 ~ 24 bit | No output data (*2) | 44.1 kHz / 16 ~ 24 bit PCM | 44.1 kHz / 16 bit PCM |
| | | 48 kHz / 16 ~ 24 bit | No output data (*1) | 48 kHz / 16 ~ 24 bit PCM | 48 kHz / 16 bit PCM |
| | | 88.2 kHz / 16 ~ 24 bit | No output data | 88.2 kHz / 16 ~ 24 bit PCM | 44.1 kHz / 16 bit PCM |
| | | 96 kHz / 16 ~ 24 bit | No output data | 96 kHz / 16 ~ 24 bit PCM | 48 kHz / 16 bit PCM |
| | | 176.4 kHz / 16 ~ 24 bit | No output data | 88.2 kHz / 16 ~ 24 bit PCM | 44.1 kHz / 16 bit PCM |
| | | 192 kHz / 16 ~ 24 bit | No output data | 96 kHz / 16 ~ 24 bit PCM | 48 kHz / 16 bit PCM |
| Video CD | MPEG 1 | 44.1 kHz / 16 bit PCM | | 44.1 kHz / 16 bit PCM | |
| Music CD | 44.1 kHz / 16 bit Linear PCM | 44.1 kHz / 16 bit PCM | | 44.1 kHz / 16 bit PCM | |
| MP3 CD | MP3 (MPEG-1 Audio Layer 3) | 44.1, 48 kHz / 16 bit PCM | | 44.1, 48 kHz / 16 bit PCM | |
| WMA CD | WMA (Windows Media Audio) | 44.1, 48 kHz / 16 bit PCM | | 44.1, 48 kHz / 16 bit PCM | |
| Super audio CD | DSD (DIRECT STREAM DIGITAL) | No output data (*3) | | No output data (*3) | |

*1 Only 48 kHz/16 bit sources are output.

*2 Only 44.1 kHz/16 bit sources are output.

*3 44.1 kHz/16-bit PCM signals are output during CD layer playback.

- Down-mixed to 2 channels for multi-channel PCM sources. (Only the front left and right channels are output for sources for which down-mixing is prohibited.)
- When playing copyright-protected linear PCM or packed PCM DVDs, in consideration of copyrights, no digital signals are output for sources exceeding 48 kHz/16 bits. When playing such sources, either set "LPCM (44.1 kHz/48 kHz)" under "AUDIO SETUP" at "SETUP" to "ON" (See pages 46, 50.) or make analog connections. (See page 16.)
- When making digital connections to an AV amplifier that is not compatible with 96 kHz/88.2 kHz signals, set "LPCM (44.1 kHz/48 kHz)" under "AUDIO SETUP" at "SETUP" to "ON". (See pages 46, 50.)
- With Super audio CDs, digital audio signals cannot be output from the digital out terminals. Use analog or IEEE1394 connections. (See pages 16, 19, 20.)
- When "DIGITAL OUTPUT : OFF" is selected at the "PURE DIRECT MODE", digital signals are not output from the digital audio output at this time.
- Bitstream signals are signals that are compressed and converted into digital format. They are decoded into multi-channel audio signals (5.1-channel, etc.) by the decoder.
- Linear PCM audio is the signal recording format used for music CDs. While the signals are recorded at 44.1 kHz/16 bit for music CDs, for DVDs they are recorded at 44.1 kHz/16 bit to 192 kHz/24 bit, providing higher sound quality than music CDs.
- Packed PCM signals are high sound quality compressed PCM signals that are decompressed with virtually no loss of data.

(5) Connecting a basic 5.1-channel surround system

Analog 5.1-channel audio signals can be output from the DVD-A1XV.

The multi-channel audio signals recorded in packed PCM and the multi-channel Super audio CDs can be played when an AV amplifier equipped with analog 5.1-channel audio inputs is connected.

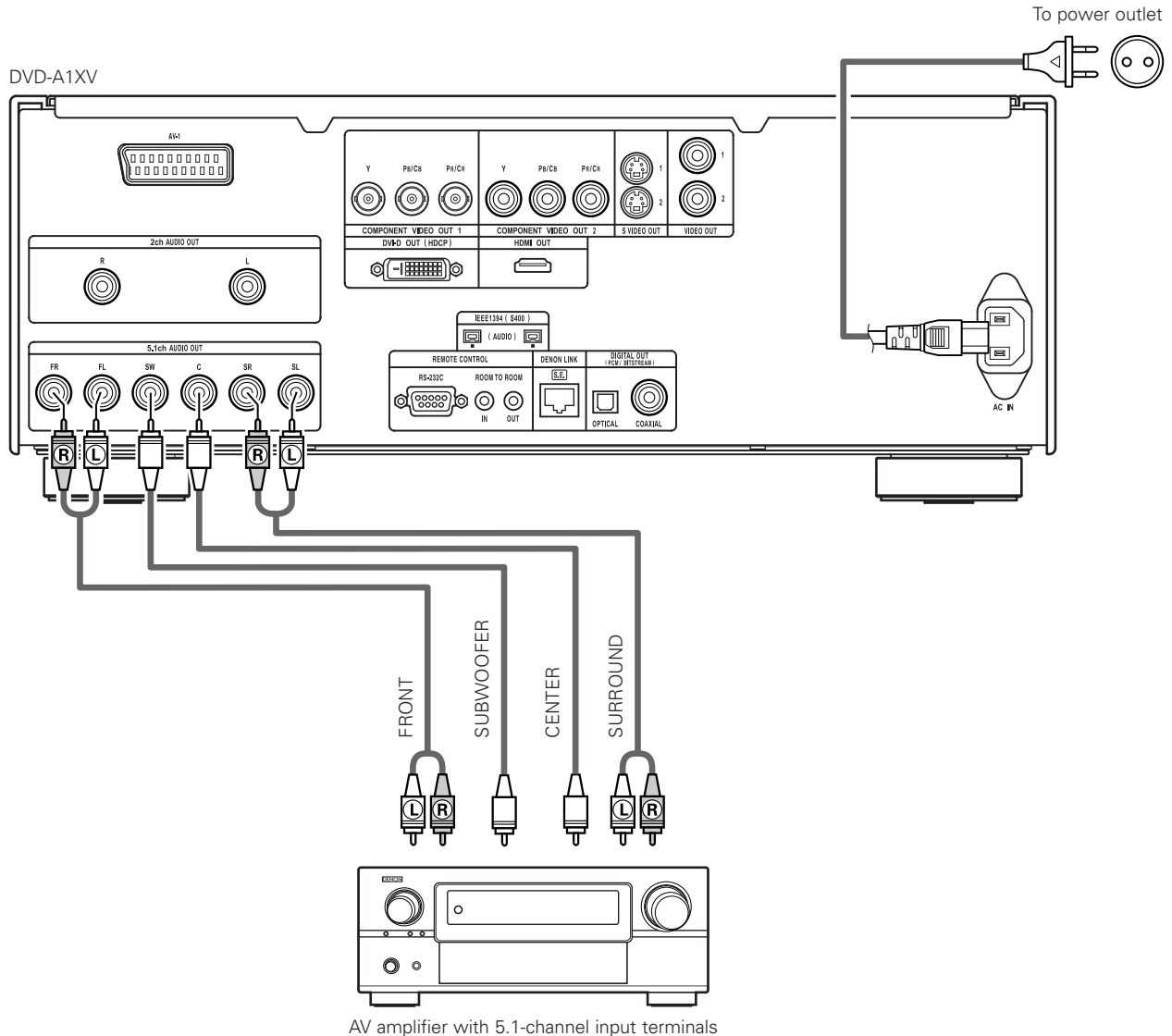

AV amplifier with 5.1-channel input terminals

NOTES:

- For multi-channel connections, set "AUDIO CHANNEL" under "AUDIO SETUP" at "SETUP" to "MULTI CHANNEL" and make the "SPEAKER CONFIGURATION", "CHANNEL LEVEL" and "DELAY TIME" settings. (See pages 46 ~ 51.)
- With the DVD-A1XV, we recommend turning the digital output off by using the "PURE DIRECT MODE" and only outputting analog signals in order to keep interference from the digital output circuitry to a minimum and allow you to enjoy high-quality multi-channel sound thanks to the high-bit, high sampling frequency. (See pages 57, 58.)

(6) Connecting to a Digital Recorder (MD Recorder, DAT Deck, etc.)

* Set the "AUDIO SETUP" default setting as shown below. (See pages 46 ~ 51.)

- "DIGITAL OUTPUT" → "PCM"
- "LPCM (44.1kHz/48kHz)" → "ON"

Playing DVDs with incorrect settings may result noise that could damage your ears or the speakers.

DVD-A1XV

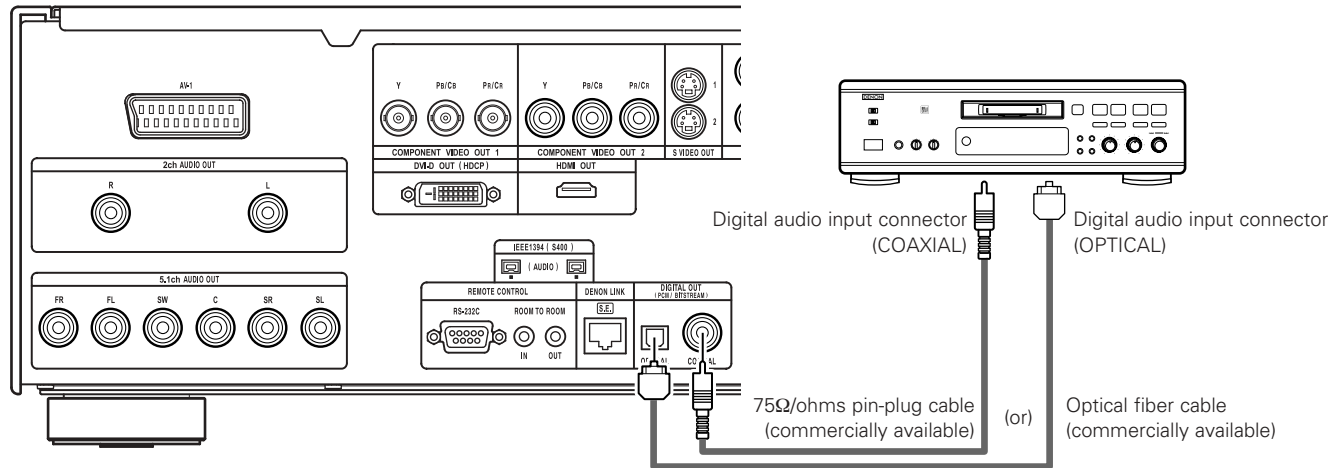

NOTE:

- Digital audio signals cannot be output when playing Super Audio CDs. Use analog connections to record Super Audio CDs.

(7) Connecting to a Stereo Component

DVD-A1XV

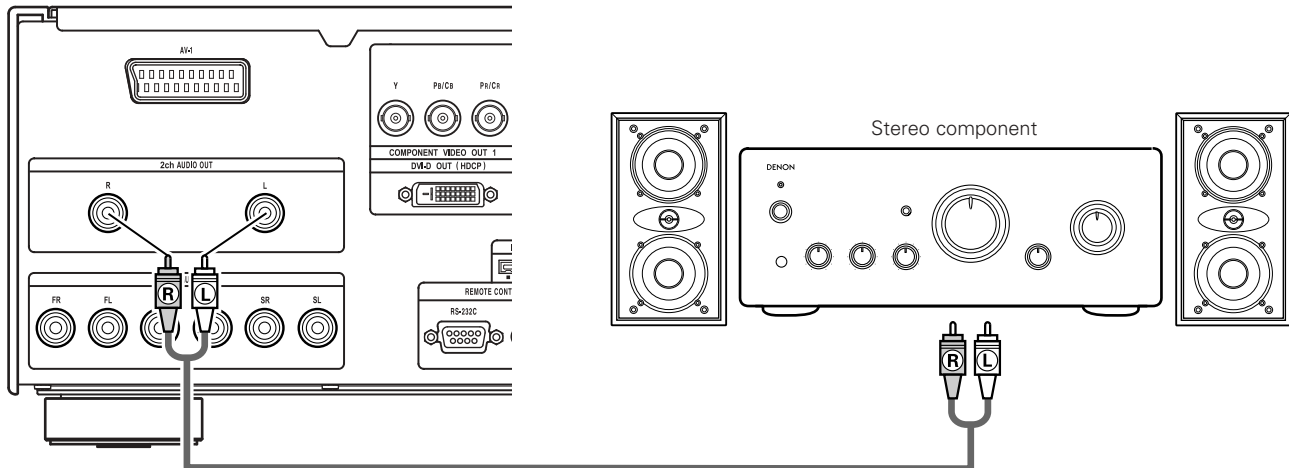

NOTE:

- When connecting to a 2-channel audio stereo device using the "5.1ch AUDIO OUT", set "AUDIO CHANNEL" under "AUDIO SETUP" on the "SETUP" to "2CH (SRS OFF)" or "2CH (SRS ON)" (See pages 46, 47.). For multi-channel sources, the signals are down-mixed into two channels (analog).
(Only the front left and right channels are output for sources for which down-mixing is prohibited.)

(8) DENON LINK connections

High quality digital sound with reduced digital signal transfer loss can be enjoyed by connecting a separately sold DENON LINK compatible AV amplifier.

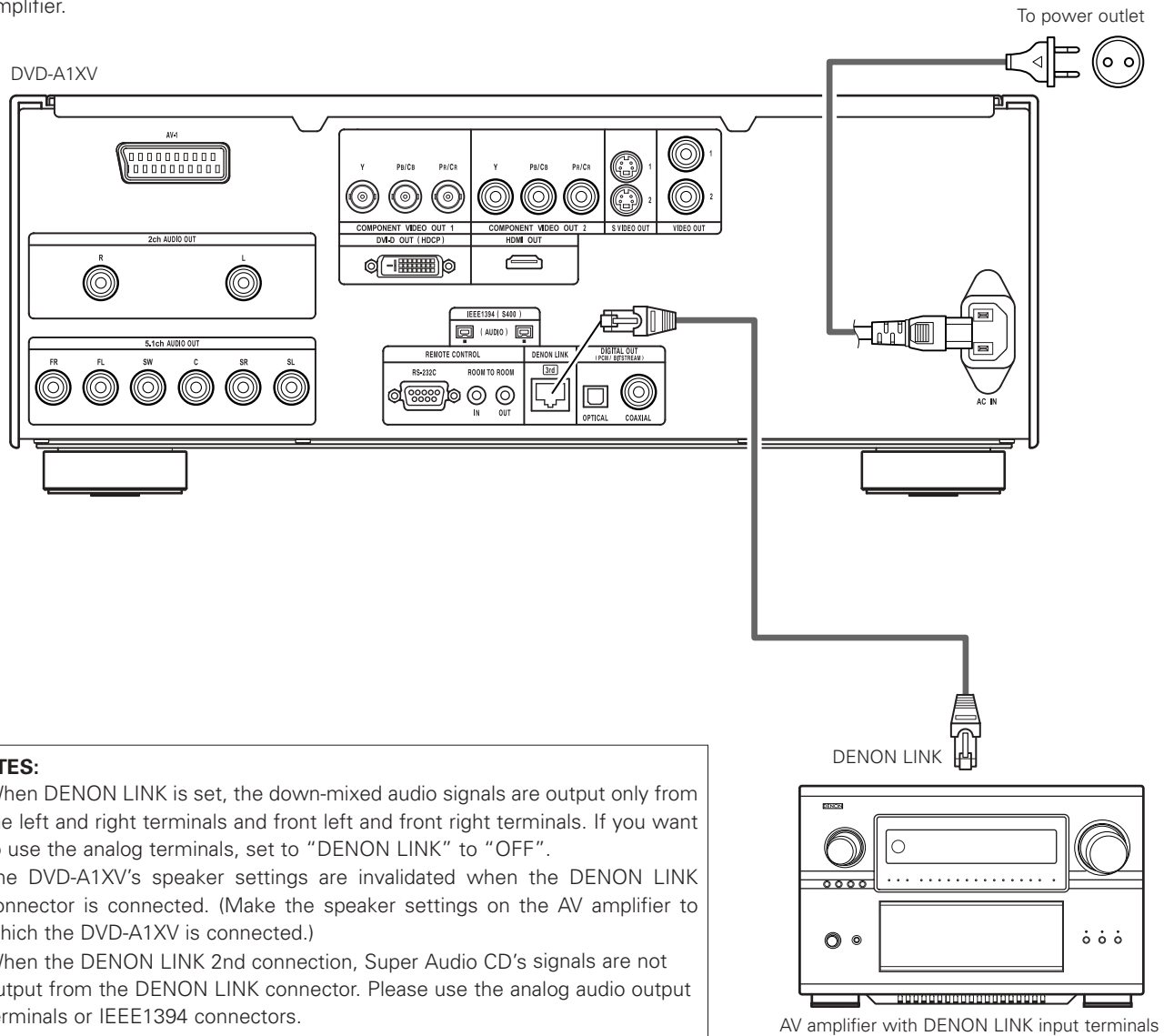

NOTES:

- When DENON LINK is set, the down-mixed audio signals are output only from the left and right terminals and front left and front right terminals. If you want to use the analog terminals, set to "DENON LINK" to "OFF".
- The DVD-A1XV's speaker settings are invalidated when the DENON LINK connector is connected. (Make the speaker settings on the AV amplifier to which the DVD-A1XV is connected.)
- When the DENON LINK 2nd connection, Super Audio CD's signals are not output from the DENON LINK connector. Please use the analog audio output terminals or IEEE1394 connectors.

■ Compatibility with previous equipment

- DENON LINK 3rd Edition uses a different signal format from DENON LINK Second (2nd) Edition. Because of this, the DENON LINK 3rd Edition compatible digital audio signals output from the DVD player can only be played on AV amplifiers that are DENON LINK 3rd Edition compatible. (Playback using DENON LINK 3rd Edition compatible signals is not possible when using a DENON LINK 3rd Edition compatible DVD player together with an AV amplifier that is not DENON LINK 3rd Edition compatible.)

NOTES:

- Note that the sound may not be output or noise may be generated when two devices compatible with different DENON LINK versions are connected. To avoid this, please pay attention to the points below when making the settings.
- When using the DENON LINK connectors, be sure to check the DENON LINK version of your AV amplifier then make the DENON LINK output settings on the DVD-A1XV accordingly.

① If the DENON LINK version of your AV amplifier is 2nd Edition (if "S.E." is indicated next to the connector), the DVD-A1XV can only be used with its DENON LINK output set to "2nd".

② If the DENON LINK version of your AV amplifier is 3rd Edition (if "3rd" is indicated next to the connector), the DVD-A1XV can be used with its DENON LINK output set to either "2nd" or "3rd".

DENON LINK "2nd (AUTO)", "2nd (1394)" and "2nd (ANALOG)" settings:

DVD Video, DVD Audio, CDDA and Video CD audio signals can be transferred.

DENON LINK "3rd" setting:

Super Audio CD, DVD Video, DVD Audio, CDDA and Video CD audio signals can be transferred.

(9) IEEE 1394 connections

The simple connection of one IEEE 1394 cable permits high quality digital transfer of the following between devices having IEEE 1394 connectors: the audio of DVD video, DVD audio that up until now could only be connected by 5-conductor audio cable in an analog connection, or Super Audio CD and other multi-channel audio. (unless DENON LINK connections)

(IEEE 1394 is an international standard established by the Institute of Electrical and Electronics Engineers, Inc. of the U.S.)

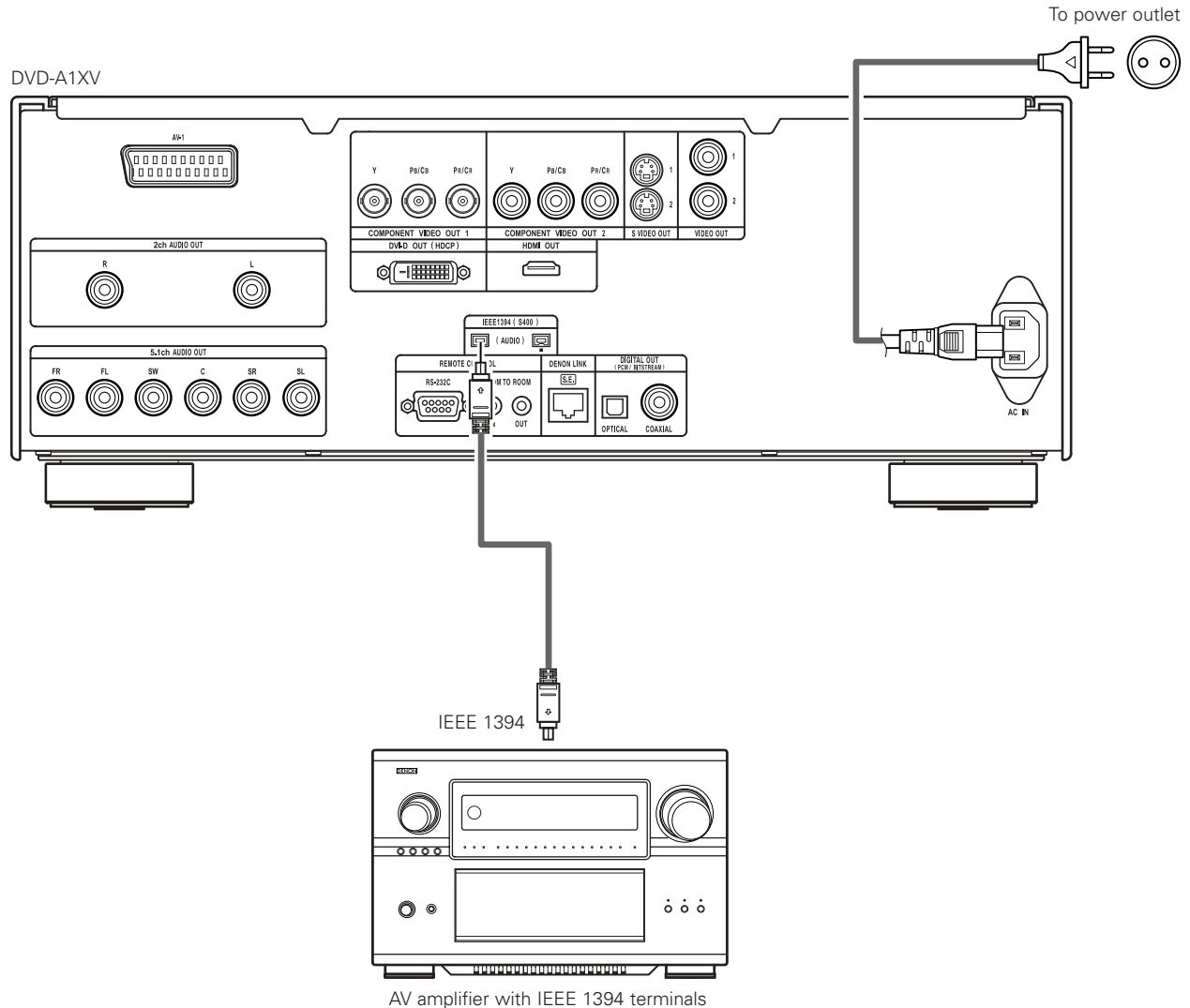

■ IEEE1394 settings:

- For IEEE1394 connection, set "IEEE1394" under "DIGITAL INTERFACE SETUP" at "SETUP" to "ON". (See pages 38 ~ 42.)

* The DVD-A1XV's IEEE 1394 mode is designed based on IEEE Std. 1394a-2000, Standard for a High Performance Serial Bus.

* IEEE 1394 network

The following types of connections can be made between devices handling IEEE 1394 audio signals (A&M protocol):

① Daisy chain connections

Connect the sets in series using a single IEEE 1394 cord. Up to 15 sets can be connected.

② Tree (tower) connections

Connect the sets in parallel and in series using a single IEEE 1394 cord. Up to 63 sets can be connected.

Copyright Protection System

To play back through an IEEE 1394 connection the audio of Super Audio CD or DVD (except for discs that may be copied freely), both the player and the amplifier are required to support a copyright protection system called DTCP (Digital Transmission Content Protection). DTCP is copy protection technology comprising data encryption and the authentication of the remote device. This unit supports DTCP. Please see the operation manual of your amplifier for information about your amplifier.

NOTES:

- Please use the included IEEE 1394 cable. When using a cable other than the included IEEE 1394 cable, please use a 4-pin IEEE 1394 cable with a length of 3.5 m or less for S400 or higher.
 - The "IEEE 1394 audio signal (A&M protocol)" output from the DVD-A1XV's IEEE 1394 connector not out video signals, please connecting to a TV or Monitor with "component video output" or "S-video output" or "Video output". (See pages 12 ~ 14.)
 - The "IEEE 1394 audio signal (A&M protocol)" output from the DVD-A1XV's IEEE 1394 connector can only be received on AV equipment equipped with an IEEE 1394 connector. Digital video (DV), personal computer, and i-Link (a Sony trademark) audio signals cannot be sent and received. Incorrect connections could lead to malfunction. Connect as instructed in the other device's operating manual. Note that there is no guarantee of the operation of the connection even between devices supporting IEEE 1394. Whether or not data and control signals can be transmitted and received between devices supporting IEEE 1394 depends on the functions of the respective devices.
 - When connecting using the IEEE 1394 connector, only connect one cord between the two devices. Never connect two cords between the two devices (loop connection). If this is done, the signal output from one device will return to the same device, resulting in malfunction.
 - No audio signals are output from the DVD-A1XV's analog audio connectors, digital audio connectors, DENON LINK and HDMI connector when IEEE 1394 is set.
To use these connectors, set the IEEE 1394 setting to "OFF".
 - When the IEEE 1394 connector is connected, the DVD-A1XV's speaker settings are disabled.
 - During playback of a device supporting IEEE 1394, please do not disconnect the IEEE 1394 cable of the other device, do not connect a new device, and do not switch the power on or off. Doing so may interrupt the audio.
 - Among the devices that support IEEE 1394, when the power is in the standby mode or off, some devices are not able to relay data. Please see the operation manual of the connected device that supports IEEE 1394. This unit is not able to relay the IEEE 1394 data while in the standby mode.
 - Devices that support IEEE 1394 have the maximum data transfer speed supported by that device marked in the vicinity of the IEEE 1394 connector. The maximum transfer speed of IEEE 1394 is defined as approximately 100/200/400 Mbps*, with 200 Mbps items having S200 inscribed and 400 Mbps items having S400 inscribed. The maximum IEEE 1394 data transfer speed of this unit is 400 Mbps. The actual transfer speed may be slower than 400 Mbps when S100 or S200 devices are connected, or depending on the specifications of the device. Try to ensure that connections are made between devices that have the same maximum data transfer speed.
- * Mbps (Mega bps) is an abbreviation of "Mega bits per second" and indicates the volume of data that can be communicated in 1 second. At 400 Mbps, 400 Mega bits of data is transferred in 1 second.

(10) HDMI connections

A simple 1-cable connection (using a commercially available cable) with a device having an HDMI (High-Definition Multimedia Interface) connector allows digital transfer of the digital images of and other sources, and the multi-channel sound of DVD video and DVD audio. The DVD-A1XV is compatible with High-Definition Multimedia Interface (HDMI) Specification Version 1.1. (The multi-channel audio signals of DVD audio discs can be transferred.) Use Type-A cables that have received HDMI certification for connections to the DVD-A1XV. For stable signal transfer, we recommend using cables that are a maximum of 5 meters in length.

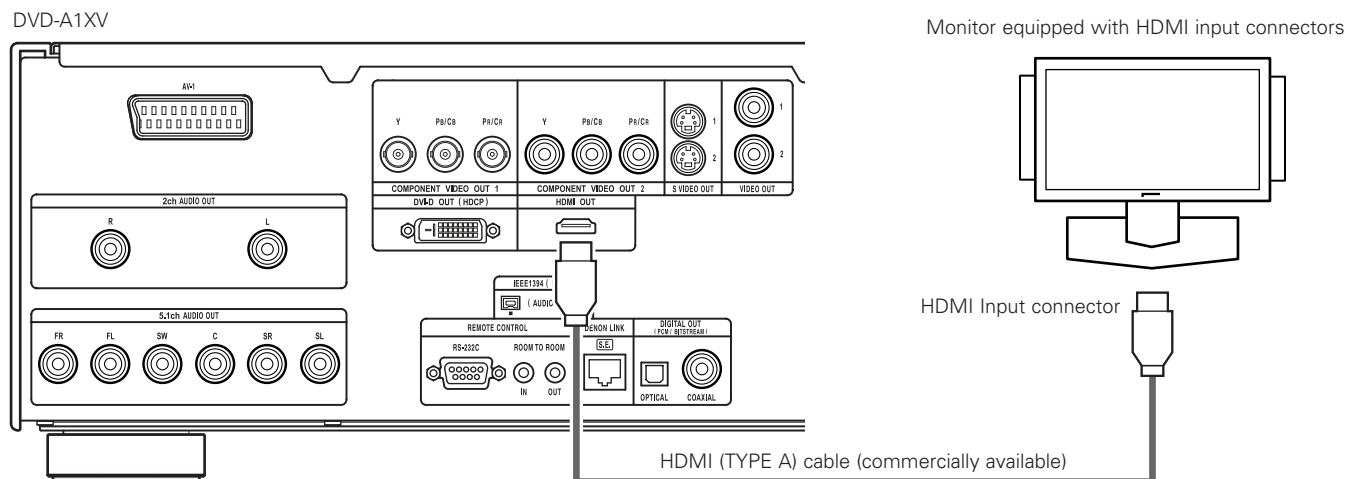

HDMI settings

- When using HDMI connections, use the HDMI/DVI SELECT button on the main unit or the remote control unit to set "HDMI Y Cb Cr" or "HDMI R G B". (See page 63. By default, this setting is set to "HDMI/DVI OFF".)

Video settings

- Set to "480P/576P" upon shipment from the factory. Can be set manually to change the resolution. Use the HDMI/DVI FORMAT button on the main unit or the remote control unit to set the resolution to 480P/576P, 720P or 1080i according to the connected monitor.

Also, when set to "AUTO", the resolution of the connected HDMI device is detected and the resolution is set automatically.

Audio settings

- When connecting another device with the HDMI connector, make the "HDMI AUDIO SETUP" under "DIGITAL INTERFACE SETUP" on the "SETUP" according to the specifications of the device or monitor to be connected. (See pages 38 ~ 41.)

| Device to be connected | HDMI AUDIO SETUP | HDMI audio |
|---|------------------|---|
| HDMI compatible monitor, projector etc. (2-channel audio compatible or non-audio compatible) | 2 CH | Video signals and 2-channel PCM audio signals are output via the HDMI connector. When connecting to an AV amplifier with DENON LINK/IEEE1394 or multi-channel analog audio, set to "2CH". |
| HDMI compatible AV amplifier, monitor, etc. (with Dolby Digital/DTS decoder) | MULTI (NORMAL) | Video signals and Dolby Digital/DTS bitstream signals are output via the HDMI connector. Make the speaker settings on the connected AV amplifier, etc. |
| HDMI compatible monitor, etc. (without Dolby Digital/DTS decoder, with multi-channel audio compatibility) | MULTI (LPCM) | Video signals and Dolby Digital/DTS bitstream signals converted into multi-channel PCM signals are output via the HDMI connector. Make the speaker settings at "HDMI AUDIO SETUP" at SETUP. |

* When set to DENON LINK and IEEE1394, switch the "HDMI AUDIO SETUP" setting to "2CH".

* When the setting for outputting audio signals from the IEEE1394 connector is made, no audio signals are output via the HDMI connector.

* When "MULTI (NORMAL)" "MULTI (LPCM)" is set, analog audio signals are only output from the L/R and FL/FR terminals. (The signals from the FL/FR terminals are down-mixed audio signals.)

* With Super Audio CDs, digital audio signals in areas except for the CD layer are not output via the HDMI connector. To play multi-channel/stereo area signals, set the "HDMI AUDIO SETUP" setting to "2CH" and use the analog audio or IEEE1394.

NOTES:

- The HDMI video and audio output are both turned off if the video output is set to "OFF" or if "ALL OFF" is set. (See Pages 57, 58.)
- When selecting MULTI (NORMAL), the DVD-A1XV speaker settings under "AUDIO SETUP" become invalid.
- Among the devices that support HDMI, some devices can control other devices via the HDMI connector; however, the DVD-A1XV cannot be controlled by another device via the HDMI connector.
- When using display equipment that is not supported by the HDCP (content protection function), the image will not be output properly.
- The audio signals via the HDMI connector (including the sampling frequency and bit length) may be limited by the equipment that is connected.
- When using devices not compatible with HDMI specification Ver. 1.1, the audio signals of DVD audio discs copyright-protected by CPPM are not output via the HDMI connector.

(11) DVI-D connections

Connection with equipment that has a DVI (Digital Visual Interface)-D connector permits the transfer of digital images.

- * When using display equipment that is not supported by the HDCP (content protection function), the image will not be output properly.
- * Make an audio connection also because an audio signal will not be output via the DVI-D connector.
- * Commercially DVI cables are available in 24-pin and 29-pin types. The DVD-A1XV supports the 24-pin DVI-D cable, but the 29-pin DVI cable cannot be connected.

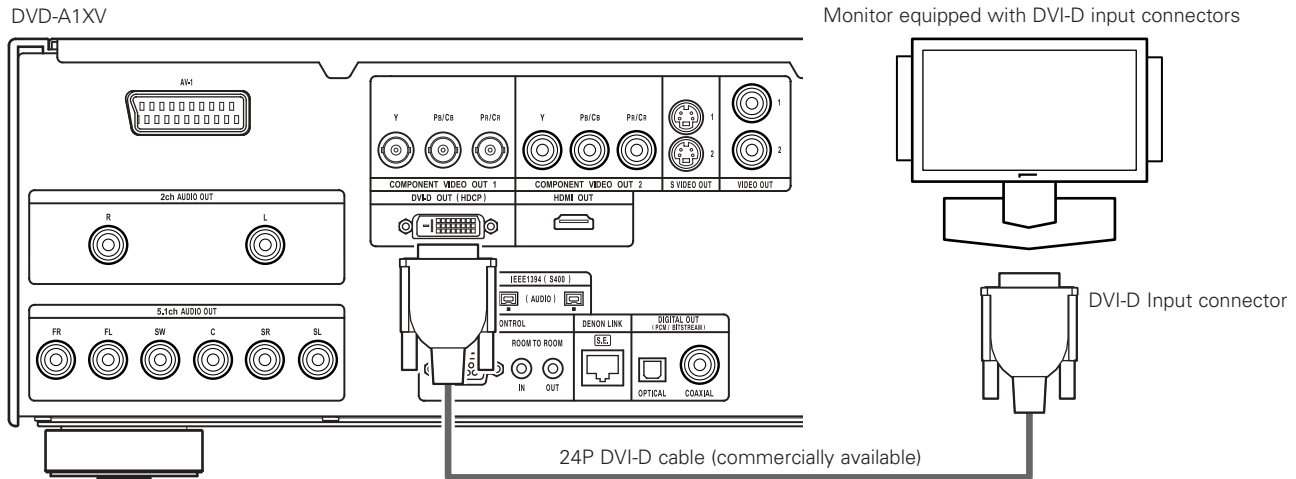

DVI-D Settings

- When using DVI-D connections, use the HDMI/DVI SELECT button on the main unit or the remote control unit to set “HDMI Y Cb Cr” or “HDMI R G B”. (See “HDMI/DVI SELECT” on page 63. By default, this setting is set to “HDMI/DVI OFF”.)
- * Signals are output via the DVI-D connector in RGB format, regardless of whether “HDMI Y Cb Cr” or “HDMI R G B” is set.

When connecting both the HDMI and DVI-D connectors to monitors

- Video signals with the same resolution are output via the HDMI and DVI-D connectors.
 - When monitors are connected to both the HDMI and DVI-D connectors in the AUTO mode, the resolution is set automatically according to the connected devices. (See “HDMI/DVI FORMAT” on page 63.)
 - ① When two HDMI devices are connected (an HDMI-DVI conversion cable is required)
The resolutions of the two HDMI devices are detected automatically, the lowest resolution is selected and the signals are output with that resolution.
 - ② When one HDMI and one DVI device are connected
The resolution is set to “480P/576P”.
 - ③ When two DVI devices are connected (an HDMI-DVI conversion cable is required)
The resolution is set to “480P/576P”.
- It is also possible to set the resolution manually. Use the HDMI/DVI FORMAT button on the main unit or the remote control unit to set the resolution to “480P/576P”, “720P” or “1080i” according to the resolution of the connected device.
- Select the HDMI output format, either the Y Cb Cr or the RGB format. Use the HDMI/DVI SELECT button on the main unit or the remote control unit to make the setting. The DVI-D output is set to the RGB format regardless of the HDMI setting. (See page 63.)

Connecting an HDMI-DVI conversion cable

- When connecting to a monitor using a commercially available HDMI-DVI conversion cable, no audio signals are output.
- When connected to a DVI-D compatible monitor, the output is automatically switched to RGB.
- For stable signal transfer, we recommend using cables that are a maximum of 5 meters in length.

| | Video | Audio | |
|---|-------|-------|---|
| HDMI connector → DVI-D compatible monitor | ○ | x | Switches automatically to RGB. |
| DVI-D connector → HDMI compatible monitor | ○ | x | Output via DVI-D connector in RGB format. |

Copyright Protection System

To play the digital images and sounds of DVD video or DVD audio via an HDMI/DVI-D connection, it is necessary that both the player and monitor (or AV amplifier) support a copyright protection system called HDCP (High-bandwidth Digital Content Protection System). HDCP is copy protection technology that comprises data encryption and authentication of the partner equipment. The DVD-A1XV supports HDCP. Please see the user’s manual of your monitor (or AV amplifier) for information about this.

5 PART NAMES AND FUNCTIONS

(1) Front Panel

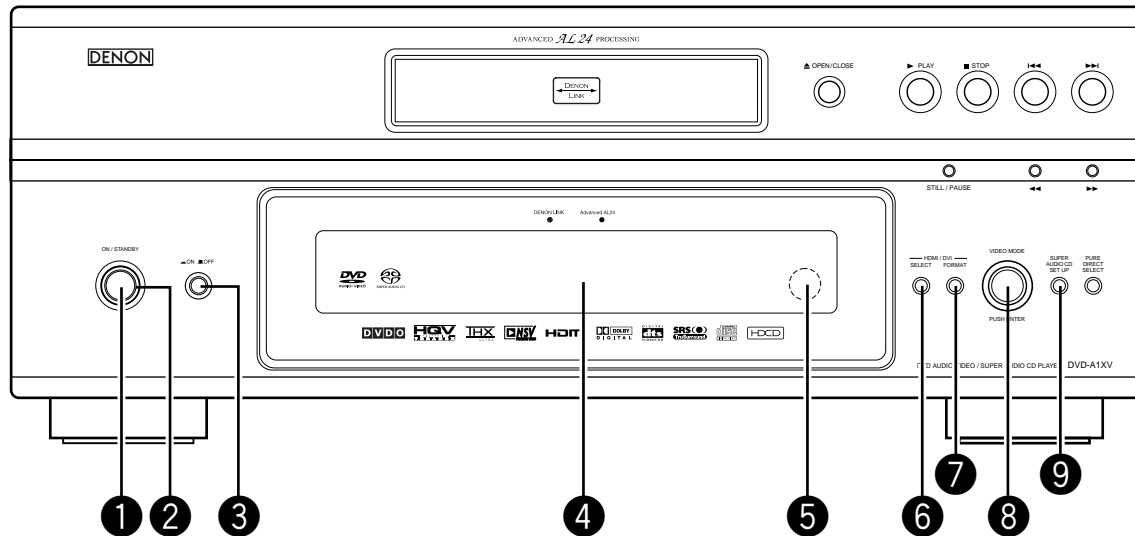

1 Power ON/STANDBY button

- Press once to set to the standby mode. The indicator lights up in red.
- Press again to turn the power on. The indicator lights up in green.

2 Power indicator

- This indicator lights when the power is on and when the power is in the standby mode.
Light green: Power is on
Light red : Power is in the standby mode

3 Power switch

- Press once to turn the power on.
- Press again to set to the "OFF" position and turn the power off.

4 Display

- Information on the disc that is currently playing is shown on the display. (See page 26.)

5 Remote control sensor

6 SELECT of HDMI/DVI button

- Press this to set the video signal output via the HDMI/DVI connector. (See page 63.)

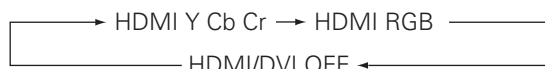

7 FORMAT of HDMI/DVI button

- Press this to set the video signal format via the HDMI connector or the DVI connector. (See page 63.)



8 VIDEO MODE button

- Use this to instantly change the adjustment mode of the stored video signals. (See page 63.)
- ※ The setting values of PICTURE MODE and SQUEEZE MODE will not be stored.
The unit will return to the stored setting values when the power is switched off.

- PICTURE MODE

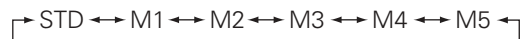

- TV SYSTEM

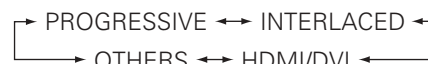

- SQUEEZE MODE

- ※ No effective for interlaced image.



- AUDIO ADJUST



9 Select the playback area/layer of SUPER AUDIO CD (SUPER AUDIO CD SETUP)

- Switch the area /layer of the Super audio CDs played with priority.
- MULTI.....When playing Super audio CDs, the Multi channel area is played with priority
- STEREO....When playing Super audio CDs, the stereo channel area is played with priority.
- CD.....When playing Super audio CDs, the CDs layer is played with priority.



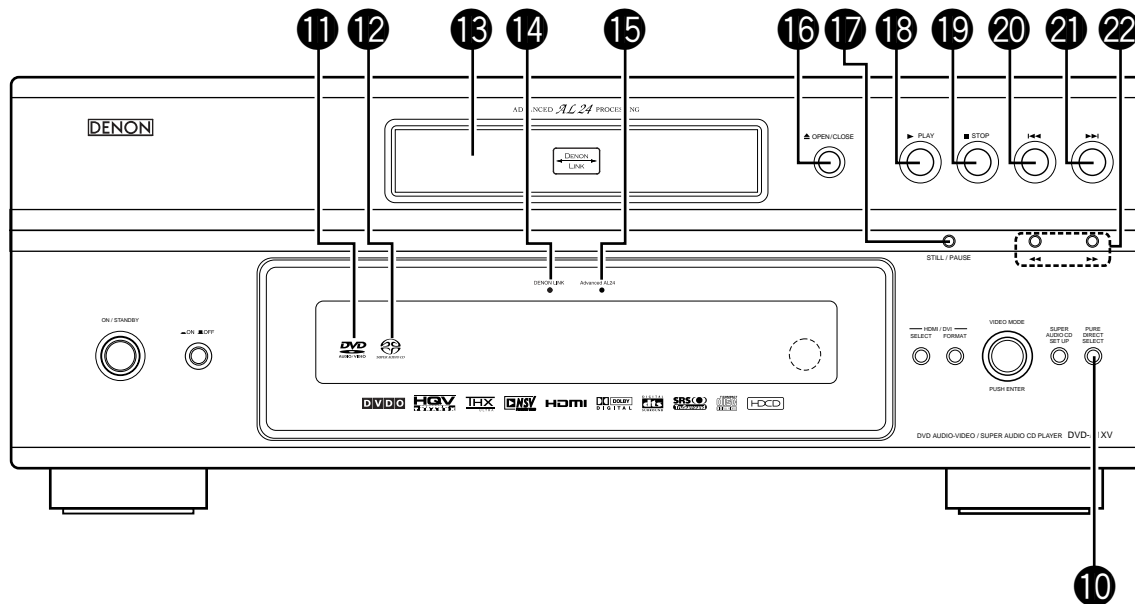

10 PURE DIRECT SELECT button

- Press to switch the modes with the specific video signals, digital audio signals and indicate in display on and off. (See pages 57, 58.)

→NORMAL→ MODE 1→ MODE 2→ ALL OFF→

11 DVD AUDIO/VIDEO indicator

- This indicator lights when playing the DVD audio or DVD video.

12 Super Audio CD indicator

- This indicator lights when playing the Super Audio CD.

13 Disc tray

- Load discs here. (See page 30.)
- Press the OPEN/CLOSE button 16 to open and close the disc tray.
- The disc tray is also closed when the PLAY button 18 is pressed.

14 DENON LINK indicator

- This indicator lights when the audio signals are transferred by DENON LINK connections.

15 Advanced AL24 Processing indicator

- This indicator lights when the audio signals of a DVD, etc., are being processed digitally with the Advanced AL24 processing.

16 OPEN/CLOSE button (▲)

- Press this to open and close the disc tray. (See pages 30, 66.)

17 STILL/PAUSE button (||)

- Press this to pause images or music or to play images frame by frame. (See page 68, 69.)

18 PLAY button (▶)

- Press this to play the disc. (See page 67.)

19 STOP button (■)

- Press this to stop the disc. (See page 68.)

20 Skip button (I◀◀)

- Press this to move back to the beginning of the current track (or chapter).
- Press again to move back to the beginning to the previous track (or chapter). (See page 69.)

21 Skip button (▶▶I)

- Press this to move ahead to the beginning of the next track (or chapter). (See page 69.)

22 Slow/Search buttons (◀◀ ▶▶)

- Press this to set the slow or search play mode. (See pages 68, 69.)
- ◀◀: search in the reverse direction.
- ▶▶: search in the forward direction.

(2) Rear Panel

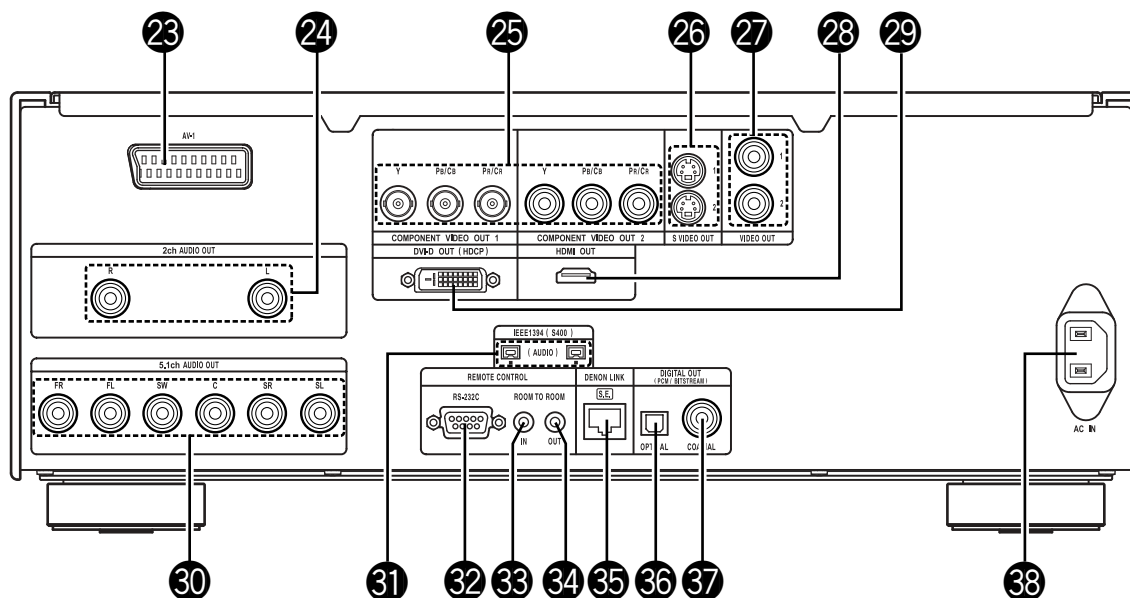

- 23 21-pin SCART terminal (AV1)**
- Connect using a 21-pin SCART cable (available in stores).
- 24 Audio output connectors (2ch AUDIO OUT)**
- Connect using the included audio cord.
Multi-channel sound is down-mixed and output.
- 25 Component video output connectors (COMPONENT VIDEO OUT)**
- Connect using video cords (available in stores).
- 26 S-Video output connector (S-VIDEO OUT)**
- Connect using an S-Video connection cord (available in stores).
- 27 Video output connector (VIDEO OUT)**
- Connect using the included video cord.
- 28 HDMI output connector (HDMI)**
- Connect using HDMI (TYPE A) connection cord (available in stores).
- 29 DVI-D-Video output connector (DVI-D OUT)**
- Connect using 24P DVI-D connection cord (available in stores).
- 30 Audio output connectors (5.1ch AUDIO OUT)**
- Connect using an audio cord. Connect a commercially available pin-plug cord.
- 31 Digital connectors (IEEE 1394)**
- This is for connection of a separately sold AV amplifier equipped with a IEEE 1394 connector.
 - Use it to achieve high quality digital sound with low data loss.
- 32 Control connector (RS-232C)**
- This is a terminal for future system expansion.
- 33 Control input connector (ROOM TO ROOM IN)**
- This is the input connector for wired remote control.
Consult your DENON dealer if you wish to use this connector.
- 34 Control output connector (ROOM TO ROOM OUT)**
- This is the output connector for wired remote control.
Consult your DENON dealer if you wish to use this connector.
- 35 Digital output connector (DENON LINK)**
- This is for connection of a separately sold AV amplifier equipped with a DENON LINK connector.
 - Use it to achieve high quality digital sound with low data loss.
- 36 Digital audio output connector (OPTICAL)**
- Connect using an optical fiber cable (available in stores).
 - Digital data is output from this connector.
- 37 Digital audio output connector (COAXIAL)**
- Connect using a digital audio cord. Connect a commercially available 75 Ω/ohms pin-plug cord.
 - Digital data is output from this connector.
- 38 Power input (AC IN)**
- Connect to AC power supply using the included power supply cord.

(3) Display

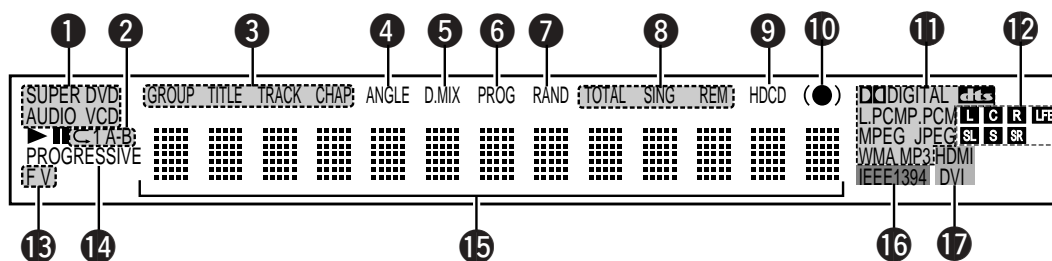

- ❶ Lights to indicate the currently playing disc.
- ❷ Lights in the repeat play mode.
- ❸ These light to indicate the names of sections of the disc being played.
- ❹ Lights during playback of multiple angles disc.
- ❺ Lights when the audio signals can be down-mixed.
- ❻ Lights in the programmed play mode.
- ❼ Lights in the random play mode.
- ❽ There light to indicate the time display mode.
- ❾ Lights when HDCD is playing.
- ❿ Lights when SRS TruSurround is on.
- ⓫ Lights to indicate the currently playing audio format.
- ⓬ Lights to indicate the currently playing audio.
L : Front left channel
C : Center channel
R : Front right channel
SL : Surround left channel
S : Mono surround channel
SR : Surround right channel
LFE : Low frequency effect
- ⓭ Lights to indicate the currently playing video type.
F :Film source
V :Video source
- ⓮ Lights when progressive video signals are being output.
- ⓯ Displays the title , track number and elapsed time during playback.
- ⓰ Lights when the audio signals is output from IEEE1394 terminals.
- ⓱ Lights when the video (or audio) signals is output via HDMI or DVI connectors.
(Flashes while the connection to the HDMI/DVI-D connector is being checked.)

6 REMOTE CONTROL UNIT

■ The DVD-A1XV can be controlled from a distance using the included remote control unit (RC-993).

(1) Inserting Batteries

① Remove the remote control unit's rear cover.

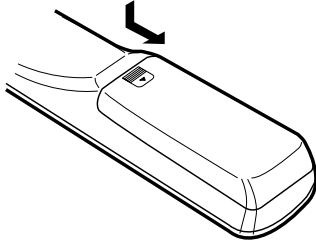

② Place three R6P/AA batteries in the battery compartment in the direction indicated by the marks.

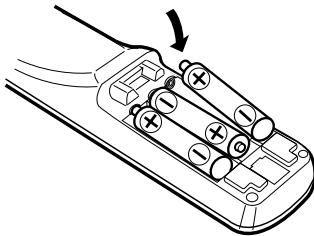

③ Close the rear cover.

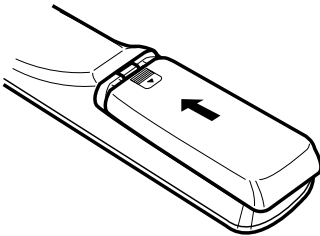

Cautions On Batteries

- Use R6P/AA batteries in this remote control unit.
- Replace the batteries with new ones approximately once a year, though this depends on the frequency with which the remote control unit is used.
- If the remote control unit does not operate from close to the main unit, replace the batteries with new ones, even if less than a year has passed.
- The included battery is only for verifying operation. Replace it with a new battery as soon as possible.
- When inserting the batteries, be careful to do so in the proper direction, following the ⊕ and ⊖ marks in the remote control unit's battery compartment.
- To prevent damage or battery fluid leakage:
 - Do not use a new battery with an old one.
 - Do not use two different types of batteries.
 - Do not short-circuit, disassemble, heat or dispose of batteries in flames.
- Remove the batteries when not planning to use the remote control unit for a long period of time.
- If the batteries should leak, carefully wipe off the fluid from the inside of the battery compartment, then insert new batteries.

(2) Using the Remote Control Unit

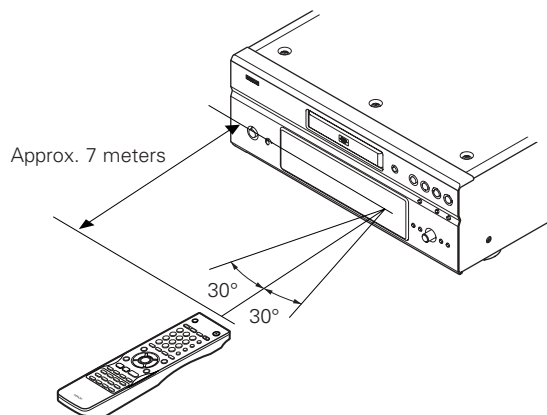

- When operating the remote control unit, point it at the remote control sensor as shown on the diagram.
- The remote control unit can be used from a direct distance of approximately 7 meters. This distance will be shorter, however, if there are obstacles in the way or if the remote control unit is not pointed directly at the remote control sensor.
- The remote control unit can be operated at a horizontal angle of up to 30° with respect to the remote control sensor.

NOTES:

- It may be difficult to operate the remote control unit if the remote control sensor is exposed to direct sunlight or strong artificial light.
- Do not press buttons on the main unit and on the remote control unit at the same time. Doing so will result in malfunction.

(3) Names and Functions of Remote Control Unit Buttons

■ Button not explained here function in the same way as the corresponding buttons on the main unit.

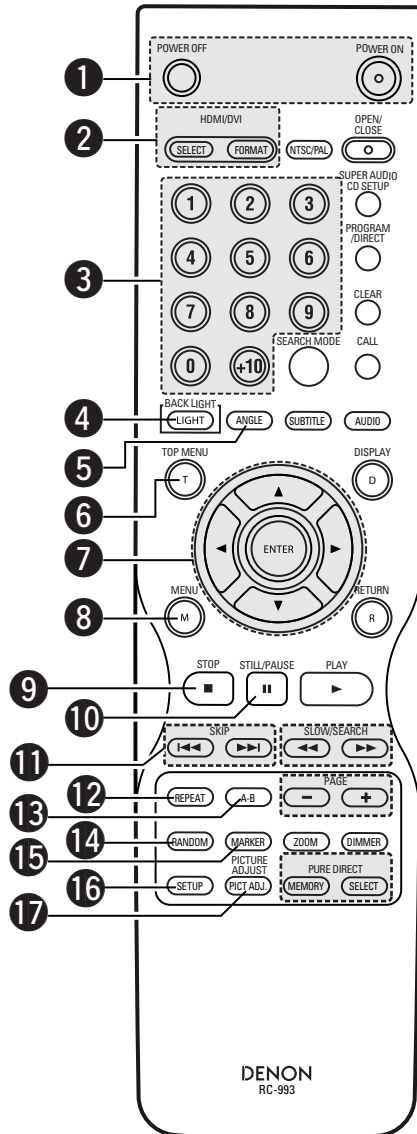

- 1 POWER ON/POWER OFF buttons**
 - Press this to switch the power between on and standby.
- 2 HDMI/DVI SELECT/FORMAT buttons**
 - Use these to select to use HDMI connector or DVI connector, and the format of video signals (480P/576P, 720P, 1080i, AUTO).
- 3 Number buttons**
 - Use these to input numbers.
 - Use the +10 button to input numbers of 10 or over.
 - Example : To input 25
- 4 LIGHT button**
 - Press this to light the all buttons.
 - Press again this to put out light.
- 5 ANGLE button**
 - Press this to switch the angle.
- 6 TOP MENU button**
 - The top menu stored on the disc is displayed.
- 7 Cursor buttons/ENTER button**
 - Use the ▲ and ▼ cursor buttons to select in the vertical direction.
 - Use the ◀ and ▶ cursor buttons to select in the horizontal direction.
 - Press the ENTER button to select the item selected with the cursor buttons.
- 8 MENU button**
 - The DVD menu stored on the disc is displayed.
- 9 STOP button (■)**
- 10 STILL/PAUSE button (||)**
- 11 SKIP buttons**
- 12 REPEAT button**
 - Press this to play tracks repeatedly.
- 13 A-B repeat button (A-B)**
 - Use this to repeat sections between two specific points.
- 14 RANDOM button**
 - Press this to play the tracks on the video or music CD in random order.
- 15 MARKER button**
 - Press this to mark places you want to see again.
- 16 SETUP button**
 - Press this to display the default setting screen.
- 17 PICTURE ADJUST button**
 - Press this to adjust the picture quality to suit your tastes.

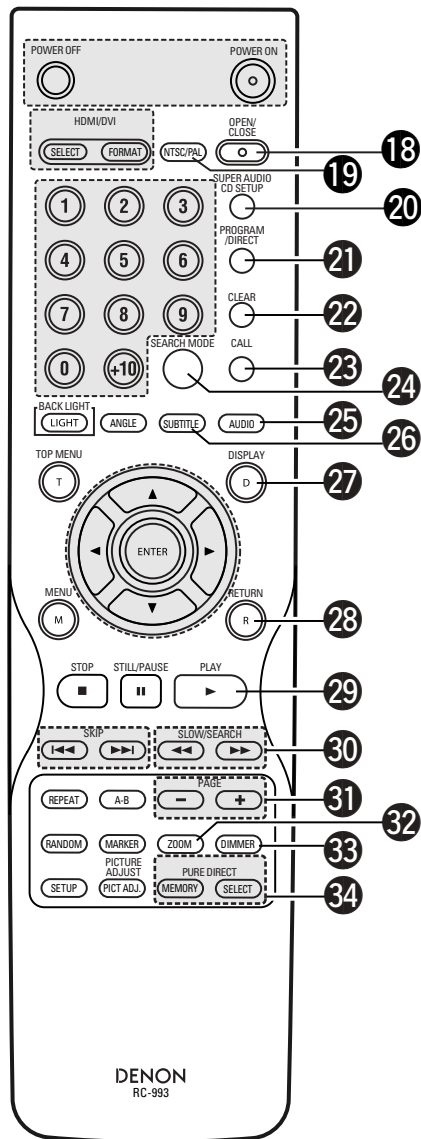

- 18 OPEN/CLOSE button**
- 19 NTSC/PAL button**
 - Use this to switch the set's video output format (NTSC/PAL).
- 20 SUPER AUDIO CD SETUP button**
- 21 PROGRAM/DIRECT button**
- 22 CLEAR button**
 - Press this to clear numbers that you have input.
- 23 CALL button**
 - Press this to check the program contents.
- 24 SEARCH MODE button**
 - Press this to change the search mode to search for groups or titles, tracks or chapters when selecting sections of discs directly using the number buttons.
- 25 AUDIO button**
 - For DVDs, press this to switch the audio language. For video CDs, press this to switch the channel between "STEREO", "MONO LEFT" and "MONO RIGHT".
- 26 SUBTITLE button**
 - Press this to switch the DVD's subtitle language.
- 27 DISPLAY button**
 - Press this to display the ON-SCREEN.
- 28 RETURN button**
 - Press this to return to the previous menu screen.
- 29 PLAY button (▶)**
- 30 SLOW/SEARCH buttons**
- 31 PAGE -/PAGE + buttons**
 - Use these to selected the desired still picture on DVD audio discs containing browseable still pictures.
- 32 ZOOM button**
 - Press this to enlarge the image.
- 33 DIMMER button**
 - Use this to adjust the brightness of the main unit's display. Can be switched in 4 steps, from all off to always on.
- 34 PURE DIRECT MEMORY/SELECT buttons**
 - Use these to make and select that various setting to achieve higher quality sound.

7 LOADING DISCS

- Set discs in the disc tray with the labeled (printed) side facing up.

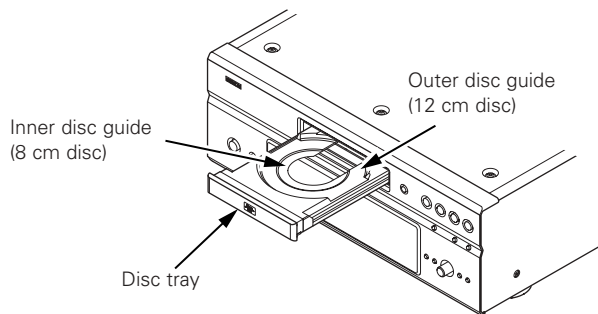

NOTE:

- Do not move the DVD-A1XV while a disc is playing. Doing so may scratch the disc.

(1) Opening and Closing the Disc Tray

- ① Turn on the power.
- ② Press the OPEN/CLOSE button.

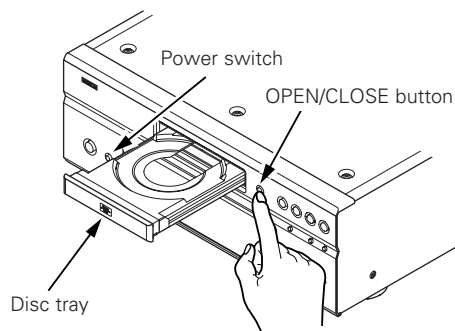

NOTES:

- Be sure to turn on the power before opening and closing the disc tray.
- Do not strike on the button with a pencil, etc.

(2) Loading Discs

- Pick up the disc carefully so as not to touch the signal surface and hold it with the labeled side facing up.
- With the disc tray fully open, set the disc in the disc tray.
- Set 12 cm discs in the outer disc guide (Figure 1), 8 cm discs in the inner disc guide (Figure 2).
- Press the OPEN/CLOSE button. The disc is automatically loaded.
- The disc tray can also be closed automatically to load the disc by pressing the PLAY button.

Figure 1

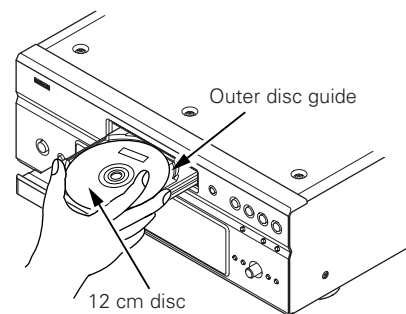
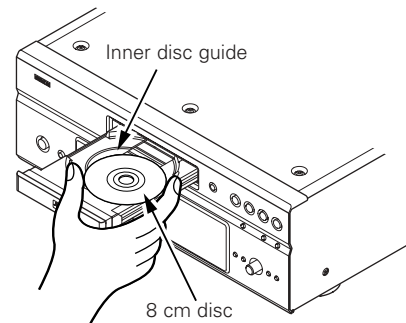

Figure 2







NOTES:

- If a foreign object is caught in the disc tray during closing, simply press the OPEN/CLOSE button again and the tray will open.
- Do not press the disc tray in by hand when the power is off. Doing so will damage it.
- Do not place foreign objects in the disc tray. Doing so will damage it.

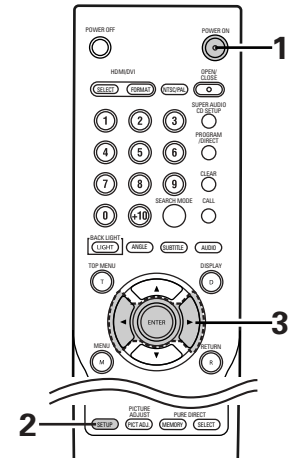
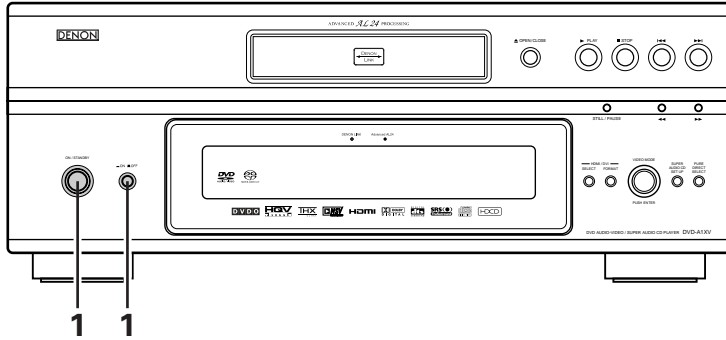
8 CHANGING THE DEFAULT SETTINGS

- Make the initial settings to suit your usage conditions before starting playback.
The initial settings are retained until they are next changed, even if the power is turned off.



| | | |
|----------|---|--|
| 1 | <p>Turn on the power.</p> <ul style="list-style-type: none"> Press the power button, the power indicator lights green and the power turns on. When pressed again, the power turns off and indicator is off. In the standby mode (the power indicator lights red), press the ON/STANDBY button on the main unit or POWER ON button on the remote control unit (RC-993). | <p>(Green) ON / STANDBY</p>   <p>Main unit</p> <p>(Red) ON / STANDBY</p>   <p>Main unit</p> <p>Remote control unit</p> |
|----------|---|--|

2

In the stop mode, press the SETUP button.

- The setup (default settings) screen appears.

NOTE: For some menus, the initial values can be changed during playback.

LANGUAGE SETUP

Use this to set the language to be used when playing the disc. If the set language is not offered on that disc, the disc's default language is set. And use this to set the language for the default setting screen and messages displayed on the TV screen ("PLAY", etc.).

DIGITAL INTERFACE SETUP

Use this to set the output of DVI, HDMI, DENON LINK and IEEE1394 terminals.

VIDEO SETUP

Use this to set the DVD-A1XV's screen mode.

AUDIO SETUP

Use this to set the DVD-A1XV's audio output mode.

RATINGS

Use this to disable playback of adult DVDs so that children cannot watch them. Note that playback of adult DVDs cannot be disabled if the rating level is not recorded on the DVD.

OTHER SETUP

These include special settings such as CAPTIONS, WALL PAPER, etc.,.



Remote control unit



3

Use the ◀ and ▶ cursor buttons to select the desired setting item, then press the ENTER button.

- Select "LANGUAGE SETUP". (See pages 35 ~ 37.)
- Select "DIGITAL INTERFACE SETUP". (See pages 38 ~ 42.)
- Select "VIDEO SETUP". (See pages 43 ~ 45.)
- Select "AUDIO SETUP". (See pages 46 ~ 51.)
- Select "RATINGS". (See pages 52, 53.)
- Select "OTHER SETUP". (See pages 54 ~ 56.)

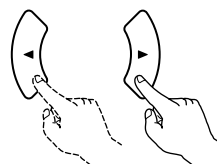

Remote control unit



Remote control unit

* To exit the setup mode

Use the ▼ cursor button to select "EXIT SETUP", then press the ENTER button. It is also possible to quit by pressing the SETUP button on the remote control unit.

Setup items for use

Bold characters indicate factory defaults.

LANGUAGE SETUP

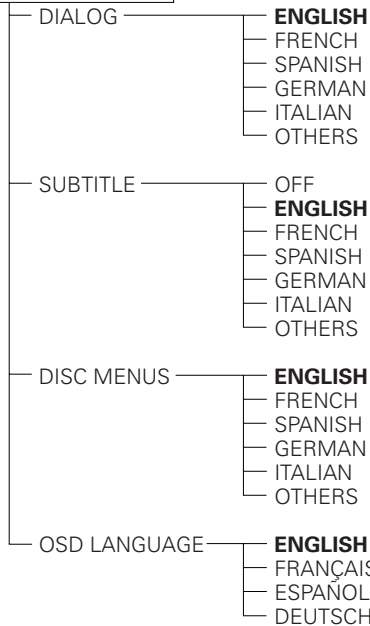

DIGITAL INTERFACE SETUP

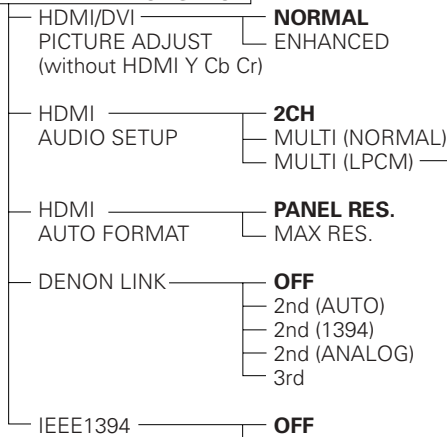

VIDEO SETUP

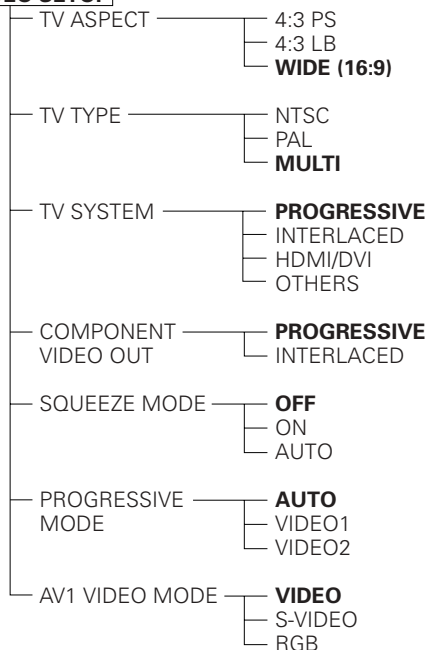

※ The display depends on the connected device.

HDMI SPEAKER SETUP

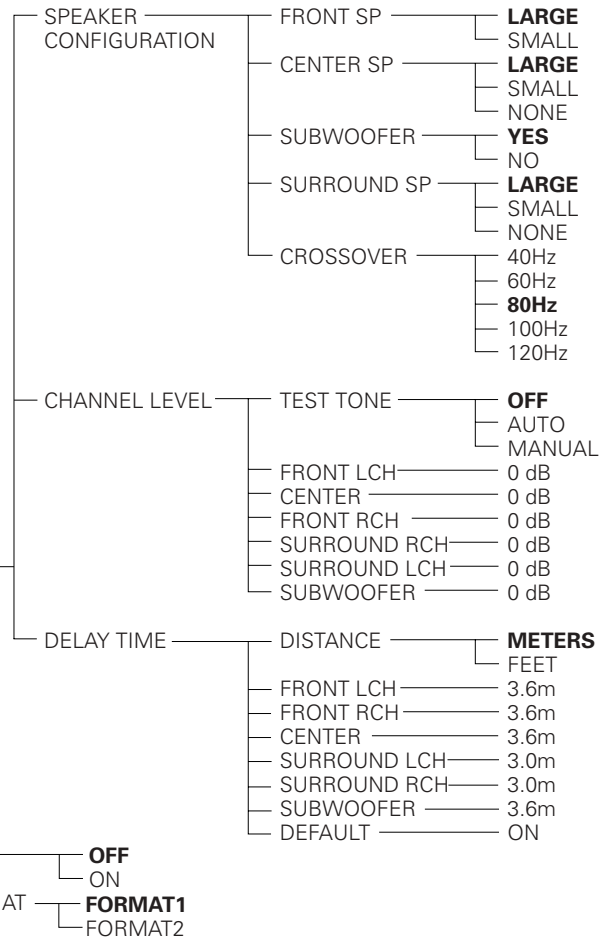

Bold characters indicate factory defaults.

AUDIO SETUP

- AUDIO CHANNEL — **MULTI CHANNEL**
 - 2 CH (SRS OFF)
 - 2 CH (SRS ON)
- DIGITAL OUTPUT — **NORMAL**
 - PCM
- LPCM (44.1 kHz/48 kHz) — **OFF**
 - ON
- SOURCE DIRECT — **OFF**
 - ON
- BASS ENHANCER — **OFF**
 - ON
- COMPRESSION — **OFF**
 - ON
- SACD FILTER — **50kHz**
 - 100kHz

SPEAKER SETUP

- SPEAKER CONFIGURATION
 - FRONT SP — **LARGE**
 - SMALL
 - CENTER SP — **LARGE**
 - SMALL
 - NONE
 - SUBWOOFER — **YES**
 - NO
 - SURROUND SP — **LARGE**
 - SMALL
 - NONE
 - CROSSOVER — **80Hz**
 - 40Hz
 - 60Hz
 - 100Hz
 - 120Hz
- CHANNEL LEVEL
 - TEST TONE — **OFF**
 - AUTO
 - MANUAL
 - FRONT LCH — 0 dB
 - CENTER — 0 dB
 - FRONT RCH — 0 dB
 - SURROUND RCH — 0 dB
 - SURROUND LCH — 0 dB
 - SUBWOOFER — 0 dB
 - SW+ 10dB — **OFF**
 - ON
- DELAY TIME
 - DISTANCE — **METERS**
 - FEET
 - FRONT LCH — 3.6m
 - FRONT RCH — 3.6m
 - CENTER — 3.6m
 - SURROUND LCH — 3.0m
 - SURROUND RCH — 3.0m
 - SUBWOOFER — 3.6m
 - DEFAULT — ON







RATINGS

- RATING LEVEL — 0 (LOCK ALL)
 - 1
 - 2
 - 3
 - 4
 - 5
 - 6
 - 7
 - 8 (NO LIMIT)**
- PASSWORD — CHANGE
 - OLD PASSWORD
 - NEW PASSWORD
 - CONFIRM PASSWORD

OTHER SETUP

- PLAYER MODE — **AUDIO**
 - VIDEO
- CAPTIONS — **OFF**
 - ON
- WALL PAPER — **BLUE**
 - GRAY
 - BLACK
 - PICTURE
- SCREEN SAVER — **OFF**
 - ON
- DISPLAY — **OFF**
 - ON
- AUTO POWER MODE — **OFF**
 - ON
- SLIDE SHOW — **5SEC**
 - (5~15SEC)

When "LANGUAGE SETUP" is selected

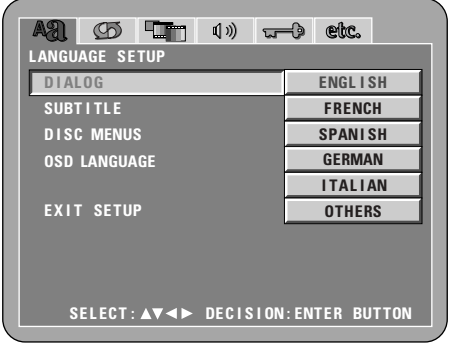
| | | |
|-----------------|---|---|
| <p>1</p> | <p>See pages 31, 32.</p> |   |
| <p>2</p> | <p>Use the ▲ and ▼ cursor buttons to select the desired setting, then press the ENTER button.</p> <p>DIALOG Use this to set the language of the sound output from the speakers.</p> <p>SUBTITLE Use this to set the language of the subtitles displayed on the TV.</p> <p>DISC MENUS Use this to set the language of the menus recorded on the disc (top menu, etc.).</p> <p>OSD LANGUAGE Use this to set the language for the default setting screen and messages displayed on the TV screen ("PLAY", etc.)</p> |  <p>Remote control unit Remote control unit</p>  |
| <p>3</p> | <p>Use the ▲ and ▼ cursor buttons to select the desired setting, then press the ENTER button.</p> <p>① When "DIALOG" is selected:</p> <p>ENGLISH (Factory default) Select this when you want to play the DVD with the sound in English.</p> <p>FRENCH Select this when you want to play the DVD with the sound in French.</p> <p>SPANISH Select this when you want to play the DVD with the sound in Spanish.</p> <p>GERMAN Select this when you want to play the DVD with the sound in German.</p> <p>ITALIAN Select this when you want to play the DVD with the sound in Italian.</p> <p>OTHERS Use the number buttons to input the language number. (See "Language code list" on page 37.)</p> |    <p>Remote control unit Remote control unit</p>  |

② When "SUBTITLE" is selected:

OFF

Select this if you do not want to display the subtitles. (For some discs it is not possible to turn off the subtitle display.)

ENGLISH (Factory default)

Select this when you want to play the DVD with the subtitles in English.

FRENCH

Select this when you want to play the DVD with the subtitles in French.

SPANISH

Select this when you want to play the DVD with the subtitles in Spanish.

GERMAN

Select this when you want to play the DVD with the subtitles in German.

ITALIAN

Select this when you want to play the DVD with the subtitles in Italian.

OTHERS

Use the number buttons to input the language number. (See "Language code list" on page 37.)

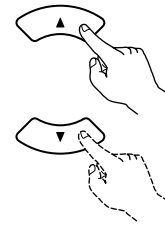

Remote control unit



Remote control unit

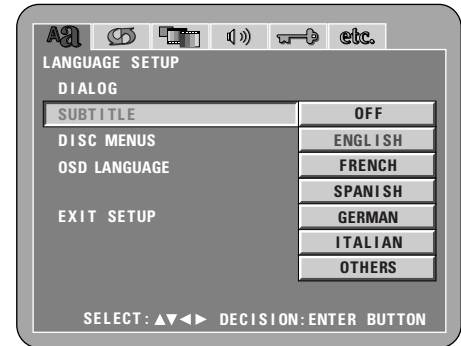

3

③ When "DISC MENU" is selected:

ENGLISH (Factory default)

Select this when you want to display the menus in English.

FRENCH

Select this when you want to display the menus in French.

SPANISH

Select this when you want to display the menus in Spanish.

GERMAN

Select this when you want to display the menus in German.

ITALIAN

Select this when you want to display the menus in Italian.

OTHERS

Use the number buttons to input the language number. (See "Language code list" on page 37.)

④ When "OSD LANGUAGE" is selected:

ENGLISH (Factory default)

Select this to set the OSD language to English.

FRANÇAIS

Select this to set the OSD language to French.

ESPAÑOL

Select this to set the OSD language to Spanish.

DEUTSCH

Select this to set the OSD language to German.







*** To exit the setup mode**

Use the ▼ cursor button to select "EXIT SETUP", then press the ENTER button. It is also possible to quit by pressing the SETUP button on the remote control unit.

Language code list

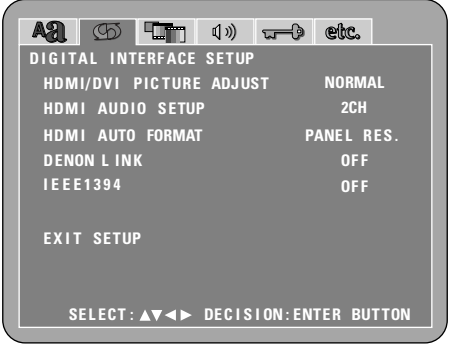
| Code | Language | Code | Language | Code | Language | Code | Language |
|-------------|-----------------|-------------|--------------|-------------|------------------|-------------|------------|
| 6565 | Afar | 7079 | Faroese | 7678 | Lingala | 8375 | Slovak |
| 6566 | Abkhazian | 7082 | French | 7679 | Laothian | 8376 | Slovenian |
| 6570 | Afrikaans | 7089 | Frisian | 7684 | Lithuanian | 8377 | Samoan |
| 6577 | Ameharic | 7165 | Irish | 7686 | Latvian, Lettish | 8378 | Shona |
| 6582 | Arabic | 7168 | Scots Gaelic | 7771 | Malagasy | 8379 | Somali |
| 6583 | Assamese | 7176 | Galician | 7773 | Maori | 8381 | Albanian |
| 6588 | Aymara | 7178 | Guarani | 7775 | Macedonish | 8382 | Serbian |
| 6590 | Azerbaijani | 7185 | Gujarati | 7776 | Malayalam | 8385 | Sundanese |
| 6665 | Bashkir | 7265 | Hausa | 7778 | Mongolian | 8386 | Swedish |
| 6669 | Byelorussian | 7273 | Hindi | 7779 | Moldavian | 8387 | Swahili |
| 6671 | Bulgarian | 7282 | Croatian | 7782 | Marathi | 8465 | Tamil |
| 6672 | Bihari | 7285 | Hungarian | 7783 | Malay | 8469 | Telugu |
| 6678 | Bengali; Bangla | 7289 | Armenian | 7784 | Maltese | 8471 | Tajik |
| 6679 | Tibetan | 7365 | Interlingua | 7789 | Burmese | 8472 | Thai |
| 6682 | Breton | 7378 | Indonesian | 7865 | Nauru | 8473 | Tigrinya |
| 6765 | Catalan | 7383 | Icelandic | 7869 | Nepali | 8475 | Turkmen |
| 6779 | Corsican | 7384 | Italian | 7876 | Dutch | 8476 | Tagalog |
| 6783 | Czech | 7387 | Hebrew | 7879 | Norwegian | 8479 | Tonga |
| 6789 | Welsh | 7465 | Japanese | 7982 | Oriya | 8482 | Turkish |
| 6865 | Danish | 7473 | Yiddish | 8065 | Panjabi | 8484 | Tatar |
| 6869 | German | 7487 | Javanese | 8076 | Polish | 8487 | Twi |
| 6890 | Bhutani | 7565 | Georgian | 8083 | Pashto, Pushto | 8575 | Ukrainian |
| 6976 | Greek | 7575 | Kazakh | 8084 | Portuguese | 8582 | Urdu |
| 6978 | English | 7576 | Greenlandic | 8185 | Quechua | 8590 | Uzbek |
| 6979 | Esperanto | 7577 | Cambodian | 8277 | Rhaeto-Romance | 8673 | Vietnamese |
| 6983 | Spanish | 7578 | Kannada | 8279 | Romanian | 8679 | Volapük |
| 6984 | Estonian | 7579 | Korean | 8285 | Russian | 8779 | Wolof |
| 6985 | Basque | 7583 | Kashmiri | 8365 | Sanskrit | 8872 | Xhosa |
| 7065 | Persian | 7585 | Kurdish | 8368 | Sindhi | 8979 | Yoruba |
| 7073 | Finnish | 7589 | Kirghiz | 8372 | Serbo-Croatian | 9072 | Chinese |
| 7074 | Fiji | 7665 | Latin | 8373 | Singhalese | 9085 | Zulu |

When "DIGITAL INTERFACE SETUP" is selected

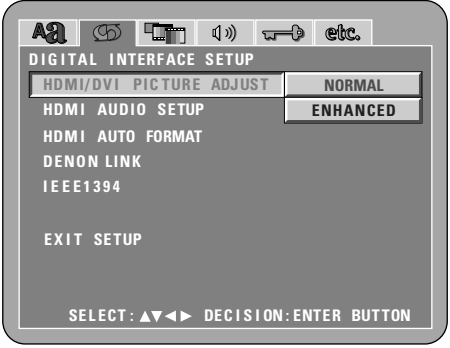
| | | |
|-----------------|--|---|
| <p>1</p> | <p>See pages 31, 32.</p> |    <p>Remote control unit Remote control unit</p> |
| <p>2</p> | <p>Use the ▲ and ▼ cursor buttons to select the desired setting, then press the ENTER button.</p> <p>HDMI/DVI PICTURE ADJUST Switches the digital RGB video range (data range) via the HDMI and the DVI-D connectors.</p> <p>HDMI AUDIO SETUP Use this to adjust for the audio signals via the HDMI connector.</p> <p>HDMI AUTO FORMAT Set the "AUTO" function selected with the HDMI/DVI FORMAT button on the main unit or the remote control unit.</p> <p>DENON LINK Use this to output digital signals from the DENON LINK terminal.</p> <p>IEEE1394 Use this to output digital signals from the IEEE1394 terminal.</p> |  |
| <p>3</p> | <p>Use the ▲ and ▼ cursor buttons to select the desired setting, then press the ENTER button.</p> <p>① When "HDMI/DVI PICTURE ADJUST" is selected:</p> <p>NORMAL (Factory default) Signals are output via the HDMI and the DVI-D connectors with a digital RGB video range (data range) of 16 (black) to 235 (white).</p> <p>ENHANCED Signals are output via the HDMI and the DVI-D connectors with a digital RGB video range (data range) of 0 (black) to 255 (white).</p> <p>※ When the HDMI and the DVI-D connectors are connected, the black may seem to stand out, depending on the TV or the Monitor. In this case, set this to "ENHANCED".</p> <p>※ When select "HDMI Y Cb Cr" under "HDMI/DVI SELECT", will have no effect. (See page 63.)</p> |    <p>Remote control unit Remote control unit</p>  |

② When "HDMI AUDIO SETUP" is selected:

2CH (Factory default)

The audio signals are output via the HDMI connector with a down-mixed to 2 channel.

MULTI (NORMAL)

The multi-channel audio signals are output via the HDMI connector with a bitstream.

MULTI (LPCM)

The multi-channel audio signals are output via the HDMI connector with a linear PCM.

⊙ When "MULTI (LPCM)" is selected, use the ▲ and ▼ cursor buttons to select the item to be set, then press the ENTER button.

SPEAKER CONFIGURATION

Use this to select the types of the different speakers.

CHANNEL LEVEL

Use this to adjust the output level of the different speakers.

DELAY TIME

Use this to set the distance from the different speakers to the listening position.

* To exit the HDMI SPEAKER SETUP mode.

Use the ▼ cursor button to select "DIGITAL INTERFACE SETUP" then press ENTER button.

⊙ When "SPEAKER CONFIGURATION" is selected, use the ▲ and ▼ cursor buttons to select the speaker to be set then press the ENTER button.

- The type of speaker used for the front speakers, center speaker, subwoofer and surround speakers can be set. Use the ▲ and ▼ cursor buttons to select the speaker type, then press the ENTER button.

LARGE

Select this when a large speaker is connected.

SMALL

Select this when a small speaker is connected.

- When "CROSSOVER" is selected:
40 Hz, 60 Hz, 80 Hz (Factory default), 100 Hz, 120 Hz, set the frequency of cross over.

* Press the RETURN button to return to the "HDMI SPEAKER SETUP" menu.

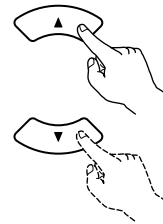

Remote control unit



Remote control unit

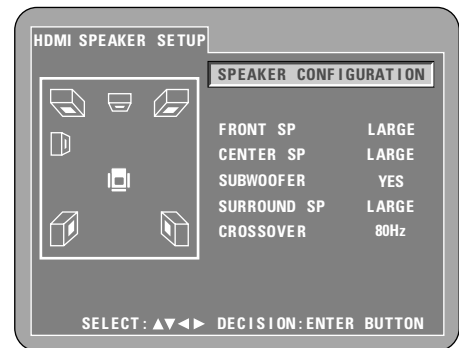
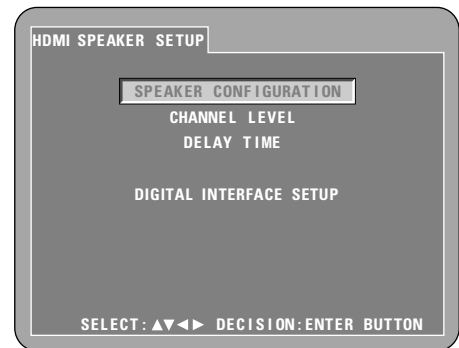
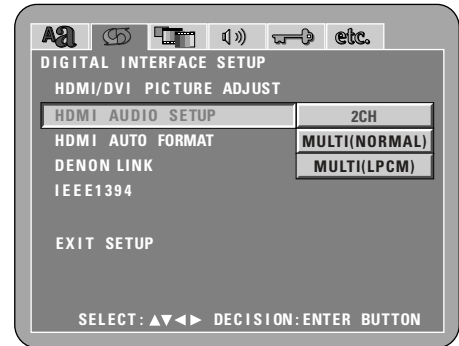

* The display depends on the connected device. (Indicates whether or not speakers are connected)

- © When "CHANNEL LEVEL" is selected, use the ▲ and ▼ cursor buttons to select the speaker to be adjusted, then use the ◀ and ▶ cursor buttons to set the level.
 - TEST TONE
 - Use the ◀ and ▶ cursor buttons to select auto or manual.
 - Adjust so that the volume of the test tones output from the different speakers sounds the same.
 - The volume level output from the front speakers (left and right channels), center speaker, surround speakers (left and right channels) and subwoofer can be adjusted.
 - The volume level can be adjusted between 0 and -10 dB in steps of 1 dB.
- * Press the RETURN button to return to the "HDMI SPEAKER SETUP" menu.

- © When "DELAY TIME" is selected:

With 5.1-channel surround sound, ideally the distance between the listening position and all the speakers aside from the subwoofer should be the same. The delay time setting can be used to make the sound from the different speakers reach the listening position at the same time.

Use the ▲ and ▼ cursor buttons to select the setting item, then press the ENTER button.

- When "DISTANCE" is selected:
 - METERS** (when the ◀ cursor button is pressed):
The unit of distance is set to meters ("m").
 - FEET** (when the ▶ cursor button is pressed):
The unit of distance is set to feet ("ft").
- When "FRONT LCH", "FRONT RCH", "CENTER", "SURROUND LCH", "SURROUND RCH", "SUBWOOFER" is selected:
 - Use the ◀ and ▶ cursor buttons to set the distance from the listening position to the different speakers.
 - * The distance can be set within the range of 0 to 18 meters (60 feet).
 - * The maximum difference in speaker distance for which adjustment is possible is 4.5 meters (15 feet).

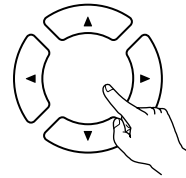

Remote control unit



Remote control unit

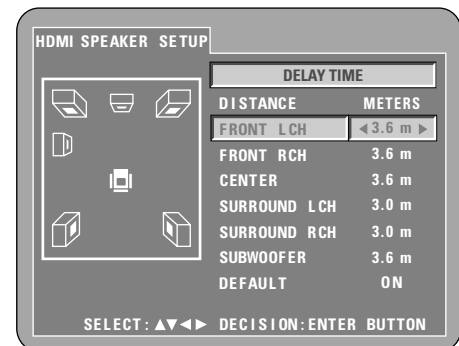
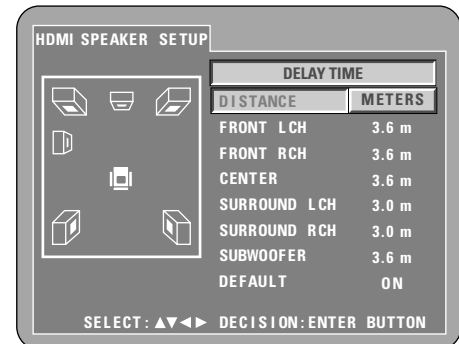
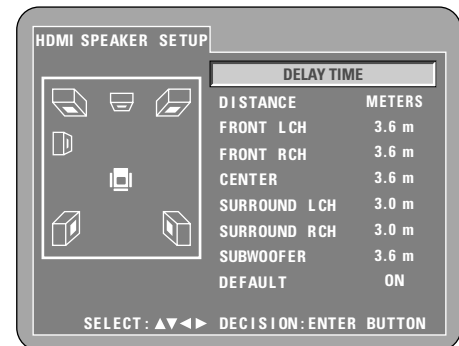
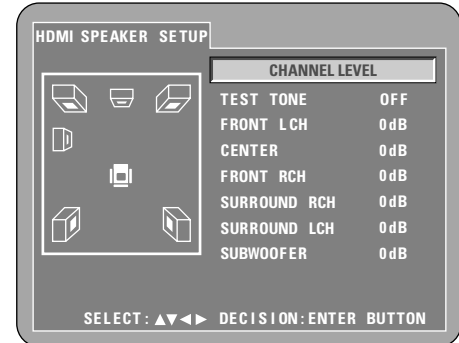

- When "DEFAULT" is selected:
When "DEFAULT" is selected and the ENTER button is pressed, all the items are restored to their factory default settings.
- ※ When digital connections are made with an AV amplifier, make the speaker settings on the AV amplifier.
For DVD audio discs, the disc's settings are given priority, so the sound may not be produced as set with the above speaker mode setting.
- * Press the RETURN button to return to the "HDMI SPEAKER SETUP" menu.
- ※ When the HDMI connection cable is disconnected, the "SPEAKER CONFIGURATION", "CHANNEL LEVEL", and "DELAY TIME" settings under "HDMI SPEAKER SETUP" are stored.
- ③ When "HDMI AUTO FORMAT" is selected:
PANEL RES. (Factory default)
The HDMI output format is selected automatically according to the panel resolution of the connected HDMI device.
MAX RES.
The HDMI output format is selected automatically according to the maximum resolution of the connected HDMI device.
- ※ When connected with a DVI device, the HDMI output format is fixed at 480P/576P.
- ④ When "DENON LINK" is selected:
OFF (Factory default)
No digital audio signals are output from the DENON LINK connector. Set to "OFF" when not using DENON LINK connections.
2nd (AUTO)
Signals are output from the DENON LINK connector in "2nd" format. When playing the multi/stereo area of super audio CDs, the connection to the IEEE1394 connector is detected automatically, and if a device is connected, the signals are output from the IEEE1394 connector. If no device is connected to the IEEE1394 connector, the signals are output from the analog audio connectors.
2nd (1394)
Signals are output from the DENON LINK connector in "2nd" format. When playing the multi/stereo area of super audio CDs, the signals are output from the IEEE1394 connector. No signals are output from the analog audio connectors.
2nd (ANALOG)
Signals are output from the DENON LINK connector in "2nd" format. When playing super audio CDs, the signals are output from the analog audio connectors. (No signals are output from the IEEE1394 connector, even if a device is connected.) Select this if your AV amplifier does not have an IEEE1394 connector.
3rd
Set this when the amplifier to be connected by DENON LINK 3rd. When playing super audio CDs, the signals are output from the DENON LINK.
- ※ Set this according to the type of DENON LINK connector on the amplifier connected to the DVD-A1XV. (See page 18.)
- ※ When the DENON LINK 2nd connection, Super audio CD's signals are not output from the DENON LINK connector. Please use the analog output terminals or the IEEE1394 connection.
- ※ When the DENON LINK is set, the down mixed audio signals are output only from the Left and Right and Front Left and Front Right terminals.

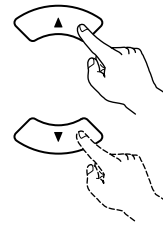

Remote control unit



Remote control unit

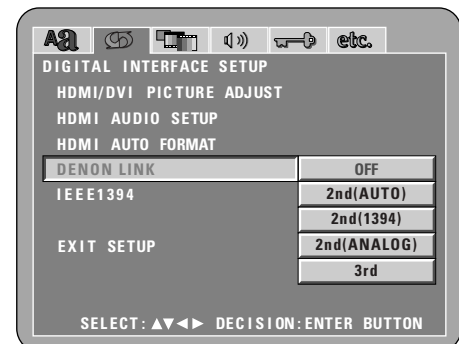
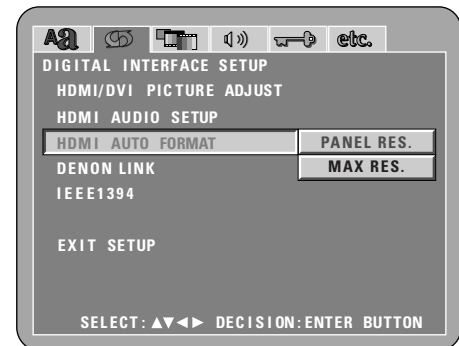
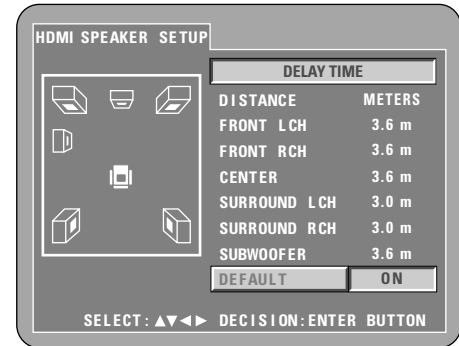

3

⑤ When "IEEE1394" is selected:

OFF (Factory default)

Digital audio signals are not output from the IEEE1394 terminal.

ON

Digital audio signals are output from the IEEE1394 terminal.

※ No audio signals are output from the analog connectors when IEEE1394 is set.

◎ When "ON" is selected:

This will lead to the "AUTO PLAY", and "AUDIO FORMAT" setting screens. Select the item to be set using the (▲, ▼) cursor buttons and press the ENTER button.

AUTO PLAY

Set this when automatically playing this unit from another device, under circumstances in which this unit is used in conjunction with a DENON device that supports IEEE1394.

AUDIO FORMAT

Set this format of audio signals from IEEE1394 connector.

◎ When "AUTO PLAY" is selected:

OFF (Factory default)

Set this when you do not wish to control the operation of this unit from another device.

ON

Set this when you wish to control the operation of this unit from another device.

◎ When "AUDIO FORMAT" is selected:

FORMAT1 (Factory default)

Set this when you conjunction with a DENON device.

FORMAT2

This is a mode for future system expansion.

[IEEE1394 indicator in the display]

- When "IEEE1394" set to "ON", this indicator lights as bellow.
 - flashingself check of IEEE1394 connections.
 - light.....IEEE1394 connection is OK.
 - slow flashingIEEE1394 connection is NG. (Loop connection) confirm the connection.
 - fast flashingIEEE1394 connection is NG. confirm the connection.

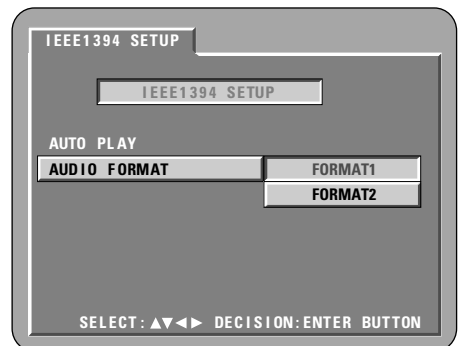
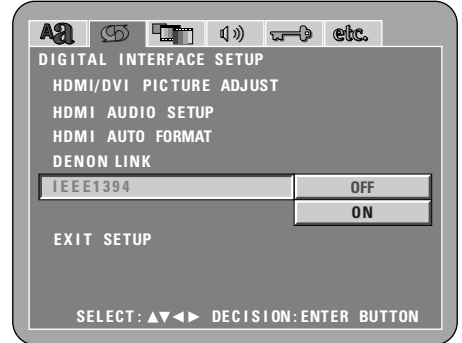
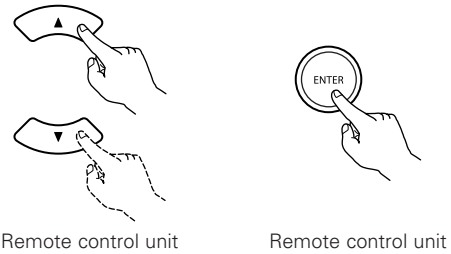

*** To exit the setup mode**

Use the ▼ cursor button to select "EXIT SETUP", then press the ENTER button. It is also possible to quit by pressing the SETUP button on the remote control unit.

1

See pages 31, 32.

Use the ▲ and ▼ cursor buttons to select the desired setting, then press the ENTER button.

TV ASPECT

Use this to set the shape of your TV's screen.

TV TYPE

Use this to set your TV's video format (NTSC, PAL or MULTI).

TV SYSTEM

Select the video output connected to the TV or monitor whose image you want to view.

On the DVD-A1XV, interlace output, progressive output and HDMI/DVI output signals are each processed on independent video circuits. The audio output is optimized for the selected video output, so choose the video output you wish to view.

COMPONENT VIDEO OUT

Use this to select either the progressive image output or interlace image output.

SQUEEZE MODE

The size of the screen to be output can be switched.

PROGRESSIVE MODE

The play DVD video, select the desired video mode.

AV1 VIDEO MODE

To select whether composite video signals or S video signals or RGB signals will be output from the AV1 SCART terminals.

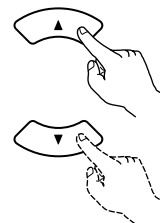

Remote control unit



Remote control unit



2

Use the ▲ and ▼ cursor buttons to select the desired setting, then press the ENTER button.

① When "TV ASPECT" is selected:

4:3 PS

Select this to play wide DVDs in the pan & scan mode (with the sides of the picture cut off). Discs for which pan & scan is not specified are played in the letter box mode.

4:3 LB

Select this to play wide DVDs in the letter box mode (with black strips at the top and bottom).

WIDE (16:9) (Factory default)

Select this to play wide DVDs in the full-screen mode.

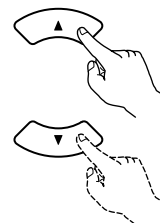

Remote control unit



Remote control unit

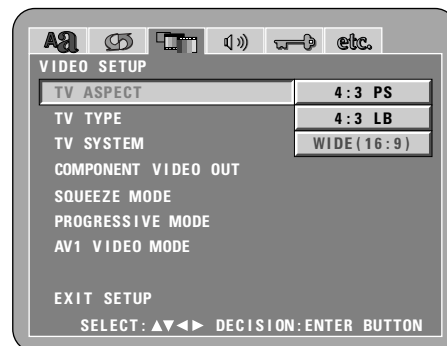

3

3

② When "TV TYPE" is selected:

NTSC

Select this when your TV's video format is NTSC.
If NTSC is selected, output format is fixed to NTSC.

PAL

Select this when your TV's video format is PAL.
If PAL is selected, output format is fixed to PAL.

MULTI (Factory default)

Select this when your TV is compatible with both the NTSC and PAL formats.

NTSC signals are output from the video output jacks when discs recorded in NTSC format are played, and PAL signals are output from the video output jacks when discs recorded in PAL format are played.

NOTE:

- If "TV TYPE" is set to a format other than a registered TV format, the image may no longer be smooth and the top and bottom of the image may be cut off.

③ When "TV SYSTEM" is selected:

PROGRESSIVE (Factory default)

The audio signals are synchronized with the progressive output.
(For component video output signals when "COMPONENT VIDEO OUT" at "VIDEO SETUP" is set to "PROGRESSIVE")

INTERLACED

The audio signals are synchronized with the interlaced output.
(For video output and S-video output signals, as well as for component video output signals when "COMPONENT VIDEO OUT" at "VIDEO SETUP" is set to "INTERLACED")

HDMI/DVI

The audio signals are synchronized with the video signals output via the HDMI/DVI connectors.

OTHERS

Select this when you want to view both the interlace output/progressive output image and the HDMI/DVI output image at the same time.

The audio signals are set to the optimum timing for the interlace output/progressive output image and the HDMI/DVI output image.
(Note, however, that the audio signals are not synchronized with the interlace output/progressive output image and the HDMI/DVI output image. To synchronize them, set to another position.)

④ When "COMPONENT VIDEO OUT" is selected: (NOTE)

PROGRESSIVE (Factory default)

The signals output from the DVD-A1XV's "COMPONENT VIDEO OUT" connector are formatted in the progressive format.
Select this when using the DVD-A1XV connected to a progressive type TV.

INTERLACED

The signals output from the DVD-A1XV's "COMPONENT VIDEO OUT" connector are formatted in the interlaced format.
Select this when using the DVD-A1XV connected to an interlace type TV.

NOTE:

- For the component output only, it is possible to switch between interlace image output and progressive image output. It is not possible to specify progressive image output for the Video output connector or S-Video output connector.

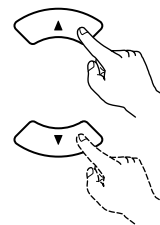

Remote control unit



Remote control unit

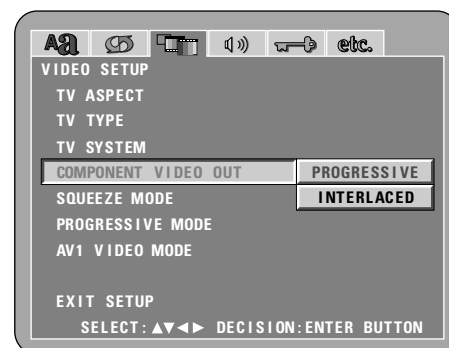
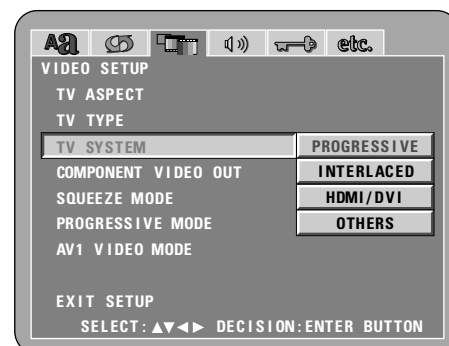

3

⑤ When "SQUEEZE MODE" is selected:

OFF (Factory default)

Select this to display as full size of a 16:9 TV, regardless of the image's size.



TV

ON

Select this to display the image with a ratio of 4:3 at the center of a 16:9 TV display, regardless of the image's size.



TV

AUTO

Select this when playing back a 4:3 image, display at 4:3 aspect ratio at the center of a 16:9 TV.

- ※ Only effective for set to "WIDE (16:9)" at "TV ASPECT". (See page 43.)
- ※ No effective for interlaced image.

⑥ When "PROGRESSIVE MODE" is selected:

AUTO (Factory default)

The set identifies the type of material on the disc being played (film or video) and selects the mode automatically.

VIDEO1

This mode is best suited for playing discs containing video material.

VIDEO2

This mode is best suited for playing discs containing video material or 30-frame film material.

⑦ When "AV1 VIDEO MODE" is selected:

VIDEO (Factory default)

Composite video signals will be output from the AV1 SCART terminal.

S-VIDEO

S video signals will be output from the AV1 SCART terminal.

RGB

RGB signals will be output from the AV1 SCART terminal.

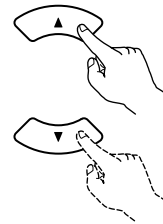

Remote control unit



Remote control unit

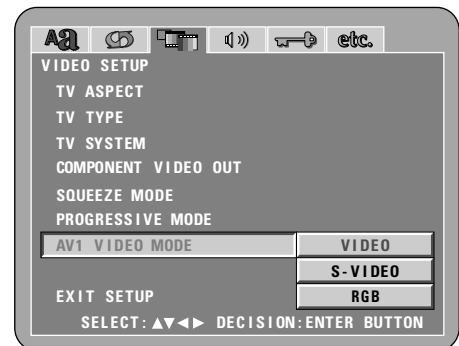
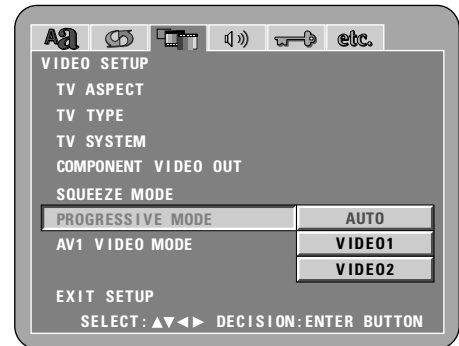
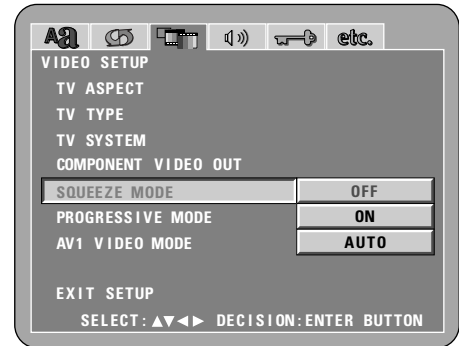

*** To exit the setup mode**

Use the ▼ cursor button to select "EXIT SETUP", then press the ENTER button. It is also possible to quit by pressing the SETUP button on the remote control unit.

When "AUDIO SETUP" is selected

1

See pages 31, 32.

Use the ▲ and ▼ cursor buttons to select the desired setting, then press the ENTER button.

AUDIO CHANNEL

Use this to adjust for the connected speaker systems.

DIGITAL OUTPUT

Use this to select the digital output's signal format.

LPCM (44.1 kHz/48 kHz)

Use this to set the digital audio output when playing DVDs recorded in linear PCM audio.

SOURCE DIRECT

This permits a setting to output the audio without adding speaker settings to the audio signals of DVD audio or Super Audio CD.

BASS ENHANCER

Set whether or not to output audio signals from the subwoofer when playing two-channel audio signals.

※ The BASS ENHANCER settings do not apply to digital outputs.

COMPRESSION

Use this to set the dynamic range output when playing discs.

SACD FILTER

The low pass filter value when playing Super Audio CDs can be set.

The audio channel, digital output, LPCM conversion mode and source direct bass expand items cannot be selected when DENON LINK or IEEE1394 is selected or when the HDMI audio is "MULTI (NORMAL)".

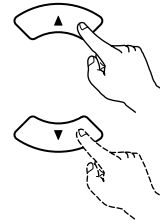

Remote control unit



Remote control unit

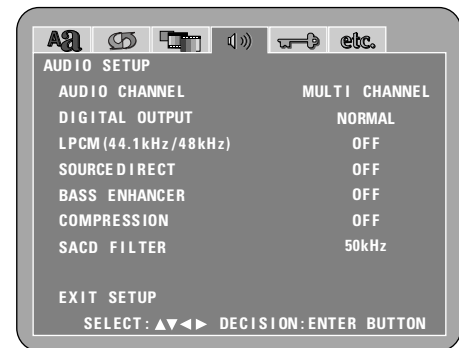

2

Use the ▲ and ▼ cursor buttons to select the desired setting, then press the ENTER button.

- ① When "AUDIO CHANNEL" is selected:

MULTI CHANNEL (Factory default)

Select this for systems in which three or more speakers are connected.

When MULTI CHANNEL is set, the speaker settings (SPEAKER CONFIGURATION), speaker output level adjustment (CHANNEL LEVEL) and speaker distances (DELAY TIME) can be set.

2CH (SRS OFF)

Select this does not to use the SRS TruSurround function for systems in which only two speakers are connected.

When connecting with Dolby Prologic decoder (Dolby Prologic amplifier etc.), select this setting.

2CH (SRS ON)

Select this to use the SRS TruSurround function for systems in which only two speakers are connected.

The indicator "●●" in the display lights at this mode.

■ **The SRS TruSurround function**

(only for DVD-videos and Video CDs)

The multi-channel sound normally achieved with five speakers is recreated using only the two front stereo speakers. This results in a sound with a nearly natural sense of movement that seems to surround the head, without the strong directivity characteristic of multi-speaker systems.

NOTES:

- Note that for some discs the effect will be weak or there will be no effect.
- Turn off other surround functions (the TV's surround mode, etc.).



is a trademark of SRS Labs, Inc.

TruSurround technology is incorporated under license from SRS Labs, Inc.

- © When "MULTI CHANNEL" is selected, use the ▲ and ▼ cursor buttons to select the item to be set, then press the ENTER button.

SPEAKER CONFIGURATION

Use this to select the types of the different speakers.

CHANNEL LEVEL

Use this to adjust the output level of the different speakers.

DELAY TIME

Use this to set the distance from the different speakers to the listening position.

- ※ The SPEAKER CONFIGURATION settings only apply to analog outputs.

- * To exit the SPEAKER SETUP mode

Use the ▼ cursor button to select "AUDIO SETUP" then press ENTER button.

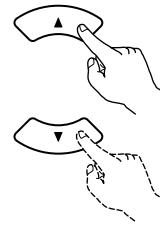

Remote control unit



Remote control unit

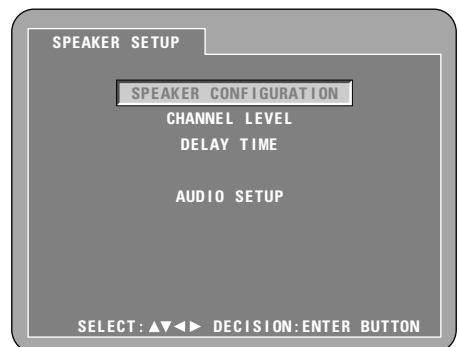
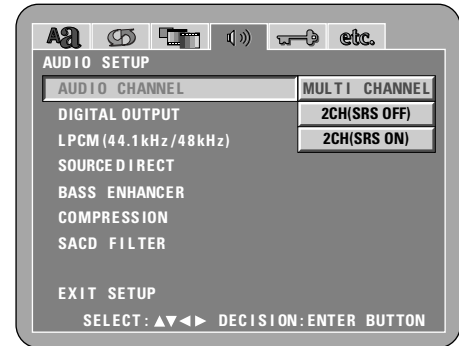

3

© When "SPEAKER CONFIGURATION" is selected, use the ▲ and ▼ cursor buttons to select the speaker to be set then press the ENTER button.

- The type of speaker used for the front speakers, center speaker, subwoofer and surround speakers can be set. Use the ▲ and ▼ cursor buttons to select the speaker type, then press the ENTER button.

LARGE

Select this when a large speaker is connected.

SMALL

Select this when a small speaker is connected.

NONE

Select this when no speaker is connected.

YES

Select this when a subwoofer is connected.

NO

Select this when no subwoofer is connected.

- When "CROSSOVER" is selected:
40 Hz, 60 Hz, 80 Hz (Factory default), 100 Hz, 120 Hz, set the frequency of crossover.

* Press the RETURN button to return to the "SPEAKER SETUP" menu.

© When "CHANNEL LEVEL" is selected, use the ▲ and ▼ cursor buttons to select the speaker to be adjusted, then use the ◀ and ▶ cursor buttons to set the level.

• **TEST TONE**

Use the ◀ and ▶ cursor buttons to select auto or manual.

Adjust so that the volume of the test tones output from the different speakers sounds the same.

- The volume level output from the front speakers (left and right channels), center speaker, surround speakers (left and right channels) and subwoofer can be adjusted.
- The volume level can be adjusted between 0 and -10 dB in steps of 1 dB.
- Settings SW +10 dB to "ON" increases by 10 dB the volume level that is output from the subwoofer.

* Press the RETURN button to return to the "SPEAKER SETUP" menu.

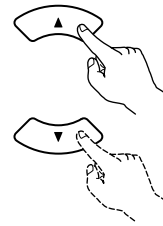

Remote control unit



Remote control unit

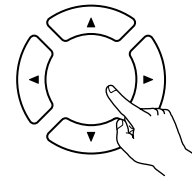
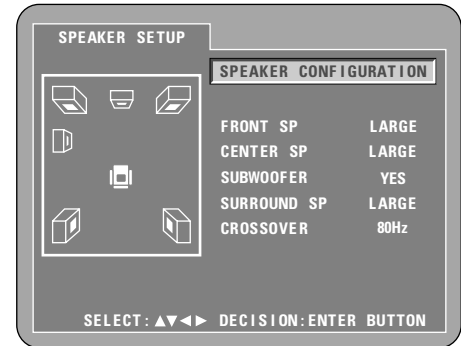

Remote control unit

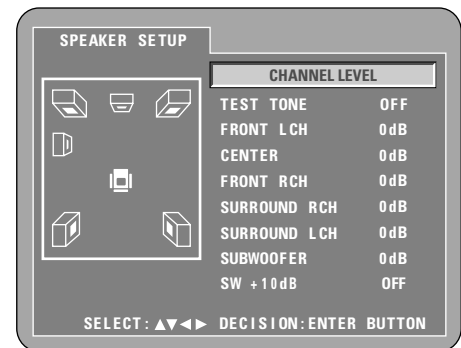

© When "DELAY TIME" is selected:

With 5.1-channel surround sound, ideally the distance between the listening position and all the speakers aside from the subwoofer should be the same. The delay time setting can be used to make the sound from the different speakers reach the listening position at the same time.

Use the ▲ and ▼ cursor buttons to select the setting item, then press the ENTER button.

• When "DISTANCE" is selected:

METERS (when the ◀ cursor button is pressed):

The unit of distance is set to meters ("m").

FEET (when the ▶ cursor button is pressed):

The unit of distance is set to feet ("ft").

• When "FRONT LCH", "FRONT RCH", "CENTER", "SURROUND LCH", "SURROUND RCH", "SUBWOOFER" is selected:

Use the ◀ and ▶ cursor buttons to set the distance from the listening position to the different speakers.

※ The distance can be set within the range of 0 to 18 meters (60 feet).

※ The maximum difference in speaker distance for which adjustment is possible is 4.5 meters (15 feet).

• When "DEFAULT" is selected:

When "DEFAULT" is selected and the ENTER button is pressed, all the items are restored to their factory default settings.

※ When digital connections are made with an AV amplifier, make the speaker settings on the AV amplifier.

For DVD audio discs, the disc's settings are given priority, so the sound may not be produced as set with the above speaker mode setting.

* Press the RETURN button to return to the "SPEAKER SETUP" menu.

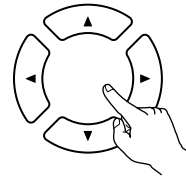

Remote control unit



Remote control unit

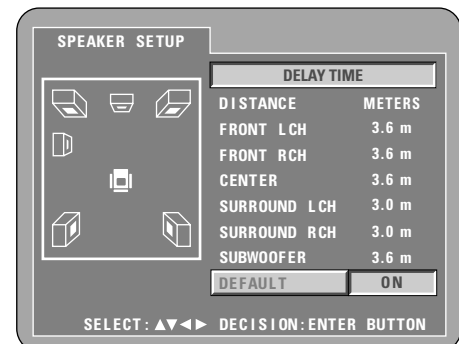
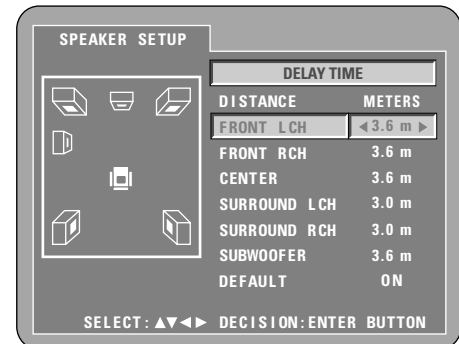
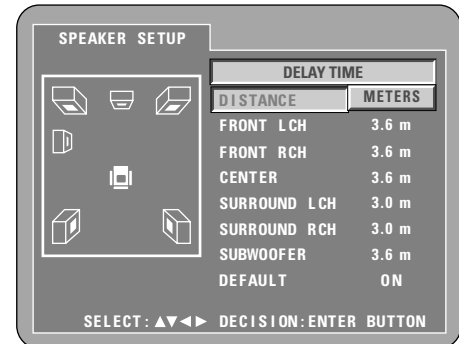
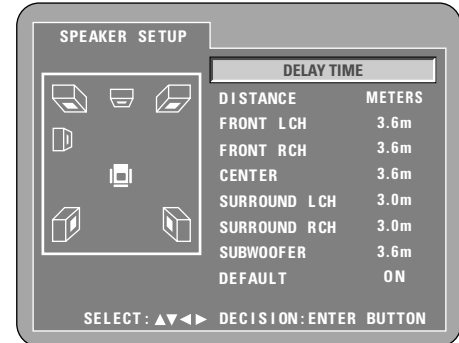

- ② When "DIGITAL OUTPUT" is selected:

NORMAL (Factory default)

When playing DVDs recorded in Dolby Digital or DTS, bitstream signals are output from the digital audio output terminals. When playing DVDs recorded in linear PCM or packed PCM, linear PCM signals are output.

Select "NORMAL" when making digital connections to an AV amplifier with built-in Dolby Digital and DTS decoder.

PCM

When playing Dolby Digital/DTS bitstream signals or DVDs recorded in linear PCM or packed PCM, the signals are converted into 48 kHz/16-bit PCM (2-channel) signals and output from the digital outputs. When playing DVDs recorded in PCM, linear PCM signals are output.

- ③ When "LPCM (44.1 kHz/ 48 kHz)" is selected:

OFF (Factory default)

When playing linear PCM or packed PCM DVDs that are not copyright-protected, for 2-channel PCM audio signals up to 96 kHz, linear PCM signals are output as such without being converted from the digital outputs. (176.4 kHz and 192 kHz signals are converted to 88.2 kHz and 96 kHz, respectively.)

For DVDs containing multi-channel PCM signals, the digital signals are down-mixed for output into two channels, front left and right. (Only the front left and right channels are output for sources for which down-mixing is prohibited.)

When playing copyright-protected linear PCM or packed PCM DVDs, in consideration of copyrights, no digital signals are output for sources exceeding 48 kHz/16 bits. When playing such sources, either set to "ON" or make analog connections. (See page 16.)

ON

Linear PCM and packed PCM signals are converted to 44.1 kHz or 48 kHz and output. (The PCM digital audio output signals are converted to 48 kHz or less in consideration of copyrights.) When making digital connections to an AV amplifier that is not compatible with 96 kHz/88.2 kHz signals, set to "ON".

- ④ When "SOURCE DIRECT" is selected:

OFF (Factory default)

Please set to OFF when performing speaker settings or setting the delay time and playing back.

ON

Set to ON when playing back without performing the processing of speaker settings. Performing this setting will result in the setting of the DTS recommended all-channel, full bandwidth playback. (Note that the volume of the sub woofer will increase by 5 dB, and there will be an increase of 15 dB with a Super Audio CD.) This is also set when playing back a 6-channel source of DVD audio that has been recorded with all channels and full bandwidth. When set to "ON", the speaker size will be set to "Large" for all speakers and the sub woofer will be set to "Yes". When playing back software such as this, perform the analog connections according to the software instruction manual.

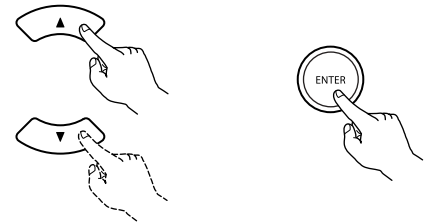

Remote control unit

Remote control unit

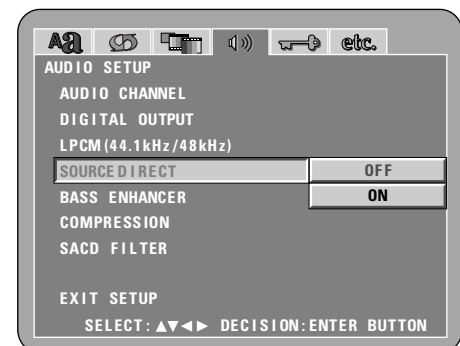
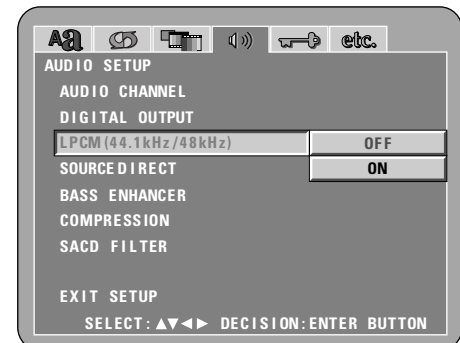
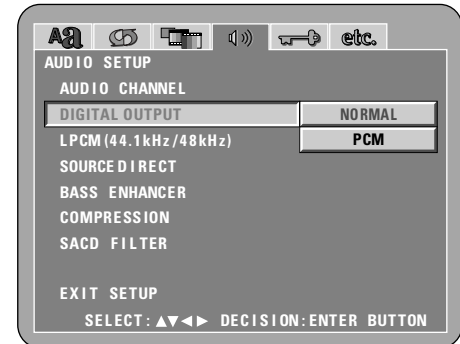

3

- ⑤ When "BASS ENHANCER" is selected: (For 2 channel source.)

OFF (Factory default)

No sound is produced from the subwoofer.

ON

Sound is produced from the subwoofer.

In the case, set the subwoofer to "YES" at the speaker settings.

- ※ This works only with analog audio output.
- ※ This does not work, at "SOURCE DIRECT" is on.

- ⑥ When "COMPRESSION" is selected:

OFF (Factory default)

Select this for the standard range.

ON

Select this to achieve powerful sound even when the volume is low. This setting is suited for watching DVDs late at night with the volume low. (This setting is only valid for DVDs recorded in Dolby Digital.)

- ⑦ When "SACD (Super Audio CD) FILTER" is selected:

50kHz (Factory default)

When playing Super Audio CDs, high frequencies of 50kHz and higher are cut.

100kHz

When playing Super Audio CDs, high frequencies of 100kHz and higher are cut.

- ※ Set to 100kHz when a high frequency compatible AV amplifier is connected.

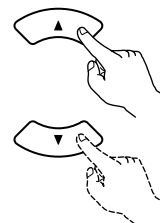

Remote control unit













Remote control unit

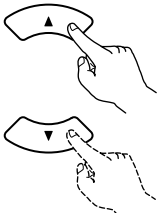

*** To exit the setup mode**

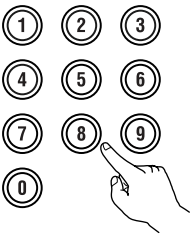
Use the ▼ cursor button to select "EXIT SETUP", then press the ENTER button. It is also possible to quit by pressing the SETUP button on the remote control unit.

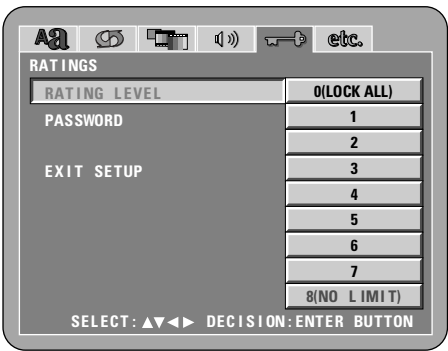
When "RATINGS" is selected

| | | | |
|-----------------|---|---|---|
| <p>1</p> | <p>See pages 31, 32.</p> |  |  |
| <p>2</p> | <p>Use the ▲ and ▼ cursor buttons to select the desired setting, then press the ENTER button.</p> <p>RATING LEVEL Use this to restrict playback of adult DVDs you do not want children to view. Note that even with adult DVDs, viewing cannot be restricted unless the restriction level is recorded on the disc.</p> <p>PASSWORD Use this to change the password. The default password is "0000".</p> | <p>Remote control unit</p>  <p>Remote control unit</p> |  |
| <p>3</p> | <p>Use the ▲ and ▼ cursor buttons to select the desired setting, then press the ENTER button.</p> <p>① When "RATING LEVEL" is selected:</p> <p>0 (LOCK ALL) Select this to disable playback of all DVDs. Use this for example to disable playback of adult DVDs on which the rating level is not recorded.</p> <p>1 Select this to play only DVDs for children. (Adult and general audience DVDs cannot be played.)</p> <p>2 to 7 Select this to play DVDs for general audiences and children. Adult DVDs cannot be played.</p> <p>8 (NO LIMIT) (Factory default) Select this to play all DVDs.</p> <p>Use the number buttons to input a 4-digit password, then press the ENTER button.</p> <ul style="list-style-type: none"> ※ The default password is "0000". ※ Do not forget the password. ※ The setting cannot be changed without inputting the correct password. | <p>Remote control unit</p>  <p>Remote control unit</p>  <p>Remote control unit</p>  <p>Remote control unit</p>  <p>Remote control unit</p> |   |

3

② When "PASSWORD" is selected:
Use the ► cursor button to select the "CHANGE", then press the ENTER button.

Use the number buttons to input a old (current) 4-digit password.

※ The default password is "0000".

Use the number buttons to input a new 4-digit password.

Use the number buttons to input a new 4-digit password again. (for the confirmation.)
Then press the ENTER button.

※ Do not forget the password.
※ The setting cannot be changed without inputting the correct password.

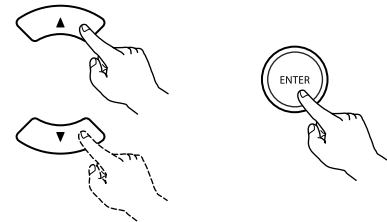

Remote control unit Remote control unit



Remote control unit



Remote control unit

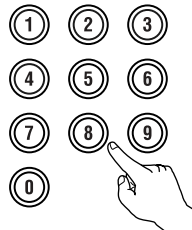

Remote control unit



Remote control unit



* To exit the setup mode

Use the ▼ cursor button to select "EXIT SETUP", then press the ENTER button. It is also possible to quit by pressing the SETUP button on the remote control unit.

1

See pages 31, 32.

Use the ▲ and ▼ cursor buttons to select the desired setting, then press the ENTER button.

PLAYER MODE

The DVD video play mode can be set to play the DVD video contents included on a DVD audio disc.

CAPTIONS

Use this to set whether or not to display the closed captions recorded on DVDs.

WALL PAPER

Use this to select the image to be shown on the screen in the stop mode and CD play mode.

2

SCREEN SAVER

The screen saver function prevents ghosting on the TV screen.

DISPLAY

The setting of whether or not there will be an indication on the display of this unit only for the 2 seconds immediately following the operation, even while the display has been off.

AUTO POWER MODE

To save power, DVD-A1XV's can automatically be set to the standby mode when it is not used for long periods of time.

SLIDE SHOW

The time interval for switching to the next still picture when playing slide shows of still pictures (in JPEG format) can be set.

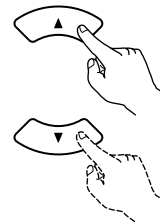

Remote control unit



Remote control unit



Use the ▲ and ▼ cursor buttons to select the desired setting, then press the ENTER button.

① When "PLAYER MODE" is selected:

AUDIO (Factory default)

Set this to play the DVD audio signals as such.

VIDEO

Set this to play the DVD video contents included on a DVD audio disc.

3

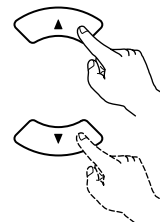

Remote control unit



Remote control unit



3

② When "CAPTIONS" is selected:

OFF (Factory default)

Select this when you do not want to display the captions on the screen when playing DVDs containing English captions

ON

Select this to display the captions on the screen when playing DVDs containing English captions.

NOTES:

- An English caption decoder is required to display English captions.
- DVDs with caption signals are indicated by the  mark.

English captions cannot be displayed when playing DVDs which do not contain caption signals.

③ When "WALL PAPER" is selected:

BLUE (Factory default)

Select this to display a blue background on the TV display.

GRAY

Select this to display a gray background on the TV display.

BLACK

Select this to display a black background on the TV display.

PICTURE

Select this to display the picture on the TV display.

④ When "SCREEN SAVER" is selected:

OFF (Factory default)

The screen saver function does not work.

ON

If more than 5 minutes passes while in the stop, pause or other mode, the screen saver function is activated to prevent ghosting on the TV screen.

⑤ When "DISPLAY" is selected:

OFF (Factory default)

This is valid when the display has been switched off. The display will not show an indication even when the button (ex. skip, stop, etc.) has been pressed.

ON

This is valid when the display has been switched off. When the button (ex. skip, stop, etc.) is pressed, the indication will appear on the display for approximately 2 seconds.

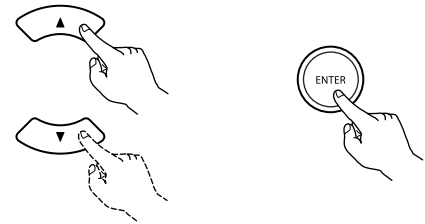

Remote control unit

Remote control unit

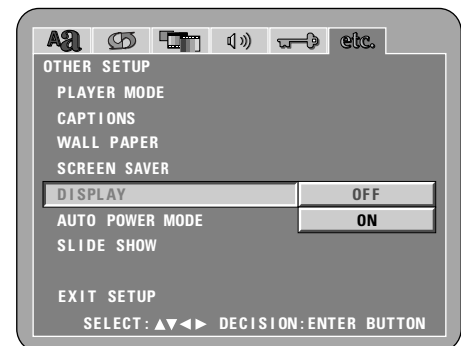
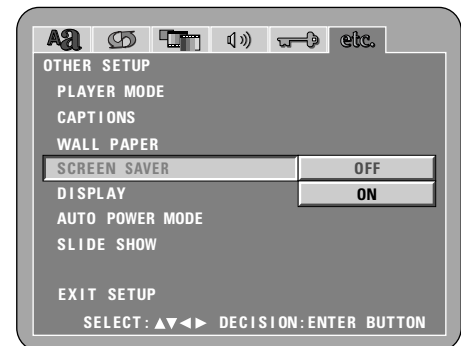
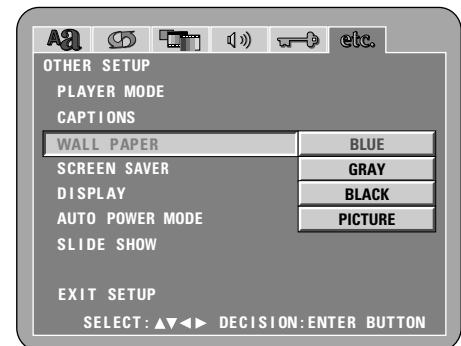

3

- ⑥ When "AUTO POWER MODE" is selected:

OFF (Factory default)

The power does not automatically switch to the standby mode.

ON

The DVD-A1XV's power turns off and the standby mode is set if the DVD-A1XV remains in the stop mode for approximately 30 minutes.

- ⑦ When "SLIDE SHOW" is selected:

Use the ▲ and ▼ cursor buttons to set the time interval.

The time interval can be set within 5 and 15 seconds. **(The factory default setting is 5 seconds.)**

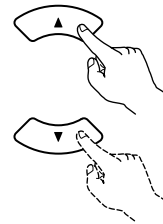

Remote control unit



Remote control unit

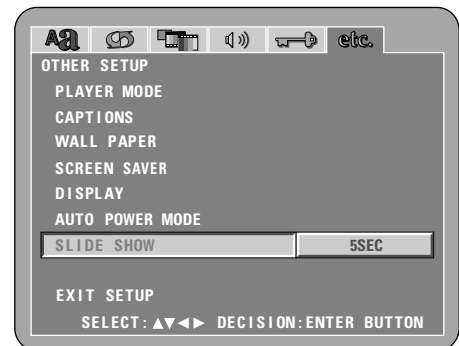
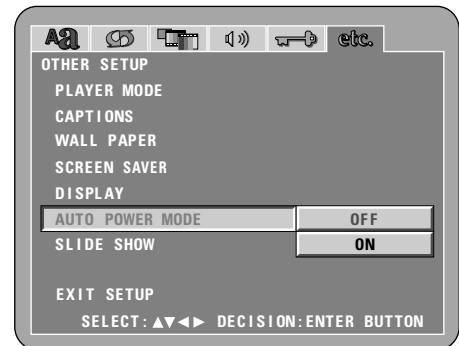

*** To exit the setup mode**

Use the ▼ cursor button to select "EXIT SETUP", then press the ENTER button. It is also possible to quit by pressing the SETUP button on the remote control unit.

9 USING THE PURE DIRECT MODE

- In the pure direct mode, only analog audio signals (no video signals, etc.) are output, thereby achieving high quality sound.

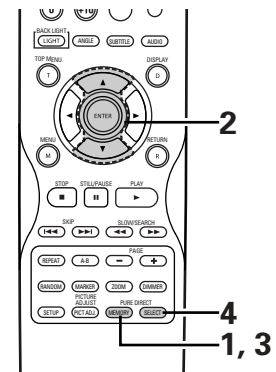
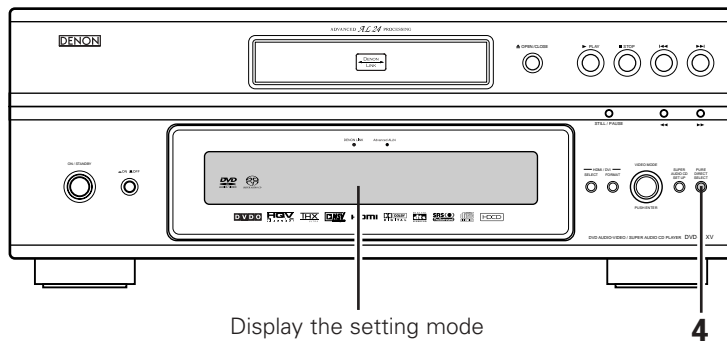

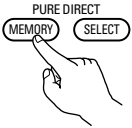
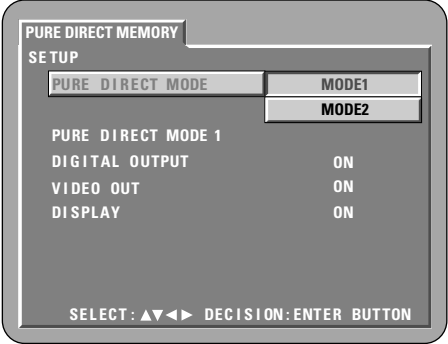
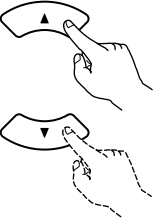
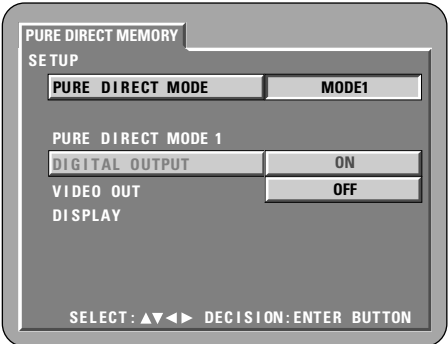

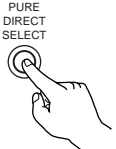
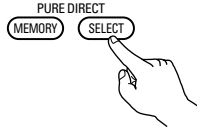
| | | |
|-----------------|--|--|
| <p>1</p> | <p>Press the PURE DIRECT MEMORY button.</p> <ul style="list-style-type: none"> The output status of the video signals, etc., can be stored at MODE 1 and MODE 2 as desired. |  <p>Remote control unit</p>  |
| <p>2</p> | <p>Use the ▲ and ▼ cursor buttons to select the mode, then press the ENTER button.</p> <p>DIGITAL OUTPUT</p> <p>ON : Digital audio signals are output. OFF : Digital audio signals are not output. * Does not function for DENON LINK or IEEE1394 digital outputs. For these outputs, set "OFF" at the initial settings.</p> <p>VIDEO OUT</p> <p>ON : Video signals are output. OFF : Video signals are not output.</p> <p>DISPLAY</p> <p>ON : It is indicate in Display of the main unit. OFF : It is not indicate in Display of the main unit.</p> <p>* When the video output is set to "OFF" or "ALL OFF", neither HDMI video nor audio signals are output. Also, when the "HDMI AUDIO SETUP" is set to "MULTI (NORMAL)", the setting of DIGITAL OUTPUT cannot be made. (See pages 38, 39.)</p> <p>* When DENON LINK and IEEE 1394 settings are valid, the setting of DIGITAL OUTPUT cannot be selected.</p> |  <p>Remote control unit</p>  |
| <p>3</p> | <p>Press the PURE DIRECT MEMORY button.</p> <ul style="list-style-type: none"> All of the settings are stored in the memory. | <p>Remote control unit</p> |

| | | |
|---|---|---|
| 4 | <p>Press the PURE DIRECT SELECT button.</p> <ul style="list-style-type: none"> The modes described below will appear on the display. <ul style="list-style-type: none"> NORMAL : All signals are output normally. MODE 1 : The settings stored for MODE 1 are used. The factory default settings are: <ul style="list-style-type: none"> "DIGITAL OUTPUT" : "ON" "VIDEO OUT" : "ON" "DISPLAY" : "ON" MODE 2 : The settings stored for MODE 2 are used. The factory default settings are: <ul style="list-style-type: none"> "DIGITAL OUTPUT" : "ON" "VIDEO OUT" : "ON" "DISPLAY" : "ON" ALL OFF : No indicate in Display of the main unit, video and digital signals are not out.(except analog audio output) | <div style="display: flex; justify-content: space-around; align-items: center;"> <div style="text-align: center;">  <p>PURE DIRECT SELECT</p> <p>Main unit</p> </div> <div style="text-align: center;">  <p>PURE DIRECT MEMORY SELECT</p> <p>Remote control unit</p> </div> </div> |
|---|---|---|

10 USING THE SUPER AUDIO CD SETUP

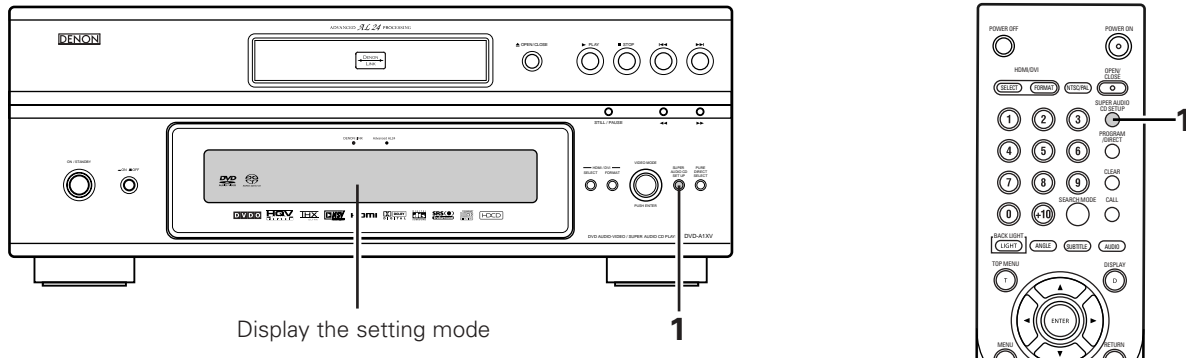
- On a Super Audio CD, the stereo and multi – channel areas are separate. Hybrid discs comprise 2-layer structure of Super Audio CD layer and a CD layer. The area/layer can be set to be played with priority.

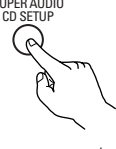

| | | |
|---|--|--|
| 1 | <p>Press the SUPER AUDIO CD SETUP button.</p> <ul style="list-style-type: none"> The modes described below will appear on the display. <ul style="list-style-type: none"> MULTI (Factory default) When playing a Super Audio CD disc, the multi – channel area will be played back with priority. STEREO When playing a Super Audio CD disc, the stereo area will be played back with priority. CD When playing a Super Audio CD disc, the CD layer will be played back with priority. * When playing back a disc that does not have a selected area/layer, another area/layer will be played back automatically. | <div style="display: flex; flex-direction: column; align-items: center;"> <div style="text-align: center; margin-bottom: 20px;">  <p>SUPER AUDIO CD SETUP</p> <p>Main unit</p> </div> <div style="text-align: center; margin-bottom: 20px;">  <p>SUPER AUDIO CD SETUP</p> <p>Remote control unit</p> </div> <div style="display: flex; flex-direction: column; gap: 20px; width: 100%;"> <div style="border: 1px solid black; padding: 5px; text-align: center; width: 80%; margin: 0 auto;">MULTI</div> <div style="border: 1px solid black; padding: 5px; text-align: center; width: 80%; margin: 0 auto;">STEREO</div> <div style="border: 1px solid black; padding: 5px; text-align: center; width: 80%; margin: 0 auto;">CD</div> </div> </div> |
|---|--|--|

11 ADJUSTING THE PICTURE QUALITY

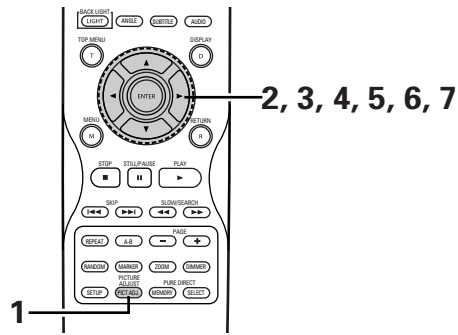

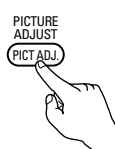
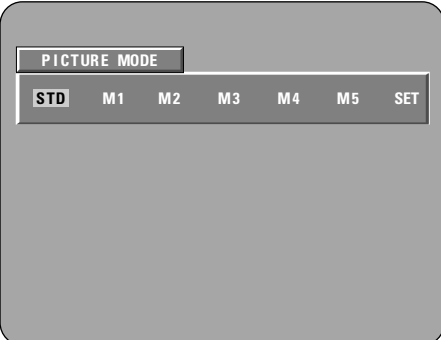
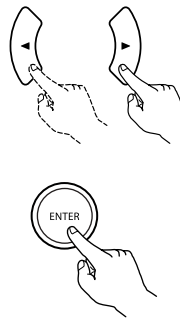
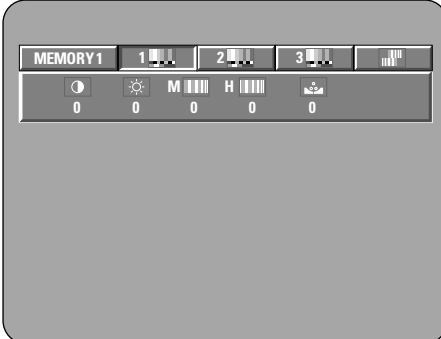
| | | |
|-----------------|---|---|
| <p>1</p> | <p>Press the PICTURE ADJUST button.</p> <ul style="list-style-type: none"> The image quality adjustment screen will appear. <p>STD Returns the settings to the factory default settings.</p> <p>M1 TO M5 Image quality settings that have been adjusted to your preference can be stored to 5 memories, M1 to M5.</p> <p>SET SET permits set to setup level and setting of the screen display position (horizontal and vertical).</p> |  <p>Remote control unit</p>  |
| <p>2</p> | <p>Select the memory using the 2 cursor buttons (◀, ▶) and press the ENTER button.</p> <p>IMAGE QUALITY ADJUSTMENT 1 This permits adjustment of the contrast, brightness, sharpness and hue. → Advance to Operation 3</p> <p>IMAGE QUALITY ADJUSTMENT 2 This permits adjustment of the white level, black level and chroma level. → Advance to Operation 4.</p> <p>IMAGE QUALITY ADJUSTMENT 3 This permits adjustment of the enhancer. → Advance to Operation 5.</p> <p>GAMMA CORRECTION This is selected when dark portions of the image are obscure, or bright portions are much brighter than necessary. → Advance to Operation 6.</p> |  <p>Remote control unit</p>  |

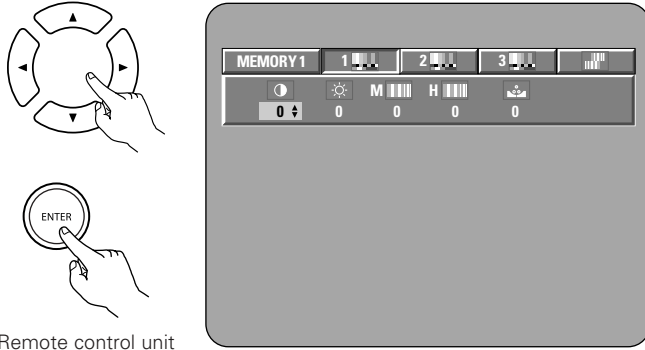
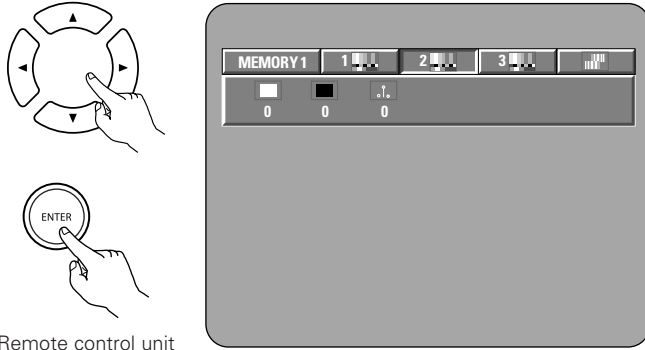
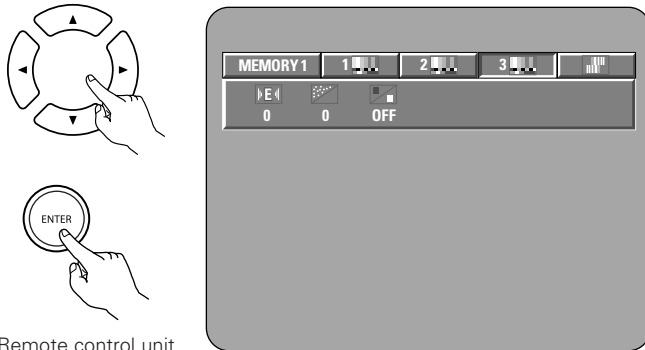
| | | |
|-----------------|--|---|
| <p>3</p> | <p>When Image Quality Adjustment 1 is selected and adjusted:</p> <ul style="list-style-type: none"> • Press cursor button (▼), then select the image quality adjustment item with cursor buttons (◀, ▶), set the adjustment value with cursor buttons (▲, ▼), and press the ENTER button. • All of the adjusted contents will be stored. <ul style="list-style-type: none"> CONTRAST (-6 to +6) (Factory default: 0) <ul style="list-style-type: none"> • This adjusts the light/dark difference of the image. BRIGHTNESS (0 to +12) (Factory default: 0) <ul style="list-style-type: none"> • This adjusts the brightness of the image. SHARPNESS (MID) (-6 to +6) (Factory default: 0) <ul style="list-style-type: none"> • This adjusts the sharpness of the image for the intermediate frequencies. SHARPNESS (HIGH) (-6 to +6) (Factory default: 0) <ul style="list-style-type: none"> • This adjusts the sharpness of the image for the high frequencies. (Only effective for progressive images.) HUE (-6 to +6) (Factory default: 0) <ul style="list-style-type: none"> • This adjusts the balance between green and red. (This does not affect the component interlaced output.) |  <p>Remote control unit</p> |
| <p>4</p> | <p>When Image Quality Adjustment 2 is selected and adjusted:</p> <ul style="list-style-type: none"> WHITE LEVEL (-5 to +5) (Factory default: 0) <ul style="list-style-type: none"> • This adjusts the white level. BLACK LEVEL (-5 to +5) (Factory default: 0) <ul style="list-style-type: none"> • This adjusts the black level. CHROMA LEVEL (-6 to +6) (Factory default: 0) <ul style="list-style-type: none"> • This adjusts the density of the color. |  <p>Remote control unit</p> |
| <p>5</p> | <p>When Image Quality Adjustment 3 is selected and adjusted:</p> <ul style="list-style-type: none"> ENHANCER (0 to +11) (Factory default: 0) <ul style="list-style-type: none"> • This emphasizes the contour of the image. DNR (Digital Noise Reduction) (0 to +3) (Factory default: 0) <ul style="list-style-type: none"> • This reduces video noise. CCS (ON/OFF) (Factory default: OFF) <ul style="list-style-type: none"> • This performs removal of the color signal component for images in which the color signal component is mixed with the brightness signal. (Only effective with progressive images.) |  <p>Remote control unit</p> |

When Gamma Correction is selected and adjusted:
Two kinds of displays are prepared for adjustment of Gamma Correction.

- When use the Numerical table of Gamma Correction. (Figure 1)
:Pressing the cursor button (▼)
- When use the Graph of Gamma Correction. (Figure 2)
:Pressing the enter button

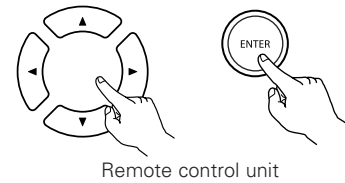

Select the adjust point with cursor buttons (◀, ▶), set the adjustment brightness level with cursor buttons (▲, ▼), and press the ENTER button.

(If the PICTURE ADJUST button is pressed before pressing the enter button, an adjustment level is not stored)

- The brightness level can be adjusted in range of 16 to 235.
- Pressing the cursor button (▲) raises the level (and the image becomes brighter), and pressing the cursor button (▼) lowers the level (and the image becomes darker).
- A press of the CLEAR button returns all of the setting points to the standard level.

- * The level of the selected point cannot exceed the level of the points above and below that point.
(A dark portion cannot be set to exceed a portion that is brighter than it.)

6

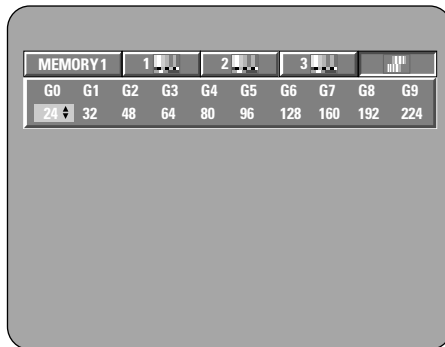

(Figure 1)

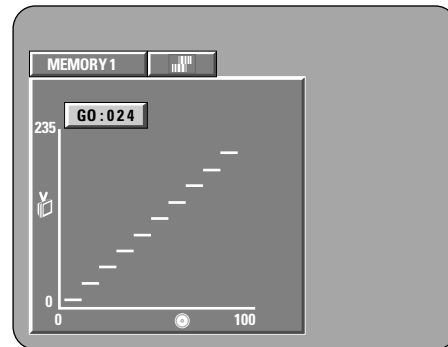

(Figure 2)

***To exit the Image Quality Adjustment mode**

Press the PICTURE ADJUST button.

REFERENCE:

- In the Graph of Gamma correction, the horizontal axis indicates the brightness level of the image that is recorded on the disc, and the vertical axis indicates the brightness level of the image when it is output from this unit.

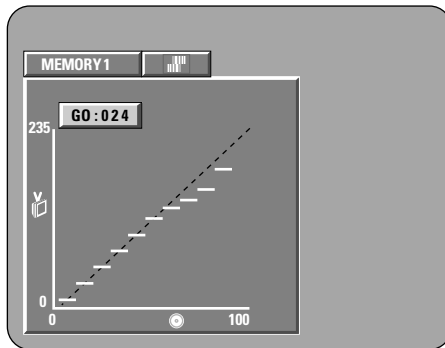

- When bright points of the disc side are adjusted to the "dark" of the output side, the fine parts of the bright portion that normally become hard to see, become an easily discerned image.

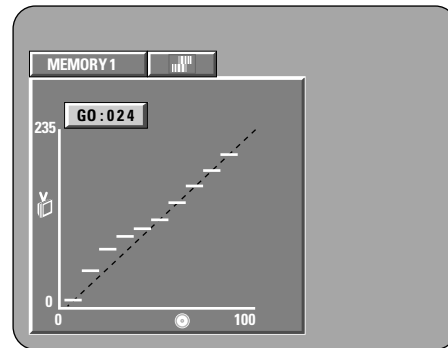

- When dark points of the disc side are adjusted to the "bright" of the output side, the fine parts of the dark portion that normally become hard to see, become an easily discerned image.

7

When the Display Position is Selected and Adjusted:

- Press the cursor button (▼), then select the horizontal/vertical direction with the cursor buttons (◀, ▶), set the adjustment value with the (▲, ▼) cursor buttons, and press the ENTER button.

SETUP LEVEL (0 IRE, 0 IRE)
(Factory default: 0 IRE)

- This corrects floating black.
- H. POSITION (-7 to +7) (Factory default: 0)**
- A position adjustment is permitted left and right.
- V. POSITION (-7 to +7) (Factory default: 0)**
- A position adjustment is permitted up and down.

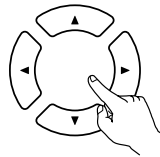

Remote control unit

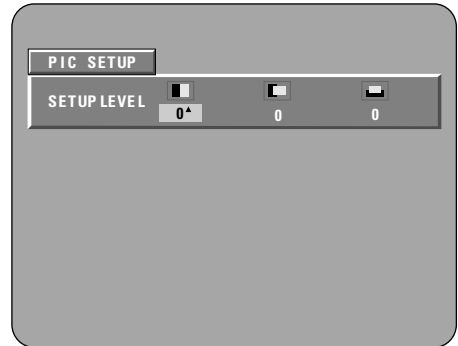
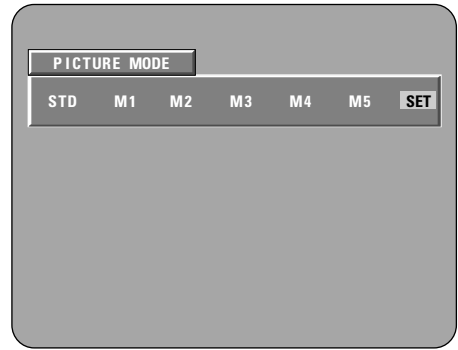

*** To exit the picture adjust mode**

Press the PICTURE ADJUST button.

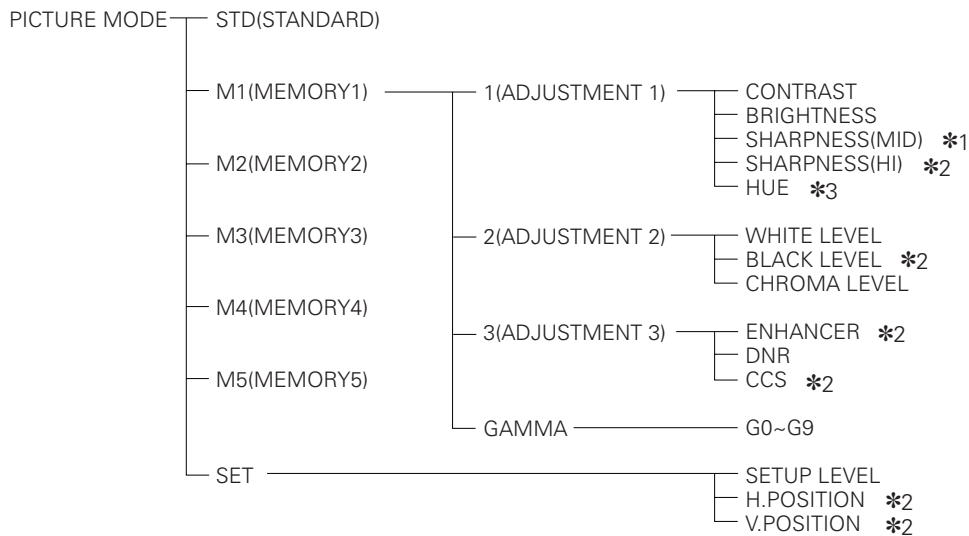

*1 This does not affect the HDMI/DVI output.

*2 Only effective for HDMI, DVI and progressive scan.

*3 This does not affect the interlaced of component video output.

12 USING THE VIDEO SETUP

- The video output setting of the HDMI and the DVI-D connectors can be changed.
- The video output setting of the PICTURE MODE, TV SYSTEM, SQUEEZE MODE and AUDIO ADJUST also can be changed.

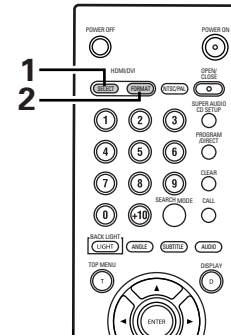
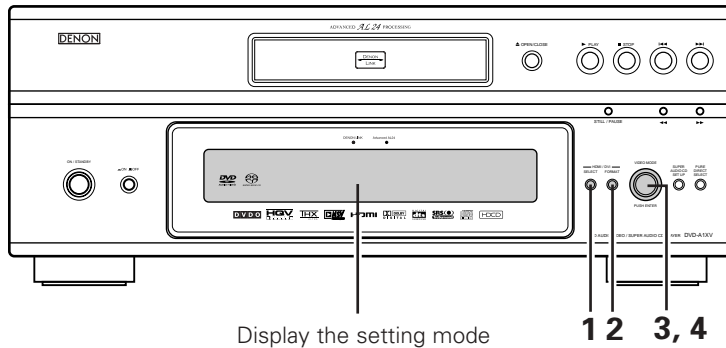

* The HDMI and DVI indicators flash when the connection is being checked, then stop flashing, once the check is completed.

| | | |
|-----------------|---|---|
| <p>1</p> | <p>Press the HDMI/DVI SELECT button.</p> <ul style="list-style-type: none"> The modes described below will appear on the display. <p>HDMI/DVI OFF (Factory default) Not output via the HDMI and DVI-D connectors. Set to "HDMI/DVI OFF" when not connecting to these connectors.</p> <p>HDMI Y Cb Cr The Y Cb Cr format video signals and audio signals are output via the HDMI connector. The RGB format video signals are output via the DVI-D connector.</p> <p>HDMI RGB The RGB format video signals and audio signals are output via the HDMI connector. The RGB format video signals are output via the DVI-D connector.</p> <p>* When connecting to the DVI device via the HDMI connector, signals are output in RGB format regardless of whether "HDMI Y Cb Cr" or "HDMI R G B" is set.</p> | <p>Main unit Remote control unit</p> <p>HDMI / DVI SELECT HDMI/DVI SELECT FORMAT</p> <p>HDMI/DVI OFF</p> <p>HDMI Y Cb Cr</p> <p>HDMI R G B</p> |
| <p>2</p> | <p>Press the HDMI/DVI FORMAT button.</p> <ul style="list-style-type: none"> The modes described below will appear on the display. <p>Select the item you wish to set and define it.</p> <p>480P/576P (Factory default) Outputs the image via the HDMI or DVI-D connector at 480P or 576P.</p> <p>720P Outputs the image via the HDMI or DVI-D connector at 720P.</p> <p>1080i Outputs the image via the HDMI or DVI-D connector at 1080i.</p> <p>AUTO The performance of the HDMI device connected to the HDMI/DVI-D connectors is detected automatically and the signals are output according to the HDMI device's panel resolution or maximum resolution. The panel resolution or maximum resolution is selected according to the setting made at "HDMI AUTO FORMAT" in the initial settings. (By factory default this is set to "PANEL RES.". (See pages 38, 41.)) When a DVI device is connected, the signals are output with a resolution of "480P/576P" automatically, so set the resolution manually.</p> | <p>Main unit Remote control unit</p> <p>HDMI / DVI SELECT HDMI/DVI SELECT FORMAT</p> <p>480P/576P</p> <p>720P</p> <p>1080i</p> <p>AUTO</p> |

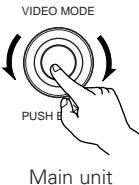
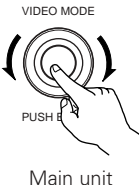
| | | |
|---|---|--|
| <p style="text-align: center; font-size: 2em; font-weight: bold;">3</p> | <p>Turning the VIDEO MODE knob.</p> <ul style="list-style-type: none"> The modes described below will appear on the display. <p>Select the item you wish to set and press the VIDEO MODE knob to define it.</p> <p>PICTURE MODE It is possible to select between five modes at which picture quality settings are stored (M1 to M5) as well as the standard settings set upon shipment from the factory. (See pages 59 ~ 62.)</p> <p>TV SYSTEM Select the video output connected to the TV or monitor whose image you want to view. On the DVD-A1XV, interlace output, progressive output and HDMI/DVI output signals are each processed on independent video circuits. The audio output is optimized for the selected video output, so choose the video output you wish to view.</p> <p>SQUEEZE MODE The various modes that are selected in the VIDEO MODE are temporary. The unit will return to the stored values when the power turns off.</p> <p>AUDIO ADJUST Depending on the connected device, the difference in the time required to process the audio and video signals may result for example in the lips of speaking characters not being synchronized with the sound. If this should happen, this delay can be adjusted by offsetting the output of the audio signals from the DVD-A1XV.</p> <p>* For "TV SYSTEM" and "AUDIO ADJUST" selected at "VIDEO MODE", the change in the setting is stored in the memory. The same setting is set when the power is turned off then back on.</p> <p>* "PICTURE MODE" and "SQUEEZE MODE" selected at "VIDEO MODE" are temporary changes. The settings return to those stored in the memory as the default settings when the power is turned off then back on.</p> | <div style="text-align: center;">  </div> <div style="text-align: center; margin-top: 20px;"> <div style="border: 1px solid black; padding: 5px; width: 100%; margin-bottom: 10px;">PICTURE MODE</div> <div style="border: 1px solid black; padding: 5px; width: 100%; margin-bottom: 10px;">TV SYSTEM</div> <div style="border: 1px solid black; padding: 5px; width: 100%; margin-bottom: 10px;">SQUEEZE MODE</div> <div style="border: 1px solid black; padding: 5px; width: 100%;">AUDIO ADJUST</div> </div> |
| <p style="text-align: center; font-size: 2em; font-weight: bold;">4</p> | <p>When "PICTURE MODE" is selected:</p> <ul style="list-style-type: none"> The modes described below will appear on the display. <p>Select the item you wish to set and press the VIDEO MODE knob to define it. (See pages 59 ~ 62.)</p> <p>STD (STANDARD) Returns the settings to the factory default settings.</p> <p>M1 (MEMORY1) Picture quality adjustment items – M1 (MEMORY1) mode stored in the picture quality adjustment mode.</p> <p>M2 (MEMORY2) Picture quality adjustment items – M2 (MEMORY2) mode stored in the picture quality adjustment mode.</p> <p>M3 (MEMORY3) Picture quality adjustment items – M3 (MEMORY3) mode stored in the picture quality adjustment mode.</p> <p>M4 (MEMORY4) Picture quality adjustment items – M4 (MEMORY4) mode stored in the picture quality adjustment mode.</p> <p>M5 (MEMORY5) Picture quality adjustment items – M5 (MEMORY5) mode stored in the picture quality adjustment mode.</p> | <div style="text-align: center;">  </div> <div style="text-align: center; margin-top: 20px;"> <div style="border: 1px solid black; padding: 5px; width: 100%; margin-bottom: 10px;">STD (STANDARD)</div> <div style="border: 1px solid black; padding: 5px; width: 100%; margin-bottom: 10px;">M1 (MEMORY1)</div> <div style="border: 1px solid black; padding: 5px; width: 100%; margin-bottom: 10px;">M2 (MEMORY2)</div> <div style="border: 1px solid black; padding: 5px; width: 100%; margin-bottom: 10px;">M3 (MEMORY3)</div> <div style="border: 1px solid black; padding: 5px; width: 100%; margin-bottom: 10px;">M4 (MEMORY4)</div> <div style="border: 1px solid black; padding: 5px; width: 100%;">M5 (MEMORY5)</div> </div> |

4

When "TV SYSTEM" is selected:

- The modes described below will appear on the display.
Select the item you wish to set and press the VIDEO MODE knob to define it.

PROGRESSIVE (Factory default)

The audio signals are synchronized with the progressive output.
(For component video output signals when "COMPONENT VIDEO OUT" at "VIDEO SETUP" is set to "PROGRESSIVE")

INTERLACED

The audio signals are synchronized with the interlaced output.
(For video output and S-video output signals, as well as for component video output signals when "COMPONENT VIDEO OUT" at "VIDEO SETUP" is set to "INTERLACED")

HDMI/DVI

The audio signals are synchronized with the video signals output via the HDMI/DVI connectors.

OTHERS

Select this when you want to view both the interlace output/progressive output image and the HDMI/DVI output image at the same time.
The audio signals are set to the optimum timing for the interlace output/progressive output image and the HDMI/DVI output image.
(Note, however, that the audio signals are not synchronized with the interlace output/progressive output image and the HDMI/DVI output image. To synchronize them, set to another position.)

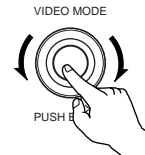

Main unit

PROGRESSIVE

INTERLACED

HDMI/DVI

OTHERS

When "SQUEEZE MODE" is selected:

- The modes described below will appear on the display.
Select the item you wish to set and press the VIDEO MODE knob to define it.

OFF

Select this to display as full size of a 16:9 TV, regardless of the image's size.

ON

Select this to display the image with a ratio of 4:3 at the center of a 16:9 TV, regardless of the image's size.

AUTO

Select this when playing back a 4:3 image, display images with a 4:3 aspect ratio in the center of a 16:9 TV.

OFF

ON

AUTO

When "AUDIO ADJUST" is selected:

- The currently set time is shown on the display.
To change the set time, turn the VIDEO MODE knob, then press the knob. Settable in units of 10 msec between -30 msec and +200 msec. (+ direction: delay the sounds in the picture.)
The setting is reset to the default value (0 msec) when the "TV SYSTEM" setting at "VIDEO SETUP" is switched.







TIME: 0nsec

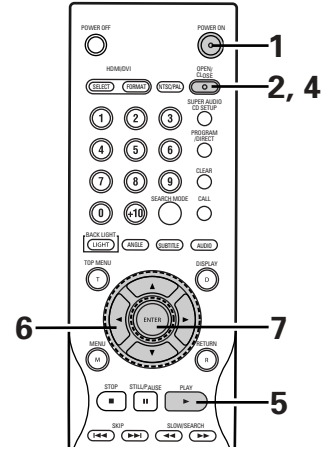
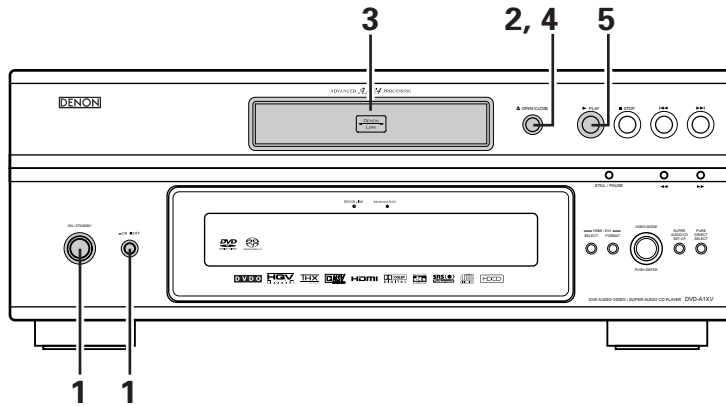

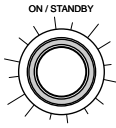
TIME: +10nsec

13 PLAYBACK

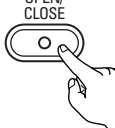
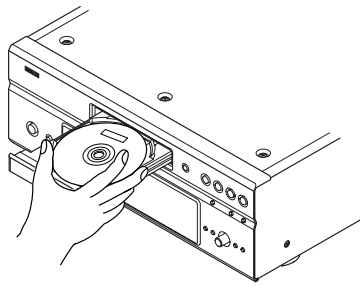
(1) Playback

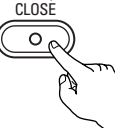

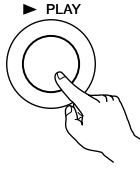
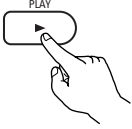
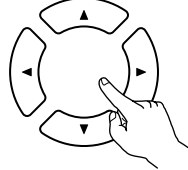
| | | |
|-----------------|--|--|
| <p>1</p> | <p>Turn on the power.</p> <ul style="list-style-type: none"> Press the power button, the power indicator lights green and the power turns on. When pressed again, the power turns off and indicator is off. In the standby mode (the power indicator lights red), press the ON/STANDBY button on the main unit or POWER ON button on the remote control unit (RC-993). | <p>(Green)</p>   <p>Main unit</p> <p>(Red)</p>   <p>Main unit</p> <p>Remote control unit</p> |
| <p>2</p> | <p>Press the OPEN/CLOSE button to open the disc tray.</p> |   <p>Main unit</p> <p>Remote control unit</p> |
| <p>3</p> | <p>Set the disc in the disc tray.</p> |  |
| <p>4</p> | <p>Press the OPEN/CLOSE button.</p> |   <p>Main unit</p> <p>Remote control unit</p> |

| <p>5</p> | <p>Press the PLAY button.</p> <ul style="list-style-type: none"> For many interactive DVDs and video CDs with playback control, a menu screen appears. In this case use the procedure in step 6 to select the desired item. * Interactive DVDs are DVDs including multiple angles, stories, etc. | <div style="display: flex; justify-content: space-around;"> <div style="text-align: center;">  <p>Main unit</p> <p>Example: For DVDs with menu screens</p> <table border="1" style="margin: 0 auto;"> <tr><th colspan="2">TOP MENU</th></tr> <tr><td>Apple</td><td>Banana</td></tr> <tr><td>Orange</td><td>Strawberry</td></tr> <tr><td>Peach</td><td>Pineapple</td></tr> </table> </div> <div style="text-align: center;">  <p>Remote control unit</p> <p>Example: For video CDs with playback control</p> <table border="1" style="margin: 0 auto;"> <tr><td>1. Opening</td></tr> <tr><td>2. 1st movement</td></tr> <tr><td>3. 2nd movement</td></tr> <tr><td>4. 3rd movement</td></tr> <tr><td>5. Ending</td></tr> </table> </div> </div> | TOP MENU | | Apple | Banana | Orange | Strawberry | Peach | Pineapple | 1. Opening | 2. 1st movement | 3. 2nd movement | 4. 3rd movement | 5. Ending |
|-----------------|--|---|----------|--|-------|--------|--------|------------|-------|-----------|------------|-----------------|-----------------|-----------------|-----------|
| TOP MENU | | | | | | | | | | | | | | | |
| Apple | Banana | | | | | | | | | | | | | | |
| Orange | Strawberry | | | | | | | | | | | | | | |
| Peach | Pineapple | | | | | | | | | | | | | | |
| 1. Opening | | | | | | | | | | | | | | | |
| 2. 1st movement | | | | | | | | | | | | | | | |
| 3. 2nd movement | | | | | | | | | | | | | | | |
| 4. 3rd movement | | | | | | | | | | | | | | | |
| 5. Ending | | | | | | | | | | | | | | | |
| <p>6</p> | <p>Use the cursor buttons (▲, ▼, ◀ and ▶) to select the desired item.</p> <ul style="list-style-type: none"> For some discs there is a second menu screen. If so, press the ►► button to display the next menu screen. (See the disc's jacket.) * The cursor buttons (▲, ▼, ◀ and ▶) do not work for video CDs. Use the number buttons to select the desired item. | <div style="text-align: center;">  <p>Remote control unit</p> </div> | | | | | | | | | | | | | |
| <p>7</p> | <p>Press the ENTER button.</p> <ul style="list-style-type: none"> The desired item is selected and playback starts. You can return to the menu screen by pressing the TOP MENU/MENU button while the DVD is playing, though this depends on the disc. Press the RETURN button during playback of a video CD to return to the menu screen. | <div style="display: flex; justify-content: space-around; align-items: center;"> <div style="text-align: center;">  <p>Remote control unit</p> <p>Example: When "Apple" is selected</p> <table border="1" style="margin: 0 auto;"> <tr><th colspan="2">TOP MENU</th></tr> <tr><td>Apple</td><td>Banana</td></tr> <tr><td>Orange</td><td>Strawberry</td></tr> <tr><td>Peach</td><td>Pineapple</td></tr> </table> </div> <div style="font-size: 2em; margin: 0 10px;">→</div> <div style="text-align: center;"> <table border="1" style="margin: 0 auto;"> <tr><td style="padding: 20px 40px;">Apple</td></tr> </table> </div> </div> | TOP MENU | | Apple | Banana | Orange | Strawberry | Peach | Pineapple | Apple | | | | |
| TOP MENU | | | | | | | | | | | | | | | |
| Apple | Banana | | | | | | | | | | | | | | |
| Orange | Strawberry | | | | | | | | | | | | | | |
| Peach | Pineapple | | | | | | | | | | | | | | |
| Apple | | | | | | | | | | | | | | | |

NOTES:

- If  appears on the TV screen while buttons are being operated, that operation is not possible on the DVD-A1XV or with that disc.
- Set the disc in the disc tray.
- Do not place more than one disc in the disc tray.
- The disc keeps turning while the menu screen is displayed on the TV screen.

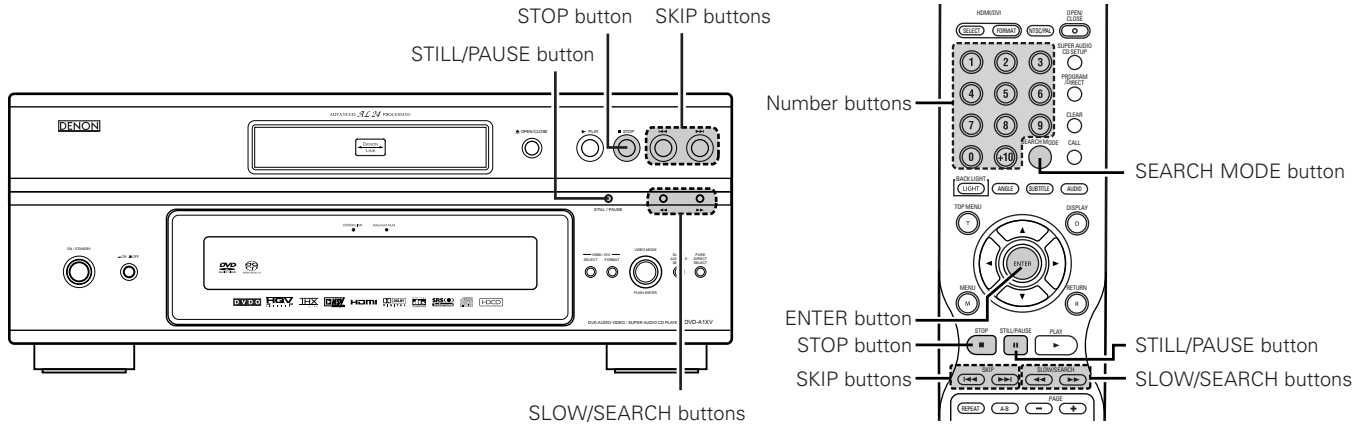

(2) Stopping Playback

During playback, press the STOP button on the main unit or the remote control unit, playback stops and wall paper is displayed. When "AUTO POWER MODE" is selected after 30 minutes in the stop mode, the DVD-A1XV's power automatically turns off and the standby mode is set. (Auto Power Off) (See pages 54, 56.)

<Resume play memory function (DVD only)>

- With the DVD-A1XV, when the STOP button is pressed, that position is stored in the memory. At this time, "▶" flashes on the display. When the PLAY button is pressed after pressing the STOP button, playback resumes from the position at which it was stopped. The resume play memory function is cancelled if the disc tray is opened or the STOP button is pressed a second time.

■ STOP

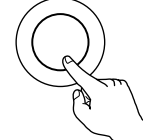

Main unit

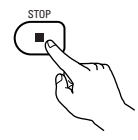

Remote control unit

- * The resume play memory function only works for discs for which the elapsed time is shown on the display during playback.

NOTE:

- The resume play memory function does not work during menu playback of DVD discs.

(3) Playing Still Pictures (Pausing)

During playback, press the STILL/PAUSE button on the main unit or the remote control unit.

- Press the PLAY button to resume normal playback.



Main unit



Remote control unit

(4) Forward/Reverse Searching

During playback, press one of the SLOW/SEARCH buttons on the main unit or the remote control unit.

◀◀ : Reverse direction

▶▶ : Forward direction

- When pressed again, the search speed increases.
- Variable in 4 steps for Super audio CDs and CDs, 7 steps for DVD audio, DVD video and video CD discs.
- Press the PLAY button to resume normal playback.

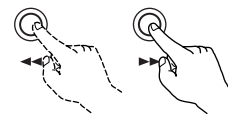

Main unit

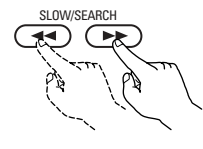

Remote control unit

NOTE:

- In some cases the menu screen may reappear when one of the SLOW/SEARCH buttons is pressed during menu playback on a video CD.

(5) Skipping to the Beginning of Chapters or Tracks

Cueing using the SKIP buttons

During playback, press one of the SKIP buttons on the main unit or the remote control unit.

◀◀ : Reverse direction (PREVIOUS)

▶▶ : Forward direction (NEXT)

- A number of chapters or tracks equal to the number of times the button is pressed is skipped.
- When the SKIP ◀◀ button is pressed once, the pickup returns to the beginning of the currently playing chapter or track.

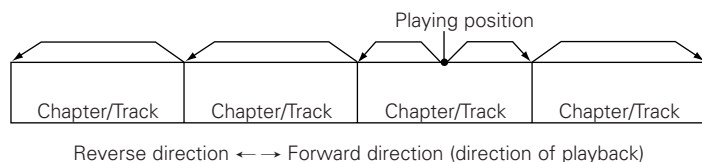

Cueing using the number buttons

Press the SEARCH MODE button during playback.

- The search mode switches each time the button is pressed.
 - For DVD audio discs : Group → Track → (Group) →
 - For DVD video discs : Title → Chapter → (Title) →
 - For Super audio CDs, CDs and video CDs : Track only
- * The search mode set by pressing the SEARCH MODE button is stored in the memory until the button is pressed again. However, the search mode returns to the default mode when the power is turned off.
- Use the number buttons to input the number to be played.

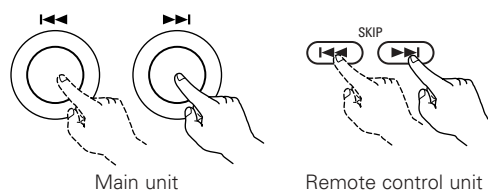

NOTE:

- In some cases the menu screen may reappear when one of the SKIP buttons is pressed during menu playback on a video CD.

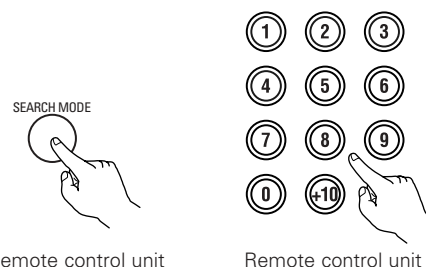

NOTE:

- Some DVD audio, DVD video and video CD discs do not operate as described in this manual due to the intentions of the discs' producers.

(6) Playing Frame by Frame (for DVD-videos and video CDs only)

During playback, press the STILL/PAUSE button on the main unit or the remote control unit.

- The picture moves forward one frame each time the button is pressed.
- Press the PLAY button to resume normal playback.
- With DVD audio discs, forward frame-by-frame skipping is only possible for the video part.



(7) Slow Playback (for DVD-videos and video CDs only)

In the still mode, press one of the SLOW/SEARCH buttons on the main unit or the remote control unit.

◀◀ : Reverse direction

▶▶ : Forward direction

- When pressed again, the slow play speed increases. For video CDs there are three steps.
- Press the PLAY button to resume normal playback.
- With DVD audio discs, the forward slow play function can only be used with the video part.

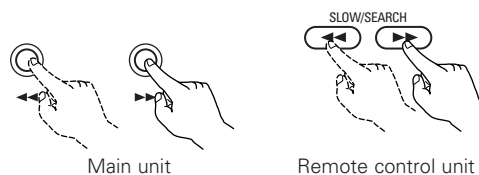

NOTE:

- Reverse slow play is not possible on video CDs.

(8) Selecting the still image (only for DVD-audios)

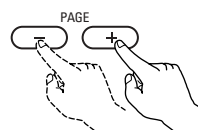

During playback, press the PAGE + or PAGE – button on the remote control unit.

- For DVD audio discs with still images, the desired image can be selected.
- On some discs the image cannot be selected due to the intentions of the discs' producers.

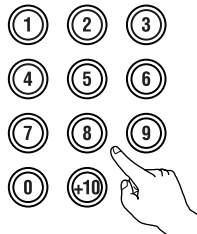

Remote control unit

(9) Playing bonus groups (only for DVD-audios)

| | | |
|---|---|---|
| 1 | In the stop mode, press the SEARCH MODE button on the remote control unit to set the search mode to "GROUP". |  <p>SEARCH MODE</p> Remote control unit |
| 2 | Use the number buttons to input the bonus group number. |  <p>1 2 3 4 5 6 7 8 9 0 +10</p> Remote control unit |
| 3 | Use the number buttons on the remote control unit to input the password (4 digits), then press the ENTER button. <ul style="list-style-type: none">• Playback starts from the first track in the specified group. |  <p>ENTER</p> Remote control unit |
| <ul style="list-style-type: none">• In some cases the password must be input at the menu screen. In these cases, follow the instructions on the screen.• Once the password is input, the disc can be played as many times as you want until it is removed.• If you make a mistake when inputting the password, press the CLEAR button on the remote control unit. | | |

14 PLAYING REPEATEDLY

■ Use this function to play your favourite audio or video sections repeatedly.

Playing Repeatedly (Repeat Playback)

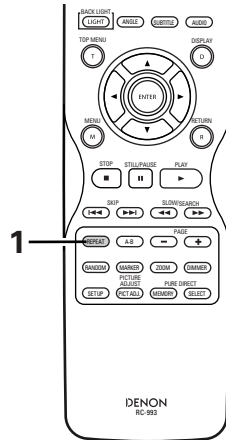

In the play mode, press the REPEAT button.

- The display on the TV screen switches each time the button is pressed, and the corresponding repeat play mode or normal playback mode is set.



Remote control unit

① For DVD audio discs

- Normal playback

- Track repeated

TRACK REPEAT

- Group repeated

GROUP REPEAT

- Repeat playback cancelled

REPEAT OFF

② For DVD video discs

- Normal playback

- Chapter repeated

CHAPTER REPEAT

- Title repeated

TITLE REPEAT

- Repeat playback cancelled

REPEAT OFF

③ For video CDs, Super audio CDs and music CDs

- Normal playback

- Track repeated

TRACK REPEAT

- Entire disc repeated

DISC REPEAT

- Repeat playback cancelled

REPEAT OFF

1

* To return to normal playback:

Return to normal playback by pressing the REPEAT button until "REPEAT OFF" appears on the TV screen.

Playing a Certain Section Repeatedly (A-B Repeat Playback)

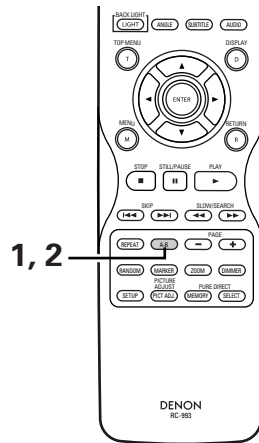

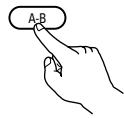
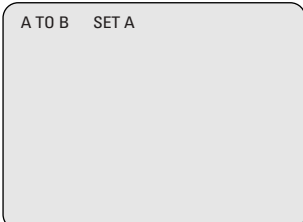
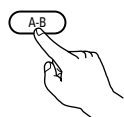
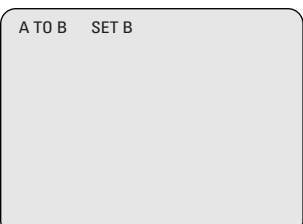
| | | |
|---|--|--|
| <p>1</p> | <p>During playback, press the A-B button.</p> <ul style="list-style-type: none"> This sets start point A. |  <p>Remote control unit</p>  |
| <p>2</p> | <p>Press the A-B button again.</p> <ul style="list-style-type: none"> This sets end point B, and repeat playback of the A-B section starts. |  <p>Remote control unit</p>  |
| <p>* To return to normal playback: Press the A-B button until "A TO B CANCELED" appears on the TV screen.</p> | | |

NOTES:

- Repeat playback may not work for some DVDs.
- The repeat playback and A-B repeat playback functions will not work for DVDs and video CDs for which the elapsed time is not shown on the display during playback.
- In some cases, subtitles may not be displayed near the A and B points during A-B repeat playback.

15 PLAYING TRACKS IN THE DESIRED ORDER

- Use this function with DVD-AUDIO discs, video CDs, Super audio CDs and music CDs to play the tracks in the desired order.
- This function does not affect with DVD-VIDEO discs.

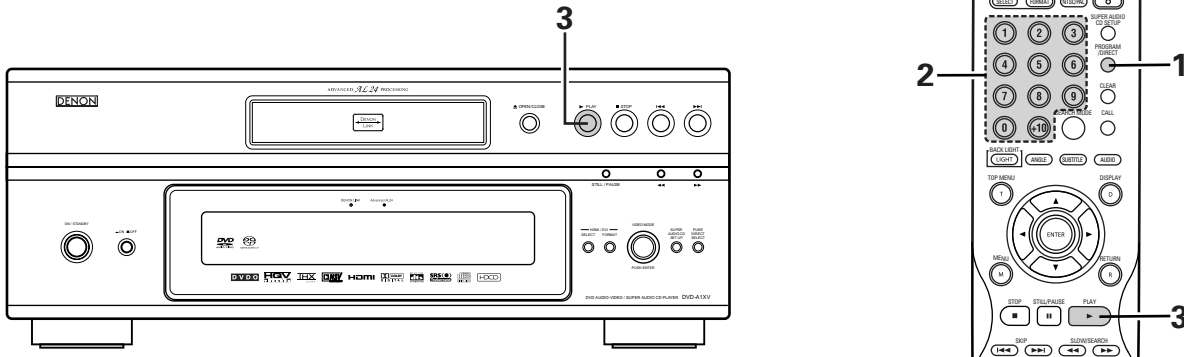

| | | |
|--|---|---|
| <p>1</p> | <p>In the stop mode, press the PROGRAM/DIRECT button once.</p> <ul style="list-style-type: none"> • The program selection screen appears. | <p>Remote control unit</p> |
| <p>2</p> | <p>Use the number buttons to select the track number you want to program.</p> <p>EX: To program track 5 and track 12</p> <ul style="list-style-type: none"> • Press the "5". • Press the "+10" and "2". <p>• With DVD-audio, group numbers can be specified and programmed. Bonus tracks, however, cannot be programmed.</p> | <p>Remote control unit</p> |
| <p>3</p> | <p>Press the PLAY button.</p> <ul style="list-style-type: none"> • Playback of the tracks in the programmed order begins. | <p>Main unit</p> <p>Remote control unit</p> |
| <p>* To return to normal playback: Press the STOP button to stop programmed playback, then press the PROGRAM/DIRECT button. Now press the PLAY button to start normal playback from the beginning of the disc.</p> <p>* To clear tracks from the program: Press the STOP button. The program play screen appears. Press the CLEAR button to clear the last track in the program.</p> <p>* To clear the entire program: The entire program is cleared when the power is turned off or the disc is ejected.</p> <p>* To check the programmed contents, press the CALL button in the stop mode. The programmed contents are displayed step by step.</p> <p>* Up to 20 tracks can be programmed.</p> | | |

16 PLAYING TRACKS IN THE RANDOM ORDER

- Use this function with video CDs, Super audio CDs and music CDs to play the tracks in random order.
With DVD-AUDIO discs, random playback is performed within the selected group.
- This function does not affect with DVD-VIDEO discs.

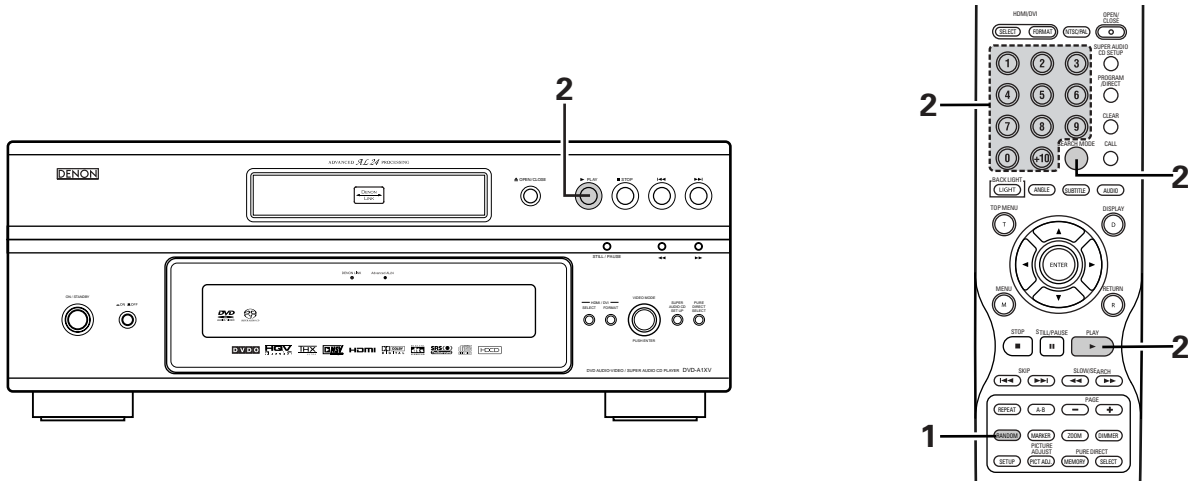

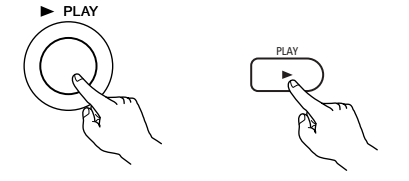
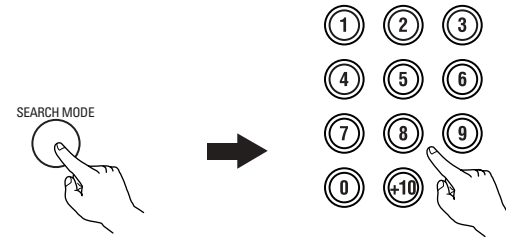
| | | |
|--|---|---|
| <p>1</p> | <p>In the stop mode, press the RANDOM button.</p> <ul style="list-style-type: none"> • The random play screen appears. |  <p>Remote control unit</p> |
| <p>2</p> | <p>Press the PLAY button.</p> <ul style="list-style-type: none"> • The tracks start playing in random order. |  <p>Main unit Remote control unit</p> |
| <p>2</p> | <p>* For DVD audio discs: When operating from the remote control unit, use the buttons to input the number of the group you want to play.</p> |  <p>Remote control unit Remote control unit</p> <p>* for DVD audio discs</p> |
| <ul style="list-style-type: none"> • Random playback is not possible for some discs. * To return to normal playback: Press the STOP button to stop random playback, then press the RANDOM button once. | | |

17 USING THE ON-SCREEN DISPLAY

■ Use this function to display and change information on the disc (titles, chapters, time, etc.)

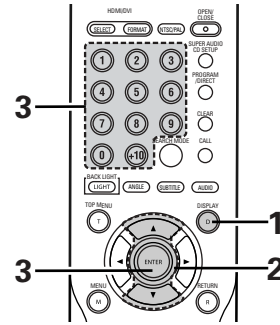

| | | |
|-----------------|---|---|
| <p>1</p> | <p>In the play mode, press the DISPLAY button.</p> <ul style="list-style-type: none"> The On-Screen Display appears. The picture on the TV screen switches each time the button is pressed. The items displayed differ from disc to disc. <div style="display: flex; justify-content: space-around;"> <div style="width: 30%;"> <p>Example: For DVD audio discs</p> <ul style="list-style-type: none"> Normal playback screen </div> <div style="width: 30%;"> <p>Example: For DVD video discs</p> <ul style="list-style-type: none"> Normal playback screen </div> <div style="width: 30%;"> <p>Example: For video CDs, Super audio CDs and music CDs</p> <ul style="list-style-type: none"> Normal playback screen </div> </div> <p>* Some Super audio CDs contain text data. In this case, the album title and artist are displayed in the stop mode, and the title of the currently playing track is displayed in the play mode.</p> | <p>Remote control unit</p> |
| <p>2</p> | <p>Use the ▲ and ▼ cursor buttons to select the item you wish to change.</p> <ul style="list-style-type: none"> The selected item is displayed with a yellow frame. <ol style="list-style-type: none"> For DVD audio discs The elapsed time of groups and tracks can be selected. For DVD video discs The elapsed time of titles, titles and chapters can be selected. For video CDs, Super audio CDs and music CDs The elapsed time of tracks, tracks can be selected. | <p>Remote control unit</p> |
| <p>3</p> | <ol style="list-style-type: none"> Changing the elapsed time Input using the number buttons, then press the ENTER button. Example: For 1 minute 26 seconds → "00126" : DVD/SUPER AUDIO CD ↳ "0126" : VIDEO CD/CD Changing the title, track or chapter <ul style="list-style-type: none"> For DVDs Input using the number buttons, then press the ENTER button. (For some discs it is not possible to change the title or chapter.) For video CDs, Super audio CDs and music CDs Input using the number buttons. Playback starts from that track. | <p>Remote control unit Remote control unit</p> |

18 USING THE MULTIPLE AUDIO, SUBTITLE AND ANGLE FUNCTIONS

Switching the Audio Language (Multiple Audio Function)

- With DVDs containing multiple audio language signals, the audio language can be switched during playback.

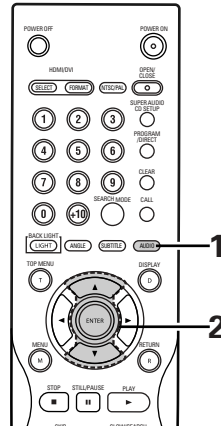

| | | |
|-----------------|---|----------------------------|
| <p>1</p> | <p>During playback, press the AUDIO button.</p> <ul style="list-style-type: none"> • The current audio language number is displayed. | <p>Remote control unit</p> |
| <p>2</p> | <p>Use the ▲ and ▼ cursor buttons to select the desired language.</p> <ul style="list-style-type: none"> • The display turns off when the AUDIO button is pressed. | <p>Remote control unit</p> |





NOTES:

- With some discs it is not possible to change the audio language during playback. In such cases, select from the DVD menu. (See page 79.)
- If the desired language is not set after pressing the ▲ and ▼ cursor buttons several times, the disc does not include that language.
- The language selected in the default settings (See page 35.) is set when the power is turned on and when the disc is replaced.

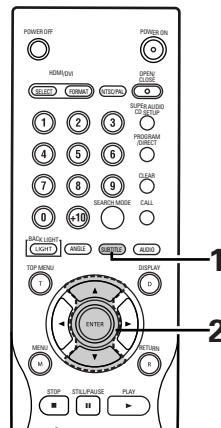
Switching the Subtitle Language (Multiple Subtitle Function)

- With DVDs containing multiple subtitle language signals, the subtitle language can be switched during playback.

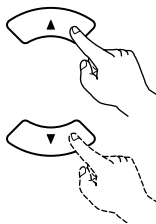

| | | |
|-----------------|--|---|
| <p>1</p> | <p>During playback, press the SUBTITLE button.</p> <ul style="list-style-type: none"> The current subtitle language number is displayed. |  <p>Remote control unit</p>  |
| <p>2</p> | <p>Use the ▲ and ▼ cursor buttons to select the desired language.</p> <ul style="list-style-type: none"> The display turns off when the SUBTITLE button is pressed. |  <p>Remote control unit</p>  |

NOTES:

- If the desired language is not set after pressing the ▲ and ▼ cursor buttons several times, the disc does not include that language.
- The subtitle language set with the default settings (See pages 35, 36.) is set when the power is turned on and when the disc is replaced.
If that language is not included on the disc, the disc's default language is set.
- When the subtitle language is changed, several seconds may be required for the new language to appear.
- When a disc supporting the closed caption is played, the subtitle and the closed caption may overlap each other on the TV monitor. In this case, turn the subtitle off.

Switching the Angle (Multiple Angle Function)

- With DVDs containing multiple angle signals, the angle can be switched during playback.

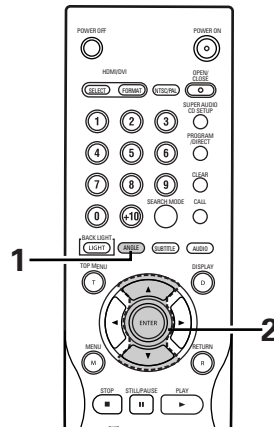

| | | |
|-----------------|--|----------------------------|
| <p>1</p> | <p>During playback, press the ANGLE button.</p> <ul style="list-style-type: none"> • The current angle number is displayed. | <p>Remote control unit</p> |
| <p>2</p> | <p>Use the ▲ and ▼ cursor buttons to select the desired angle.</p> <ul style="list-style-type: none"> • The display turns off when the ANGLE button is pressed. | <p>Remote control unit</p> |

NOTES:



- The multiple angle function only works with discs on which multiple angles are recorded.
- "ANGLE" lights on the main unit's display when playing a section recorded in the multi-angle mode.
- At scenes where multiple angles are recorded, the angle can be switched.

19 USING THE MENUS

Using the Top Menu

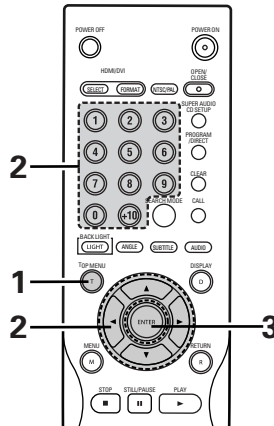
■ For DVDs containing multiple titles, the desired title can be selected and played from the top menu.

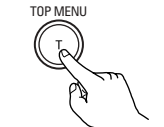
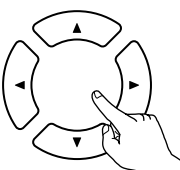
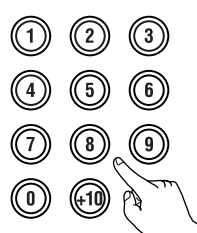

| | | | | | | | | |
|-----------------|--|--|-------|--------|--------|------------|-------|-----------|
| <p>1</p> | <p>During playback, press the TOP MENU button.</p> <ul style="list-style-type: none"> The top menu appears. | <p>Example:</p>  <p>Remote control unit</p> <div data-bbox="1201 829 1461 1021" style="border: 1px solid black; padding: 5px;"> <p style="text-align: center;">TOP MENU</p> <table border="1" style="width: 100%; text-align: center;"> <tr> <td>Apple</td> <td>Banana</td> </tr> <tr> <td>Orange</td> <td>Strawberry</td> </tr> <tr> <td>Peach</td> <td>Pineapple</td> </tr> </table> </div> | Apple | Banana | Orange | Strawberry | Peach | Pineapple |
| Apple | Banana | | | | | | | |
| Orange | Strawberry | | | | | | | |
| Peach | Pineapple | | | | | | | |
| <p>2</p> | <p>Use the cursor or number buttons to select the desired title.</p> <ul style="list-style-type: none"> If you select the title number using the number buttons, skip step 3 below. |  <p>Remote control unit</p>  <p>Remote control unit</p> <div data-bbox="1201 1255 1461 1447" style="border: 1px solid black; padding: 5px;"> <p style="text-align: center;">TOP MENU</p> <table border="1" style="width: 100%; text-align: center;"> <tr> <td>Apple</td> <td>Banana</td> </tr> <tr> <td style="background-color: #cccccc;">Orange</td> <td>Strawberry</td> </tr> <tr> <td>Peach</td> <td>Pineapple</td> </tr> </table> </div> <p>Example: When "Orange" is selected</p> | Apple | Banana | Orange | Strawberry | Peach | Pineapple |
| Apple | Banana | | | | | | | |
| Orange | Strawberry | | | | | | | |
| Peach | Pineapple | | | | | | | |
| <p>3</p> | <p>Press the ENTER button.</p> <ul style="list-style-type: none"> Playback starts. Playback also starts if the PLAY button is pressed. |  <p>Remote control unit</p> | | | | | | |

Using the DVD Menu



Some DVDs include special menus called DVD menus.

For example, DVDs with complex contents may contain guide menus, and DVDs with multiple languages may contain audio and subtitle language menus.

These menus are called "DVD menus".

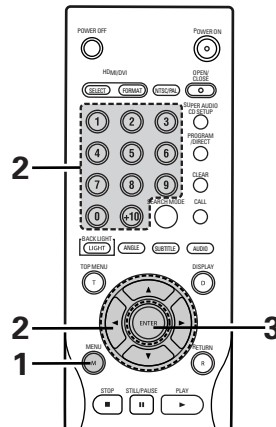
Here we describe the general procedure for using DVD menus.

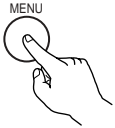
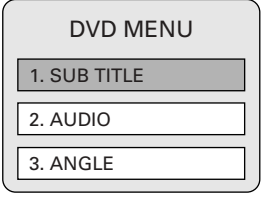
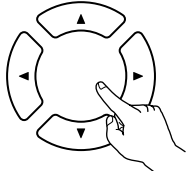
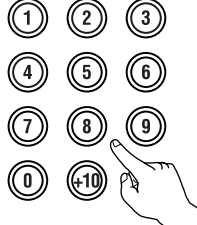
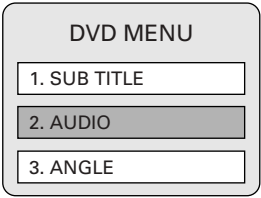

| | | |
|-----------------|---|---|
| <p>1</p> | <p>During playback, press the MENU button.</p> <ul style="list-style-type: none"> The DVD menu appears. | <p>Example:</p>  <p>Remote control unit</p>  |
| <p>2</p> | <p>Use the cursor or number buttons to select the desired item.</p> <ul style="list-style-type: none"> If you select the item using the number buttons, skip step 3 below. |  <p>Remote control unit</p>  <p>Remote control unit</p> <p>Example: "AUDIO" is selected</p>  |
| <p>3</p> | <p>Press the ENTER button.</p> <ul style="list-style-type: none"> The selected item is set. If more menus appear, repeat steps 2 and 3. |  <p>Remote control unit</p> |

20 MARKING SCENES YOU WANT TO SEE AGAIN

■ Set marks at scenes you want to see again so that you can start playback from the marked position whenever you want.

Setting Marks (for DVD-audios and DVD-videos only)

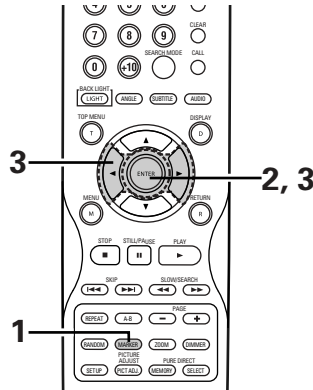

| | | |
|-----------------|--|----------------------------|
| <p>1</p> | <p>During playback, press the MARKER button.</p> <ul style="list-style-type: none"> • The marker screen appears. • Use the ◀ and ▶ cursor buttons to select the “✿” marks. • “✿” is displayed if the mark is not set. | <p>Remote control unit</p> |
| <p>2</p> | <p>Press the ENTER button at the scene you want to mark.</p> <ul style="list-style-type: none"> • A number is displayed. • Up to five marks can be set. (To select another marker, use the cursor buttons (◀, ▶).) | <p>Remote control unit</p> |

Calling Out Marked Scenes and Clearing Marks

| | | |
|--|---|---|
| <p>3</p> | <p>Use the ◀ and ▶ cursor buttons to select the marker number and press the ENTER button.</p> <ul style="list-style-type: none"> • If the marker screen is not displayed during playback, press the MARKER button to display it. | <p>Remote control unit Remote control unit</p> |
| <p>* To clear the marker display: Press the MARKER button.</p> <p>* To clear a marker: Use the ◀ and ▶ cursor buttons to select a marker number and press the CLEAR button.</p> <ul style="list-style-type: none"> • You can clear existing markers, but they are restored when you open the disc tray or switch the unit to standby. | | |

NOTES:

- All the markers added with this unit are cleared when the unit is switched to standby or the disc tray is opened.
- Depending on where the marker is set, subtitles may not be displayed.

21 PLAYING IN THE ZOOM MODE

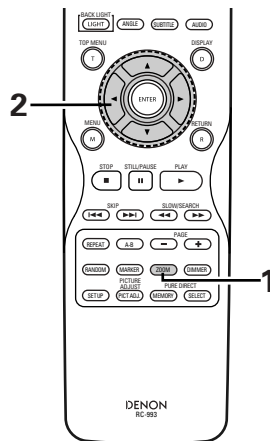

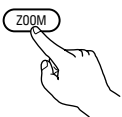
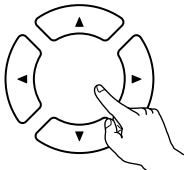
| | | |
|-----------------|---|--|
| <p>1</p> | <p>In the play or pause mode, press the ZOOM button.</p> <ul style="list-style-type: none"> The zoom rate increases each time the ZOOM button is pressed. <p>For DVD video discs and video CDs: OFF → x1.5 → x2 → x4 → OFF</p> <p>For DVD audio discs: OFF → x2 → x4 → OFF</p> |  <p>Remote control unit</p> |
| <p>2</p> | <p>Use the cursor buttons (▼, ▲, ◀ and ▶) to move the zoomed picture.</p> |  <p>Remote control unit</p> |

NOTES:

- Zooming is not possible with some discs.
- The zoom function may not work properly at some scenes.
- Zooming is not possible at the top menu or the menu screen.
- When the picture is enlarged, the picture quality may be decreased and the picture may be blurred.

22 PLAYING MP3

Listening to MP3 CD, CD-Rs and CD-RWs

■ There are many music distribution sites on the internet from which music files in MP3 format can be downloaded. Music downloaded as instructed on the site and written onto a CD-R/RW disc can be played on the DVD-A1XV.

If music recorded on commercially available music CDs is converted on a computer into MP3 files using an MP3 encoder (conversion software), the data on a 12 cm CD is reduced into about 1/10 the amount of the original data. Thus, when written in MP3 format, the data of about 10 music CDs can fit onto the one CD-R/RW disc. The one CD-R/RW disc can contain over 100 tracks.

* Values when 5-minute tracks are converted with a standard bit rate of 128 kbps into MP3 files and using a CD-R/RW disc with a capacity of 650 MB.

* **Uses of recordings you have made other than for your personal enjoyment are not permitted under the Copyright Law without permission of the copyright holder.**

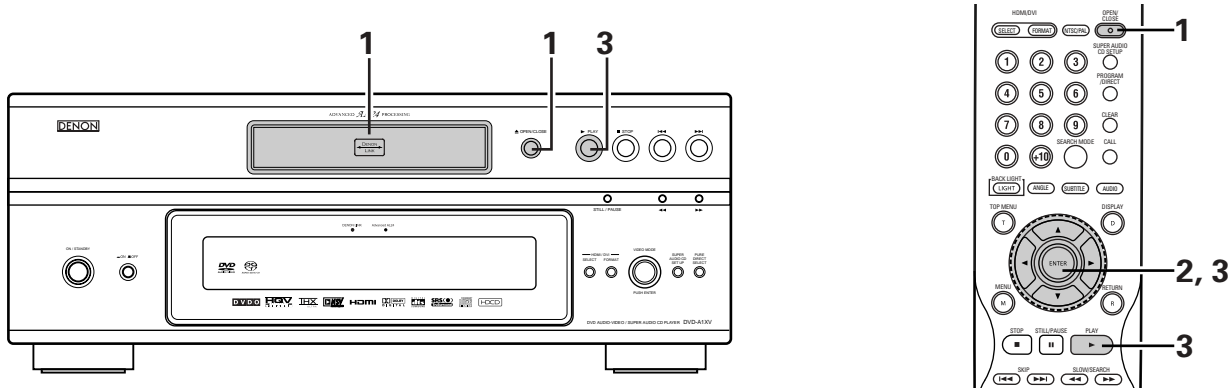

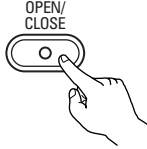
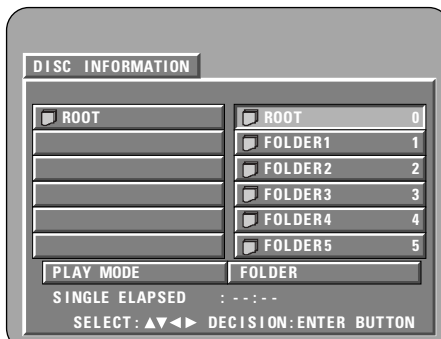
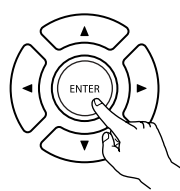
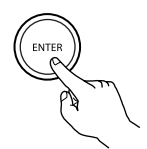
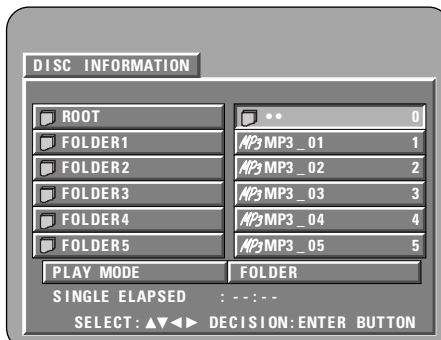
| | | |
|-----------------|--|--|
| <p>1</p> | <p>Load the CD-R/RW disc on which the MP3 format music files have been written into the DVD-A1XV. (See page 30.)</p> <ul style="list-style-type: none"> • When the disc is loaded in the DVD-A1XV, the disc information screen appears. • If there are multiple folders, proceed to step 2. • If there are no folders on the disc, proceed to step 3. | <p>▲ OPEN/CLOSE</p>  <p>Main unit</p>  <p>Remote control unit</p>  |
| <p>2</p> | <p>Use the cursor buttons (▼, ▲, ◀ and ▶) to select the folder containing the file(s) you want to play, then press the ENTER button.</p> <p>* To change the folder</p> <p>Use the cursor buttons to select "ROOT", then press the ENTER button. The screen in step 1 reappears. Select the desired folder.</p> |  <p>Remote control unit</p>  <p>Remote control unit</p>  |

3

Use the ▲ and ▼ cursor buttons to select the MP3 file you want to play, then press the PLAY button or ENTER button.

- Playback starts.

* The display can be switched between the single elapsed time and the single remaining time and the track name by pressing the DISPLAY button.

* Programmed playback is not possible with MP3 discs.

*** To change the MP3 file**

Press the STOP button, then use the ▲ and ▼ cursor buttons to reselect the desired MP3 file.

*** To set the random play mode**

In the stop mode, press the RANDOM button.

Then press the PLAY button or ENTER button.

*** To set the repeat mode**

The repeat mode changes each time the REPEAT button is pressed.



*** To return to the initial disc information screen**

Press the STOP button, use the cursor button to select "ROOT", then press the ENTER button.

The screen in step 1 reappears.



Remote control unit

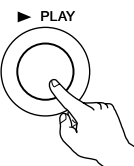

Main unit

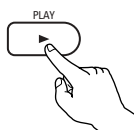

Remote control unit

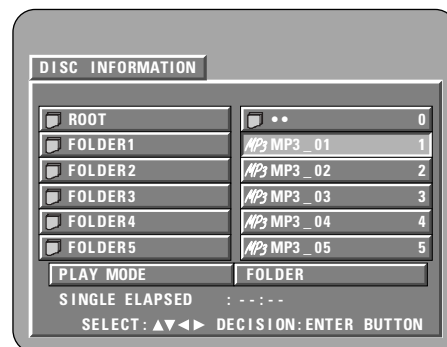

NOTES:

- The DVD-A1XV is compatible with the "MPEG-1 Audio Layer 3" standards (sampling frequency of 44.1 kHz or 48 kHz). It is not compatible with such other standards as "MPEG-2 Audio Layer 3", "MPEG-2.5 Audio Layer 3", MP1, MP2, etc.
- It may not be possible to play some CD-R/RW discs due to disc properties, dirt, warping, etc.
- The digital signals output when playing MP3 files are MP3 signals converted into PCM, regardless of whether the audio output presetting is set to "NORMAL" or "PCM". The signals are output with the same sampling frequency as that of the music source.
- In general, the higher an MP3 file's bit rate, the better the sound quality. On the DVD-A1XV, we recommend using MP3 files recorded with bit rates of 128 kbps or greater.
- MP3 files may not be played in the expected order, since the writing software may change the position of the folders and the order of the files when writing them on the CD-R/RW.
- Programmed playback are not possible with MP3 discs.
- When writing MP3 files on CD-R/RW discs, select "ISO9660 level 1/ level 2" as the writing software format. This may not be possible with some types of writing software. For details, refer to the writing software's usage instructions.
- The number of files playable with the DVD-A1XV is approximately 600 or less.
- With the DVD-A1XV it is possible to display folder names and file names on the screen like titles. The DVD-A1XV can display up to 8 characters, consisting of numbers, capital letters, and the "_" (underscore) mark.
- If recorded in a format other than "ISO9660 level 1", normal display and playback may not be possible. In addition, folder and file names including other symbols will not be displayed properly.
- Be sure to add the extension ".MP3" to MP3 files. Files cannot be played if they have any extension other than ".MP3" or if they have no extension. (with Macintosh computers, MP3 files can be played by adding the extension ".MP3" after the file name consisting of up to 8 capital or numbers and recording the files on the CD-R/RW.)
- Do not apply stickers, tape, etc., to either the label side or the signal side of CD-R/RW discs. If adhesive gets on the surface of a disc, the disc may get stuck inside the DVD-A1XV and be impossible to eject.
- The DVD-A1XV is not compatible with packet write software.
- The DVD-A1XV is not compatible with ID3-Tag.
- The DVD-A1XV is not compatible with play lists.
- The DVD-A1XV is not compatible with MP3 PRO.
- Do not play CD-R/RW discs containing any files other than music CD files (in CDDA format), WMA, MP3 and JPEG files. Doing so may result in malfunction or damage, depending on the type of file.

23 PLAYING WMA

■ Listening to WMA (Windows Media Audio) CD-R/CD-RW

- This unit can play CD-R/RW music files that have been recorded in the WMA (Windows Media Audio)* audio compression format.



Windows Media and the Windows logo are trademarks, or registered trademarks of Microsoft Corporation in the United States and/or other countries.

* WMA (Windows Media Audio): Audio coding of Microsoft Corporation.

*** Uses of recordings you have made other than for your personal enjoyment are not permitted under the Copyright Law without permission of the copyright holder.**

- The method of playback is the same as "Listening to MP3 CD, CD-Rs and CD-RWs" on Pages 83, 84.
 - In the file display of the disc information screen, WMA files will be displayed with the "WMA" icon instead of the "MP3" icon. (Files for which the "WMA" icon is not displayed cannot be played. There will be a skip and the next file with an icon will be played.)

NOTES:

- Files recorded with a sampling frequency of 44.1 kHz, and 48 kHz are supported.
- Programmed playback cannot be performed with WMA discs.
- The digital output at the time of WMA file playback is converted to PCM regardless of the initial settings.
- Please use discs that have been recorded in conformity with the ISO 9660 level 1/level 2 CD-ROM file system. (Extended formats are excluded.)
- Copyright protected files cannot be played. Also note that depending on the writing software and conditions, playback might not be possible, or the files might not be displayed properly.
- Playback of the CD-R/RW might not be possible depending on the disc characteristics, soiling, scratches, and other factors.
- Bit rates of 64 k to 160 kbps are supported for WMA files that have an extension of ".wma" or ".WMA".
- This unit can display the folder names and file names on the screen. Up to 11 half-width alphanumeric upper case characters and symbols (including the underscore symbol) can be displayed. Kanji, hiragana, katakana and other characters cannot be displayed.
- While in the stop condition, the DISPLAY button of the remote control can be used to switch and display the title names and the artist names. (One folder has a capacity of up to 99 files.)
- Recorded discs with no more than 99 files per folder are recommended. Multiple folder configurations are possible; however, depending on the configuration, recognition and playback of all the folders and files might not be possible.
- Multi-session discs can also be played back, however, playback of discs that have had session closure within 10 sessions.
- Direct track selection using the remote control numerical keys (0 to 9, and +10) can specify up to 179 tracks (179 files) per folder. When 179 tracks are exceeded, while the unit is stopped, use the cursor buttons at the disc information screen to select the files, and use the play button or the ENTER button to play.

24 PLAYING STILL PICTURE FILES (JPEG FORMAT)

■ JPEG files stored on Kodak picture CDs, Fujicolor CDs, CD-Rs and CD-RWs can be played as a slide show and enjoyed on the DVD-A1XV.

Playing still picture

■ Kodak picture CDs and Fujifilm Fujicolor CDs can be played on the DVD-A1XV. When a CD (recording still picture) is played, the photographs on the CD can be displayed on a TV.

("Picture CD" and "Fujicolor CD" are service by which photographs taken on conventional silver film cameras are converted into digital data and written on CDs. For details on Kodak picture CD, contact a store that offers Kodak development services. For details about Fujicolor CDs, please contact a store offering Fuji Photo Film developing services.)

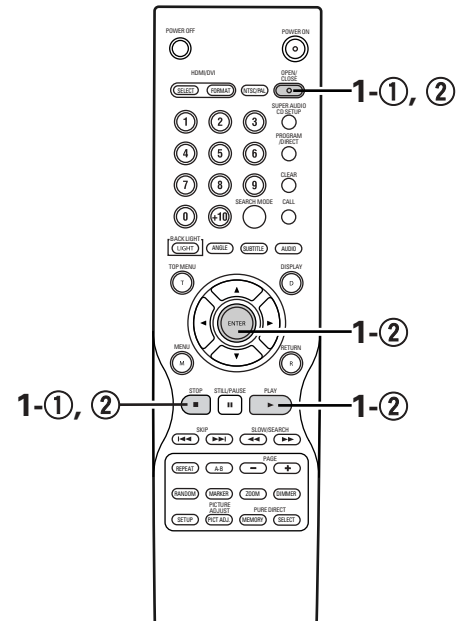
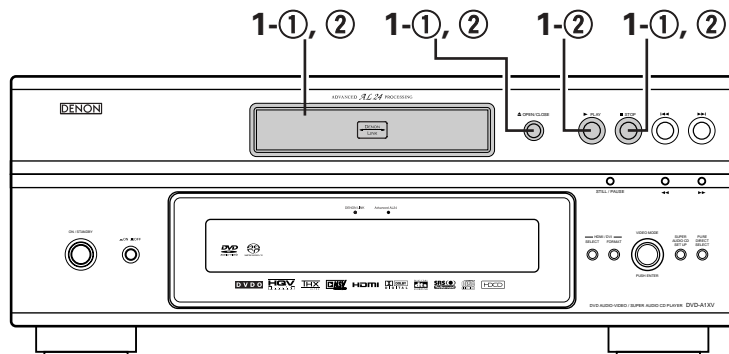

1

- ① Load the Kodak picture CD into the DVD-A1XV.
 - When the disc is loaded, a slide show of the still pictures begins automatically.
 - The slide show continues until the STOP button is pressed.
- ② Load the Fujicolor CD into the DVD-A1XV.
 - When the disc is loaded, a maximum of 9 still pictures are displayed automatically.
 - Press the PLAY or ENTER button, the slide show begins. The slide show continues until the STOP button is pressed.

Playing still pictures stored on CD-Rs/RWs

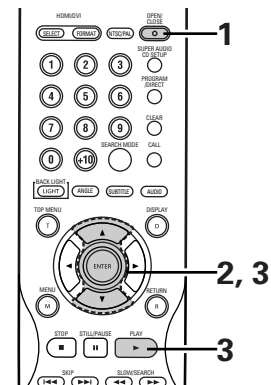
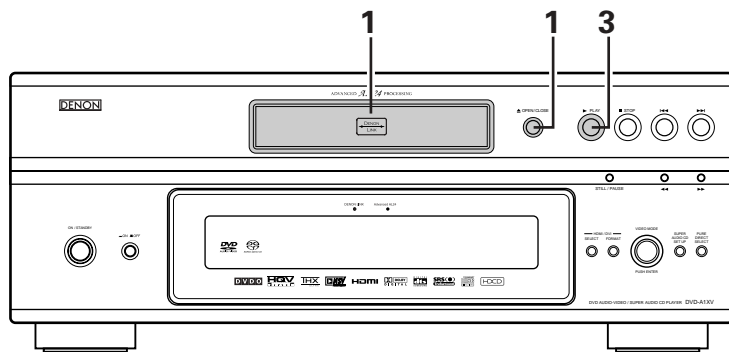

1

- 1 Load the CD-R/RW on which the still pictures have been written into the DVD-A1XV.
 - When the disc is loaded in the DVD-A1XV, the disc information screen appears.
 - If there are multiple folders, proceed to step 2.
 - If there are no folders on the disc, proceed to step 3.

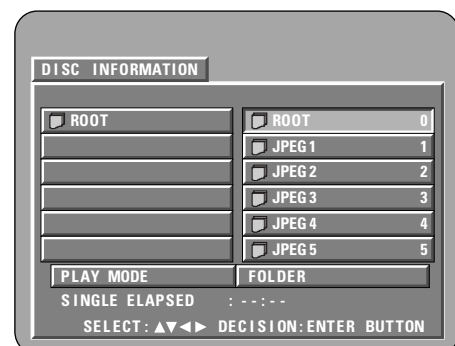

2

Use the ▲ and ▼ cursor buttons to select the folder containing the file(s) you want to play, then press the ENTER button.

*** To change the folder**

Use the cursor button to select "ROOT", then press the ENTER button. The screen in step 1 reappears. Select the desired folder.

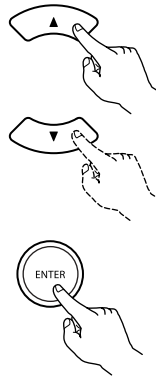

Remote control unit

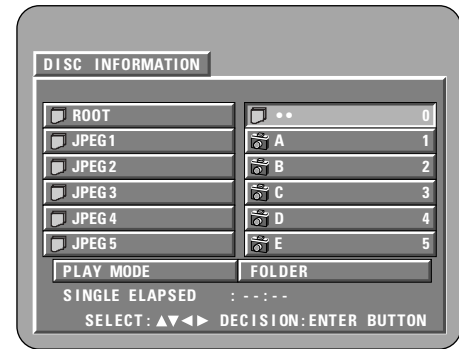

3

Use the ▲ and ▼ cursor buttons on the remote control unit to select the still picture file from which you want to start the slide show, then press the PLAY button or the ENTER button on the remote control unit.

- The slide show starts.
- Only the still picture files in the selected folder are played.

* Once all the still picture files in the folder have been played, the disc information screen reappears.

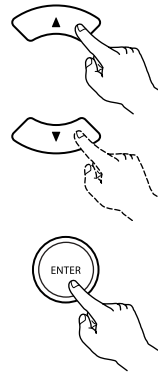

Remote control unit

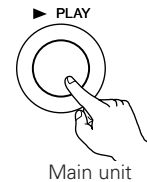
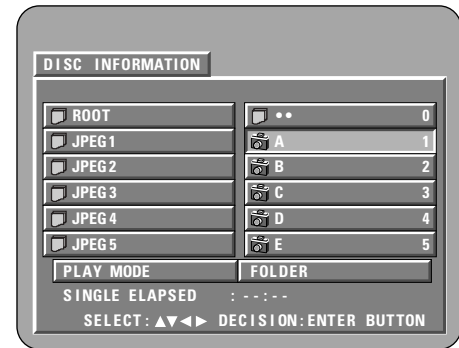

Main unit

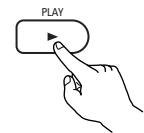

Remote control unit

- * To view several of the still pictures stored on the disc at once:
 - To select and view a still picture (to start the slide show from a specific still picture), use the cursor buttons (▼, ▲, ◀ and ▶) to select the desired still picture, then press the ENTER button.
- * To temporarily stop the slide show:
 - Press the STILL/PAUSE button.
 - To resume the slide show, press the PLAY button.
- * To cue a still picture you want to view (from which you want to start the slide show):
 - During the slide show, press one of the SKIP (◀◀, ▶▶) buttons. Press the SKIP ◀◀ button to cue back to the previous still picture, the SKIP ▶▶ button to cue ahead to the next still picture.
- * Flipping and rotating still pictures:
 - Use the cursor buttons (▼, ▲, ◀ and ▶) to flip the still picture.
 - ▲ cursor button: The currently displayed still picture is flipped vertically.
 - ▼ cursor button: The currently displayed still picture is flipped horizontally.
 - ◀ cursor button: The currently displayed still picture is rotate 90° counterclockwise.
 - ▶ cursor button: The currently displayed still picture is rotate 90° clockwise.
- * Play the image in the zoom mode.
 - When the ZOOM button is pressed while playing a JPEG image ("ZOOM ON" is displayed on the screen at this time) zoom in and zoom out using the search keys.
 - ◀◀: zoom out, ▶▶: zoom in
 - When the image is zoomed, use the cursor buttons (▼, ▲, ◀ and ▶) to move the zoomed picture.
 - Continuous playback (SLIDE SHOW) is not possible in the zoom mode.
 - Zooming is not possible with files that have a low resolution.
- * The way of switching to the next image during continuous JPEG image playback (SLIDE SHOW) can be selected.
 - Preset the SEARCH MODE button on the remote control unit.
 - Select from SLIDE SHOW MODE:1 to MODE: 11, MODE: RAND and MODE: NONE.

Special play modes for WMA and MP3 and JPEG files

Use the ◀ and ▶ cursor buttons to select the play mode, the ▲ and ▼ cursor buttons to select the special play mode.

- FOLDER (the WMA and MP3 and JPEG files in the folder are played in order starting from the selected file)
- FOLDER REPEAT (all the WMA and MP3 and JPEG files in the folder are played repeatedly starting from the selected file)
- DISC (all the WMA and MP3 and JPEG files on the disc are played in order starting from the selected file)
- DISC REPEAT (all the WMA and MP3 and JPEG files on the disc are played repeatedly starting from the selected file)
- RANDOM ON (all the WMA and MP3 and JPEG files in the folder are played in random order starting from the selected file)
- TRACK REPEAT (the select WMA or MP3 or JPEG file is played repeatedly)

NOTES:

- The DVD-A1XV is compatible with image data stored in JPEG format, but Denon does not guarantee that all image data stored in JPEG format can be viewed.
- Files with sizes of up to 30 Mbytes can be displayed.
- It may not be possible to play some CD-Rs/RWs due to disc properties, dirt, scratches, etc.
- When storing JPEG files on the CD-R/RW, set the writing program to store the files in the "ISO9660 level 1/ level 2" format.
- Be sure to give JPEG files the extension ".JPG" and ".JPE". Files with other extensions or with no extensions cannot be viewed on the DVD-A1XV.
- Do not apply stickers, tape, etc., to either the label side or the signal side of CD-R/RW discs. If adhesive gets on the surface of a disc, the disc may get stuck inside the DVD-A1XV and be impossible to eject.
- Do not play CD-R/RW discs containing any files other than music CD files (in CDDA format), WMA, MP3 and JPEG files. Doing so may result in malfunction or damage, depending on the type of file.
- JPEG files written using Macintosh computers cannot be played.

25 TROUBLESHOOTING

Check again before assuming the player is malfunctioning

- Are all the connections correct ?
- Are you following the instructions in the manual ?
- Are the amplifier and speakers operating properly ?

If the DVD-A1XV does not seem to be functioning properly, check the table below. If this does not solve the problem, the DVD-A1XV may be damaged. Turn off the power, unplug the power cord from the power outlet, and contact your store of purchase or nearest Denon sales office.

| Symptom | Check | Page |
|--|---|---|
| Power does not turn on. | <ul style="list-style-type: none"> • Plug the power supply cord securely into the power outlet. | 12~22, 25 |
| Playback does not start when PLAY button is pressed. Playback stops immediately. | <ul style="list-style-type: none"> • Is there condensation on the disc or player ? (Let stand for 1 or 2 hours.) • Discs other than DVDs, SuperAudio CDs, video CDs and music CDs cannot be played. • Disc is dirty. Wipe off the dirt. | – 10 11 |
| Picture does not appear. | <ul style="list-style-type: none"> • Check the connections. • Check that VIDEO OUT has not been set to "VIDEO OUT:OFF" or "ALL OFF" for PURE DIRECT MODE. • Set the TV's input to "video". | 12~22 57, 58 – |
| Sound is not produced or sound quality is poor. | <ul style="list-style-type: none"> • Check the connections. • Properly set the input of the TV, stereo, etc. • Check the "DIGITAL OUTPUT" and "COMPRESSION" settings. • Digital signals cannot be output with Super audio CDs. Use analog or DENON LINK 3rd or IEEE1394 connections. • Area/layer of Super audio CD being played (MULTI/STEREO/CD) does not match amplifier connections. • When the video output setting at "PURE DIRECT" is set to "VIDEO OUT : OFF" or "ALL OFF", no sound at HDMI connector. • When a device not compatible with HDMI specification Ver. 1.1 is connected via an HDMI connector, the audio signals of DVD audio discs copyright-protected by CPPM are not output. | 12~22 – 46, 50, 51 16~20 16, 17, 58 57, 58 21 |
| Menu playback of video CD's is not possible. | <ul style="list-style-type: none"> • Menu playback is not possible with anything but video CDs with playback control. | 67 |
| Picture is disturbed during the search operation. | <ul style="list-style-type: none"> • Some disturbance is normal. | – |
| Buttons do not operate. | <ul style="list-style-type: none"> • Some operations are disabled for some discs. | 67 |
| No subtitles are displayed. | <ul style="list-style-type: none"> • Subtitles are not displayed for DVDs not containing subtitles. • Subtitles are turned off. Turn the subtitles setting on. | – 35, 36 |
| Audio (or subtitle) language does not switch. | <ul style="list-style-type: none"> • The audio (or subtitle) language does not switch for discs which do not include multiple audio (or subtitle) languages. • For some discs the audio (or subtitle) language cannot be switched when the operation to switch it is performed, but can be switched on the menu screens. | 76, 77 80 |
| Angle does not switch. | <ul style="list-style-type: none"> • The angle cannot be switched for DVDs which do not contain multiple angles. In some cases multiple angles are only recorded for specific scenes. | 78 |
| Playback does not start when the title is selected. | <ul style="list-style-type: none"> • Check the "RATINGS" setting. | 52, 53 |
| The password for rating level has been forgotten. Reset all the setting to Factory Preset. | <ul style="list-style-type: none"> • While the player is in the stop mode, hold the player's SKIP ►►► button and the PLAY button down simultaneously and then hold the OPEN/CLOSE button down for longer than 3 seconds (until "INITIALIZE" disappears from the TV monitor). The lock will be released and all default settings and picture settings will return to the default values. | – |
| The disc is not played with the audio or subtitle language set as the default setting. | <ul style="list-style-type: none"> • The disc does not play with the selected audio or subtitle language if that audio or subtitle language is not included on that DVD. | 35~37 |
| Picture is not displayed in 4:3 (or 16:9). | <ul style="list-style-type: none"> • Set the "TV ASPECT" default setting to the proper setting for the connected TV. | 43 |

| Symptom | Check | Page |
|---|--|--------------------------------------|
| Menu screen messages for the desired language do not display. | <ul style="list-style-type: none"> • Check the setting of "DISC MENUS" under "LANGUAGE SETUP" in "SETUP". | 35~37 |
| An image is not projected with an HDMI/DVI connection. | <ul style="list-style-type: none"> • Check the HDMI/DVI connection.(Check the status of the HDMI/DVI indicators.) • Check whether the connected monitor equipment or other equipment supports HDCP. (The DVD-A1XV will not output a video signal unless the connected equipment supports HDCP.) • Check the settings of "HDMI/DVI SELECT". • Check whether the output format of the DVD-A1XV (HDMI/DVI FORMAT) matches the input format of the connected equipment. • Check whether the video output setting at "PURE DIRECT" is set to "VIDEO OUT : OFF" or "ALL OFF". | 25 20~22 63 20~22 57, 58 |
| Picture and sound are interrupted with HDMI/DVI connections. | <ul style="list-style-type: none"> • When the "HDMI/DVI FORMAT" setting is set to "AUTO", the picture or sound may be interrupted when cables are connected or disconnected or depending on the conditions of the connected device(s). | 63 |
| Remote control unit does not operate. | <ul style="list-style-type: none"> • Check that the batteries are inserted in the proper "⊕" and "⊖" directions. • The batteries are dead. Replace them with new batteries. • Point the remote control unit at the remote control sensor when operating it. • Operate the remote control unit within a distance of 7 meters from the remote control sensor. • Remove the obstacle between the remote control unit and remote control sensor. | 27 27 27 27 27 |

26 MAIN SPECIFICATIONS

| | |
|-------------------------------------|---|
| Signal system: | NTSC/PAL |
| Applicable discs: | (1) DVD-Audio/DVD-Video discs 1-layer 12 cm single-sided discs, 2-layer 12 cm single-sided discs, 2-layer 12 cm double-sided discs (1 layer per side) 1-layer 8 cm single-sided discs, 2-layer 8 cm single-sided discs, 2-layer 8 cm double-sided discs (1 layer per side) (2) Super audio CDs Single layer 12 cm discs, Dual layer 12 cm discs, Hybrid layer 12 cm discs (3) Compact discs (CD-DA, Video CD) 12 cm discs, 8 cm discs |
| S-Video output: | Y output level : 1 Vp-p (75 Ω/ohms) C output level: 0.3 Vp-p (75 Ω/ohms) Output connector : S connectors, 2 sets / AV 1 connector, 1 set |
| Video output: | Output level : 1 Vp-p (75 Ω/ohms) Output connector : Pin jacks, 2 sets / AV 1 connector, 1 set |
| Component output: | Y output level : 1 Vp-p (75 Ω/ohms) PB/CB output level : 0.7 Vp-p (75 Ω/ohms) PR/CR output level : 0.7 Vp-p (75 Ω/ohms) Output connector : Pin jack, 1 set / BNC jack, 1 set |
| HDMI output: | Output connector : HDMI connector, 1 set |
| DVI output: | Output connector : DVI-D connector, 1 set |
| RGB output: | Output level : 0.7 Vp-p (75 Ω/ohms) Output connector : AV 1 connector, 1 set |
| Audio output: | Output level : 2 Vrms 2 channel (L, R) output connector : Pin jack, 1 set AV 1 connector, 1 set Multi channel (FL, FR, C, SW, SL, SR) output connector : Pin jack, 1 set |
| Audio output properties: | (1) Frequency response ① DVDs (linear PCM) : 2 Hz to 22 kHz (48 kHz sampling) : 2 Hz to 44 kHz (96 kHz sampling) : 2 Hz to 88 kHz (192 kHz sampling) ② Super audio CDs : 2 Hz to 100 kHz ③ CDs : 2 Hz to 20 kHz (2) S/N ratio : 125 dB (3) Total harmonic distortion : 0.0008 % (4) Dynamic range : 112 dB |
| Digital audio output: | Optical digital output : Optical connector, 1 set Coaxial digital output : Pin jack, 1 set DENON LINK output : DENON LINK connector, 1 set IEEE 1394 terminal : IEEE 1394 connectors, 2 sets |
| Power supply: | AC 230 V, 50 Hz |
| Power consumption: | 80 W |
| Maximum external dimensions: | 434 (width) x 170 (height) x 432 (depth) mm (including protruding parts) |
| Mass: | 19 kg |
| Remote control unit: | RC-993 |
| Type: | Infrared pulse |
| Power supply: | DC 4.5 V, 3 R6P/AA batteries |

This product incorporates copyright protection technology that is protected by U.S. patents and other intellectual property rights. Use of this copyright protection technology must be authorized by Macrovision, and is intended for home and other limited viewing uses only unless otherwise authorized by Macrovision. Reverse engineering or disassembly is prohibited.

* Design and specifications are subject to change without notice in the course of product improvement.

DENON

TOKYO, JAPAN
www.denon.com

Denon Brand Company, D&M Holdings Inc.
00D 511 4289 039A

Free Manuals Download Website

<http://myh66.com>

<http://usermanuals.us>

<http://www.somanuals.com>

<http://www.4manuals.cc>

<http://www.manual-lib.com>

<http://www.404manual.com>

<http://www.luxmanual.com>

<http://aubethermostatmanual.com>

Golf course search by state

<http://golfingnear.com>

Email search by domain

<http://emailbydomain.com>

Auto manuals search

<http://auto.somanuals.com>

TV manuals search

<http://tv.somanuals.com>