

DENON

Professional DIGITAL DJ Mixer

DN-X1600

Owner's Manual

SAFETY PRECAUTIONS



CAUTION

RISK OF ELECTRIC SHOCK

DO NOT OPEN



CAUTION:
TO REDUCE THE RISK OF ELECTRIC SHOCK, DO NOT REMOVE COVER (OR BACK). NO USER-SERVICEABLE PARTS INSIDE. REFER SERVICING TO QUALIFIED SERVICE PERSONNEL.

The lightning flash with arrowhead symbol, within an equilateral triangle, is intended to alert the user to the presence of uninsulated "dangerous voltage" within the product's enclosure that may be of sufficient magnitude to constitute a risk of electric shock to persons.

The exclamation point within an equilateral triangle is intended to alert the user to the presence of important operating and maintenance (servicing) instructions in the literature accompanying the appliance.

WARNING:
TO REDUCE THE RISK OF FIRE OR ELECTRIC SHOCK, DO NOT EXPOSE THIS APPLIANCE TO RAIN OR MOISTURE.

CAUTION:

1. Handle the power supply cord carefully

Do not damage or deform the power supply cord. If it is damaged or deformed, it may cause electric shock or malfunction when used. When removing from wall outlet, be sure to remove by holding the plug attachment and not by pulling the cord.

2. Do not open the top cover

In order to prevent electric shock, do not open the top cover. If problems occur, contact your DENON dealer.

3. Do not place anything inside

Do not place metal objects or spill liquid inside the DJ mixer. Electric shock or malfunction may result.

Please, record and retain the Model name and serial number of your set shown on the rating label.

Model No. DN-X1600

Serial No. _____

LABELS:

CAUTION
 TO PREVENT ELECTRIC SHOCK, MATCH WIDE BLADE OF PLUG TO WIDE SLOT, FULLY INSERT.

ATTENTION
 POUR ÉITER LES CHOCS ÉLECTRIQUES, INTERODUIRE LA LAME LA PLUS LARGE DE LA FICHE DANS LA BORNE CORRESPONDANTE DE LA PRISE ET POUSSER JUSQU' AU FOND.

FCC INFORMATION (For US customers)

1. COMPLIANCE INFORMATION

Product Name: DJ Mixer
Model Number: DN-X1600

This product complies with Part 15 of the FCC Rules. Operation is subject to the following two conditions: (1) this product may not cause harmful interference, and (2) this product must accept any interference received, including interference that may cause undesired operation.

Denon Professional div. D&M Professional
 1100 Maplewood Drive Itasca, IL 60143
 Tel. 630-741-0330

2. IMPORTANT NOTICE: DO NOT MODIFY THIS PRODUCT

This product, when installed as indicated in the instructions contained in this manual, meets FCC requirements. Modification not expressly approved by DENON may void your authority, granted by the FCC, to use the product.

3. NOTE

This product has been tested and found to comply with the limits for a Class B digital device, pursuant to Part 15 of the FCC Rules. These limits are designed to provide reasonable protection against harmful interference in a residential installation.

This product generates, uses and can radiate radio frequency energy and, if not installed and used in accordance with the instructions, may cause harmful interference to radio communications. However, there is no guarantee that interference will not occur in a particular installation. If this product does cause harmful interference to radio or television reception, which can be determined by turning the product OFF and ON, the user is encouraged to try to correct the interference by one or more of the following measures:

- Reorient or relocate the receiving antenna.
- Increase the separation between the equipment and receiver.
- Connect the product into an outlet on a circuit different from that to which the receiver is connected.
- Consult the local retailer authorized to distribute this type of product or an experienced radio/TV technician for help.
- Increase the separation between the equipment and receiver.
- Connect the product into an outlet on a circuit different from that to which the receiver is connected.
- Consult the local retailer authorized to distribute this type of product or an experienced radio/TV technician for help.

This Class B apparatus complies with Canadian ICES-003.

Cet appareil numérique de la classe B est conforme à la norme NMB-003 du Canada.

IMPORTANT SAFETY INSTRUCTIONS







READ BEFORE OPERATING EQUIPMENT

This product was designed and manufactured to meet strict quality and safety standards. There are, however, some installation and operation precautions which you should be particularly aware of.

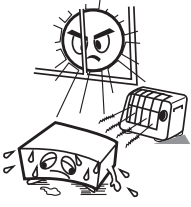
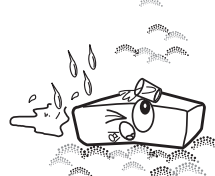
1. Read these instructions.
2. Keep these instructions.
3. Heed all warnings.
4. Follow all instructions.
5. Do not use this apparatus near water.
6. Clean only with dry cloth.
7. Do not block any ventilation openings. Install in accordance with the manufacturer's instructions.
8. Do not install near any heat sources such as radiators, heat registers, stoves, or other apparatus (including amplifiers) that produce heat.
9. Do not defeat the safety purpose of the polarized or grounding-type plug. A polarized plug has two blades with one wider than the other. A grounding type plug has two blades and a third grounding prong. The wide blade or the third prong are provided for your safety. If the provided plug does not fit into your outlet, consult an electrician for replacement of the obsolete outlet.
10. Protect the power cord from being walked on or pinched particularly at plugs, convenience receptacles, and the point where they exit from the apparatus.
11. Only use attachments/accessories specified by the manufacturer.
12. Use only with the cart, stand, tripod, bracket, or table specified by the manufacturer, or sold with the apparatus. When a cart is used, use caution when moving the cart/apparatus combination to avoid injury from tip-over.
13. Unplug this apparatus during lightning storms or when unused for long periods of time.
14. Refer all servicing to qualified service personnel. Servicing is required when the apparatus has been damaged in any way, such as power-supply cord or plug is damaged, liquid has been spilled or objects have fallen into the apparatus, the apparatus has been exposed to rain or moisture, does not operate normally, or has been dropped.
15. This product is equipped with a three-wire grounding type plug, a plug having a third (grounding) pin. This plug will only fit into a grounding-type power outlet. If you are unable to insert the plug into the outlet, contact your electrician to replace your obsolete outlet. Do not defeat the safety purpose of the grounding-type plug.

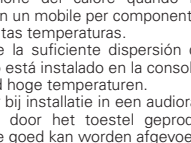

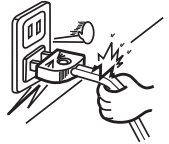
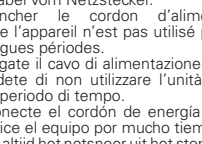
NOTE ON USE / HINWEISE ZUM GEBRAUCH / OBSERVATIONS RELATIVES A L'UTILISATION / NOTE SULL'USO / NOTAS SOBRE EL USO / ALVORENS TE GEBRUIKEN / OBSERVERA ANGÅENDE ANVÄNDNINGEN

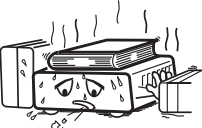
 <ul style="list-style-type: none"> Avoid high temperatures. Allow for sufficient heat dispersion when installed in a rack. Vermeiden Sie hohe Temperaturen. Beachten Sie, dass eine ausreichende Belüftung gewährleistet wird, wenn das Gerät auf ein Regal gestellt wird. Eviter des températures élevées. Tenir compte d'une dispersion de chaleur suffisante lors de l'installation sur une étagère. Evitate di esporre l'unità a temperature elevate. Assicuratevi che vi sia un'adeguata dispersione del calore quando installate l'unità in un mobile per componenti audio. Evite altas temperaturas. Permite la suficiente dispersión del calor cuando está instalado en la consola. Vermijd hoge temperaturen. Zorg er bij installatie in een audiorack voor, dat de door het toestel geproduceerde warmte goed kan worden afgevoerd. Undvik höga temperaturer. Se till att det finns möjlighet till god värmeavledning vid montering i ett rack. 	 <ul style="list-style-type: none"> Keep the unit free from moisture, water, and dust. Halten Sie das Gerät von Feuchtigkeit, Wasser und Staub fern. Protéger l'appareil contre l'humidité, l'eau et la poussière. Tenete l'unità lontana dall'umidità, dall'acqua e dalla polvere. Mantenga el equipo libre de humedad, agua y polvo. Laat geen vochtigheid, water of stof in het apparaat binnendringen. Utsätt inte apparaten för fukt, vatten och damm. 	 <ul style="list-style-type: none"> Do not let foreign objects into the unit. Lassen Sie keine fremden Gegenstände in das Gerät kommen. Ne pas laisser des objets étrangers dans l'appareil. Non inserire corpi estranei all'interno dell'unità. No deje objetos extraños dentro del equipo. Laat geen vreemde voorwerpen in dit apparaat vallen. Se till att främmande föremål inte tränger in i apparaten.
 <ul style="list-style-type: none"> Unplug the power cord when not using the unit for long periods of time. Wenn das Gerät längere Zeit nicht verwendet werden soll, trennen Sie das Netzkabel vom Netzstecker. Débrancher le cordon d'alimentation lorsque l'appareil n'est pas utilisé pendant de longues périodes. Scollegate il cavo di alimentazione quando prevedete di non utilizzare l'unità per un lungo periodo di tempo. Desconecte el cordón de energía cuando no utilice el equipo por mucho tiempo. Neem altijd het netsnoer uit het stopcontact wanneer het apparaat gedurende een lange periode niet wordt gebruikt. Koppla loss nätkabeln om apparaten inte kommer att användas i lång tid. 		 <ul style="list-style-type: none"> Do not let insecticides, benzene, and thinner come in contact with the unit. Lassen Sie das Gerät nicht mit Insektiziden, Benzin oder Verdünnungsmitteln in Berührung kommen. Ne pas mettre en contact des insecticides, du benzène et un diluant avec l'appareil. Assicuratevi che l'unità non entri in contatto con insetticidi, benzolo o solventi. No permita el contacto de insecticidas, gasolina y diluyentes con el equipo. Vorkom dat insecticiden, benzeen of ververdunner met dit toestel in contact komen. Se till att inte insektsmedel på spraybruk, bensen och thinner kommer i kontakt med apparatens hölje.
 <ul style="list-style-type: none"> Handle the power cord carefully. Hold the plug when unplugging the cord. Gehen Sie vorsichtig mit dem Netzkabel um. Halten Sie das Kabel am Stecker, wenn Sie den Stecker herausziehen. Manipuler le cordon d'alimentation avec précaution. Tenir la prise lors du débranchement du cordon. Manneggiare il cavo di alimentazione con attenzione. Tenete ferma la spina quando scollegate il cavo dalla presa. Maneje el cordón de energía con cuidado. Sostenga el enchufe cuando desconecte el cordón de energía. Hanteer het netsnoer voorzichtig. Houd het snoer bij de stekker vast wanneer deze moet worden aan- of losgekoppeld. Hantera nätkabeln varsamt. Håll i kabeln när den kopplas från el-uttaget. 		 <ul style="list-style-type: none"> Never disassemble or modify the unit in any way. Versuchen Sie niemals das Gerät auseinander zu nehmen oder zu verändern. Ne jamais démonter ou modifier l'appareil d'une manière ou d'une autre. Non smontate né modificate l'unità in alcun modo. Nunca desarme o modifique el equipo de ninguna manera. Dit toestel mag niet gedemonteerd of aangepast worden. Ta inte isär apparaten och försök inte bygga om den.
 <ul style="list-style-type: none"> Do not obstruct the ventilation holes. Decken Sie den Lüftungsbereich nicht ab. Ne pas obstruer les trous d'aération. Non coprite i fori di ventilazione. No obstruya los orificios de ventilación. De ventilatieopeningen mogen niet worden beblokkeerd. Täpp inte till ventilationsöppningarna. 	<p>* (For apparatuses with ventilation holes)</p>	

CAUTION:

- The ventilation should not be impeded by covering the ventilation openings with items, such as newspapers, tablecloths, curtains, etc.
- No naked flame sources, such as lighted candles, should be placed on the unit.
- Observe and follow local regulations regarding battery disposal.
- Do not expose the unit to dripping or splashing fluids.
- Do not place objects filled with liquids, such as vases, on the unit.

ACHTUNG:

- Die Belüftung sollte auf keinen Fall durch das Abdecken der Belüftungsöffnungen durch Gegenstände wie beispielsweise Zeitungen, Tischtücher, Vorhänge o. Ä. behindert werden.
- Auf dem Gerät sollten keinerlei direkte Feuerquellen wie beispielsweise angezündete Kerzen aufgestellt werden.
- Bitte beachten Sie bei der Entsorgung der Batterien die örtlich geltenden Umweltbestimmungen.
- Das Gerät sollte keiner tropfenden oder spritzenden Flüssigkeit ausgesetzt werden.
- Auf dem Gerät sollten keine mit Flüssigkeit gefüllten Behälter wie beispielsweise Vasen aufgestellt werden.

ATTENTION:

- La ventilation ne doit pas être gênée en recouvrant les ouvertures de la ventilation avec des objets tels que journaux, rideaux, tissus, etc.
- Aucune flamme nue, par exemple une bougie, ne doit être placée sur l'appareil.
- Veillez à respecter les lois en vigueur lorsque vous jetez les piles usagées.
- L'appareil ne doit pas être exposé à l'eau ou à l'humidité.
- Ne pas poser d'objet contenant du liquide, par exemple un vase, sur l'appareil.

ATTENZIONE:

- Le aperture di ventilazione non devono essere ostruite coprendole con oggetti, quali giornali, tovaglie, tende e così via.
- Non posizionate sull'unità fiamme libere, come ad esempio candele accese.
- Prestate attenzione agli aspetti legati alla tutela dell'ambiente nello smaltimento delle batterie.
- L'apparechiatura non deve essere esposta a gocciolii o spruzzi.
- Non posizionate sull'unità alcun oggetto contenente liquidi, come ad esempio i vasi.

PRECAUCIÓN:

- La ventilación no debe quedar obstruida por haberse cubierto las aperturas con objetos como periódicos, manteles, cortinas, etc.
- No debe colocarse sobre el aparato ninguna fuente inflamable sin protección, como velas encendidas.
- A la hora de deshacerse de las pilas, respete la normativa para el cuidado del medio ambiente.
- No exponer el aparato al goteo o salpicaduras cuando se utilice.
- No colocar sobre el aparato objetos llenos de líquido, como jarros.

WAARSCHUWING:

- De ventilatie mag niet worden belemmerd door de ventilatieopeningen af te dekken met bijvoorbeeld kranten, een tafelkleed, gordijnen, enz.
- Plaats geen open vlammen, bijvoorbeeld een brandende kaars, op het apparaat.
- Houd u steeds aan de milieuvoorschriften wanneer u gebruikte batterijen wegdoet.
- Stel het apparaat niet bloot aan druppels of spatten.
- Plaats geen voorwerpen gevuld met water, bijvoorbeeld een vaas, op het apparaat.

OBSERVERA:

- Ventilationen bör inte förhindras genom att täcka för ventilationsöppningarna med föremål såsom tidningar, bordsdukar, gardiner osv.
- Inga blottade brandkällor, såsom tända ljus, får placeras på apparaten.
- Tänk på miljöaspekterna när du bortskaffar batterier.
- Apparaten får inte utsättas för vätska.
- Placera inte föremål fyllda med vätska, t.ex. vaser, på apparaten.

DECLARATION OF CONFORMITY

We declare under our sole responsibility that this product, to which this declaration relates, is in conformity with the following standards:
EN60065, EN55013, EN55020, EN61000-3-2 and EN61000-3-3. EN55022, EN55024 for USB as multifunction terminal.
Following the provisions of 2006/95/EC and 2004/108/EC Directive.

ÜBEREINSTIMMUNGSERKLÄRUNG

Wir erklären unter unserer Verantwortung, daß dieses Produkt, auf das sich diese Erklärung bezieht, den folgenden Standards entspricht:
EN60065, EN55013, EN55020, EN61000-3-2 und EN61000-3-3.

EN55022, EN55024 für USB Multifunktionsbuchse. Entspricht den Verordnungen der Direktive 2006/95/EC und 2004/108/EC.

DECLARATION DE CONFORMITE

Nous déclarons sous notre seule responsabilité que l'appareil, auquel se réfère cette déclaration, est conforme aux standards suivants:

EN60065, EN55013, EN55020, EN61000-3-2 et EN61000-3-3. EN55022, EN55024 USB comme prise de multifonction. D'après les dispositions de la Directive 2006/95/EC et 2004/108/EC.

DICHIARAZIONE DI CONFORMITÀ

Dichiariamo con piena responsabilità che questo prodotto, al quale la nostra dichiarazione si riferisce, è conforme alle seguenti normative:

EN60065, EN55013, EN55020, EN61000-3-2 e EN61000-3-3. EN55022, EN55024 per USB come terminale multifunzione. In conformità con le condizioni delle direttive 2006/95/EC e 2004/108/EC.

QUESTO PRODOTTO E' CONFORME

AL D.M. 28/08/95 N. 548

DECLARACIÓN DE CONFORMIDAD

Declaramos bajo nuestra exclusiva responsabilidad que este producto al que hace referencia esta declaración, está conforme con los siguientes estándares:

EN60065, EN55013, EN55020, EN61000-3-2 y EN61000-3-3. EN55022, EN55024 para USB como terminal multifuncional. Siguiendo las provisiones de las Directivas 2006/95/EC y 2004/108/EC.

EENVORMIGHEIDSVERKLARING

Wij verklaren uitsluitend op onze verantwoordelijkheid dat dit product, waarop deze verklaring betrekking heeft, in overeenstemming is met de volgende normen:

EN60065, EN55013, EN55020, EN61000-3-2 en EN61000-3-3. EN55022, EN55024 voor USB som multifunktionskontakten. Volgens de bepalingen van de Richtlijnen 2006/95/EC en 2004/108/EC.

ÖVERENSSTÄMMELSESINTYG

Härmed intygas helt på eget ansvar att denna produkt, vilken detta intyg avser, uppfyller följande standarder:
EN60065, EN55013, EN55020, EN61000-3-2 och EN61000-3-3.

EN55022, EN55024 för USB som multifunktionskontakten. Enligt stadgarna i direktiv 2006/95/EC och 2004/108/EC.

A NOTE ABOUT RECYCLING:

This product's packaging materials are recyclable and can be reused. Please dispose of any materials in accordance with the local recycling regulations.

When discarding the unit, comply with local rules or regulations.

Batteries should never be thrown away or incinerated but disposed of in accordance with the local regulations concerning battery disposal.

This product and the supplied accessories, excluding the batteries, constitute the applicable product according to the WEEE directive.

HINWEIS ZUM RECYCLING:

Das Verpackungsmaterial dieses Produktes ist zum Recyceln geeignet und kann wieder verwendet werden. Bitte entsorgen Sie alle Materialien entsprechend der örtlichen Recycling-Vorschriften.

Beachten Sie bei der Entsorgung des Gerätes die örtlichen Vorschriften und Bestimmungen.

Die Batterien dürfen nicht in den Hausmüll geworfen oder verbrannt werden; bitte entsorgen Sie die Batterien gemäß der örtlichen Vorschriften.

Dieses Produkt und das im Lieferumfang enthaltene Zubehör (mit Ausnahme der Batterien!) entsprechen der WEEE-Direktive.

UNE REMARQUE CONCERNANT LE RECYCLAGE:

Les matériaux d'emballage de ce produit sont recyclables et peuvent être réutilisés. Veuillez disposer des matériaux conformément aux lois sur le recyclage en vigueur.

Lorsque vous mettez cet appareil au rebut, respectez les lois ou réglementations en vigueur.

Les piles ne doivent jamais être jetées ou incinérées, mais mises au rebut conformément aux lois en vigueur sur la mise au rebut des piles.

Ce produit et les accessoires inclus, à l'exception des piles, sont des produits conformes à la directive DEEE.

NOTA RELATIVA AL RICICLAGGIO:

I materiali di imballaggio di questo prodotto sono riutilizzabili e riciclabili. Smaltire i materiali conformemente alle normative locali sul riciclaggio.

Per lo smaltimento dell'unità, osservare le normative o le leggi locali in vigore.

Non gettare le batterie, né incenerirle, ma smaltirle conformemente alla normativa locale sui rifiuti chimici.

Questo prodotto e gli accessori inclusi nell'imballaggio sono applicabili alla direttiva RAEE, ad eccezione delle batterie.

ACERCA DEL RECICLAJE:

Los materiales de embalaje de este producto son reciclables y se pueden volver a utilizar. Disponga de estos materiales siguiendo los reglamentos de reciclaje de su localidad.

Cuando se deshaga de la unidad, cumpla con las reglas o reglamentos locales.

Las pilas nunca deberán tirarse ni incinerarse. Deberá disponer de ellas siguiendo los reglamentos de su localidad relacionados con los desperdicios químicos.

Este producto junto con los accesorios empaquetados es el producto aplicable a la directiva RAEE excepto pilas.

EEN AANTEKENING MET BETREKKING TOT DE RECYCLING:

Het inpakmateriaal van dit product is recycleerbaar en kan opnieuw gebruikt worden. Er wordt verzocht om zich van elk afvalmateriaal te ontdoen volgens de plaatselijke voorschriften.

Volg voor het wegdoen van de speler de voorschriften voor de verwijdering van wit- en bruingoed op.

Batterijen mogen nooit worden weggegooid of verbrand, maar moeten volgens de plaatselijke voorschriften betreffende chemisch afval worden verwijderd.

Op dit product en de meegeleverde accessoires, m.u.v. de batterijen is de richtlijn voor afgedankte elektrische en elektronische apparaten (WEEE) van toepassing.

OBSERVERA ANGÅENDE ÅTERVINNING:

Produktens emballage är återvinningsbart och kan återanvändas. Kassera det enligt lokala återvinningsbestämmelser.

När du kasserar enheten ska du göra det i överensstämmelse med lokala regler och bestämmelser.

Batterier får absolut inte kastas i soporna eller brännas. Kassera dem enligt lokala bestämmelser för kemiskt avfall.

Denna apparat och de tillbehör som levereras med den uppfyller gällande WEEE-direktiv, med undantag av batterierna.



Pb

CAUTION:

To completely disconnect this product from the mains, disconnect the plug from the wall socket outlet. The mains plug is used to completely interrupt the power supply to the unit and must be within easy access by the user.

VORSICHT:

Um dieses Gerät vollständig von der Stromversorgung abzutrennen, ziehen Sie bitte den Stecker aus der Wandsteckdose.

Der Netzstecker wird verwendet, um die Stromversorgung zum Gerät völlig zu unterbrechen; er muss für den Benutzer gut und einfach zu erreichen sein.

PRECAUTION:

Pour déconnecter complètement ce produit du courant secteur, débranchez la prise de la prise murale. La prise secteur est utilisée pour couper complètement l'alimentation de l'appareil et l'utilisateur doit pouvoir y accéder facilement.

ATTENZIONE:

Per scollegare completamente questo prodotto dalla rete di alimentazione elettrica, scollegare la spina dalla relativa presa a muro.

La spina di rete viene utilizzata per interrompere completamente l'alimentazione all'unità e deve essere facilmente accessibile all'utente.

PRECAUCIÓN:

Para desconectar completamente este producto de la alimentación eléctrica, desconecte el enchufe del enchufe de la pared.

El enchufe de la alimentación eléctrica se utiliza para interrumpir por completo el suministro de alimentación eléctrica a la unidad y debe de encontrarse en un lugar al que el usuario tenga fácil acceso.

WAARSCHUWING:

Om de voeding van dit product volledig te onderbreken moet de stekker uit het stopcontact worden getrokken.

De netstekker wordt gebruikt om de stroomtoevoer naar het toestel volledig te onderbreken en moet voor de gebruiker gemakkelijk bereikbaar zijn.

FÖRSIKTIHETSMÅTT:

Koppla loss stickproppen från eluttaget för att helt skilja produkten från nätet.

Stickproppen används för att helt bryta strömförsörjningen till apparaten, och den måste vara lättillgänglig för användaren.

□ Contents

Getting Started	
Accessories	2
Installation	2
Main Features	3
Part Names and Functions	4
Top Panel	4
Display	6
Rear Panel	6
Connections	
Preparations	7
Cables Used for Connections	7
Input Terminal Connection	7
Output Terminal Connection	8
Connections to USB Memory or USB Cable	9
Connecting the Power Cord	9
Basic Operations	
Basic Operations	10
MIC (mic input)	11
Ducking function	11
MONITOR (headphones output)	11
Effector Function	
BeatBreaker Function	12
Effector Operations	13
Selecting the effector units and channels	13
Setting the BPM	13
Setting the beat	13
Selecting the effects	13
Turning the effects ON and OFF	13
Fader Start Function	
Channel Fader Start	14
Crossfader Start	15
FADER (setting the fader curve)	15
How to adjust the Crossfader torque	15

USB Settings	
Selecting the USB mode	16
USB audio	16
Setting the USB audio output	17
Setting the USB audio input	17
MIDI	18
Setting the MIDI channels	18
Setting the MIDI clock	18
MIDI layer operations	18
DVS function	19

Utility settings	
Utility operations	22
Preset Export	24
Preset Recall	24
Owner Setting Mode	24
Preset Import	24

Specifications	25
Block Diagram	26

Troubleshooting	27
-----------------------	----

Getting Started
Connections
Basic Operations
Effector Function
Fader Start
USB
Utility
Specifications
Troubleshooting

Getting Started

Thank you for purchasing this Denon product. To ensure proper operation, please read these owner's manual carefully before using the product.

After reading them, be sure to keep them for future reference.

Accessories

Check that the following parts are supplied with the product.

- ① Owner's manual..... 1
- ② CD-ROM..... 1
- ③ Power cord..... 1
- ④ USB cable..... 1

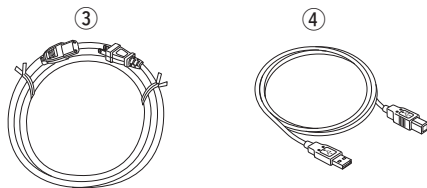

Installation

When the DN-X1600 is mounted inside a coffin or DJ booth, we recommend leaving a 20 mm (3/4 ins.) (Bottom 2.5 mm (1/16 ins.)) blank space above the mixer if possible.

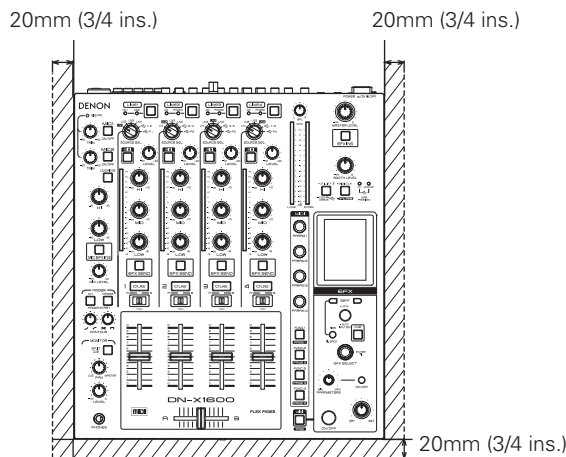
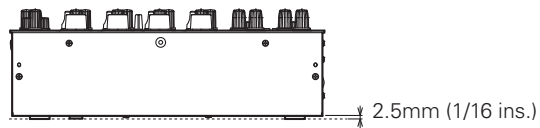

Main Features

The basic configuration of the input and output systems for this unit is as shown below.

- 5 CD Inputs, 3 PHONO inputs
- 2 Microphone inputs
- 2 Master outputs
- 1 Booth output
- 1 REC output
- 1 Digital output
- 1 Effect input/output
- 4 USB audio input/outputs

This unit is also a DJ full digital mixer which supports 96 kHz/32-bit digital-to-analog conversion and which comes with USB MIDI and 5 pin output MIDI interface functions.

1. Design oriented toward achieving a high sound quality

- The unit features a 96 kHz/32-bit floating digital signal processor (DSP) and 32-bit digital-to-analog converter (DAC) (master output). A sound quality faithful to the original sources is delivered at a high degree of accuracy.
- An electrolytic capacitor designed to enhance sound quality is employed in the power supply unit. Furthermore, film capacitors designed to enhance the sound quality and high-precision metal film resistors help to configure the audio signal processing unit. The result is a sound quality which is overwhelmingly high.
- The unit incorporates a microphone amplifier with a discrete transistor configuration and a low equivalent input noise of 126 dB, as well as PHONO amplifier with a signal to noise ratio of 89 dB.

2. Multiple Effect

- The unit comes with an effector which is linked to the number of beats which has been set in synchronization with the number of beats per minute (BPM) of the musical composition. In addition to the newly developed BeatScratch and Ping Pong Delay, a total of 14 different effectors including delay, echo, reverb, looping, flanger, phaser, and pitch shift are incorporated.
- The effect send configuration makes it possible to send multiple input channel signals to the effector at the same time.

3. USB audio and MIDI interfaces

- An interface prepared specifically for the MIDI controller increases controllability of the DJ software.
- 8-channel (4 stereo channels) 96 kHz USB audio input/output function
- DVS (Digital Vinyl System) is supported. (See page 19 for more details of the DVS function.)
- Also available is a MIDI layer function for controlling the DJ software on a channel by channel basis, and the effect control section on an individual basis. MIDI output is enabled for almost all other operations involving panel controls.
- The 5-pin DIN MIDI output terminals provided support synchronization with external devices.
- ASIO driver which achieves a low latency packed together with the unit
- USB assign switch function enables system switching for the USB audio inputs using just 1 Utility Preset button.

4. V-LINK

The unit is equipped with the V-LINK (**V-LINK**) function. V-LINK is a function developed by Roland Corporation that allows musicians to simultaneously integrate audio and video. Connecting devices that support V-LINK to the MIDI terminals makes it possible to perform a wide range of visual effects that are linked with the musical performance.

5. Operating ease and high-reliability design tailored for professional use

- Isolator equalizers are incorporated for each input channel. It is also possible to customize the crosspoint frequencies of the bands using presets.
- The crossfader's slide torque can be adjusted to achieved the desired feeling.
- Equipped with a high contrast VFD (vacuum fluorescent display) that provides outstanding visibility.
- Matrix source selectors enabling the user to select any of 6 input sources

6. Other features

- The preset import/export function makes it possible to carry around the preset data stored on an USB memory or other such device. This reduces the setting time.
- Ducking function for reducing the amount of background sound during mic input
- Channel Fader and Crossfader start function

Part Names and Functions

Top Panel

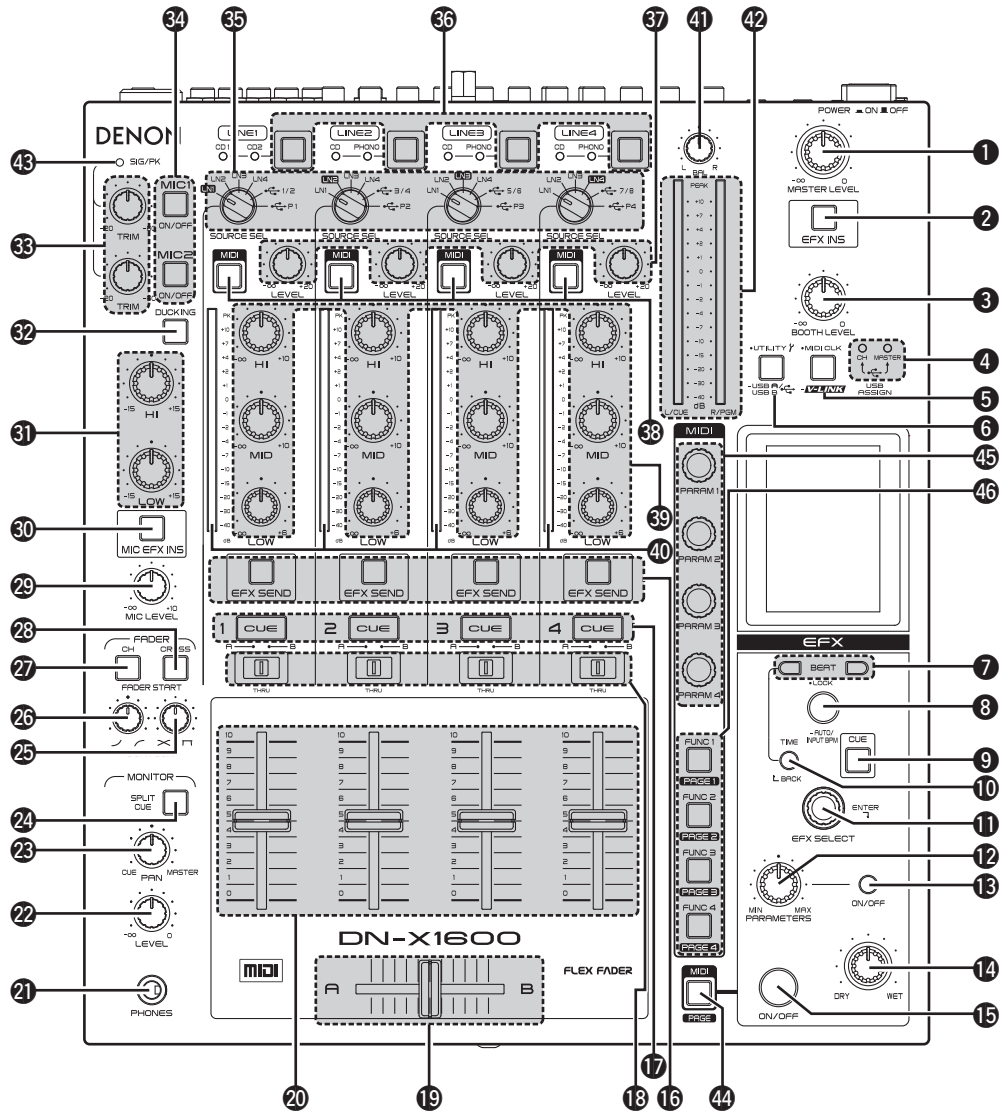

1 MASTER LEVEL control

Adjusts the level of the MASTER outputs.

2 Master EFX INS button

This button enable the various effects to be obtained for the master output signals.

3 BOOTH LEVEL control

Adjusts the level of the BOOTH outputs.

4 USB ASSIGN CH/MASTER indicator

This displays the assignment destination of the USB Audio input signal supplied from the computer.

Assignment destination settings for Ch and Master are selected from the USB Assign items in the preset controls in the utility mode.

CH:

- Displayed when CH (1–4) are assigned.

MASTER:

- Displayed when assigned to the master bus and monitor bus.

5 MIDI CLK / V-LINK button

This enables the MIDI clock corresponding to the BPM value to be sent from the USB MIDI and MIDI output terminals to the computer (software) or external device.

START:

Sending the MIDI clock is started.

STOP:

Sending the MIDI clock is stopped.

- Press for more than one second to switch V-LINK ON/OFF.

6 UTILITY/–USB A/USB B button

This allows the presets to be set and the system information to be set, changed or referenced.

- When it is held down for more than a second, the USB mode switching screen is opened, and the USB device mode or USB host mode can be selected.

7 BEAT ◀ ▶ buttons

◀ (Short) :

The beat/time is decreased.

▶ (Long) :

The beat/time is increased.

8 TAP/LOCK/AUTO/INPUT BPM button

TAP:

When this button is tapped repeatedly, the BPM is measured using the intervals between taps.

LOCK:

When the button is pressed once in the auto BPM mode, the BPM value measured automatically is locked.

AUTO BPM:

When the button is held down for one second, the auto BPM mode is established, and the measured BPM value is displayed.

INPUT BPM:

When it is held down for two or more seconds, the BPM input mode is established, and the BPM value can be input directly using the 7 BEAT ◀, ▶ buttons. When it is pressed again, the mode is released.

9 Effect CUE button

When the CUE button is set to ON, the sound of the effects can be monitored even if the effect is OFF.

(Excluding ECHO, REVERB, and ECHO REVERB.)

10 TIME/BACK button

TIME:

This button is used to select whether to change the effects produced using the 7 BEAT ◀, ▶ buttons on the basis of the number of beats or time.

BACK:

This is used when returning to the previous screen while setting screen operations are being performed.

11 EFX SELECT control

This is for selecting the effect to be used.

Refer to the effect functions (page 12).

12 PARAMETER MIN/MAX control

This is used to adjust the filter cutoff frequency and other effector parameters. The parameters are changed by the effector selected.

13 Parameter ON/OFF button

This is used to control the ON and OFF settings of the effect parameters.

14 DRY/WET control

Use this to adjust the ratio of original and effected sound.

15 Effect ON/OFF button

Sets the EFX effects to ON/OFF.

16 Channel EFX SEND button

The various set effects can be obtained for the channel audio signal.

Multiple channels can be selected.

17 Channel CUE buttons

Pressing in any or all of **CUE** buttons routes the respective source to the headphone and meter cue sections. When the CUE button is pressed multiple times, the channels selected by the CUE button are mixed.

- The SOLO mode with no signals mixed can also be selected as a preset.

18 CROSSFADER ASSIGN switches**A, B:**

The channel source is assigned to A or B of the Crossfader.

THRU:

Select when you don't assign the channel source into the Crossfader.

19 CROSSFADER

Controls the relative output level from the summed A and B Mixes. When the fader is at its far left, only the A Mix is heard from the Outputs. As the fader is moved toward the right, the amount of B Mix is increased and the amount of A Mix is decreased. When the fader is centered, equal amounts of A and B Mixes are routed to the Outputs. Fully right is all B Mix at the Outputs.

20 Channel input fader (CH FADER)

Controls the level of the selected Input.

21 HEADPHONE output jack

Accepts 1/4" stereo headphone plugs.

22 HEADPHONE level control

Adjusts the volume for the headphones.

23 HEADPHONE PAN control

This is used to adjust the balance between the CUE sound and the master sound which are monitored using the headphones.

24 SPLIT CUE button

There are two headphone monitor modes.

SPLIT CUE OFF:

The cue signals and master signals can be monitored in stereo.

SPLIT CUE ON:

The monaural cue signals are heard through the left channel of the headphones, and the monaural master signals through the right channel.

25 CROSSFADER CONTOUR control

Allows adjusting the "shape" of the Crossfader response from a gentle curve for smooth, long running fades, to the steep pitch required for top performance cut and scratch effects.

26 CH FADER CONTOUR control

Adjusts the volume curve response of the channel fader.

27 CH FADER START switch

This function will start the performance of CD/Media Player with Ch. Fader automatically is **ON/OFF**.

28 CROSSFADER START switches

Use this to switch the Crossfader Start function **ON** and **OFF**.

29 MIC SEND LEVEL control

This is used to adjust the level at which the mic signals are sent to the master output.

30 Mic EFX INS button

This button enable the various effects to be obtained for the mic input signals.

31 MIC EQ controls

Adjusts the frequency of the mic input.

32 DUCKING ON/OFF button

- Use this to switch the Talk Over function ON and OFF. (ON/OFF is cyclic)
- When the button is lit, level of signals except Mics is attenuated.
- The ducking attenuation level can be adjusted in the "UTILITY" mode.

33 MIC1, MIC2 TRIM controls

Adjusts the level of the Main Mic input.

34 MIC1, 2 buttons

When the button's LED is lighted, the mic signals take effect.

35 SOURCE SEL LN1/LN2/LN3/LN4/USB/P1-4 controls (channel input selector)

These enable any of six inputs to be selected for each of the channels. The same input can be selected for more than one channel.

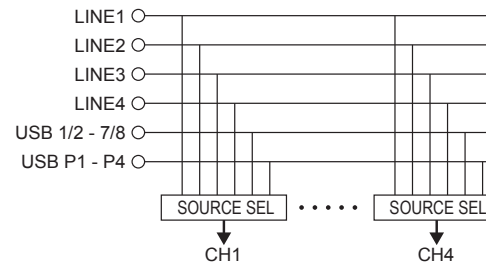

The desired USB source from USB P1-P4 can be selected from USB 1/2-7/8 and DVS from the utility mode preset control.

36 CD/PHONO line input selector buttons

These enable the line input of each channel to be selected as CD or PHONO.

CD:

Rear panel LINE1-4 CD terminal input

PHONO:

Rear panel LINE2-4 PHONO terminal input

- LINE1 is only for the CD terminal input.

37 Channel input LEVEL controls

These are used to adjust the levels of the selected inputs.

38 MIDI layer selector buttons

When these buttons are set to ON, the controls of the selected channels function as MIDI controllers.

39 Channel isolator EQ controls (HI, MID, LOW)

These are used to change the frequency response of the selected inputs.

At the center position, the frequency response is flat.

At the $-\infty$ position, the frequencies of all the bands are cut off completely.

40 CH LEVEL meter

Displays the input level after adjusted with LEVEL **37** and Source EQ **39** controls.

41 MASTER BALANCE control

Adjusts the L/R balance of the MASTER output.

42 L/CUE, R/PGM master level meter

One of two modes can be selected for display on this meter.

SPLIT CUE OFF:

The master output audio level is displayed.

SPLIT CUE ON:

The right channel master CUE (monaural) and left channel CUE (monaural) audio levels are displayed.

43 SIG/PK indicator

This is the signal/peak meter for the mic input level.

Off:

No signals input (under -60 dB/FS)

Green:

Signal input (-60 dB/FS to under -20 dB/FS)

Orange:

Suitable signal input level (-20 dB/FS to under -6 dB/FS)

Red:

Excessively high signal input level (above -6 dB/FS)

44 MIDI button

Pressing this button makes the EFX control function as the MIDI controller.

45 MIDI parameter control

Controlling each button outputs the MIDI command.

46 MIDI function buttons (FUNC1/2/3/4)

Controlling each button outputs the MIDI command. Pressing the MIDI function button while pressing the MIDI button makes it possible to switch the MIDI page. Different commands can be output when the MIDI page is switched.

Display

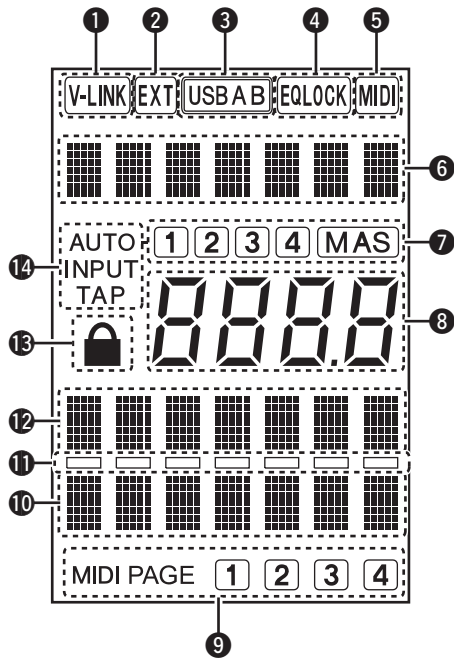

- 1 V-LINK indicator**
This lights when in V-LINK mode.
- 2 EXT indicator**
This lights when the Preset information in the USB device is used.
- 3 USB A/USB B indicator**
This indicates the current USB mode.
USB A: USB host mode
USB B: USB device mode
- 4 EQ LOCK indicator**
This flashes when the equalizers and faders are locked.
- 5 MIDI indicator**
This lights when MIDI communication is being performed.
- 6 Effect display**
This indicates the name of the currently selected effect.
- 7 BPM source indicator**
This indicates the signal source that is being detected for AUTO BPM.
- 8 Effector BPM display**
This indicates the current BPM value.
- 9 MIDI PAGE indicator**
This indicates the current MIDI page.
- 10 Time display**
- 11 Beat display bar**
This lights in accordance with the set number of beats.
- 12 Beat display**
- 13 Lock icon**
This lights when the BPM is locked.
- 14 BPM indicator**
This indicates the current BPM mode.
AUTO:
This lights when BPM mode is AUTO BPM.
INPUT:
This lights when BPM mode is INPUT mode.
TAP:
This lights when BPM mode is TAP input mode.

Rear Panel

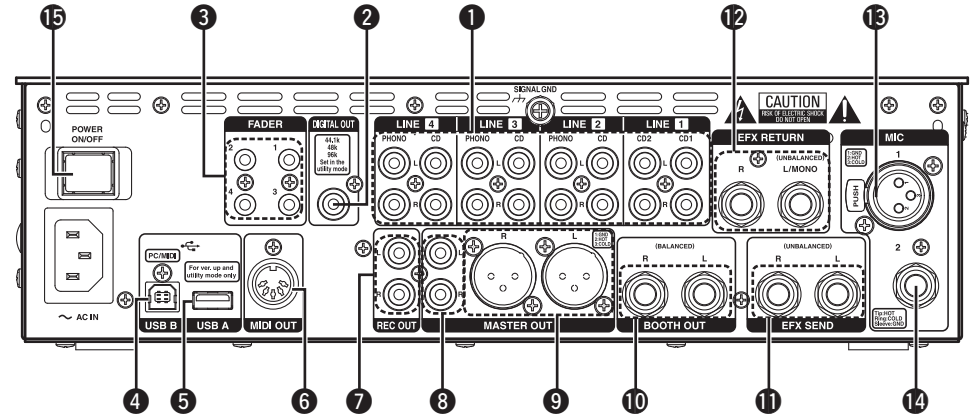

- 1 3 PHONO inputs/5 CD inputs terminals**
- 2 DIGITAL OUT terminal**
- 3 LINE 1, 2, 3, 4 FADER output terminals**
- 4 USB B terminal**
- 5 USB A terminal**
- 6 MIDI output terminal**
- 7 REC OUT terminals**
- 8 MASTER OUT (UNBALANCED) terminals**
- 9 MASTER OUT (BALANCED) terminals**
- 10 BOOTH OUT (BALANCED) terminals**
- 11 SEND terminals**
- 12 RETURN terminals**
- 13 MIC1 input terminal**
- 14 MIC2 input terminal**
- 15 POWER switch**

NOTE

- When the switch is in the OFF position, the equipment is not completely switched off from MAINS.

Connections

When making connections, also refer to the instruction manuals of each device.

1. Make certain AC power is off while making connections.
2. Quality cables make a big difference in fidelity and punch. Use high-quality, audio cables. Do not use excessively long cables.
3. Be sure plugs and terminals are securely fastened. Loose connections cause hum, noise, or intermittence that could damage your speakers.
4. Make sure that all faders are at "zero," and that the power supply to each unit is off.
5. Connect the cables to the input and output terminals.
6. Connect the power amplifier to the output.

NOTE

- Always switch on your audio input sources such as CD players first, then your mixer, and finally any amplifiers.
- When turning off, always reverse this operation by turning off amplifiers, then your mixer, and then input units.

Preparations

Cables Used for Connections

Select the cables according to the equipment being connected.

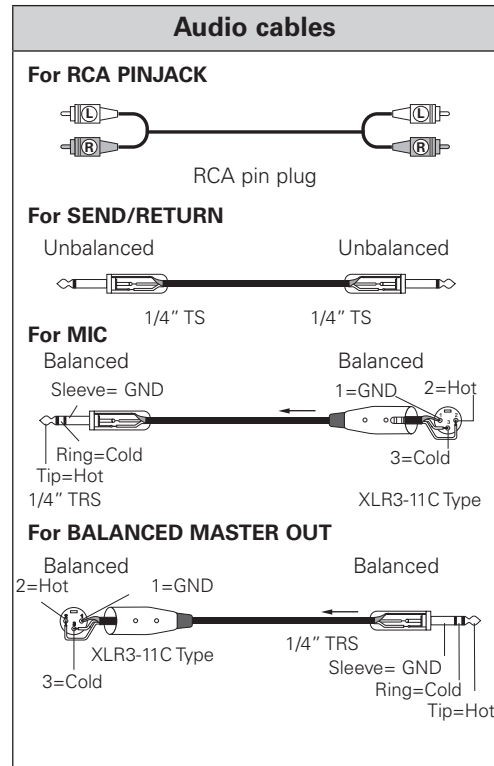

Input Terminal Connection

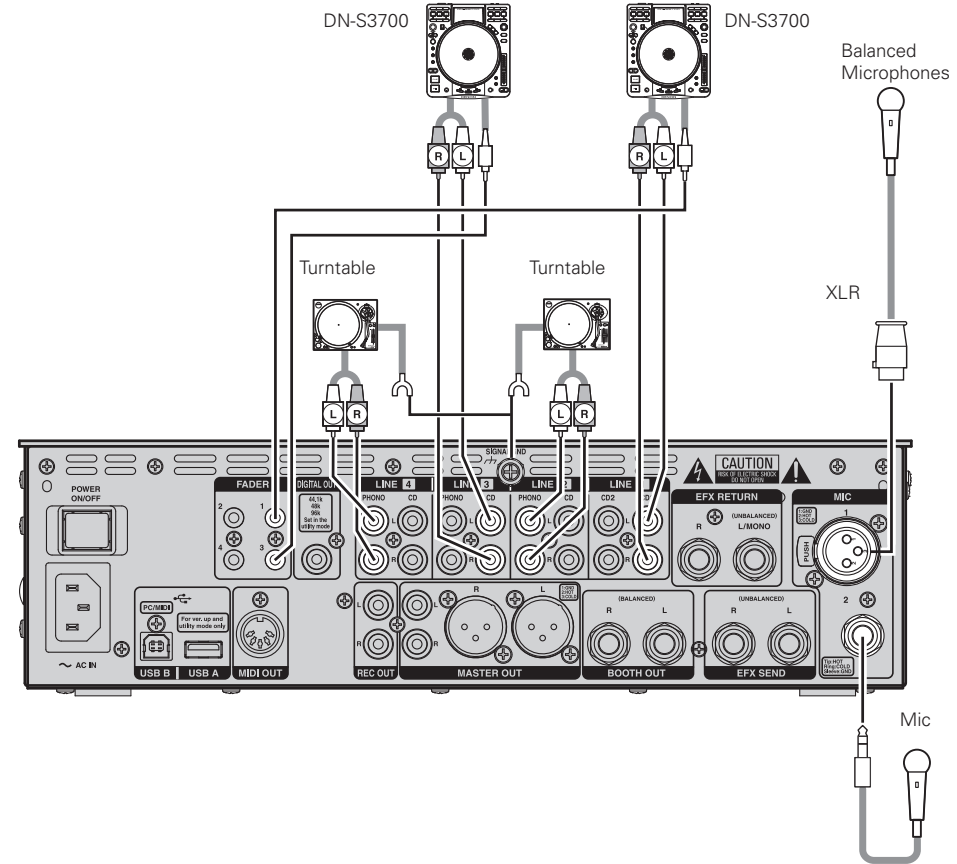

3 PHONO inputs/5 CD inputs terminals

These unbalanced stereo RCA terminals are used to connect devices such as a turntable (RIAA) with an MM (moving magnet) type of cartridge or CD/Media Player.

LINE 1, 2, 3, 4 FADER output terminals

Connect these terminals to the Fader input terminals of the DN-S1200, DN-S3700 and etc using the 3.5 mm stereo mini cord.

MIC1 input terminal

A microphone is connected to this balanced combo jack with XLR connector.

• Pin layout:

1. GND
2. Hot
3. Cold

• Applicable connector:

Cannon XLR-3-32 or equivalent.

MIC2 input terminal

Accepts a balanced microphone with 1/4" terminals.

• Pin layout (TRS):

- Tip: Hot
- Ring: Cold
- Sleeve: GND

Output Terminal Connection

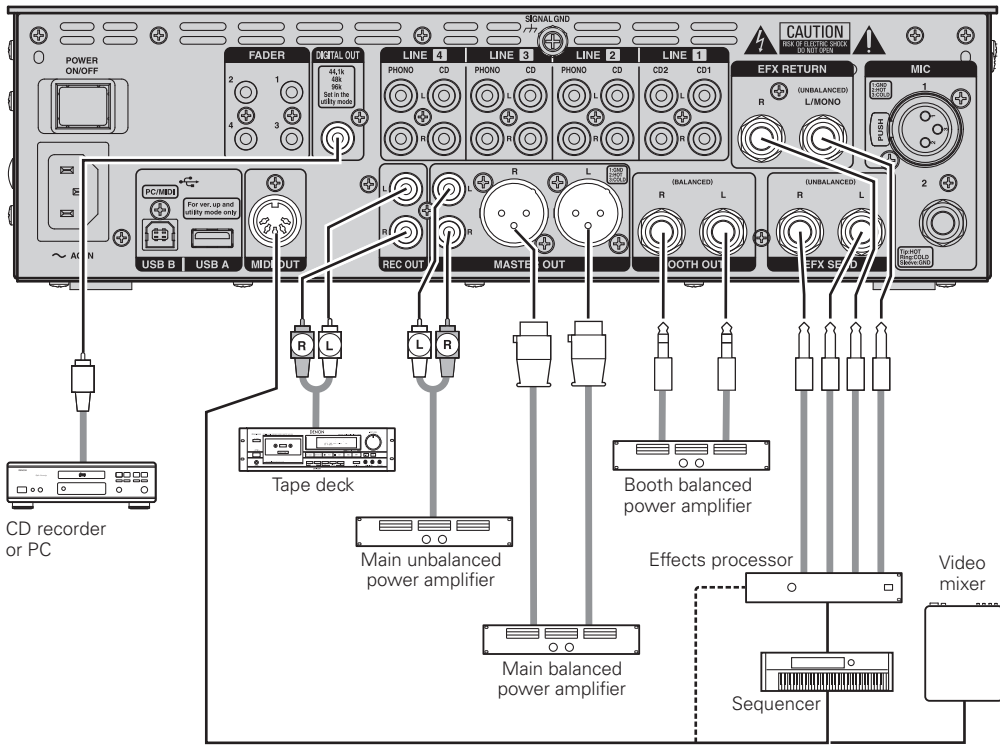

COAXIAL DIGITAL OUT terminal (44.1/ 48/ 96kHz)

Output from this RCA terminal is the digital output data. These signals are not affected by the master level adjustments. We recommend using an RCA cable designed for digital signals (75 ohms). (This can be purchased from an audio/video store.)

MIDI output terminal

This is a 5 Pin DIN connector output terminal. This is connected to a MIDI-compatible device.

REC OUT terminals

These are the recording output terminals.

MASTER OUT (UNBALANCED) terminals

This stereo pair of RCA terminals provides an unbalanced line level output. Connect these terminals to the unbalanced analog input terminals on an amplifier or console.

MASTER OUT (BALANCED) terminals

These XLR type connectors provide a balanced line level output. Connect these connectors to the balanced analog input connectors on an amplifier or console.

• **Pin layout:**

- 1. GND
- 2. Hot
- 3. Cold

• **Applicable connector:**

Cannon XLR-3-32 or equivalent.

BOOTH OUT (BALANCED) terminals

These TRS terminals are balanced line output terminals whose signal levels are adjusted using the BOOTH LEVEL control provided on the top panel.

• **Pin layout (TRS):**

- Tip: Hot
- Ring: Cold
- Sleeve: GND

SEND/RETURN terminals

These 1/4" TS mono terminals allow external processing of the program signal. When connect monaural type effect processor, use Lch input and output.

• **SEND (output):**

Connect this to the input terminal on the external effector.

• **RETURN (input):**

Connect this to the output terminal on the external effector.

HEADPHONE output jack

Accepts 1/4" stereo headphone plugs.

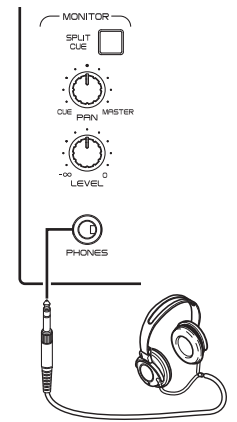

NOTE

To prevent hearing loss, do not raise the volume level excessively when using headphones.

Connections to USB Memory or USB Cable

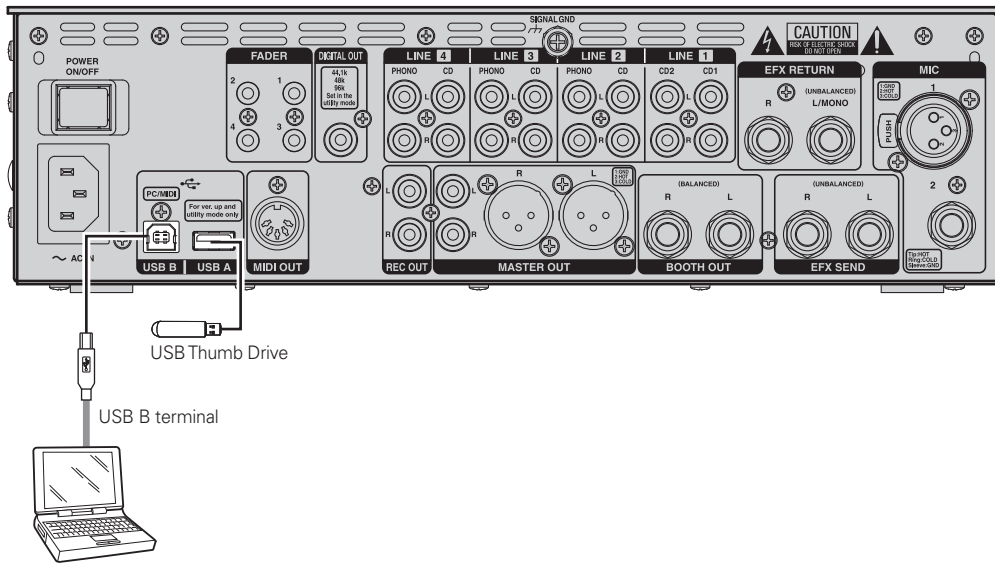

USB A terminal

Only one mass storage device such as a USB memory or USB hard disk drive can be connected to this terminal.

- A USB hub is not supported.
- The terminal supports USB 2.0 HighSpeed.

USB B terminal

This is connected to a computer to send and receive the USB MIDI, HID and USB audio signals.

- The terminal supports USB 2.0 HighSpeed.

ASIO Driver Application included.

- Computer OS versions that can be connected to the DN-X1600:
- Windows XP SP2, Vista, Mac OSX 10.5.7 or later Computers with other operating systems are not compatible with USB MIDI, so the computer may operate erratically after connected to the DN-X1600 by USB.
- It has been verified that this unit operates with the Mac OS 10.5.7 operating system. When using Mac OS 10.5.6 or an earlier version, operation of the computer may be unstable. Furthermore, this unit operates using an audio driver compliant with the Core Audio format. As such, use software applications that have been guaranteed to run using a driver compliant with this format.
- Windows is either a registered trademark or trademark of Microsoft Corporation in the United States and / or other countries. MAC is either a registered trademark or trademark of Apple Incorporated in the United States and / or other countries.

Connecting the Power Cord

Connect the included power cord to the DN-X1600, and plug it into an AC outlet.

NOTE

- Be sure to insert the power plug firmly. Incomplete connection results in noise generation.

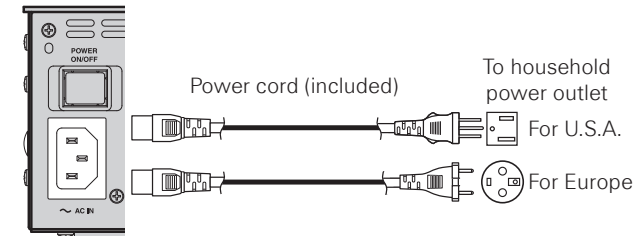

Basic Operations

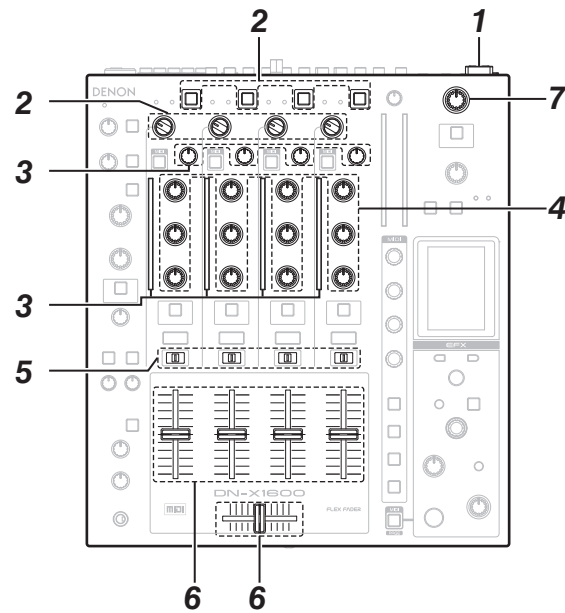

Basic Operations

- 1** Press the **POWER ON/OFF** switch to turn the unit's power ON.
- 2** Use the **SOURCE SEL** controls to select the channels from 1 to 4 of the sources to be used (LN1-LN4, P1-P4, USB).
Use the **SEL** buttons of each **LINE** to select CD or PHONO as the **LINE** input.
- 3** While checking the input level on the level meter, adjust the input levels using the **channel LEVEL** controls.
- 4** Adjust the sound quality using the **channel EQ** controls (HI, MID, LOW).
- 5** Assignment of the channel signals can be switched using the **CROSSFADER ASSIGN** switches. Set these switches to the **THRU** position if the **Crossfader** is not going to be used.
- 6** Adjust the volume level using the **Channel Fader** and **Crossfader**.
- 7** Adjust the output level using the **MASTER LEVEL** control.

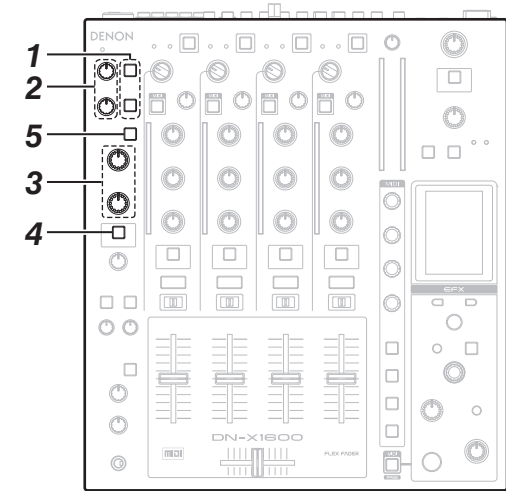

MIC (mic input)

- 1** When a microphone is connected to MIC1 or MIC2, press the **MIC1** or **MIC2** button to set it to ON.
- 2** Adjust the **MIC1** volume level using the **MIC1 TRIM** control, and adjust the **MIC2** volume level using the **MIC2 TRIM** control.
 - While inputting audio signals, if the SIG/PK LEDs occasionally light up red and then amber, the suitable level has been reached without any distortion.
- 3** Adjust the sound quality using the **MIC EQ** controls (**HI**, **LOW**).
- 4** To add the effect functions to the mic input, press the **MIC EFX INS** buttons to switch them ON.

Ducking function

- 5** To enable the ducking function, set the **DUCKING** button to ON. The button will light.
 - This function detects the mic input and attenuates the level of the music signals in the master output. It prevents the sound from the microphone from being drowned out by the music when a microphone is used.
 - The attenuation level of the master output while the ducking function is operating can be set within a range from $-30 \text{ dB} \pm 10 \text{ dB}$ in the Utility mode.

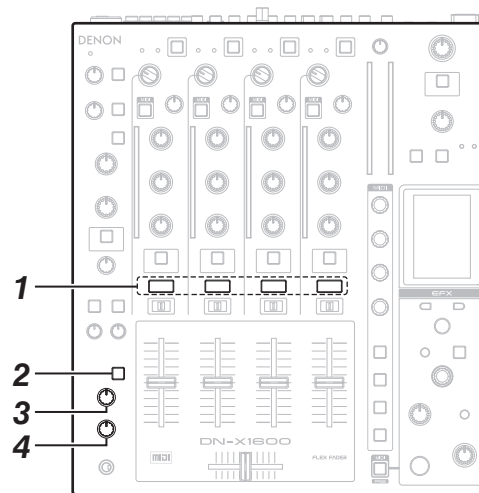

MONITOR (headphones output)

- 1** Select the source to be monitored using the **CUE** buttons for each channel.
 - When selected, the **CUE** button lights.
 - CUE monitors for channels 1–4 as well as EFX can be selected.
- 2** Use the **SPLIT CUE** button to select the **STEREO/SPLIT CUE** mode.
 - When selected, the **SPLIT CUE** button lights.
 - In the SPLIT CUE (monaural) mode, the signal selected for cue is output to the left speaker of the headphones, and the master signal is output to the right speaker of the headphones.
 - In the STEREO mode, the master signals and signals selected for cue are output in stereo.
- 3** Use the **PAN** control to adjust the balance between the **CUE** signals and master output signals.
 - When it is turned to the left, only the CUE signals are output from the headphones.
 - When it is turned to the right, only the master signals are output.
- 4** Use the **LEVEL** control to adjust the headphone output level.

NOTE

To prevent hearing loss, do not raise the volume level excessively when using headphones

Effector Function

The unit comes with an effector which is linked to the number of beats which has been set in synchronization with the number of beats per minute (BPM) of the musical composition. It also has an effect send configuration which makes it possible to send the signals from multiple input channels simultaneously to the effectors, enabling a wide range of acoustic effects.

Types of effects and details of operations

No.	Effect	Description of effect operation
1	Delay	Adds signals which have been delayed by the time of the beat setting.
2	Echo	Adds echo signals which have been delayed by the time of the beat setting.
3	Ping Pong Delay	Signals with a beat setting time delay are split and output from the left and right channels. • Effect Parameter Control: Adjusts the ratio of signal being output to the left and right.
4	Trans	Cuts off the signals at the time of the beat setting.
5	Flanger	Adds signals whose delay time has been varied in the LFO period of the beat setting.
6	Filter	Varies the filter cut-off frequency using the beat setting time.
7	Phaser	Adds signals whose phase has been varied in the LFO period of the beat setting.
8	Reverb	Adds reverberation signals which have been delayed by the time of the beat setting.
9	Echo Reverb	Adds an echo signal to the beat setting time delay, and adds a reverberation signal.
10	Loop	Initiates the same kind of loop sampler processing as the LOOP function of other Denon DJ products.
11	Rev. Loop	Initiates the reverse play processing of the above loop signals.
12	Pitch Shift	Initiates the pitch shift processing of the input signals, and outputs the results.
13	BeatBreaker	Initiates the partial insertion processing of the attack sounds of the beats as per the beat pattern.
14	BeatScratch	Repeats standard playback of the beat setting time and reverse playback of the same beat setting time to output a scratching effect.
15	SEND/RTN	Sends the signals whose effects have been selected to the external effector and returns the signals from the external effector.

* In order to achieve normal effects, set the BPM value that matches the number of beats of the musical compositions.

BeatBreaker Function

What the BeatBreaker effector does

This effector breaks down the music signals in each bar obtained from the BPM value a quarter beat at a time into 16 sections, replaces these sections with a preset beat pattern, and then plays them back to achieve an effect where the beat of the original musical composition is changed.

Details of operation

The beat patterns consist of 16 blocks, and when these blocks are lighted, the sound is being replaced by the initial sound of the beat.

When this effect is ON, the left block and beat display are used, and the block being played is indicated.

Example:

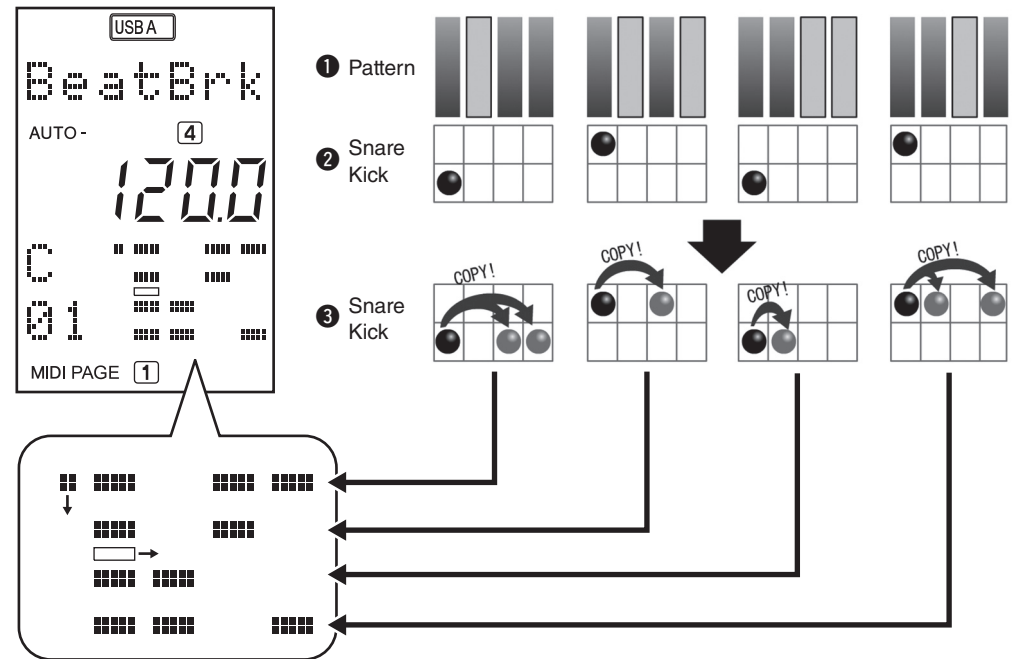

In the case of pattern ① shown in the figure, when the music signals ② are input, the sound of signals ③, which are produced by replacing the sound of the first quarter beat with the lighted section, are output.

Operation method

Using the **Effect ON/OFF** buttons, the effect with the timing when the buttons were set to ON at the beginning is added.

The beat pattern is selected using the **BEAT** ◀, ▶ buttons.

In the Utility mode, five user presets can be created.

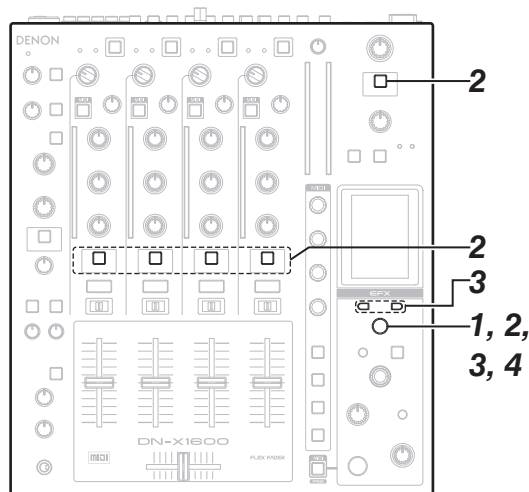

Effector Operations

Selecting the effector units and channels

With the input channels:

Using the **EFX SEND** button, select the effect units to be used. The same effect can be selected for a multiple number of channels.

With the mic input and master output:

Using the **EFX INS** button, select the effect unit to be used. The insertion operation is initiated and just the one channel is selected.

Setting the BPM

- 1 When the auto BPM counter is off, press the **TAP** button for over 1 second to turn the auto BPM counter on.
- 2 When the auto BPM counter is on, press the **TAP** button and release it immediately. The data measured with the auto BPM function is locked.
 - The channel for which the effect unit was last selected using the **EFX SEND** or **EFX INS** button takes effect as the channel used for the auto BPM counter measurement.
- 3 If the **TAP** button is pressed down for over 2 seconds, the BPM value can be set directly by pressing the **BEAT** buttons.
- 4 The BPM value can be set by the interval during which the **TAP** buttons are repeatedly pressed.

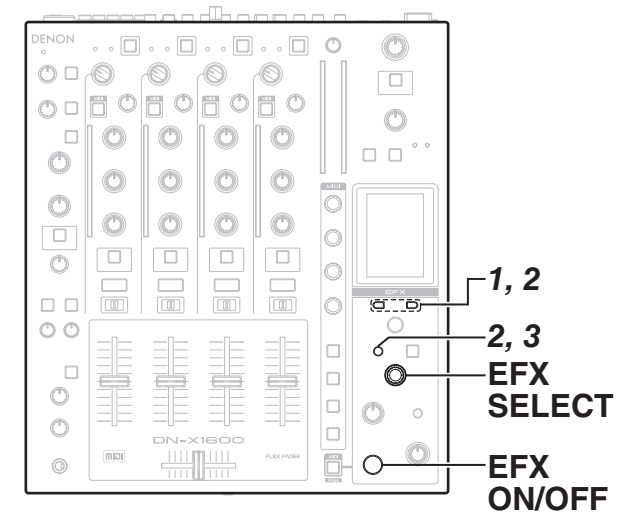

Setting the beat

- 1 Press the **BEAT** , buttons to set the number of beats.
- 2 When the **TIME** button is pressed, the mode is changed to the time input mode. The time can be adjusted by pressing the **BEAT** , buttons.
- 3 When the **TIME** button is pressed again, the number of beats setting mode is restored.

Selecting the effects

Turn the **EFX SELECT** controls to select the effect, and press the control to enter the desired effect.

Turning the effects ON and OFF

When the **Effect ON/OFF** buttons are pressed, the effect is turned ON or OFF.

Fader Start Function

- The fader start function controls playback/pause of the CD player using the fader control on the unit by sending a fader command to the CD player.
- Check that the FADER terminal of this unit and CD player are connected using a 3.5mm stereo mini plug cable.

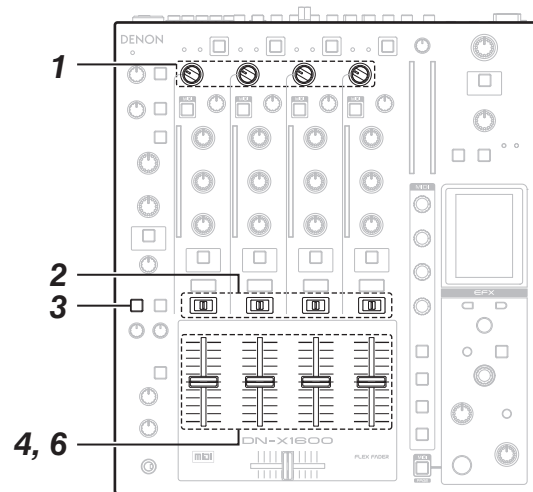

Channel Fader Start

- 1** Using the **SOURCE SEL** controls, select the source from **LINE1 CD**, **LINE2 CD**, **LINE3 CD** and **LINE4 CD**.
- 2** Turn the **CROSSFADER ASSIGN** switch to **THRU**.
- 3** Turn on the **CH FADER START** switch.
- 4** Move the **channel input faders** for **CH1** to **CH4** all the way to the bottom.
- 5** Set the standby mode on CD player.
- 6** When you want to start the player, move up the **Channel input fader (CH FADER)** and the CD player will begin playing.

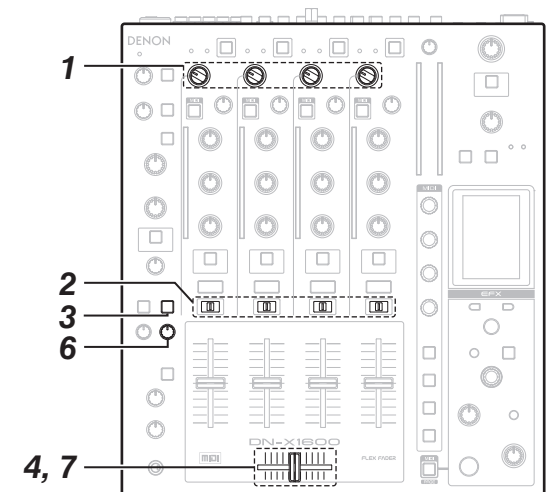

Crossfader Start

- 1** Using the **SOURCE SEL** controls, select the source from LINE1 CD, LINE2 CD, LINE3 CD and LINE4 CD.
- 2** Set the **CROSSFADER ASSIGN** switches (A/THRU/B) to A or B.
- 3** Turn on the **CROSSFADER START** switches.
- 4** Slide the **Crossfader** all the way in direction opposite the source you want to start. (In the following example, startup is done with the CD player connected set to Assign A.)
- 5** Set the standby mode on CD player.
- 6** Use the **CROSSFADER CONTOUR** control to control the cross fader startup curve.
- 7** When the **Crossfader** is slide in the opposite direction, CD player play will begin.

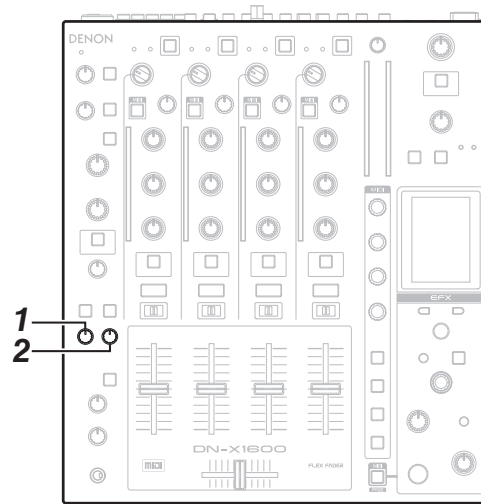

FADER (setting the fader curve)

This adjusts the rise response of the channel fader/cross fader.

1 Setting the channel fader curve

- When the **channel fader CONTOUR** control is turned to the left, the curve will have characteristics that rise gradually.
- When turned to the right, it will have characteristics that rise sharply.
- At the center position, curve characteristics between the two will be produced.
- The same curve characteristics apply to channels 1 to 4.

2 Setting the crossfader curve

- When the **crossfader CONTOUR** control is turned to the left, the curve will have characteristics that rise gradually.
- When turned to the right, it will have characteristics that rise sharply, and cut-in and cut-out operations will be performed.
- At the center position, curve characteristics between the two will be produced.

How to adjust the Crossfader torque

- 1** Remove the rubber cap of the front panel.
- 2** Move the **Crossfader** to the far right until the screw head becomes visible.

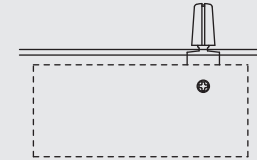

- 3** Insert a screwdriver, and adjust the sliding torque.
 - When the screw is turned clockwise: The sliding torque is increased so that the Crossfader moves more stiffly.
 - When the screw is turned counterclockwise: The sliding torque is decreased so that the Crossfader moves more easily.

- 4** After completing the adjustments, replace the rubber cap onto the front panel.

NOTE

- The Crossfader has a high-precision construction: As such, tightening the screw with too much force or loosening it excessively may result in damage or adversely affect performance.

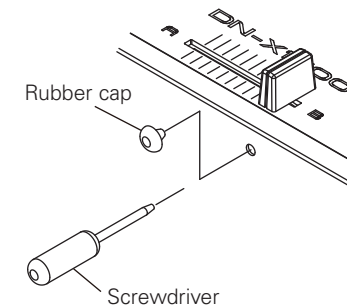

USB Settings

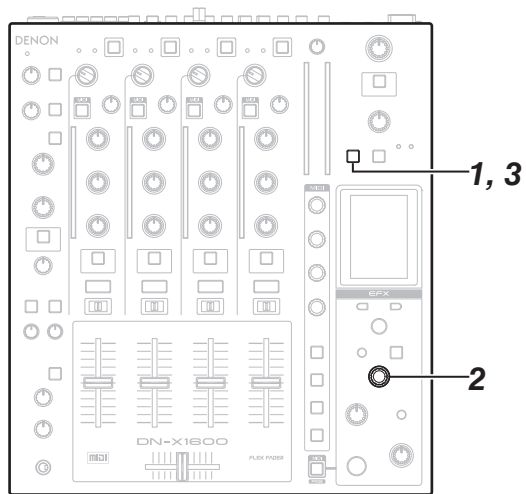

Selecting the USB mode

The respective functions given below are carried out in the operation modes of the USB A terminal (USB host mode) and USB B terminal (USB device mode).

USB A :

- Preset data import/export function
- Version upgrading

USB B :

- USB audio interface function
- USB MIDI interface function

The operation mode to be established when the unit's power is turned on can be selected by a Utility setting.

(Factory setting: USB A)

Follow the procedure below to switch from USB host mode (USB A terminal) to USB device mode (USB B terminal).

1 Press the **UTILITY/-USB A/USB B** button for more than a second.

Operation now transfers to the screen shown below.

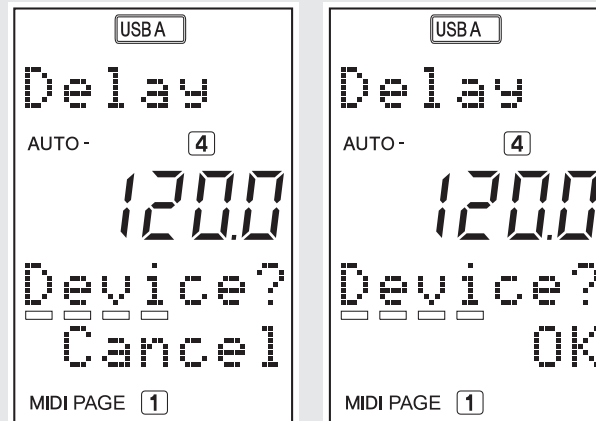

2 Select **OK/Cancel** using the **EFX SELECT** control, and press the button to enter the selection.

- The indicator changes from USB-A to USB-B, and the device mode is established.
- When a specific period of time elapses with no computer connected to the USB B terminal, the indicator changes back to USB-A, and the host mode is automatically selected.

3 To select the host mode again, press the **UTILITY/-USB A/USB B** button for more than a second, and select the settings by following the same steps.

USB audio

This unit features a 24-bit 96 kHz USB audio input/output sound card function which supports up to 8 channels (4 stereo systems). The sampling frequency can be set to 44.1 kHz, 48 kHz or 96 kHz using a Utility setting (factory setting: 96 kHz).

- When the unit is connected to a computer which runs Windows XP, Vista or a similar operating system, install DENON DJ ASIO driver Ver2 contained on the CD-ROM provided. Operation cannot be guaranteed on computers that are running with an OS prior to Windows XP SP2.
- If the Ver1 driver is already installed, first uninstall it, and then install the Ver2 driver.
- Depending on the computer used, select the PC/MAC section settings under System Setting among the Utility settings.

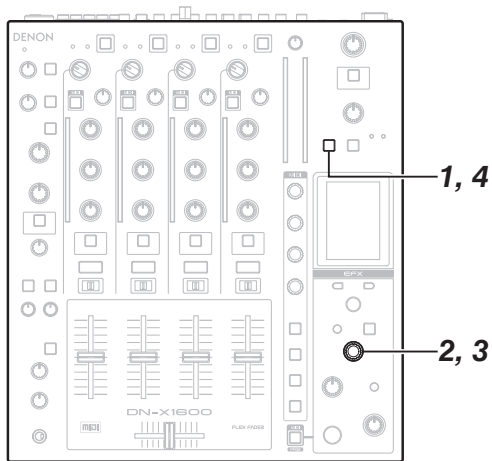

Setting the USB audio output

The following audio sources can be selected for USB audio output.

- Input channels 1–4 (Pre EQ)
- Mic input (Post Send VR)
- Master output
- REC output

The USB audio output level can be adjusted using a Utility setting.

- 1 Press the UTILITY/–USB A/USB B button.**
 - The Utility setting screen is displayed.
- 2 Using the EFX SELECT control, select Audio Setting → USB Audio Setting → Output Source Select.**
- 3 One of the audio sources assigned to the USB output channels is selected on the selection screen displayed.**
- 4 Press the UTILITY/–USB A/USB B button.**
 - The Utility setting screen is closed.

Setting the USB audio input

One of the two modes below is set using the **UTILITY** for the USB audio input assignment destinations.

The LED on the side corresponding to the mode selected lights.

The USB audio input levels can be adjusted using Utility settings. The adjustment values are stored on a mode by mode basis.

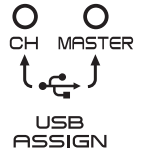

① CH INPUT mode

Select this mode when mixing sound using only the DN-X1600 without using the mixer functions of the DJ software. The USB audio input signals are assigned using the configuration shown below.

- USB channel 1 and 2 inputs → Input channel 1
- USB channel 3 and 4 inputs → Input channel 2
- USB channel 5 and 6 inputs → Input channel 3
- USB channel 7 and 8 inputs → Input channel 4

② MASTER mode

Select this mode when using both the mixer functions of the DJ software and the DN-X1600's functions. The USB audio input signals are assigned to the buses shown below.

- USB channel 1 and 2 inputs → Master bus
- USB channel 3 and 4 inputs → Cue monitor bus
- USB channel 5 and 6 inputs → Disabled
- USB channel 7 and 8 inputs → Disabled

The mixer output of the DJ software is mixed in the buses using the DN-X1600.

- Ensure that the audio output settings of the DJ software correspond to the specifications given above.

MIDI

This unit comes with USB MIDI input/output and 5-pin DIN MIDI output functions.

These functions support the MIDI control functions of almost all the controls as well as the MIDI clock.

Setting the MIDI channels

- 1** Press the **UTILITY/–USB A/USB B** button.
- 2** Use the **EFX SELECT** control to select the **MIDI Setting**→**MIDI INPUT CH** or **MIDI OUTPUT CH**.
- 3** Set the MIDI channels.

Setting the MIDI clock

The MIDI clock that is synchronized with the set BPM value is output. (60 to 300 BPM)

- 1** Press the **MIDI CLK** button.
 - The MIDI clock is output from the USB MIDI and MIDI output terminals.
 - The **MIDI CLK** button lights up.

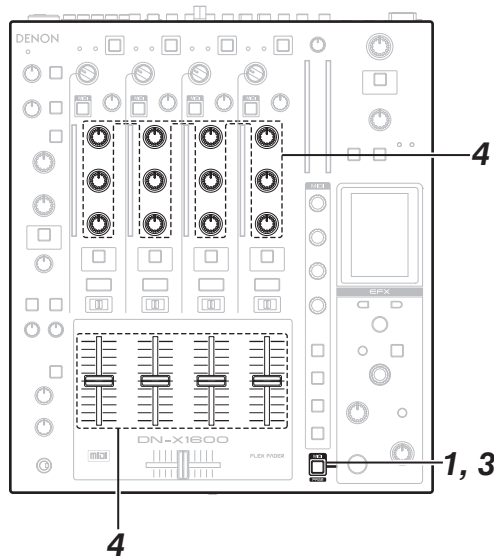

MIDI layer operations

The unit incorporates a MIDI layer function for the input channels. This function controls the external devices and software as the MIDI controller.

- 1** Press the **MIDI** buttons.
 - The MIDI button lights up, and the MIDI layer operations are performed.
- 2** The **MIDI commands corresponding to the operations using the panel controls are output.**
 - The operations are not reflected in the unit, and normal operation as a mixer cannot be performed.
 - The MIDI signals are received, and the LEDs light up or go off.
 - MIDI output operation block
Channel isolator EQ (HI, MID, LOW) controls; **Channel EFX SEND** button; **CUE** buttons; **Channel Fader**
 - MIDI input operation block
 The **channel level meter**; **channel EFX SEND** button; **CUE** button display

- 3** When the **MIDI** button is pressed again, the **MIDI** button light goes out, and the **MIDI** layer operations are ended.
 - The details of the operation are not output to the MIDI terminals, and the unit can be operated as normal.

- 4** If, at the completion of the MIDI layer operations, the positions of the **EQ adjustment controls** and **Channel Fader** differ from the internal statuses of the unit, the unit locks its internal statuses without reflecting the positions of the controls.
 - While these statuses are locked, the **EQ LOCK** indicator flashes.

- 5** If a control that is locked is operated, the lock screen appears.

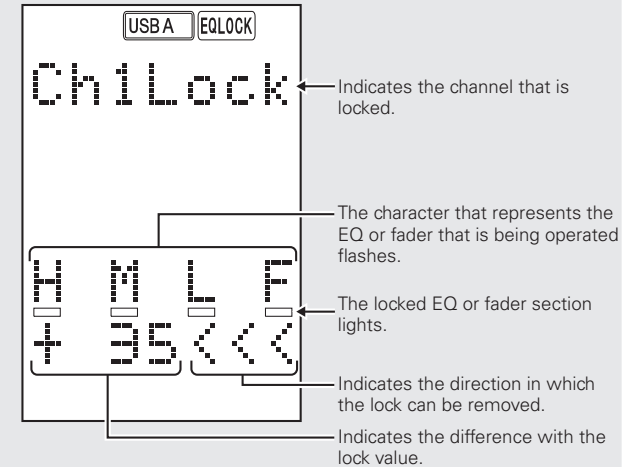

- 6** When the control matches the locked position, the lock is released, and normal operations can be performed on the unit.

DVS function

The DVS (Digital Vinyl System) function is used when a record or CD that contains a time code is played back, and the time code signal input from the CD player is sent to the computer to be converted to a music signal before being input to the unit.

- Check that the DVS software has been installed on the computer.

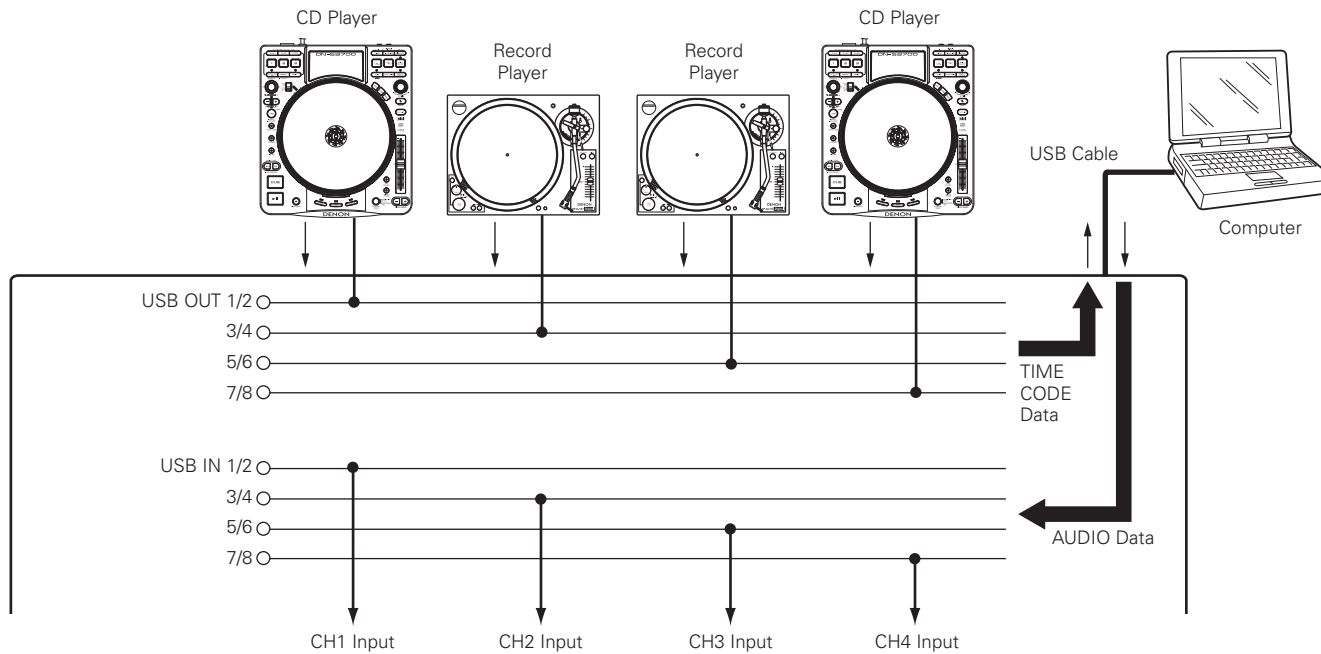

- 1 Select USB Audio Setting → Preset Input Select in the UTILITY settings, and check that the settings are DVS.**
 - DVS is the default setting
- 2 Select USB Audio Setting → USB Assign in the UTILITY settings, and change the setting details to CH.**
- 3 Set the channel to be used with the P1–P4 of the source selector.**
- 4 Set the USB mode to device mode for the unit.**
- 5 Set the DVS software in the computer.**
- 6 Plays the player that is connected to LINE.**
 - Enter the TIME CODE data to the connected LINE. The TIME CODE data is entered to the computer via the USB cable. The data is converted to AUDIO data by the computer, and then input to the various channels of this device.
- 7 Adjust the volume etc. for the connected line.**

MIDI Command List

Send commands

	items	MIDI command		
		Command	Number	Value
CH1	EQ HIGH VR	0xBn	0x02	0x00 to 0x7F
	EQ MID VR	0xBn	0x03	0x00 to 0x7F
	EQ LOW VR	0xBn	0x04	0x00 to 0x7F
	FADER	0xBn	0x05	0x00 to 0x7F
	EFFECT SEND	SW ON : 0x9n / SW OFF : 0x8n	0x01	SW ON : 0x40 / SW OFF : 0x00
	CUE	SW ON : 0x9n / SW OFF : 0x8n	0x03	SW ON : 0x40 / SW OFF : 0x00
MIDI LAYER CHANGE	0xBn	0x46	0x00,0x7F	
CH2	EQ HIGH VR	0xBn	0x08	0x00 to 0x7F
	EQ MID VR	0xBn	0x09	0x00 to 0x7F
	EQ LOW VR	0xBn	0x0A	0x00 to 0x7F
	FADER	0xBn	0x0B	0x00 to 0x7F
	EFFECT SEND	SW ON : 0x9n / SW OFF : 0x8n	0x05	SW ON : 0x40 / SW OFF : 0x00
	CUE	SW ON : 0x9n / SW OFF : 0x8n	0x07	SW ON : 0x40 / SW OFF : 0x00
MIDI LAYER CHANGE	0xBn	0x47	0x00,0x7F	
CH3	EQ HIGH VR	0xBn	0x0D	0x00 to 0x7F
	EQ MID VR	0xBn	0x0E	0x00 to 0x7F
	EQ LOW VR	0xBn	0x0F	0x00 to 0x7F
	FADER	0xBn	0x10	0x00 to 0x7F
	EFFECT SEND	SW ON : 0x9n / SW OFF : 0x8n	0x09	SW ON : 0x40 / SW OFF : 0x00
	CUE	SW ON : 0x9n / SW OFF : 0x8n	0x0B	SW ON : 0x40 / SW OFF : 0x00
MIDI LAYER CHANGE	0xBn	0x48	0x00,0x7F	
CH4	EQ HIGH VR	0xBn	0x12	0x00 to 0x7F
	EQ MID VR	0xBn	0x13	0x00 to 0x7F
	EQ LOW VR	0xBn	0x14	0x00 to 0x7F
	FADER	0xBn	0x15	0x00 to 0x7F
	EFFECT SEND	SW ON : 0x9n / SW OFF : 0x8n	0x0D	SW ON : 0x40 / SW OFF : 0x00
	CUE	SW ON : 0x9n / SW OFF : 0x8n	0x0F	SW ON : 0x40 / SW OFF : 0x00
MIDI LAYER CHANGE	0xBn	0x49	0x00,0x7F	
CROSS FADER	0xBn	0x16	0x00 to 0x7F	
MASTER	MASTER LEVEL VR	0xBn	0x19	0x00 to 0x7F
	BALANCE VR	0xBn	0x1A	0x00 to 0x7F
	BOOTH LEVEL VR	0xBn	0x1B	0x00 to 0x7F
	EFFECT INSERT	SW ON : 0x9n / SW OFF : 0x8n	0x11	SW ON : 0x40 / SW OFF : 0x00
EFFECT	BEAT UP	SW ON : 0x9n / SW OFF : 0x8n	0x16	SW ON : 0x40 / SW OFF : 0x00
	BEAT DOWN	SW ON : 0x9n / SW OFF : 0x8n	0x17	SW ON : 0x40 / SW OFF : 0x00
	TAP	SW ON : 0x9n / SW OFF : 0x8n	0x18	SW ON : 0x40 / SW OFF : 0x00
	TIME	SW ON : 0x9n / SW OFF : 0x8n	0x19	SW ON : 0x40 / SW OFF : 0x00
	CUE	SW ON : 0x9n / SW OFF : 0x8n	0x1A	SW ON : 0x40 / SW OFF : 0x00
	EFFECT SELECT KNOB SW	SW ON : 0x9n / SW OFF : 0x8n	0x1B	SW ON : 0x40 / SW OFF : 0x00
	PARAMETER SW	SW ON : 0x9n / SW OFF : 0x8n	0x1C	SW ON : 0x40 / SW OFF : 0x00
	EFFECT ON/OFF	SW ON : 0x9n / SW OFF : 0x8n	0x1D	SW ON : 0x40 / SW OFF : 0x00
	EFFECT SELECT KNOB	0xBn	0x44	Increment 0x00 Decrement 0x7F
	PARAMETER VR	0xBn	0x1C	0x00 to 0x7F
	DRY/WET VR	0xBn	0x1D	0x00 to 0x7F
	MIDI LAYER CHANGE	0xBn	0x4B	0x00,0x7F
MIC/PHONES	MIC EQ HIGH VR	0xBn	0x21	0x00 to 0x7F
	MIC EQ LOW VR	0xBn	0x22	0x00 to 0x7F
	MIC SEND LEVEL VR	0xBn	0x23	0x00 to 0x7F
	MIC1 TRIM ON/OFF	SW ON : 0x9n / SW OFF : 0x8n	0x26	SW ON : 0x40 / SW OFF : 0x00
	MIC2 TRIM ON/OFF	SW ON : 0x9n / SW OFF : 0x8n	0x27	SW ON : 0x40 / SW OFF : 0x00
	MIC EFFECT INSERT	SW ON : 0x9n / SW OFF : 0x8n	0x28	SW ON : 0x40 / SW OFF : 0x00
DUCKING	SW ON : 0x9n / SW OFF : 0x8n	0x2A	SW ON : 0x40 / SW OFF : 0x00	
MIDI (Page 1)	PARAM 1	0xBn	0x50	Increment 0x00 Decrement 0x7F
	PARAM 1 SW	SW ON : 0x9n / SW OFF : 0x8n	0x40	SW ON : 0x40 / SW OFF : 0x00
	PARAM 2	0xBn	0x51	Increment 0x00 Decrement 0x7F
	PARAM 2 SW	SW ON : 0x9n / SW OFF : 0x8n	0x41	SW ON : 0x40 / SW OFF : 0x00

	items	MIDI command		
		Command	Number	Value
MIDI (Page 1)	PARAM 3	0xBn	0x52	Increment 0x00 Decrement 0x7F
	PARAM 3 SW	SW ON : 0x9n / SW OFF : 0x8n	0x42	SW ON : 0x40 / SW OFF : 0x00
	PARAM 4	0xBn	0x53	Increment 0x00 Decrement 0x7F
	PARAM 4 SW	SW ON : 0x9n / SW OFF : 0x8n	0x43	SW ON : 0x40 / SW OFF : 0x00
	FUNC 1	SW ON : 0x9n / SW OFF : 0x8n	0x44	SW ON : 0x40 / SW OFF : 0x00
	FUNC 2	SW ON : 0x9n / SW OFF : 0x8n	0x45	SW ON : 0x40 / SW OFF : 0x00
	FUNC 3	SW ON : 0x9n / SW OFF : 0x8n	0x46	SW ON : 0x40 / SW OFF : 0x00
	FUNC 4	SW ON : 0x9n / SW OFF : 0x8n	0x47	SW ON : 0x40 / SW OFF : 0x00
	PARAM 1	0xBn	0x54	Increment 0x00 Decrement 0x7F
	PARAM 1 SW	SW ON : 0x9n / SW OFF : 0x8n	0x48	SW ON : 0x40 / SW OFF : 0x00
MIDI (Page 2)	PARAM 2	0xBn	0x55	Increment 0x00 Decrement 0x7F
	PARAM 2 SW	SW ON : 0x9n / SW OFF : 0x8n	0x49	SW ON : 0x40 / SW OFF : 0x00
	PARAM 3	0xBn	0x56	Increment 0x00 Decrement 0x7F
	PARAM 3 SW	SW ON : 0x9n / SW OFF : 0x8n	0x4A	SW ON : 0x40 / SW OFF : 0x00
	PARAM 4	0xBn	0x57	Increment 0x00 Decrement 0x7F
	PARAM 4 SW	SW ON : 0x9n / SW OFF : 0x8n	0x4B	SW ON : 0x40 / SW OFF : 0x00
	FUNC 1	SW ON : 0x9n / SW OFF : 0x8n	0x4C	SW ON : 0x40 / SW OFF : 0x00
	FUNC 2	SW ON : 0x9n / SW OFF : 0x8n	0x4D	SW ON : 0x40 / SW OFF : 0x00
	FUNC 3	SW ON : 0x9n / SW OFF : 0x8n	0x4E	SW ON : 0x40 / SW OFF : 0x00
	FUNC 4	SW ON : 0x9n / SW OFF : 0x8n	0x4F	SW ON : 0x40 / SW OFF : 0x00
MIDI (Page 3)	PARAM 1	0xBn	0x58	Increment 0x00 Decrement 0x7F
	PARAM 1 SW	SW ON : 0x9n / SW OFF : 0x8n	0x50	SW ON : 0x40 / SW OFF : 0x00
	PARAM 2	0xBn	0x59	Increment 0x00 Decrement 0x7F
	PARAM 2 SW	SW ON : 0x9n / SW OFF : 0x8n	0x51	SW ON : 0x40 / SW OFF : 0x00
	PARAM 3	0xBn	0x5A	Increment 0x00 Decrement 0x7F
	PARAM 3 SW	SW ON : 0x9n / SW OFF : 0x8n	0x52	SW ON : 0x40 / SW OFF : 0x00
	PARAM 4	0xBn	0x5B	Increment 0x00 Decrement 0x7F
	PARAM 4 SW	SW ON : 0x9n / SW OFF : 0x8n	0x53	SW ON : 0x40 / SW OFF : 0x00
	FUNC 1	SW ON : 0x9n / SW OFF : 0x8n	0x54	SW ON : 0x40 / SW OFF : 0x00
	FUNC 2	SW ON : 0x9n / SW OFF : 0x8n	0x55	SW ON : 0x40 / SW OFF : 0x00
MIDI (Page 4)	FUNC 3	SW ON : 0x9n / SW OFF : 0x8n	0x56	SW ON : 0x40 / SW OFF : 0x00
	FUNC 4	SW ON : 0x9n / SW OFF : 0x8n	0x57	SW ON : 0x40 / SW OFF : 0x00
	PARAM 1	0xBn	0x5C	Increment 0x00 Decrement 0x7F
	PARAM 1 SW	SW ON : 0x9n / SW OFF : 0x8n	0x58	SW ON : 0x40 / SW OFF : 0x00
	PARAM 2	0xBn	0x5D	Increment 0x00 Decrement 0x7F
	PARAM 2 SW	SW ON : 0x9n / SW OFF : 0x8n	0x59	SW ON : 0x40 / SW OFF : 0x00
	PARAM 3	0xBn	0x5E	Increment 0x00 Decrement 0x7F
	PARAM 3 SW	SW ON : 0x9n / SW OFF : 0x8n	0x5A	SW ON : 0x40 / SW OFF : 0x00
	PARAM 4	0xBn	0x5F	Increment 0x00 Decrement 0x7F
	PARAM 4 SW	SW ON : 0x9n / SW OFF : 0x8n	0x5B	SW ON : 0x40 / SW OFF : 0x00
MIDI Page	FUNC 1	SW ON : 0x9n / SW OFF : 0x8n	0x5C	SW ON : 0x40 / SW OFF : 0x00
	FUNC 2	SW ON : 0x9n / SW OFF : 0x8n	0x5D	SW ON : 0x40 / SW OFF : 0x00
	FUNC 3	SW ON : 0x9n / SW OFF : 0x8n	0x5E	SW ON : 0x40 / SW OFF : 0x00
	FUNC 4	SW ON : 0x9n / SW OFF : 0x8n	0x5F	SW ON : 0x40 / SW OFF : 0x00
Other	MIDI Page CHANGE	0xBn	0x4C	0x00, 0x01, 0x02, 0x03 Preset mode on : 0x7F Preset mode off : 0x00

* n=MIDI CH

Receive commands

	items	MIDI command		
		Command	Number	Value
	LED	0xBn	↓	
CH1	Level Meter -40dB		ON TRG : 0x50 OFF TRG : 0x51	0x01
	Level Meter -30dB		↓	0x02
	Level Meter -20dB		↓	0x03
	Level Meter -15dB		↓	0x04
	Level Meter -10dB		↓	0x05
	Level Meter -7dB		↓	0x06
	Level Meter -4dB		↓	0x07
	Level Meter -2dB		↓	0x08
	Level Meter -1dB		↓	0x09
	Level Meter 0dB		↓	0x0A
	Level Meter 1dB		↓	0x0B
	Level Meter 2dB		↓	0x0C
	Level Meter 4dB		↓	0x0D
	Level Meter 7dB		↓	0x0E
	Level Meter 10dB		↓	0x0F
	Level Meter PEAK		↓	0x10
CH2	Level Meter -40dB		ON TRG : 0x50 OFF TRG : 0x51	0x11
	Level Meter -30dB		↓	0x12
	Level Meter -20dB		↓	0x13
	Level Meter -15dB		↓	0x14
	Level Meter -10dB		↓	0x15
	Level Meter -7dB		↓	0x16
	Level Meter -4dB		↓	0x17
	Level Meter -2dB		↓	0x18
	Level Meter -1dB		↓	0x19
	Level Meter 0dB		↓	0x1A
	Level Meter 1dB		↓	0x1B
	Level Meter 2dB		↓	0x1C
	Level Meter 4dB		↓	0x1D
	Level Meter 7dB		↓	0x1E
	Level Meter 10dB		↓	0x1F
	Level Meter PEAK		↓	0x20
CH3	Level Meter -40dB		ON TRG : 0x50 OFF TRG : 0x51	0x21
	Level Meter -30dB		↓	0x22
	Level Meter -20dB		↓	0x23
	Level Meter -15dB		↓	0x24
	Level Meter -10dB		↓	0x25
	Level Meter -7dB		↓	0x26
	Level Meter -4dB		↓	0x27
	Level Meter -2dB		↓	0x28
	Level Meter -1dB		↓	0x29
	Level Meter 0dB		↓	0x2A
	Level Meter 1dB		↓	0x2B
	Level Meter 2dB		↓	0x2C
	Level Meter 4dB		↓	0x2D
	Level Meter 7dB		↓	0x2E
	Level Meter 10dB		↓	0x2F
	Level Meter PEAK		↓	0x30

	items	MIDI command		
		Command	Number	Value
	LED	0xBn	↓	
CH4	Level Meter -40dB		ON TRG : 0x50 OFF TRG : 0x51	0x31
	Level Meter -30dB		↓	0x32
	Level Meter -20dB		↓	0x33
	Level Meter -15dB		↓	0x34
	Level Meter -10dB		↓	0x35
	Level Meter -7dB		↓	0x36
	Level Meter -4dB		↓	0x37
	Level Meter -2dB		↓	0x38
	Level Meter -1dB		↓	0x39
	Level Meter 0dB		↓	0x3A
	Level Meter 1dB		↓	0x3B
	Level Meter 2dB		↓	0x3C
	Level Meter 4dB		↓	0x3D
	Level Meter 7dB		↓	0x3E
	Level Meter 10dB		↓	0x3F
	Level Meter PEAK		↓	0x40
CH1	EFX SEND		ON TRG : 0x50 OFF TRG : 0x51	0x41
	EFX SEND Dimmer		↓	0x42
	CUE		↓	0x45
	CUE Dimmer		↓	0x46
CH2	EFX SEND		ON TRG : 0x50 OFF TRG : 0x51	0x47
	EFX SEND Dimmer		↓	0x48
	CUE		↓	0x4B
	CUE Dimmer		↓	0x4C
CH3	EFX SEND		ON TRG : 0x50 OFF TRG : 0x51	0x4D
	EFX SEND Dimmer		↓	0x4E
	CUE		↓	0x51
	CUE Dimmer		↓	0x52
CH4	EFX SEND		ON TRG : 0x50 OFF TRG : 0x51	0x53
	EFX SEND Dimmer		↓	0x54
	CUE		↓	0x57
	CUE Dimmer		↓	0x58
EFX	TAP		ON TRG : 0x50 OFF TRG : 0x51	0x59
	CUE		↓	0x5A
	CUE Dimmer		↓	0x5B
	EFX SELECT		↓	0x5C
	Parameter ON/OFF		↓	0x5D
	DRY/WET		↓	0x5E
	EFX ON/OFF		↓	0x5F
	EFX ON/OFF Dimmer		↓	0x60
MIDI	FUNC1		ON TRG : 0x50 OFF TRG : 0x51	0x61
	FUNC2		↓	0x62
	FUNC3		↓	0x63
	FUNC4		↓	0x64

* n=MIDI CH

- Getting Started
- Connections
- Basic Operations
- Effector Function
- Fader Start
- USB
- Utility
- Specifications
- Troubleshooting

Utility settings

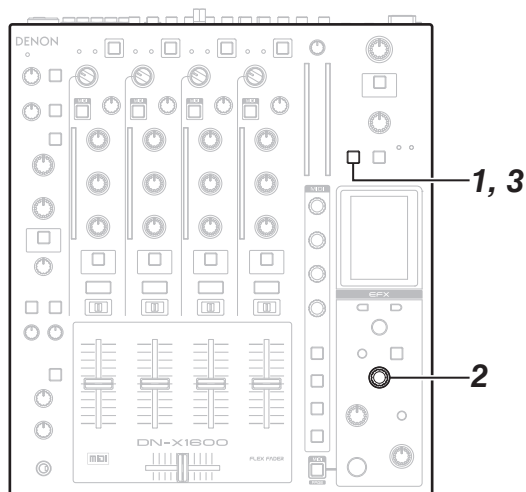

Utility operations

The following items can be set for the utility mode.

- 1 Audio Setting
- 2 System Setting
- 3 MIDI Setting
- 4 Other Setting
- 5 Owner Setting

For details on the settings, see the preset items and data (page 23).

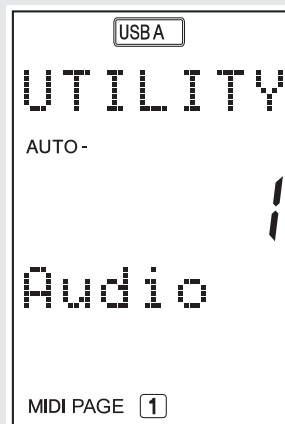

1 Press the **UTILITY/–USB A/USB B** button. The utility screen now appears.

2 Using the **EFFECT SELECT** control, select the item, and press the control to enter the selection.

- When the selection is entered, the items and data are switched using the hierarchy shown in the table below.
- To go back to the selection, press the **BACK** button. Operation then returns to the previous screen.

3 In the Utility mode, press the **UTILITY/–USB A/USB B** button to turn off the Utility mode.

- The data which has been set is now stored in the internal memory.

Preset Items and Data

Category	Item	Parameter	Value	Default Settings	Setting Details		
1 Audio Setting	1 Master Setting	1 MONO	ON / OFF	OFF	When set to ON, the Master output is monaural.		
	2 Mic Setting	1 Ducking Level		-20dB to -40dB	-30dB	Adjusts the amount of attenuation for the audio level when ducking is operating.	
		2 Ducking Response		Fast or Normal	Normal	Adjusts the ducking response.	
		3 Mic EQ	1 Hi		1kHz to 4kHz	2kHz	Sets the Mic EQ cut off frequency.
			2 Low		500Hz to 2kHz	1kHz	
	3 Default				-		
	4 Isolator EQ	4 Mic to Booth/Rec		ON / OFF	OFF	When set to ON, the Mic sound is output from Booth and Rec.	
		1 X.Over Hi		1kHz to 8kHz	2kHz	Sets the boundary lines for the frequencies that control Hi, Mid, and Low in the channel equalizer.	
		2 X.Over Low		100Hz to 800Hz	360Hz		
	3 Default			-			
	4 Cue Setting	1 Cue Mode *1		Mix / Solo	Mix	When set to Solo, audio from only one channel can be continually cued.	
	5 Head Phones EQ	1 EQ Hi		-15dB to +15dB	0dB	Adjusts the equalizer settings for the headphones.	
		2 EQ Low		-15dB to +15dB	0dB		
		3 Default			-		
	6 EFX Send/Rtn	1 Unity Level Select		-10dBV / 0dBV	-10dBV	Selects the signal level for the Effect Rtn with connected device.	
	7 USB Audio Setting	1 USB Assign		Ch / Master	Ch	Selects whether to assign a channel to the USB audio input, or to add a Master/Cue bus.	
		2 OutputSourceSelect	1 USB1 / USB2		Master	Selects the source output with the USB audio.	
			2 USB3 / USB4		Mic		
			3 USB5 / USB6		CH2		
4 USB7 / USB8				CH3			
3 Preset Input Select		1 CH1		USB1/USB2,USB3/USB4, USB5/USB6,USB7/USB8,DVS	DVS	Selects the source input with P1-P4.	
		2 CH2					
		3 CH3					
		4 CH4					
4 Output Level VR				-20dB to +20dB	0dB	Selects the USB audio output level.	
5 CH Input Level VR			-20dB to +20dB	-6dB	Selects the level when USB audio is input into Channel 1-4.		
6 Mas Input Level VR			-20dB to +20dB	-6dB	Selects the level when USB audio is input into Master.		
7 Cue Input Level VR			-20dB to +20dB	-6dB	Selects the level when USB audio is input into Cue.		
8 Digital Out Setting	1 Digital Output VR		-20dB to +20dB	0dB	Selects the output level for the Digital Out terminal.		
9 X-Fader Setting	1 A Side Cut Position *2		-2.0mm to +8.0mm	0.0mm	Adjusts the rise position for the A side cross fader.		
	2 B Side Cut Position *2		-2.0mm to +8.0mm	0.0mm	Adjusts the rise position for the B side cross fader.		
10 Beat Breaker Setting			1 to 5	1	Edits the custom pattern for the BeatBreaker.		
2 System Setting	1 Sampling Frequency		44.1kHz / 48kHz / 96kHz	96kHz	Selects the internal sampling rate for the unit.		
	2 PC/MAC*3		PC Mode / MAC Mode	PC Mode	Selects the type of connected computer when in device mode.		
	3 Version		XXXX	-	Displays the version number.		
3 MIDI Setting	1 MIDI INPUT CH		1 to 16, OMNI	1	Selects the USB MIDI INPUT CH.		
	2 MIDI OUTPUT CH		1 to 16	1	Selects the MIDI OUTPUT CH.		
	3 MIDI Output Enable	1 5Pin		ON / OFF	ON	Selects whether or not to output from MIDI.	
		2 USB		ON / OFF	ON		
	4 MIDI CLK	1 5Pin		ON / OFF	ON	Selects whether or not to output from MIDI CLOCK.	
		2 USB		ON / OFF	ON		
	5 MIDI Page			1 to 4	1	Selects the MIDI page for when the power is switched on.	
	6 V-LINK	1 Model		V-4 / V-8	V-4	Selects the model connected to V-LINK.	
		2 Device ID		0x00 to 0x1F	0x10	Selects the Device ID for the device connected to V-LINK.	
		3 Trigger Level		-40dBFS to 0dBFS	-30dBFS	Selects the level of trigger that switches the image effects when Ping Pong Delay is used.	
4 Cross Fader Contour			ON/OFF	OFF	Selects whether to reflect the crossfader curve on V-LINK.		
5 Cross Fader							
6 Beat							
7 Parameter			Enable / Disable	Enable	Selects whether or not to use each control with V-LINK.		
8 DRY/WET							
9 EFX Button							
10 FUNC1/FUNC2							
4 Other Setting	1 Preset Export		Exit / Execute*4	Exit	Writes the Presets to the USB memory.		
	2 DN-X1600 Initialize		Exit / Execute*5	Exit	Returns settings to the factory settings. (Excluding the Owner Setting items)		
5 Owner Setting	Display only				Displays the details of the Owner Settings.		

- *1 When SOLO is selected as the CUE mode setting, only one of the two CUE buttons, whichever was pressed last, becomes operational.
- *2 The cut-off position of the Crossfader can be adjusted separately for each side.
- *3 When the unit is connected to a computer which runs Windows XP, Vista or a similar operating system, select the PC Mode.
When it is connected to a computer which runs Mac OSX or a similar operating system, select the MAC Mode.
- *4 The settings for these Preset and the Owner mode settings can be stored on an external USB memory or other memory device.
- *5 The settings for these Preset are set to the factory settings.

Getting Started
Connections
Basic Operations
Effector Function
Fader Start
USB
Utility
Specifications
Troubleshooting

Preset Export

Writes the details of the settings performed in utility mode to the connected USB memory.

- 1 **Connect the USB memory to the unit.**
- 2 **In the Utility settings, select Other Settings → Preset Export.**
- 3 **Press Execute to write the Preset conditions to the USB memory.**
 - If an export file already exists, an overwrite confirmation screen is displayed.
 - If you perform Preset Import on a DN-X1700 using a file exported from a DN-X1600 using Preset Export, the settings in the imported file may be different from those in the exported file. In this case, set the items that are different.

Preset Recall

This recalls the setting contents from the export file that was written to the USB memory.
After recall is completed, the setting details are not updated in the unit.
Use Preset Recall to temporarily use the settings stored in the USB memory.

- 1 **Insert the USB memory device with the export files into the DN-X1600 or turn on the unit's power with the device already inserted.**
- 2 **A screen prompting the user to verify whether the presets are to be called appears.**
- 3 **When OK is selected, the preset Audio Setting and MIDI Setting of the export file are called.**
 - The preset information stored inside the DN-X1600 is not updated.
- 4 **When the USB memory device is ejected, a screen prompting the user to verify whether to return to the status before the presets were called appears.**
 - Cancel cannot be selected.

5 When OK is selected, the presets are restored to the status before they were called.

- After the presets are called, they are retained while the unit remains connected to the computer even if the USB B mode is selected.

Owner Setting Mode

When the **POWER** switch is set to the ON position while the **UTILITY/–USB A/USB B** button is held down, the Owner Setting mode is established, and the settings listed below can be selected.
To release the Owner Setting mode, set the **POWER** switch to the OFF position.

Parameter	Value	Default
1. Digital Output FS	INT / 44.1kHz / 48kHz / 96kHz	44.1kHz
2. Power ON USB Mode	USB A / USB B	USB A
3. Preset Import	Exit / Execute*1	-
4. DN-X1600 Initialize	Exit / Execute*2	-

- Using the Preset stored externally, the internal memory is updated, and the settings are reflected in the device.
- All the Owner settings and Preset are set to the factory settings.

1. Digital Output FS

This sets the digital output frequency for the unit. When set to INT, the frequency is synchronized with the System Setting sampling frequency.

2. Power ON USB Mode

This selects the USB mode to be used when the power is switched on.

3. Preset Import

Imports the presets from inside the USB memory.

4. DN-X1600 Initialize

Returns all of the items for the unit to the factory settings.

Preset Import

This imports the setting contents from the export file that was written to the USB memory.
After recall is completed, the setting details are updated in the unit.

- 1 **In the Owner Setting mode, insert the USB memory device with the export files into the DN-X1600 or establish the Owner Setting mode with the device already inserted.**
- 2 **A screen prompting the user to verify whether the preset memory is to be updated appears.**
- 3 **When OK is selected, the contents of the preset memory are updated to the contents of the export files.**

NOTE

- Bear in mind that the data prior to the updating will not be retained.

Specifications

□ AUDIO	(0 dBu = 0.775 Vrms, 0 dBV = 1 Vrms)	
• PHONO inputs	Stereo x 3	Unbalanced RCA terminal
Input impedance:	47 kΩ	
Level:	-40 dBV (10 mV)	
Signal to Noise ratio:	89 dB	
• CD inputs	Stereo x 5	Unbalanced RCA terminal
Input impedance:	10 kΩ	
Level:	0 dBV	
Signal to Noise ratio:	100 dB	
• Equalizer (LINE)	Band x 3	
Channel equalization adjustment range:	HI: -∞, -90 dB to +10 dB MID: -∞, -90 dB to +10 dB LOW: -∞, -90 dB to +6 dB	
• RETURN inputs	Monaural x 2	1/4" TS terminal
Input impedance:	10 kΩ	
Level:	-10dBV/0dBV (Default: -10dBV)	
• MIC inputs	Monaural x 2	
MIC1:	Balanced	XLR connectors
	(1: Ground, 2: Hot, 3: Cold)	
MIC2:	Balanced	1/4" TRS jack
	(Tip: hot, ring: cold, sleeve: ground)	
Input impedance:	5 kΩ	
Level:	-60 to -20 dBu	
EIN:	Less than -126 dBu (Rs = 150 Ω)	
CMRR:	More than 89 dB (1 kHz)	
• Equalizer (MIC)	Band x 2	
Adjustment range:	HI: -15 to +15 dB LOW: -15 to +15 dB	
• USB audio inputs	Stereo x 4 (monaural x 8) 24 bit, Fs: 44.1 kHz, 48 kHz, 96 kHz USB B	
• MASTER output		
Balanced:	Stereo, balanced XLR terminal	
	(1: Ground, 2: Hot, 3: Cold)	
DA converter:	32-bit 128x oversampling advanced segment converter	
Load impedance:	More than 600 Ω	
Level:	+4dBu (Max.: +24 dBu)	
Frequency response:	20 Hz to 20 kHz (±0.5 dB)	
THD:	Less than 0.05%	
Crosstalk:	Less than -100 dB (1 kHz)	
Unbalanced:	Stereo RCA terminal	
Load impedance:	10 kΩ	
Level:	0 dBu (Max.: +20 dBu)	
• REC output	Stereo	Unbalanced RCA terminal
Load impedance:	10 kΩ	
Level:	-10 dBV (Max.: +10 dBV)	

• BOOTH output	Stereo	Balanced 1/4" TRS terminal
	(Tip: hot; ring: cold, sleeve: ground)	
Load impedance:	More than 600 Ω	
Level:	+4 dBu (Max.: +24 dBu)	
• SEND output	Monaural x 2	Unbalanced 1/4" TS terminal
Load impedance:	10 kΩ	
Level:	-10 dBV (Max.: +10 dBV)	
• Headphones output	Stereo	
Load impedance:	40 Ω	
Level:	150 mW	
• Digital coaxial output	Stereo RCA terminal, IEC958 Consumer	
	(Fs: 44.1 kHz, 48 kHz, 96 kHz)	
• USB audio output	Stereo x 4 (monaural x 8) 24 bit, 44.1 kHz, 48 kHz, 96 kHz USB B	
□ GENERAL		
USB MIDI I/O:	IN: 1ch, OUT: 1ch MIDI1.0, MIDI Clock	USB B
MIDI OUT:	OUT: 1ch MIDI1.0, MIDI Clock	5pin DIN
Channel level meters:	PPM 16-point LEDs from -40 to +10 dB, peak display	
Cue master level meters:	PPM 16-point LEDs from -40 to +10 dB, peak display	
Channel Fader:	60 mm Slim Type fader	
Crossfader:	45 mm FLEX Fader (Fader Torque Adjustable)	
Dimensions:	320(W) x 357(D) x 91(H) mm (12"5/8 (W) x 14"1/16 (D) x 3"5/8 (H))	
Weight:	6.2 Kg (13.7 lbs)	
Supply voltage:	AC 120 V, 60 Hz (U.S.A. and Canada models) AC 230 V, 50 Hz (European models)	
Power consumption:	34 W	
Operational temperature:	+5°C to +35°C (+41 F to +95 F)	
Operational humidity:	25% to 85%	
Storage temperature:	-20°C to +60°C (-4 F to +140 F)	

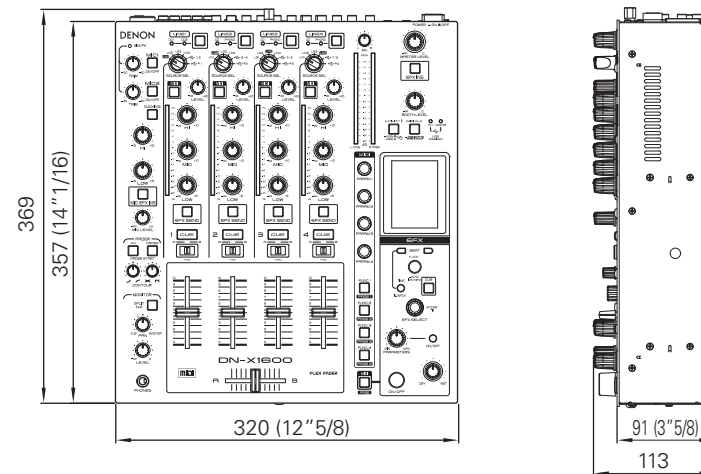

unit : mm (ins.)

* For purposes of improvement, specifications and design are subject to change without notice.

Block Diagram

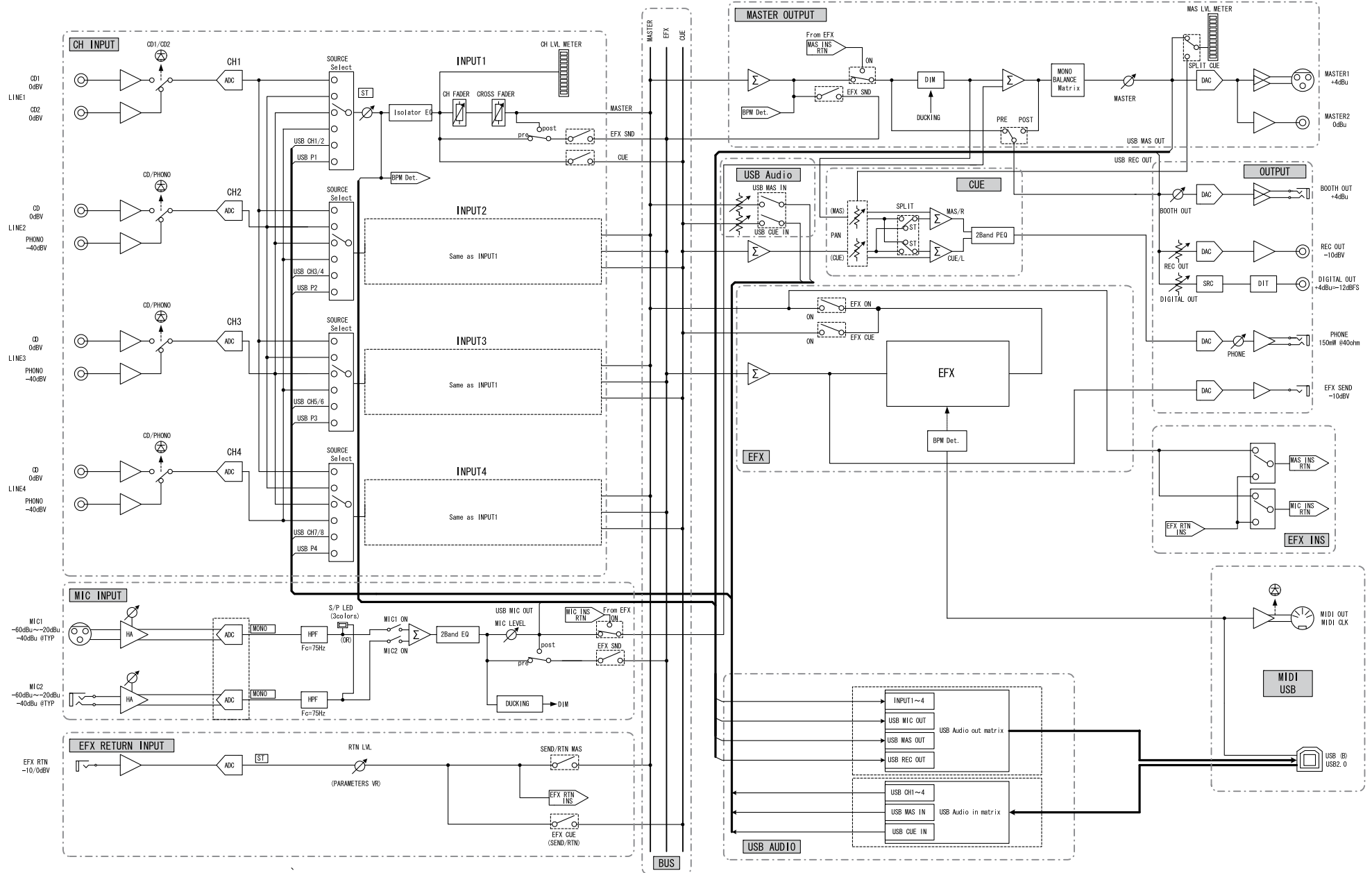

Troubleshooting

- ❑ **Are all the parts connected properly?**
- ❑ **Have the operations been performed properly according to the owner's manual?**
- ❑ **Are the amplifier and speakers operating properly?**

If the unit fails to operate properly, check out the remedial action in the table below according to the symptoms present, and see if this fixes the problem. Types of trouble which are not described in the table below may indicate trouble in the unit itself so consult with your dealer from whom you purchased the unit. If your dealer does not know what action to take, contact one of our customer service centers or your nearest repair service center. Service centers are listed at <http://www.d-mpro.com>.

Symptom	Cause	Remedy	Page
The power fails to turn on.	<ul style="list-style-type: none"> • The AC power cable is not connected to the power outlet. 	<ul style="list-style-type: none"> • Connect the AC power cable to the power outlet. 	9
No sound is heard or the volume level is low.	<ul style="list-style-type: none"> • One or more of the connecting cables have not been connected properly. • The SOURCE SEL LN1/LN2/LN3/LN4/USB/P1-4 controls have not been set to the correct positions. 	<ul style="list-style-type: none"> • Check the cable connections. 	7
		<ul style="list-style-type: none"> • Set the SOURCE SEL LN1/LN2/LN3/LN4/USB/P1-4 controls to the position which corresponds to the component now playing. • Set the DUCKING ON/OFF button to the OFF position. 	10 11
The sound is distorted.	<ul style="list-style-type: none"> • The master output audio level is too high. • The input level is too high. 	<ul style="list-style-type: none"> • Adjust the MASTER LEVEL control. 	10
		<ul style="list-style-type: none"> • Adjust the channel input LEVEL controls. 	10
The fader start of the CD player cannot be initiated.	<ul style="list-style-type: none"> • One or more of the connecting cables have not been connected properly. • The CH FADER START switch and CROSSFADER START switch have not been set to the ON position. 	<ul style="list-style-type: none"> • Connect the CD player to the unit using the stereo mini jacks. • Set the CH FADER START switch and CROSSFADER START switch to the ON position. 	7 14, 15

- ❑ **DN-X1600 does not operate normally or no sound is produced**
 - **Are the USB cable, audio cables, etc., properly connected?**
 - **Is the volume setting for the source, audio device, application, OS, etc., properly raised?**
 - **Is the appropriate device selected on your audio application?**
 - **Is the sampling frequency setting appropriate?**
 - ➔ Either make the same settings in the DN-X1600's preset mode and on the application.
 - **Are there WAV files with different sampling frequencies and bit rates?**
 - ➔ Depending on your audio application, it may not be possible to play WAV files with different sampling frequencies and bit rates simultaneously.
 - **Is other USB equipment in use?**
 - ➔ If other USB devices are connected, try connecting only DN-X1600 to check for problems.
 - **Is the USB connector of the connected computer compatible with USB 2.0 (Hi-Speed)?**
 - ➔ Use a USB 2.0-compatible cable.
- ❑ **Sound is broken or distorted**
 - **Are other applications or device drivers operating?**
 - ➔ Close any unneeded applications.
 - **Are you playing multiple WAV files?**
 - ➔ When playing multiple WAV files simultaneously, depending on the capacity of your computer, the sound may be broken.

D&M Holdings Inc.

Free Manuals Download Website

<http://myh66.com>

<http://usermanuals.us>

<http://www.somanuals.com>

<http://www.4manuals.cc>

<http://www.manual-lib.com>

<http://www.404manual.com>

<http://www.luxmanual.com>

<http://aubethermostatmanual.com>

Golf course search by state

<http://golfingnear.com>

Email search by domain

<http://emailbydomain.com>

Auto manuals search

<http://auto.somanuals.com>

TV manuals search

<http://tv.somanuals.com>