

DENSO

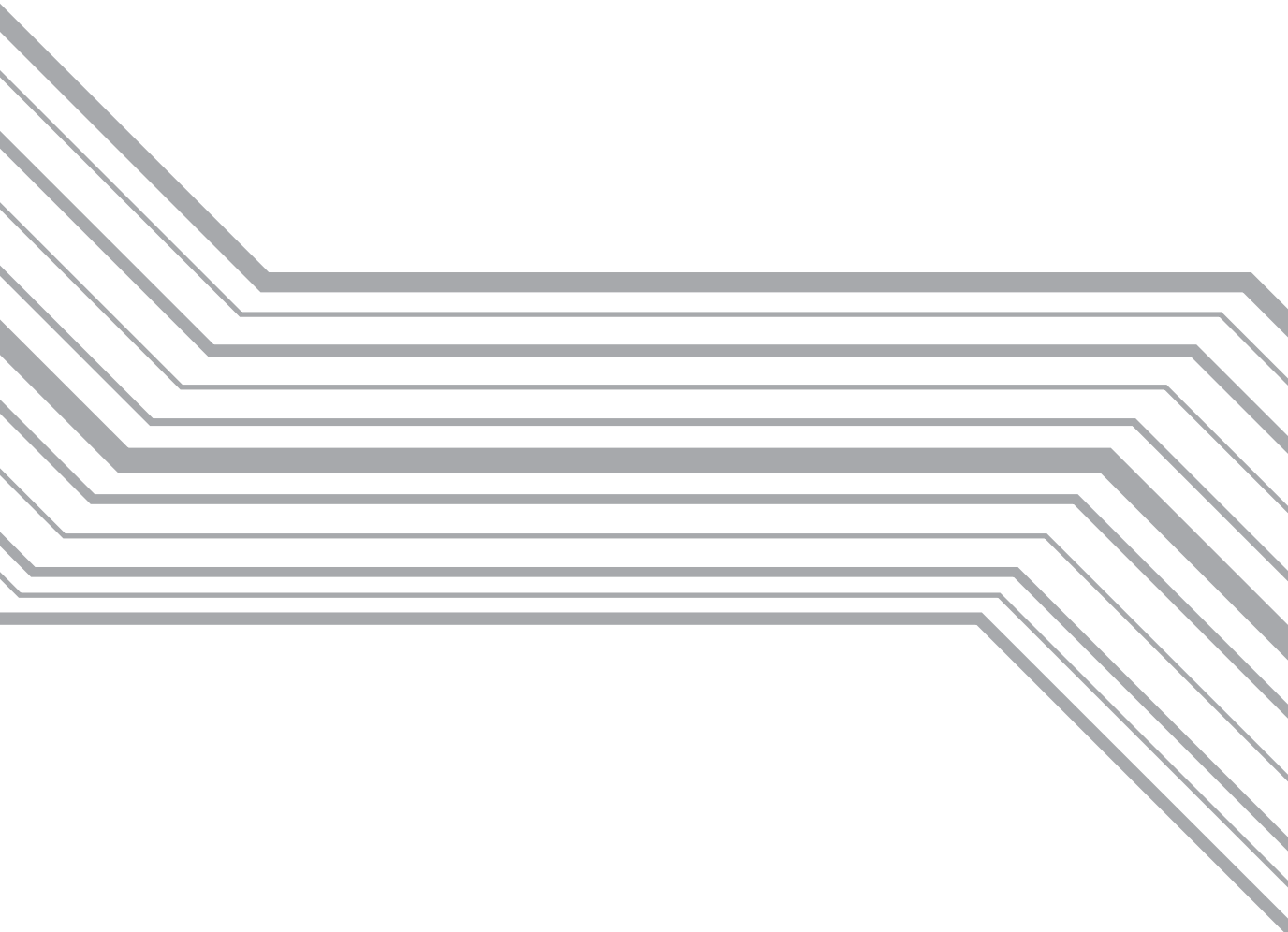

Communication Unit
CU-7011

User's Manual

Copyright © DENSO WAVE INCORPORATED, 2001

All rights reserved. No part of this publication may be reproduced in any form or by any means without permission in writing from the publisher.

Specifications are subject to change without prior notice.

All products and company names mentioned in this manual are trademarks or registered trademarks of their respective holders.

Preface

Please READ through these operating instructions carefully. It will enable you to operate your CU-7011 correctly.

After you have finished reading the instructions, keep this manual handy for speedy reference.

How this book is organized

This manual is made up of 10 chapters and appendix.

Chapter 1	Ethernet System Configuration
Chapter 2	Functions of the CU-7011
Chapter 3	Components and Functions
Chapter 4	CU Status Indication by LED Indicators
Chapter 5	Applying Power to the CU-7011
Chapter 6	Connecting to Ethernet
Chapter 7	Charging the Rechargeable Battery Cartridge
Chapter 8	Displaying the CU System Information on the BHT
Chapter 9	Updating the CU System Program via the BHT
Chapter 10	MAC Address
Appendix	Specifications

■ Related Publications

BHT-7000 User's Manual

BHT-7000 User's Manual "LAN Support Version"

BHT-100 Series User's Manuals

BHT-100 Series User's Manual "LAN Support Version"

BHT-BASIC Programmer's Manual

BHT-BASIC Programmer's Manual (BHT-100 series)

SAFETY PRECAUTIONS

Be sure to observe all these safety precautions.

Strict observance of these warning and caution indications are a **MUST** for preventing accidents which could result in bodily injury and substantial property damage. Make sure you fully understand all definitions of these terms and related symbols given below, before you proceed on to the text itself.



WARNING

Alerts you to those conditions which could cause serious bodily injury or death if the instructions are not followed correctly.



CAUTION

Alerts you to those conditions which could cause minor bodily injury or substantial property damage if the instructions are not followed correctly.

Meaning of Symbols



A triangle (\triangle) with a picture inside alerts you to a warning of danger. Here you see the warning for electrical shock.



A diagonal line through a circle (\otimes) alerts you to something you should not do; it may or may not have a picture inside. Here you see a screwdriver inside the circle, meaning that you should not disassemble.



A black circle (\bullet) with a picture inside alerts you to something you **MUST** do. This example shows that you **MUST** unplug the power cord.

! WARNING

Handling the battery cartridge

- Never disassemble or heat the battery cartridge, nor put it into fire or water; doing so could cause battery-rupture or leakage of battery fluid, resulting in a fire or bodily injury.



- Do not carry or store the battery cartridge together with metallic ball-point pens, necklaces, coins, hairpins, etc. Doing so could short-circuit the terminal pins, causing the batteries to rupture or the battery fluid to leak, resulting in a fire or bodily injury.



WARNING

- Avoid dropping the battery cartridge or letting it undergo any shock or impact.

Doing so could cause the batteries to break, generate heat, rupture or burn.

- Only use the dedicated charger (CU-7011, CU-7001, C-700 or C-750) for charging the battery cartridge.

Using a different type of charger could cause battery-rupture or leakage of battery fluid and result in a fire, bodily injury, or serious damage to property.

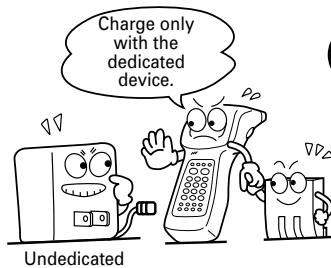

- Never charge the battery cartridge where any inflammable gases may be emitted; doing so could cause fire.

Handling the CU

- If smoke, abnormal odors or noises come from the CU, immediately unplug the AC adapter from the wall socket and contact your nearest dealer.

Failure to do so could cause fire or electrical shock.

- If foreign material or water gets into the CU, immediately unplug the AC adapter from the wall socket and contact your nearest dealer.

Failure to do so could cause fire or electrical shock.

- If you drop the CU so as to damage its housing, immediately unplug the AC adapter from the wall socket and contact your nearest dealer.

Failure to do so could cause fire or electrical shock.

- Never use the CU for charging anything other than the specified battery cartridges.

Doing so could cause heat, battery-rupture, or fire.

- Never bring any metals into contact with the output terminals.

Doing so could produce a large current through the CU, resulting in heat or fire, as well as damage to the CU.

- Use the dedicated AC adapter only. Failure to do so could result in fire.

- Never use the CU on the line voltage other than the specified level. Doing so could cause the CU to break or burn.

- If the power cord of the AC adapter is damaged (e.g., exposed or broken lead wires), stop using it and contact your nearest dealer.

Failure to do so could result in a fire or electrical shock.

CAUTION

Handling the battery cartridge

- Never charge a wet or damp battery cartridge.
Doing so could cause the batteries to break, generate heat, rupture, or burn.



Handling the CU

- Never put the CU in places where there are excessively high temperatures, such as inside closed-up automobiles, or in places exposed to direct sunlight.
Doing so could affect the housing or parts, resulting in a fire.

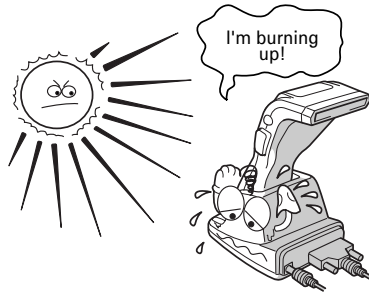

- Avoid using the CU in extremely humid or dusty areas, or where there are drastic temperature changes.
Moisture or dust will get into the CU, resulting in malfunction, fire or electrical shock.



- Never disassemble or modify the CU; doing so could result in an accident such as fire or malfunction.



- If you are not using the CU for a long time, be sure to unplug the AC adapter from the wall socket for safety.



Failure to do so could result in a fire.

- When caring for the CU, unplug the AC adapter from the wall socket for safety.



Failure to do so could result in an electrical shock.

- Never cover or wrap up the CU or AC adapter in a cloth or blanket.
Doing so could cause the unit to heat up inside, deforming its housing, resulting in a fire.



Always use the CU and AC adapter in a well-ventilated area.

- Do not place the CU anywhere where it may be subjected to oily smoke or steam, e.g., near a cooking range or humidifier.



Doing so could result in a fire or electrical shock.

- Keep the power cord away from any heating equipment.
Failure to do so could melt the sheathing, resulting in a fire or electrical shock.



- Do not insert or drop foreign materials such as metals or anything inflammable through the openings or vents into the CU.



Doing so could result in a fire or electrical shock.

■ Proper Care of the CU

Before starting cleaning, unplug the AC adapter from the wall socket for safety.

Clean the housing and the charge terminals of the CU and the battery cartridge terminals with a dry, soft cloth.

- Never use benzene, alcohol, or other organic solvents. The housing may be marred or the paint may come off.
- If the CU becomes smudged, moisten a soft cloth with neutral detergent and wring it out thoroughly. Wipe the CU with the cloth and then go over it again with a dry cloth.



■ Limited Warranty on Software Products

In no event will DENSO WAVE be liable for direct, indirect, special, incidental, or consequential damages (including imaginary profits or damages resulting from interruption of operation or loss of business information) resulting from any defect in the software or its documentation or resulting from inability to apply the software or its documentation.

- DENSO WAVE INCORPORATED does not assume any product liability arising out of, or in connection with, the application or use of any product, circuit, or application described herein.

■ Intellectual Property Precaution

DENSO WAVE INCORPORATED ("DENSO WAVE") takes reasonable precautions to ensure its products do not infringe upon any patent or other intellectual property rights of other(s), but DENSO WAVE cannot be responsible for any patent or other intellectual property right infringement(s) or violation(s) which arise from (i) the use of DENSO WAVE's product(s) in connection or in combination with other component(s), product(s), data processing system(s) or equipment or software not supplied from DENSO WAVE; (ii) the use of DENSO WAVE's products in a manner for which the same were not intended nor designed; or (iii) any modification of DENSO WAVE's products by other(s) than DENSO WAVE.

Content Overviews

Preface	i
How this book is organized	ii
SAFETY PRECAUTIONS	iv
Chapter 1 Ethernet System Configuration	1
Chapter 2 Functions of the CU-7011	1
Chapter 3 Components and Functions	2
Chapter 4 CU Status Indication by LED Indicators	3
Chapter 5 Applying Power to the CU-7011	4
Chapter 6 Connecting to Ethernet.....	5
6.1 Setting the Transmission Speed of the CU-7011	5
6.2 Interface Cable Connection	6
6.3 Communication with the Host Computer	7
Chapter 7 Charging the Rechargeable Battery Cartridge.....	8
Chapter 8 Displaying the CU System Information on the BHT	10
Chapter 9 Updating the CU System Program via the BHT	10
Chapter 10 MAC Address	11
Appendix Specifications	12

Chapter 1 Ethernet System Configuration

Connecting CU-7011 units to an Ethernet enables you to use BHTs as a LAN client.

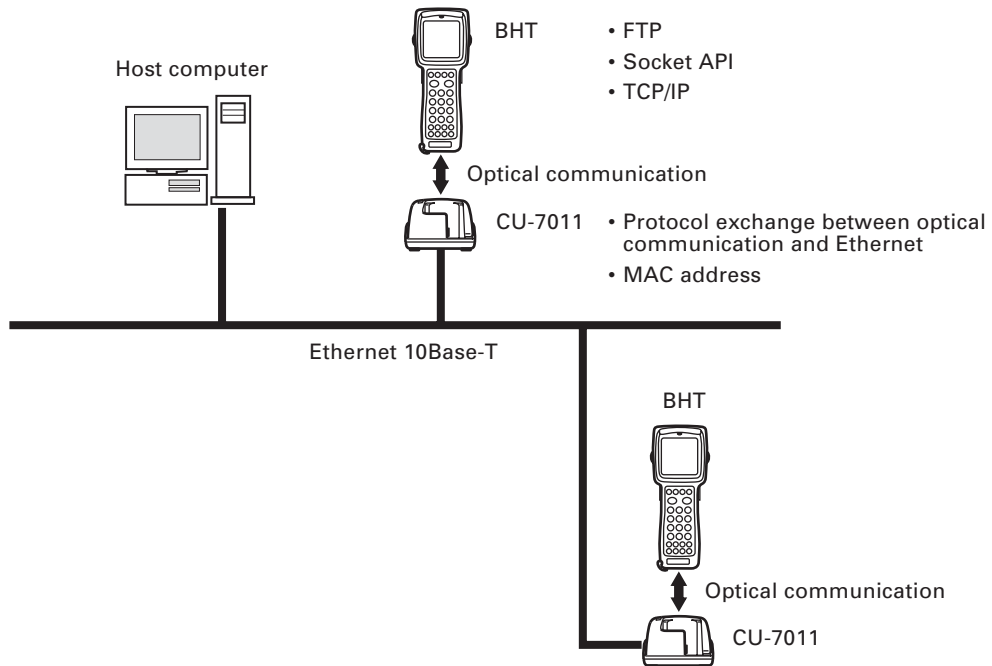

For details about FTP and Socket API, refer to the BHT-BASIC Programmer's Manual. For procedures about setting the TCP/IP and FTP on the BHT, refer to the BHT User's Manual.

Chapter 2 Functions of the CU-7011

The CU-7011 has the following two functions:

(1) Data exchange

The CU-7011 exchanges data and programs between the BHT and host computer. It interfaces with the BHT via the optical interface and with the host computer via an Ethernet (10Base-T).

(2) Battery cartridge charging

The CU-7011 charges the rechargeable battery cartridge loaded in the BHT.

Chapter 3 Components and Functions

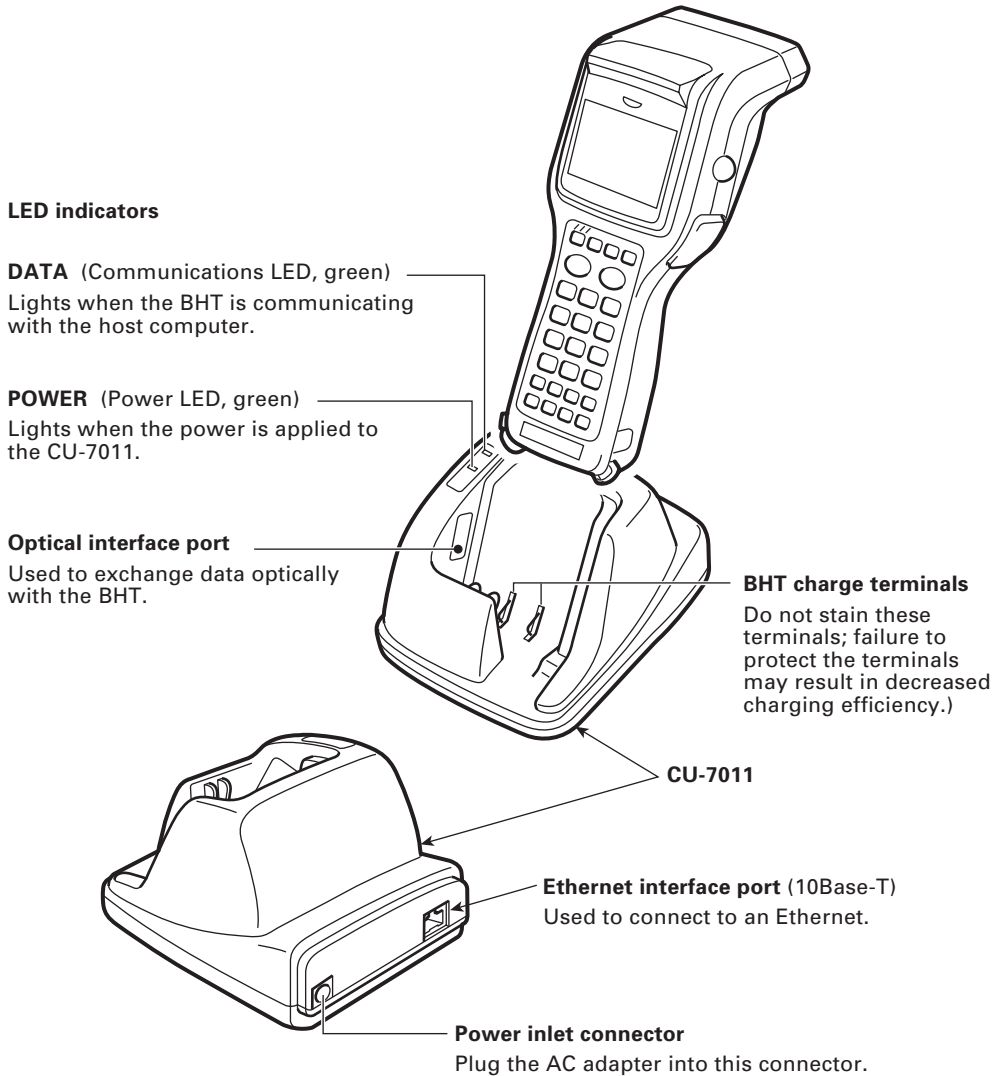

NOTE

Place the CU on a flat, horizontal plane. Do not install the CU on a wall or in a vertical position.

Chapter 4 CU Status Indication by LED Indicators

According to the ON/OFF states of the POWER and DATA LED indicators, you may check the machine status of the CU-7011 as listed below.

POWER	DATA	Machine status
OFF	OFF	Power off
ON	OFF	Power on
ON	ON	Communicating with the host
Flashing slowly* ¹	ON	Updating the CU system program
Flashing slowly	Flashing* ²	Waiting for retry after occurrence of a CU system program updating error
Flashing slowly	Flashing slowly	System program failure Solution: Contact your nearest dealer.
Flashing quickly* ³	Flashing quickly	System program error Solution: Restart the CU-7011. If this error occurs frequently, contact your nearest dealer.

*¹ At one-second intervals

*² At 100-ms intervals







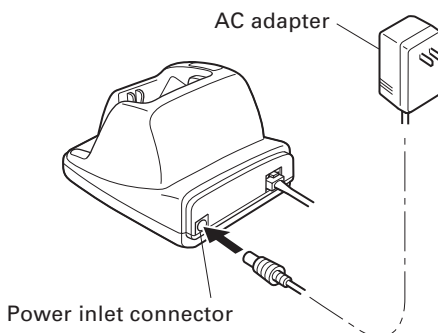

*³ At 50-ms intervals





Chapter 5 Applying Power to the CU-7011

Apply power to the CU-7011 via the dedicated AC adapter.

Connect the outlet plug of the AC adapter to the power inlet connector of the CU-7011, then plug the other end of the AC adapter into a wall socket.



<p>⚠ WARNING</p>	<ul style="list-style-type: none"> • If smoke, abnormal odors or noises come from the CU, immediately unplug the AC adapter from the wall socket and contact your nearest dealer. Failure to do so could cause fire or electrical shock.   • If foreign material or water gets into the CU, immediately unplug the AC adapter from the wall socket and contact your nearest dealer. Failure to do so could cause fire or electrical shock.   • If you drop the CU so as to damage its housing, immediately unplug the AC adapter from the wall socket and contact your nearest dealer. Failure to do so could cause fire or electrical shock.   • Use the dedicated AC adapter only. Failure to do so could result in a fire.  • Never use the CU on the line voltage other than the specified level. Doing so could cause the CU to break or burn.  • If the power cord of the AC adapter is damaged (e.g., exposed or broken lead wires), stop using it and contact your nearest dealer. Failure to do so could result in a fire or electrical shock. 
-------------------------	--

<p>⚠ CAUTION</p>	<ul style="list-style-type: none"> • If you are not using the CU for a long time, be sure to unplug the AC adapter from the wall socket for safety. Failure to do so could result in a fire.  • When caring for the CU, unplug the AC adapter from the wall socket for safety. Failure to do so could result in an electrical shock.  • Never cover or wrap up the CU or AC adapter in a cloth or blanket. Doing so could cause the unit to heat up inside, deforming its housing, resulting in a fire. Always use the CU and AC adapter in a well-ventilated area.  • Keep the power cord away from any heating equipment. Failure to do so could melt the sheathing, resulting in a fire or electrical shock. 
-------------------------	--

Chapter 6 Connecting to Ethernet

6.1 Setting the Transmission Speed of the CU-7011

Set the transmission speed of the CU-7011 to the same value as that of the BHT, by using the DIP switch provided on the bottom of the CU-7011.

- (1) Unplug the AC adapter from the wall socket.
- (2) Turn the CU-7011 upside down.
- (3) Remove the protection sheet of the DIP switch from the CU-7011.
- (4) Set the selectors of the DIP switch as shown below.

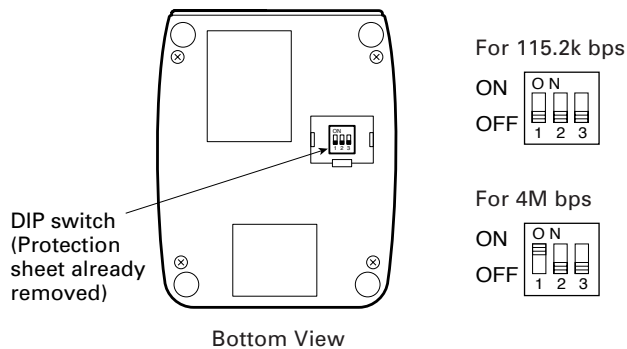

NOTE

- Do not set the DIP switch to any configurations other than either of the two shown above.
- When the power is turned on, the DIP switch settings will be read in.

- (5) Reinstall the protection sheet.
- (6) Plug the AC adapter into a wall socket.

6.2 Interface Cable Connection

Connect the modular plug* of the Ethernet cable to the Ethernet port of the CU-7011.
(*10Base-T 8-pin modular, RJ45, ITA/ETA category 3 or higher)

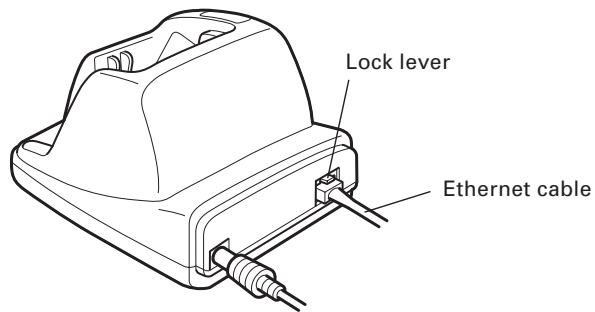

NOTE

- When connecting the modular plug, insert it until it snaps into place. To disconnect it, press the lock lever and pull it out.
- Do not force the modular plug in or out. Doing so will result in a CU-7011 failure.

6.3 Communication with the Host Computer

This section describes how to start communication with the host computer according to the FTP in System Mode.

- (1) Turn on the host computer.
- (2) On the host computer, start the FTP server program.
- (3) Turn on the BHT and run System Mode. Set the TCP/IP parameters (incl. IP address and subnet mask)) and FTP parameters (incl. server IP and user ID).
- (4) Put the BHT on the CU-7011.

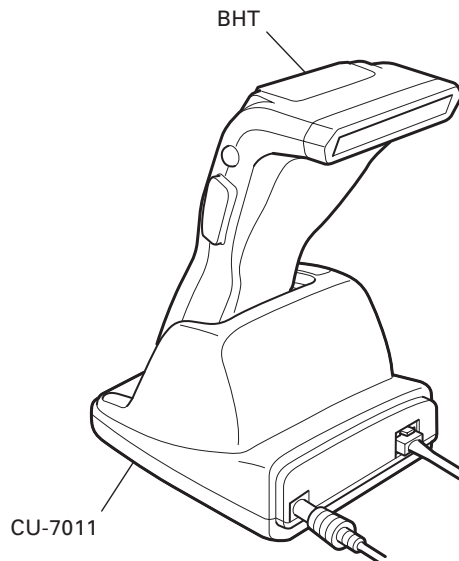

NOTE

Take care not to put the hand strap or get any foreign material between the CU and BHT. The BHT may fail to communicate with the host.

- (5) To upload a file from the BHT according to FTP, choose "FTP" on the SYSTEM MENU in System Mode and then choose "UPLOAD."

To download a file from the host computer, choose "FTP" and "DOWNLOAD."

For details about the operating procedure, refer to the BHT User's Manual "LAN Support Version."

The DATA LED will come on upon start of communication. After completion of communication, the LED will go off.

Chapter 7 Charging the Rechargeable Battery Cartridge

You may charge the battery cartridge loaded in the BHT.

NOTE

Service Life of Rechargeable Battery Cartridge:

Lithium-ion batteries used in the battery cartridge will gradually deteriorate during the repeated cycles of charging and discharging due to its properties, even under normal use. When the battery run time becomes shortened due to its deterioration even if it has been charged for the specified hours, replace the battery cartridge with a new one. Generally, it is necessary to replace the battery cartridge after it has undergone approx. 300 cycles of charging and discharging operation.

- (1) Plug the AC adapter of the CU-7011 into a wall socket.

The POWER LED on the CU-7011 comes on.

- (2) Place the BHT loaded with a battery cartridge onto the CU-7011.

NOTE

Take care not to put the hand strap or get any foreign material between the CU and BHT. The CU may fail to charge the battery cartridge loaded in the BHT.

The BHT turns on the indicator LED in red and starts charging. The charging time is approx. 6 hours.

Upon completion of charging, the indicator LED turns green.

- (3) Take the BHT off the CU-7011.

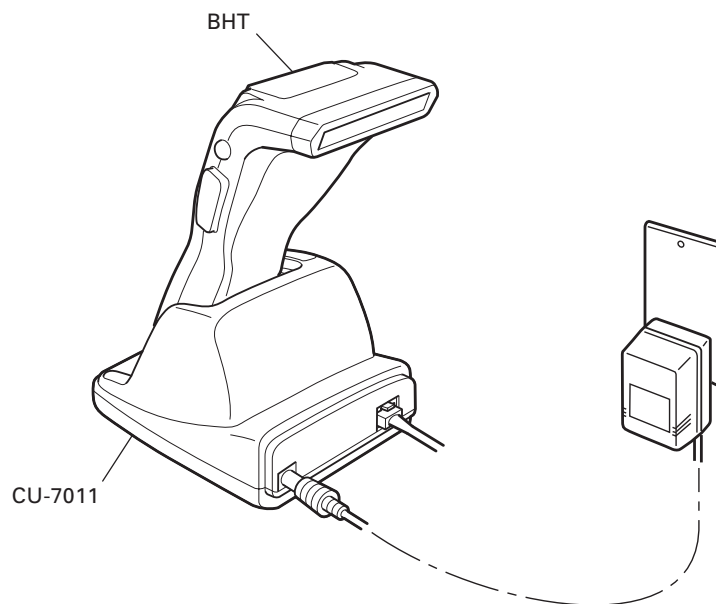

■ Charging Operation and BHT's Indicator LED

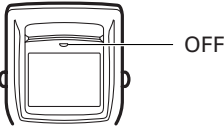
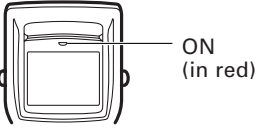
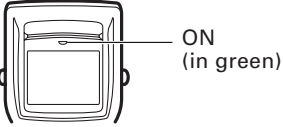
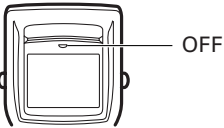
Operator's Action	CU-7011 Status	Indicator LED on the BHT
	On standby	 OFF
	↓	
Place the BHT on the CU-7011.	Normal charging	 ON (in red)
	↓	
After approx. 6 hours	Charging completed	 ON (in green)
	↓	
Remove the BHT.	On standby	 OFF

TIP

The charging time is approx. 6 hours if the "Charge the battery!" message is displayed on the BHT. The battery cartridge not discharged so much will be fully recharged in shorter time.

Chapter 8 Displaying the CU System Information on the BHT

You may display the CU-7011 system information on the BHT's LCD.

Set the BHT on the CU-7011 and operate the BHT to display the SYSTEM INFORMATION screen on the LCD. From that screen, you may call up the system program version and MAC address.

For details about the displaying procedure of the CU system information, refer to the BHT User's Manual, "LAN Support Version."

Chapter 9 Updating the CU System Program via the BHT

You may update the CU-7011 system program by using the BHT.

(1) **Downloading the CU-7011 system program file**

Download the CU-7011 system program file to the BHT from the host computer.

(2) **Updating the current CU-7011 system program**

Set the BHT on the CU-7011 whose system program should be updated. Operate the BHT to display the CU-F/W MODIFY screen where you may update the system program.

During updating, the POWER LED on the CU-7011 will flash. (Refer to Chapter 4, "CU Status Indication by LED Indicators.")

For details about the updating procedure, refer to the BHT User's Manual "LAN Support Version."

Chapter 10 MAC Address

The MAC address of the CU-7011 is printed on the nameplate.

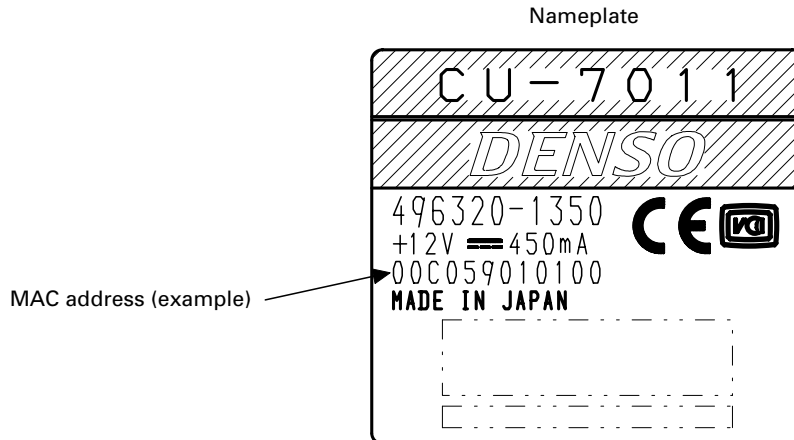

Appendix Specifications

[1] Product Specifications

Power Source

-Europe	230 VAC, 16 VA
-U.S.	120 VAC, 13 VA
-Australia	10 to 18 VDC, 450 mA (on 12 VDC)

Power Consumption 8 VA

Dimensions 112 x 142 x 84 mm
(W) x (L) x (H) (4.41 x 5.59 x 3.31 inches)

Weight Approx. 220 g (Approx. 7.76 oz.)

Operating Ambient Temperature 0°C to 40°C (32°F to 104°F)

Operating Humidity 20% to 80% (with no dew condensation)

[2] Charging Requirements

Charge current: Approx. 400 mA

Charge time: Approx. 6 hours

[3] Interface

Ethernet interface IEEE802.3, 10Base-T

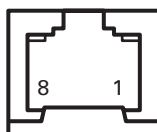

Pin No.	Signal	Functions
1	TD+	Send data
2	TD-	Send data
3	RD+	Receive data
4	N.C.	} No connection
5	N.C.	
6	RD-	Receive data
7	N.C.	} No connection
8	N.C.	

Communication Unit CU-7011

User's Manual

First Edition, October 2001

DENSO WAVE INCORPORATED

The purpose of this manual is to provide accurate information in the handling and operating of the CU-7011. Please feel free to send your comments regarding any errors or omissions you may have found, or any suggestions you may have for generally improving the manual.

In no event will DENSO WAVE be liable for any direct or indirect damages resulting from the application of the information in this manual.

Free Manuals Download Website

<http://myh66.com>

<http://usermanuals.us>

<http://www.somanuals.com>

<http://www.4manuals.cc>

<http://www.manual-lib.com>

<http://www.404manual.com>

<http://www.luxmanual.com>

<http://aubethermostatmanual.com>

Golf course search by state

<http://golfingnear.com>

Email search by domain

<http://emailbydomain.com>

Auto manuals search

<http://auto.somanuals.com>

TV manuals search

<http://tv.somanuals.com>