

DENSO

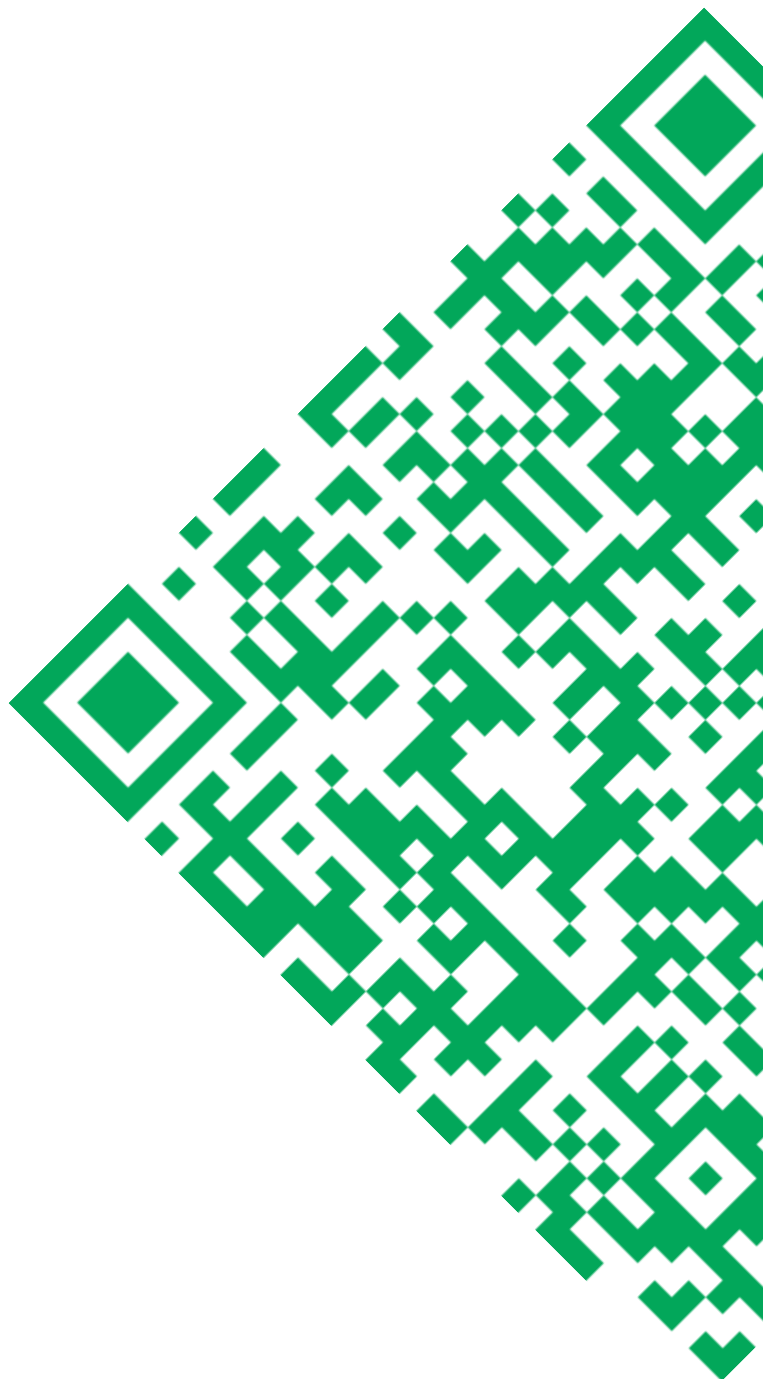

BHT-100Q/100B

User's Manual

Copyright © DENSO, 2001

All rights reserved. No part of this publication may be reproduced in any form or by any means without permission in writing from the publisher.

Specifications are subject to change without prior notice.

All products and company names mentioned in this manual are trademarks or registered trademarks of their respective holders.

Preface

Please READ through these operating instructions carefully. It will enable you to operate your BHT-100Q/100B correctly.

After you have finished reading the instructions, keep this manual handy for speedy reference.

How this book is organized

This manual is made up of five chapters and appendices.

Chapter 1. Quick Guide

Describes the basic operating method of the BHT and the related notes.

Chapter 2. Getting Started the BHT and System Mode

Summarizes the BHT system configuration and describes the operation including preparation and System Mode (which is required for the efficient use of application programs).

Chapter 3. Communications Operations of BHT

Describes the communications operations of the BHT—the IR communication, RS-232C interface specifications, basic communications specifications, and the communications protocols—for data transfer with the host computer or other devices.

Chapter 4. Error Messages

Lists the error messages which will appear on the LCD if some error occurs in the BHT.

Chapter 5. Handling the CU-7000 (Option)

Describes the handling procedure of the CU-7000, the interfacing with the host computer, and the charging of the rechargeable battery cartridge.

Appendix A: Specifications

Appendix B: Communications Protocol Details

Appendix C: A Typical Basic Operation

Appendix D: Quality Assurance Standards

■ Technical Terms Used in This Manual

Source Program and Object Program (User Program)

Generally, a source program is translated into an object program by a compiler. This manual calls an object program a user program.

BHT-BASIC

This manual expresses BHT-BASIC3.0 and BHT-BASIC3.5 as BHT-BASIC.

■ Related Publications

BHT-BASIC Programmer's Manual (BHT-100 series)

Transfer Utility Guide

Ir-Transfer Utility C Guide

Ir-Transfer Utility E Guide

■ Screen Indication

The lettering in the screens in this manual is a little different from that in the actual screens. File names used are only for description purpose, so they will not appear if you have not set files having those names.

SAFETY PRECAUTIONS

Be sure to observe all these safety precautions.

- Please READ through this manual carefully. It will enable you to use the BHT and CU correctly.
- Always keep this manual nearby for speedy reference.

Strict observance of these warning and caution indications are a MUST for preventing accidents which could result in bodily injury and substantial property damage. Make sure you fully understand all definitions of these terms and related symbols given below, before you proceed to the text itself.



WARNING

Alerts you to those conditions which could cause serious bodily injury or death if the instructions are not followed correctly.



CAUTION

Alerts you to those conditions which could cause minor bodily injury or substantial property damage if the instructions are not followed correctly.

Meaning of Symbols



A triangle (△) with a picture inside alerts you to a warning of danger. Here you see the warning for electrical shock.



A diagonal line through a circle (⊘) alerts you to something you should not do; it may or may not have a picture inside. Here you see a screwdriver inside the circle, meaning that you should not disassemble.



A black circle (●) with a picture inside alerts you to something you MUST do. This example shows that you MUST unplug the power cord.

WARNING

Handling the battery cartridge

- Never disassemble or heat the battery cartridge, nor put it into fire or water; doing so could cause battery-rupture or leakage of battery fluid, resulting in a fire or bodily injury.



- Do not carry or store the battery cartridge together with metallic ball-point pens, necklaces, coins, hairpins, etc.

Doing so could short-circuit the terminal pins, causing the batteries to rupture or the battery fluid to leak, resulting in a fire or bodily injury.

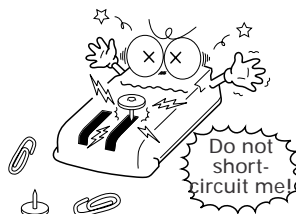

- Avoid dropping the battery cartridge or letting it undergo any shock or impact.

Doing so could cause the batteries to break, generate heat, rupture or burn.



- Only use the dedicated charger (CU-7001, C-700 or C-750) for charging the rechargeable battery cartridge.

Using a different type of charger could cause battery-rupture or leakage of battery fluid and result in a fire, bodily injury, or serious damage to property.

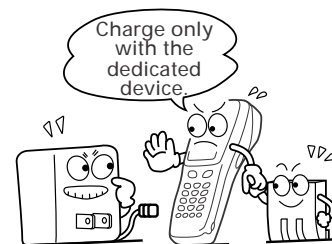

Undedicated

- Never charge the rechargeable battery cartridge where any inflammable gases may be emitted; doing so could cause fire.



Handling the BHT

- The BHT-100B uses a laser light for indicating the scanning range. The intensity of the laser light might be too low to inflict bodily injury. However, do not look into the laser beam.

The BHT-100B complies with Laser Safety Standard, Class II of 21 CFR Chapter 1, Subchapter J.

The BHT-100B does not mount beam attenuator and laser radiation emission indicator required by this standard. Instead, the software-controlled trigger switches (see Section 2.2 "Components and Functions") function as them because the laser light is not enabled without the trigger switches pressed.

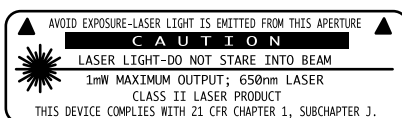

WARNING

- Do not look into the light source through the reading window or point the light source towards the eyes.



The light emitted through the reading window is harmful to the eyes.

- Do not poke at the eyes with the stylus that comes with the BHT.

Handling the CU

- If smoke, abnormal odors or noises come from the CU, immediately unplug the AC adapter from the wall socket and contact your nearest dealer.



Failure to do so could cause fire or electrical shock.



- If foreign material or water gets into the CU, immediately unplug the AC adapter from the wall socket and contact your nearest dealer.



Failure to do so could cause fire or electrical shock.



- If you drop the CU so as to damage its housing, immediately unplug the AC adapter from the wall socket and contact your nearest dealer.



Failure to do so could cause fire or electrical shock.



- Never use the CU for charging anything other than the specified rechargeable battery cartridges.



Doing so could cause heat, battery-rupture, or fire.

- Never bring any metals into contact with the output terminals.



Doing so could produce a large current through the CU, resulting in heat or fire, as well as damage to the CU.

- Use the dedicated AC adapter only. Failure to do so could result in fire.



- Never use the CU on the line voltage other than the specified level. Doing so could cause the CU to break or burn.



- If the power cord of the AC adapter is damaged (e.g., exposed or broken lead wires), stop using it and contact your nearest dealer.



Failure to do so could result in a fire or electrical shock.

CAUTION

Basic handling tips

- Never put the BHT in places where there are excessively high temperatures, such as inside closed-up automobiles, or in places exposed to direct sunlight.

Doing so could affect the housing or parts, resulting in a fire.

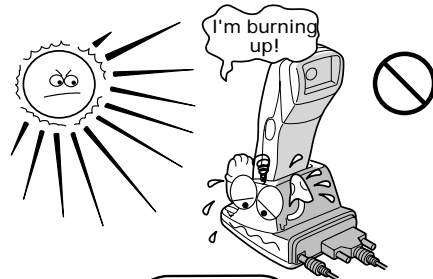

- Avoid using the BHT in extremely humid or dusty areas, or where there are drastic temperature changes.

Moisture or dust will get into the BHT, resulting in malfunction, fire or electrical shock.

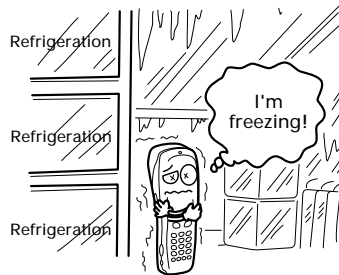
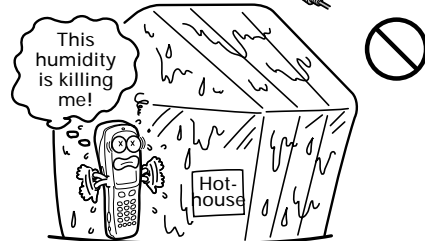

- Never disassemble or modify the BHT; doing so could result in an accident such as break or fire.



Never disassemble

Handling the rechargeable battery cartridge

- Never charge a wet or damp rechargeable battery cartridge.

Doing so could cause the batteries to break, generate heat, rupture, or burn.

Handling the BHT

- If smoke, abnormal odors or noises come from the BHT, immediately turn off the power, pull out the battery cartridge, and contact your nearest dealer.

Failure to do so could cause smoke or fire.



- If foreign material or water gets into the BHT, immediately turn off the power, pull out the battery cartridge, and contact your nearest dealer.

Failure to do so could cause smoke or fire.

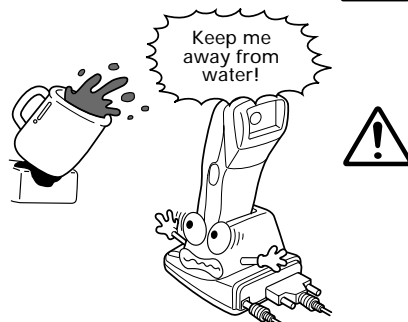

CAUTION

- If you drop the BHT so as to damage its housing, immediately turn off the power, pull out the rechargeable battery cartridge or dry battery cartridge, and contact your nearest dealer.

Failure to do so could cause smoke or fire.



- For those machines using the dry battery cartridge, do not mistake the plus and minus marks when loading dry cells into the cartridge.

Failure to do so could cause battery-rupture or leakage of battery fluid, resulting in bodily injury, fire, or property damage.



- For those machines using the dry battery cartridge, do not use anything other than the specified type of batteries, nor use new and old batteries together.

Doing so could cause battery-rupture or leakage of battery fluid, resulting in bodily injury, fire, or property damage.



- Do not use batteries or power sources other than the specified ones; doing so could generate heat or cause malfunction.



- In environments where static electricity can build into significant charges (e.g., if you wipe off the resin plate with a dry cloth), do not operate the BHT. Doing so will result in malfunction or machine failure.



- Touch the LCD only with the stylus that comes with the BHT. Using the tip of a pen or any pointed object will result in a damaged or broken LCD.



Handling the CU

- If you will not be using the CU for a long time, be sure to unplug the AC adapter from the wall socket for safety.

Failure to do so could result in a fire.







- When caring for the CU, unplug the AC adapter from the wall socket for safety.

Failure to do so could result in an electrical shock.



 **CAUTION**

- Never cover or wrap up the CU or AC adapter in a cloth or blanket. 
Doing so could cause the unit to heat up inside, deforming its housing, resulting in a fire.
Always use the CU and AC adapter in a well-ventilated area.
- Do not place the CU anywhere where it may be subjected to oily smoke or steam, e.g., near a cooking range or humidifier. 
Doing so could result in a fire or electrical shock.
- Keep the power cord away from any heating equipment. 
Failure to do so could melt the sheathing, resulting in a fire or electrical shock.
- Do not insert or drop foreign materials such as metals or anything inflammable through the openings or vents into the CU. 
Doing so could result in a fire or electrical shock.

■ DENSO WAVE INCORPORATED does not assume any product liability arising out of, or in connection with, the application or use of any product, circuit, or application described herein.

■ Intellectual Property Precaution

DENSO WAVE INCORPORATED ("DENSO WAVE") takes reasonable precautions to ensure its products do not infringe upon any patent or other intellectual property rights of other(s), but DENSO WAVE cannot be responsible for any patent or other intellectual property right infringement(s) or violation(s) which arise from (i) the use of DENSO WAVE's product(s) in connection or in combination with other component(s), product(s), data processing system(s) or equipment or software not supplied from DENSO WAVE; (ii) the use of DENSO WAVE's products in a manner for which the same were not intended nor designed; or (iii) any modification of DENSO WAVE's products by other(s) than DENSO WAVE.

Licensed under one or more of the following U.S. patents:

4, 570, 057; 4, 766, 300; 4, 894, 523; 5, 021, 642; 5, 038, 024
5, 081, 343; 5, 095, 197; 5, 144, 119; 5, 144, 121; 5, 182, 441
5, 187, 355; 5, 187, 356; 5, 218, 191; 5, 233, 172; 5, 258, 606
5, 288, 985

■ Proper Care of the BHT and CU

Clean the housings, battery cartridge terminals, and CU-7001 charge terminals with a dry, soft cloth. Before cleaning, be sure to turn the BHT power off and unplug the AC adapter of the CU.

- Never use benzene, alcohol, or other organic solvents. The housing may be marred or the paint may come off.
- Never rub or strike the liquid crystal display (LCD) with anything hard. The LCD surface will be easily scratched or broken.
- When cleaning the keypad, do not scrub the surface too hard, and do not pull on the keys. Doing so may break the keys or cause the keypad to dislocate.
- If the BHT or CU becomes smudged, moisten a soft cloth with neutral detergent and wring it out thoroughly. Wipe the BHT or CU with the cloth and then go over it again with a dry cloth.

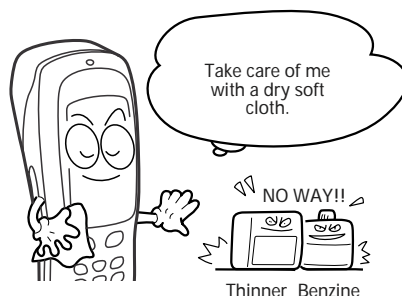

Dust or dirt accumulating on the clear plate of the reading window will affect reading performance. If you use the BHT in dusty areas, therefore, periodically check the clear plate of the reading window and clean it if dusty.

- To clean the plate, first blow the dust away with an air brush. Then wipe the plate with a cotton swab or the similar soft one gently.
- If sand or hard particles have accumulated, never rub the plate; doing so will scratch or damage it. Blow the particles away with an air brush or a soft brush.

FCC Regulations

This Device complies with Part 15 of the FCC Rules.

Operation is subject to the following two conditions:

- (1) this device may not cause harmful interference, and
- (2) this device must accept any interference received, including interference that may cause undesired operation.

NOTE: This equipment has been tested and found to comply with the limits for a Class A digital device, pursuant to Part 15 of the FCC Rules. These limits are designed to provide reasonable protection against harmful interference when the equipment is operated in a commercial environment. This equipment generates, uses, and can radiate radio frequency energy and, if not installed and used in accordance with the instruction manual, may cause harmful interference to radio communications. Operation of this equipment in a residential area is likely to cause harmful interference in which case the user will be required to correct the interference at his own expense.

FCC WARNING: Changes or modifications not expressly approved by the party responsible for compliance could void the user's authority to operate the equipment.

Labeling

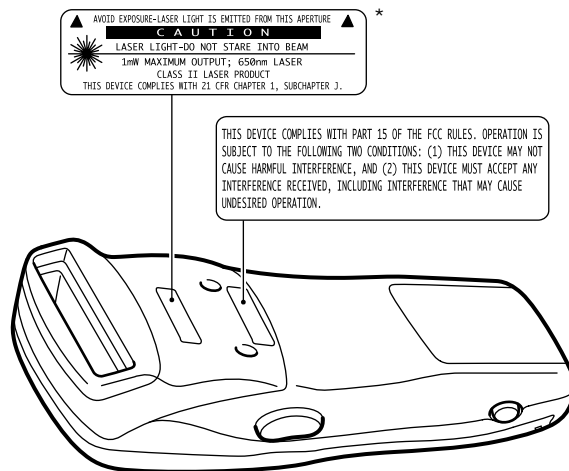

*Only for the BHT-100B.

Content Overviews

Preface	i
How this book is organized	ii
SAFETY PRECAUTIONS	iv
Chapter 1 Quick Guide	1
1.1 Reading 2D Codes and Bar Codes	2
<u>BHT-100Q</u>	2
<u>BHT-100B</u>	4
1.2 Setting and Using the Hand Strap and Stylus	6
1.3 Setting the Backlight	8
1.4 Using the Keypad	9
1.5 Transferring Data	10
Chapter 2 Getting Started the BHT and System Mode	11
2.1 BHT System Configuration	12
2.2 Components and Functions	17
2.3 Preparation	19
2.3.1 Setting-up 1: Loading the Battery Cartridge	19
2.3.2 Setting-up 2: Setting the Calendar Clock	23
2.3.3 Adjusting the LCD Contrast, Beeper Volume and Touch Screen, and Switching the Beeper & Vibrator	24
2.3.4 Battery Voltage Display	28
2.3.5 Battery Replacement Notes	29
2.3.6 BHT Turning-off Notes	31
2.4 Initializing the BHT System	35
2.5 Operating in System Mode	39
2.5.1 Starting System Mode	39
2.5.2 Operating in System Mode	43
2.5.3 Detailed Description of the Functions in System Mode	45
Chapter 3 Communications Operations of the BHT-100Q/100B	108
3.1 Infrared Communication	109
3.2 RS-232C Interface Specifications	111
3.3 Basic Communications Specifications and Parameters	113
3.3.1 Basic Communications Specifications	113
3.3.2 Communications Parameters	115

3.4	Communications Protocols	116
3.4.1	BHT-protocol	116
3.4.2	BHT-Ir Protocol	122
Chapter 4	Error Messages	128
4.1	System Errors	129
4.2	Errors in System Mode	134
Chapter 5	Handling the CU-7000 (Option)	139
5.1	Functions of the CU-7000	140
5.2	Components and Functions	140
5.3	Applying Power to the CU-7000	141
5.4	Communicating with the Host Computer	142
5.4.1	Setting the Transmission Speed of the CU-7000	142
5.4.2	Interface Cable Connection	142
5.4.3	Interfacing with the Host Computer	143
5.5	Charging the Rechargeable Battery Cartridge (using the CU-7001)	144
5.6	RS-232C Interface Specifications	146
Appendices	148
Appendix A.	Specifications	149
A.1	BHT-100Q	149
A.2	BHT-100B	156
A.3	CU-7000	161
Appendix B.	Communications Protocol Details	163
B.1	BHT-protocol	163
B.2	BHT-Ir protocol	173
Appendix C.	A Typical Basic Operation	184
Appendix D.	Quality Assurance Standards	185
D.1	Applicable Standards	185
D.2	Interface Cables	186
Index	188

Chapter 1. Quick Guide



**Chapter 2. Getting Started the BHT
and System Mode**



**Chapter 3. Communications Operations
of the BHT**

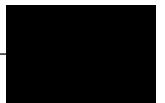

Chapter 4. Error Messages

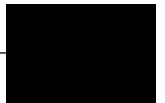

Chapter 5. Handling the CU-7000 (Option)

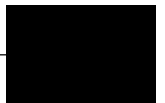

Appendices

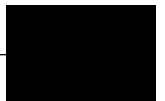

Chapter 1

Quick Guide

This chapter describes the basic operating method of the BHT and the related notes.

1.1	Reading 2D Codes and Bar Codes	2
	BHT-100Q	2
	BHT-100B	4
1.2	Setting and Using the Hand Strap and Stylus	6
1.3	Setting the Backlight	8
1.4	Using the Keypad	9
1.5	Transferring Data	10

1.1 Reading 2D Codes and Bar Codes

BHT-100Q

Turn the BHT power on, bring the reading window to the target code, and press the trigger switch. The BHT-100Q turns three marker LEDs on to indicate the scanning range and the illumination LED to scan the code. Keep the BHT stationary in a position where the target code lies between the right and left markers and the center marker comes to the center of the target code.

Hold the reading window 4 to 14 cm (1.6 to 5.5 inches) away from codes to be scanned.

When the BHT has read the code successfully, the indicator LED will illuminate in green and the markers will go off.

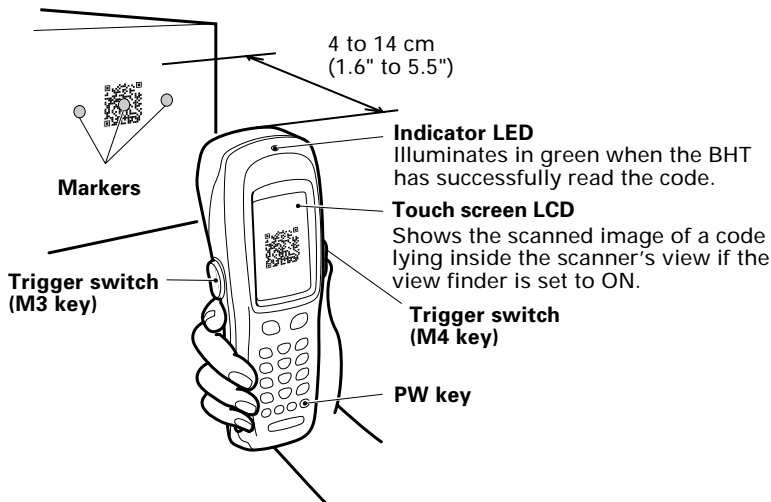

- The markers show the left-to-right scanning range. When the scanning distance is 8.5 to 9.5 cm (3.3 to 3.7 inches), they indicate almost the center of the up-down scanner's view. If the distance is out of the range, those markers will deviate from the center.
- If the BHT fails to read due to specular effects or other factors, change the scanning angle of the reading window or the distance from codes as shown at right, and try it again. (Specular effects occur when the reflection of the light from the code becomes excessively strong. This can easily happen when the reflecting surface is polished or covered with vinyl.)
- The code reading procedure may differ depending upon the application used, so follow the application's manual.

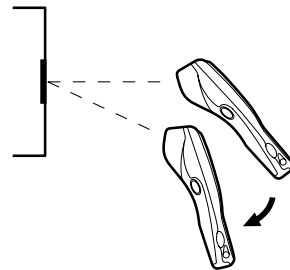

NOTE

- Before reading 2D codes or bar codes, clean those labels if stained.
- Avoid using the BHT in direct sunlight. The BHT might fail to read correctly.
- To read 2D codes or bar codes on curved surfaces, apply the BHT to the target code so that the code comes to the center of the scanning range indicated by the markers.
- Depending upon the code size or cell pitch, the proper scanning distance from 2D codes or bar codes will differ.
- Do not use the BHT in the vicinity of radio equipment. The BHT may malfunction.

TIP

At the scanning time, the marker LEDs and illumination LED will come on. The illumination LED may not come on where it is bright enough for the BHT to scan. The light intensity of those LEDs will vary depending upon the scanning conditions and variation of their elements.

BHT-100B

Turn the BHT power on, bring the bar-code reading window to the bar code to be scanned, and press the trigger switch. The BHT-100B emits a laser light to indicate the scanning range and turns on the illumination LED to scan the bar code.

When the BHT has read the bar code successfully, the indicator LED will illuminate in green.

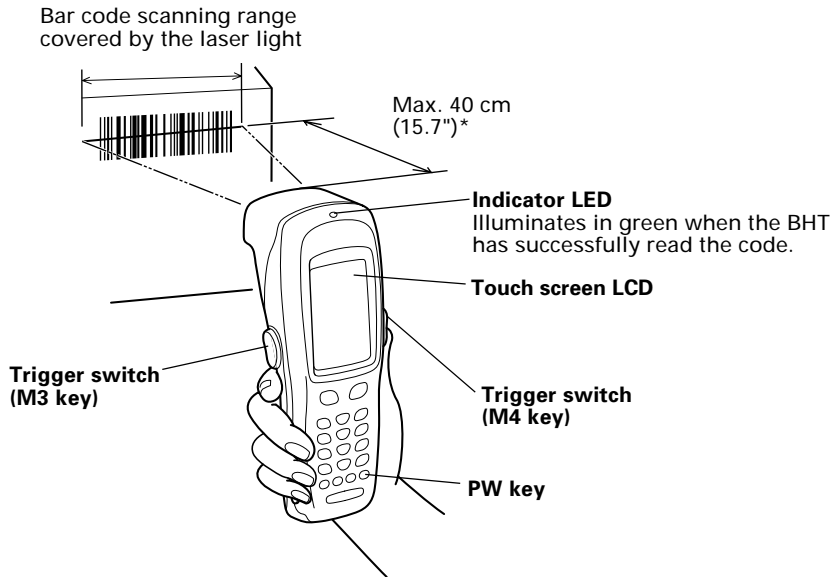

- If the BHT fails to read due to specular effects or other factors, change the scanning angle of the reading window or the distance from codes as shown at right, and try it again. (Specular effects occur when the reflection of the light from the bar code becomes excessively strong. This can easily happen when the reflecting surface is polished or covered with vinyl.)
- The laser light indicates the scanning range as a guide. The indicated scanning range will deviate a little bit from the actual one. Keep the BHT so that the laser light comes to almost the center of the bar code height.
- The BHT can read bar codes at a maximum distance of 40 cm (15.7")* from the reading window. (*For details about the scanning conditions, refer to Appendix A.)
- The bar code reading procedure may differ depending upon the application used, so follow the application's manual.

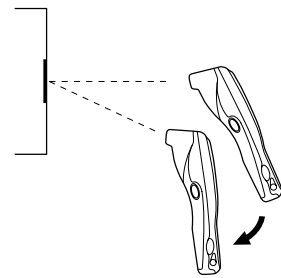

NOTE

- Before reading bar codes, clean those labels if stained.
- Avoid using the BHT in direct sunlight. The BHT might fail to read correctly.
- To read bar codes on curved surfaces, apply the BHT to the target bar code so that the code comes to the center of the scanning range indicated by the laser beam.
- When you pull the bar-code reading window away from bar codes, the actual scanning range will become narrower than the range covered by the laser beam.
- Do not use the BHT in the vicinity of personal or amateur radio equipment. The BHT may malfunction.

TIP

The light intensity of the laser light or illumination LED will vary depending upon the scanning conditions and variation of their elements.

1.2 Setting and Using the Hand Strap and Stylus

■ Setting the hand strap

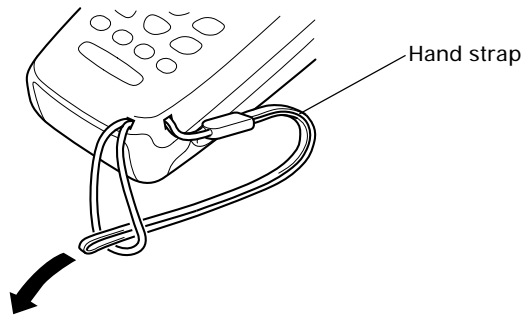

■ Using the hand strap

Put your hand through the hand strap and hold the BHT as shown below. This will prevent you from dropping the BHT accidentally.

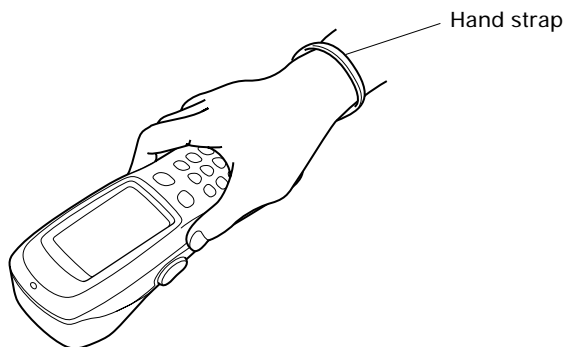

■ Setting the stylus

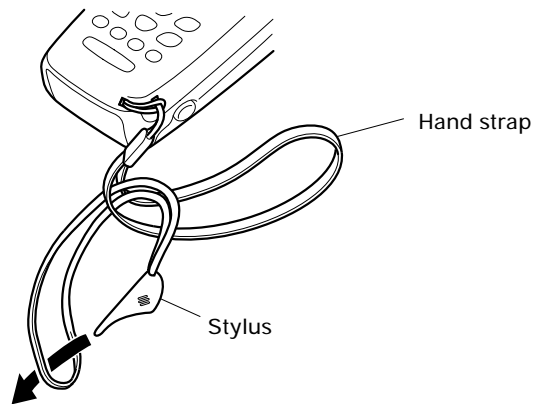

■ Using the stylus

The BHT has a touch screen LCD that enables you to use touch keys and draw images on the touch screen with the stylus if you have defined those touch keys and graphics pad box in user programs, respectively. Before using the touch screen, adjust it, referring to Subsection 2.3.3.

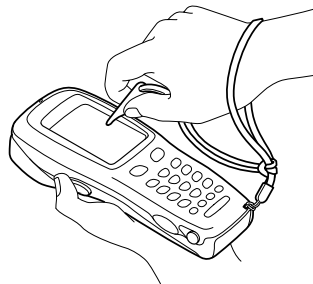

NOTE

Press the touch screen only with the stylus that comes with the BHT. Using the tip of a pen or any pointed object will result in a damaged or broken LCD. Strong pressure or impact applied to the LCD may also break the LCD.

1.3 Setting the Backlight

Pressing the right-hand trigger switch (**M4** key) while holding down the **SF** (Shift) key activates or deactivates the backlight function.

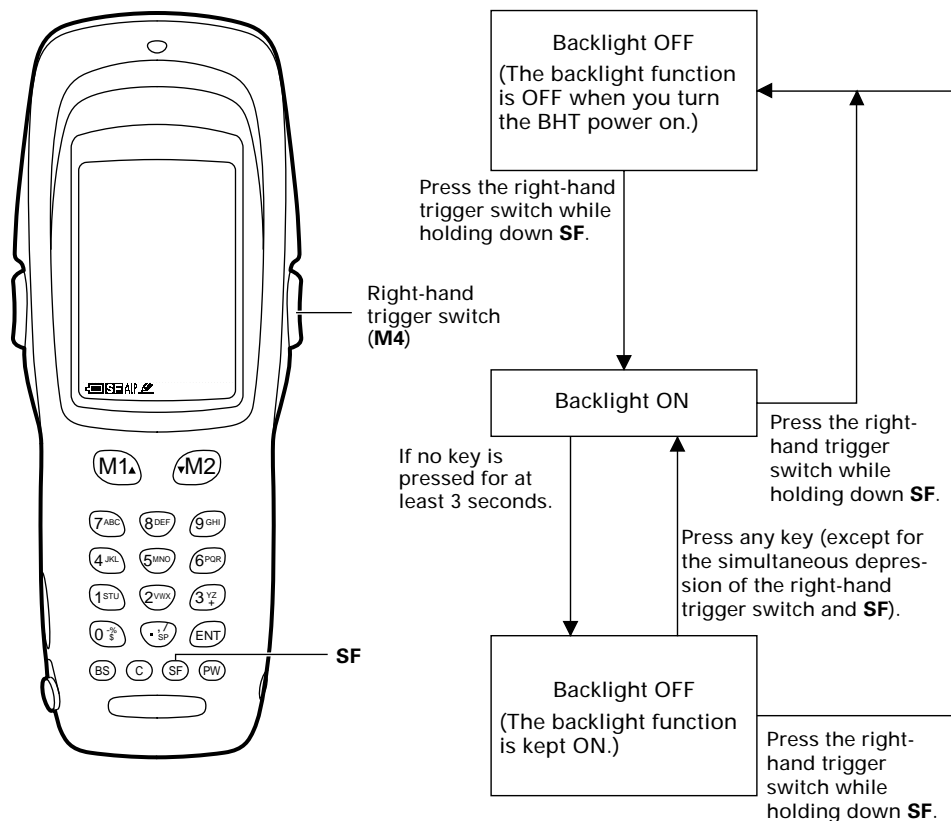

NOTE

In user programs, you can select the key to be used for activating or deactivating the backlight function (instead of the initial setting: combination of **SF** and the right-hand trigger switch), as well as modifying the ON-duration of the backlight before the automatic turning-off.

1.4 Using the Keypad

■ Entering Numerical Data

To enter numerical data, e.g., the quantity of goods, use the ten numerical keys and the **ENT** key.

For example, to enter the number "120," press the **1**, **2** and **0** keys and then press the **ENT** key.

If you key in any wrong value, press the **C** or **BS** key and then enter the correct one.

■ Selecting Tasks

If the LCD shows the selection items (xxx) prefixed by numerals (e.g., 1: xxx, 2: xxx), use the numerical keys to select a desired item and press the **ENT** key to execute.

If a YES/NO screen (e.g., 1: YES, 2: NO) appears, press the **1** key for YES response and **2** key for NO response.

■ Entering Alphabetic Characters

The BHT supports the alphabet entry function which allows you to enter alphabetic characters, space, and symbols from the keypad during execution of a user program. For the alphabet entry procedure, refer to the "BHT-BASIC Programmer's Manual (BHT-100 series)."

1.5 Transferring Data

■ Using infrared link

Using infrared rays, the BHT may transfer data directly to the host computer equipped with an IrDA interface port and other IrDA-compliant devices.

NOTE

- Make sure that there is no obstruction in the light path between the BHT and any target stations. In infrared communication, you need to keep the BHT and any target stations within the effective infrared radiation range, usually 10 to 80 cm (3.94 to 31.50").
- Shield the IrDA interface from direct sunlight, ambient intense lighting (inverter-driven fluorescent lighting, in particular), and other potential sources of infrared radiation. Sources to watch out for include remote control units for television sets and the like.

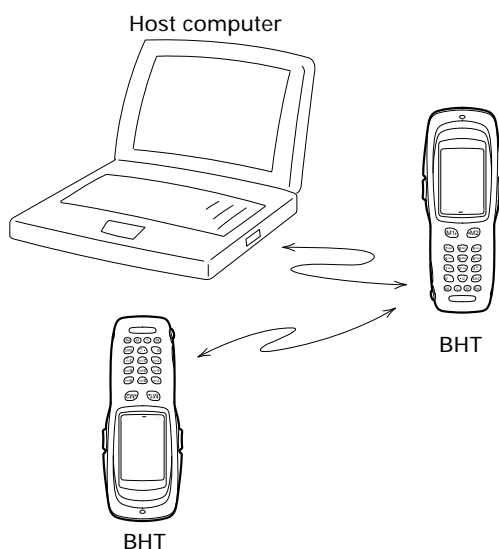

For a host computer having no IrDA interface port, use the optical communications unit CU-7000 (option) connected to the host via an RS-232C interface cable. Put the BHT in the CU-7000 as shown below.

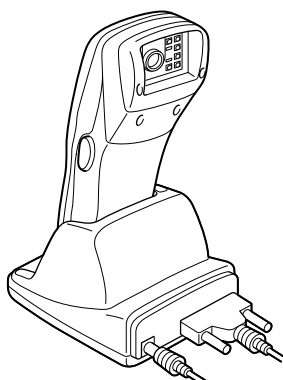

Chapter 2

Getting Started the BHT and System Mode

This chapter summarizes the BHT system configuration and describes the operation including preparation and System Mode (which is required for the efficient use of application programs).

2.1	BHT System Configuration	12
2.2	Components and Functions	17
2.3	Preparation	19
2.3.1	Setting-up 1: Loading the Battery Cartridge	19
2.3.2	Setting-up 2: Setting the Calendar Clock	23
2.3.3	Adjusting the LCD Contrast, Beeper Volume and Touch Screen, and Switching the Beeper & Vibrator	24
2.3.4	Battery Voltage Display	28
2.3.5	Battery Replacement Notes	29
2.3.6	BHT Turning-off Notes	31
	[1] "Shutdown in progress" message	31
	[2] If the BHT is turned off abnormally	31
	[3] About "\$\$BRKLST.SYS"	34
	[4] If invalid files are found	34
2.4	Initializing the BHT System	35
2.5	Operating in System Mode	39
2.5.1	Starting System Mode	39
2.5.2	Operating in System Mode	43
	[1] Calling up the desired set screen	43
	[2] Selecting a desired setting	44
2.5.3	Detailed Description of the Functions in System Mode	45
	[1] Program Execution	45
	[2] Downloading	47
	[3] Uploading	51
	[4] System Environment Setting	54
	[5] Testing	75
	[6] System Information	92
	[7] Deleting Files	93
	[8] Downloading/Uploading the BHT System Parameter File	95
	[9] Setting the Remote Wakeup	101
	[10] Downloading/Uploading the System Message File	102

2.1 BHT System Configuration

The BHT barcode data collection system requires the following hardware as well as the BHT Bar Code Handy Terminal (which reads 2D codes or bar codes and accepts key entry) as illustrated below:

- Host computer: Allows you to edit, manage and download programs and data, as well as downloading system programs.

For host computers having no IrDA interface ports, the optional CU-7000 optical communications unit and RS-232C interface cable are available.

- CU-7000 (option): Exchanges programs and data with the BHT via the IrDA interface and with the host computer via the RS-232C interface.
- RS-232C interface cable (option): Connects the CU-7000 and the host computer.

Direct cable connection between the BHT and host computer is also possible.

Optional software includes the BHT-BASIC Extension Library, BHT-BASIC Compiler, Ir-Transfer Utility C, Ir-Transfer Utility E, and Transfer Utility.

System Configuration

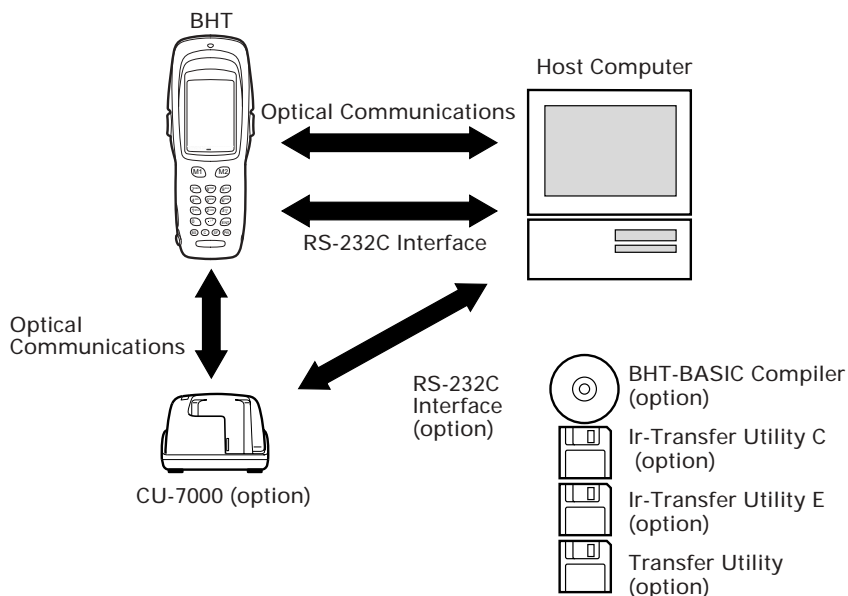

■ Host Computer

Models: PC/AT, PS/2

Optional application programs and OSes

Applications \ OS	MS-DOS	Win3.1	Win95	Win98	WinNT3.5/4.0	Win2000 Professional
BHT-BASIC Compiler	BHT-BASIC3.0 (MS-DOS-based)	BHT-BASIC3.0 (Windows3.1-based)	BHT-BASIC3.5			
Ir-Transfer Utility C	MS-DOS-based	—	Win95-/NT-based			
Ir-Transfer Utility E	—	—	Win95-/NT-based	Win95-/NT-based*	Win95-/NT-based	Win95-/NT-based*
Transfer Utility	MS-DOS-based	Windows3.1-based	Win95-/NT-based			

*This application does not activate any built-in port.

■ CU-7000 and RS-232C Interface Cable (option)

The CU-7000 is an IrDA-compliant communications unit which is required when your host computer is not equipped with an IrDA interface port. The CU-7000 exchanges data and programs with the BHT optically, and with the host computer via the RS-232C interface cable.

You may directly connect two BHTs with each other by using a commercially available metal cable having 3-pole mini stereo plugs (as a direct-connect interface cable). You also connect the BHT directly with the host computer or with the modem by using the direct-connect interface cable compatible with the target equipment. (NOTE: The direct-connect interface port of the BHT is not designed to stand frequent connecting/disconnecting. You are, therefore, recommended to use the CU-7000 where you expect to do a lot of connecting and disconnecting of the BHT to/from a host computer.)

■ BHT-BASIC Compiler (option)

This Compiler compiles a source program written in BHT-BASIC by an editor of the host computer running the MS-DOS, into the object program (user program) which can be used in the BHT. The compiled and linked program file is named "XXX.PD3." (XXX: File name you can set arbitrarily under the MS-DOS rules) You should download it to the BHT by using Ir-Transfer Utility C/Ir-Transfer Utility E/Transfer Utility.

■ **Ir-Transfer Utility C (option)**

Running on the host computer, this utility transfers files between the BHT and the host computer. For its file transfer control procedure, the utility uses the BHT-Ir protocol. (For the details about the BHT-Ir protocol, refer to Chapter 3, Subsection 3.4.2.)

To transfer files under any of the following conditions, use Ir-Transfer Utility C:

- At transmission speeds of 115200 or 57600 bps (This may be impossible depending upon the host computer type.)
- When the BHT is placed on the CU-7000
- Via the direct-connect interface of the BHT

■ **Ir-Transfer Utility E (option)**

Running on the host computer, this utility transfers files between the BHT and the host computer. For its file transfer control procedure, the utility uses the BHT-Ir protocol. (For the details about the BHT-Ir protocol, refer to Chapter 3, Subsection 3.4.2.)

To transfer files under any of the following conditions, use Ir-Transfer Utility E:

- Via an external IR transceiver
- Via an IR port integrated in a computer

■ **Transfer Utility (option)**

Running on the host computer, this utility transfers files between the BHT and the host computer. For its file transfer control procedure, the utility uses the BHT-protocol. (For the details about the BHT-protocol, refer to Chapter 3, Subsection 3.4.1.)

To transfer files under any of the following conditions, use Transfer Utility:

- When the BHT is placed on the CU-7000
- Via the direct-connect interface of the BHT

Software Structure

System Programs and JIS Level 1 & Level 2 fonts are resident in the system area and user area, respectively.

To use extension programs and user programs, you should download the program files into the user area.

To use data files (e.g., goods master files) required for execution of user programs, you should download those data files before execution of user programs. Those files will be stored in the user area.

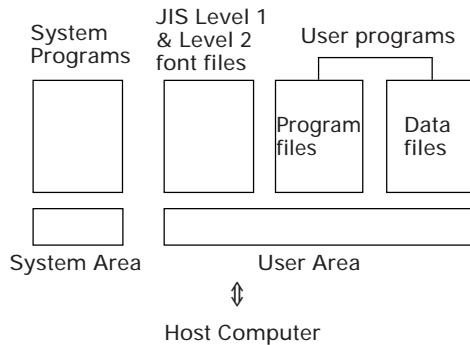

■ System Programs

The system programs include the following three sets of programs:

Drivers

Drivers is a set of programs that directly controls the BHT hardware. It may be called up by the BHT-BASIC Interpreter or System Mode.

BHT-BASIC Interpreter

The interpreter interprets and executes instructions in user programs written in BHT-BASIC.

System Mode

System Mode is a system program exclusively designed for the effective use of user programs in the BHT. It sets up the execution environments for those programs; e.g., it prepares downloading/uploading conditions, sets the calendar clock, and tests the BHT components including the LCD, beeper, and keypad. Shown below is the System Mode menu (SYSTEM MENU).

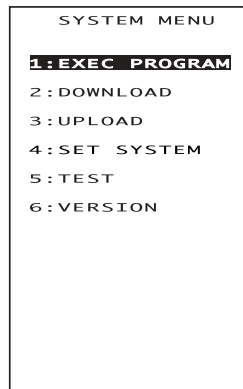

■ JIS Level 1 and Level 2 Font Files

These files contain font data required for displaying Kanji characters on the LCD.

The BHT can display the Kanji characters not only in the conventional standard-size font (16 dots wide by 16 dots high) but also in the small-size font (12 dots wide by 12 dots high) in application programs. It can also display the double-width, double-height, and quadruple-size (double-width & -height) Kanji characters of those 16-dot and 12-dot fonts in application programs.



If you do not need to display Kanji characters, you may delete these JIS font files. After deletion, the memory area which was occupied by these files can be used as a user area. For the deleting procedure, refer to Section 2.4, "Initializing the BHT System" or Subsection 2.5.3, "[7] Deleting Files."

The names of the JIS font files are:

FNT16J1.FN3	(JIS Level 1 font, 16-dot)
FNT16J2.FN3	(JIS Level 2 font, 16-dot)
FNT12J1.FN3	(JIS Level 1 font, 12-dot)
FNT12J2.FN3	(JIS Level 2 font, 12-dot)

■ User Programs

You can develop application programs to meet individual job requirements by using the BHT-BASIC Compiler. To download those user programs to the BHT, use Ir-Transfer Utility C/Ir-Transfer Utility E/Transfer Utility.

2.2 Components and Functions

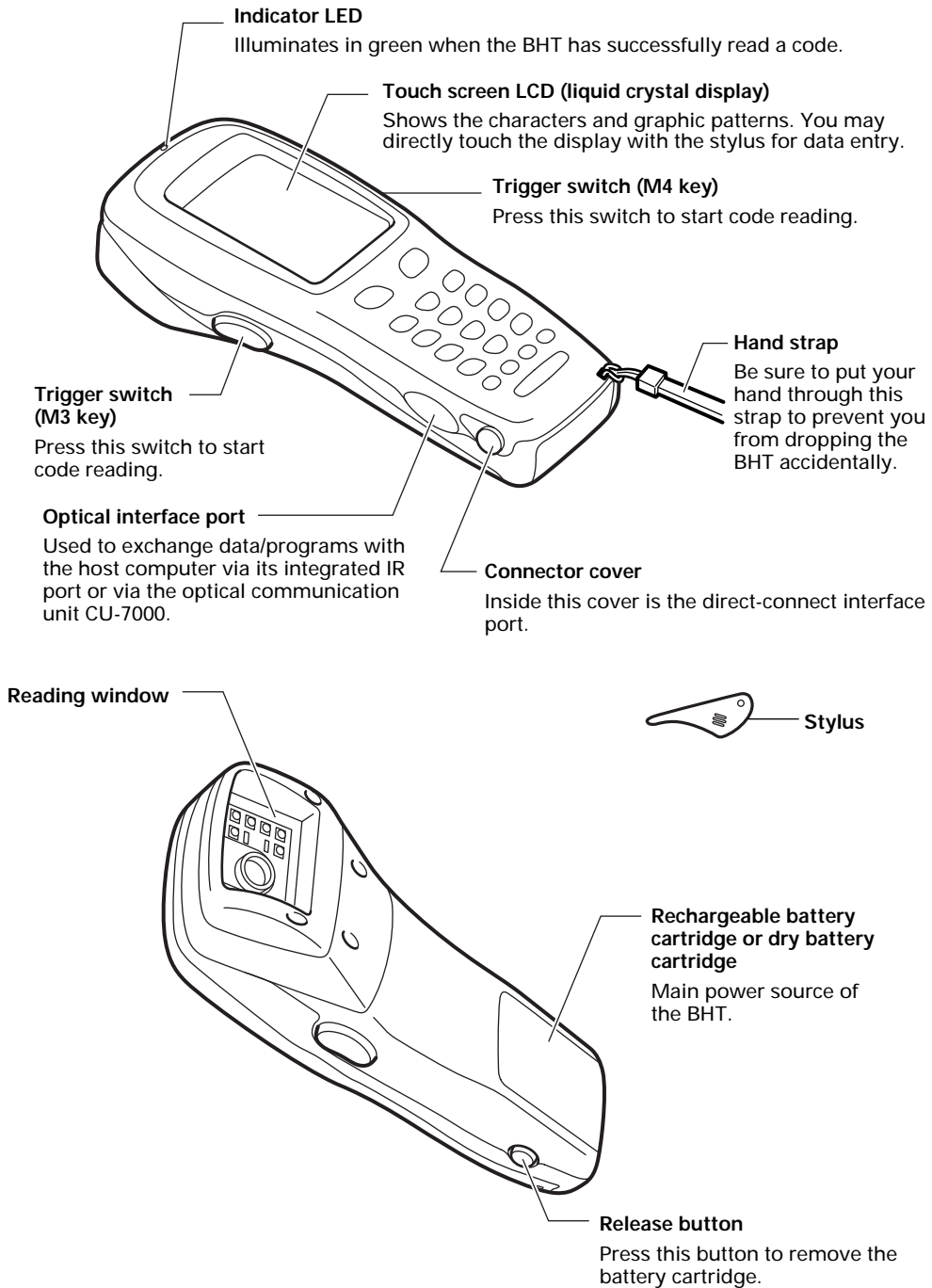

The functions of the keys may be set by user programs. Shown below is a set of sample functions.

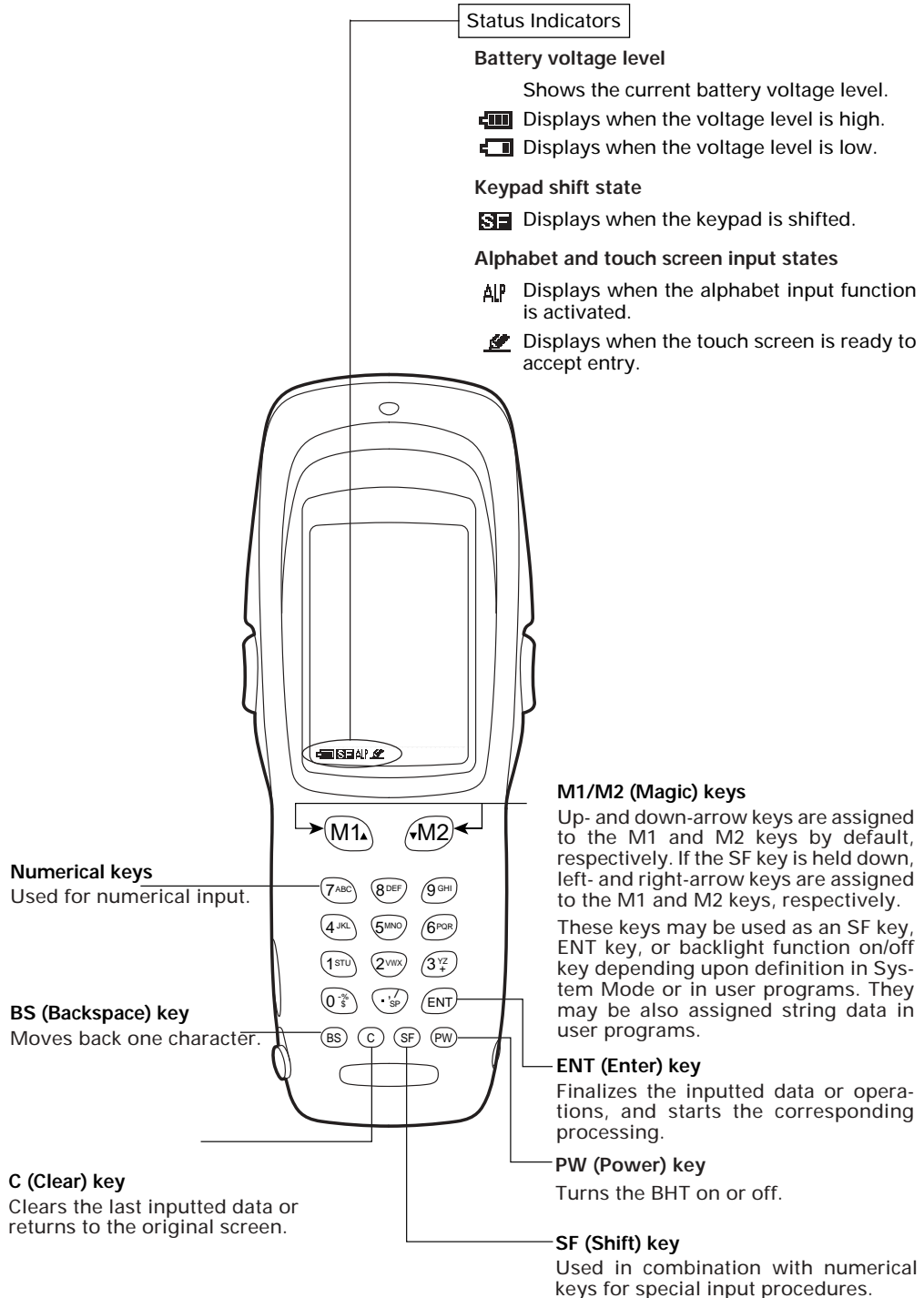

Function keys F1 through F8 may be assigned to FUNC keys defined on the touch screen. (For details, refer to Subsection 2.5.3, [4.6].)

2.3 Preparation

2.3.1 Setting-up 1: Loading the Battery Cartridge

Before the first use of the BHT, be sure to load the battery cartridge as shown below. The battery cartridge is not loaded in the BHT when shipped from the factory.

- (1) Charge the rechargeable battery cartridge. (Refer to Section 5.5.)

To use the dry battery cartridge in the BHT, set two dry cells into the cartridge. (Refer to the "Dry Battery Cartridge User's Manual" that comes with the dry battery cartridge.)

NOTE

Use the dry battery cartridge as a spare of the rechargeable battery cartridge. The run time of the dry battery cartridge loaded with new dry cells is shorter than that of the fully-charged rechargeable battery cartridge.

- (2) Turn the BHT upside down.
- (3) As shown below, slide the battery cartridge into the BHT until it clicks into place. (To remove it, press the release button after making sure that the BHT power is off.)

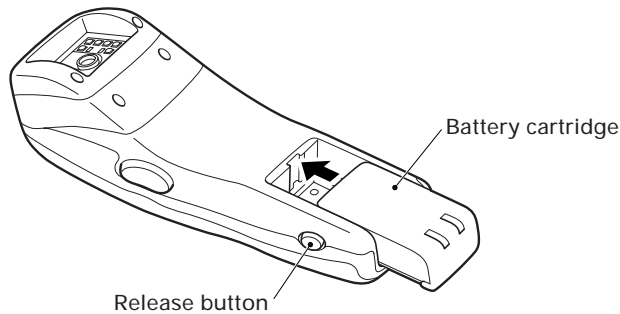

<p>⚠ WARNING</p>	<ul style="list-style-type: none"> • Never disassemble or heat the battery cartridge, nor put it into fire or water; doing so could cause battery-rupture or leakage of battery fluid, resulting in a fire or bodily injury. ⊘ • Do not carry or store the battery cartridge together with metallic ball-point pens, necklaces, coins, hairpins, etc. ⊘ Doing so could short-circuit the terminal pins, causing the batteries to rupture or the battery fluid to leak, resulting in a fire or bodily injury. • Avoid dropping the battery cartridge or letting it undergo any shock or impact. ⊘ Doing so could cause the batteries to break, generate heat, rupture or burn. • Never charge the rechargeable battery cartridge where any inflammable gases may be emitted; doing so could cause fire. ⊘
<p>⚠ CAUTION</p>	<ul style="list-style-type: none"> • Do not use batteries or power sources other than the specified ones; doing so could generate heat or cause malfunction. ⊘

NOTE

- Never charge the dry battery cartridge.
- The BHT has an integrated backup power source which backs up the memory and calendar clock in the BHT when no battery cartridge is loaded or the voltage level of the battery cartridge drops below the specified level. The backup power source is automatically charged by the battery cartridge.

When you first load the battery cartridge after purchase or you load it after leaving the BHT unused for a long time, do not remove the battery cartridge for 10 minutes or more after that loading. This is for charging the memory backup source integrated in the BHT.

- Be sure to turn the BHT off before battery replacement. Replace the battery cartridge quickly. Load a charged battery cartridge within 3 minutes from the removal of the cartridge to avoid data loss.

After battery replacement, turn the BHT on and check its operation.

- If you leave the BHT with no battery cartridge loaded for a long time, the memory contents will no longer be backed up so that the message "Contact your administrator. Note the error number. (XXXX)" or "Set the current date and time." may appear on the LCD.

If you will not be using the BHT for a long time, follow the instructions given in Subsection 2.3.5, "Battery Replacement Notes."

- Avoid storing the rechargeable battery cartridge in a hot place. The battery capacity may be decreased.
- Do not touch the charge terminals of the rechargeable battery cartridge or stain those terminals. Doing so could result in a charging failure.

■ Battery Voltage Level on the Status Indicator Line

The battery voltage level is always displayed on the status indicator line. (For details, refer to Subsection 2.3.4 "Battery Voltage Display.")

■ Low Battery Indication

Low battery indication—Level 1

If the battery output voltage drops below a specified lower level limit while the BHT is in operation, the BHT displays the following Level 1 message for approx. 2 seconds and beeps three times. After that, it will resume previous regular operation.

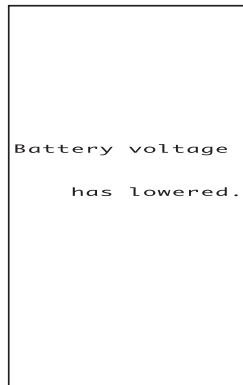

The battery recharge or replacement time will come soon. If the BHT is driven by the rechargeable battery cartridge, recharge or replace it; if it is driven by the dry battery cartridge, replace the dry cells.

Low battery indication—Level 2

If you continue to use the BHT without recharge or battery replacement after the Level 1 message appears, the BHT displays the following Level 2 message, beeps five times, and then turns itself off. Depending upon the battery level, the beeper may not sound five times.

(When driven by the
rechargeable battery cartridge)

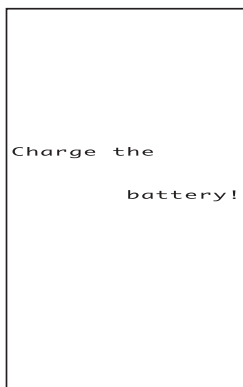

(When driven by the dry battery cartridge)

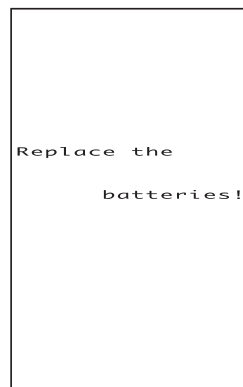

If the BHT is driven by the rechargeable battery cartridge, recharge or replace it; if it is driven by the dry battery cartridge, replace the dry cells.

NOTE

- When replacing dry cells, always replace both of them with new alkaline manganese batteries (LR6).
- You may charge the rechargeable battery cartridge with the optional CU-7001 communication unit or optional C-700/C-750 charger. For the charging procedure using the CU-7001, refer to Chapter 5. For that using the C-700/C-750, refer to the "C-700 User's Manual"/"C-750 User's Manual."
- If the "Charge the battery!" or "Replace the batteries!" message appears after the BHT undergoes any shock or impact, turn the power off and on and then check the battery output level. The battery may not have run out.

**WARNING**

Only use the dedicated charger (CU-7001, C-700 or C-750) for charging the rechargeable battery cartridge.

Using a different type of charger could cause battery-rupture or leakage of battery fluid and result in a fire, bodily injury, or serious damage to property.

**CAUTION**

Never charge a wet or damp rechargeable battery cartridge.

Doing so could cause the batteries to break, generate heat, rupture or burn.



2.3.2 Setting-up 2: Setting the Calendar Clock

Turn the BHT on by pressing the **PW** key.

The following message will appear.

```

Set the current
  date and time.

00/01/01 00:00
_ / /      :
  
```

In the following cases, the above message will appear. In such instances, it is necessary to set the date and time. (The indication "00/01/01 00:00" will differ depending upon the calendar clock state.)

- The BHT is first turned on from the time of purchase.
- The BHT is turned on after the memory backup power source is completely discharged.

```

SET DATE/TIME

00/01/01 00:00
00/04/19 16:00_
  
```

Use the numerical keys to enter the year (only the last two digits), month, day, hour, and minute in this order. If the data is in one digit, add a 0 (zero) preceding the data.

NOTE

For the year, be sure to enter the last two digits of the year. For the hour, enter it in the 24-hour format.

If any of the year, month, day, hour, and minute is not entered, the **ENT** key will be deactivated.

If you make a wrong entry, press the **BS** key to delete it and then enter the correct data.

[Example] To set 2000, April 19, at 4:00 p.m.

Press **0, 0, 0, 4, 1, 9, 1, 6, 0**, and **0**. Then press the **ENT** key to register the new setting.

If the above screen does not appear, follow the calendar clock setting procedure given in Subsection 2.5.3, [4.3] to set the calendar clock.

2.3.3 Adjusting the LCD Contrast, Beeper Volume and Touch Screen, and Switching the Beeper & Vibrator

While holding down the **M1** key or right-hand trigger switch (**M4**), press the **PW** key. The main adjustment screen appears which differs depending upon the current state as shown below.

After adjustment, press the **ENT** key or no keys for five seconds. The new settings will be registered and the main adjustment screen will disappear.

When the beeper is selected (default)

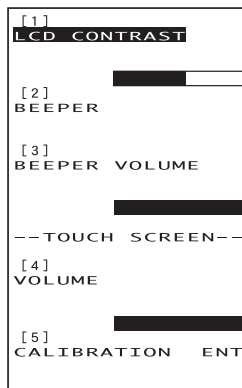

When the vibrator is selected

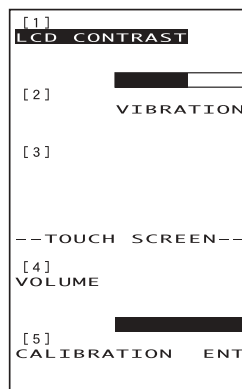

When both the beeper and vibrator are selected

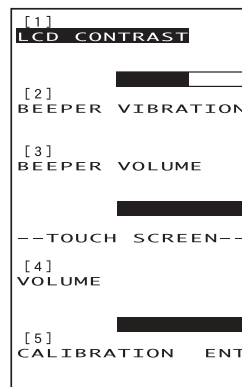

(The current selection is highlighted.)

Adjusting the LCD contrast

You can adjust the LCD brightness to eight contrast levels.

- (1) Use the **1** key (or **M1** or **M2** key) to select the LCD CONTRAST line.
- (2) To decrease the contrast, press the **M1** key with the **SF** key held down; to increase it, press the **M2** key with the **SF** key held down.

Switching the beeper & vibrator

You may choose any of three ways—beeping only, vibrating only, or beeping & vibrating as a confirmation of completion of code reading.

- (1) Use the **2** key (or **M1** or **M2** key) to select the BEEPER VIBRATION line that will be highlighted in any one of the following three states:



- (2) Highlight the desired way(s) by using the **M1** or **M2** key while holding down the **SF** key.

Adjusting the beeper volume

You can adjust the beeper volume to four levels from OFF to MAX.

- (1) Use the **3** key (or **M1** or **M2** key) to select the BEEPER VOLUME line.
- (2) To turn down the volume, press the **M1** key with the **SF** key held down; to turn it up, press the **M2** key with the **SF** key held down.

Adjusting the beeper volume to be sounded when you press the touch screen

You can adjust the volume of the beeper to be sounded when you press the touch screen, to three levels from OFF to MAX.

- (1) Use the **4** key (or **M1** or **M2** key) to select the VOLUME line.
- (2) To turn down the volume, press the **M1** key with the **SF** key held down; to turn it up, press the **M2** key with the **SF** key held down.

Adjusting the touch screen

At the first use of the touch screen or if the touch areas seem to deviate from the normal positions when in use, adjust the touch screen according to the steps given below.

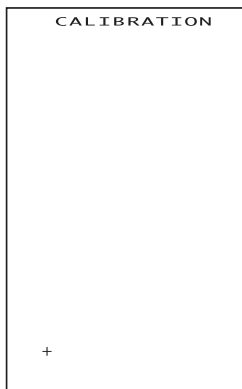
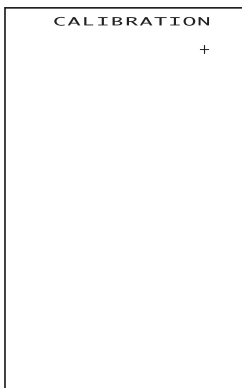
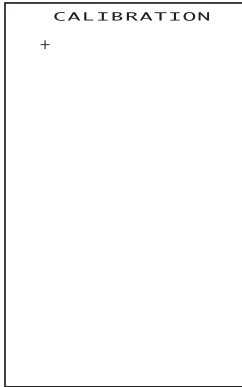

Use the **5** key (or **M1** or **M2** key) to select the CALIBRATION line, then press the **ENT** key. The screen shown at left will appear.

Touch the center of the "+" with the stylus. The screen will switch to the following one.

To cancel adjustment and return to the main adjustment screen, press the **C** key.

Touch the center of the newly displayed "+."

To cancel adjustment and return to the main adjustment screen, press the **C** key.

Touch the center of the newly displayed "+."

To cancel adjustment and return to the main adjustment screen, press the **C** key.

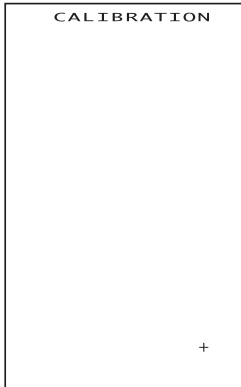

Touch the center of the 4th "+."

The adjustment will complete and the display will return to the main adjustment screen.

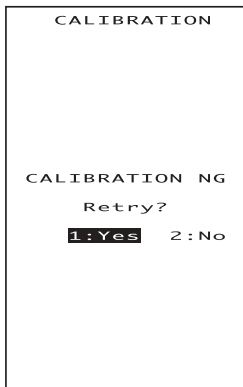

If the adjustment is not completed normally, the screen shown at left will appear where you may choose retry or not.

If you select "1:Yes" and press the **ENT** key, the display will return to the top screen of the touch screen adjustment sequence.

If you select "2:No" and press the **ENT**, or press the **C** key, the display will return to the main adjustment screen.



2.3.4 Battery Voltage Display

The battery voltage level is always displayed on the status indicator line (bottom line).



Battery voltage level

Shows the current battery voltage level.

-  Displays when the voltage level is high.
-  Displays when the voltage level is low.

TIP

The displayed battery level shows the terminal voltage of the battery, not how much power is left.

The battery voltage level varies depending upon the operation of the BHT, so the displayed level also may vary.

2.3.5 Battery Replacement Notes

■ When is battery replacement needed?

If the "Charge the battery!" or "Replace the batteries!" appears on the LCD, replace the rechargeable battery cartridge with a fully charged one or replace the dry cells with new ones, respectively.

If you leave the BHT without replacing the rechargeable battery cartridge or dry cells, the integrated calendar clock or data will no longer be backed up so that the calendar clock will stop or the message "Contact your administrator. Note the error number. (XXXX)" will appear on the LCD.

NOTE

Be sure to turn the BHT off before battery replacement.

Replace the battery cartridge quickly. Load a charged battery cartridge or new dry cells within 3 minutes after the removal to avoid data loss.

After battery replacement, turn the BHT on and check its operation.

■ If you will use the BHT more than one time per month:

Keep the battery cartridge loaded in the BHT.

■ If you will not be using the BHT for more than one month:

Remove the battery cartridge from the BHT and then store the BHT. To do so, be sure to follow the procedure given below.

(1) When removing the battery cartridge:

Press the **PW** key for more than 3 seconds to turn the power off.

The following message will appear on the LCD and the BHT will start backing up data. After completion of the backup operation so that the message disappears, remove the battery cartridge.

(The backup operation may take several tens of seconds depending upon the volume of data to be backed up.)

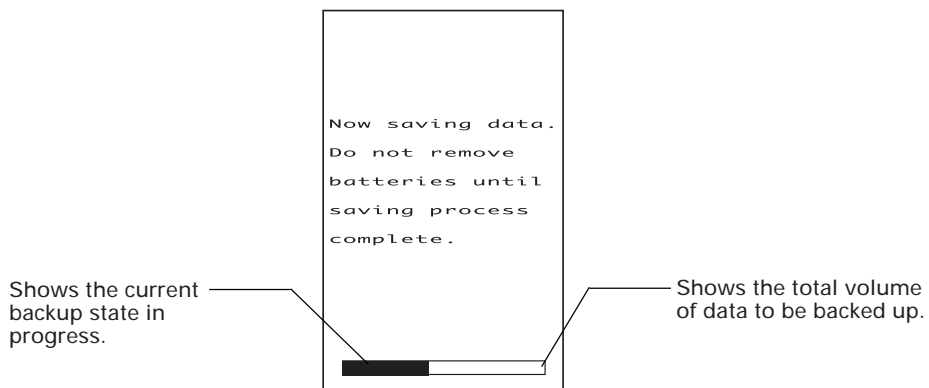

(2) When turning the BHT on after storage with no battery cartridge loaded:

Even after removal of the battery cartridge, the calendar clock will work with the backup power source for a while.

If the calendar clock backup has stopped, loading the battery cartridge and turning the BHT on will display the following message, prompting you to set the current date and time.

Set the calendar clock according to the procedure given in Subsection 2.3.2.

(The indication "00/01/01 00:00" will vary depending upon the calendar clock state.)

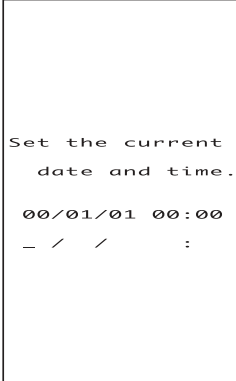

```
Set the current
  date and time.
00/01/01 00:00
_ / /      :
```

NOTE

- The rechargeable battery cartridge can be recharged hundreds of times, but it will eventually wear out. If the run time is noticeably shorter than normal, replace the battery cartridge with a new one.
- Use only DENSO WAVE-authorized battery cartridges and chargers.
- Never dispose of batteries into a fire.
- When disposing of battery cartridges, cover their terminal pins with vinyl tape to prevent short-circuit.
- Batteries should be recycled properly. Do not throw them in the trash.

2.3.6 BHT Turning-off Notes

[1] "Shutdown in progress" message

When the BHT is turned off by pressing the **PW** key or by the auto power-off feature, it displays the following message and starts preparation for shutdown.

```
Shutdown
in progress.

Do not remove
the battery.
```

When the above message is displayed, do not remove the battery cartridge.

If you do so and leave the BHT without a battery cartridge loaded for one hour or more, then the error message "Contact your administrator. Note the error number. (2XXX)" may appear when turning the BHT on at the next time.

[2] If the BHT is turned off abnormally

If the BHT is turned off abnormally* and is left without a battery cartridge loaded or with a discharged battery cartridge loaded, then unsaved data may be lost.

(*"Normally turned off" refers to "turned off with the **PW** key or by the auto power-off feature.")

If the above problem has arisen, the following message will appear when you load a fully-charged battery cartridge (or a dry battery cartridge having new dry cells) and turn the BHT on.

```
Your terminal
was not shut
down properly
the last time
it was used.

Unsaved data
was lost.

[SF+2]
```

- (1) Press the **2** key while holding down the **SF** key. The screen will switch to the following:

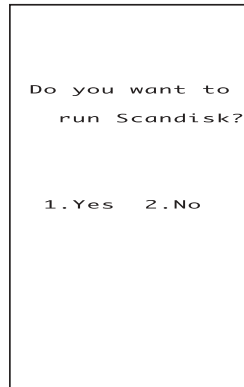

[1] YES: Run Scandisk and start the System.

[2] NO: Turn the BHT off.

- (2) Choose either one with the numerical keys and press the **ENT** key.

When Scandisk is in progress, the following message is displayed:

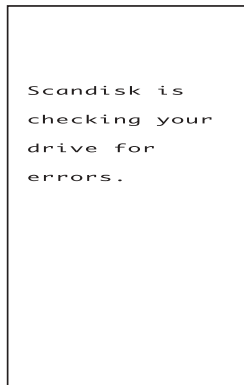

If Scandisk finds an invalid file(s), the following screen will appear. As long as an invalid file exists, that screen displays every time the BHT System is started up.

```
Scandisk found
invalid files.

Refer to the
file
"$$BRKLST.SYS"
for more
information.
```

- (3) Press the ENT key to start up the BHT System.

■ Scandisk when the resume function is enabled

If Scandisk runs when the resume function is enabled, the screen given below may appear. The screen may also appear when the calendar clock built in the BHT stops, even without running Scandisk.

The BHT displays the screen for three seconds and then automatically runs the execution program from the beginning.

```
No resume info.
has been
retained.
Program restarts
automatically.
```

[3] About "\$\$BRKLIST.SYS"

If Scandisk finds an invalid file(s), it will automatically create the "\$\$BRKLIST.SYS" file. To check the contents of the file, upload the file in System Mode to the host computer. (Refer to Subsection 2.5.3, "[3] Uploading.")

Contents of the "\$\$BRKLIST.SYS" file

Records (1) File name

(2) Error factor + (Broken since the BHT has not been turned off normally)

* (Broken due to any other causes)

(3) Broken records e.g. 01000-01200 (Data in records numbered 1000 to 1200 is lost)

(Example)

SAMPLE1.DAT + 01000-01050	}	If more than one sequence of records is broken in a same file, they will be written into the subsequent records in the "\$\$BRKLIST.SYS."
SAMPLE1.DAT + 01200-01250		
SAMPLE1.DAT + 01600-01650		
SAMPLE2.DAT * 00250-00275		
SAMPLE3.DAT * 00100-00150		
↑ ↑ ↑		
(1) (2) (3)		

[4] If invalid files are found

Even invalid, files may be uploaded, so upload them to the host computer according to your needs.

After uploading,

- Delete those invalid files. (Refer to Subsection 2.5.3, "[7] Deleting Files.")
- or
- Download valid files having the same names as invalid files. (Refer to Subsection 2.5.3, "[2] Downloading.")

2.4 Initializing the BHT System

Initializing the system will lose program files and data files stored in the user area and the system settings will revert to the factory defaults.

TIP You may delete font files by selecting the whole user area to be initialized.

You need to initialize the system when:

- (1) you want to delete all of the program files and data files.
- (2) the following message appears.

A rectangular box with a thin black border containing the following text:

```
Contact your
  administrator.
Note the error
      number.
(2xxx)
```

On the following pages is an initialization procedure.

(1) Selecting the memory area to be initialized



(Area selection screen)

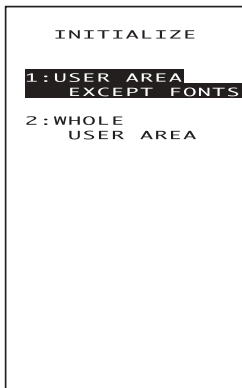

Press the **PW** key while holding down the **SF**, **M1** and **0** keys together.

The screen shown at left will appear.

To initialize the user area except for the font file area, press the **ENT** key. The screen switches to the SELECT MESSAGE display given in step (2).

To initialize the whole user area including the font file area, press the **2** key while holding down the **SF** key. The "2:WHOLE USER AREA" item will appear.

1 USER AREA EXCEPT FONTS:

Initializes the user area except for the font file area.

2 WHOLE USER AREA:

Initializes the whole user area including the font file area.

TIP

If the message "Contact your administrator. Note the error number. (2XXX)" appears on the LCD, you need to select "2: WHOLE USER AREA" to initialize the whole user area.

Select an area to be initialized by using the numerical keys, then press the **ENT** key. The screen switches to the SELECT MESSAGE display given in step (2).

(2) Selecting the English or Japanese message version

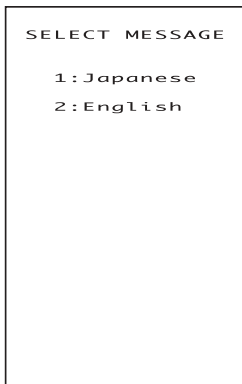

Preceding the execution of initialization, the message version selection screen will appear as shown at left.

1 Japanese : Switches the message version to Japanese.

2 English : Switches the message version to English.

Select a desired item by using the numerical keys, then press the **ENT** key.

(3) Confirming the memory area selected for initialization

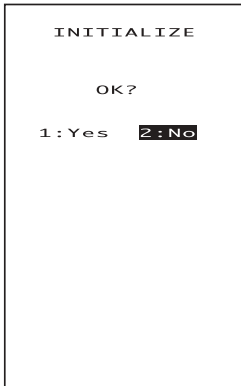

Selecting the "USER AREA EXCEPT FONTS" in step (1) above will call up the confirmation screen shown at left.

1 Yes : Starts initialization.

2 No : Cancels initialization and turns the power off.

Select a desired item by using the numerical keys, then press the **ENT** key.

Pressing the **C** key will switch the screen back to the area selection screen.

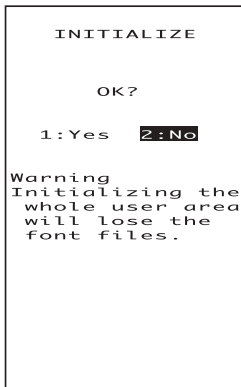

Selecting the "WHOLE USER AREA" in step (1) above will call up the screen shown at left.

1 Yes: Starts initialization.

2 No: Cancels initialization and turns the power off.

Select a desired item by using the numerical keys, then press the **ENT** key.

Pressing the **C** key will switch the screen back to the area selection screen.

(4) During initialization

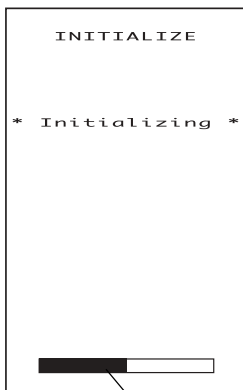

During initialization, the screen shown at left is displayed.

Progress in initialization

(5) Completion of initialization

```
INITIALIZE  
  
** Completed **
```

Upon completion of the initialization, the BHT displays the screen shown at left for a second and turns itself off automatically.

NOTE

- Do not turn the BHT off until the above initialization completion screen appears. A too-early powering-off will interrupt initialization, requiring you to initialize the BHT again.
- If the message "Contact your administrator. Note the error number. (2XXX)" appears although the initialization has completed, initialize the BHT again.
- If you initialize the BHT after downloading user programs and data, all of those programs and data stored in the target memory area will be lost. Download them again if necessary.
- Initialization will reset the LCD contrast level (refer to Subsection 2.3.3), communications conditions and other settings to the factory defaults, so modify them if necessary. After initialization, be sure to set the calendar clock (refer to Subsection 2.3.2).

2.5 Operating in System Mode

System Mode is an operating software exclusively designed for the effective use of the BHT, which includes various functions as shown on the following pages.

2.5.1 Starting System Mode

To start up System Mode, turn the BHT power on while holding down the **SF** and **1** keys. This operation calls up the SYSTEM MENU on the LCD as shown below.

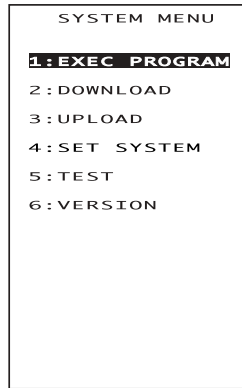

The function selected is highlighted (white-on-black) with the cursor. To select a desired item in System Mode, press the corresponding numerical key and then press the **ENT** key.

The keys below are so designed that the function of each key is consistent in every screen.

Numerical keys	Pressing a numerical key corresponding with a desired menu number selects the desired item displayed on the screen.
ENT key	Pressing this key registers the selected item and executes the corresponding function.
M1 and M2 keys	Pressing the M1 or M2 key moves the cursor up or down, respectively, to select a desired item.
SF+M1 and SF+M2 keys	Pressing the M1 or M2 key with the SF key held down moves the cursor to the left or right, respectively, to select a desired setting.

The **C** key is inoperative on the SYSTEM MENU. On other screens, pressing the **C** key returns to the immediately preceding screen.

The power-on default is "EXEC PROGRAM" which is highlighted. Once any other item is selected, the selected item will become highlighted with the cursor when you turn back to the SYSTEM MENU.

■ Structure of System Mode

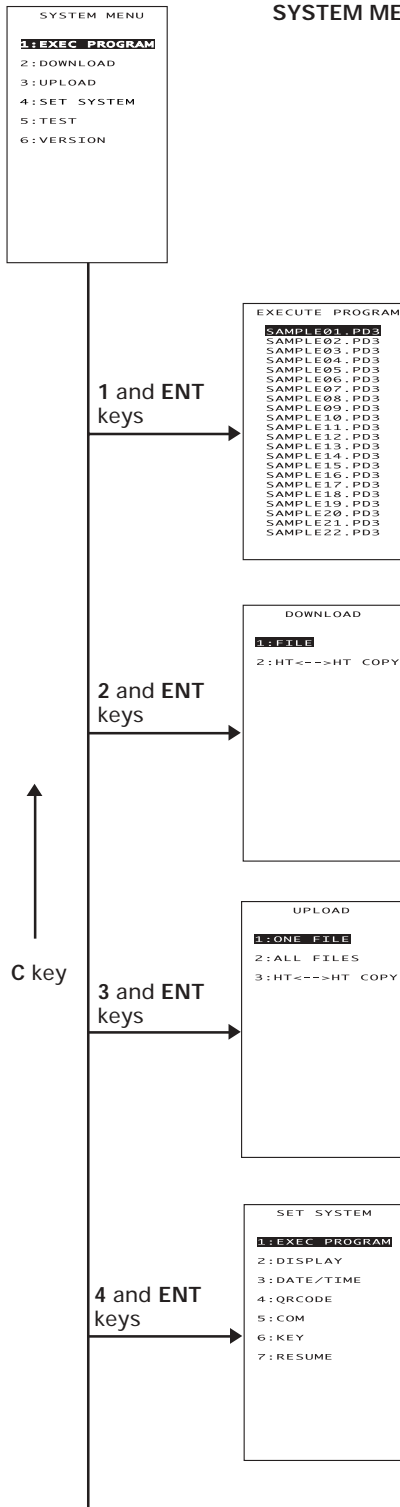

SYSTEM MENU ← Press the **PW** key while holding down the **SF** and **1** keys.

Program Execution

Allows you to select a desired user program to be executed immediately. (Refer to Subsection 2.5.3, [1].)

Downloading

Transfers user program files or data files from the host computer to the memory integrated in the BHT. Downloading between the BHTs is also possible. (Refer to Subsection 2.5.3, [2].)

Uploading

Transfers user program files and data files stored in the memory of the BHT to the host computer. (Refer to Subsection 2.5.3, [3].)

System Environment Settings

Sets a variety of environmental conditions—an execution program, message version (English or Japanese), calendar clock, special bar-code scanning parameters, interface port, communications parameters, functions of the shift key, magic keys and FUNC keys, and resume function.

Shown at left is the BHT-100Q screen. The BHT-100B screen displays "4:BARCODE" instead of "4:QRCODE." (Refer to Subsection 2.5.3, [4].)

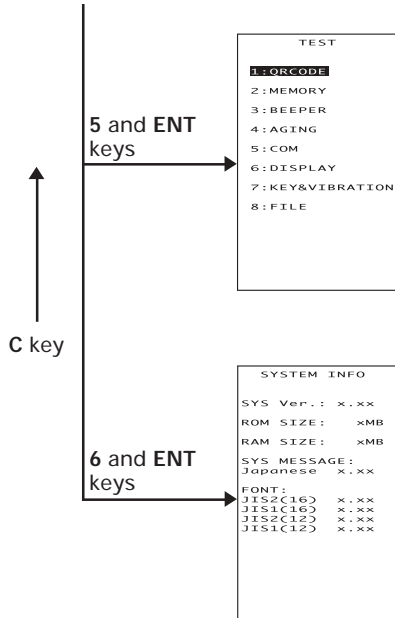

```

TEST
1: QR CODE
2: MEMORY
3: BEEPER
4: AGING
5: COM
6: DISPLAY
7: KEY&VIBRATION
8: FILE
    
```

```

SYSTEM INFO
SYS Ver.: x.xx
ROM SIZE: xMB
RAM SIZE: xMB
SYS MESSAGE:
Japanese x.xx
FONT:
JIS2(16) x.xx
JIS1(16) x.xx
JIS2(12) x.xx
JIS1(12) x.xx
    
```

Testing

Used for the code reading test, memory test, beeper test, aging test, communications test, LCD indication test, indicator LED test, touch screen test, key-entry test, vibrator test, and file test.

Shown at left is the BHT-100Q screen. The BHT-100B screen displays "1:BARCODE" instead of "1:QR CODE." (Refer to Subsection 2.5.3, [5].)

System Information

Shows the system program version, memory size, system message version, and JIS font type and version.

(Refer to Subsection 2.5.3, [6].)

2.5.2 Operating in System Mode

Some functions in System Mode require several screens to be shifted, as shown in the example below.

[1] Calling up the desired set screen

First, select a desired item on the current screen by using the numerical key or the **M1** and **M2** keys so as to highlight the desired item.

Press the **ENT** key to establish the selected item and proceed to the subsequent screen.

To return to the preceding screen, press the **C** key.

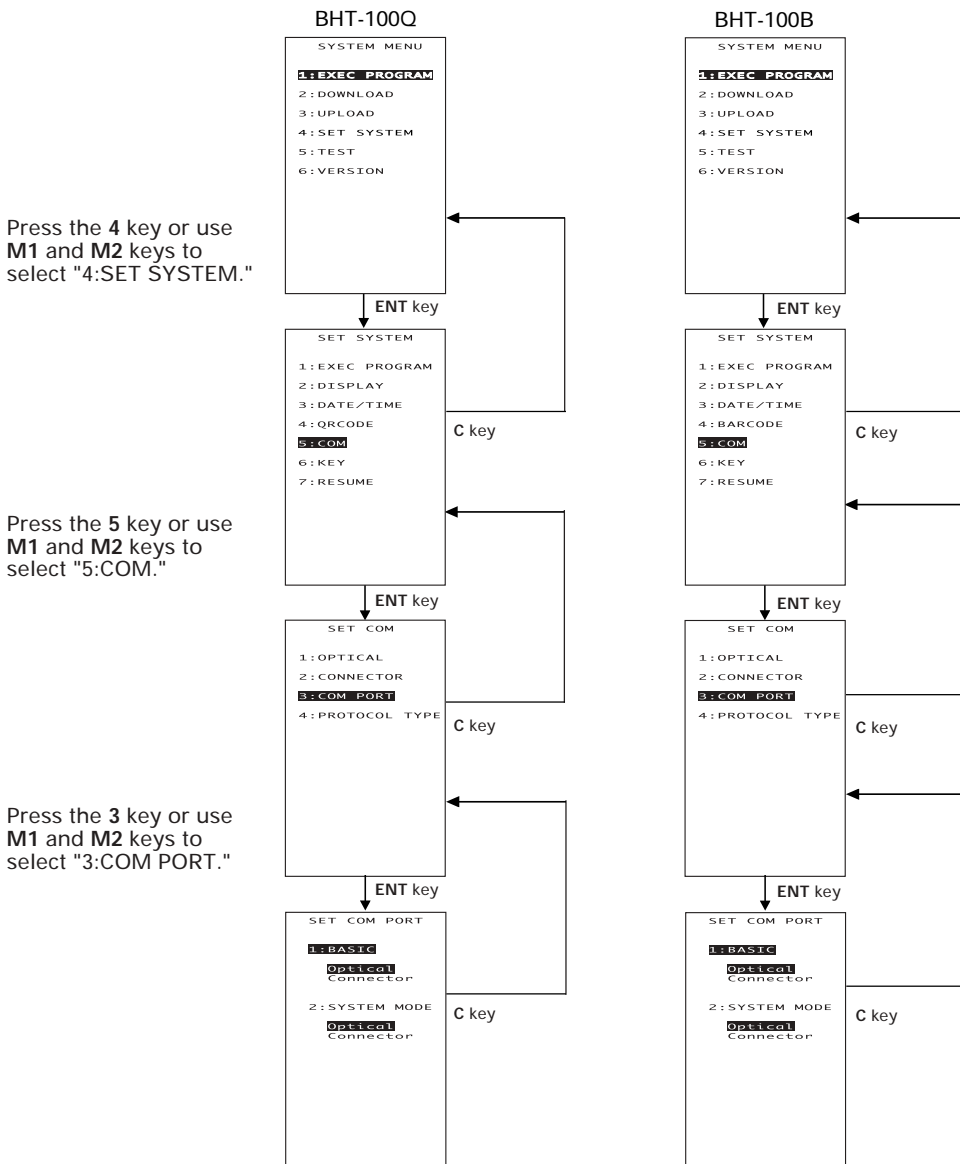

[2] Selecting a desired setting

First, select a desired item on the current screen by using the numerical key or the **M1** and **M2** keys so as to highlight the desired item.

Next, while holding down the **SF** key, use the **M1** and **M2** keys to select a desired setting and then press the **ENT** key. The screen returns to the previous selection screen.

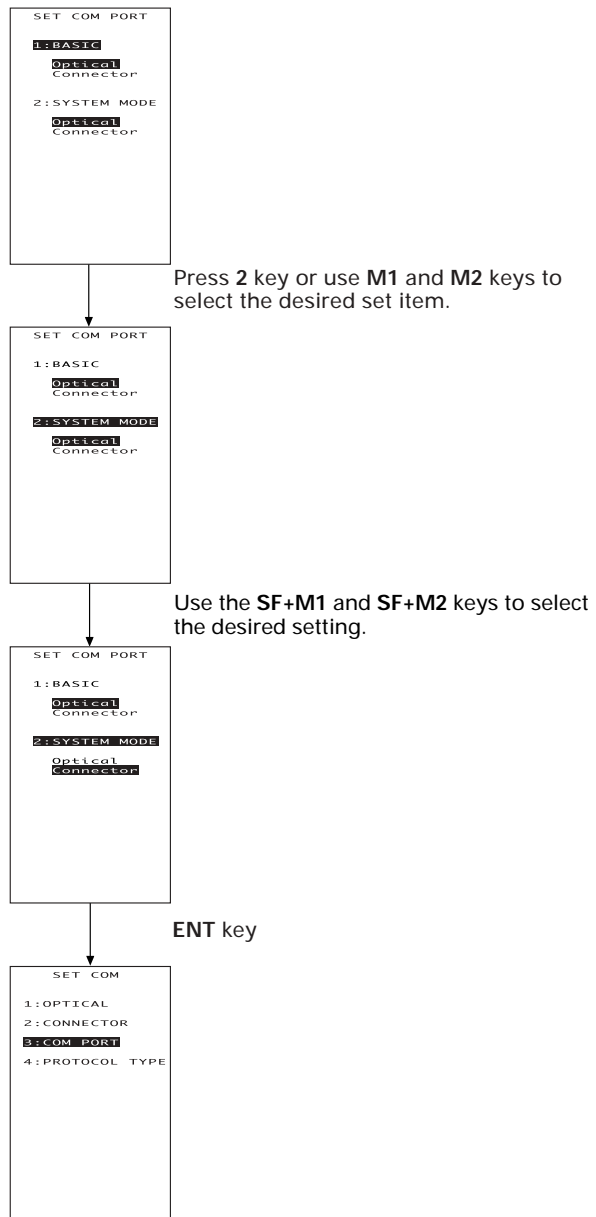

2.5.3 Detailed Description of the Functions in System Mode

[1] Program Execution

```
EXECUTE PROGRAM
SAMPLE01.PD3
SAMPLE02.PD3
SAMPLE03.PD3
SAMPLE04.PD3
SAMPLE05.PD3
SAMPLE06.PD3
SAMPLE07.PD3
SAMPLE08.PD3
SAMPLE09.PD3
SAMPLE10.PD3
SAMPLE11.PD3
SAMPLE12.PD3
SAMPLE13.PD3
SAMPLE14.PD3
SAMPLE15.PD3
SAMPLE16.PD3
SAMPLE17.PD3
SAMPLE18.PD3
SAMPLE19.PD3
SAMPLE20.PD3
SAMPLE21.PD3
SAMPLE22.PD3
```

Selecting "1:EXEC PROGRAM" on the SYSTEM MENU calls up the screen shown at left.

If more than one program has been downloaded to the user area of the target memory, use the **M1** and **M2** keys to move the cursor to a target program, and then press the **ENT** key.

To return to the SYSTEM MENU, press the **C** key.

```
EXECUTE PROGRAM
SAMPLE01.PD3
SAMPLE02.PD3
SAMPLE03.PD3
SAMPLE04.PD3
SAMPLE05.PD3
SAMPLE06.PD3
SAMPLE07.PD3
SAMPLE08.PD3
SAMPLE09.PD3
SAMPLE10.PD3
SAMPLE11.PD3
SAMPLE12.PD3
SAMPLE13.PD3
SAMPLE14.PD3
SAMPLE15.PD3
SAMPLE16.PD3
SAMPLE17.PD3
SAMPLE18.PD3
SAMPLE19.PD3
SAMPLE20.PD3
SAMPLE21.PD3
SAMPLE22.PD3
SAMPLE23.PD3
```

If more than 22 programs have been downloaded, you may need to scroll the screen with the **M2** key.



```
EXECUTE PROGRAM
SAMPLE02.PD3
SAMPLE03.PD3
SAMPLE04.PD3
SAMPLE05.PD3
SAMPLE06.PD3
SAMPLE07.PD3
SAMPLE08.PD3
SAMPLE09.PD3
SAMPLE10.PD3
SAMPLE11.PD3
SAMPLE12.PD3
SAMPLE13.PD3
SAMPLE14.PD3
SAMPLE15.PD3
SAMPLE16.PD3
SAMPLE17.PD3
SAMPLE18.PD3
SAMPLE19.PD3
SAMPLE20.PD3
SAMPLE21.PD3
SAMPLE22.PD3
SAMPLE23.PD3
```



```
EXECUTE PROGRAM
SAMPLE05.PD3
SAMPLE06.PD3
SAMPLE07.PD3
SAMPLE08.PD3
SAMPLE09.PD3
SAMPLE10.PD3
SAMPLE11.PD3
SAMPLE12.PD3
SAMPLE13.PD3
SAMPLE14.PD3
SAMPLE15.PD3
SAMPLE16.PD3
SAMPLE17.PD3
SAMPLE18.PD3
SAMPLE19.PD3
SAMPLE20.PD3
SAMPLE21.PD3
SAMPLE22.PD3
SAMPLE23.PD3
SAMPLE24.PD3
SAMPLE25.PD3
SAMPLE26.PD3
```

In the example shown at left, 26 programs are downloaded.

```
EXECUTE PROGRAM
*****
*NO FILE EXISTS*
*****
```

If no program file is downloaded, the message shown at left will appear.

To return to the SYSTEM MENU, press the **C** key.

[2] Downloading

NOTE

If you download a file having the same name as one already used in the user area of the target memory in the BHT, the newly downloaded file replaces the old one.

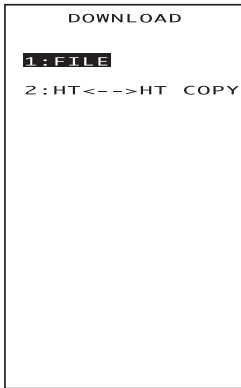

Selecting "2: DOWNLOAD" on the SYSTEM MENU calls up the screen shown at left.

- 1 FILE : Downloads a user program file or data file to the user area of the BHT.
- 2 HT<-->HT COPY : Downloads all of the files, system parameters, and calendar clock data stored in the connected BHT.

This function enables copying between the BHTs.

For the preparation to be made preceding the start of this function, refer to NOTE below.

Select a desired item by using the numerical keys or **M1** and **M2** keys, and the selected item becomes highlighted. Then press the **ENT** key.

To return to the SYSTEM MENU, press the **C** key.

NOTE

Carrying out "2:HT<-->HT COPY" will not copy the JIS1 and JIS2 font files. Those font files may be downloaded by "1:FILE."

NOTE Preparation for Copying between the BHTs

Before downloading to the BHT from another BHT, make the following preparation:

- At each BHT, set the interface port. The default is an optical interface (Optical).

Interface setting procedure: Starting on the SYSTEM MENU, select "4:SET SYSTEM," "5:COM," and "3:COM PORT." On the SET COM PORT screen, select the optical interface (Optical) or direct-connect interface (Connector) of "2:SYSTEM MODE."

- When using the direct-connect interface, pull out the connector cover on each BHT to expose the direct-connect interface port. Connect the BHTs via those ports with the direct-connect interface cable (having 3-pole mini stereo plugs). For the details about the cable, refer to Chapter 3, Section 3.2.
- On the uploading BHT, run System Mode and select "3:UPLOAD" and "3:HT<-->HT COPY."

Download screens

```
DOWNLOAD FILE
** Waiting **
```



```
DOWNLOAD FILE
XXXXXXXXX.XXX
** Loading **
YYYYY/ZZZZ
```



```
DOWNLOAD FILE
XXXXXXXXX.XXX
* Now Checking *
YYYYY/ZZZZ
```

With this screen displayed, the BHT waits for a file to be downloaded.

If you select "2:HT<-->HT" on the DOWNLOAD menu, the "HT<-->HT" will appear in the center of the 2nd line. If you select "1:FILE," nothing will appear on the 2nd line.

The screen at left shows that "1:FILE" has been selected.

Upon start of optional Ir-Transfer Utility C/Ir-Transfer Utility E/Transfer Utility or equivalent program (upon receipt of an ENQ code from the host computer), the BHT displays the file name and the number of received records/the total number of records on the screen as shown at left.

To abort the downloading operation, press the C key. The screen will switch back to the DOWNLOAD menu.

(Refer to the "Ir-Transfer Utility C Guide"/"Ir-Transfer Utility E Guide"/"Transfer Utility Guide.")

```

DOWNLOAD FILE
XXXXXXXXX.XXX
** Completed **
    
```

Upon completion of downloading, the number of received records becomes equal to the total number of records and the beeper beeps once. Press the C key to return to the DOWNLOAD menu.

If the host computer downloads another new file (if the BHT receives an ENQ code) when this screen is displayed, the BHT starts receiving it.

(Refer to the "Ir-Transfer Utility C Guide"/"Ir-Transfer Utility E Guide"/"Transfer Utility Guide.")

If you have selected "2: HT<-->HT COPY" on the DOWNLOAD menu, a sequence of the above screens will be repeated by the number of files to be downloaded.

If an error occurs during downloading

If some error occurs during downloading, the BHT beeps three times and shows one of the following screens with the prompt "Retry?":

To retry the download, press the 1 and ENT keys; to abort it, press the 2 and ENT keys.

```

DOWNLOAD FILE
XXXXXXXXX.XXX
Out of memory!!

Retry?
 1:Yes  2:No
    
```

■ Problem

The memory is insufficient for storing files to be downloaded.

■ Solution

Press the 2 key to return to the SYSTEM MENU, then delete unnecessary files in the memory or decrease the size of the file to be downloaded. (Refer to Subsection 2.5.3, [7] and [2].)

```

DOWNLOAD FILE
XXXXXXXXX.XXX
File mismatch!!

Retry?
 1:Yes  2:No
    
```

■ Problem

You attempted to download the BHT system parameter file or system message file.

■ Solution

Check the file you attempted to download. Press the 2 key to return to the SYSTEM MENU and then download the file in the appropriate menu (SYSTEM PARAMETER transfer menu or SYSTEM MESSAGE transfer menu). (Refer to Subsection 2.5.3, [8] and [10].)

```
DOWNLOAD FILE
XXXXXXXXX.XXX
Too many files!!

Retry?
 1:Yes  2:No
```

■ Problem

The current download will exceed the maximum of 80 files in the memory.

■ Solution

Press the **2** key to return to the SYSTEM MENU. Delete unnecessary files in memory or decrease the number of files to be downloaded if you attempted to download more than one file. (Refer to Subsection 2.5.3, [7] and [2].)

```
DOWNLOAD FILE
XXXXXXXXX.XXX
Communication
error!!

Retry?
 1:Yes  2:No
```

■ Problem

Downloading has failed.

■ Solution

To retry downloading, press the **1** key.

Pressing the **2** key returns to the SYSTEM MENU. Check the interface port, communications parameters, and communications protocol type in the SET SYSTEM menu or perform the communications test in the TEST menu. (Refer to Subsection 2.5.3, [4.5] and [5.5].)

It is also necessary to check the communications parameters setup of the host computer.

```
DOWNLOAD FILE
XXXXXXXXX.XXX
File error!!

Retry?
 1:Yes  2:No
```

■ Problem

You attempted to download an invalid program file.

■ Solution

Check whether the program file you attempted to download is available to your BHT model. If it is not available, download the appropriate program.

[3] Uploading

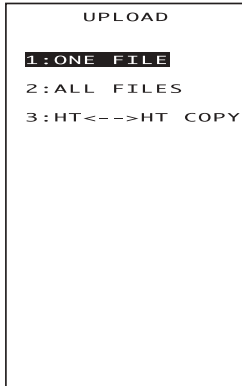

Selecting "3: UPLOAD" on the SYSTEM MENU calls up the screen shown at left.

- 1 ONE FILE : Uploads a user program file or data file stored in the memory.
- 2 ALL FILES : Uploads all user program files (object programs) and all data files stored in the memory.
- 3 HT<-->HT COPY : Uploads all of the files, system parameters, and calendar clock data stored in the BHT, to another BHT.

This function enables copying between the BHTs. At the receiving BHT, select "2: DOWNLOAD" and "2: HT<-->HT COPY" in System Mode.

For the preparation to be made preceding the start of this function, refer to NOTE given on page 47.

Select a desired item by using the numerical keys or **M1** and **M2** keys, and the selected item becomes highlighted. Then press the **ENT** key.

To return to the SYSTEM MENU, press the **C** key.

NOTE

Carrying out "3:HT<-->HT COPY" will not copy the JIS1 and JIS2 font files. Those font files may be uploaded by "1:ONE FILE" or "2:ALL FILES."

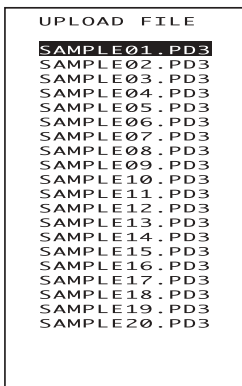

If you select "1:ONE FILE" on the UPLOAD menu, the file selection screen as shown at left will appear, listing all of the program files and data files stored in the memory. Select a file(s) you want to upload and press the **ENT** key.

If you select "2:ALL FILES" or "3:HT<-->HT COPY" on the UPLOAD menu, the "ALL" or "HT<-->HT" will appear in the center of the 2nd line, respectively.

```
UPLOAD FILE
*****
*NO FILE EXISTS*
*****
```

If you select "1:ONE FILE" or "2:ALL FILES" on the UPLOAD menu when no files are stored in the memory, the message shown at left will appear.

Pressing the C key returns to the UPLOAD menu.

Upload screens

```
UPLOAD FILE
** Waiting **
```

If you select "1:ONE FILE" and choose a file to be uploaded or if you select the "2:ALL FILES" or "3:HT<-->HT COPY" on the UPLOAD menu, then the screen shown at left will appear.

If you select "2:ALL FILES" or "3:HT<-->HT COPY," the "ALL" or "HT<-->HT" will appear in the center of the 2nd line, respectively.

Showing this screen, the BHT waits for a file(s) to be uploaded.



```
UPLOAD FILE
XXXXXXXX.XXX
** Loading **
YYYYY/ZZZZ
```

Upon start of optional Ir-Transfer Utility C/Ir-Transfer Utility E/Transfer Utility or equivalent program (upon receipt of an ACK code from the host computer), the BHT displays the file name and the number of sent records/the total number of records on the screen as shown at left.

To abort the uploading operation, press the C key. The screen will switch back to the UPLOAD menu.

(Refer to the "Ir-Transfer Utility C Guide"/"Ir-Transfer Utility E Guide"/"Transfer Utility Guide.")



```

UPLOAD FILE
XXXXXXXXXX.XXX
** Completed **
    
```

Upon completion of uploading, the number of sent records becomes equal to the total number of records and the beeper beeps once. Press the **C** key to return to the UPLOAD menu.

If you have selected "2:ALL FILES" or "3:HT<-->HT COPY" on the UPLOAD menu, a sequence of the above screens will be repeated by the number of files to be uploaded.

If an error occurs during uploading

If some error occurs during uploading, one of the following screens will appear and the beeper beeps three times.

To retry the uploading operation, press the **1** and **ENT** keys; to abort it, press the **2** and **ENT** keys.

```

UPLOAD FILE
XXXXXXXXXX.XXX
File error!!
Upload?
  1:Yes  2:No
    
```

■ Problem

The file you attempted to upload is damaged.

■ Solution

To upload the damaged file as is, press the **1** key.

```

UPLOAD FILE
XXXXXXXXXX.XXX
Communication
error!!
Retry?
  1:Yes  2:No
    
```

■ Problem

Uploading has failed.

■ Solution

To retry uploading, press the **1** key.

Pressing the **2** key returns to the SYSTEM MENU. Check the interface port, communications parameters, and communications protocol type in the SET SYSTEM menu or perform the communications test in the TEST menu. (Refer to Subsection 2.5.3, [4.5] and [5.5].)

It is also necessary to check the communications parameters setup of the host computer.

[4] System Environment Setting

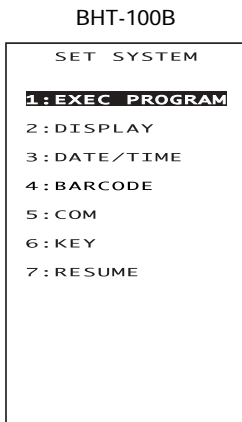
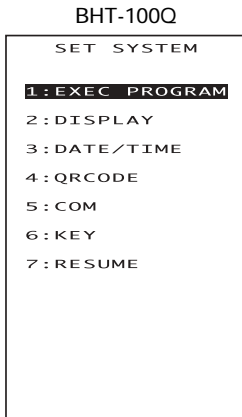

Selecting "4: SET SYSTEM" on the SYSTEM MENU calls up the screen shown at left.

1 EXEC PROGRAM : Sets an execution program to be run when the power is turned on.

2 DISPLAY : Sets the message version (English or Japanese).

3 DATE/TIME : Sets the calendar clock (date and time).

4 QR CODE : Sets the special code scanning parameters—the black-and-white inverted label reading, marker, view finder, option data, and the minimum number of digits to be read for bar codes (ITF and Codabar).

BARCODE (BHT-100B) : Sets the special bar-code scanning parameters (the black-and-white inverted label reading and the decoding level) and the minimum number of digits to be read for bar codes (ITF, STF and Codabar).

5 COM : Sets the communications environments (interface port and communications parameters).

6 KEY : Defines the functions of the shift key, magic keys, and function keys.

7 RESUME : Sets the resume function.

Select a desired item by using the numerical keys or **M1** and **M2** keys, and the selected item becomes highlighted. Then press the **ENT** key.

Press the **C** key to return to the SYSTEM MENU.

[4.1] Setting an execution program

```
SET EXEC PROGRAM
SAMPLE01.PD3
SAMPLE02.PD3
SAMPLE03.PD3
SAMPLE04.PD3
SAMPLE05.PD3
```

Selecting "1: EXEC PROGRAM" on the SET SYSTEM menu calls up the screen shown at left.

Highlighted is the current setting.

Use the **M1** and **M2** keys to move the cursor to a desired execution program to be run when the power is applied, and then press the **ENT** key.

To return to the SET SYSTEM menu, press the **C** key.

If no program files are stored in the memories, the screen shown at left will appear.

```
SET EXEC PROGRAM
*****
*NO FILE EXISTS*
*****
```

To return to the SET SYSTEM menu, press the **C** key.

[4.2] Setting the message version

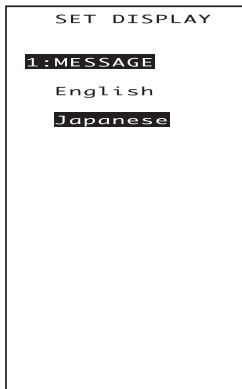

Selecting "2: DISPLAY" on the SET SYSTEM menu calls up the screen shown at left.

Highlighted is the current setting.

- 1 MESSAGE: Switches the message version to English or Japanese for system error messages and indications on the screen for the LCD contrast, beeper volume and touch screen adjustment and the beeper & vibrator switching. (The default is the message version that you selected in the initializing sequence.)

Select a desired setting by using the **M1** and **M2** keys with the **SF** key held down.

Press the **ENT** key.

To return to the SET SYSTEM menu, press the **C** key.

[4.3] Setting the calendar clock

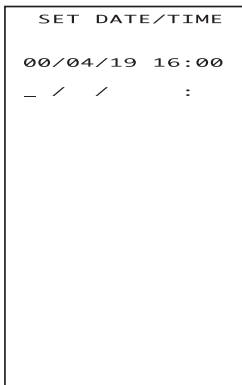
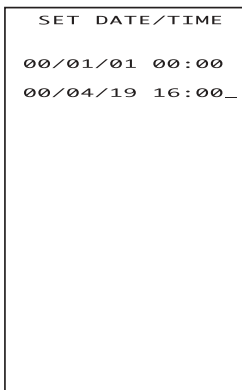
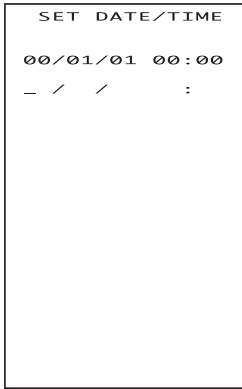

Selecting "3:DATE/TIME" on the SET SYSTEM menu calls up the screen shown at left.

Use the numerical keys to enter the year (only the last two digits), month, day, hour, and minute in this order, and then press the **ENT** key. If the data is in one digit, add a 0 (zero) preceding the data.

NOTE

For the year, be sure to enter the last two digits of the year. For the hour, enter it in the 24-hour format.

If any of the year, month, day, hour, and minute is not entered, the **ENT** key will be deactivated.

If you make a wrong entry, press the **BS** key to delete it and then enter the correct data.

To return to the SET SYSTEM menu, press the **C** key.

[Example] To set 2000, April 19, at 4:00 p.m.

Press **0, 0, 0, 4, 1, 9, 1, 6, 0,** and **0.**

Press the **ENT** key to register the above setting.

[4.4] Setting the special scanning parameters

BHT-100Q

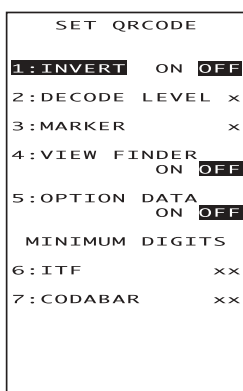

Selecting "4: QRCODE" on the SET SYSTEM menu calls up the screen shown at left.

Highlighted is the current setting.

- 1 INVERT : Activates or deactivates the black-and-white inverted label reading function.
- 2 DECODE LEVEL : (Not applicable.)
- 3 MARKER : Sets the marker ON/OFF mode.
- 4 VIEW FINDER : Turns the view finder on or off.
- 5 OPTION DATA : Selects whether or not option data will be added to the tail of 2D code data read.
- 6 ITF : Sets the minimum number of digits to be read for ITF.
- 7 CODABAR : Sets the minimum number of digits to be read for Codabar.

Select a desired item by using the numerical keys or **M1** and **M2** keys, and then select a desired setting by using the **SF+M1** and **SF+M2** keys.

To increase the decode level, press the **SF+M2** keys; to decrease it, press the **SF+M1** keys.

To increase the number of digits to be read for ITF and Codabar, press the **SF+M2** keys; to decrease it, press the **SF+M1** keys.

Press the **ENT** key.

To return to the SET SYSTEM menu, press the **C** key.

Black-and-white inverted label reading function (INVERT)

This function makes it possible to read white bars on a black background.

NOTE

When this function is activated, the BHT-100Q cannot read codes other than QR codes.

Marker

You may select the marker ON/OFF mode from the following:

- 0: Driven by the trigger switch
- 1: Fixed to ON
- 2: Fixed to OFF

NOTE

If you select "1" (Fixed to ON), the markers will keep ON so that power consumption is higher than that in other modes and the battery working time becomes short. Do not disturb this setting unless necessary.

View Finder

If the View Finder is set to ON, the LCD shows the scanned image of a code lying inside the scanner's view when you scan the code. Upon completion of scanning, the view finder display goes off.

NOTE

Setting the View Finder to ON decreases the scanning speed.

TIP

You may set the view finder also by using the OUT statement in BHT-BASIC.

Option Data

If the Option Data is set to ON, the BHT-100Q will add option data (containing 2D code model and error correction level) to the tail of 2D code data when it reads a 2D code.

NOTE

This setting takes effect not only in the reading test in System Mode but also in any other operations. Do not disturb this setting unless necessary.

Option data format

- QR code

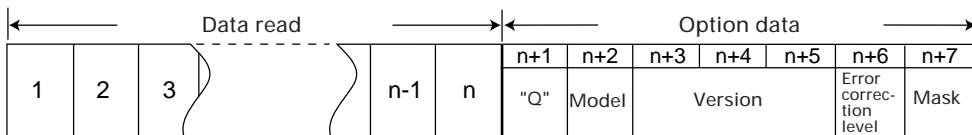

Example: If a code read is "QR code, Model 2, Version 5, Error correction level M, and mask number 6," then the option data below will follow.

(Data read)... Q2V05M6

• PDF417

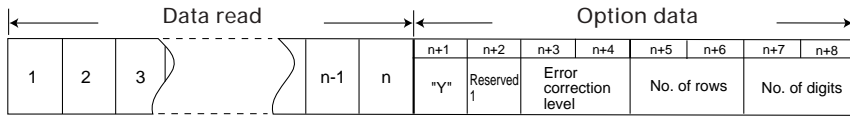

Example: If a code read is "PDF417, Error correction level 4, 12 rows and 2 digits," then the option data below will follow.

(Data read)... Y1041202

• MaxiCode

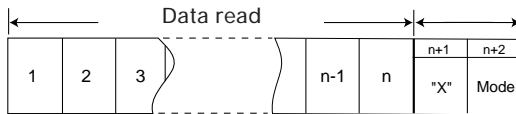

Example: If a code read is "MaxiCode and Mode 4," then the option data below will follow.

(Data read)... X4

• Data Matrix

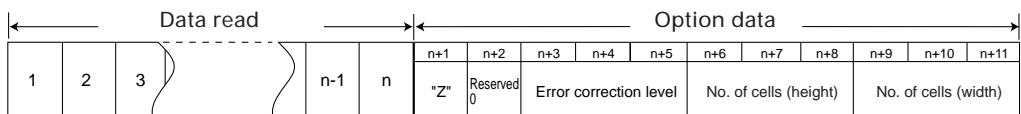

Example: If a code read is "Data Matrix, Error correction level ECC200, 10 cells wide by 10 cells high," then the option data below will follow.

(Data read)... Z0200010010

Minimum number of digits to be read for ITF or Codabar

You may set the minimum number of digits to be read for ITF and Codabar. Setting a small number of digits increases the frequency of digit-missing reading or misreading depending upon how to scan bar codes or the quality of bar codes. On the other hand, setting a large number will diminish the possibility of those errors.

The setting range is from 2 to 20 for ITF and from 3 to 20 for Codabar. The default is 4 for ITF and Codabar.

BHT-100B

SET BARCODE	
1: INVERT	ON OFF
2: DECODE LEVEL	x
3: MARKER	x
MINIMUM DIGITS	
4: ITF	xx
5: STF	xx
6: CODABAR	xx

Selecting "4: BARCODE" on the SET SYSTEM menu calls up the screen shown at left.

Highlighted is the current setting.

- 1 INVERT : Activates or deactivates the black-and-white inverted label reading function.
- 2 DECODE LEVEL : Sets the decode level.
- 3 MARKER : Sets the marker ON/OFF mode.
- 4 ITF : Sets the minimum number of digits to be read for ITF.
- 5 STF : Sets the minimum number of digits to be read for STF.
- 6 CODABAR : Sets the minimum number of digits to be read for Codabar.

Select a desired item by using the numerical keys or **M1** and **M2** keys, and then select a desired setting by using the **SF+M1** and **SF+M2** keys.

To increase the decode level, press the **SF+M2** keys; to decrease it, press the **SF+M1** keys.

To increase the number of digits to be read for ITF, STF and Codabar, press the **SF+M2** keys; to decrease it, press the **SF+M1** keys.

Press the **ENT** key.

To return to the SET SYSTEM menu, press the **C** key.

Black-and-white inverted label reading function (INVERT)

This function makes it possible to read white bars on a black background.

NOTE

Activating this function might increase the frequency of bar-code reading errors. This function can usually be set to OFF.

DECODE LEVEL

You may set the decode level. Decreasing the level value increases the bar-code reading efficiency, but the BHT might misread low-quality bar codes (split or stained). To the contrary, increasing the level value decreases the bar-code reading efficiency, but it will diminish the possibility of misreading.

The setting range of the level value is from 1 to 9 and the default is 4.

Marker

You may select the marker ON/OFF mode from the following:

- 0: Driven by the trigger switch
- 1: Fixed to ON
- 2: Fixed to OFF

NOTE

If you select "1" (Fixed to ON), the markers will keep ON so that power consumption is higher than that in other modes and the battery working time becomes short. Do not disturb this setting unless necessary.

Minimum number of digits to be read for ITF, STF, or Codabar

You may set the minimum number of digits to be read for ITF, STF, and Codabar. Setting a small number of digits increases the frequency of digit-missing reading or misreading depending upon how to scan bar codes or the quality of bar codes. On the other hand, setting a large number will diminish the possibility of those errors.

The setting range is from 2 to 20 for ITF, from 1 to 20 for STF, and from 3 to 20 for Codabar. The default is 4 for ITF and Codabar, and 2 for STF.

[4.5] Setting the communications environments

After the BHT is initialized, the interface port and communications parameters are set as listed in the default table below. Do not access them unless necessary.

Interface port	Optical (Optical interface port)
Communications protocol	BHT-protocol
Communications parameters for the optical interface port	Defaults
TRANSMIT SPEED	9600 bps
PROTOCOL (Protocol options)	SERIAL No.: ON (Adds serial numbers to data blocks.)
	H. PARITY: ON (Adds a horizontal parity.)
	LINKUP TIME: 30 seconds
	FIELD SPACE: Ignore

Listed below are the default communications parameters for the direct-connect interface.

Communications parameters for the direct-connect interface port	Defaults
TRANSMIT SPEED	19200 bps
PARITY BIT (Vertical parity)	None
DATA BIT (Character length)	8 bits
STOP BIT	1 bit
PROTOCOL (Protocol options)	SERIAL No.: ON (Adds serial numbers to data blocks.)
	H. PARITY: ON (Adds a horizontal parity.)
	LINKUP TIME: 30 seconds
	FIELD SPACE: Ignore

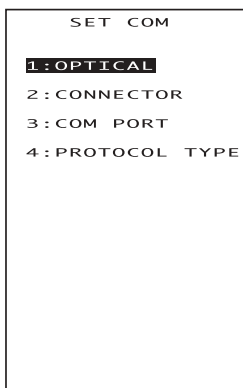

Selecting the "5: COM" on the SET SYSTEM menu calls up the screen shown at left.

- 1 OPTICAL: Switches to the communications parameters setting screen *for the optical interface*.
- 2 CONNECTOR: Switches to the communications parameters setting screen *for the direct-connect interface*.
- 3 COM PORT: Switches to the interface port setting screen.
- 4 PROTOCOL TYPE: Switches to the communications protocol type setting screen.

Select a desired screen by using the numerical keys or **M1** and **M2** keys, and then press the **ENT** key.

To return to the SET SYSTEM menu, press the **C** key.

[4.5-1] Setting the communications parameters for the optical interface

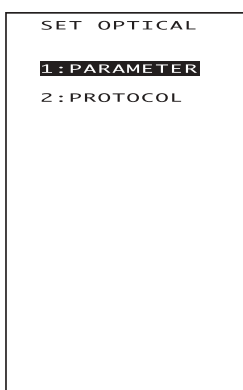

Selecting "1:OPTICAL" on the SET COM menu calls up the screen shown at left.

- 1 PARAMETER: Switches to the communications parameters setting screen.
- 2 PROTOCOL: Switches to the communications protocol option screen.

Select a desired screen by using the numerical keys or **M1** and **M2** keys, and then press the **ENT** key.

To return to the SET COM menu, press the **C** key.

(1) Communications parameters setting screen

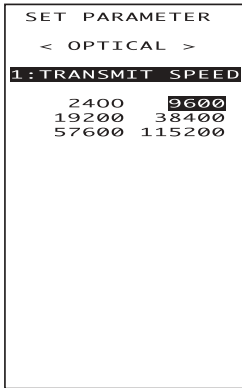

Selecting "1:PARAMETER" on the SET OPTICAL screen calls up the screen shown at left.

Highlighted is the current setting.

Select the desired transmission speed by using the numerical keys or **SF+M1** and **SF+M2** keys, and then press the **ENT** key.

To return to the SET OPTICAL screen, press the **C** key.

(2) Communications protocol option screen

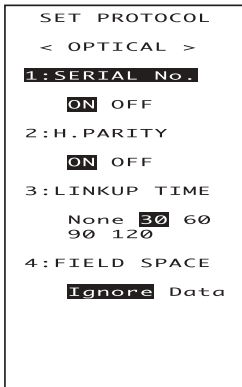

Selecting "2: PROTOCOL" on the SET OPTICAL screen calls up the screen shown at left.

Highlighted is the current setting.

- 1 SERIAL No.: Selects whether or not the system will add serial numbers to data blocks.
- 2 H. PARITY: Selects whether or not the system will add a horizontal parity.
- 3 LINKUP TIME: Selects the timeout length (in seconds) to be applied when a link is to be established.
- 4 FIELD SPACE: Selects whether space codes in the tail of a data field will be ignored or handled as data.

Select a desired item by using the numerical keys or **M1** and **M2** keys. Then select a desired setting by using the **SF+M1** and **SF+M2** keys.

To return to the SET OPTICAL screen, press the **C** key.

NOTE If the BHT-Ir protocol has been selected, the serial number and horizontal parity settings will be ignored.

[4.5-2] Setting the communications parameters for the direct-connect interface

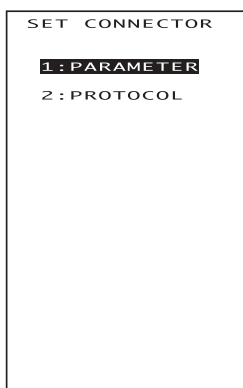

Selecting "2:CONNECTOR" on the SET COM menu calls up the screen shown at left.

- 1 PARAMETER: Switches to the communications parameters setting screen.
- 2 PROTOCOL: Switches to the communications protocol option screen.

Select a desired screen by using the numerical keys or **M1** and **M2** keys, and then press the **ENT** key.

To return to the SET COM menu, press the **C** key.

(1) Communications parameters setting screen

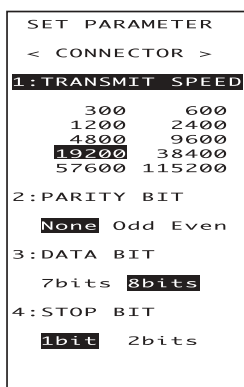

Selecting "1:PARAMETER" on the SET CONNECTOR screen calls up the screen shown at left.

Highlighted is the current setting.

- 1 TRANSMIT SPEED: Sets the transmission speed.
- 2 PARITY BIT: Sets the vertical parity: none, odd, or even.
- 3 DATA BIT: Sets the character length.
- 4 STOP BIT: Sets the stop bit length.

Select a desired item by using the numerical keys or **M1** and **M2** keys. Then select a desired setting by using the **SF+M1** and **SF+M2** keys.

To return to the SET CONNECTOR screen, press the **C** key.

NOTE

If the BHT-Ir protocol has been selected, the parity bit, character length, and stop bit length settings will be ignored.

(2) Communications protocol option screen

```

SET PROTOCOL
< CONNECTOR >
1: SERIAL No.
  ON OFF
2: H. PARITY
  ON OFF
3: LINKUP TIME
  None 30 60
  90 120
4: FIELD SPACE
  Ignore Data

```

Selecting "2:PROTOCOL" on the SET CONNECTOR screen calls up the screen shown at left.

Highlighted is the current setting.

- 1 SERIAL No.: Selects whether or not the system will add serial numbers to data blocks.
- 2 H. PARITY: Selects whether or not the system will add a horizontal parity.
- 3 LINKUP TIME: Selects the timeout length (in seconds) to be applied when a link is to be established.
- 4 FIELD SPACE: Selects whether space codes in the tail of a data field will be ignored or handled as data.

Select a desired item by using the numerical keys or M1 and M2 keys. Then select a desired setting by using the SF+M1 and SF+M2 keys.

To return to the SET CONNECTOR screen, press the C key.

NOTE

If the BHT-Ir protocol has been selected, the serial number and horizontal parity settings will be ignored.

[4.5-3] Setting the interface port

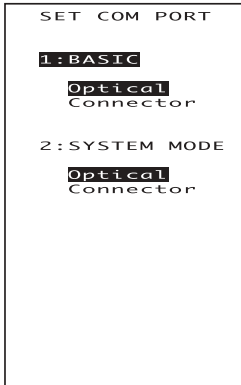

Selecting the "3:COM PORT" on the SET COM menu calls up the screen shown at left.

Highlighted is the current setting.

- 1 BASIC: Selects the optical or direct-connect interface port to be used *for user programs written in BHT-BASIC (OPEN "COM:").*
- 2 SYSTEM MODE: Selects the optical or direct-connect interface port to be used *for downloading or uploading files in System Mode.*

Select a desired item by using the numerical keys or **M1** and **M2** keys, and then select a desired setting by using the **SF+M1** and **SF+M2** keys.

To return to the SET COM menu, press the **C** key.

[4.5-4] Setting the communications protocol type

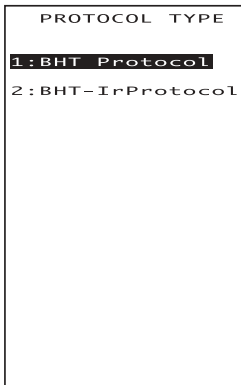

Selecting the "4:PROTOCOL TYPE" on the SET COM menu calls up the screen shown at left.

Highlighted is the current setting.

1 BHT Protocol: Selects the BHT-protocol for downloading or uploading files in System Mode or for the execution of XFILE statement in BHT-BASIC.

This protocol should be selected for file transmission with Transfer Utility.

2 BHT-Ir Protocol: Selects the BHT-Ir protocol for downloading or uploading files in System Mode or for the execution of XFILE statement in BHT-BASIC.

This protocol should be selected for file transmission with Ir-Transfer Utility C/Ir-Transfer Utility E.

Select a desired item by using the numerical keys or **M1** and **M2** keys, and then press the **ENT** key.

To return to the SET COM menu, press the **C** key.

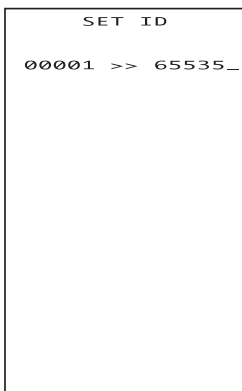
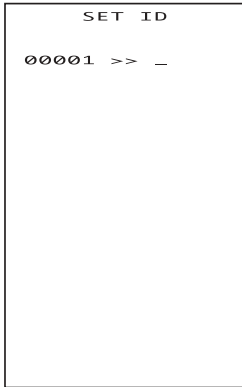

Selecting the "2:BHT-Ir Protocol" on the PROTOCOL TYPE screen calls up the screen shown at left.

Enter the ID number of the BHT by using the numerical keys, and then press the **ENT** key. If you do not need to modify the current setting, press the **ENT** key only.

NOTE

An ID number should be five-digit decimal character string. The entry range is from 00001 to 65535. If the entry value is less than five digits, the **ENT** key will be deactivated.

If you make a wrong entry, press the **BS** key to delete it and then enter the correct data.

To return to the SET COM menu, press the **C** key.

[4.6] Defining the functions of the shift key, magic keys, and function keys

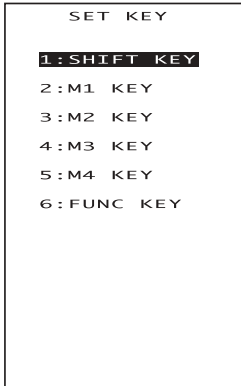

Selecting the "6:KEY" on the SET SYSTEM menu calls up the screen shown at left.

Highlighted is the current setting.

- 1 SHIFT KEY: Switches to the shift key definition screen.
- 2 M1 KEY: Switches to the M1 key definition screen.
- 3 M2 KEY: Switches to the M2 key definition screen.
- 4 M3 KEY: Switches to the M3 key (left-hand trigger switch) definition screen.
- 5 M4 KEY: Switches to the M4 key (right-hand trigger switch) definition screen.
- 6 FUNC KEY: Switches to the function key ON/OFF screen.

Select a desired screen by using the numerical keys or **M1** and **M2** keys, and then press the **ENT** key.

To return to the SET SYSTEM menu, press the **C** key.

Defining the function of the shift key

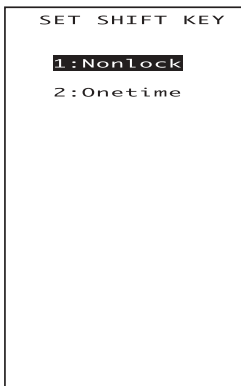

Selecting the "1:SHIFT KEY" on the SET KEY menu calls up the screen shown at left.

Highlighted is the current setting.

- 1 Nonlock: Shifts the keypad only when the **SF** key is held down.
- 2 Onetime: Shifts only one key pressed immediately after the **SF** key is pressed. (The following keys will not be shifted.)

Select a desired setting by using the numerical keys or **M1** and **M2** keys, and then press the **ENT** key. The screen returns to the SET KEY menu.

Defining the function of **M1**, **M2**, **M3** (left-hand trigger switch), or **M4** (right-hand trigger switch) key

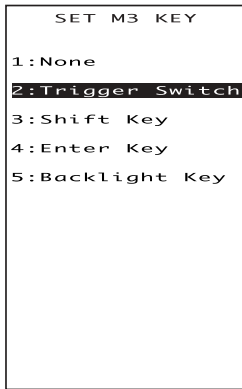

Selecting the "2:M1 KEY," "3:M2 KEY," "4:M3 KEY" or "5:M4 KEY" on the SET KEY menu calls up the screen as shown at left. (This example appears when the "4:M3 KEY" is selected.)

Highlighted is the current setting.

The **M1**, **M2**, **M3** or **M4** key can function as listed below.

- 1 None: The key entry will be ignored.
- 2 Trigger Switch: As the trigger switch.
- 3 Shift Key: As the **SF** key.
- 4 Enter Key: As the **ENT** key.
- 5 Backlight Key: As the backlight function on/off key.

Select a desired setting by using the numerical keys or **M1** and **M2** keys, and then press the **ENT** key. The screen returns to the SET KEY menu.

The **M3** and **M4** keys are assigned the trigger switch function by default. You can make them function as the **SF** key, **ENT** key, or backlight function on/off key.

If you define the **M4** key as the backlight function on/off key, pressing the **M4** key activates or deactivates the backlight function.

In user programs, a string data can also be assigned to these magic keys.

NOTE The backlight function on/off key can be assigned only to any one of **M1** through **M4** keys. The key defined more recently will act as the backlight function on/off key and one defined earlier will be ignored.

That is, if you define the **M1** and **M2** keys as the backlight function on/off key in this order, the **M2** key will work as the backlight function on/off key and the **M1** key's entry will be ignored.

Enabling/disabling the function keys

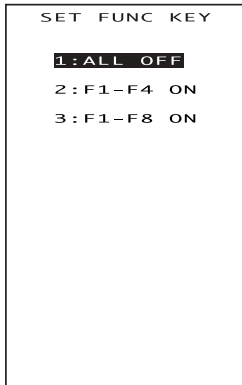

Selecting the "6:FUNC KEY" on the SET KEY menu calls up the screen shown at left.

Highlighted is the current setting.

- 1 ALL OFF Disables all function keys.
- 2 F1-F4 ON Enables four function keys F1 through F4.
- 3 F1-F8 ON Enables all of the eight function keys F1 through F8.

Select a desired setting by using the numerical keys or **M1** and **M2** keys, and then press the **ENT** key. The screen returns to the SET KEY menu.

Display positions of function keys

(When "2:F1-F4 ON" is selected)



(When "3:F1-F8 ON" is selected)

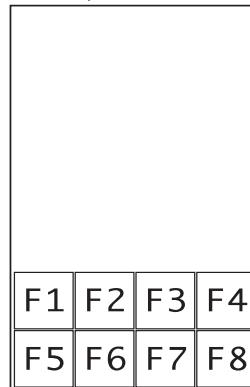

TIP

- Even if enabled in the above setting, these function keys will not work in System Mode.
- If the screen scrolls, no function keys will move.

[4.7] Setting the resume function

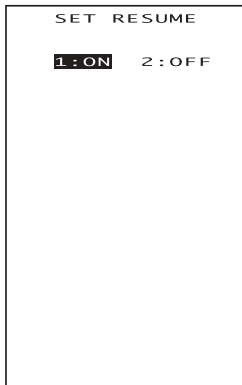

Selecting "7: RESUME" on the SET SYSTEM menu calls up the screen shown at left.

Highlighted is the current setting.

1 ON : Activates the resume function which resumes the current BHT status when the BHT power was turned off, when the BHT is switched on.

2 OFF : Deactivates the resume function.

Select a desired item by using the numerical keys or **M1** and **M2** keys, and then press the **ENT** key.

To return to the SET SYSTEM menu, press the **C** key.

[5] Testing

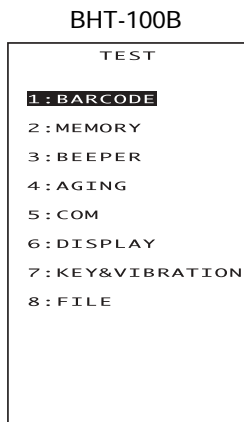
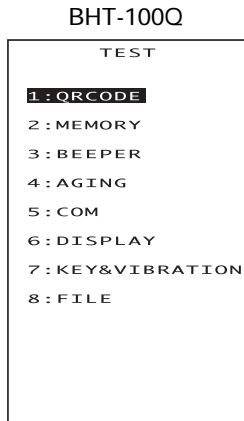

Selecting "5:TEST" on the SYSTEM MENU calls up the screen shown at left.

1 QR CODE : Selects the 2D-code & bar-code reading test.
(BHT-100Q)

BARCODE : Selects the bar-code reading test.
(BHT-100B)

2 MEMORY : Selects the RAM read/write test.

3 BEEPER : Selects the beeper scale test.

4 AGING : Selects the aging test.

5 COM : Selects the communications test.

6 LCD : Selects the LCD, indicator LED, and touch screen tests.

7 KEY & VIBRATION : Selects the key entry, beeper, and vibrator tests.

8 FILE : Selects the file checksum test.

Select a desired setting by using the numerical keys or **M1** and **M2** keys, and then press the **ENT** key. The selected test will start.

Highlighted is the currently selected item.

To return to the SYSTEM MENU, press the **C** key.

NOTE

If an error occurs in any of the above tests, contact your nearest dealer.

[5.1] 2D-code and bar-code reading test

BHT-100Q

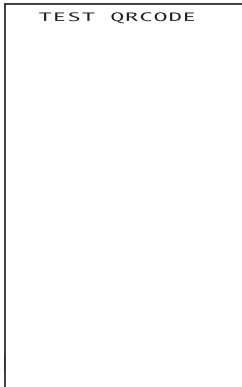

Selecting "1: QRCODE" on the TEST menu calls up the screen shown at left.

Actually read bar codes with the BHT-100Q and check the read data displayed on the LCD.



Sample-1

Number of digits of the code
Code type

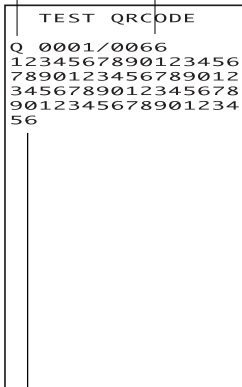

Upon completion of 2D-code & bar-code reading, the BHT-100Q beeps, turns on the indicator LED in green, and displays the read data together with the code type and the number of data digits.

If the read data is a 2D code containing the small number of digits or a bar code, it will display as shown in Sample-1.

Data read

Sample-2

Code type



If the read data is a 2D code containing the large number of digits, all data may not display on a single screen. You may scroll the screen, line by line or page by page, by using the **M1** and **M2** keys or **SF+M1** and **SF+M2** keys, respectively.

xxxx : Shows that this page starts with this digit of the read data.

□□□□ : Shows the total number of digits of the read code.

Listed below is a table showing the relationship between the 2D-code/bar-code types and the identifier letters to be displayed on the LCD.

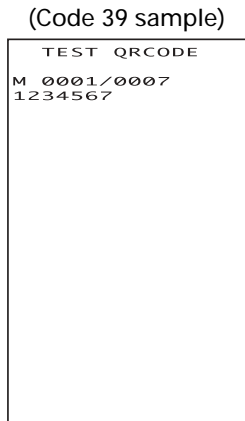

Code Type	ID Letters
QR Code	Q
PDF417	Y
MaxiCode	X
Data Matrix	Z
EAN-13, UPC-A	A
EAN-8	B
UPC-E	C
Interleaved 2of5 (ITF)*	I
Codabar (NW-7)*	N
Code 39	M
Code 128	K
EAN-128	W

* The minimum number of digits to be read depends on the scanning parameter setting. (Refer to [4.4].)

To return to the TEST menu, press the **C** key.

TIP

- The "QR Code" system supports a split QR code feature ("Structured Append") which can divide data in a QR code into a maximum of 16 blocks and encode each of them into a split QR code.

When reading split QR codes, the BHT-100Q beeps in a different way from usual. That is, when the BHT-100Q reads the first split code, it beeps twice and enters the split code scanning mode. After that, each time it reads the subsequent split code, it beeps once. If the BHT-100Q reads the last split code, it beeps three times and completes the sequence of split code scanning.

The scanned data will not be displayed on the LCD until a sequence of split code scanning is completed.

If you scan any non-split code midway in a sequence of split code scanning, the BHT-100Q displays the scanned non-split code, cancels the split code scanning mode, and discards those split codes being scanned. The same occurs also if you release the trigger switch or the split code scanning interval exceeds approx. 5 seconds.

The scanning order of split codes is arbitrary. The same split code will never be double-scanned.

- If the OPTION DATA is set to ON on the SET QR CODE screen in the SET SYSTEM menu (see [4.4] Setting the special scanning parameters), then the option data will follow QR code data read.

BHT-100B

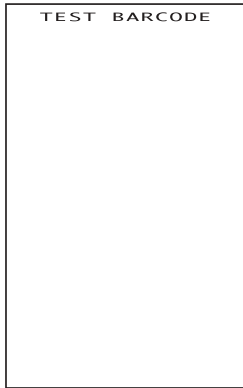

Bar-code type

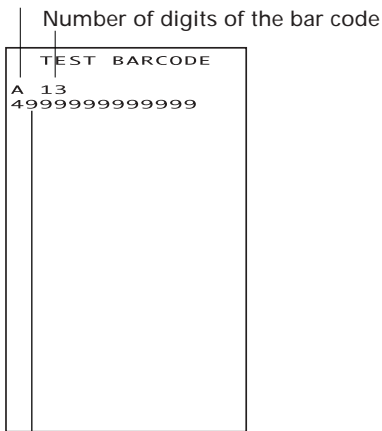

Data

Selecting "1: BARCODE" on the TEST menu calls up the screen shown at left.

Actually read bar codes with the BHT-100B and check the read data displayed on the LCD.

Upon completion of bar-code reading, the BHT-100B beeps, turns on the indicator LED in green, and displays the read data together with the bar-code type and the number of data digits.

To return to the TEST menu, press the **C** key.

Listed below is a table showing the relationship between the bar-code types and the identifier letters to be displayed on the LCD.

Bar-code Type	ID Letters
EAN-13, UPC-A	A
EAN-8	B
UPC-E	C
Standard 2of5 (STF)*	H
Interleaved 2of5 (ITF)*	I
Codabar (NW-7)*	N
Code 39	M
Code 93	L
Code 128	K
EAN-128	W

* The minimum number of digits to be read depends on the scanning parameter setting. (Refer to [4.4].)

[5.2] Memory test

```

TEST MEMORY

** Testing **
XXXXX/YYYYY

```

Selecting "2:MEMORY" on the TEST menu calls up the screen shown at left, and then starts writing and reading onto/from all areas of the RAM as well as checking the address.

XXXXX: Tested RAM capacity (in kilobytes)

YYYYY: Total RAM capacity (in kilobytes)

```

TEST MEMORY

** Test NG **
XXXXX/YYYYY
Address: zzzzzzzz
Write: aaaaaaaaa
Read: bbbbbbbb

```

If any error is detected, the BHT beeps three times, shows the message as shown at left, and terminates the test.

Where,

zzzzzzzz: Address where an error has occurred.

aaaaaaaa: Data to write.

bbbbbbbb: Data read out from the RAM.

To return to the TEST menu, press the **C** key.

```

TEST MEMORY

** Test OK **
YYYYY/YYYYY

```

Upon normal completion of the RAM test, the BHT beeps once, shows the message as shown at left, and returns to the TEST menu.

[5.3] Beeper scale test

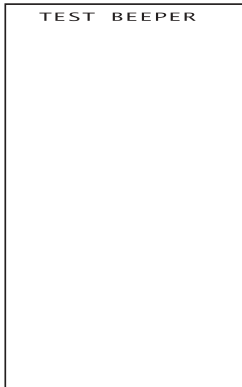

Selecting "3:BEEPER" on the TEST menu calls up the screen shown at left and makes the beeper sound at three octaves listed below.

Upon completion of this test, the BHT automatically returns to the TEST menu.

To stop this test while in progress, turn the power off and on.

Scale	Frequency (Hz)			
do	523	1046	2093	4186
re	587	1174	2349	-
mi	659	1318	2637	-
fa	698	1396	2793	-
sol	783	1567	3135	-
la	880	1760	3520	-
ti	987	1975	3951	-

[5.4] Aging test

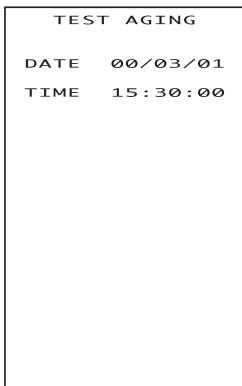

Selecting "4:AGING" on the TEST menu proceeds to the aging test while showing the current date and time on the LCD. (This test is intended for personnel which check the BHT in the factory.)

NOTE

Once this test is selected, the automatic powering-off function becomes disabled. Be sure to turn the power off or press the **C** key to return to the TEST menu.

[5.5] Communications test

In System Mode, you may test the optical interface port and direct-connect interface port.

■ Preparation for the optical interface test

Arrange two BHTs, one as a master station and the other as a slave station (to be tested) with their IR ports facing each other as illustrated below. In this test, the slave BHT transmits data to the master BHT and receives the data sent back from the master BHT.

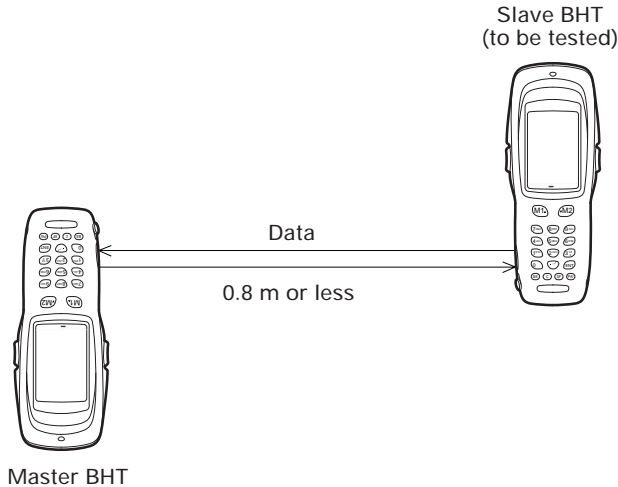

■ Preparation for the direct-connect interface test

Arrange the 3-pole mini stereo plug as illustrated below and connect it to the direct-connect interface port on the BHT.

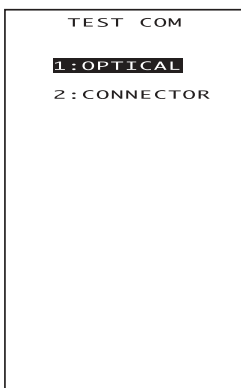
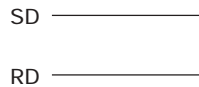

Selecting the "5:COM" on the TEST menu calls up the screen shown at left.

- 1 OPTICAL : Switches to the MASTER/SLAVE selection screen for the optical interface test.
- 2 CONNECTOR : Tests the direct-connect interface port.

Select a desired item by using the numerical keys or M1 and M2 keys, then press the ENT key.

Testing the optical interface port

```
TEST COM
< OPTICAL >

1: SLAVE
2: MASTER
```

Selecting the "1:OPTICAL" on the TEST COM menu calls up the screen shown at left.

At the slave BHT to be tested, select the "1:SLAVE" and at the master BHT, select the "2:MASTER." Then press the **ENT** key on each BHT.

```
TEST COM
< OPTICAL >

** Testing **
```

During the test, the screen shown at left is displayed.

```
TEST COM
< OPTICAL >

** Test NG **
  (xx)
```

If any error occurs, the tested slave BHT beeps three times and shows the screen at left.

In parentheses are error codes which have the following meanings:

(X X)

- 1: The received data is different from the sent data.
- 2: A timeout has occurred during standby for data reception.

- 1: 2400 bps
- 2: 9600 bps
- 3: 115200 bps

Press the **C** key to return to the MASTER/SLAVE selection menu.

The master BHT will automatically return to the MASTER/SLAVE selection menu after 10 seconds from the occurrence of an error.

```

TEST COM
< OPTICAL >

** Test OK **
    
```

Upon normal completion of the test, the tested slave BHT beeps once and shows the screen at left.

Press the **C** key to return to the TEST COM menu.

The master BHT will automatically return to the MASTER/SLAVE selection menu.

Testing the direct-connect interface port

```

TEST COM
< CONNECTOR >

** Testing **
    
```

Selecting the "2:CONNECTOR" on the TEST COM menu displays the screen shown at left and then starts testing the direct-connect interface port.

```

TEST COM
< CONNECTOR >

** Test NG **
  (xx)
    
```

If any error occurs, the BHT beeps three times and shows the screen at left.

In parentheses are error codes which have the following meanings:

(X X)

- 1: The received data is different from the sent data.
 - 2: A timeout has occurred during standby for data reception.
- 1: 300 bps
2: 115200 bps

```
TEST COM
< CONNECTOR >

** Test OK **
```

Upon normal completion of the test, the BHT beeps once and shows the screen at left.

Press the C key to return to the TEST COM menu.

[5.6] LCD, indicator LED, and touch screen tests

In System Mode, you may test the LCD, indicator LED, and touch screen.

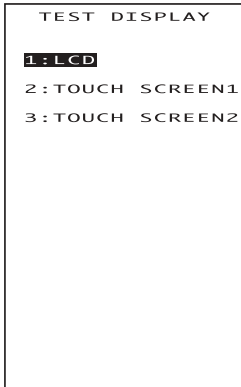

Selecting "6:LCD" on the TEST menu calls up the screen shown at left on the LCD.

- 1 LCD: Tests the LCD and indicator LED.
- 2 TOUCH SCREEN1: Tests touch-keys.
- 3 TOUCH SCREEN2: Tests the graphics pad box by drawing an image with the stylus.

Select a desired item by using the numerical keys or **M1** and **M2** keys, then press the **ENT** key.

LCD & indicator LED test

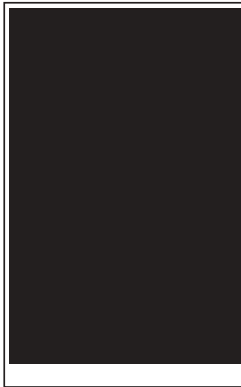

Selecting "1:LCD" on the TEST DISPLAY menu calls up the test pattern shown at left on the LCD and turns on the indicator LED in green.

Each time the **ENT** key is pressed, the screen shifts to the next test pattern. To return to the previous screen, press the **BS** key.

To stop this test while in progress, press the **C** key.

BS key ↑ ↓ ENT key

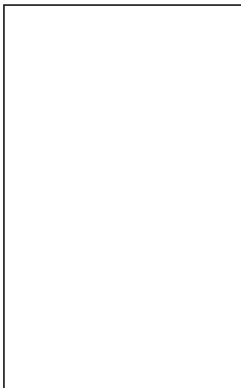

As shown at left, everything disappear and the indicator LED lights in red.

BS key ↑ ↓ ENT key

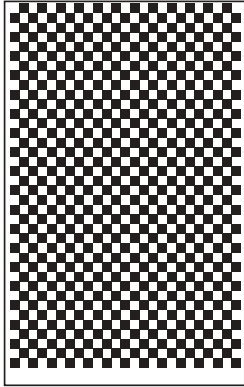

The checker pattern shown at left appears and the indicator LED goes off.

BS key ↑ ↓ ENT key

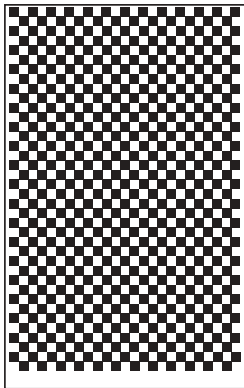

The checker pattern is reversed.

BS key ↑ ↓ ENT key

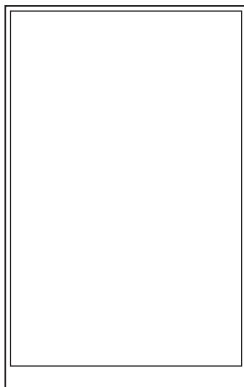

An outline with a width of one dot appears.

BS key ↑ ↓ ENT key

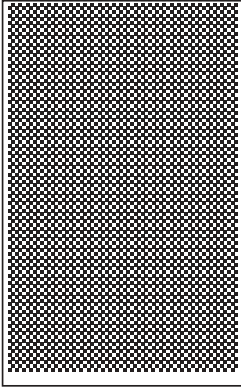

The fine checker pattern appears.

BS key ↑ ↓ ENT key

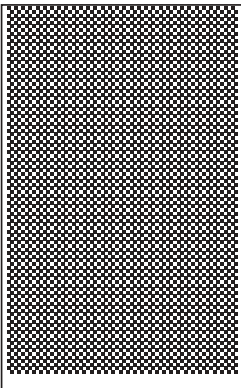

The fine checker pattern is reversed.

BS key ↑ ↓ ENT key

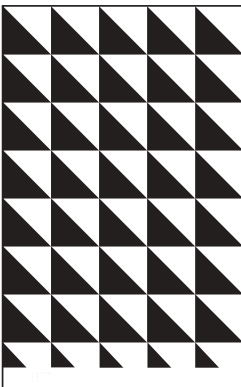

Forty right-angled triangles appear.

BS key ↑ ↓ ENT key

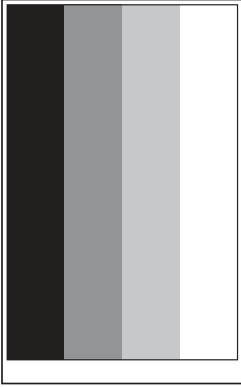

BS key ↑ ↓ ENT key

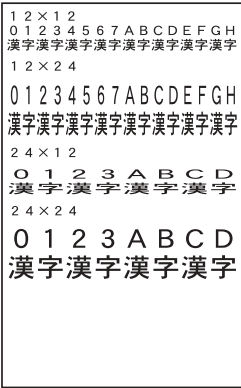

BS key ↑ ↓ ENT key

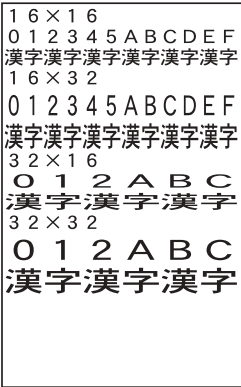

BS key ↑ ↓ ENT key

Press the ENT key, and the BHT beeps once and returns to the TEST DISPLAY menu.

Touch screen test 1

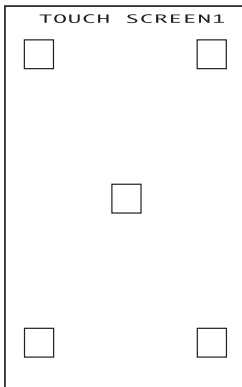

Selecting "2:TOUCH SCREEN1" on the TEST DISPLAY menu calls up the screen shown at left.

Press individual touch-keys (□) on the LCD. When each of them is pressed, the beeper will sound and the key will become highlighted (■). Pressing the highlighted key again will cancel highlighting (□).

Pressing all five touch-keys (highlighting all) or C key will return to the TEST DISPLAY menu.

Touch screen test 2

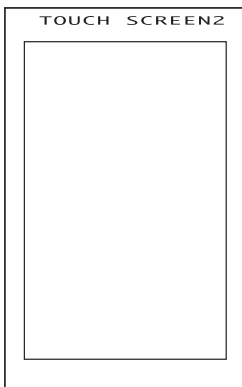

Selecting "3:TOUCH SCREEN2" on the TEST DISPLAY menu calls up the screen shown at left.

You may draw an image with the stylus in the box (graphics pad box) shown at left.

Press the C key to return to the TEST DISPLAY menu.

[5.7] Key entry, beeper, and vibrator test

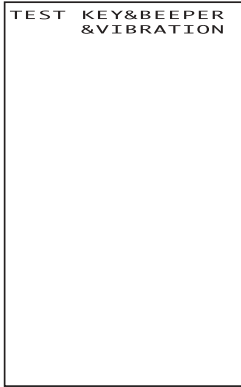

Selecting "7:KEY & VIBRATION" on the TEST menu calls up the screen shown at left and makes the BHT ready for entry from the keypad.

Pressing individual keys displays the identifier letters in the positions pre-assigned to those keys on the LCD as well as sounding the beeper or running the vibrator. (As long as the individual key is held down, the BHT continues beeping or vibrating.)

Pressing the same key again erases the displayed letter.

The table below shows the relationship between the keys, the identifier letters to be displayed on the LCD, and the frequencies (Hz) of the beeper.

Key	Letter	Beeper (Hz)	Key	Letter	Beeper (Hz)
M3	F	(Note)	1	1	698
M1	D	293	2	2	783
M2	E	329	3	3	880
M4	G	(Note)	0	0	987
7	7	391	.	.	1046
8	8	440	ENT	=	1174
9	9	493	BS	A	1318
4	4	523	C	B	1396
5	5	587	SF	C	1567
6	6	659			

(Note) Only when the **M3** (left-hand trigger switch) or **M4** key (right-hand trigger switch) is pressed, the vibrator works.

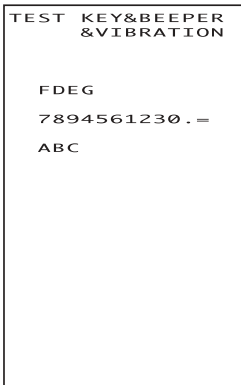

After all keys are pressed and displayed on the LCD, this test automatically ends and the screen returns to the TEST menu.

To stop this test, turn the power off.

[5.8] File test

```

TEST FILE
SAMPLE01.PD3
*SAMPLE02.PD3
SAMPLE03.PD3
SAMPLE04.PD3
+SAMPLE05.PD3
SAMPLE06.PD3
SAMPLE07.PD3
SAMPLE08.PD3
SAMPLE09.PD3
SAMPLE10.PD3
SAMPLE11.PD3
SAMPLE12.PD3
SAMPLE13.PD3
SAMPLE14.PD3
SAMPLE15.PD3
SAMPLE16.PD3
SAMPLE17.PD3
SAMPLE18.PD3
SAMPLE19.PD3
SAMPLE20.PD3

SIZE:bbbbbb
FREE:yyyyyy
    
```

Selecting "8:FILE" on the TEST menu calls up the screen shown at left.

If any of the files stored in the memory is defective, an asterisk (*) or plus sign (+) will be prefixed to the defective file name(s). For details about the (*) and (+), refer to Subsection 2.3.6, [3].

Selecting a file on this screen will show the file size and the test result.

To select a file, use the **M1** and **M2** keys to move the cursor to the desired file. If there are more than 20 files, the screen will scroll.

Highlighted is the currently selected file.

Press the **C** key to return to the TEST menu.

```

TEST FILE

SAMPLE01.PD3
00004096 bytes
OK

SIZE:bbbbbb
FREE:yyyyyy
    
```

The file name, file size, and test result (OK or NG) appear as shown at left.

```

TEST FILE

SAMPLE01.PD3
00004096 bytes
NG

SIZE:bbbbbb
FREE:yyyyyy
    
```

Press the **C** key to return to the file selection screen.

NOTE

If a defective file is found, delete it or overwrite it with the same name file.

Even defective, the file can be uploaded on the **UPLOAD** menu. It is, therefore, recommended that important files be uploaded before deleted.

[6] System Information

```
SYSTEM INFO
SYS Ver. : x.xx
ROM SIZE:  xMB
RAM SIZE:  xMB
SYS MESSAGE:
Japanese  x.xx
FONT:
JIS2(16)  x.xx
JIS1(16)  x.xx
JIS2(12)  x.xx
JIS1(12)  x.xx
```

Selecting the "6:VERSION" on the SYSTEM MENU calls up the screen shown at left, displaying the system program version, memory sizes, system message version, and JIS font types and their versions.

Press the C key to return to the SYSTEM MENU.

The following font types are displayed:

JIS2 (16):	JIS Level 2 font, 16-dot
JIS1 (16):	JIS Level 1 font, 16-dot
JIS2 (12):	JIS Level 2 font, 12-dot
JIS1 (12):	JIS Level 1 font, 12-dot

```
DELETE FILE
XXXXXXXXX.XXX
** Working **
```



Deletion completion screen

```
DELETE FILE
** Completed **
```

When deletion is in progress, the screen shown at left is displayed.

Upon completion of deletion, the screen shown at left appears.

Press the **C** key to return to the file deletion menu.

[8] Downloading/Uploading the BHT System Parameter File

The BHT system parameter file (named "_BHT.SYS") stores system environment settings specified in the SET SYSTEM menu (in Subsection 2.5.3, [4]) and other settings such as the LCD contrast and beeper volume.

The SYSTEM PARAMETER transfer menu allows you to upload or download the BHT system parameter file to/from the host computer. This helps you make the same settings for the BHTs as those made in a single BHT.

First, make settings in a particular BHT and upload the BHT system parameter file to the host computer by using this menu ("2:UPLOAD"). Next, let other BHTs download the file from the host computer by using this menu ("1:DOWNLOAD").

TIP

Without the host computer, you may directly copy the BHT system parameter file between two BHTs (one BHT runs UPLOAD and the other, DOWNLOAD). For the preparation to be made beforehand, refer to NOTE on page 47.

If you select the "2:UPLOAD," the system will set up the BHT system parameter file based on the current settings and upload it to the host computer. After that, the created file will be deleted.

If you select the "1:DOWNLOAD," the BHT will receive the BHT system parameter file from the host computer and apply the stored values. After that, the received file will be deleted.

For uploading/downloading, the BHT will use the communications parameters, communications protocol, and interface port specified in Subsection 2.5.3, "[4.5] Setting the communications environments."

SYSTEM PARAMETER transfer menu

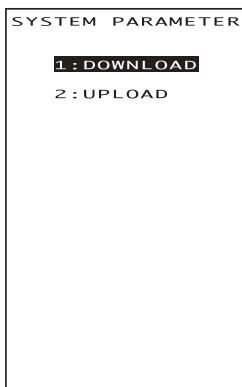

Pressing the **3** key while holding down the **SF** key on the SYSTEM MENU calls up the screen shown at left.

1 DOWNLOAD: Downloads the BHT system parameter file to the user area of the BHT.

2 UPLOAD: Uploads the BHT system parameter file stored in the BHT.

Select a desired item by using the numerical keys or **M1** and **M2** keys, then press the **ENT** key.

Press the **C** key to return to the SYSTEM MENU.

[8.1] Downloading the BHT system parameter file

```
DOWNLOAD
** Waiting **
```



```
DOWNLOAD
__BHT.SYS
** Loading **
YYYYY/ZZZZZ
```



```
DOWNLOAD
__BHT.SYS
** Completed **
```

Selecting "1:DOWNLOAD" on the SYSTEM PARAMETER transfer menu calls up the screen shown at left. With this screen displayed, the BHT waits for the BHT system parameter file to be downloaded.

While the downloading operation is in progress, the screen shown at left is displayed indicating the file name and the number of received records/the total number of records.

To abort the downloading operation, press the **C** key. The screen will switch back to the SYSTEM PARAMETER transfer menu.

Upon completion of downloading, the BHT displays the screen shown at left and beeps once.

Press the **C** key to return to the SYSTEM PARAMETER transfer menu.

If an error occurs during downloading

If some error occurs during downloading, the BHT beeps three times and shows one of the following screens with the prompt "Retry?":

To retry the download, press the **1** and **ENT** keys; to abort it, press the **2** and **ENT** keys.

To return to the SYSTEM PARAMETER transfer menu, press the **C** key.

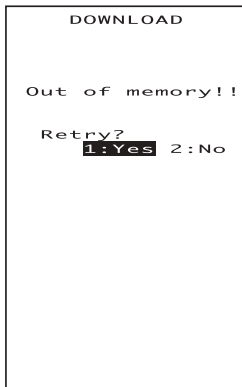

■ Problem

The memory is insufficient for storing the BHT system parameter file to be downloaded.

■ Solution

Press the **2** key to return to the SYSTEM MENU, then delete unnecessary files in the memory. (Refer to Subsection 2.5.3, [7].)



■ Problem

You attempted to download a file other than the BHT system parameter file.

■ Solution

Check whether the file you attempted to download is a BHT system parameter file.

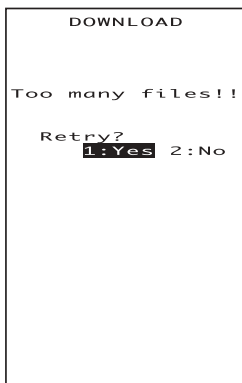

■ Problem

The current download will exceed the maximum of 80 files in the memory.

■ Solution

Press the **2** key to return to the SYSTEM MENU, then delete unnecessary files in the memory. (Refer to Subsection 2.5.3, [7].)

```
DOWNLOAD
__BHT.SYS
Communication
error!!
Retry?
1:Yes 2:No
```

■ Problem

Downloading has failed.

■ Solution

To retry downloading, press the 1 key.

Pressing the 2 key returns to the SYSTEM MENU. Check the interface port, communications parameters, and communications protocol type in the SET SYSTEM menu or perform the communications test in the TEST menu. (Refer to Subsection 2.5.3, [4.5] and [5.5].)

It is also necessary to check the communications parameters setup of the host computer.

[8.2] Uploading the BHT system parameter file

```
UPLOAD
** Waiting **
```

Selecting "2:UPLOAD" on the SYSTEM PARAMETER transfer menu calls up the screen shown at left. With this screen displayed, the BHT waits for the BHT system parameter file to be uploaded.



```
UPLOAD
__BHT.SYS
** Loading **
00000/00000
```

While the uploading operation is in progress, the screen shown at left is displayed indicating the file name and the number of sent records/the total number of records.

To abort the uploading operation, press the C key. The screen will switch back to the SYSTEM PARAMETER transfer menu.

⇓

```

UPLOAD
  __BHT.SYS
** Completed **

```

Upon completion of uploading, the BHT displays the screen shown at left and beeps once.

Press the **C** key to return to the SYSTEM PARAMETER transfer menu.

If an error occurs during uploading

If some error occurs during uploading, one of the following screens will appear and the beeper beeps three times.

To retry the uploading operation, press the **1** and **ENT** keys; to abort it, press the **2** and **ENT** keys.

Press the **C** key to return to the SYSTEM PARAMETER transfer menu.

```

UPLOAD
  __BHT.SYS
File error!!
Upload?
  1:Yes  2:No

```

■ Problem

The file you attempted to upload is broken.

■ Solution

To upload the broken file as is, press the **1** key.

```

UPLOAD
Out of memory!!

```

■ Problem

The memory is insufficient for setting up the BHT system parameter file to be uploaded.

■ Solution

Press the **C** key to return to the SYSTEM MENU, then delete unnecessary files in the memory. (Refer to Subsection 2.5.3, [7].

```
UPLOAD
Too many files!!
```

■ Problem

The memory has already contained 80 files, so the BHT system parameter file cannot be set up.

■ Solution

Press the **C** key to return to the SYSTEM MENU, then delete unnecessary files in the memory. (Refer to Subsection 2.5.3, [7].)

```
UPLOAD
__BHT.SYS
Communication
error!!
Retry?
 1:Yes 2:No
```

■ Problem

Uploading has failed.

■ Solution

To retry uploading, press the **1** key.

Pressing the **2** key returns to the SYSTEM MENU. Check the interface port, communications parameters, and communications protocol type in the SET SYSTEM menu or perform the communications test in the TEST menu. (Refer to Subsection 2.5.3, [4.5] and [5.5].)

It is also necessary to check the communications parameters setup of the host computer.

[9] Setting the Remote Wakeup

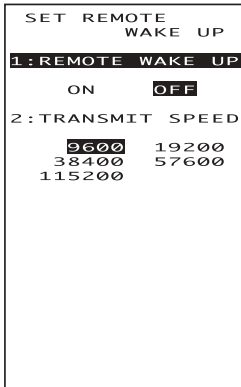

Pressing the **4** key while holding down the **SF** key on the SYSTEM MENU calls up the screen shown at left.

- 1 REMOTE WAKEUP: Activates or deactivates the remote wakeup function.
- 2 TRANSMIT SPEED: Sets the transmission speed for the remote wakeup.

Select a desired item by using the numerical keys or **M1** and **M2** keys. Then select a desired setting by using the **SF+M1** and **SF+M2** keys.

To return to the SYSTEM MENU, press the **C** key.

[10] Downloading/Uploading the System Message File

The system message file (named "__SYSMSG.FN2") stores system messages, e.g., "Shutdown in progress. Do not remove the battery." and "Charge the battery!."

The SYSTEM MESSAGE transfer menu allows you to upload or download the system message file to/from the host computer.

If you select the "2:UPLOAD," the system will set up the system message file based on the current settings and upload it to the host computer. After that, the created file will be deleted.

If you select the "1:DOWNLOAD," the BHT will receive the system message file from the host computer and apply the stored messages. After that, the received file will be deleted.

For uploading/downloading, the BHT will use the communications parameters, communications protocol, and interface port specified in Subsection 2.5.3, "[4.5] Setting the communications environments."



Usually you do not need to use this SYSTEM MESSAGE transfer menu since system messages have been set at the time of delivery from the factory.

SYSTEM MESSAGE
transfer menu

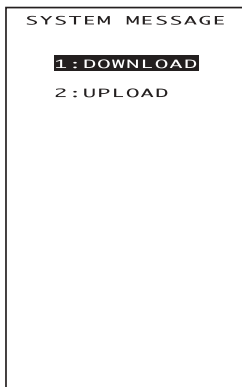

Pressing the **6** key while holding down the **SF** key on the SYSTEM MENU calls up the screen shown at left.

1 DOWNLOAD: Downloads the system message file to the user area of the BHT.

2 UPLOAD: Uploads the system message file stored in the BHT.

Select a desired item by using the numerical keys or **M1** and **M2** keys, then press the **ENT** key.

Press the **C** key to return to the SYSTEM MENU.

[10.1] Downloading the system message file

```

DOWNLOAD
** Waiting **

```



```

DOWNLOAD
  _SYSMSG.FN3
** Loading **
YYYYY/ZZZZ

```



```

DOWNLOAD
  _SYSMSG.FN3
** Completed **

```

Selecting "1:DOWNLOAD" on the SYSTEM MESSAGE transfer menu calls up the screen shown at left. With this screen displayed, the BHT waits for the system message file to be downloaded.

While the downloading operation is in progress, the screen shown at left is displayed indicating the file name and the number of received records/the total number of records.

To abort the downloading operation, press the **C** key. The screen will switch back to the SYSTEM MESSAGE transfer menu.

Upon completion of downloading, the BHT displays the screen shown at left and beeps once.

Press the **C** key to return to the SYSTEM MESSAGE transfer menu.

NOTE

When the BHT downloads the system message file, it creates a temporary file named "_SYSMSG.FN3" in the user area. If the user area is insufficient for creating the temporary file, therefore, an error will result.

The created temporary file will be automatically deleted after completion of downloading.

If an error occurs during downloading

If some error occurs during downloading, the BHT beeps three times and shows one of the following screens with the prompt "Retry?":

To retry the download, press the **1** and **ENT** keys; to abort it, press the **2** and **ENT** keys.

To return to the SYSTEM MESSAGE transfer menu, press the **C** key.

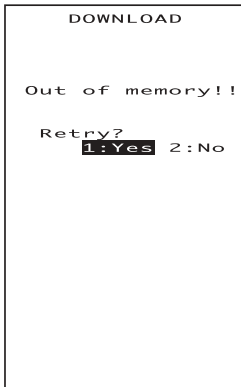

■ Problem

The memory is insufficient for storing the system message file to be downloaded.

■ Solution

Press the **2** key to return to the SYSTEM MENU, then delete unnecessary files in the memory. (Refer to Subsection 2.5.3, [7].)



■ Problem

You attempted to download a file other than the system message file.

■ Solution

Check whether the file you attempted to download is a system message file.

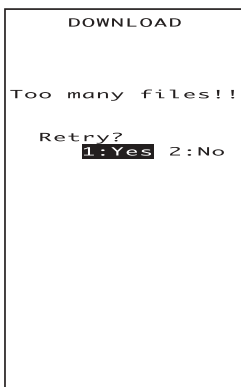

■ Problem

The current download will exceed the maximum of 80 files in the memory.

■ Solution

Press the **2** key to return to the SYSTEM MENU, then delete unnecessary files in the memory. (Refer to Subsection 2.5.3, [7].)

```
DOWNLOAD
_SYSMSG.FN3
Communication
error!!
Retry?
1:Yes 2:No
```

■ Problem

Downloading has failed.

■ Solution

To retry downloading, press the 1 key.

Pressing the 2 key returns to the SYSTEM MENU. Check the interface port, communications parameters, and communications protocol type in the SET SYSTEM menu or perform the communications test in the TEST menu. (Refer to Subsection 2.5.3, [4.5] and [5.5].

[13.2] Uploading the system message file

```
UPLOAD
** Waiting **
```

Selecting "2:UPLOAD" on the SYSTEM MESSAGE transfer menu calls up the screen shown at left. With this screen displayed, the BHT waits for the system message file to be uploaded.



```
UPLOAD
_SYSMSG.FN3
** Loading **
00000/00000
```

While the uploading operation is in progress, the screen shown at left is displayed indicating the file name and the number of sent records/the total number of records.

To abort the uploading operation, press the C key. The screen will switch back to the SYSTEM MESSAGE transfer menu.

```
      UPLOAD
      _SYSMSG.FN3
** Completed **
```

Upon completion of uploading, the BHT displays the screen shown at left and beeps once.

Press the **C** key to return to the SYSTEM MESSAGE transfer menu.

NOTE

When the BHT uploads the system message file, it creates a temporary file named "_SYSMSG.FN3" in the user area. If the user area is insufficient for creating the temporary file, therefore, an error will result.

The created temporary file will be automatically deleted after completion of uploading.

If an error occurs during uploading

If some error occurs during uploading, one of the following screens will appear and the beeper beeps three times.

To retry the uploading operation, press the **1** and **ENT** keys; to abort it, press the **2** and **ENT** keys.

Press the **C** key to return to the SYSTEM MESSAGE transfer menu.

```
      UPLOAD
      _SYSMSG.FN3
File error!!
Upload?
  1:Yes  2:No
```

■ **Problem**

The file you attempted to upload is broken.

■ **Solution**

To upload the broken file as is, press the **1** key.

```
UPLOAD
Out of memory!!
```

■ **Problem**

The memory is insufficient for setting up the system message file.

■ **Solution**

Press the **C** key to return to the SYSTEM MENU, then delete unnecessary files in the memory. (Refer to Subsection 2.5.3, [7].)

```
UPLOAD
Too many files!!
```

■ **Problem**

The memory has already contained 80 files, so the BHT system message file cannot be set up.

■ **Solution**

Press the **C** key to return to the SYSTEM MENU, then delete unnecessary files in the memory. (Refer to Subsection 2.5.3, [7].)

```
UPLOAD
  _SYSMSG.FN3
Communication
  error!!
Retry?
  1:Yes 2:No
```

■ **Problem**

Uploading has failed.

■ **Solution**

To retry uploading, press the **1** key.

Pressing the **2** key returns to the SYSTEM MENU. Check the interface port, communications parameters, and communications protocol type in the SET SYSTEM menu or perform the communications test in the TEST menu. (Refer to Subsection 2.5.3, [4.5] and [5.5].)

It is also necessary to check the communications parameters setup of the host computer.

Chapter 3

Communications Operations of the BHT-100Q/100B

This chapter describes the communications operations of the BHT-100Q/100B—the IR communication, RS-232C interface specifications, the basic communications specifications, and the communications protocols—for data transfer with the host computer or other devices.

3.1	Infrared Communication	109
3.2	RS-232C Interface Specifications	111
	[1] Interface Connector and Pin Assignment	111
	[2] Interface Cable Connection	112
3.3	Basic Communications Specifications and Parameters	113
3.3.1	Basic Communications Specifications	113
3.3.2	Communications Parameters	115
3.4	Communications Protocols	116
3.4.1	BHT-protocol	116
	[1] Overview	116
	[2] Control Characters	117
	[3] Basic Format of Transmission Messages	119
	[4] Text Format	120
3.4.2	BHT-Ir Protocol	122
	[1] Overview	122
	[2] Control Characters	123
	[3] Basic Format of Transmission Messages	125
	[4] Text Format	126

3.1 Infrared Communication

The BHT has an integrated infrared (IR) communications device which enables wireless transfer of programs and data between the BHT and the host computer and between the BHTs, instead of the conventional wire transfer.

The IR communications device features the following:

- Wireless communications
- Small and lightweight design
- High transmission speed
- Freedom from the codes/regulations and licenses which differ from country to country, unlike radio devices

The BHT may communicate with other IrDA-compliant equipment just by aligning their IR ports with each other. The effective IR range and IR port angle may differ depending upon the target equipment, so observe the instructions given in manuals furnished with such equipment.

NOTE

If IR transfer fails, bring the BHT closer to the target station or change the IR port angle, and try again.

The BHT's IR communications device is IrDA-compliant. IrDA stands for Infrared Data Association, which has defined hardware (IrDA Serial Infrared Physical Layer Link) and communications protocols for IR communications.

The BHT's physical layer complies with the IrDA1.0, with a maximum transfer distance of 0.8 m and maximum transmission rate of 115.2 kbits per second.

The BHT adopts the exclusive BHT-Ir protocol which allows you to develop user programs for IR communications in BHT-BASIC, as can be done with conventional wire communications.

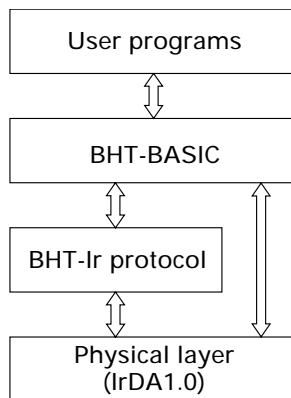

3.2 RS-232C Interface Specifications

[1] Interface Connector and Pin Assignment

The BHT has a direct-connect interface port which is connectable to the 3-pole mini stereo plug ($\varnothing 2.5$ mm or 0.1") and supports a subset of the RS-232C interface as shown below.

Using a direct-connect interface cable having the mini stereo plugs makes it possible to connect the BHT to a host computer (or another BHT) directly without any routing through the CU-7000.

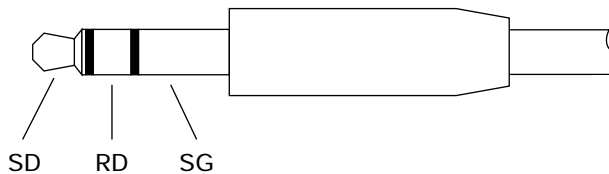

3-pole Mini Stereo Plug ($\varnothing 2.5$ mm or 0.1")

The poles of the plug are assigned as listed below.

Signal Name	Function	Signal Input/Output	
		BHT	External device
SD	Send data		→
RD	Receive data		←
SG	Signal ground		

The input/output voltage threshold for the logical valued signal is listed below.

Logical Value	Input Voltage Threshold	Output Voltage Threshold
	(RD)	(SD)
0	3V min.	5V min.
1	-3V max.	-5V max.

NOTE

- The direct-connect interface port is not designed to stand frequent connecting/disconnecting. Do not plug and unplug basically more than one time a day; otherwise, the service life of the plug will shorten. To connect the BHT to a host computer having no IR port (or another BHT) frequently, use the CU-7000.
- Allow the specified signals only to enter the direct-connect interface port. Entry of other signals will result in a failure or malfunction of the BHT.

[2] Interface Cable Connection

Connect the BHT directly to a host computer, a modem, or a printer with a direct-connect interface cable as illustrated below.

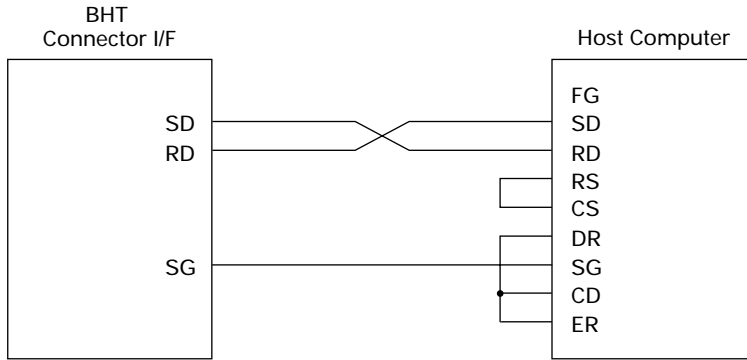

Cable Connection between BHT and Host Computer

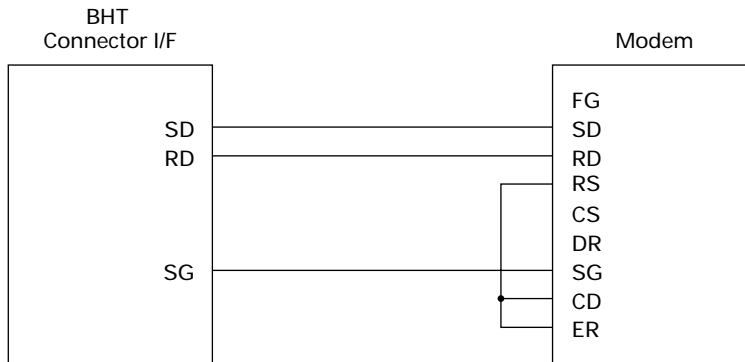

Cable Connection between BHT and Modem

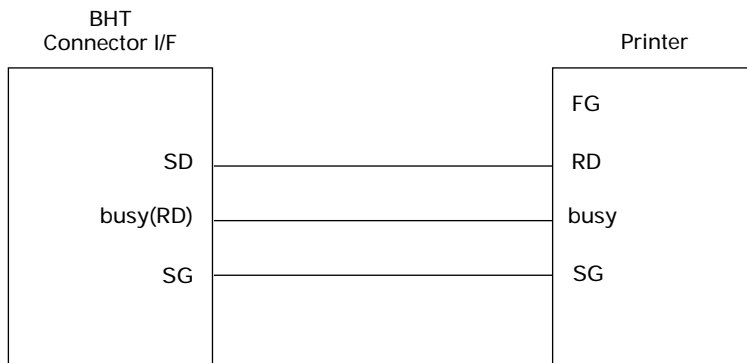

Cable Connection between BHT and Printer

3.3 Basic Communications Specifications and Parameters

3.3.1 Basic Communications Specifications

Listed below are the communications specifications when the BHT exchanges data with a host computer through the CU-7000 (optical interface) or direct-connect interface cable.

	Optical Interface	Direct-connect Interface
Synchronization	Start-stop	
Transmission Speed	2400, 9600, 19200, 38400, 57600, or 115200 bps	300, 600, 1200, 2400, 4800, 9600, 19200, 38400, 57600, or 115200 bps
Transmission Code	JIS 8-bit codes	JIS 7- or 8-bit codes
Transmission Bit Order	LSB (Least significant bit) first	
Vertical Parity	None	Even, odd, or none

■ Synchronization

For accurate data transaction, it is very important to synchronize the transmission between the sender and receiver. To do this, it is required to previously define the bit order and position, the character length, and the beginning and end of the character to be transmitted.

The start-stop synchronization is an asynchronous system which synchronizes each character as a unit; that is, it externally adds start and stop bits to the leading and trailing bit positions of the character to be transmitted, respectively. A clock starts counting on receiving the start bit and it falls into a non-communication state on receiving the stop bit. The number of the stop bits is selectable (1 or 2 bits).

■ Transmission Speed

Maximum number of bits to be transmitted per second. Expressed in bps (bits per second).

■ Optical Interface Communications Range

The optical interface's maximum effective range is 80 cm (31.5 in.) with the IR beam within a 10° angle of divergence.

■ Switching Time between Sending and Receiving on Optical Interface

The optical interface should satisfy the following requirements in switching between sending and receiving:

- (1) Within 10 ms from completion of sending, the optical interface should become ready to receive.
- (2) After 10 ms or more from completion of receiving, the optical interface should start sending.

■ Transmission Code and Bit Order

All characters should be coded to 7- or 8-bit code for data transmission. The standard data exchange code of the BHT is JIS 7- or 8-bit code. The transmission bit order is LSB (Least significant bit) first.

What follows is an example for transmitting character A (41h, 01000001b) coded to JIS 8-level code with an even parity and a single bit each for start and stop bits.

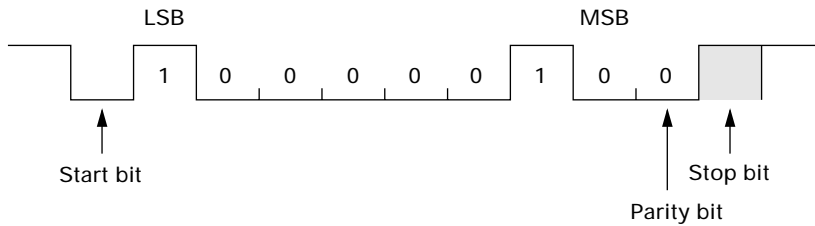

■ Vertical Parity

A vertical parity bit is a redundancy bit which is added to every character to be transmitted in order to check that data has been transmitted accurately. The parity bit should be set to "1" or "0" depending upon the parity parameter setting, to make the number of set bits in the character even or odd. The receiver counts the number of set bits in the transmitted character code to make sure that it has the selected number (even or odd) of set bits.

The vertical parity bit is positioned immediately following the MSB (Most significant bit) as shown below.

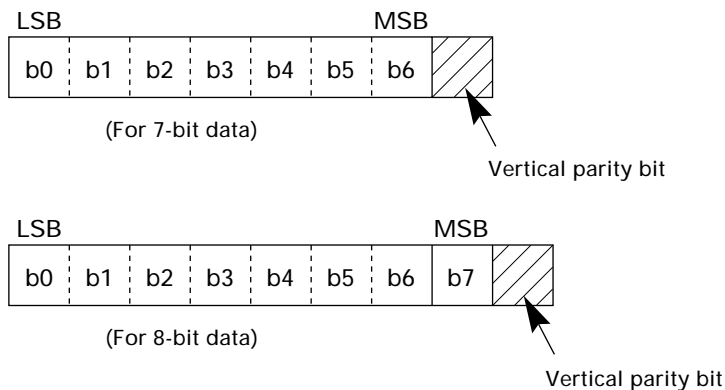

3.3.2 Communications Parameters

In System Mode and user programs written in BHT-BASIC, you may set the communications parameters listed below.

Communications Port	Optical interface	Direct-connect interface
Transmission Speed	2400, 9600, 19200, 38400, 57600, or 115200 bps	300, 600, 1200, 2400, 4800, 9600, 19200, 38400, 57600, or 115200 bps
Character Length	8 bits	7 or 8 bits
Vertical Parity	None	Odd, even, or none
Stop Bit Length	1 bit	1 or 2 bits

In System Mode

Refer to Chapter 2, Subsection 2.5.3, "[4.5] Setting the communications environments."

In BHT-BASIC

To set the transmission speed, character length, vertical parity, and stop bit length (To set the transmission speed only for the optical interface), use the `OPEN "COM: "` statement in BHT-BASIC.

- `OPEN "COM: ... "` Opens the interface port selected in System Mode.
- `OPEN "COM1: ... "` Opens the optical interface port for data transmission, irrespective of the setting in System Mode.
- `OPEN "COM2: ... "` Opens the direct-connect interface port for data transmission, irrespective of the setting in System Mode.

Note that it is impossible to open both the optical interface port and the direct-connect interface port concurrently.

Through the interface port opened by the `OPEN "COM: "` statement, the `XFILE` statement transmits a designated file.

3.4 Communications Protocols

The BHT supports both the BHT-protocol and the BHT-Ir protocol for file transmission.

3.4.1 BHT-protocol

[1] Overview

The BHT-protocol is the communications procedure used to transmit files between the BHT and a host (or between the BHTs). It adopts the response method using ACK/NAK codes.

The BHT-protocol is composed of a defined set of the control character sequences including the following three phases:

Phase 1: Establishment of data link

The sending station confirms that the receiving station is ready to receive data.

Phase 2: Data transmission

The sending station transmits data to the target receiving station.

Phase 3: Release of data link

The sending station confirms whether or not all of the transmitted data has been correctly received by the receiving station. If yes, the sending station terminates the data transmission and releases the data link.

For details about the transmission control sequences and horizontal parity checking, refer to Appendix B, B.1, "BHT-protocol."

[2] Control Characters

The control characters are classified into two groups: transmission control characters and text control characters.

(1) Transmission control characters

The transmission control characters listed below are used to compose transmission control sequences in phases 1 through 3.

Symbol	Value	Meaning	Function
EOT	04h	End Of Transmission	Releases a data link (Phase 3). Requests abort of transmission (Phase 2).
ENQ	05h	Enquiry	Requests establishment of a data link (Phase 1). Prompts the receiver to respond to the sent text (Phase 2).
ACK	06h	Acknowledge	Acknowledgment response to ENQ (Phase 1). Acknowledgment response to text (Phase 2). Acknowledgment response to EOT (Phase 3).
NAK	15h	Negative Acknowledge	Negative acknowledgment response to ENQ (Phase 1). Negative acknowledgment response to text (Phase 2).

■ Transparency

The BHT uses the non-transparent mode which handles the control characters and codes (e.g., STX, ETX, and SOH) as starting or ending markers and does not allow them to be transmitted as normal data in the transmission texts.

(2) Text control characters

The text control characters are used to format transmission texts. In the BHT-protocol, they include the following headers and a terminator.

Symbol	Value	Meaning	Function
SOH	01h	Start Of Heading	Indicates the start of heading text (Phase 2).
STX	02h	Start of Text	Indicates the start of data text (Phase 2).
ETX	03h	End of Text	Indicates the end of data text (Phase 2).

You may designate values of headers and a terminator with the protocol functions in BHT-BASIC. If you designate none of them in a user program, the BHT may apply those as listed above. Refer to the "BHT-BASIC Programmer's Manual (BHT-100 series)."

[3] Basic Format of Transmission Messages

Basically, the BHT transmits data as units of a file. First, it transmits a heading text which includes the attribute information of a file (e.g., file name and the number of data texts) to be transmitted. Following the heading text, it transmits the data text in the file. A heading text and data text comprise a text.

In actual text transmission, the text is divided into several blocks, then a header and terminator are added to each block. If the serial number management or error checking by BCC (Block Check Character) is required, the serial number or BCC is also added to each block, respectively. This procedure forms a transmission block. A set of transmission blocks makes up one transmission message.

Shown below is an example of a transmission message formed with the BHT-protocol.

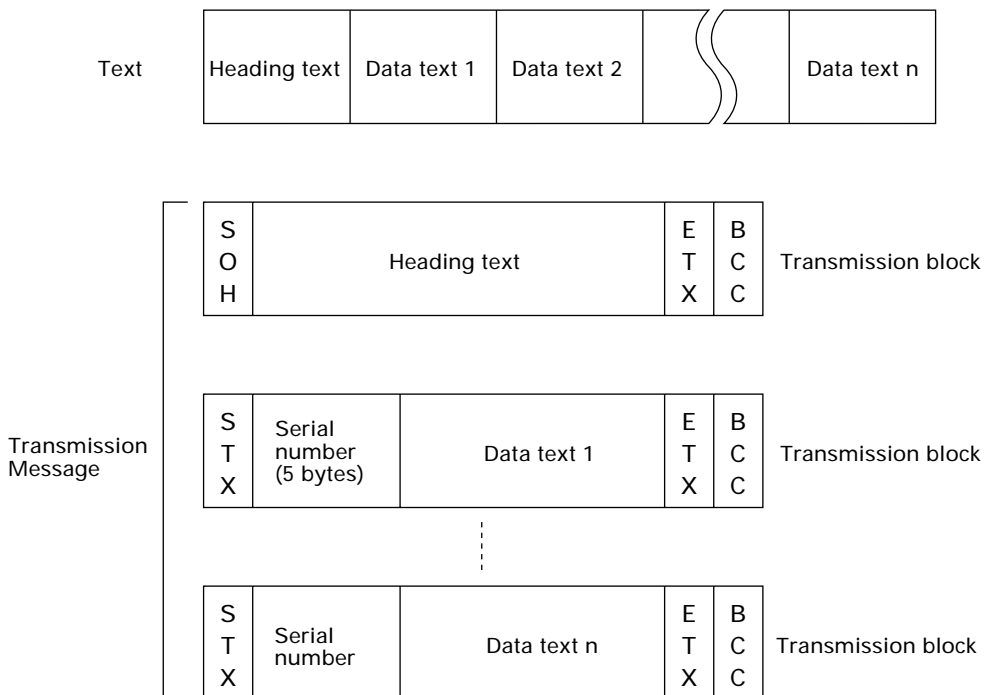

In the above figure, SOH, STX, and ETX are text control characters as described in [2] Control Characters, (2). A serial number is expressed by a five-digit decimal number, starting from 00001 to 32767, and identifies transmitted data texts. For the BCC, refer to Appendix B, B.1, "BHT-protocol," [3].

[4] Text Format

Text should be formatted according to the standard of the BHT-protocol before transmission. Shown below are two types of the standard text formats for program files and data files.

■ Program Text Format

(1) Heading text

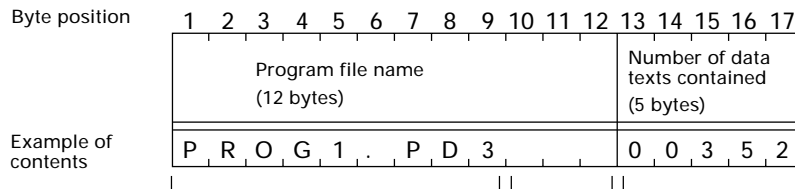

The program file name should be a maximum of 12 characters in length and it consists of FILE NAME and .EXTENSION. The FILE NAME should be 1 to 8 characters. The EXTENSION should be .PD3 (.FN3 and .EX3 may be available for future functional expansion).

If the program file name is less than 12 characters in length, the lower blank bytes will be filled with space characters.

The number of data texts should be 0 to 32767. If it is less than 5 digits, the upper blank bytes will be filled with zeros (0).

(2) Data text

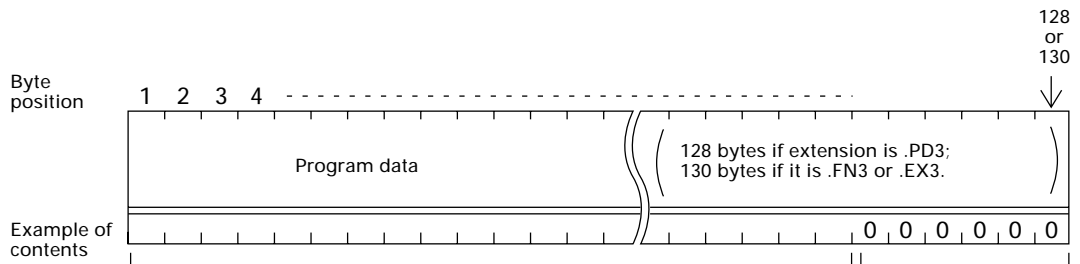

Object file (compiled from a source program file having one of the extensions .PD3, .FN3, and .EX3.)

If a program data field is less than the maximum digits in length, the lower blank bytes will be filled with zeros (0).

■ Data Text Format

(1) Heading text

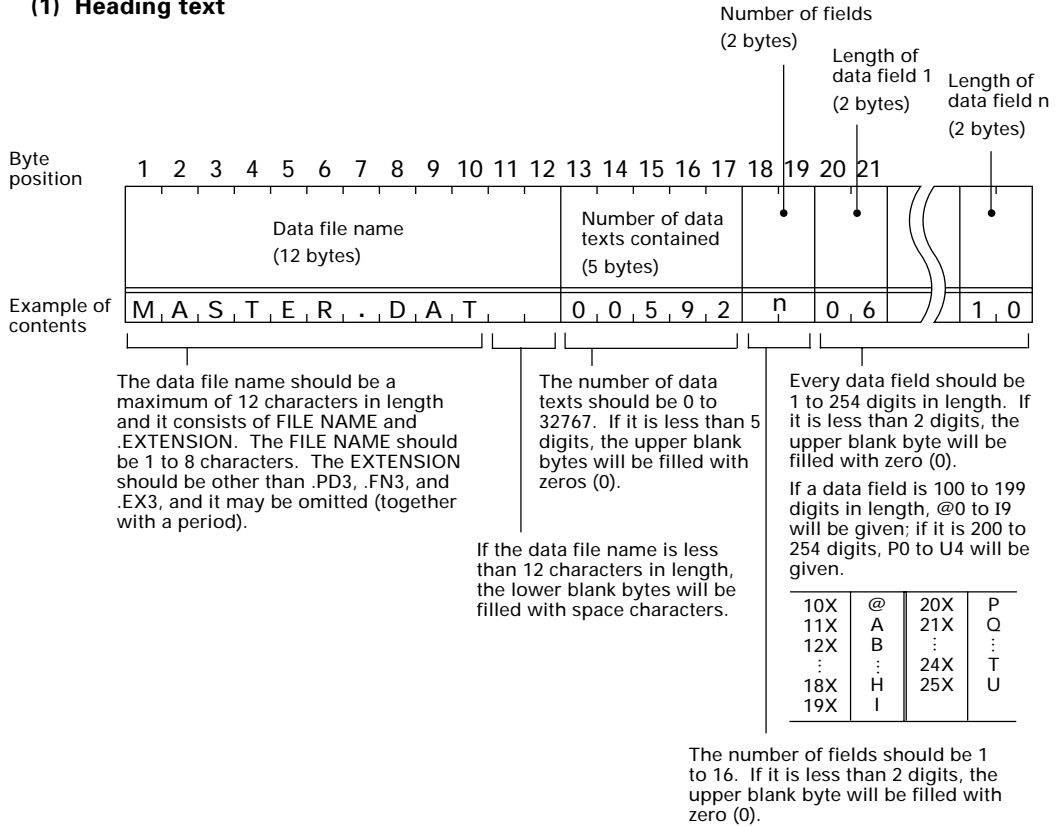

NOTE

To transfer a data file containing a data field(s) of 100 digits or more, use the Windows-based Transfer Utility. The MS-DOS-based Transfer Utility does not support transmission of data fields exceeding 99 digits.

(2) Data text

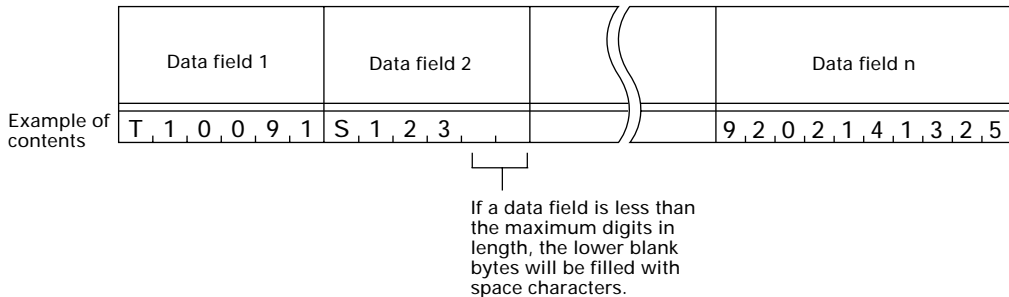

NOTE

The total length of all data fields plus the number of the character count bytes (= the number of the fields) should be 255 bytes or less.

When you transfer five 50-digit (50-byte) fields, for example, the total length of all data fields is 250 (50 x 5) bytes and the number of the character count bytes is 5. Accordingly, the total is 255, so you can transfer the file.

3.4.2 BHT-Ir Protocol

[1] Overview

The BHT-Ir protocol is the communications procedure for the serial infrared link, which is used to transmit files between the BHT and a host (or between the BHTs). It adopts the response method using ACK/NAK codes. The BHT-Ir protocol can be used also for communications through the direct-connect interface.

The BHT-Ir protocol is composed of a defined set of the control character sequences including the following three phases:

Phase 1: Establishment of data link

The sending station confirms that the receiving station is ready to receive data.

Phase 2: Data transmission

The sending station transmits data to the target receiving station.

Phase 3: Release of data link

The sending station confirms whether or not all of the transmitted data has been correctly received by the receiving station. If yes, the sending station terminates the data transmission and releases the data link.

For details about the transmission control sequences and CRC, refer to Appendix B, B.2, "BHT-Ir protocol."

[2] Control Characters

The control characters are classified into two groups: transmission control characters and text control characters.

(1) Transmission control characters

The transmission control characters listed below are used to compose transmission control sequences in phases 1 through 3.

Symbol	Value	Meaning	Function
DLE EOT	1004h	End Of Transmission	Releases a data link (Phase 3). Requests abort of transmission (Phase 2).
DLE ENQ	1005h	Enquiry	Requests establishment of a data link (Phase 1). Prompts the receiver to respond to the sent text (Phase 2).
DLE ACK	1006h	Acknowledge	Acknowledgment response to DLE ENQ (Phase 1). Acknowledgment response to text (Phase 2). Acknowledgment response to DLE EOT (Phase 3).
DLE NAK	1015h	Negative Acknowledge	Negative acknowledgment response to DLE ENQ (Phase 1). Negative acknowledgment response to text (Phase 2).
WACK	103Bh	Wait for Acknowledge	Requests suspension of data reception during erasure of the flash memory.

■ Transparency

The BHT uses the transparent mode which allows the control characters and codes (e.g., STX, ETX, SOH, and DLE) to be transmitted as normal data in the transmission texts.

To transmit a DLE as normal data, type DLE DLE per DLE.

(2) Text control characters

The text control characters are used to format transmission texts. In the BHT-Ir protocol, they include the following headers and a terminator.

Symbol	Value	Meaning	Function
DLE SOH	1001h	Start Of Heading	Indicates the start of heading text (Phase 2).
DLE STX	1002h	Start of Text	Indicates the start of data text (Phase 2).
DLE ETX	1003h	End of Text	Indicates the end of data text (Phase 2).

In the BHT-Ir protocol, you cannot change the values of the headers and terminator with the protocol functions in BHT-BASIC.

[3] Basic Format of Transmission Messages

Basically, the BHT transmits data as units of a file. First, it transmits a heading text which includes the attribute information of a file (e.g., file name and the number of data texts) to be transmitted. Following the heading text, it transmits the data text in the file. A heading text and data text comprise a text.

In actual text transmission, the text is divided into several blocks, then a header, terminator, serial number, receiver station's ID, and CRC-16 (Cyclic Redundancy Check) are added to each block. This procedure forms a transmission block. A set of transmission blocks makes up one transmission message.

Shown below is an example of a transmission message formed with the BHT-Ir protocol.

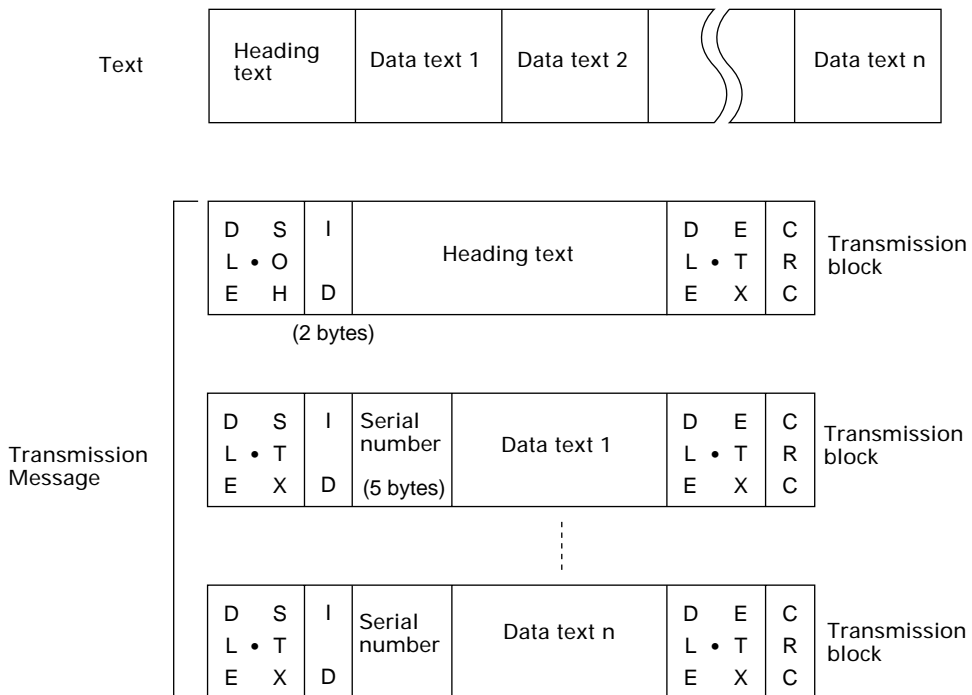

In the above figure, DLE SOH, DLE STX and DLE ETX are text control characters as described in [2] Control Characters, (2). An ID denotes the ID number of the receiver station, expressed by two bytes. A serial number is expressed by a five-digit decimal number, starting from 00001 to 32767, and identifies data texts. For the CRC-16, refer to Appendix B, B.2, "BHT-Ir protocol," [3].

TIP

You can use the control characters for expressing IDs, serial numbers, or text data.

[4] Text Format

Text should be formatted according to the standard of the BHT-Ir protocol before transmission. Shown below are two types of the standard text formats for program files and data files.

■ Program Text Format

(1) Heading text

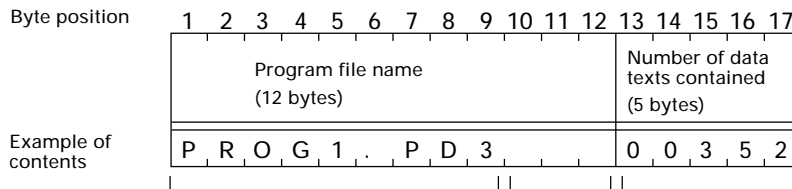

The program file name should be a maximum of 12 characters in length and it consists of FILE NAME and .EXTENSION. The FILE NAME should be 1 to 8 characters. The EXTENSION should be .PD3 (.EX3 and .FN3 may be available for future functional expansion).

If the program file name is less than 12 characters in length, the lower blank bytes will be filled with space characters.

The number of data texts should be 0 to 32767. If it is less than 5 digits, the upper blank bytes will be filled with zeros (0).

(2) Data text

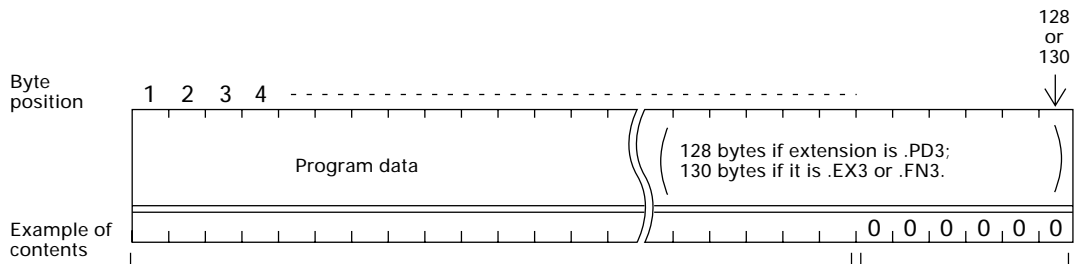

Object file (compiled from a source program file having one of the extensions .PD3, .EX3, and .FN3.)

If a program data field is less than the maximum digits in length, the lower blank bytes will be filled with zeros (0).

■ Data Text Format

(1) Heading text

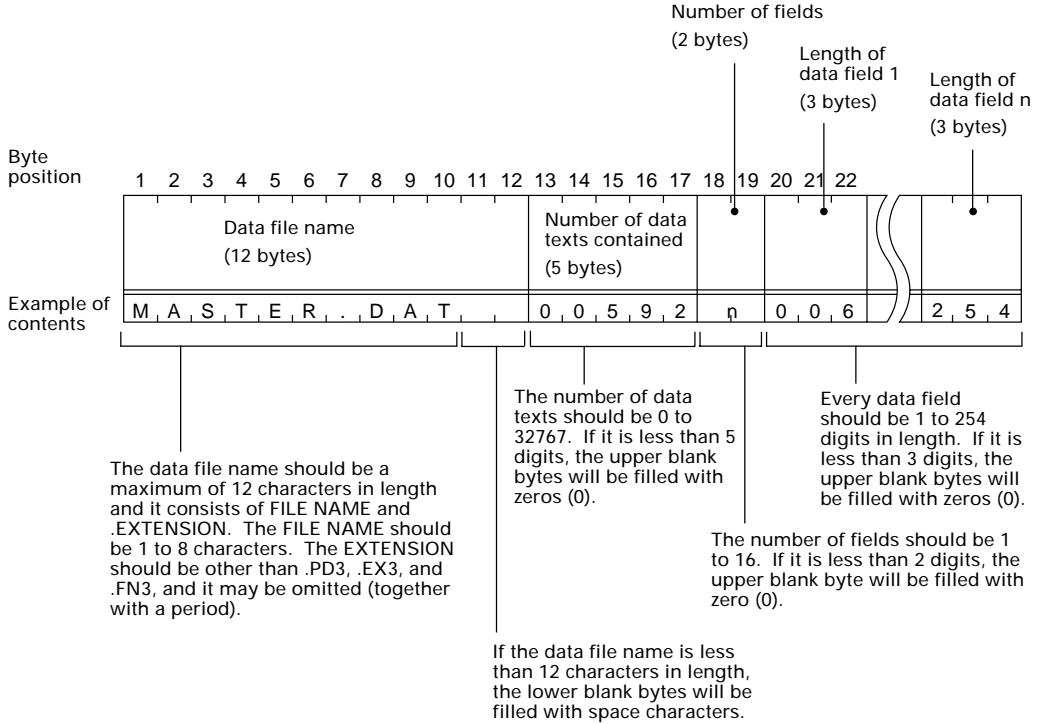

(2) Data text

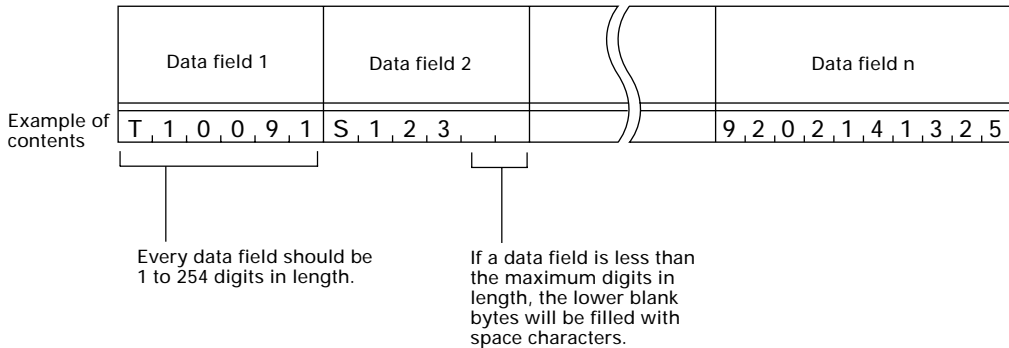

NOTE

The total length of all data fields plus the number of the character count bytes (= the number of the fields) should be 255 bytes or less.

When you transfer five 50-digit (50-byte) fields, for example, the total length of all data fields is 250 (50 x 5) bytes and the number of the character count bytes is 5. Accordingly, the total is 255, so you can transfer the file.

This chapter lists the error messages which will appear on the LCD if some error occurs in the BHT-100Q/100B.

4.1	System Errors	129
4.2	Errors in System Mode	134

Chapter 4

Error Messages

4.1 System Errors

If some error occurs when the power is turned on or during program execution, one of the following error messages will appear on the LCD.

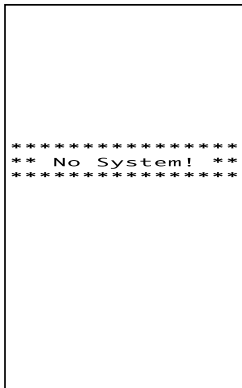

System Program error

■ Problem

A System Program error has occurred.

NOTE If this error occurs, the BHT beeps five times (for 0.1 second per beep) and then turns itself off.

■ Solution

Contact your nearest dealer.

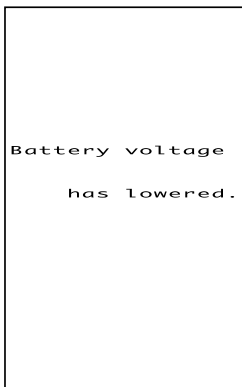

Low battery indication—Level 1

■ Problem

When the power is turned on or off or during execution of program (System Mode or application), the battery output level has dropped below a specified lower level limit.

NOTE If low battery is detected, the BHT displays this message for approx. 2 seconds and beeps three times (for 0.1 second per beep). After that, it will resume previous regular operation.

■ Solution

The battery recharge or replacement time will come soon.

If the BHT is loaded with the rechargeable battery cartridge, replace or charge it. (For the charging procedure, refer to Chapter 5, Section 5.5.)

If the BHT is loaded with the dry battery cartridge, replace the dry cells.

(When the rechargeable battery cartridge is loaded)

```
Charge the
      battery!
```

(When the dry battery cartridge is loaded)

```
Replace the
      batteries!
```

```
Set the current
  date and time.
00/01/01 00:00
- / /   :
```

Low battery indication—Level 2

■ Problem

When the power is turned on or off or during execution of program (System Mode or application), the battery output level has lowered.

NOTE If lower battery is detected, the BHT beeps five times (for 0.1 second per beep) and then turns itself off. Depending upon the battery level, the beeper may not sound five times.

■ Solution

If the BHT is loaded with the rechargeable battery cartridge, replace or charge it. (For the charging procedure, refer to Chapter 5, Section 5.5.)

If the BHT is loaded with the dry battery cartridge, replace the dry cells.

Calendar clock stopped

■ Problem

The calendar clock integrated in the BHT has stopped because:

- The battery cartridge had been removed for a long time,
- The rechargeable battery cartridge had not been recharged for a long time, or
- The dry cells in the dry battery cartridge had not been replaced.

NOTE The indication of 00/01/01 00:00 will vary depending upon the calendar clock state.

■ Solution

Set the calendar clock (refer to Chapter 2, Subsection 2.3.2).

```

Your terminal
was not shut
down properly
the last time
it was used.

Unsaved data
was lost.

[SF+2]

```

Abnormally turned off last

■ Problem

After turned off abnormally*, the BHT had been left with no battery cartridge loaded or with a discharged battery cartridge loaded, so unsaved data was lost.

(*"Normally turned off" refers to turned-off with the **PW** key or by the auto power-off feature.)

■ Solution

Refer to Subsection 2.3.6 "BHT Turning-off Notes."

```

Reload the
battery
to restart!

xxxxxxx  01

```

System Program malfunction

■ Problem

During execution of System Program, the System Program has attempted to write onto the write-protected area of the memory.

(xxxxxxx: Error address)

NOTE If this error occurs, the BHT beeps five times (for 0.1 second per beep).

■ Solution

Unload and reload the battery cartridge, then turn on the power.

```

Reload the
battery
to restart!

tskid:xxxxxxx
ercd :xxxxxxx
addr :xxxxxxx 02

```

■ Problem

During execution of System Program, the System Program has received an invalid command code.

(xxxxxxx: Error address)

NOTE If this error occurs, the BHT beeps five times (for 0.1 second per beep).

■ Solution

Unload and reload the battery cartridge, then turn on the power.

No execution
program selected
Contact your
administrator.

Execution program not selected

■ Problem

No user program has been selected as an execution program to be run when the power is turned on.

NOTE If this error occurs, the BHT beeps five times (for 0.1 second per beep) and then turns itself off.

■ Solution

Run System Mode and select an execution program in the SET SYSTEM menu. (For the selecting procedure, refer to Chapter 2, Subsection 2.5.3, [4.1].)

No resume info.
has been
retained.
Program restarts
automatically.

Resume data lost

■ Problem

No resume data has been retained since the BHT was not normally turned off and then left with no battery cartridge loaded or with a discharged battery cartridge loaded even if the resume function had been set to ON.

NOTE The BHT displays this error message for 3 seconds and automatically runs the execution program from the point of start-up.

Your settings in
System Mode
have been lost.
Will reset
to defaults.

Error in System Mode settings

■ Problem

Your settings made in System Mode contain an error.

NOTE

- If this error occurs, the System Mode settings revert to the factory defaults.
- The BHT displays this error message for three seconds and then displays the "No execution program selected..." message.

■ Solution

Make your settings in System Mode again.

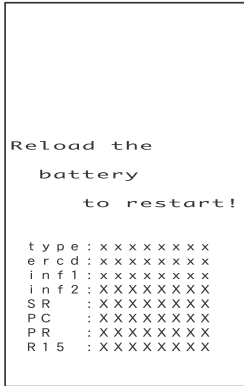

System down error

■ Problem

An error has occurred during execution of System Program.

NOTE If this error occurs, the BHT beeps five times (for 0.1 second per beep).

■ Solution

Unload and reload the battery cartridge, then turn on the power.

If this error occurs frequently, make a note of the message and codes on the LCD and contact your nearest dealer.

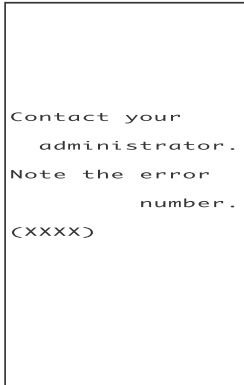

System administrator to be called

■ Problem

Any of the following errors has occurred:

- (1) Hardware error
 - Calendar clock error: (1010)
 - Flash memory error: (1020)
- (2) Memory storage error (2XXX)
- (3) Execution program error (3010)

(XXXX: Error code)

TIP If any of the above errors occurs, the BHT beeps five times (for 0.1 second per beep) and then turns itself off.

■ Solution

Turn on the power again.

If error (1) above occurs frequently, contact your nearest dealer.

If error (2) occurs frequently, initialize the BHT System (the whole user area including the font file area).

If error (3) occurs frequently, delete the execution program file that causes this error or download the original execution program file to overwrite the current one.

4.2 Errors in System Mode

If some error occurs during operation in System Mode, one of the following error messages will appear on the LCD.

```
EXECUTE PROGRAM
*****
*NO FILE EXISTS*
*****
```

```
SET EXEC PROGRAM
*****
*NO FILE EXISTS*
*****
```

```
UPLOAD FILE
*****
*NO FILE EXISTS*
*****
```

When selecting a program file or data file

■ Problem

You attempted to execute a user program in the EXECUTE PROGRAM menu, but no user program files had been stored in the memory.

■ Solution

Press the **C** key to return to the SYSTEM MENU screen, then download user programs. (Refer to Chapter 2, Subsection 2.5.3, [2].)

■ Problem

In the SET SYSTEM menu, you attempted to select a user program file as an execution program to be run when the power is applied, but no user program files had been stored in the memory.

■ Solution

Press the **C** key to return to the SYSTEM MENU screen, then download user programs. (Refer to Chapter 2, Subsection 2.5.3, [2].)

■ Problem

You attempted to select "ONE FILE" or "ALL FILES" for uploading in the UPLOAD menu, but no data files had been stored in the memory.

■ Solution

Press the **C** key to return to the SYSTEM MENU screen.

```

DELETE FILE

*****
*NO FILE EXISTS*
*****

```

■ Problem

You have deleted all of the files stored in the memory in the DELETE FILE menu.

■ Solution

Press the **C** key to return to the SYSTEM MENU screen.

During downloading of a program file, data file, BHT system parameter file, or system message file

```

DOWNLOAD FILE

XXXXXXXXX.XXX
Out of memory!!

Retry?
  1:Yes  2:No

```

■ Problem

The memory is insufficient for storing files to be downloaded.

■ Solution

Press the **2** key to return to the SYSTEM MENU, then delete unnecessary files in the memory or decrease the size of the file to be downloaded. (Refer to Chapter 2, Subsection 2.5.3, [7], [2], [8], and [10].)

```

DOWNLOAD FILE

XXXXXXXXX.XXX
File mismatch!!

Retry?
  1:Yes  2:No

```

■ Problem

In the DOWNLOAD menu, you attempted to download the BHT system parameter file or system message file. In the SYSTEM PARAMETER transfer menu, you attempted to download a file other than the BHT system parameter file. Or in the SYSTEM MESSAGE transfer menu, you attempted to download a file other than the system message file.

■ Solution

Check the file you attempted to download and then download the file in the appropriate menu (DOWNLOAD menu, SYSTEM PARAMETER transfer menu, or SYSTEM MESSAGE transfer menu).

```
DOWNLOAD FILE
XXXXXXXXX.XXX
Too many files!!

Retry?
 1:Yes  2:No
```

■ Problem

The current download will exceed the maximum of 80 files in the memory.

■ Solution

Press the **2** key to return to the SYSTEM MENU, then delete unnecessary files in the memory (or decrease the number of files to be downloaded if you attempted to download more than one file in the DOWNLOAD menu.)

(Refer to Chapter 2, Subsection 2.5.3, [7], [2], [8], and [10].)

```
DOWNLOAD FILE
XXXXXXXXX.XXX
Communication
error!!

Retry?
 1:Yes  2:No
```

■ Problem

Downloading has failed.

■ Solution

To retry downloading, press the **1** key.

Pressing the **2** key returns to the SYSTEM MENU. Check the interface port, communications parameters, and communications protocol type in the SET SYSTEM menu or perform the communications test in the TEST menu. (Refer to Chapter 2, Subsection 2.5.3, [4.5] and [5.5].)

It is also necessary to check the communications parameters setup of the host computer.

```
DOWNLOAD
__BHT.SYS
Communication
error!!

Retry?
 1:Yes  2:No
```

■ Problem

Downloading the BHT system parameter file has failed.

■ Solution

To retry downloading, press the **1** key.

Pressing the **2** key returns to the SYSTEM MENU. Check the interface port, communications parameters, and communications protocol type in the SET SYSTEM menu or perform the communications test in the TEST menu. (Refer to Chapter 2, Subsection 2.5.3, [4.5] and [5.5].)

It is also necessary to check the communications parameters setup of the host computer.

```

DOWNLOAD FILE
XXXXXXXXX.XXX
File error!!

Retry?
  1:Yes  2:No

```

■ Problem

You attempted to download an invalid program file.

■ Solution

Check whether the program file you attempted to download is available to your BHT model. If it is not available, download the appropriate program.

During uploading of a program file, data file, BHT system parameter file, or system message file

```

UPLOAD FILE
XXXXXXXXX.XXX
File error!!

Upload?
  1:Yes  2:No

```

■ Problem

The file you attempted to upload is damaged.

■ Solution

To upload the damaged file as is, press the **1** key.

```

UPLOAD

Out of memory!!

```

■ Problem

The memory is insufficient for setting up the BHT system parameter file or system message file to be uploaded.

■ Solution

Press the **C** key to return to the SYSTEM MENU and delete unnecessary files. (Refer to Chapter 2, Subsection 2.5.3, [7].)

```
UPLOAD
Too many files!!
```

■ **Problem**

The memory has already contained 80 files, so the BHT system parameter file or system message file cannot be set up.

■ **Solution**

Press the **C** key to return to the SYSTEM MENU and delete unnecessary files. (Refer to Chapter 2, Subsection 2.5.3, [7].)

```
UPLOAD FILE
XXXXXXXXX.XXX
Communication
error!!
Retry?
1:Yes 2:No
```

■ **Problem**

Uploading has failed.

■ **Solution**

To retry uploading, press the **1** key.

Pressing the **2** key returns to the SYSTEM MENU. Check the interface port, communications parameters, and communications protocol type in the SET SYSTEM menu or perform the communications test in the TEST menu. (Refer to Chapter 2, Subsection 2.5.3, [4.5] and [5.5].)

It is also necessary to check the communications parameters setup of the host computer.

```
UPLOAD
__BHT.SYS
Communication
error!!
Retry?
1:Yes 2:No
```

■ **Problem**

Uploading the BHT system parameter file has failed.

■ **Solution**

To retry uploading, press the **1** key.

Pressing the **2** key returns to the SYSTEM MENU. Check the interface port, communications parameters, and communications protocol type in the SET SYSTEM menu or perform the communications test in the TEST menu. (Refer to Chapter 2, Subsection 2.5.3, [4.5] and [5.5].)

It is also necessary to check the communications parameters setup of the host computer.

This chapter describes the handling procedure of the CU-7000, the interfacing with the host computer, and the charging of the rechargeable battery cartridge.

5.1	Functions of the CU-7000	140
5.2	Components and Functions	140
5.3	Applying Power to the CU-7000	141
5.4	Communicating with the Host Computer	142
5.4.1	Setting the Transmission Speed of the CU-7000	142
5.4.2	Interface Cable Connection	142
5.4.3	Interfacing with the Host Computer	143
5.5	Charging the Rechargeable Battery Cartridge (using the CU-7001)	144
5.6	RS-232C Interface Specifications	146
	[1] Interface Connector and Pin Assignment	146
	[2] Interface Cable Connection	147

Chapter 5

Handling the CU-7000 (Option)

5.1 Functions of the CU-7000

The optical communications unit CU-7000 is available in two models: CU-7001 and CU-7002. The CU-7001 has both of functions (1) and (2) given below, the CU-7002 has only function (1).

(1) Data exchange function

The CU-7001/CU-7002 exchanges data and programs between the BHT and the host computer. It interfaces with the BHT via the optical interface and with the host computer via the RS-232C interface.

(2) Battery cartridge charging function

The CU-7001 charges the rechargeable battery cartridge loaded in the BHT.

5.2 Components and Functions

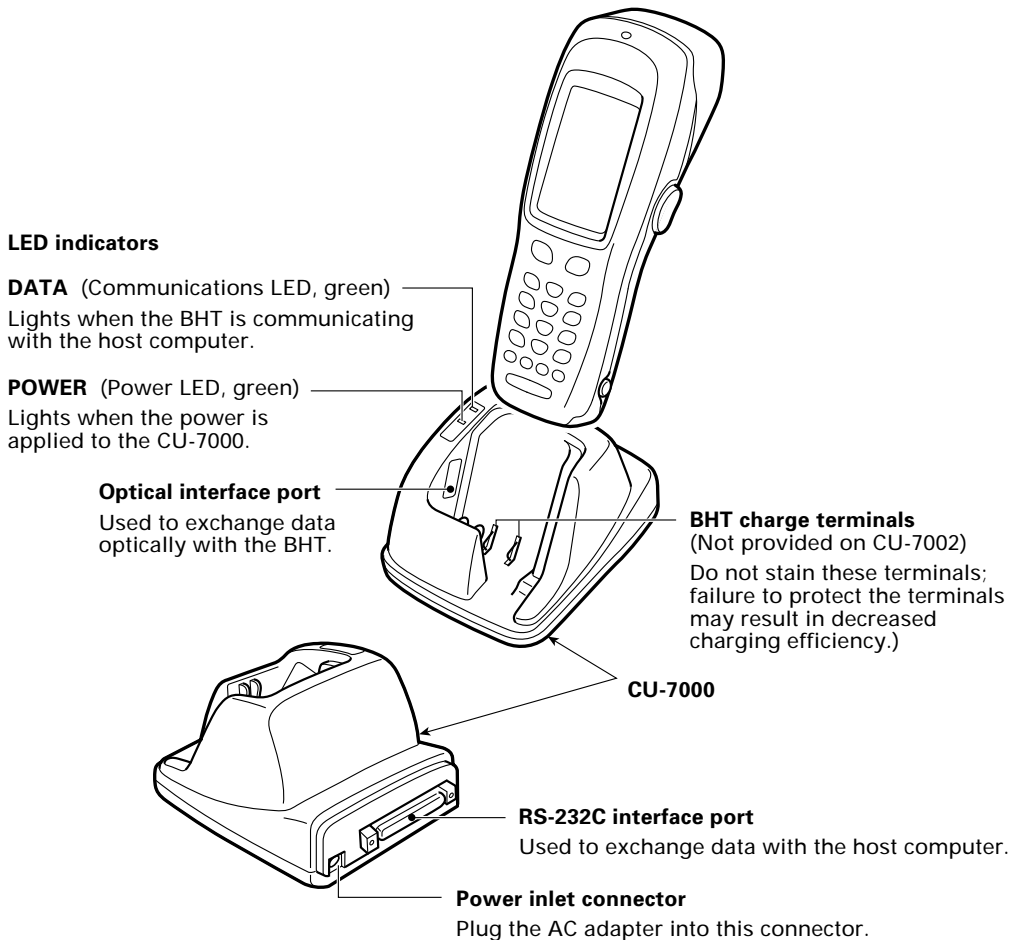

5.3 Applying Power to the CU-7000

Apply power to the CU-7000 by connecting it to the wall socket via the dedicated AC adapter.

Connect the outlet plug of the AC adapter to the power inlet connector of the CU-7000, then plug the other end of the AC adapter into the wall socket.

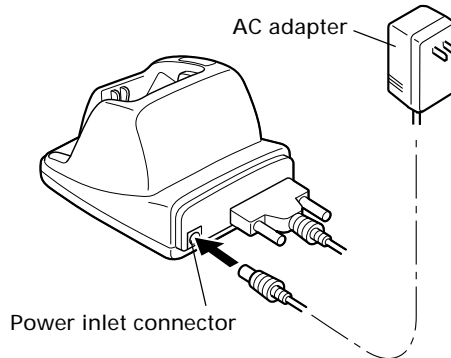

<p>⚠ WARNING</p>	<ul style="list-style-type: none"> • If smoke, abnormal odors or noises come from the CU, immediately unplug the AC adapter from the wall socket and contact your nearest dealer. Failure to do so could cause fire or electrical shock. • If foreign material or water gets into the CU, immediately unplug the AC adapter from the wall socket and contact your nearest dealer. Failure to do so could cause fire or electrical shock. • If you drop the CU so as to damage its housing, immediately unplug the AC adapter from the wall socket and contact your nearest dealer. Failure to do so could cause fire or electrical shock. • Use the dedicated AC adapter only. Failure to do so could result in a fire. • Never use the CU on the line voltage other than the specified level. Doing so could cause the CU to break or burn. • If the power cord of the AC adapter is damaged (e.g., exposed or broken lead wires), stop using it and contact your nearest dealer. Failure to do so could result in a fire or electrical shock. 	<p>⚠ ⚠ ⚠ ⚠ ⚠ ⚠ ⚠</p>
-------------------------	---	--

<p>⚠ CAUTION</p>	<ul style="list-style-type: none"> • If you are not using the CU for a long time, be sure to unplug the AC adapter from the wall socket for safety. Failure to do so could result in a fire. • When caring for the CU, unplug the AC adapter from the wall socket for safety. Failure to do so could result in an electrical shock. • Never cover or wrap up the CU or AC adapter in a cloth or blanket. Doing so could cause the unit to heat up inside, deforming its housing, resulting in a fire. Always use the CU and AC adapter in a well-ventilated area. • Keep the power cord away from any heating equipment. Failure to do so could melt the sheathing, resulting in a fire or electrical shock. 	<p>⚠ ⚠ ⚠ ⚠</p>
-------------------------	--	----------------------------

5.4 Communicating with the Host Computer

5.4.1 Setting the Transmission Speed of the CU-7000

Set the transmission speed of the CU-7000 to the same value as that of the BHT and the host computer, by using the DIP switch provided on the bottom of the CU-7000.

- (1) Turn the CU-7000 upside down.
- (2) Remove the protection sheet of the DIP switch from the CU-7000.
- (3) Set the selectors of the DIP switch as shown below.

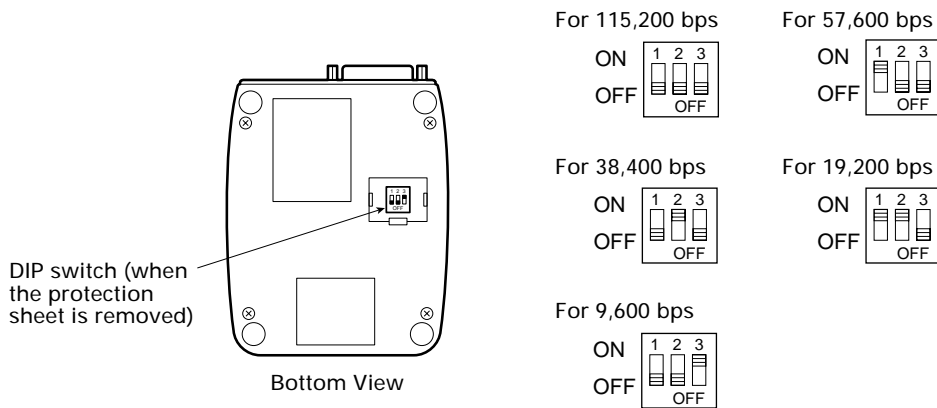

- (4) Reinstall the protection sheet.

NOTE Do not set the DIP switch to any configurations other than one of the five shown above.

5.4.2 Interface Cable Connection

- (1) Unplug the AC adapter of the CU-7000 from the wall socket.
- (2) Make sure that the host computer is turned off.
- (3) Connect the 25-pin plug (Dsub-25P) of the interface cable to the RS-232C interface port of the CU-7000.

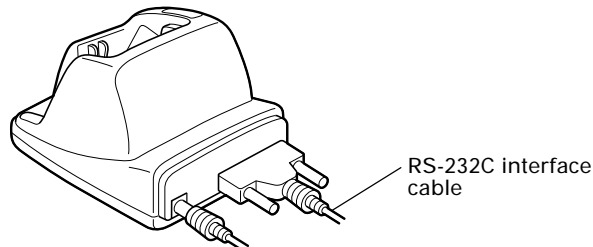

- (4) Connect the other end of the interface cable to the RS-232C port of the host computer.

5.4.3 Interfacing with the Host Computer

This section describes how to start communication with the host computer in System Mode. The same may apply when you use a user program.

- (1) Turn the host computer on.
- (2) Plug the AC adapter of the CU-7000 into the wall socket.
- (3) Make sure that the BHT is turned off, then set it on the CU-7000.

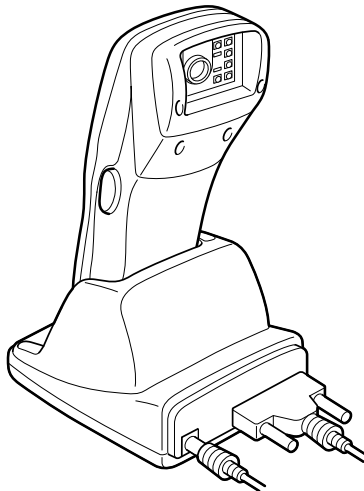

- (4) Turn the BHT power on and run System Mode. Set the communications environments (communications protocol, interface port, communications parameters, and protocol options).

Regarding the communications protocol: When using Ir-Transfer Utility C/Ir-Transfer Utility E on the host computer, select the BHT-Ir protocol; when using Transfer Utility, select the BHT-protocol.

Regarding the interface port: Select the optical interface port.

- (5) On the host computer, initiate a communications program (e.g., Ir-Transfer Utility C/Ir-Transfer Utility E/Transfer Utility, or equivalent).
- (6) To transfer data stored in the BHT to the host computer, select "3: UPLOAD" on the SYSTEM MENU in System Mode. To transfer data from the host computer to the BHT, select "2: DOWNLOAD." (For details, refer to Chapter 2, Section 2.5.)

The BHT and the host computer will start communications with each other via the CU-7000. The DATA LED will come on upon start of communications. After completion of communications, the LED will go off.

- (7) Unplug the AC adapter of the CU-7000 from the wall socket.

5.5 Charging the Rechargeable Battery Cartridge (using the CU-7001)

You may charge a rechargeable battery cartridge loaded in the BHT.

NOTE

Service Life of Rechargeable Battery Cartridge:

Lithium-ion batteries used in the rechargeable battery cartridge will gradually deteriorate during the repeated cycles of charging and discharging due to its properties, even under normal use. When the battery service period becomes shortened due to its deterioration even if it has been charged for the specified hours, replace the battery cartridge with a new one. Generally, it is necessary to replace the battery cartridge after it has undergone approx. 300 cycles of charging and discharging operation.

- (1) Plug the AC adapter of the CU-7001 into the wall socket.

The POWER LED on the CU-7001 lights in green.

- (2) Place the BHT loaded with a battery cartridge onto the CU-7001.

The BHT turns on the indicator LED in red and starts charging. The charging time is approx. 4 hours.

Upon completion of charging, the indicator LED turns green.

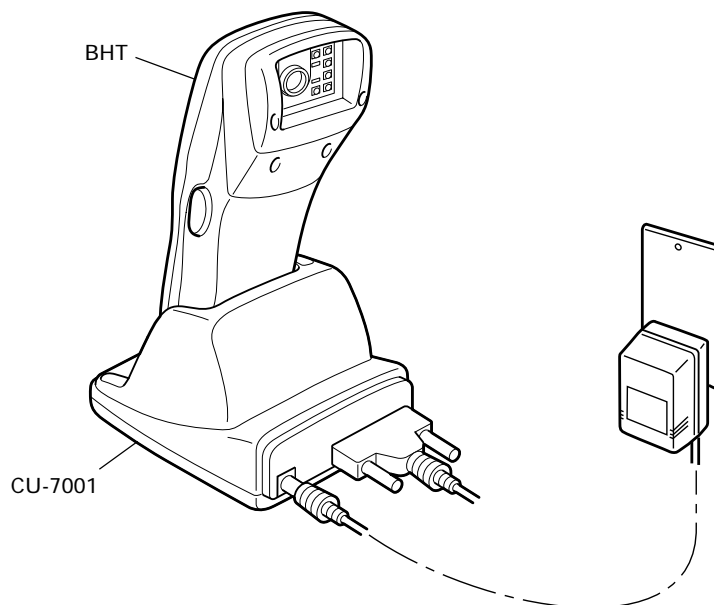

- (3) Take the BHT off the CU-7001.

TIP

The charging time is approx. 4 hours if the "Charge the battery!" message is displayed on the BHT. The battery cartridge not discharged so much will be fully recharged in shorter time.

■ Charging Operation and LED Indication

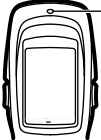
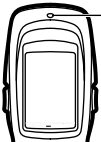
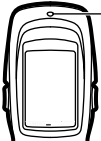
Operator's Action	CU-7001 Status	Indicator LED on the BHT
	On standby	 OFF
↓	↓	
Place the BHT on the CU-7001.	Normal charging	 ON (in red)
↓	↓	
After approx. 4 hours	Charging completed	 ON (in green)
↓	↓	
Remove the BHT.	On standby	 OFF

5.6 RS-232C Interface Specifications

[1] Interface Connector and Pin Assignment

The CU-7000 has an RS-232C interface port (Dsub-25S).

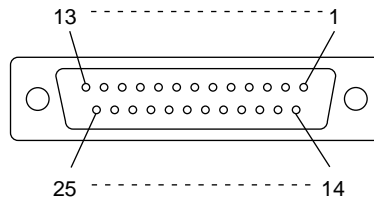

RS-232C interface port (Dsub-25S) on the CU-7000

Pin No.	Signal	Functions	Signal Input/Output	
			CU-7000	External device
1	FG	Frame ground	—	—
2	SD	Send data	→	—
3	RD	Receive data	←	—
4	RS	Request to send	—	—
5	CS	Ready to send	—	—
6	DR	Data set ready	—	—
7	SG	Signal ground	—	—
8	CD	Carrier detect	—	—
20	ER	Data terminal equipment ready	—	—

The input/output voltage threshold for the logical valued signal is listed below.

Logical Value	Input Voltage Threshold	Output Voltage Threshold
0	3V min.	5V min.
1	-3V max.	-5V max.

[2] Interface Cable Connection

As illustrated below, connect the CU-7000 (on which the BHT is put) to a host computer with a cross-mode cable. To connect it to a modem, use a straight-mode cable.

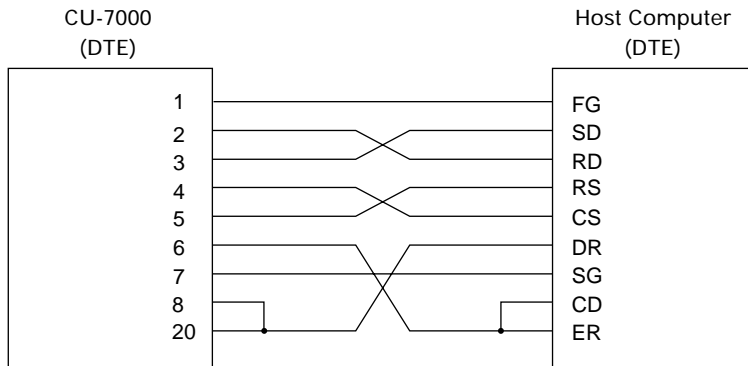

Cable Connection between CU-7000 and Host Computer

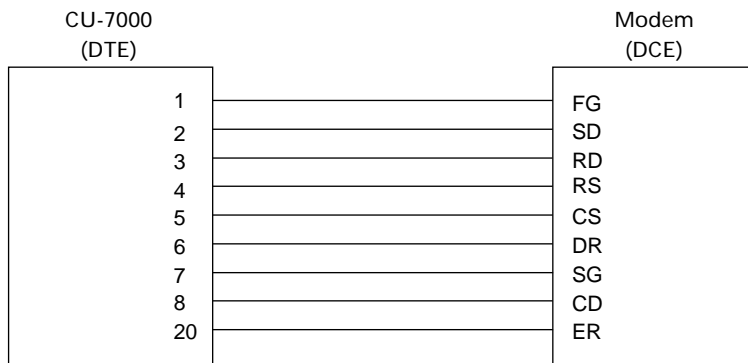

Cable Connection between CU-7000 and Modem

DTE and DCE

In the RS-232C interface specifications, the DTEs (Data Terminal Equipment) shall be generally connected with each other by a cross-mode cable; the DTE and DCE (Data Circuit-terminating Equipment) shall be connected with each other by a straight-mode cable.

The DTE is one piece of equipment connected at both ends of a communications line as a sender or receiver of data (such as CU-7000 on which the BHT is put and a host computer).

The DCE is one piece of equipment connected to the intermediate point between the DTE and the communications line. It terminates communications lines and exchanges information between those lines without any change in contents (such as modem).

Appendix A. Specifications	149
A.1 BHT-100Q	149
[1] Product Specifications	149
[2] Readable Codes	151
[3] Scanning Performance	153
[4] Interface Specifications	155
A.2 BHT-100B	156
[1] Product Specifications	156
[2] Bar Code Specifications	158
[3] Interface Specifications	160
A.3 CU-7000	161
[1] Product Specifications	161
[2] Charging Requirements (CU-7001)	161
[3] Interface Specifications	162
Appendix B. Communications Protocol Details	163
B.1 BHT-protocol	163
[1] Transmission Control Sequences	163
[2] Aborting Data Transmission	171
[3] BCC for Horizontal Parity Checking	172
B.2 BHT-Ir protocol	173
[1] Transmission Control Sequences	173
[2] Aborting Data Transmission	182
[3] CRC	183
[4] ID	183
Appendix C. A Typical Basic Operation	184
Appendix D. Quality Assurance Standards	185
D.1 Applicable Standards	185
D.2 Interface Cables	186

Appendices

Appendix A. Specifications

A.1 BHT-100Q

[1] Product Specifications

Power Source	Main power	<ul style="list-style-type: none"> • Rechargeable lithium-ion battery cartridge (3.6 VDC) or • Dry battery cartridge (two alkaline manganese batteries LR6s)
Dimensions (W) x (L) x (H)		67 x 198 x 29 mm (2.6 x 7.8 x 1.1 inches)
Weight		Approx. 280 g (Approx. 9.9 oz.) including battery cartridge
Operating Ambient Temperature		-5°C to 50°C (23°F to 122°F)
Operating Humidity		20% to 80% (with no dew condensation)
Ambient Illuminance		20 to 10000 lx. (Depth of field: 90 mm, QR code: Ver. 5 (37 x 37 cells), Error correction level: M, Cell pitch: 0.5 mm, PCS value: 0.9 min., Reflection intensity: 85% min. for white) 500 to 3000 lx. (Under the conditions except the above)
Controller		CPU: 32-bit RISC RAM: 1MB Flash memory: 8MB
Keypad		Trigger switches (M3, M4) : 2 Magic keys (M1, M2) : 2 Numerical keys and others : 16

Display

Type: Touch screen, dot-matrix, FSTN liquid crystal display (LCD) with backlight

Formation: Character display
200 dots wide by 304 dots high
Status display
200 dots wide by 16 dots high

Screen mode	Font size	Letter type		Dots (W x H)	Chars x Lines		
Single-byte ANK* mode	Standard-size (12-dot)	ANK	Regular-size	12 x 12	16 x 25		
			Double-width	24 x 12	8 x 25		
			Double-height	12 x 24	16 x 12		
			Quadruple-size	24 x 24	8 x 12		
Two-byte Kanji mode	Standard-size (16-dot)	Full-width	Regular-size	16 x 16	12 x 19		
			Double-width	32 x 16	6 x 19		
			Double-height	16 x 32	12 x 9		
			Quadruple-size	32 x 32	6 x 9		
		Half-width	Regular-size	8 x 16	25 x 19		
			Double-width	16 x 16	12 x 19		
			Double-height	8 x 32	25 x 9		
			Quadruple-size	16 x 32	12 x 9		
			Small-size (12-dot)	Full-width	Regular-size	12 x 12	16 x 25
					Double-width	24 x 12	8 x 25
Double-height	12 x 24	16 x 12					
Quadruple-size	24 x 24	8 x 12					
Half-width	Regular-size	6 x 12		33 x 25			
	Double-width	12 x 12		16 x 25			
	Double-height	6 x 24		33 x 12			
	Quadruple-size	12 x 24		16 x 12			

*ANK: Alphanumerics and Katakana

Calendar Clock

Year, month, day, hour, minute, and second

- Year Two digits (with auto-correction on February 29 for year 1901 to 2099)

Reading Confirmation

Indicator LED (Red & green), beeper, and vibrator

[2] Readable Codes

The values given below are based on the scanning reference position shown in the next item [3]. (Skew angle: 360°)

(1) QR Codes (Model 1 and Model 2) and MicroQR

Code size	Cell pitch
21 x 21 cells to 85 x 85 cells	0.25 mm (9.8 mils)
21 x 21 cells to 61 x 61 cells (105 x 105 cells)* ¹	0.33 mm (13.0 mils)
11 x 11 cells to 17 x 17 cells* ²	0.25 mm (9.8 mils)

*¹ Applies to Model 2.

*² Applies to MicroQR.

(2) PDF417

Number of columns and number of rows	Module size
1 to 5 columns, 3 to 30 rows* ³	0.17 mm (6.7 mils)

*³ Excluding start/stop codes and left and right indicators

(3) MaxiCode

Module size	Module pitch
30 (29) x 33 modules	0.88 mm (34.6 mils)

(4) Data Matrix

Code size	Cell pitch
Max. 80 x 80 cells	0.25 mm
Max. 52 x 52 cells	0.33 mm

(4) Bar Codes

Bar code type	Bar dimensions	Readable range
Universal product codes		
EAN-13	0.26 to 0.33 mm (10.24 to 12.99 mils)	0.8 to 1.0 magnifications
EAN-8	0.26 to 0.46 mm (10.24 to 18.11 mils)	0.8 to 1.4 magnifications
UPC-A	0.26 to 0.33 mm (10.24 to 12.99 mils)	0.8 to 1.0 magnification
UPC-E	0.26 to 0.56 mm (10.24 to 22.05 mils)	0.8 to 1.7 magnifications
Interleaved 2of5 (ITF)	} 0.15 mm min. (5.91 mils)	2 to 34 digits*
Codabar (NW-7)		3 to 23 digits
Code 39		1 to 17 digits
Code 128 (EAN-128)		1 to 21 digits

* Only even-numbered digits

All of the above values are under the following conditions:

- Ambient illuminance: 500 to 3000 lx.
- Light source: Xenon lamp

(5) Multi-line Code Scanning

The BHT-100Q supports multi-line code scanning that can scan up to 3 lines of codes out of universal product codes, Interleaved 2of5 (ITF), Codabar (NW-7), Code 39, and Code 128 (EAN-128) at a time in the specified order.

The multi-line code scanning may be specified in user programs only. For details, refer to the "BHT-BASIC Programmer's Manual (BHT-100 series)."

(6) Optical Properties Required

White cells (white bars):	Reflection intensity	45% min.
Black cells (black bars):	Reflection intensity	25% max.
	PCS value	0.45 min.

[3] Scanning Performance

■ Scanning reference position

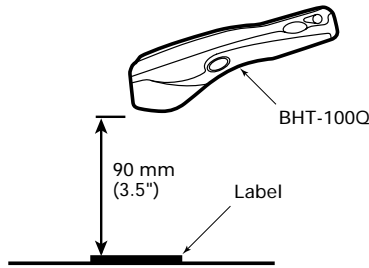

As illustrated at left, align the reading window with the center of the label (code) to be scanned.

■ Scanning distance and area

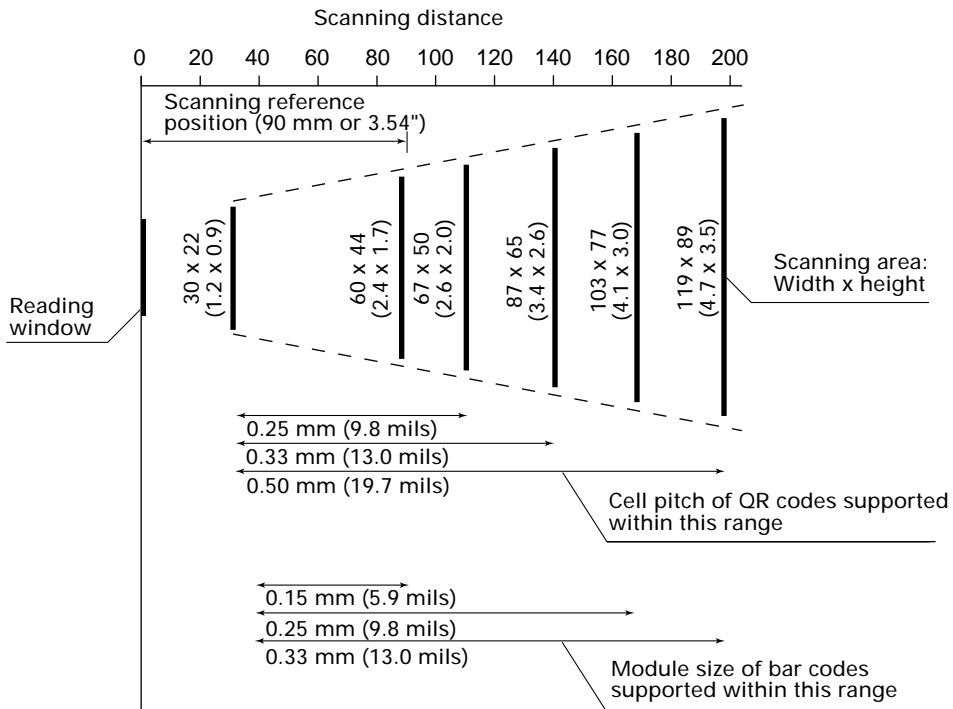

QR codes	Cell pitch	Scanning distance
	0.25 mm (9.8 mils)	30 to 110 mm (1.2 to 4.3 inches)*1
	0.33 mm (13.0 mils)	30 to 140 mm (1.2 to 5.5 inches)*1
	0.50 mm (19.7 mils)	30 to 200 mm (1.2 to 7.9 inches)*2

PCS value: 0.9 min., Reflection intensity: 85% min. for white

*1 Under these conditions: QR code Model 2 Ver. 5 (37 x 37 cells)
Error correction level: M
Black and white label

*2 Under these conditions: QR code Model 2 Ver. 3 (29 x 29 cells)
Error correction level: M
Black and white label

PDF417	Module size	Scanning distance
	0.17 mm (6.7 mils)	40 to 100 mm (1.6 to 3.9 inches) ^{*3}
	0.25 mm (9.8 mils)	40 to 170 mm (1.6 to 6.7 inches) ^{*3}
	0.33 mm (13.0 mils)	40 to 200 mm (1.6 to 7.9 inches) ^{*3}

PCS value: 0.9 min., Reflection intensity: 85% min. for white

^{*3} Under these conditions: 1-column, 11-row, Row height: 3 modules,
Error correction level: 1

MaxiCode	Cell pitch	Scanning distance
	0.88 mm (34.6 mils)	45 to 230 mm (1.8 to 9.1 inches)

PCS value: 0.9 min., Reflection intensity: 85% min. for white

Data Matrix	Cell pitch	Scanning distance
	0.25 mm (9.8 mils)	30 to 110 mm (1.2 to 4.3 inches) ^{*4}
	0.33 mm (13.0 mils)	30 to 140 mm (1.2 to 5.5 inches) ^{*4}
	0.55 mm (21.7 mils)	30 to 200 mm (1.2 to 7.9 inches) ^{*4}

PCS value: 0.9 min., Reflection intensity: 85% min. for white

^{*4} Under these conditions: 36 x 36 cells
Error correction level: ECC200
Black and white label

Bar codes	Module size	Scanning distance
	0.15 mm (5.9 mils)	40 to 90 mm (1.6 to 3.5 inches) ^{*5}
	0.25 mm (9.8 mils)	40 to 170 mm (1.6 to 6.7 inches) ^{*6}
	0.33 mm (13.0 mils)	40 to 200 mm (1.6 to 7.9 inches) ^{*7}

PCS value: 0.9 min., Reflection intensity: 85% min. for white

^{*5} Under these conditions: Codabar 10-digit
Narrow bar, Narrow space: 0.15 mm (5.9 mils)

^{*6} Under these conditions: Codabar 10-digit
Narrow bar, Narrow space: 0.25 mm (9.8 mils)

^{*7} Under these conditions: EAN-8 Module size: 0.33 mm (13.0 mils)

The BHT-100Q may fail to read codes due to specular reflection depending upon the position of the light source, scanning angle of the reading window, and other conditions.

[4] Interface Specifications

Optical Interface

Synchronization: Start-stop
 Input signals: RD
 Output signals: SD
 Transmission speed: 115,200 bps max.

Direct-connect Interface

Synchronization: Start-stop
 Transmission speed: 115,200 bps max.
 Signal level: Conforms to the RS-232C interface
 Pin assignment: As shown below.

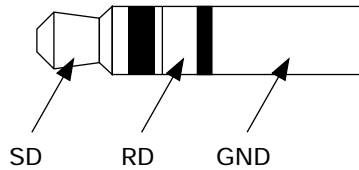

Pin No.	Signal	Functions	Signal Input/Output	
			BHT	External device
1	SG (GND)	Ground for signals	—	
2	SD	Send data	→	
3	RD	Receive data	←	

A.2 BHT-100B

[1] Product Specifications

Power Source	Main power	<ul style="list-style-type: none">• Rechargeable lithium-ion battery cartridge (3.6 VDC) or• Dry battery cartridge (two alkaline manganese batteries LR6s)
Dimensions (W) x (L) x (H)		67 x 198 x 29 mm (2.6 x 7.8 x 1.1 inches)
Weight		Approx. 280 g (Approx. 9.9 oz.) including battery cartridge
Operating Ambient Temperature		-5°C to 50°C (23°F to 122°F)
Operating Humidity		20% to 80% (with no dew condensation)
Ambient Illuminance		500 to 3000 lx. (Depth of field: 30 mm, PCS value: 0.9 min., Reflection intensity: 85% min. for white and 5% max. for black, Narrow bar width: 0.125 mm min.) 20 to 10000 lx. (Depth of field: 250 mm, ITF: 1.0 magnification, PCS value: 0.9 min., Reflection intensity: 85% min. for white and 5% max. for black)
Controller		CPU: 32-bit RISC RAM: 512KB Flash memory: 4MB
Keypad		Trigger switches (M3, M4) : 2 Magic keys (M1, M2) : 2 Numerical keys and others : 16

Display

Type: Touch screen, dot-matrix, FSTN liquid crystal display (LCD) with backlight

Formation: Character display
 200 dots wide by 304 dots high
 Status display
 200 dots wide by 16 dots high

Screen mode	Font size			Dots (W x H)	Chars x Lines		
Single-byte ANK* mode	Standard-size (12-dot)	ANK	Normal-size	12 x 12	16 x 25		
			Double-width	24 x 12	8 x 25		
			Double-height	12 x 24	16 x 12		
			Quadruple-size	24 x 24	8 x 12		
Two-byte Kanji mode	Standard-size (16-dot)	Full-width	Normal-size	16 x 16	12 x 19		
			Double-width	32 x 16	6 x 19		
			Double-height	16 x 32	12 x 9		
			Quadruple-size	32 x 32	6 x 9		
		Half-width	Normal-size	8 x 16	25 x 19		
			Double-width	16 x 16	12 x 19		
			Double-height	8 x 32	25 x 9		
			Quadruple-size	16 x 32	12 x 9		
			Small-size (12-dot)	Full-width	Normal-size	12 x 12	16 x 25
					Double-width	24 x 12	8 x 25
Double-height	12 x 24	16 x 12					
Quadruple-size	24 x 24	8 x 12					
Half-width	Normal-size	6 x 12		33 x 25			
	Double-width	12 x 12		16 x 25			
		Double-height	6 x 24	33 x 12			
		Quadruple-size	12 x 24	16 x 12			

*ANK: Alphanumerics and Katakana

Calendar Clock

Year, month, day, hour, minute, and second

- Year Two digits (with auto-correction on February 29 for year 1901 to 2099)

Reading Confirmation

Indicator LED (Red & green), beeper, and vibrator

[2] Bar Code Specifications

(1) Available Bar Code Types

Bar code type	Bar dimensions	Readable magnification
Universal product codes		
EAN-13	0.26 mm min. (10.24 mils min.)	0.8 min.
EAN-8		
UPC-A		
UPC-E		
EAN-13 with supplemental codes		
EAN-8 with supplemental codes		
UPC-A with supplemental codes		
UPC-E with supplemental codes 2-digit add-on 5-digit add-on		
Interleaved 2of5 (ITF)	0.125 mm min. (4.92 mils min.) [PCS value \geq 0.75 Reflection intensity difference between white and black bars \geq 0.4]	
Standard 2of5 (STF)		
Codabar (NW-7)		
Code 39		
Code 93	0.15 mm min. (5.91 mils min.) (PCS value \geq 0.45)	
Code 128 (EAN-128)		

(2) Optical Properties Required

White bars: Reflection intensity	45% min.
Black bars: Reflection intensity	25% max.
PCS value	0.45 min.

(3) Bar Code Label Size

Recommended width: 10 mm min. (0.39 inch min.)

Length:	Depth of field (Distance from bar codes to the reading window)	Length of labels (including margins)
	400 mm (15.75 inches)	380 mm max. (14.96 inches max.) (Minimum narrow bar width: 1.0 mm min.)* ⁴

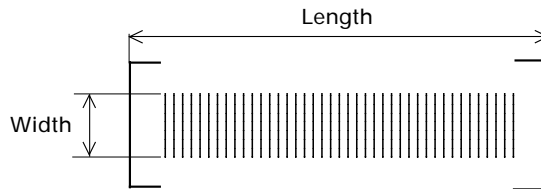

(4) Thickness of Bars and Depth of Field

Minimum narrow bar width	Depth of field
0.125 mm (4.92 mils)	0 to 30 mm (0 to 1.18 inches)* ¹
0.15 mm (5.91 mils)	0 to 70 mm (0 to 2.76 inches)* ²
0.33 mm (12.99 mils)	0 to 150 mm (0 to 5.91 inches)* ³
1.0 mm (39.37 mils)	140 to 350 mm (5.51 to 13.78 inches)* ⁴
1.2 mm (47.24 mils)	160 to 400 mm (6.30 to 15.75 inches)* ⁵

*¹ Under the following conditions:
 - Ambient illuminance: 500 lx. (Fluorescent lamp)
 - Code 39, 19-digit
 Narrow bar : Wide bar = 1 : 2.2
 - Reflection intensity of white bars: 85% min.
 Reflection intensity of black bars: 5% max.

*² Under the following conditions:
 - Ambient illuminance: 500 lx. (Fluorescent lamp)
 - Code 39, 6-digit
 Narrow bar : Wide bar = 1 : 2.2
 - Reflection intensity of white bars: 85% min.
 Reflection intensity of black bars: 5% max.

*³ Under the following conditions:
 - Ambient illuminance: 500 lx. (Fluorescent lamp)
 - EAN-13, 1.0 magnification
 - Reflection intensity of white bars: 85% min.
 Reflection intensity of black bars: 5% max.

*⁴ Under the following conditions:
 - Ambient illuminance: 500 lx. (Fluorescent lamp)
 - ITF conforming to the UPC Shipping Container Code
 - Reflection intensity of white bars: 85% min.
 Reflection intensity of black bars: 5% max.
 - 1.0 magnification

*⁵ Under the following conditions:
 - Ambient illuminance: 500 lx. (Fluorescent lamp)
 - ITF conforming to the UPC Shipping Container Code
 Narrow bar : Wide bar = 1 : 2.2
 - Reflection intensity of white bars: 85% min.
 Reflection intensity of black bars: 5% max.
 - 1.2 magnification

[3] Interface Specifications

Optical Interface

Synchronization: Start-stop
 Input signals: RD
 Output signals: SD
 Transmission speed: 115,200 bps max.

Direct-connect Interface

Synchronization: Start-stop
 Transmission speed: 115,200 bps max.
 Signal level: Conforms to the RS-232C interface
 Pin assignment: As shown below.

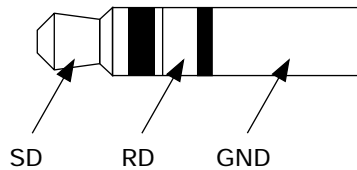

Pin No.	Signal	Functions	Signal Input/Output	
			BHT	External device
1	SG (GND)	Ground for signals	—	
2	SD	Send data	→	
3	RD	Receive data	←	

A.3 CU-7000

[1] Product Specifications

Power Source

- Europe	230 VAC, 16 VA
- U.S.	120 VAC, 13 VA
-Australia	10 to 18 VDC, 450 mA (on 12 VDC)

Power Consumption

8 VA max.

Dimensions

(W) x (L) x (H)

112 x 148 x 84 mm
(4.41 x 5.83 x 3.31 inches)

Weight

CU-7001: Approx. 230 g (Approx. 8.11 oz.)
CU-7002: Approx. 200 g (Approx. 7.06 oz.)

Operating Ambient Temperature 0°C to 40°C (32°F to 104°F)

Operating Humidity 20% to 80% (with no dew condensation)

[2] Charging Requirements (CU-7001)

Charge current: Approx. 600 mA

Charge time: Approx. 4 hours

[3] Interface Specifications

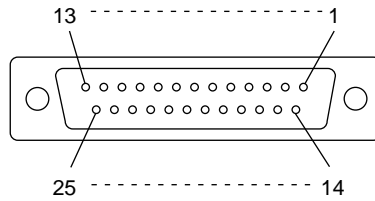

RS-232C Interface Port (Dsub-25S) on the CU-7000

Pin No.	Signal	Functions	Signal Input/Output	
			CU-7000	External device
1	FG	Frame ground	—	—
2	SD	Send data	→	—
3	RD	Receive data	←	—
4	RS	Request to send	—	—
5	CS	Ready to send	—	—
6	DR	Data set ready	—	—
7	SG	Signal ground	—	—
8	CD	Carrier detect	—	—
20	ER	Data terminal equipment ready	—	—

NOTE Shown below is a diagram of the internal connection in the CU-7000.

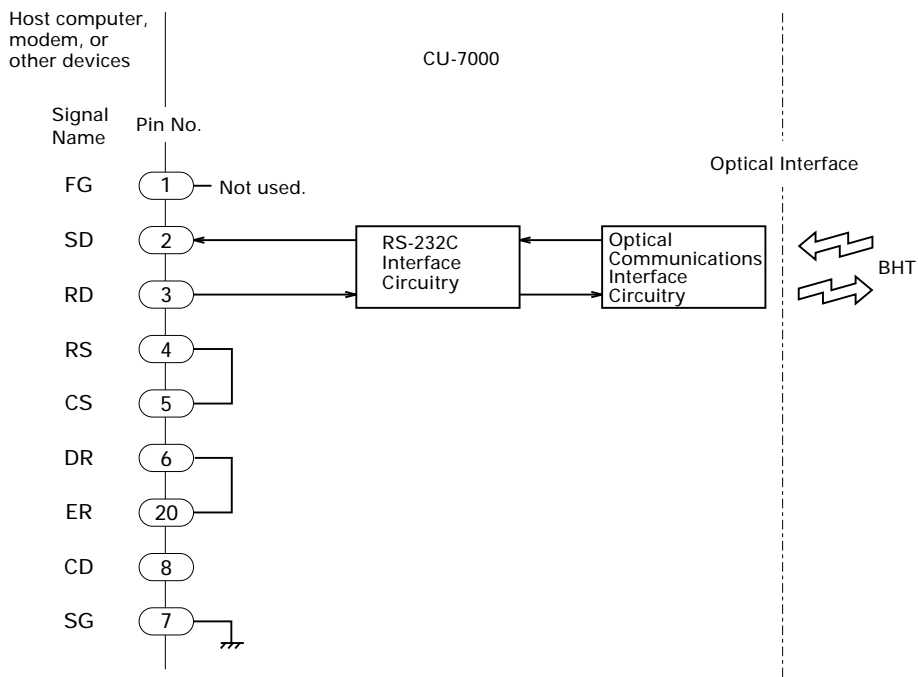

Appendix B. Communications Protocol Details

B.1 BHT-protocol

[1] Transmission Control Sequences

Shown below is a typical message transmission sequence supported by the BHT-protocol. This sequence example does not include transmission errors or negative responses.

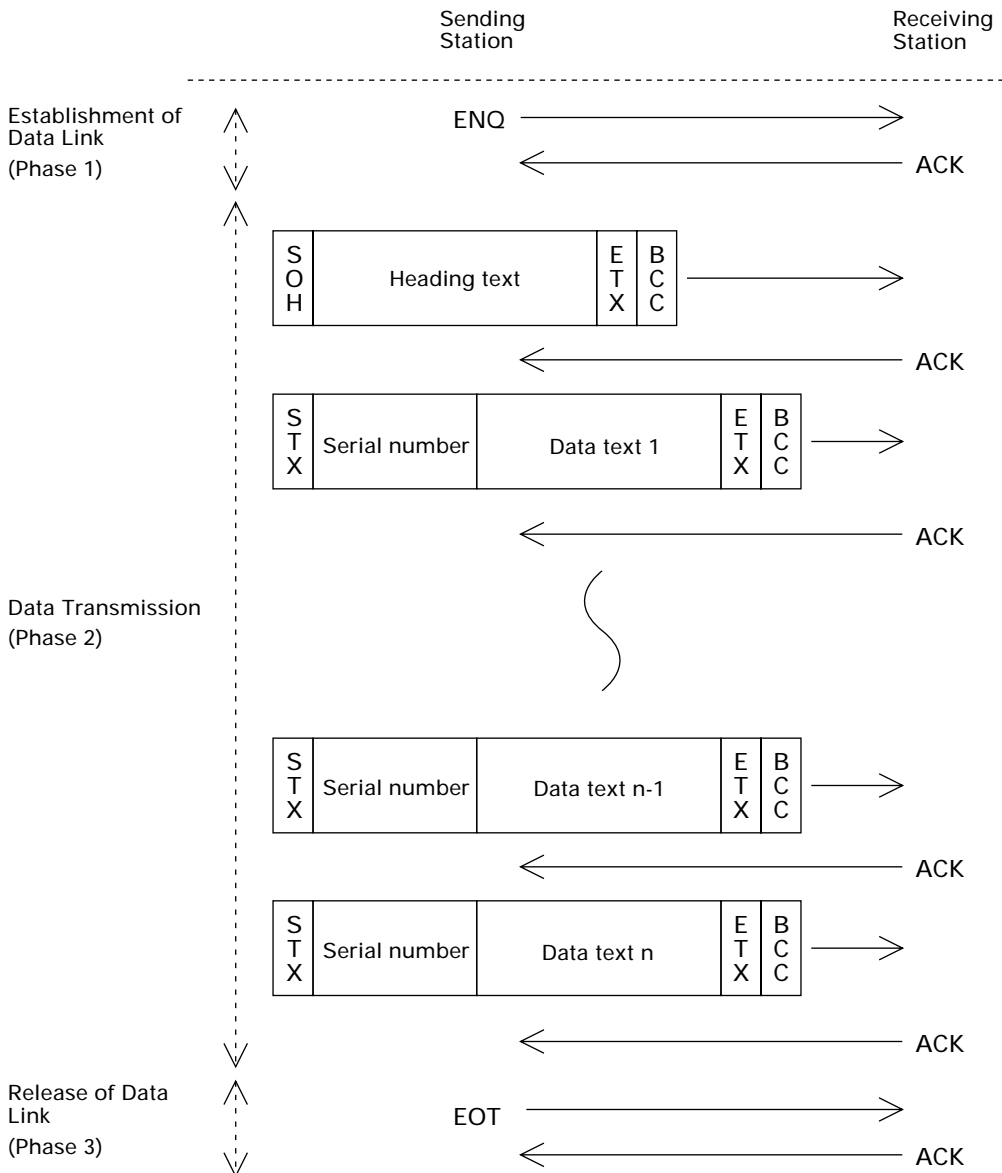

Data transmission may accidentally involve various types of errors. The BHT-protocol is designed to recover from those errors as frequently as possible.

What follows is the BHT-protocol for phases 1 through 3.

Phase 1: Establishment of Data Link

■ Normal phase 1

The sending station transmits an ENQ to the receiving station. Upon receipt of an ACK from the receiving station, the sending station shifts to phase 2.

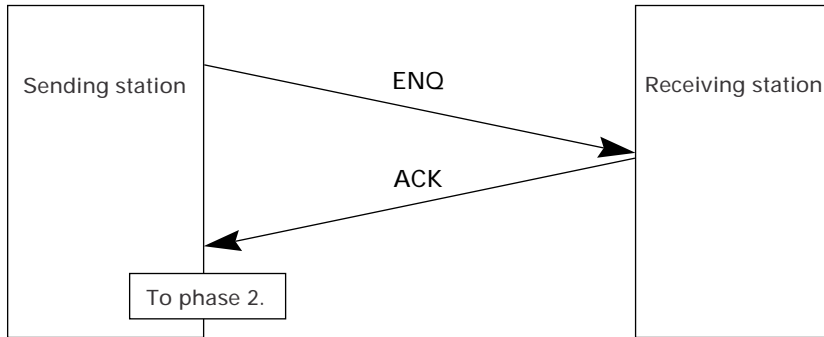

■ Phase 1 with iterated ENQ transmission due to no response or invalid response

If the sending station receives no response or any invalid response from the receiving station in response to an ENQ sent, it iterates sending of an ENQ at three-second intervals up to 10 times.

If the sending station receives an ACK before sending an ENQ ten times, it shifts to phase 2.

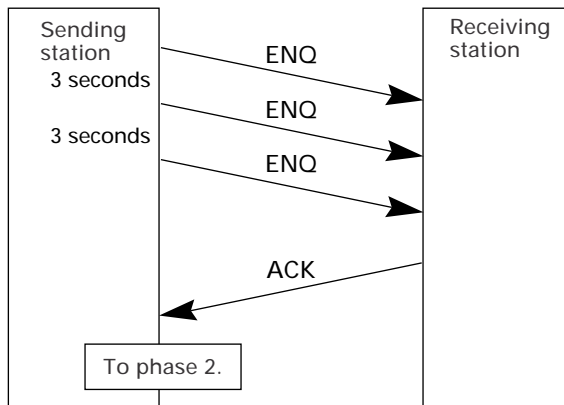

TIP

You may modify the number of ENQ iterations for the sending station. The default is 10 times at three-second intervals. For details, refer to the SET PROTOCOL screen in System Mode (pp. 65 and 67) and the XFILE statement given in "BHT-BASIC Programmer's Manual (BHT-100 series)."

■ Abnormal termination of phase 1 (Abort of phase 1)

If the sending station receives no ACK from the receiving station after sending an ENQ 10 times in succession, it sends an EOT to the receiving station after three seconds from the 10th ENQ to terminate the message transmission abnormally.

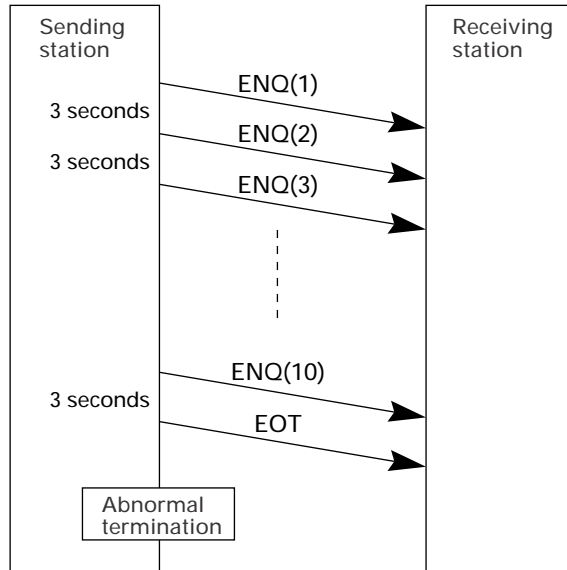

TIP

The receiving station's default timeout is 30 seconds. You may modify the timeout length on the SET PROTOCOL screen in System Mode (pp. 65 and 67) or by using the XFILE statement (refer to the "BHT-BASIC Programmer's Manual (BHT-100 series).")

Phase 2: Data Transmission

■ Normal phase 2

The sending station first sends a transmission block containing the heading text. Each time the sending station receives an ACK from the receiving station, it sends a transmission block containing the data texts as shown below. Upon receipt of an ACK in response to the last transmission block (data text n), the sending station shifts to phase 3.

If a transmission message contains no data text, the sending station transmits the heading text only.

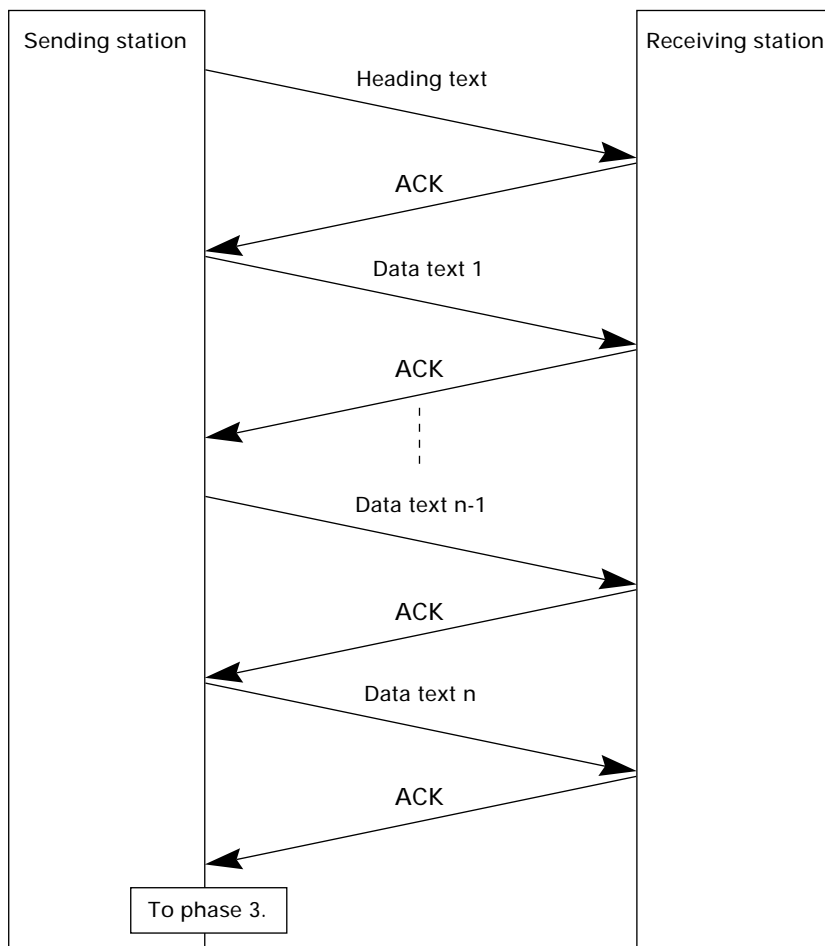

■ **Phase 2 with NAK**

If the sending station receives a NAK from the receiving station in response to a transmission block containing text data m , it sends that transmission block again immediately as shown below.

If the sending station receives an ACK before receiving a NAK 10 times in succession, it continues the subsequent message transmission.

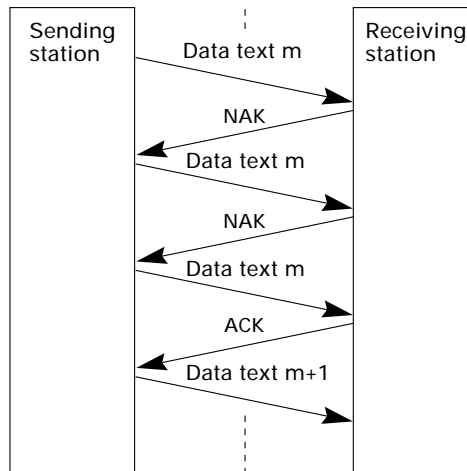

If the sending station receives a NAK 10 times in succession or it fails to send a same transmission block, it shifts to phase 3 to terminate the message transmission abnormally. Even if phase 3 terminates normally, the transmission results in an abnormal end.

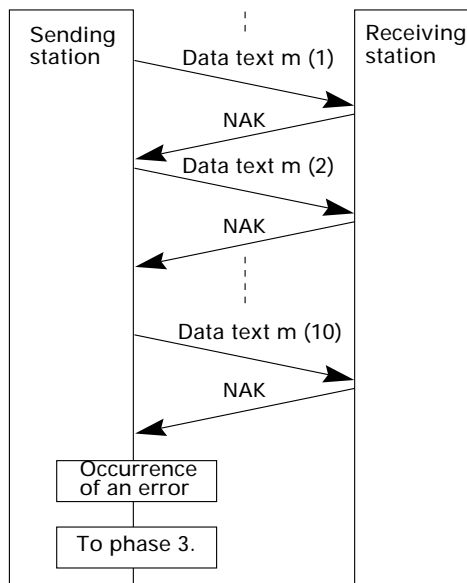

■ Phase 2 with EOT

If the sending station receives an EOT anytime during phase 2, it shifts to phase 3 to terminate the message transmission abnormally. Even if phase 3 terminates normally, the transmission results in an abnormal end.

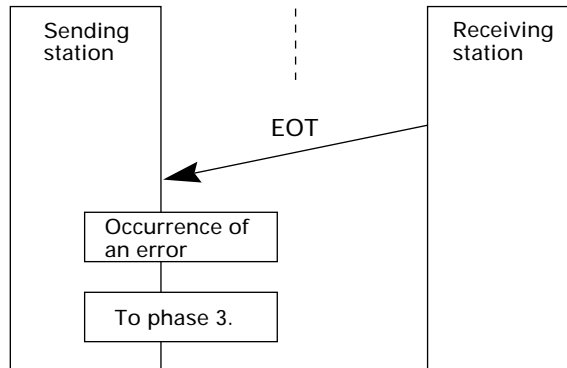

■ Phase 2 with iterated ENQ transmission due to no response or invalid response

If the sending station receives no response or any invalid response from the receiving station in response to a transmission block sent, it iterates sending of an ENQ at three-second intervals up to nine times.

If the sending station receives an ACK before sending an ENQ nine times, it continues the subsequent message transmission.

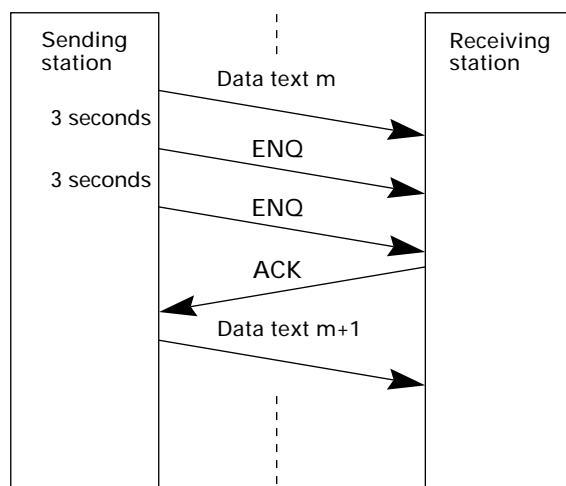

■ **Abnormal termination of phase 2 (Abort of phase 2)**

If the sending station receives no ACK from the receiving station after sending an ENQ nine times in succession, it sends an EOT to the receiving station after 3 seconds from the 9th ENQ to terminate this transmission sequence abnormally.

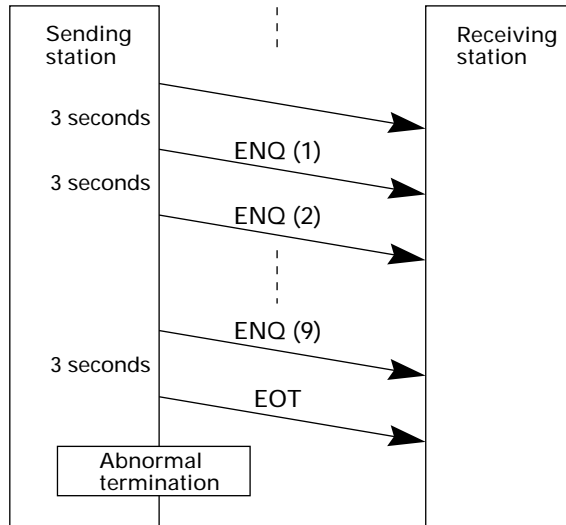

Phase 3: Release of Data Link

■ **Normal phase 3**

The sending station transmits an EOT to the receiving station. Upon receipt of an ACK from the receiving station, the sending station terminates the message transmission normally and releases the data link.

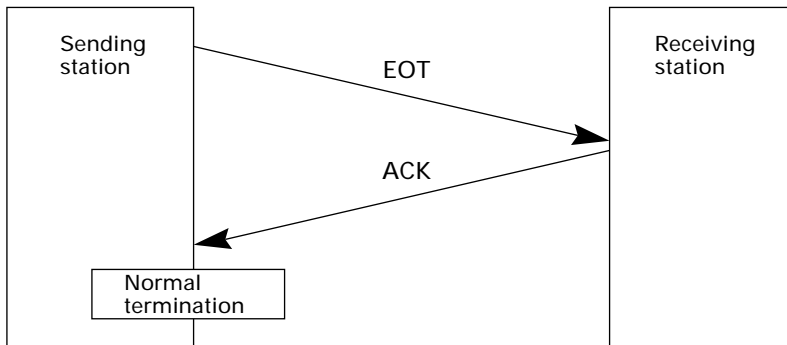

■ Phase 3 with iterated EOT transmission due to no response or invalid response

If the sending station receives no response or any invalid response from the receiving station in response to an EOT sent, it iterates sending of an EOT at three-second intervals up to ten times.

If the sending station receives an ACK before sending an EOT ten times, it terminates the message transmission normally and releases the data link.

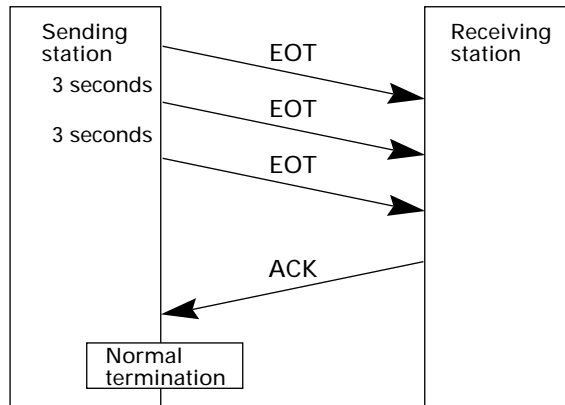

■ Abnormal termination of phase 3

If the sending station receives no ACK from the receiving station within three seconds from the 10th EOT, it terminates the message transmission abnormally and releases the data link.

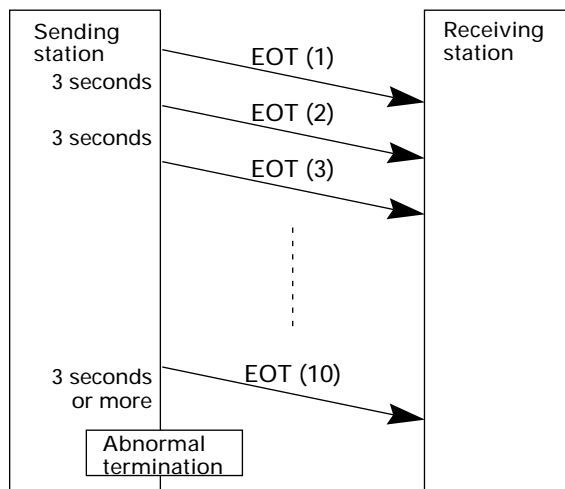

[2] Aborting Data Transmission

Pressing the **C** key aborts data transmission.

If the **C** key is pressed during downloading, the BHT transmits an EOT and aborts the file transmission.

If it is pressed during uploading, the BHT transmits the current transmission block followed by EOT and then aborts the file transmission.

[3] BCC for Horizontal Parity Checking

To check whether data has been transmitted accurately, the BHT supports horizontal parity checking for every transmission block.

In horizontal parity checking, a horizontal parity byte so called BCC (Block Check Character) is suffixed to an ETX of every transmission block.

In the BHT-protocol, every parity bit of BCC is set so that all set bits at the same bit level (including a parity bit) in the characters contained in the transmission block have an even number by binary addition, excluding SOH, STX, and functions SOH\$ and STX\$.

(For details about SOH\$ and STX\$ which are protocol functions unique to BHT-BASIC, refer to the "BHT-BASIC Programmer's Manual (BHT-100 series).")

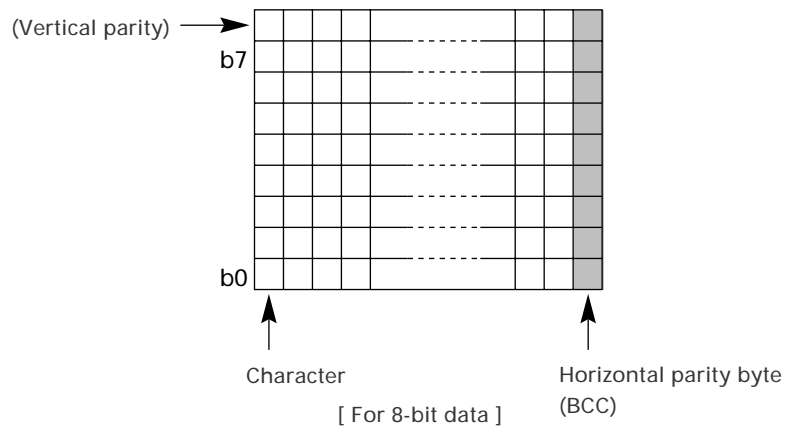

Shown below is a data text block indicating the bits to be added for horizontal parity checking.

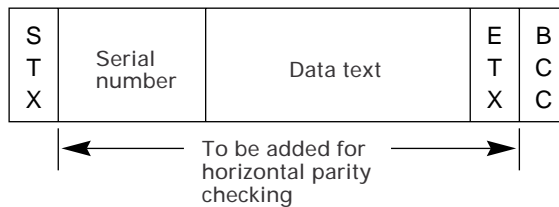

B.2 BHT-Ir protocol

[1] Transmission Control Sequences

Shown below is a typical message transmission sequence supported by the BHT-Ir protocol. This sequence example does not include transmission errors or negative responses.

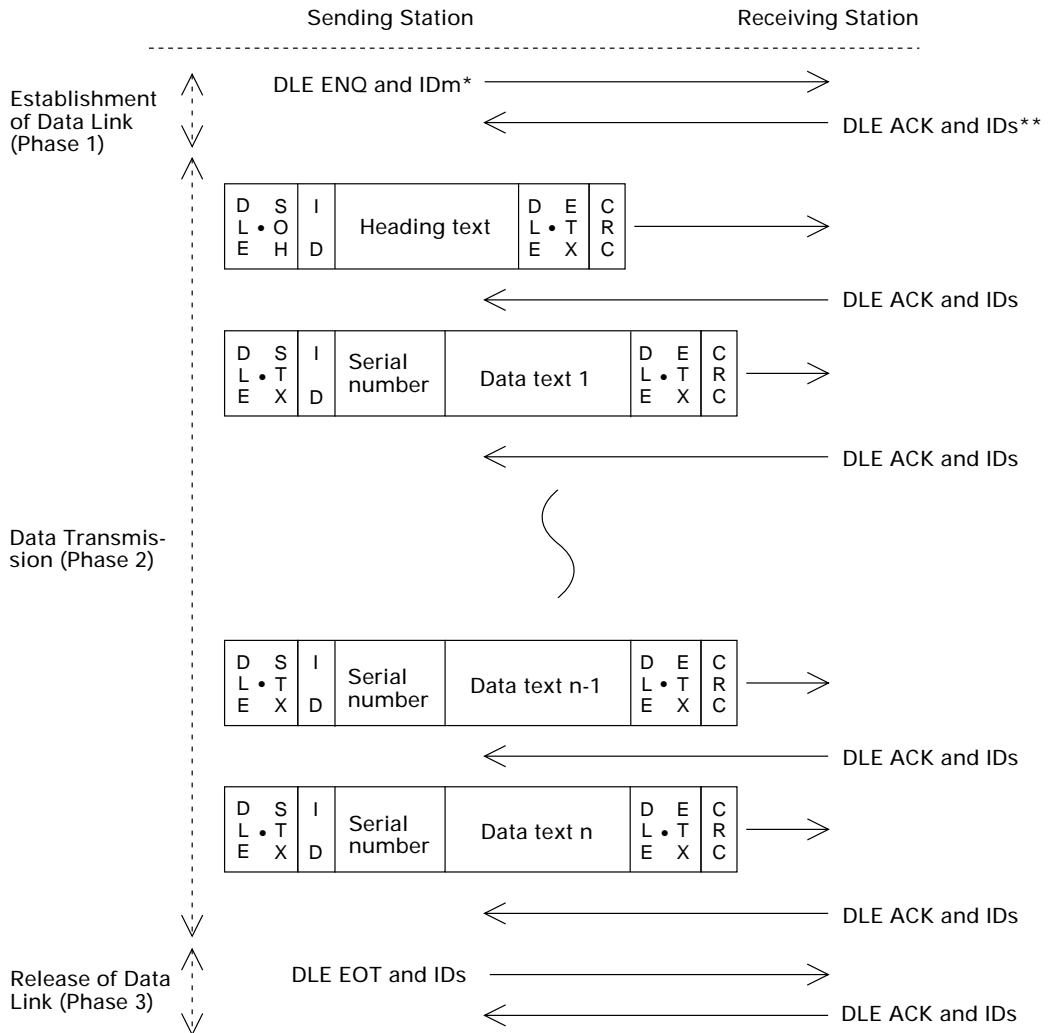

*IDm: ID of sending station

**IDs: ID of receiving station

Data transmission may accidentally involve various types of errors. The BHT-Ir protocol is designed to recover from those errors as frequently as possible.

What follows is the BHT-Ir protocol for phases 1 through 3.

Phase 1: Establishment of Data Link

■ Normal phase 1

The sending station transmits a sequence of DLE ENQ and IDm (sending station's ID) to the receiving station. Upon receipt of a sequence of DLE ACK and IDs (receiving station's ID) from the receiving station, the sending station shifts to phase 2.

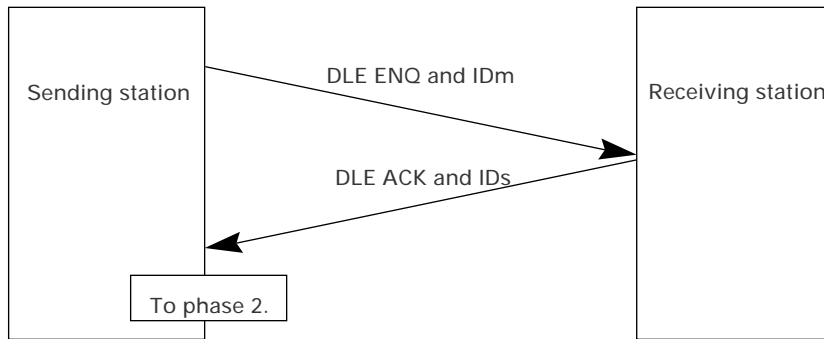

■ Phase 1 with iterated transmission of DLE ENQ and IDm due to no response or invalid response

If the sending station receives no response or any invalid response from the receiving station in response to the sent sequence of DLE ENQ and IDm, it iterates sending of the sequence at 0.5-second intervals up to 60 times.

If the sending station receives a sequence of DLE ACK and IDs before sending the sequence of DLE ENQ and IDm 60 times, it shifts to phase 2.

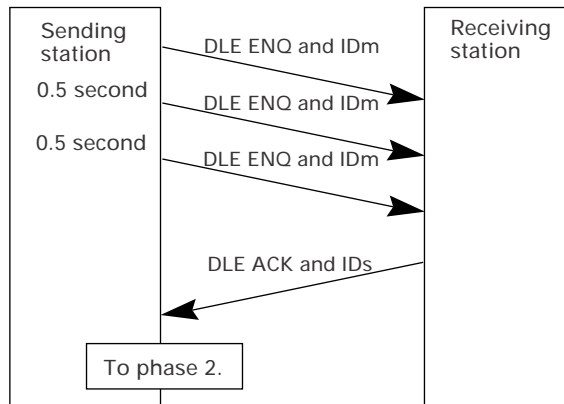

TIP

You may modify the number of iterations of a sequence of DLE ENQ and IDm for the sending station. The default is 60 times at 0.5-second intervals. For details, refer to the SET PROTOCOL screen in System Mode (pp. 65 and 67) and the XFILE statement given in "BHT-BASIC Programmer's Manual (BHT-100 series.)"

■ Abnormal termination of phase 1 (Abort of phase 1)

If the sending station receives no sequence of DLE ACK and IDs from the receiving station after sending a sequence of DLE ENQ and IDm 60 times in succession, it sends a sequence of DLE EOT and IDm to the receiving station after 0.5 second from the 60th sequence of DLE ENQ and IDm, then aborts the message transmission abnormally.

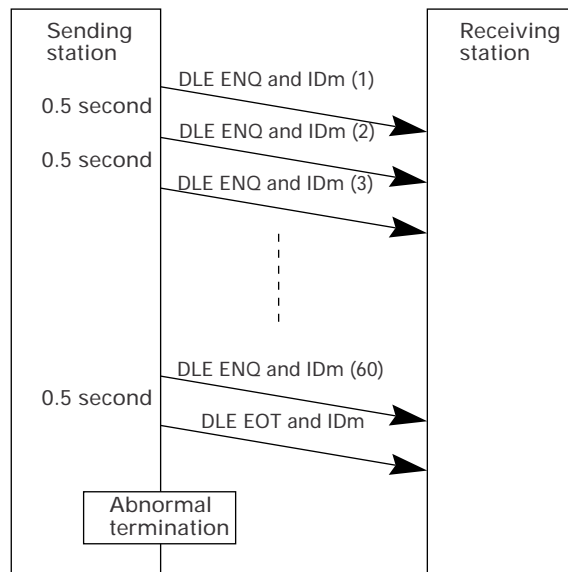

TIP

The receiving station's default timeout is 30 seconds. You may modify the timeout length on the SET PROTOCOL screen in System Mode (pp. 65 and 67) or by using the XFILE statement (refer to the "BHT-BASIC Programmer's Manual (BHT-100 series).")

Phase 2: Data Transmission

■ Normal phase 2

The sending station first sends a transmission block containing the heading text. Each time the sending station receives a sequence of DLE ACK and IDs from the receiving station, it sends a transmission block containing the data texts as shown below. Upon receipt of a sequence of DLE ACK and IDs in response to the last transmission block (data text n), the sending station shifts to phase 3.

If a transmission message contains no data text, the sending station transmits the heading text only.

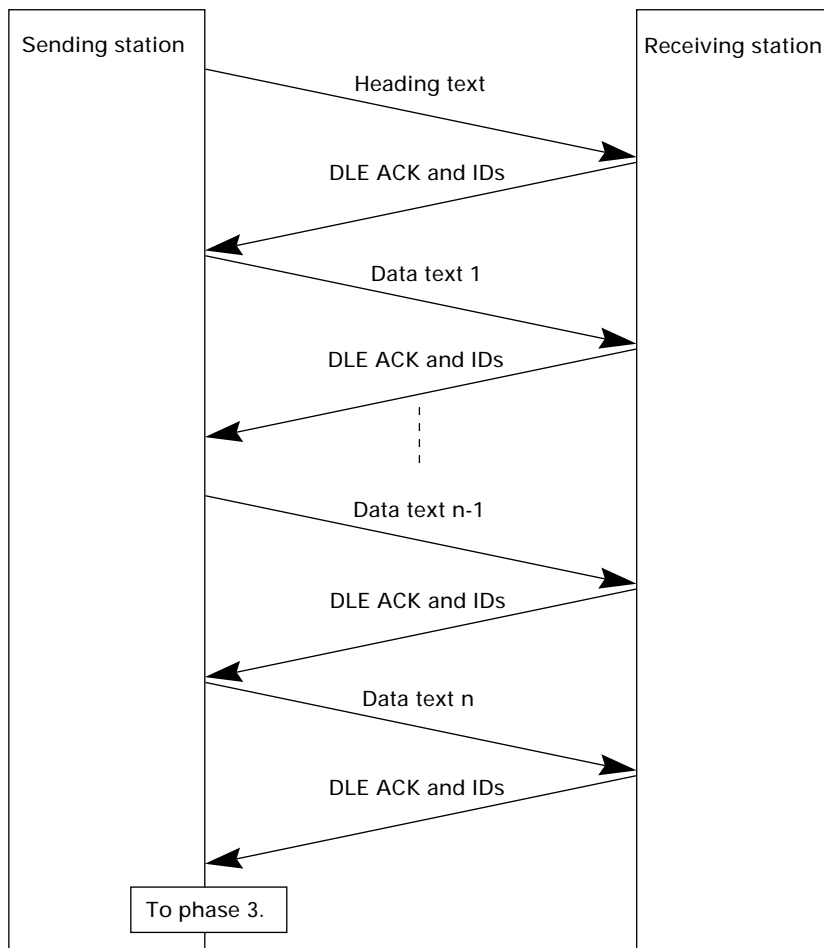

■ **Phase 2 with suspension of data reception for erasure of the flash memory**

If the receiving BHT requires the flash memory to be erased for receiving downloaded files, it sends a sequence of WACK and IDs to the sending station to suspend the data transmission.

Upon receipt of the sequence of WACK and IDs, the sending station stops the data transmission until any response comes from the receiving station for one minute. If no response comes within one minute, the sending station sends a sequence of DLE EOT and IDs and then aborts the current transmission.

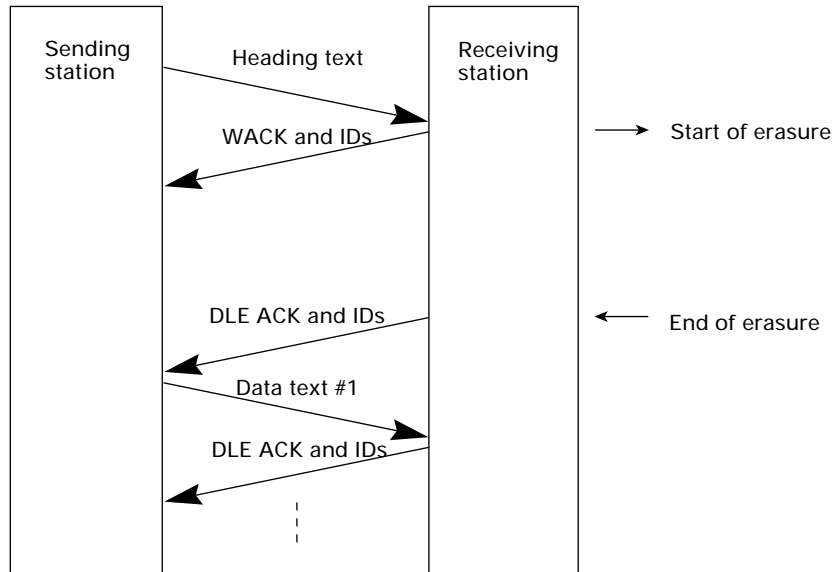

■ Phase 2 with a sequence of DLE NAK and IDs

If the sending station receives a sequence of DLE NAK and IDs from the receiving station in response to a transmission block containing text data m , it sends that transmission block again immediately as shown below.

If the sending station receives a sequence of DLE ACK and IDs before receiving the sequence of DLE NAK and IDs 10 times in succession, it continues the subsequent message transmission.

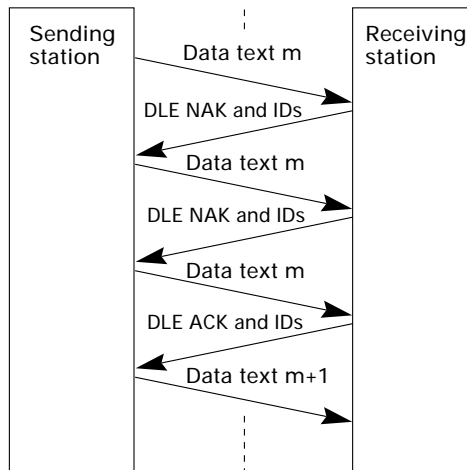

If the sending station receives a sequence of DLE NAK and IDs 10 times in succession or it fails to send a same transmission block, it shifts to phase 3 to terminate the message transmission abnormally. Even if phase 3 terminates normally, the transmission results in an abnormal end.

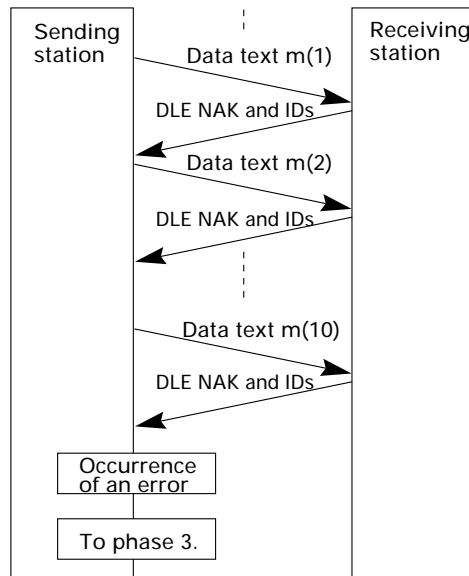

■ **Phase 2 with a sequence of DLE EOT and IDs**

If the sending station receives a sequence of DLE EOT and IDs anytime during phase 2, it shifts to phase 3 to terminate the message transmission abnormally. Even if phase 3 terminates normally, the transmission results in an abnormal end.

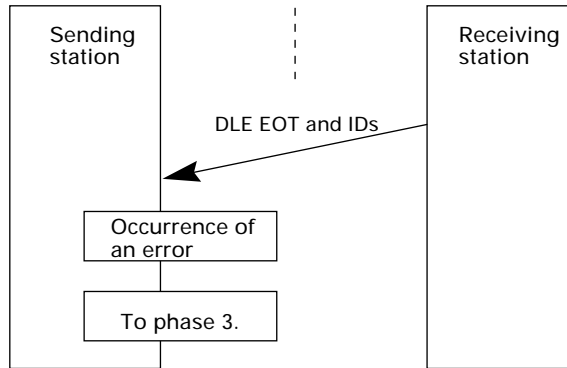

■ **Phase 2 with iterated transmission of DLE ENQ and IDs due to no response or invalid response**

If the sending station receives no response or any invalid response from the receiving station in response to a transmission block sent, it iterates sending of a sequence of DLE ENQ and IDs at 0.5-second intervals up to 59 times.

If the sending station receives a sequence of DLE ACK and IDs before sending the sequence of DLE ENQ and IDs 59 times, it continues the subsequent message transmission.

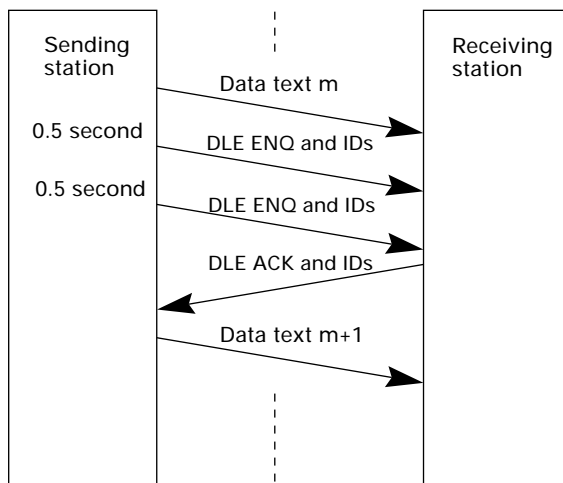

■ Abnormal termination of phase 2 (Abort of phase 2)

If the sending station receives no sequence of DLE ACK and IDs from the receiving station after sending a sequence of DLE ENQ and IDs 59 times in succession, it sends a sequence of DLE EOT and IDs to the receiving station after 0.5 second from the 59th sequence of DLE ENQ and IDs and then aborts this transmission abnormally.

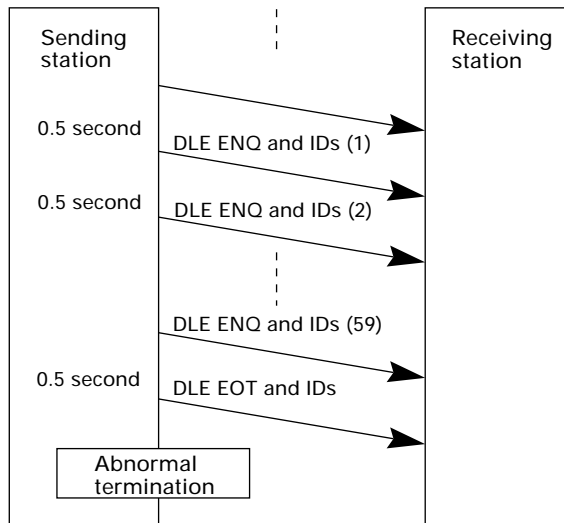

Phase 3: Release of Data Link

■ Normal phase 3

The sending station transmits a sequence of DLE EOT and IDs to the receiving station. Upon receipt of a sequence of DLE ACK and IDs from the receiving station, the sending station terminates the message transmission normally and releases the data link.

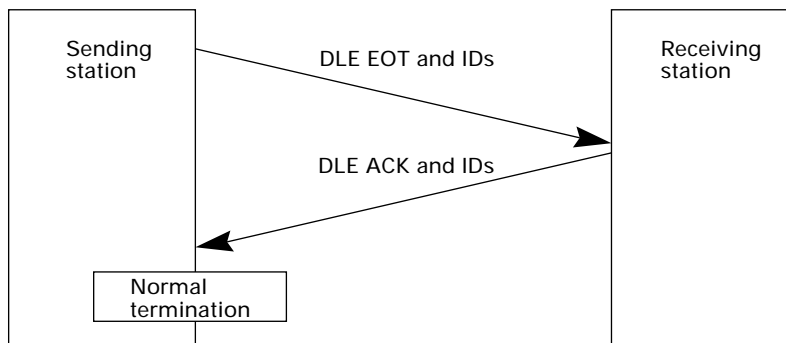

■ **Phase 3 with iterated transmission of DLE EOT and IDs due to no response or invalid response**

If the sending station receives no response or any invalid response from the receiving station in response to the sent sequence of DLE EOT and IDs, it iterates sending of the sequence at 0.5-second intervals up to 60 times.

If the sending station receives a sequence of DLE ACK and IDs before sending the sequence of DLE EOT and IDs 60 times, it terminates the message transmission normally and releases the data link.

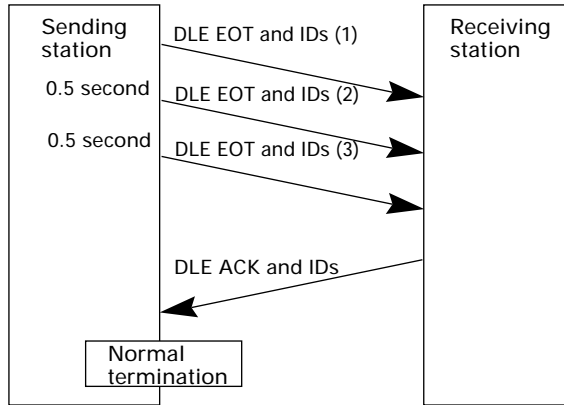

■ **Abnormal termination of phase 3**

If the sending station receives no sequence of DLE ACK and IDs from the receiving station within 0.5 second from the 60th sequence of DLE EOT and IDs, it aborts the message transmission abnormally and releases the data link.

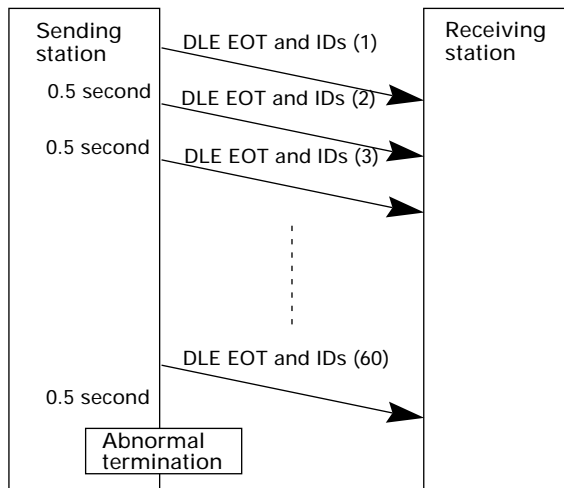

■ Phase 3 with timeout at the receiving station

If the receiving station receives no subsequent text or normal sequence of DLE EOT and IDs within 30 seconds after sending a sequence of DLE ACK and IDs, it sends a sequence of DLE EOT and IDs and aborts the transmission abnormally.

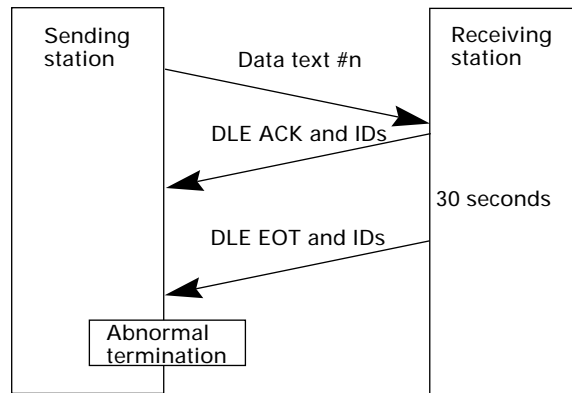

[2] Aborting Data Transmission

Pressing the **C** key aborts data transmission.

If the **C** key is pressed during downloading, the BHT transmits a sequence of DLE EOT and IDs and aborts the file transmission.

If it is pressed during uploading, the BHT transmits the current transmission block followed by a sequence of DLE EOT and IDs and then aborts the file transmission.

[3] CRC

To check whether data has been transmitted accurately, the BHT-Ir protocol supports CRC (Cyclic Redundancy Check) which employs the CRC-16 generating system. In CRC, a CRC character is suffixed to a sequence of DLE ETX of every transmission block.

Operands for CRC-16

The CRC generates CRC-16 from all bytes of a transmission block excluding DLE SOH or DLE STX characters (which are at the head of a transmission block), DLE character of DLE ETX and DLE character of DLE DLE in the text.

CRC operation

The CRC system generates CRC-16 as follows: It multiplies the polynomial formed by aligning all of the bits starting from the LSB of the first byte to the MSB of the last byte in a transmission block in descending order, by X^{16} . Next, divide the polynomial by the generative polynomial $X^{16} + X^{15} + X^2 + 1$. The remainder is the value of CRC-16.

Shown below is a data text transmission block and operands for CRC-16 generation.

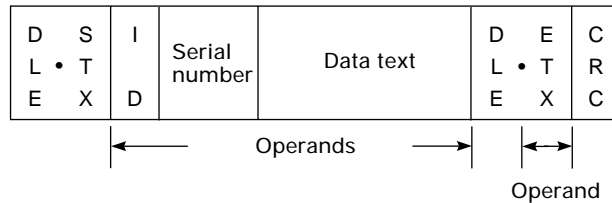

[4] ID

ID is a 2-digit hexadecimal and designated in 0000h through FFFFh in (2 bytes). 0000h is assigned to the host computer. Any of 0001h through FFFFh is assigned to the BHT as follows.

- The system sets an ID when the BHT is initialized.
- You may set an arbitrary ID in System Mode or by using the OUT statement in BHT-BASIC.

Appendix C.

A Typical Basic Operation

What follows is a typical basic operation which helps you instruct the hands-on user in practical bar-code reading operation.

Application type: Inventory

Operation: Power ON → Read the 2D code or bar code on stock (A). → Key in the quantity.

Read the 2D code or bar code on stock (B). → Key in the quantity.

⋮

Repeat the above operation.

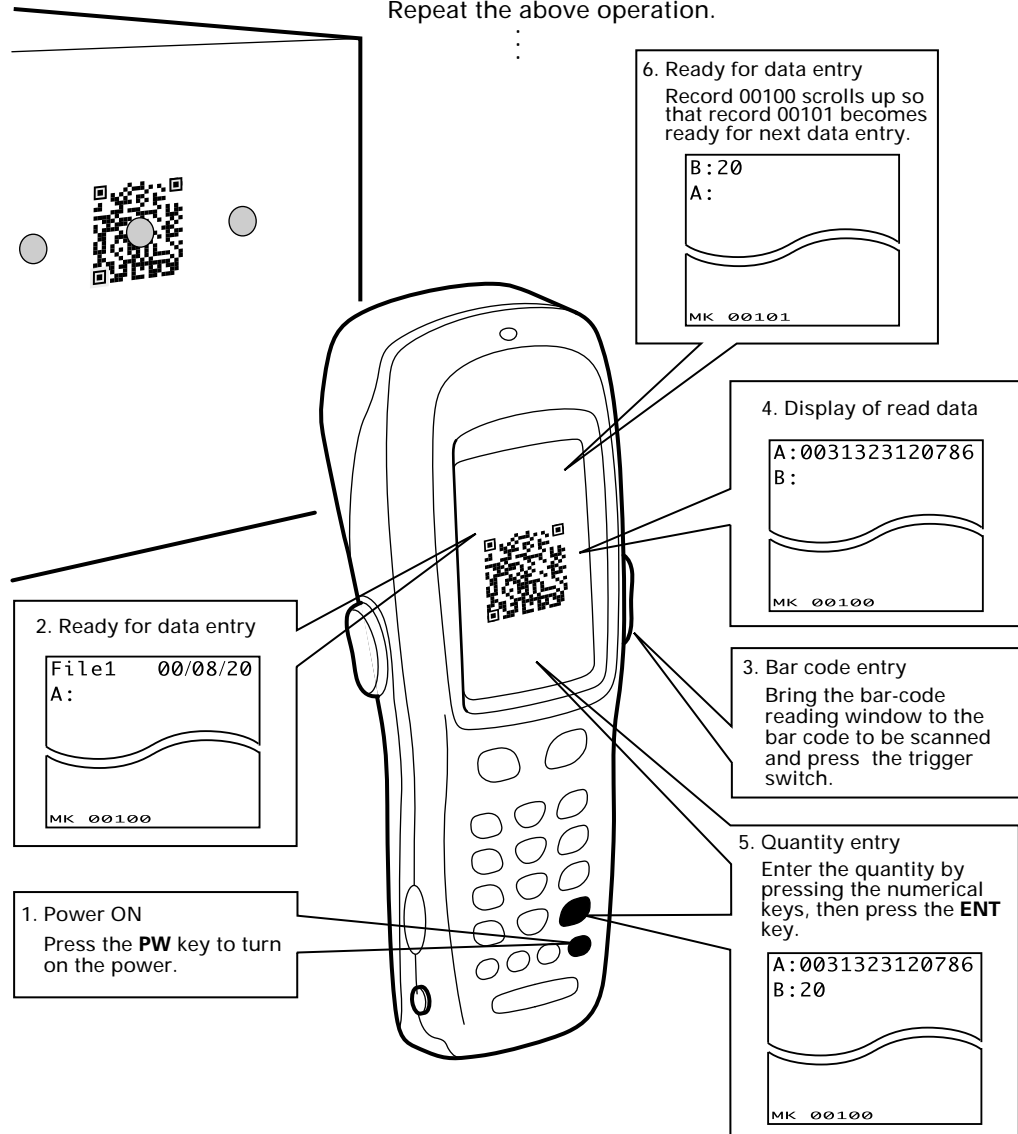

Appendix D.

Quality Assurance Standards

D.1 Applicable Standards

	Standards	Conditions*	Remarks
Noise Standards	VCCI	A	Class B
	FCC Part 15	A	Class A
	EMC Directive EN55024: 1998 IEC 61000-4-2 (1995) IEC 61000-4-3 (1995) IEC 61000-4-4 (1995) IEC 61000-4-5 (1995) IEC 61000-4-6 (1996) IEC 61000-4-8 (1993) IEC 61000-4-11 (1995) EN55022: 1995	A	Class B
	EMC Framework AS/NZD 3548	B	Class B

* Conditions

- A: Meets this standard. (Approval pending)
- B: Meets this standard.
- C: Does not meet this standard.
- D: Unknown

D.2 Interface Cables

With the interface cables described in this section, DENSO WAVE has run the quality assurance test conforming to the EMC Directive for the BHT-100Q/100B series and CU-7001.

Any connectors other than those specified here are not acceptable. They may cause the BHT or CU to fail to work according to the specifications.

For BHT

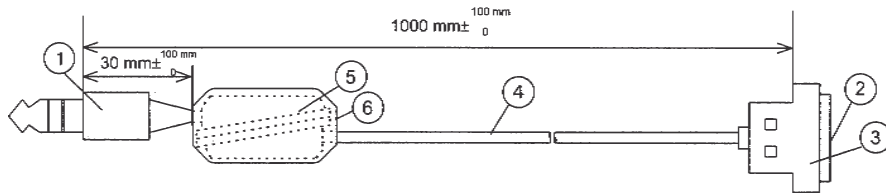

Cable 1

Wind the cable on a ferrite core twice and then secure the core with a heat-shrinkable tube.

① Connector	P161	Teisin Electric Co., Ltd.
② D-sub connector	D□-F-T-N series (EMI-durable)	Japan Aviation Electronics Industry Ltd.
③ Connector cover	17JE series hood/cable clamp (shielded)	DDK Ltd.
④ Cable	Super flex VVC 7/0.18 mm x 3C	Bando Densen Co., Ltd.
⑤ Ferrite core	ZCAT2035-0930A	TDK Corporation
⑥ Heat-shrinkable tube		

Note: A square (□) in the above specifications denotes a numeral that will vary according to the number of connector pins.

For CU

Cable 2

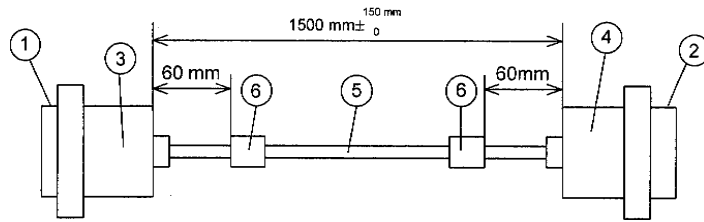

① D-sub connector	D□-F-T-N series (EMI-durable)	Japan Aviation Electronics Industry Ltd.
② D-sub connector (to be connected to CU)	DB-25SF-T-N [-S1]	Japan Aviation Electronics Industry Ltd.
③ Connector cover	17JE series hood/cable clamp (shielded)	DDK Ltd.
④ Connector cover	17JE-25○-1○	DDK Ltd.
⑤ Shielded cable		
⑥ Ferrite core withstanding EMI	RISC 5F	Kitagawa Industries Co., Ltd.

Note: A square (□) in the above specifications denotes a numeral that will vary according to the number of connector pins.

A circle (○) in the above specifications denotes a numeral that will vary according to the hood appearance and the type of connector screws.

Index

Symbols

\$\$BRKLST.SYS 34
2D-code and bar-code reading test 76
3-pole mini stereo plug 13, 47, 81, 111

A

abnormally turned off last 131
AC adapter vi, viii, ix, x, 140, 141, 142, 143, 144
aging test 41, 75, 80
auto power-off 31, 131

B

backlight function on/off key 18, 72
battery level, battery output level,
battery output voltage, battery
voltage level 18, 20, 21, 22, 28,
129, 130
BCC 119, 172
beeper scale test 75, 80
beeper volume 24, 25, 56, 95
BHT turning-off notes 31, 131
BHT-BASIC Compiler 12, 13, 16
BHT-BASIC Extension Library 12
BHT-BASIC Interpreter 15
BHT-Ir protocol 14, 65, 66, 67, 69, 70,
110, 116, 122, 124, 125, 126, 143,
173, 174, 183
BHT-protocol 14, 63, 69, 116, 118, 119,
120, 143, 163, 164, 172
black-and-white inverted label reading
54, 58, 61

C

C-700, C-750 v, 22
calendar clock 16, 20, 23, 29, 30, 33,
38, 40, 47, 51, 54, 57, 130, 133,
150, 157
character length 63, 66, 113, 115
Codabar (NW-7) 54, 58, 60, 61, 62, 77,
78, 152, 154, 158
Code 128 77, 78, 152, 158
Code 39 77, 78, 152, 158, 159
Code 93 78, 158
communications LED 140
communications parameter 40, 50, 53,
54, 63, 64, 65, 66, 95, 98, 100, 102,
105, 107, 115, 136, 138, 143
communications protocol ii, 50, 53,
63, 64, 65, 66, 67, 69, 95, 98, 100,
102, 105, 107, 108, 110, 116, 136,
138, 143, 163
connector cover 17, 47, 186, 187
control character 116, 117, 118, 119,
122, 123, 124, 125
CRC 122, 125, 183
CU-7001 v, x, 22, 140, 144, 145, 161
CU-7002 140, 161

D

Data Matrix 60, 77, 151, 154
DCE 147
decode level 58, 61
deleting files 16, 34, 42, 43, 93
DIP switch 142
direct-connect 13, 14, 17, 47, 63, 64,
66, 68, 81, 83, 111, 112, 113, 115,
122, 155, 160

download 12, 13, 15, 16, 34, 38, 40, 42,
45, 46, 47, 48, 49, 50, 51, 68, 69,
95, 96, 97, 98, 102, 103, 104, 105,
133, 134, 135, 136, 137, 143, 171,
177, 182

driver iv, 15

dry battery cartridge viii, 17, 19, 20,
21, 31, 129, 130, 149, 156

Dsub-25P 142

DTE 147

E

EAN-13 77, 78, 152, 158, 159

EAN-8 77, 78, 152, 154, 158

Error in System Mode settings 132

execution program 33, 40, 54, 55, 132,
133, 134

extension library 12

extension program 15

F

field space, space codes in the tail of a
data file 63, 65, 67

file test 41, 91

flash memory 123, 133, 149, 156, 177

FUNC 18, 40, 71, 73

G

graphics pad box 7, 85, 89

H

hand strap 1, 6, 7, 17

horizontal parity 63, 65, 67, 116, 172

HT<-->HT COPY 47, 49, 51, 52, 53

I

indicator LED 2, 4, 17, 41, 75, 76, 78,
85, 86, 144, 145, 150, 157

infrared communication 10, 109

initializing 16, 35, 56

interface cable 10, 12, 13, 47, 111, 112,
113, 142, 147, 186

interface port 10, 12, 13, 17, 40, 47, 50,
53, 54, 63, 64, 68, 81, 82, 83, 95,
98, 100, 102, 105, 107, 111, 115,
136, 138, 140, 142, 143, 146, 162

Interleaved 2of5 (ITF) 77, 78, 152, 158

IR communication ii, 108, 109, 110

Ir-Transfer Utility C iii, 12, 13, 14, 16,
48, 49, 52, 69, 143

Ir-Transfer Utility E iii, 12, 13, 14, 16,
48, 49, 52, 69, 143

IrDA interface 10, 12, 13

IrDA-compliant 10, 13, 109, 110

ITF 54, 58, 60, 61, 62, 77, 78, 152, 156,
158, 159

J

JIS Level 1, JIS Level 2 15, 16, 92

K

key entry, beeper, and vibrator test 41,
75, 90

keypad shift state 18

L

LCD contrast 24, 25, 38, 56, 95

LCD, indicator LED, and touch screen
tests 75, 85

LED indicators 140

lithium-ion battery 144, 149, 156
low battery indication 21, 129, 130

M

M1 18, 71, 72
M2 18, 71, 72
M3 2, 4, 17, 71, 72
M4 2, 4, 17, 71, 72
magic key v, 40, 54, 71, 72, 149, 156
marker 2, 3, 54, 58, 59, 61, 62, 117
MaxiCode 60, 77, 151, 154
memory size 41, 92
memory test 41, 79
message version 36, 40, 41, 54, 56, 92
multi-line code 152

N

Nonlock 71
NW-7 77, 78, 152, 158

O

Onetime 71
optical communications 12, 162
optical communications unit 10, 12, 140
optical interface 17, 47, 63, 64, 81, 82, 113, 115, 140, 143, 155, 160, 162
option data 54, 58, 59, 60, 77

P

PDF417 60, 77, 151, 154
power LED 140, 144
program execution 40, 45, 129

protection sheet of the DIP switch 142
protocol 63, 64, 65, 66, 67, 69, 70, 118, 124, 143, 164, 165, 172, 174, 175

Q

QR code 58, 59, 77, 149, 151, 153

R

radio communication xi
RAM 75, 79, 149, 156
rechargeable battery cartridge ii, v, vi, vii, viii, 17, 19, 20, 21, 22, 29, 129, 130, 139, 140, 144
release button 17, 19
remote wakeup 42, 101
resume data 132
resume function 33, 40, 54, 74, 132
RS-232C ii, 10, 12, 13, 108, 111, 140, 142, 146, 147, 155, 160, 162

S

Scandisk 32, 33, 34
serial number 63, 65, 67, 119, 125, 163, 172, 173, 183
space codes in the tail of a data field 65, 67
specular effect 2, 4
split QR code 77
Standard 2of5 (STF) 78, 158
status indicator 18, 20, 28
STF 54, 61, 62, 78, 158
stop bit length 66, 115
Structured Append 77
stylus vi, viii, 1, 6, 7, 17, 26, 85, 89

supplemental code 158
 synchronization 113, 155, 160
 system area 15
 system down error 133
 system information 41, 92
 system message file 42, 49, 102, 103,
 104, 105, 106, 107, 135, 137, 138
 System Mode ii, xv, 11, 15, 16, 18, 34,
 39, 40, 42, 43, 45, 47, 51, 59, 68,
 69, 73, 81, 85, 115, 129, 130, 132,
 134, 143, 164, 165, 174, 175, 183
 system parameter file 42, 49, 95, 96,
 97, 98, 99, 100, 135, 136, 137, 138
 System Program malfunction 131
 system program version 41, 92

T

timeout 65, 67, 82, 83, 165, 175, 182
 touch screen 2, 4, 24, 25, 26, 27, 85,
 89, 150
 Transfer Utility iii, 12, 13, 14, 16, 48,
 49, 52, 69, 121, 143
 transmission speed 14, 65, 66, 101,
 109, 113, 115, 142, 155, 160
 transparency 117, 123
 trigger switch 2, 4, 8, 17, 24, 59, 62,
 71, 72, 77, 90, 184

U

UPC-A 77, 78, 152, 158
 UPC-E 77, 78, 152, 158
 upload 16, 34, 40, 42, 47, 51, 52, 53,
 68, 69, 91, 95, 98, 99, 100, 102,
 104, 105, 106, 107, 134, 137, 138,
 143, 171, 182
 user area 15, 16, 35, 36, 37, 45, 47, 95,
 102, 103, 106, 133

V

vertical parity 63, 66, 113, 114, 115,
 172
 view finder 2, 54, 58, 59

W

wireless 109

BHT-100Q/100B

User's Manual

First Edition, February 2001

Second Edition, October 2001

DENSO WAVE INCORPORATED

The purpose of this manual is to provide accurate information in the handling and operating of the BHT-100Q/100B. Please feel free to send your comments regarding any errors or omissions you may have found, or any suggestions you may have for generally improving the manual.

In no event will DENSO WAVE be liable for any direct or indirect damages resulting from the application of the information in this manual.

Free Manuals Download Website

<http://myh66.com>

<http://usermanuals.us>

<http://www.somanuals.com>

<http://www.4manuals.cc>

<http://www.manual-lib.com>

<http://www.404manual.com>

<http://www.luxmanual.com>

<http://aubethermostatmanual.com>

Golf course search by state

<http://golfingnear.com>

Email search by domain

<http://emailbydomain.com>

Auto manuals search

<http://auto.somanuals.com>

TV manuals search

<http://tv.somanuals.com>