

# EUREKA®

## 3040 Series

# OWNER'S GUIDE

## Guía del Dueño

## Le Guide du Propriétaire



*Thank you for purchasing your new Eureka Vacuum!*  
*¡Gracias por la compra de su nueva aspiradora Eureka!*  
*Merci d'avoir acheté votre nouvel aspirateur Eureka!*

**Before Returning, Call  
Eureka Customer Service**

Antes de enviar de regreso, llame al Servicio al Cliente de Eureka

Avant de le retourner, appelez le service à la clientèle Eureka

**HELPLINE LÍNEA DE AYUDA LIGNE D'AIDE**

**1-800-282-2886**

8 a.m. to 7:30 p.m. (CST), Monday - Friday  
10 a.m. to 6:30 p.m. (CST), Saturday - Sunday

8 a.m. a 7:30 p.m. (CST), de Lunes a Viernes  
10 a.m. a 6:30 p.m. (CST), Sábado y Domingo

8 h à 19 h 30 (CST), lundi au vendredi  
10 h à 18 h 30 (CST), samedi et dimanche



Upright Vacuum Cleaner  
Household Type  
Aspiradora Vertical  
Tipo domestico  
Aspirateur vertical  
de type résidentiel

**www.eureka.com**

# Where to Find Important Vacuum Cleaner Information

## Please Retain

Record the model, type and serial number below.

Date of Purchase \_\_\_\_\_ (keep your receipt)

Model & Type \_\_\_\_\_

Serial Number \_\_\_\_\_

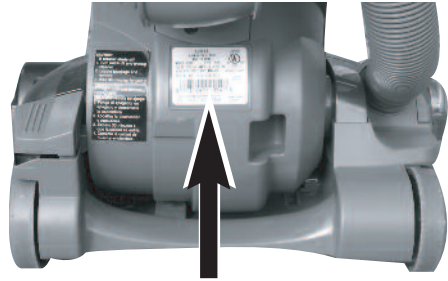

This information is located on the rating plate on the lower back side of the vacuum.  
Refer to these numbers when ordering parts, accessories or when service is needed.

## Before You Start Your Vacuum Cleaner

Refer to **Quick Start Guide** for assembly and use. This **Owner's Guide** provides important instructions to prolong the life of your Eureka vacuum cleaner.

## Inspection

Carefully unpack and inspect your new Eureka vacuum cleaner for shipping damage. Each unit is tested and thoroughly inspected before shipping. For instructions regarding any shipping damage, call Eureka Customer Service **HELPLINE 1-800-282-2886** immediately.

### Table of Contents

<b>Important Safeguards</b> .....	<b>1</b>
<b>How to Identify Parts of Vacuum Cleaner</b> .....	<b>2</b>
<b>Filter Maintenance Schedule</b> .....	<b>2</b>
Filter screen, foam filter, and HEPA filter.	
<b>How to Use Accessories</b> .....	<b>3</b>
Crevice tool, extension wand, dusting brush, Power Paw® and stair hose.	
<b>How to Maintain Your Vacuum Cleaner</b> .....	<b>4</b>
Maintain brush roll and replace EXT-U brush roll belt.	
<b>How to Clear a Blockage</b> .....	<b>5</b>
Hose blockages.	
<b>Eureka Limited Warranty Information</b> .....	<b>5</b>
<b>Thermal Cut-Off and Problem Solving</b> .....	<b>6</b>
<b>Spanish Owner's Guide</b> .....	<b>7-13</b>
<b>French Owner's Guide</b> .....	<b>14-20</b>
<b>Order Forms and Parts List</b> .....	<b>21-22</b>



Follow caution information wherever you see this symbol.

# IMPORTANT SAFEGUARDS

When using an electrical appliance, basic precautions should always be followed, including the following:

## READ ALL INSTRUCTIONS BEFORE USING THIS VACUUM CLEANER WARNING



To reduce the risk of fire, electric shock, or injury:

- Do not use outdoors or on wet surfaces.
- **Do not leave vacuum cleaner when plugged in.** Turn off the switch and unplug the electrical cord when not in use and before servicing.
- Do not allow to be used as a toy. Close attention is necessary when used by or near children.
- Use only as described in this manual. Use only manufacturer's recommended attachments.
- Do not use with damaged cord or plug. If vacuum cleaner is not working as it should, has been dropped, damaged, left outdoors, or dropped into water, return it to a service center before using.
- Do not pull or carry by cord. Do not use cord as a handle. Do not close a door on cord or pull cord around sharp edges or corners. Do not run vacuum cleaner over cord. Keep cord away from heated surfaces.
- Do not use extension cords or outlets with inadequate current carrying capacity.
- Turn off all controls before unplugging.
- Do not unplug by pulling on cord. To unplug, grasp the plug, not the cord.
- Do not handle plug or vacuum cleaner with wet hands.
- Do not put any object into openings. Do not use with any opening blocked; keep free of dust, lint, hair, and anything that may reduce airflow.
- This vacuum cleaner creates suction and contains a revolving brush roll. Keep hair, loose clothing, fingers, and all parts of body away from openings and moving parts.
- Do not place vacuum cleaner on furniture or stairs as the brush roll may cause damage. Place vacuum cleaner on floor with the handle in storage position while using attachments.
- Do not pick up anything that is burning or smoking, such as cigarettes, matches, or hot ashes.
- Do not use without dust cup, filter screen, foam filter and HEPA exhaust filter in place.
- Belt pulleys can become hot during normal use. To prevent burns, avoid touching the belt pulley when servicing the drive belt.
- Use extra care when cleaning on stairs.
- Do not use to pick up flammable or combustible liquids such as gasoline, or use in areas where they may be present.
- Store your vacuum cleaner indoors in a cool, dry area.
- Keep your work area well lighted.
- Unplug electrical appliances before vacuuming them.
- Unplug before connecting Power Paw®. Not for use on animals.

The Power Paw name is a registered trademark of Electrolux Home Care Products, Inc.

## SAVE THESE INSTRUCTIONS

To reduce the risk of electric shock, this appliance has a polarized plug (one blade is wider than the other). This plug will fit in a polarized outlet only one way. If the plug does not fit fully into the outlet, reverse the plug. If it still does not fit, contact a qualified electrician to install the proper outlet. Do not change the plug in any way.



### Motor

**Do Not Oil** the motor or the brush roll at any time. The bearings are permanently lubricated and sealed.

# How to Identify Parts of Vacuum Cleaner

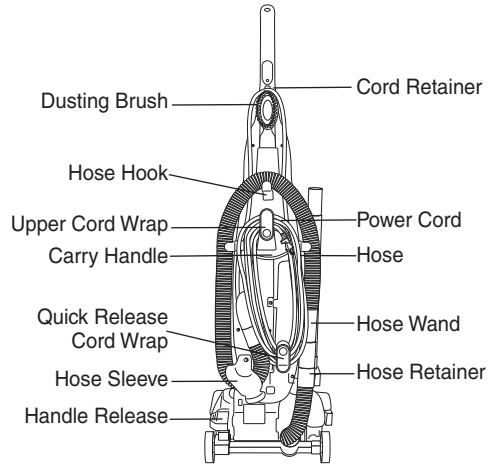
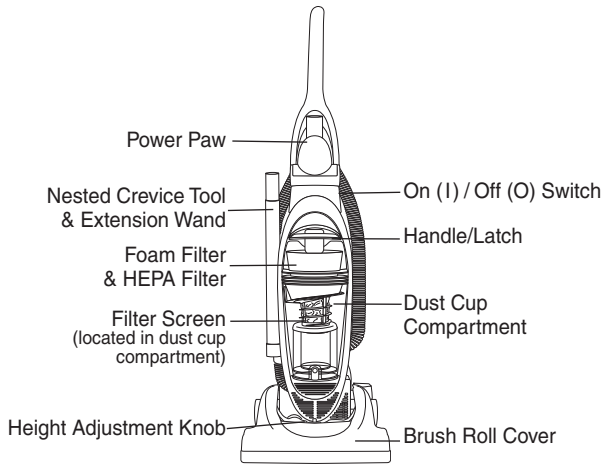

## Filter Maintenance Schedule

Maintenance Schedule is also located on back side of dust cup.

Assemble the vacuum cleaner before using. Moving parts. Make sure ON/OFF switch is in OFF (O) position before plugging in power cord.

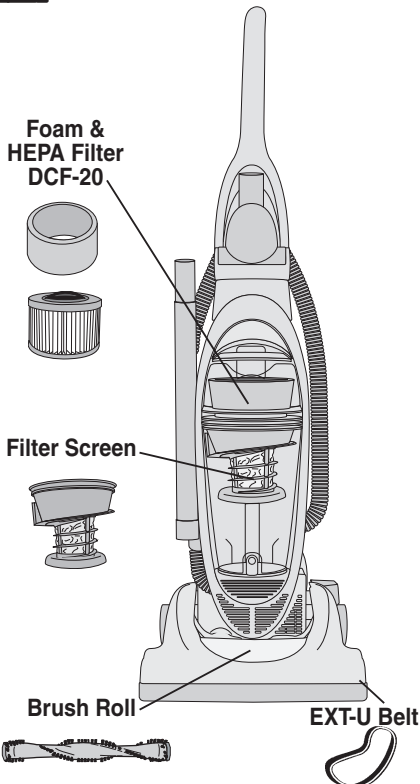

### EACH USE

### DUST CUP – Empty

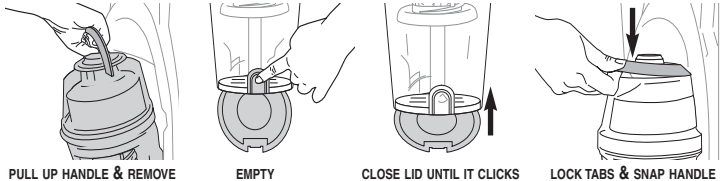

### WEEKLY

### FOAM FILTER & FILTER SCREEN – Wash & Clean

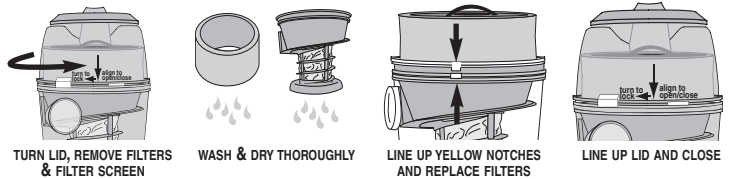

### 6 MONTHS

### HEPA FILTER – Replace

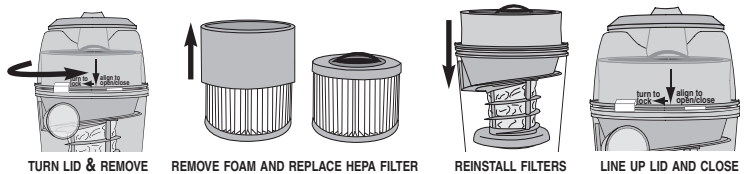

### MONTHLY

### BRUSH ROLL – Clean

BELT – Replace a worn, cut or out-of-shape belt

# How to Use Accessories



**Vacuum Cleaner handle must be in upright position.  
Be sure to raise height adjustment setting before using attachments.**

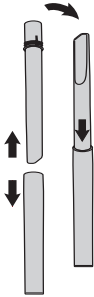

## Combination Crevice Tool and Extension Wand

Baseboards, corners & between cushions

- 1) Grasp crevice tool near ridges and pull apart.
- 2) Turn ridge end to center.
- 3) Push crevice tool into wand and place on end of hose.

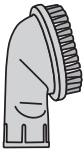
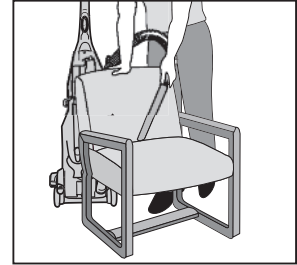
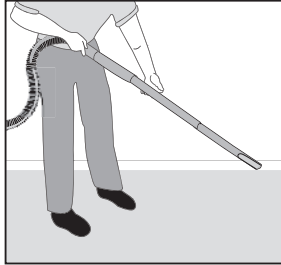

## Dusting Brush

Furniture, drapes, blinds, bookshelves, lampshades and vents.

- 1) Remove hose from hose retainer on back of vacuum.
- 2) Place dusting brush on end of hose, wand or crevice tool.

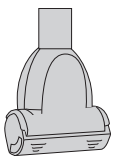
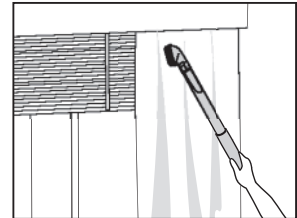
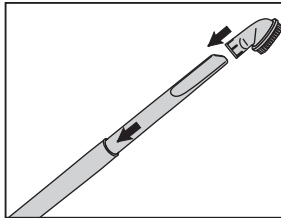

## Power Paw® for Furniture and Stairs

**Stair Hose** (Some vacuum models have an additional stair hose – Part number 70947-5)

**Make sure vacuum is below you, pushed against the bottom step.**

- 1) If model has additional stair hose, attach to end of hose.
- 2) Attach Power Paw to the end of wand or hose.

**Vacuum must be turned off before removing debris from Power Paw.**

For additional assistance, call Eureka Customer Service HELPLINE.

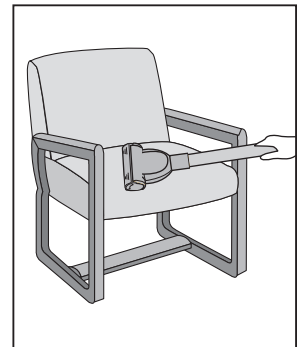
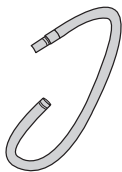



# How to Maintain Your Vacuum Cleaner

Make sure vacuum cleaner is turned off and power cord is unplugged.

## Maintain Brush Roll – Part number 77315

Do not remove end caps. Remove hair and threads from brush roll periodically.



## Replace EXT-U Belt if Worn, cut or Out of Shape – Part number 61120C

Motor can become hot with normal use.

Avoid touching the motor shaft when checking brush roll belt.

- 1) Use handle release to lower handle flat onto floor (Fig. 1).

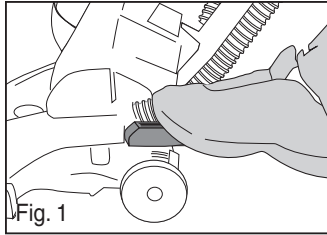

Fig. 1

### Remove Brush Roll Cover

- 1) Remove 2 screws from the front side of brush roll cover (Fig. 2).
- 2) Lift and remove brush roll cover (Fig. 3).

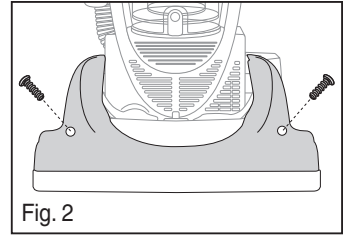

Fig. 2

### Replace EXT-U Belt

- 1) Remove brush roll and belt.
- 2) Thread new belt around motor shaft and brush roll (Fig. 4).

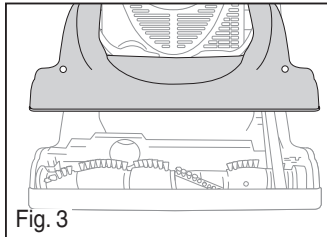

Fig. 3

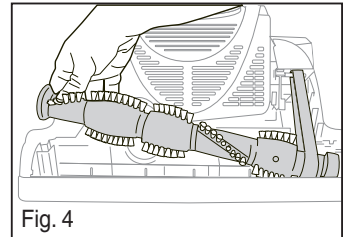

Fig. 4

### Replace Brush Roll

- 1) Insert left end of brush roll first. Make sure square on brush roll cap is in place.
- 2) Pull right side of brush roll to stretch belt.
- 3) Secure right end cap into base (Fig. 5).
- 4) Rotate brush roll 2 turns to center belt.
- 5) Replace brush roll cover and two screws (Fig. 6).

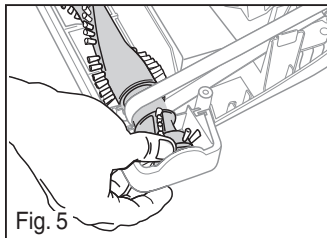

Fig. 5

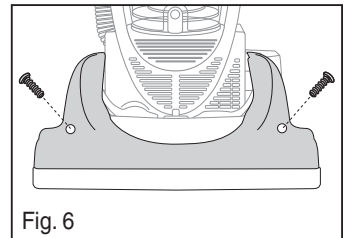

Fig. 6



## Change Light Bulb – Available on some models – Part number 57940-3

Make sure vacuum is turned off and power cord is unplugged.

- 1) Pull up release handle latch and remove dust cup compartment.
- 2) Unscrew the lens cover and remove old bulb (Fig. 7).
- 3) Push in new bulb, replace lens cover and screw. (Fig. 8).
- 4) Replace dust cup compartment, snap release handle down to secure.

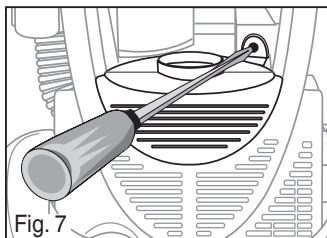

Fig. 7

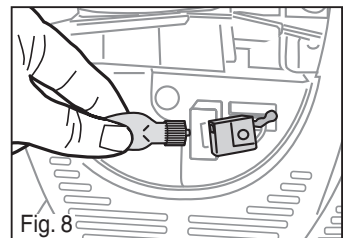

Fig. 8



## How to Clear a Blockage

**Make sure vacuum is turned off and power cord is unplugged.**

### Hose Blockage

- 1) Remove hose from hose retainer. Flexing the hose will help loosen any blockage (Fig. 1).
- 2) Remove dust cup and remove debris from hose connector opening (Fig. 2A). If still blocked, remove screw from hose connector and remove blockage (Fig. 2B).
- 3) Hose inlet – remove two screws and brush roll cover. Clear blockage from hose inlet (Fig. 3).

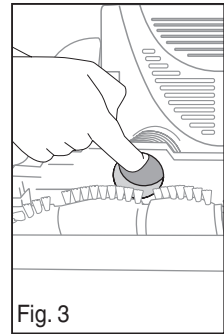
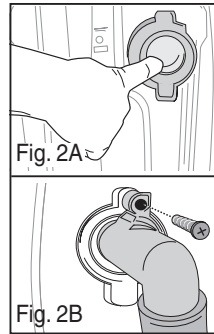
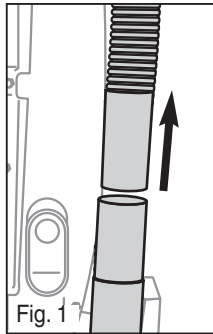

## The Eureka Limited Warranty

Eureka warrants this vacuum cleaner to be free from defects in material and workmanship for a term of one year for normal household use. Warranty is granted only to the original purchaser and members of immediate household.

This warranty is good for one year from the date of purchase only when the vacuum cleaner is used in the accordance with Eureka operating instructions.

### This Warranty Does Not Cover

- Parts of the vacuum that require replacement under normal use such as disposable dust bags, filters, drive belts, light bulbs, brush roll, bristles, impellers and cleaning.
- Damages or malfunctions caused by negligence, abuse, and use not in accordance with the Owner's Guide.
- Defects or damages caused by unauthorized service or the use of other than Genuine Eureka, ARM & HAMMER™ and Filtrete™ by 3M parts.

### What Eureka Will Do

Eureka will, at its option, repair or replace a defective vacuum or vacuum part that is covered by this warranty. As a matter of warranty policy, **Eureka will not refund the consumer's purchase price.**

### Warranty Registration

Please fill out and return the warranty registration card accompanying your vacuum.

### Obtaining Warranty Service

To obtain warranty service you must return the vacuum or vacuum part along with "proof of purchase" to any Eureka Authorized Warranty Station. For Eureka

Authorized Warranty Station or Service Information, visit **www.eureka.com**, write or telephone toll free:

<b>USA: 1-800-282-2886</b>	<b>Mexico: (55) 5343-384</b>	<b>Canada: 1-800-282-2886</b>
Electrolux Home Care North America Service Division P.O. Box 3900 Peoria, IL 61612	Electrolux Home Care North America Service Division 5855 Terry Fox Way Mississauga, Ontario L5V 3E4	Electrolux Home Care North America Service Division 5855 Terry Fox Way Mississauga, Ontario L5V 3E4

### Obtaining Warranty Service Outside Your Community

You must pay the shipping charges to the Eureka Authorized Warranty Station.

**Return Shipping Charges** will be paid by the Warranty Station. When returning parts for repair, please include the model, type and serial number located on the rating plate on the lower backside of the vacuum.

### Further Limitations and Exclusions

Any warranty that may be implied in connection with your purchase or use of the vacuum, including any warranty of Merchantability or any warranty for Fitness For A Particular Purpose is limited to the duration of this warranty. Some states do not allow limitations on how long an implied warranty lasts, so the above limitations may not apply to you.

Your relief for the breach of this warranty is limited to the relief expressly provided above. In no event shall the manufacturer be liable for any consequential or incidental damages you may incur in connection with your purchase or use of the vacuum.

Some states do not allow the exclusion or limitation of incidental or consequential damages, so the above limitation or exclusion may not apply to you.

This warranty gives you specific legal rights. You may also have other rights, which may vary by state.

The ARM & HAMMER name is a trademark of Church and Dwight Co., Inc. 3M and Filtrete are trademarks of 3M Company, used by Electrolux Home Care Products, Inc. under license.

## Thermal Cut-Off

This vacuum cleaner has a special thermostat that protects the vacuum in case of motor overheating. If the vacuum suddenly shuts off, push the on/off switch to off (O) and unplug the vacuum. Check the vacuum for a possible source of overheating such as a blocked hose or clogged filter. If these conditions are found, fix them and wait at least 30 minutes before attempting to use the vacuum. After the 30 minute period, plug the vacuum back in and turn on the switch. If the vacuum still does not work, take it to a Eureka Authorized Service Center for repair.

## Problem Solving

 **Make sure vacuum is turned off and power cord is unplugged.**

Problem	Cause	Solution
<b>Motor will not start.</b>	Power plug	<ul style="list-style-type: none"> <li>• Push plug securely into outlet.</li> <li>• Try another outlet.</li> <li>• Check circuit breaker.</li> </ul>
	On / Off switch	<ul style="list-style-type: none"> <li>• Turn On / Off switch on ( I ).</li> </ul>
	Thermal cut-off	<ul style="list-style-type: none"> <li>• See above.</li> </ul>
<b>Vacuum does not clean carpet or bare floor.</b>	Dust cup and filters	<ul style="list-style-type: none"> <li>• Empty the dust cup and/or change the filters.</li> <li>• If picking up fine dust, the dust cup may not look full, but a fine substance tends to reduce suction when it blocks air flow through the foam filter and filter screen. Refer to page 2 for filter maintenance. Make sure the foam filter and filter screen are installed properly.</li> </ul>
	Belt	<ul style="list-style-type: none"> <li>• Replace a worn, cut or out-of-shape belt. Page 4</li> </ul>
	Hose	<ul style="list-style-type: none"> <li>• Remove any clogs from the hose that restrict the airflow. Page 5</li> </ul>
	Bare floor setting	<ul style="list-style-type: none"> <li>• For bare floor cleaning, turn height adjustment knob to bare floor position. Refer to Quick Start Guide.</li> </ul>
	Carpet height setting	<ul style="list-style-type: none"> <li>• For carpet cleaning, turn height adjustment knob to another position. Refer to Quick Start Guide.</li> </ul>
<b>No suction at the end of hose.</b>	Dust cup and filters	<ul style="list-style-type: none"> <li>• Empty the dust cup and/or change the filters.</li> <li>• If picking up fine dust, the dust cup may not look full, but a fine substance tends to reduce suction when it blocks air flow through the foam filter and filter screen. Refer to page 2 for filter maintenance. Make sure the foam filter and filter screen are installed properly.</li> </ul>
	Filter screen	<ul style="list-style-type: none"> <li>• (Located inside the dust cup). Check and clean debris to maintain full air flow. Page 2</li> </ul>
	Hose	<ul style="list-style-type: none"> <li>• Remove any clogs from the hose that restrict the air flow. Page 5</li> </ul>
<b>Vacuum is hard to push.</b>	Vacuum height setting	<ul style="list-style-type: none"> <li>• Adjust knob to a higher position. Refer to Quick Start Guide.</li> </ul>
	Belt	<ul style="list-style-type: none"> <li>• Replace a worn, cut or out-of-shape belt. Page 4</li> </ul>
<b>Brush roll will not turn.</b>	Belt	<ul style="list-style-type: none"> <li>• Check brush roll for debris. Page 4</li> <li>• Replace broken or out-of-shape belt. Page 4</li> </ul>
<b>Vacuum motor sounds louder than normal.</b>	Dust cup and filters	<ul style="list-style-type: none"> <li>• Empty the dust cup and/or change the filters.</li> <li>• Refer to page 2 for filter maintenance.</li> </ul>
	Belt	<ul style="list-style-type: none"> <li>• Replace a worn, cut or out-of-shape belt. Page 4</li> </ul>
	Hose	<ul style="list-style-type: none"> <li>• Remove any clogs from the hose that restrict the airflow. Page 5</li> </ul>



## Free Manuals Download Website

<http://myh66.com>

<http://usermanuals.us>

<http://www.somanuals.com>

<http://www.4manuals.cc>

<http://www.manual-lib.com>

<http://www.404manual.com>

<http://www.luxmanual.com>

<http://aubethermostatmanual.com>

Golf course search by state

<http://golfingnear.com>

Email search by domain

<http://emailbydomain.com>

Auto manuals search

<http://auto.somanuals.com>

TV manuals search

<http://tv.somanuals.com>