

ErgoCut 48-Li Art. 8878

D Betriebsanleitung
Accu-Heckenschere

GB Operating Instructions
Cordless Hedge Trimmer

F Mode d'emploi
Taille-haies sur Accu

NL Instructies voor gebruik
Accu-heggenschaar

S Bruksanvisning
Accu Häcksax

DK Brugsanvisning
Accu hækkeklipper

FIN Käyttöohje
Akkukäyttöinen aitalleikkuri

N Bruksanvisning
Accu Hekksaks

I Istruzioni per l'uso
Tagliasiepi a batteria

E Manual de instrucciones
Recortasetos con Accu

P Instruções de utilização
Corta sebes com acumulador

PL Instrukcja obsługi
Akumulatorowe nożyce do żywopłotów

H Használati utasítás
Akkumulátoros sövénynyíró

CZ Návod k použití
Akumulátorové nůžky na živý plot

SK Návod na použitie
Akumulátorové nožnice na živý plot

GR Οδηγίες χρήσεως
Θαμνοκοπτικό μπαταρίας

RUS Инструкция по эксплуатации
Электрические кусторезы

SLO Navodilo za uporabo
Akumulatorske škarje za živo mejo

HR Upute za uporabu
Škare za živicu s akumulatorom

SRB Uputstvo za rad
Baterijske makaze za živicu

UA Інструкція з експлуатації
Акумуляторний садовий секатор

RO Instrucțiuni de utilizare
Trimmer de gard viu cu acumulator

TR Kullanım Klavuzu
Akülü Çit Budayıcısı

BG Инструкция за експлоатация
Accu Ножица за жив плет

AL Manual përdorimi
Gërshërë gardhishtesh me akumulator

EST Kasutusjuhend
Akuga hekilõikur

LT Eksploatavimo instrukcija
Akumuliatorinės gyvatvorių žirklys

LV Lietošanas instrukcija
Accu dzīvžoga šķēres



Translation of the original instructions from German. Please read these operating instructions carefully and observe the notes given. Use these operating instructions to familiarise yourself with the hedge trimmer, its proper use and the notes on safety.



For safety reasons, children under the age of 16 and people not familiar with these operating instructions must not use this hedge trimmer. Persons with reduced physical or mental abilities may use the hedge trimmer only if they are supervised or instructed by a responsible person.

→ Please keep these operating instructions in a safe place.

Contents

1. Where to Use Your GARDENA Cordless Hedge Trimmer	11
2. Safety Instructions	11
3. Initial Operation	14
4. Operation	15
5. Storage	16
6. Maintenance	16
7. Troubleshooting	17
8. Accessories	17
9. Technical Data	18
10. Service/Warranty	18

1. Where to Use Your GARDENA Cordless Hedge Trimmer

Correct Use:

This GARDENA Cordless Hedge Trimmer is intended for the cutting of hedges, shrubs and grass coverings in private domestic gardens and allotments.

Adherence to these operating instructions is a precondition for the correct use of the hedge trimmer.

Please note



WARNING! Risk of injury!

The hedge trimmer must not be used for cutting lawns / lawn edges or for chopping up material for composting purposes.

2. Safety Instructions



If not used properly this product can be dangerous. The warnings and safety instructions must be followed to ensure reasonable safety and efficiency in using this product. The operator is responsible for following the warnings and instructions in this manual and on the product. Never use the product unless the guards provided by the manufacturer are in the correct position.

Explanation of Symbols on your product.



WARNING !



Read the user instructions carefully to make sure you understand all the controls and what they do.



Remove Battery before cleaning or maintenance.



Do not expose to rain. Do not leave the product outdoors while it is raining.



The use of eye and hearing protection is recommended.

General Power Tool Safety Warnings



WARNING ! Read all safety warnings and all instructions. Failure to follow the warnings and instructions may result in electric shock, fire and/or serious injury.

Save all warnings and instructions for future reference.

The term "power tool" in the warnings refers to your mains operated (corded) power tool or battery-operated (cordless) power tool.

1) Work area safety

a) **Keep work area clean and well lit.**

Cluttered or dark areas invite accidents.

b) **Do not operate power tools in explosive atmospheres, such as in the presence of flammable liquids, gases or dust.** Power tools create sparks which may ignite the dust or fumes.

c) **Keep children and bystanders away while operating a power tool.** Distractions can cause you to lose control.

2) Electrical safety

a) **Power tool plugs must match the outlet. Never modify the plug in any way. Do not use any adaptor plugs with earthed (grounded) power tools.**

Unmodified plugs and matching outlets will reduce risk of electric shock.

b) **Avoid body contact with earthed or grounded surfaces, such as pipes, radiators, ranges and refrigerators.** There is an increased risk of electric shock if your body is earthed or grounded.

c) **Do not expose power tools to rain or wet conditions.** Water entering a power tool will increase the risk electric shock.

d) **Do not abuse the cord. Never use the cord for carrying, pulling or unplugging the power tool. Keep cord away from heat, oil, sharp edges or moving parts.** Damaged or entangled cords increase the risk of electric shock.

e) **When operating a power tool outdoors, use an extension cord suitable for outdoor use.** Use of a cord suitable for outdoor use reduces the risk of electric shock.

f) **If operating a power tool in a damp location is unavoidable, use a residual current device (RCD) protected supply.** Use of an RCD reduces the risk of electric shock.

3) Personal safety

a) **Stay alert, watch what you are doing and use common sense when operating a power tool.**

Do not use a power tool while you are tired or under the influence of drugs, alcohol or medication. A moment of inattention while operating power tools may result in serious personal injury.

b) **Use personal protective equipment. Always wear eye protection.** Protective equipment such as dust mask, non-skid safety shoes, hard hat, or hearing protection used for appropriate conditions will reduce personal injuries.

c) **Prevent unintentional starting. Ensure the switch is in the off-position before connecting to power source and/or battery pack, picking up or carrying the tool.** Carrying power tools with your finger on the switch or energising power tools that have the switch on invites accidents.

d) **Remove any adjusting key or wrench before turning the power tool on.** A wrench or a key left attached to a rotating part of the power tools may result in personal injury.

e) **Do not overreach. Keep proper footing and balance at all times.** This enables better control of the power tool in unexpected situations.

f) **Dress properly. Do not wear loose clothing or jewellery. Keep your hair, clothing and gloves away from moving parts.** Loose clothes, jewellery or long hair can be caught in moving parts.

g) **If devices are provided for the connection of dust extraction and collection facilities, ensure these are connected and properly used.** Use of dust collection can reduce dust-related hazards.

4) Power tool use and care

a) **Do not force the power tool. Use the correct power tool for your application.** The correct power tool will do the job better and safer at the rate for which it was designed.

b) **Do not use the power tool if the switch does not turn it on and off.** Any power tool that cannot be controlled with the switch is dangerous and must be repaired.

c) **Disconnect the plug from the power source and/or the battery pack from the power tool before making any adjustments, changing accessories, or storing power tools.** Such preventive safety measures reduce the risk of starting the power tool accidentally.

d) **Store idle power tools out of the reach of children and do not allow persons unfamiliar with the power tool or these instructions to operate the power tool.** Power tools are dangerous in the hands of untrained users.

e) **Maintain power tools.**

Check for misalignment or binding of moving parts, breakage of parts and any other condition that may affect the power tool's operation. If damaged, have the power tool repaired before use. Many accidents are caused by poorly maintained power tools.

f) **Keep cutting tools sharp and clean.** Properly maintained cutting tools with sharp cutting edges are less likely to bind and are easier to control.

g) **Use the power tool, accessories and tool bits etc. in accordance with these instructions, taking into account the working conditions and the work to be performed.** Use of the power tool for operations different from those intended could result in a hazardous situation.

5. Battery tool use and care

a) **Recharge only with the charger specified by the manufacturer.** *A charger that is suitable for one type of battery pack may create a risk of fire when used with another battery pack.*

b) **Use power tools only with specifically designated battery packs.** *Use of any other battery packs may create a risk of injury and fire.*

c) **When battery pack is not in use, keep it away from other metal objects, like paper clips, coins, keys, nails, screws or other small metal objects, that can make a connection from one terminal to another.** *Shorting the battery terminals together may cause burns or a fire.*

d) **Under abusive conditions, liquid may be ejected from the battery; avoid contact. If contact accidentally occurs, flush with water. If liquid contacts eyes, additionally seek medical help.** *Liquid ejected from the battery may cause irritation or burns.*

6. Service

Have your power tool serviced by a qualified repair person using only identical replacement parts. *This will ensure that the safety of the power tool is maintained.*

Hedge trimmer safety warnings:

- **Keep all parts of the body away from the cutter blade. Do not remove cut material or hold material to be cut when blades are moving. Make sure the switch is off when clearing jammed material. A moment of inattention while operating the hedge trimmer may result in serious personal injury.**
- **Carry the hedge trimmer by the handle with the cutter blade stopped. When transporting or storing the hedge trimmer always fit the cutting device cover. Proper handling of the hedge trimmer will reduce possible personal injury from the cutter blades.**
- **Hold the power tool by insulated gripping surfaces only, because the cutter blade may contact hidden wiring. Cutter blades contacting a "live" wire may make exposed metal parts of the power tool "live" and could give the operator an electric shock.**

Additional Safety Recommendations

Work area safety

Only use the product in the manner and for the functions described in these instructions.

The operator or user is responsible for accidents or hazards occurring to other people or their property.

Electrical safety

Use only on AC mains supply voltage shown on the product rating label.

Under no circumstances should an earth be connected to any part of the product.

Personal safety

Always wear suitable clothing, gloves, and stout shoes.

Thoroughly inspect the area where the product is to be used and remove all wires and other foreign objects.

Before using the machine and after any impact, check for signs of wear or damage and repair as necessary.

Never attempt to use an incomplete product or one with an unauthorised modification.

Power tool use and care

Know how to stop the product quickly in an emergency.

Never hold the product by the guard.

Do not use the Hedge Trimmer if the protection equipment (hand protection, 2-hand safety switch, protection cover, quick blade-stop) are damaged.

Do not use ladders whilst operating the product.

Remove the battery:

- before leaving the product unattended for any period;
- before clearing a blockage;
- before checking, cleaning or working on the appliance;
- if you hit an object. Do not use your product until you are sure that the entire product is in a safe operating condition;
- if the product starts to vibrate abnormally. Check immediately. Excessive vibration can cause injury.
- before passing to another person.

Maintenance and storage



RISK OF INJURY !

Do not touch blades.

→ **When work is finished or interrupted, refit the protective blade cover.**

Keep all nuts, bolts and screws secure to be sure the hedge trimmer is in safe working condition.

Battery safety



FIRE RISK !

→ **Never charge the batteries near acids or easily inflammable materials.**



RISK OF EXPLOSION !

→ **Protect Cordless Hedge Trimmer from heat and fire. Do not leave on radiators or expose to strong sunshine for long periods.**

Only use your Hedge Trimmer in an ambient temperature between -10°C and $+45^{\circ}\text{C}$.

The charging cable should be checked regularly for signs of damage or ageing (brittleness) and may only be used if it is in perfect condition.

The charger unit provided may only be used to charge the rechargeable batteries supplied with the Hedge Trimmer.

Non-rechargeable batteries must not be charged with this battery charger (danger of fire).

The Hedge Trimmer must not be operated during charging.

Only charge battery between $10 - 45^{\circ}\text{C}$. After heavy duty service allow battery to cool down first.

Storage:

The trimmer must not be stored over 35°C or under direct exposure to sunlight.

Do not store the Hedge Trimmer in places with static electricity.

3. Initial Operation

Charging the battery:



WARNING !
Overvoltage damages batteries and the battery charger.

→ Ensure the correct mains voltage.

Before using for the first time, the battery must be fully charged. Charging time (for uncharged battery) see 9. Technical Data.

The lithium-ion battery can be charged in any state of charge, and the charging process can be interrupted at any time without harming the battery (no memory effect).

So that the fully charged battery is not discharged, the battery should be disconnected from the battery charger.

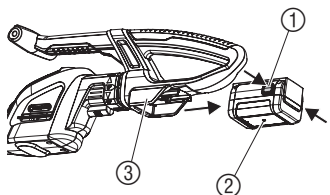

1. Press the locking buttons in ① and remove the battery ② from the handle ③.

2. Plug the plug of the charger cable ④ into the battery ②.

3. Plug battery charger ⑤ into a mains socket.

Charging indicator lamp ⑥ lights up red:

The battery is being charged.

Charging indicator lamp ⑥ lights up green:

The battery is fully charged.

(For charging time, see 9. Technical Data.)

4. First remove the charging cable ④ from the charging socket and then unplug the battery charger ⑤ from the mains socket.

5. Push the battery ② from bottom onto the handle ③.

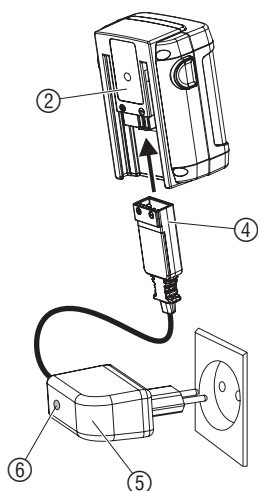

Avoid exhaustive discharge:

Do not wait until the blade comes to an absolute stop (battery totally discharged) as this shortens the battery life.

→ If the output of the hedge trimmer decreases noticeably, charge the battery.

If the battery has been totally discharged, the LED will flash at the start of charging. If the LED is still flashing after an hour, a fault has occurred (see 7. Troubleshooting).

4. Operation

Working positions:

The hedge trimmer can be operated in 3 working positions.

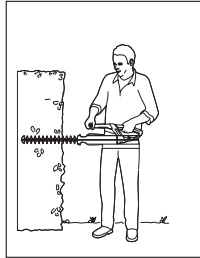

Side trimming:
Cutting unit in
90° position

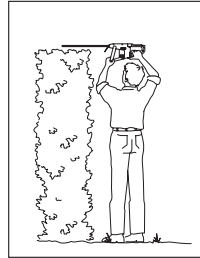

High trimming:
0° position

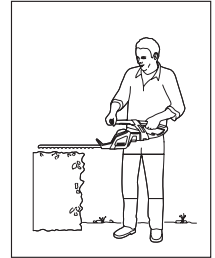

Low trimming:
0° position

Rotate cutting unit through 90°:

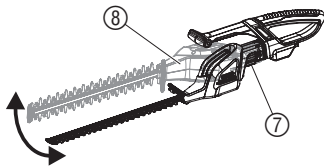

For sideways cutting, the cutting unit can be rotated through 90°. The cutting unit can be turned to the right or left for right-handed or left-handed users respectively.

1. Remove the battery from the handle (see 3. Initial Operation).
2. Keep button ⑦ pressed.
3. Turn cutting unit ⑧ in the required direction 90° until the button ⑦ locks into place.
4. Push the battery onto the handle (see 3. Initial Operation).

A safety device prevents the Hedge Trimmer from starting up when the button ⑦ is pressed or not locked in 0° or 90° position.

Starting the Hedge Trimmer:



DANGER ! Risk of physical injury!

If the Hedge Trimmer does not switch off automatically, there is a risk of lacerations.

→ Never override the safety devices (e.g. by strapping down one of the start buttons).

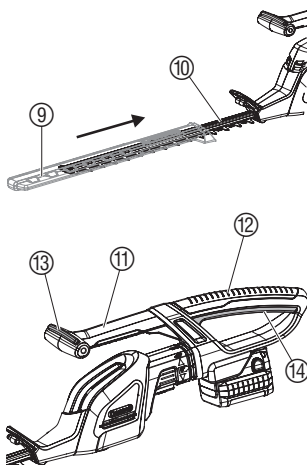

Switching the Hedge Trimmer on:

The hedge trimmer is fitted with a two-handed safety device (2 start buttons) to prevent the unit from being turned on by accident.

1. Push the battery onto the handle (see 3. Initial Operation).
2. Remove the protective cover ⑨ from the cutter blade ⑩
3. Hold the guide handle ⑪ with one hand and press the start button ⑬.
4. Hold the main handle ⑫ with the other hand and press the start button ⑭. *The hedge trimmer will start.*

Switching the Hedge Trimmer off:

1. Release the two start buttons ⑬ / ⑭.
2. Slide the protective cover ⑨ over the cutter blade ⑩.
3. Remove the battery from the handle (see 3. Initial Operation).

5. Storage

Storage:

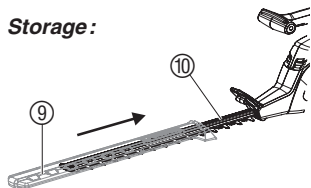

The hedge trimmer must be stored out of the reach of children.

1. Remove battery (see 3. Initial Operation).
2. Clean the hedge trimmer (see 6. Maintenance) and slide the protective cover ⑨ over the cutter blade ⑩.
3. Store the hedge trimmer in a dry, frost free place.

Disposal:

(in accordance with
RL2002/96/EC)



The product must not be added to normal household waste. It must be disposed of in line with local environmental regulations.

→ Important: Make sure that the unit is disposed of via your municipal recycling collection centre.

Disposal of batteries:



The GARDENA Cordless Hedge Trimmer contains lithium-ion batteries that should not be discarded with normal household waste at the end of their life.

Important:

Please return the lithium-ion batteries to your GARDENA dealer or dispose of them properly at a public recycling centre.

1. Discharge lithium-ion batteries completely.
2. Dispose of lithium-ion batteries properly.

6. Maintenance

Cleaning the Hedge Trimmer:



DANGER! Risk of physical injury!
Cutting injuries can be caused if the hedge trimmer does switch on unintentionally.

→ Remove the battery before maintenance (see 3. Initial Operation).



ATTENTION! Damage to the hedge trimmer!
→ Never clean the hedge trimmer under running water or with a water jet (in particular a high pressure water jet).

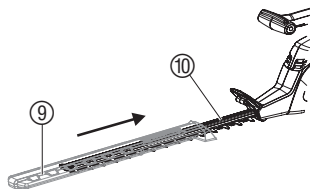

1. Clean the hedge trimmer with a damp cloth.
2. Lubricate the cutter blade ⑩ with a low viscosity oil (e.g. GARDENA spray-oil **Art. 2366**). Avoid contact with the plastic parts.

7. Troubleshooting



DANGER ! Risk of physical injury!
Cutting injuries can be caused if the hedge trimmer does switch on unintentionally.
 → Remove the battery before maintenance (see 3. Operation) and slide the protective cover ¹⁰ over the cutter blade.

Fault	Possible cause	Remedy
Hedge trimmer does not start	Battery is flat.	→ Charge battery (see 3. Initial Operation).
	Battery not pushed onto the handle properly.	→ Push battery onto the handle and make sure that the locking buttons snaps in correctly.
Hedge Trimmer does not start / starts only briefly.	Hedge Trimmer overheats.	→ Let Hedge Trimmer cool for 30 seconds.
Hedge is not cleanly cut	Blade blunt or damaged.	→ Have blade replaced by GARDENA-Service.
Charging indicator lamp does not light up	Battery not plugged in properly.	→ Plug in battery charger and charging cable properly.
Charging indicator lamp flashes for more than 1 hour	A fault has occurred.	→ Unplug and reinsert charging cable. <i>The fault will be reset.</i>
The battery can no longer be charged	Battery is defective.	→ Replace the battery (Art. 8835 / 8839).
	Only the original GARDENA Replacement Battery 18 V (Art. 8835 / 8839) may be used. This can be obtained from your GARDENA dealer or directly from GARDENA Service.	



In the event of other faults please contact GARDENA Service.
 Repairs should only be carried out by GARDENA service centres or dealers authorised by GARDENA.

8. Accessories

GARDENA Replacement Battery Li-Ion 18 V	Battery for additional duration or for replacement 1.6 Ah (approx. 60 Min.) / 2.6 Ah (approx. 100 Min.)	Art. 8835 / 8839
GARDENA Quick Battery Charger	Charging the batteries up to three times faster.	Art. 8831
GARDENA Maintenance Oil	Extends the life of the blade.	Art. 2366

9. Technical Data

ErgoCut 48-Li (Art. 8878)	
Strokes	2,300/min.
Length of cutter blade	48 cm
Tooth gap of cutter blade	16 mm
Weight including battery	3,2 kg
Workplace related sound pressure level L_{pA} 1)	76 dB (A)
Noise emission value L_{WA} 2)	measured 88 dB (A) / guaranteed 90 dB (A)
Hand/arm vibration a_{vhw} 1)	< 2.5 m/s ²
Battery	lithium ion (18 V)
Battery capacity	1.6 Ah
Battery charging time	approx. 3 hrs
Idling time	approx. 60 mins (with full battery)
Battery charger	
Mains voltage	230 V / 50 Hz
Rated output current	600 mA
Max. output voltage	21 V (DC)

Measuring method according to 1) EN 774 2) directive 2000/14/EC

10. Service / Warranty

GARDENA guarantees this product for 2 years (from date of purchase). This guarantee covers all serious defects of the unit that can be proved to be material or manufacturing faults. Under warranty we will either replace the unit or repair it free of charge if the following conditions apply:

- The unit must have been handled properly and in keeping with the requirements of the operating instructions.
- Neither the purchaser nor a non-authorized third party have attempted to repair the unit.

The blade and eccentric drive are wearing parts and are not covered by the guarantee.

This manufacturer's guarantee does not affect the user's existing warranty claims against the dealer / seller.

If a fault occurs with your hedge trimmer, please return the faulty unit together with the receipt and a description of the fault, with postage paid to the address of the Service Centre at the back of these operating instructions.

D Produkthaftung

Wir weisen ausdrücklich darauf hin, dass wir nach dem Produkthaftungsgesetz nicht für durch unsere Geräte hervorgerufene Schäden einzustehen haben, sofern diese durch unsachgemäße Reparatur verursacht oder bei einem Teileaustausch nicht unsere Original GARDENA Teile oder von uns freigegebene Teile verwendet werden und die Reparatur nicht vom GARDENA Service oder dem autorisierten Fachmann durchgeführt wird. Entsprechendes gilt für Ergänzungsstücke und Zubehör.

GB Product Liability

We expressly point out that, in accordance with the product liability law, we are not liable for any damage caused by our units if it is due to improper repair or if parts exchanged are not original GARDENA parts or parts approved by us, and, if the repairs were not carried out by a GARDENA Service Centre or an authorised specialist. The same applies to spare parts and accessories.

F Responsabilité

Nous vous signalons expressément que GARDENA n'est pas responsable des dommages causés par ses appareils, dans la mesure où ces dommages seraient causés suite à une réparation non conforme, dans la mesure où, lors d'un échange de pièces, les pièces d'origine GARDENA n'auraient pas été utilisées, ou si la réparation n'a pas été effectuée par le Service Après-Vente GARDENA ou l'un des Centres SAV agréés GARDENA. Ceci est également valable pour tout ajout de pièces et d'accessoires autres que ceux préconisés par GARDENA.

NL Productaansprakelijkheid

Wij wijzen er nadrukkelijk op, dat wij op grond van de wet aansprakelijkheid voor producten niet aansprakelijk zijn voor schade ontstaan door onze apparaten, indien deze door onvakkundige reparatie veroorzaakt zijn, of er bij het uitwisselen van onderdelen geen gebruik gemaakt werd van onze originele GARDENA onderdelen of door ons vrigegeven onderdelen en de reparatie niet door de GARDENA technische dienst of de bevoegde vakman uitgevoerd werd. Ditzelfde geldt voor extra-onderdelen en accessoires.

S Produktansvar

Tillverkaren är inte ansvarig för skada som orsakats av produkten om skadan beror på att produkten har reparerats felaktigt eller om, vid reparation eller utbyte, andra än Original GARDENA reservdelar har använts. Samma sak gäller för kompletteringsdelar och tillbehör.

DK Produktansvar

Vi gør udtrykkeligt opmærksom på at i henhold til produktansvarsloven er vi ikke ansvarlige for skader forårsaget af vores udstyr, hvis det skyldes uautoriserede reparationer eller hvis dele er skiftet ud og der ikke er anvendt originale GARDENA dele eller dele godkendt af os, eller hvis reparationerne ikke er udført af GARDENA-service eller en autoriseret fagmand. Det samme gælder for ekstra udstyr og tilbehør.

FIN Tuotevastuu

Korostamme nimenomaan, että tuotevastuulain nojalla emme ole vastuussa laitteistamme johtuneista vahingoista, mikäli nämä ovat aiheutuneet epäasianmukaisesta korjauksesta tai osia vaihdettaessa ei ole käytetty alkuperäisiä GARDENA- varaosia tai hyväksymiämme osia ja korjauksen on suorittanut muu kuin GARDENA -huoltokeskus tai valtuuttamamme ammattihenkilö. Tämä pätee myös lisäosiin ja lisävarusteisiin.

I Responsabilità del prodotto

Si rende espressamente noto che, conformemente alla legislazione sulla responsabilità del prodotto, non si risponde di danni causati da nostri articoli se originati da riparazioni eseguite non correttamente o da sostituzioni di parti effettuate con materiale non originale GARDENA o comunque da noi non approvato e, in ogni caso, qualora l'intervento non venga eseguito da un centro assistenza GARDENA o da personale specializzato autorizzato. Lo stesso vale per le parti complementari e gli accessori.

E Responsabilidad de productos

Advertimos que conforme a la ley de responsabilidad de productos no nos responsabilizamos de daños causados por nuestros aparatos, siempre y cuando dichos daños hayan sido originados por arreglos o reparaciones indebidas, por recambios con piezas que no sean piezas originales GARDENA o bien piezas autorizadas por nosotros, así como en aquellos casos en que la reparación no haya sido efectuada por un Servicio Técnico GARDENA o por un técnico autorizado. Lo mismo es aplicable para las piezas complementarias y accesorios.

P Responsabilidade sobre o produto

Queremos salientar que segundo a lei da responsabilidade do fabricante, nós não nos responsabilizaremos por danos causados pelo nosso equipamento, quando estes ocorrerem em decorrência de reparações inadequadas ou da substituição de peças por peças não originais da GARDENA, ou peças não autorizadas. A responsabilidade tornar-se-à nula também depois de reparações realizadas por oficinas não autorizadas pela GARDENA. Esta restrição valerá também para peças adicionais e acessórios.

PL Odpowiedzialność za produkt

Zwracamy Państwa uwagę na fakt, iż nie odpowiadamy za szkody wyrządzone przez nasze urządzenia, jeżeli powstały one na skutek nieodpowiedniej naprawy albo zastosowania podczas wymiany nieoryginalnych części GARDENA lub części nie polecanych przez nas oraz jeżeli naprawa nie została dokonana przez serwis GARDENA lub autoryzowanego fachowca. Podobne ustalenia obowiązują w przypadku części uzupełniających lub osprzętu.

H Termékfelelősség

Nyomatékosan utalunk arra, hogy a termékfelelősségi törvény értelmében nem felelünk a készülékeink által okozott károkért, amennyiben ezek szakszerűtlen javítás következményei, vagy ha a cseréket nem eredeti GARDENA – vagy általunk kibocsátott alkatrészekkel végzik el és a javítást nem a GARDENA megbízott szervizei végezték. Ez értelemszerűen érvényes a kiegészítő részekre és a tartozékokra is.

CZ Ručení za výrobek

Upozorňujeme výslovně na skutečnost, že podle zákona o ručení za výrobky nejsme povinni ručit za škody vyvolané našimi výrobky, pokud tyto škody byly způsobeny neodbornou opravou nebo v případě výměny dílů nebyly použity naše originální díly GARDENA, popř. díly, které jsme schválili, a oprava nebyla provedena v servisu GARDENA nebo autorizovaným specialistou. Analogické ustanovení platí rovněž pro doplňky a příslušenství.

SK Zodpovednosť za vady výrobku

Výslovne zdôrazňujeme, že podľa zákona o ručení za výrobok nie sme zodpovední za škody spôsobené našim zariadením, ak sú spôsobené nesprávnou opravou, alebo ak sa nepoužili originálne diely GARDENA alebo nami schválené diely a ak nebola oprava vykonaná značkovou opravovňou GARDENA alebo autorizovaným odborníkom. To isté platí aj pre doplnkové diely a príslušenstvo.

GR Προϊόνευθύνη

Κάνουμε σαφές ότι, σύμφωνα με τους νόμους παραγωγής των προϊόντων, δεν είμαστε υπεύθυνοι για καμία ζημιά που προκλήθηκε από το προϊόν μας εάν δε χρησιμοποιήθηκαν για όλες τις συνδέσεις αποκλειστικά και μόνο τα γνήσια εξαρτήματα ή ανταλλακτικά της GARDENA ή αν το σέρβις δεν πραγματοποιήθηκε στο σέρβις της GARDENA. Τα ίδια ισχύουν για τα συμπληρωματικά μέρη και τα αξεσουάρ.

SLO Jamstvo za proizvode

Izrecno opozarjamo, da po Zakonu o jamstvu za proizvode, ne odgovarjamo za škode, ki so jih povzročile naše naprave, v kolikor je bila povzročena zaradi nestrokovnega popravila, ali pa pri zamenjavi delov niso bili uporabljeni originalni nadomestni deli GARDENA oziroma deli, ki jih dovolimo uporabiti in če popravilo ni bilo opravljeno v servisu GARDENA oz. pri pooblaščenem strokovnjaku. Ustrezno velja tudi za dele, ki nadgrajujejo napravo in pribor.

RO Responsabilitatea legala a produsului

Menționam în mod expres că, în concordanță cu responsabilitatea legală a produsului, nu suntem răspunzători de nici un accident provocat de produsele noastre dacă se datorează reparării necorespunzătoare sau dacă piesele de schimb nu sunt originale GARDENA sau aprobate de GARDENA, sau dacă reparațiile nu au fost efectuate de un Centru de Service GARDENA sau un specialist autorizat. Aceleași prevederi se aplică și pieselor de schimb și accesoriilor.

BG Отговорност за качество

Изрично подчертаваме, че съгласно закона за отговорност за качество, ние не носим отговорност за вредите причинени от нашите уреди, ако същите са причинени от неправилен ремонт или при подмяната на части не са използвани оригинални части на GARDENA или части одобрени от нас и ремонта не е извършен от сервиз на GARDENA или оторизиран специалист. Същото важи за допълнителните части и принадлежности.

EST Tootevastutus

Juhime teie tähelepanu sellele, et tootevastutusseaduse kohaselt ei vastuta me meie seadmete poolt põhjustatud kahjude eest, kui need on tekkinud asjatundmatu paranduse tagajärjel või kui detaili vahetamisel ei kasutatud GARDENA originaalvaruosi ega meie poolt kasutada lubatud varuosi ja kui parandustöid ei ole teinud GARDENA klienditeenindusspetsialistid ega meie volitatud spetsialistid. Sama kehtib lisadetailide ja tarvikute kohta.

LT Atsakomybė už produkciją

Prašome atkreipti dėmesį, kad remdamiesi „Mašinų saugos“ įstatymu, neatsakome už nuostolius, sukeltus mūsų prietaisų, jei jie atsirado dėl netinkamo remonto, arba, jei keičiant dalis, buvo naudojami neoriginalios GARDENA dalys arba dalys, kurių mes neleidome naudoti, o remontą atliko ne GARDENA serviso centras ar įgaliotas specialistas. Tas pats galioja papildomoms dalims ir priedams.

LV Produkta atbildība

Mēs skaidri norādām uz to, ka saskaņā ar Produktu atbildības likumu, mēs neatbildam par mūsu iekārtu radītiem zaudējumiem, ciktāl tos ir izraisījis neatbilstošs remonts vai daļu nomaiņa ar neoriģinālām GARDENA daļām vai ne ar mūsu norādītajām detaļām un remontu nav veicis GARDENA serviss vai pilnvarots speciālists. Tas pats attiecas uz papildinošajām daļām un piederumiem.

<p>D EU-Konformitätserklärung</p> <p>Der Unterzeichnete GARDENA Manufacturing GmbH, Hans-Lorenser-Str. 40, D-89079 Ulm, bestätigt, dass die nachfolgend bezeichneten Geräte in der von uns in Verkehr gebrachten Ausführung die Anforderungen der harmonisierten EU-Richtlinien, EU-Sicherheitsstandards und produktspezifischen Standards erfüllen. Bei einer nicht mit uns abgestimmten Änderung der Geräte verliert diese Erklärung ihre Gültigkeit.</p>	<p>H EU azonosság nyilatkozat</p> <p>Alulírott, GARDENA Manufacturing GmbH, Hans-Lorenser-Str. 40, D-89079 Ulm, igazolja, hogy az alább felsorolt, általunk forgalomba hozott termékek megfelelnek az EU elvárásoknak, EU biztonsági normáknak és a termékspecifikus szabványoknak egyaránt. A készülékek velünk nem egyeztetett változtatása esetén ez a nyilatkozat érvényét veszti.</p>
<p>GB EU Certificate of Conformity</p> <p>The undersigned GARDENA Manufacturing GmbH, Hans-Lorenser-Str. 40, D-89079 Ulm, hereby certifies that, when leaving our factory, the units indicated below are in accordance with the harmonised EU guidelines, EU standards of safety and product specific standards. This certificate becomes void if the units are modified without our approval.</p>	<p>CZ Prohlášení o shodě EU</p> <p>Niže podepsaná společnost GARDENA Manufacturing GmbH, se sídlem Hans-Lorenser-Str. 40, D-89079 Ulm, potvrzuje, že níže označený přístroj v provedení, které jsme uvedli na trh, splňuje požadavky uvedené v harmonizovaných směrniciích EU, v bezpečnostních standardech EU a ve standardech pro příslušné produkty. V případě změny přístroje, která námi nebyla odsouhlasena, stává se toto prohlášení neplatným.</p>
<p>F Certificat de conformité aux directives européennes</p> <p>Le constructeur, soussigné : GARDENA Manufacturing GmbH, Hans-Lorenser-Str. 40, D-89079 Ulm, déclare qu'à la sortie de ses usines le matériel neuf désigné ci-dessous était conforme aux prescriptions des directives européennes énoncées ci-après et conforme aux règles de sécurité et autres règles qui lui sont applicables dans le cadre de l'Union européenne. Toute modification portée sur ce produit sans l'accord express de GARDENA supprime la validité de ce certificat.</p>	<p>SK Vyhlasenie o zhode pre Európsku úniu</p> <p>Dolu podpísaný, GARDENA Manufacturing GmbH, Hans-Lorenser-Str. 40, D-89079 Ulm, potvrdzuje, že ďalej označené zariadenie vo vyhotovení nami uvedenom do prevádzky spĺňa požiadavky harmonizovaných smerníc Európskej únie, bezpečnostných štandardov Európskej únie a štandardov špecifických pre produkt. Pri vykonaní zmien zariadenia, ktoré nie sú námi odsúhlasené, stráca toto vyhlásenie platnosť.</p>
<p>NL EU-overeenstemmingsverklaring</p> <p>Ondergetekende GARDENA Manufacturing GmbH, Hans-Lorenser-Str. 40, D-89079 Ulm, bevestigt, dat het volgende genoemde apparaat in de door ons in de handel gebrachte uitvoering voldoet aan de eis van, en in overeenstemming is met de EU-richtlijnen, de EU-veiligheidsstandaard en de voor het product specifieke standaard. Bij een niet met ons afgestemde verandering aan het apparaat verliest deze verklaring haar geldigheid.</p>	<p>GR Πιστοποιητικό συμμόρφωσης ΕΚ</p> <p>Η υπογεγραμμένη : GARDENA Manufacturing GmbH, Hans-Lorenser-Str. 40, D-89079 Ulm πιστοποιεί ότι τα μηχανήματα που υποδεικνύονται κάτωθι, όταν φύονται από το εργοστάσιο, είναι κατασκευασμένα με τις οδηγίες της Ευρωπαϊκής Κοινότητας και τα Κοινωνικά πρότυπα ασφαλείας και προδιαγραφές.</p>
<p>S EU Tillverkarintyg</p> <p>Undertecknad firma GARDENA Manufacturing GmbH, Hans-Lorenser-Str. 40, D-89079 Ulm, intygar härmed att nedan nämnda produkt överensstämmer med EU:s direktiv, EU:s säkerhetsstandard och produktspecifikation. Detta intyg upphör att gälla om produkten ändras utan vårt tillstånd.</p>	<p>SLO Izjava o skladnosti s pravili EU</p> <p>Podpisano podjetje, GARDENA Manufacturing GmbH, Hans-Lorenser-Str. 40, D-89079 Ulm, potrjuje, da v nadaljevanju navedena naprava v različici, ki smo jo poslali na trg, izpolnjuje zahteve smernic EU, varnostnih standardov EU in standardov tovrstnih proizvodov. Izjava ne velja za spremembe na napravi, ki niso opravljene v soglasju z nami.</p>
<p>DK EU Overensstemmelse certifikat</p> <p>Undertegnede GARDENA Manufacturing GmbH, Hans-Lorenser-Str. 40, D-89079 Ulm bekræfter hermed, at enheder listen herunder, ved afsendelse fra fabrikken, er i overensstemmelse med harmoniserede EU retningslinier, EU sikkerhedsstandarder og produkt-specifikationsstandarder. Dette certifikat træder ud af kraft hvis enhederne er ændret uden vor godkendelse.</p>	<p>RO UE - Certificat de conformitate</p> <p>Prin prezenta GARDENA Manufacturing GmbH, Hans-Lorenser-Str. 40, D-89079 Ulm, certifica faptul ca, in momentul in care produsele mentionate mai jos ies din fabrica sunt in concordanta cu directivele UE, standardele de siguranta UE si standardele specifice ale produsului UE. Acest certificat devine nul in cazul modificarii aparatului fara aprobarea noastra.</p>
<p>FIN EY-vaatimustenmukaisuusvakuutus</p> <p>Allekirjoittanut GARDENA Manufacturing GmbH, Hans-Lorenser-Straße 40, D-89079 Ulm vakuuttaa, että allainiimitu laitheet täyttävät tehtaaltamme lähtiessään yhdenmukaistetun EY-direktiivin, EY-turvallisuusstandardien ja tuotekohtaisten standardien vaatimukset. Laitteisiin tehdyt muutokset, joista ei ole sovittu kanssamme, johtavat tämän vakuutuksen raukeamiseen.</p>	<p>BG ЕС-Декларация за съответствие</p> <p>Подписаната фирма GARDENA Manufacturing GmbH, Хнас-Лоренсер-Щрасе 40, Бермания-89079 Улм декларира, че описаните по-долу уреди, пуснати в продажба съгласно нашата спецификация, изпълняват изискванията на хармонизираните ЕС-директиви, ЕС-стандарт за безопасност и специфичните производствени стандарти. При промяна на уреда, която не е съгласувана с нас, тази декларация губи своята валидност.</p>
<p>I Dichiarazione di conformità alle norme UE</p> <p>La sottoscritta GARDENA Manufacturing GmbH, Hans-Lorenser-Str. 40, D-89079 Ulm, certifica che il prodotto qui di seguito indicato, nei modelli da noi commercializzati, è conforme alle direttive armonizzate UE nonché agli standard di sicurezza e agli standard specifici di prodotto. Qualunque modifica apportata al prodotto senza nostra specifica autorizzazione invalida la presente dichiarazione.</p>	<p>EST ELI vastavusdeklaratsioon</p> <p>Allakirjutatu GARDENA Manufacturing GmbH, Hans-Lorenser-Straße 40, D-89079 Ulm kinnitab, et kirjeldatud seade vastab meie poolt riiglusse viidud ELI harmoneeritud direktiividele, ELI ohutusstandarditele ja tootega seotud standarditele. Meiega kooskõlastamata muudatuse tegemise korral seadme kaotab see deklaratsioon kehtivuse.</p>
<p>E Declaración de conformidad de la UE</p> <p>El que suscribe GARDENA Manufacturing GmbH, Hans-Lorenser-Str. 40, D-89079 Ulm, declara que la presente mercancía, objeto de la presente declaración, cumple con todas las normas de la UE, en lo que a normas técnicas, de homologación y de seguridad se refiere. En caso de realizar cualquier modificación en la presente mercancía sin nuestra previa autorización, esta declaración pierde su validez.</p>	<p>LT ES Atitikties deklaracija</p> <p>Pasirašanti GARDENA Manufacturing GmbH, Hans-Lorenser-Straße 40, D-89079 Ulm patvirtina, kad žemiau nurodyti prietaisai ir jų modeliai, kuriuos paleidome į apyvartą, patenkina harmonizuotas ES direktyvas, ES saugumo standartus ir specifinius gaminių standartus. Atlikus bet kokį pakeitimą pakeičiant, kuris nėra suderintas su mumis, ši deklaracija praranda galiojimą.</p>
<p>P Certificado de conformidade da UE</p> <p>Os abaixo mencionados GARDENA Manufacturing GmbH, Hans-Lorenser-Str. 40, D-89079 Ulm, por este meio certificam que ao sair da fábrica o aparelho abaixo mencionado está de acordo com as directrizes harmonizadas da UE, padrões de segurança e de produtos específicos. Este certificado ficará nulo se a unidade for modificada sem a nossa aprovação.</p>	<p>LV ES-atbilstības deklarācija</p> <p>Parakstījis GARDENA Manufacturing GmbH, Hans-Lorenser-Straße 40 D-89079 Ulma, Vācijas apstiprina, ka sekojoši apzīmētais iekārtas, kuras mēs izplatām, savā izpildījumā atbilst harmonizētajām ES direktīvām, ES drošības standartiem un produkta specifikācijām standartiem. Ar mūsu neapstiprinātām izmaiņām iekārtā šī deklarācija zaudē savu derīgumu.</p>
<p>PL Deklaracja zgodności Unii Europejskiej</p> <p>Niżej podpisany GARDENA Manufacturing GmbH, Hans-Lorenser-Str. 40, D-89079 Ulm, potwierdza, że poniżej opisane urządzenie w wykonaniu wprowadzonym przez nas do obrotu spełnia wymogi zharmonizowanych wytycznych Unii Europejskiej, standardów bezpieczeństwa Unii Europejskiej i standardów specyficznych dla danego produktu. W przypadku wprowadzenia zmian nie uzgodnionych z nami wyjaśnienie to traci swoją ważność.</p>	

<p>Bezeichnung des Gerätes: Akku-Heckenschere Description of the unit: Cordless Hedge Trimmer Désignation du matériel : Taille-haies sur Accu Omschrijving van het apparaat: Accu-heggenschaar Produktbeskrivning: Accu Häcksax Beskrivelse af enhederne: Accu hækkeklipper Laitteen nimitys: Akkukäyttöinen aitalleikkuri Descrizione del prodotto: Tagliasiepi a batteria Descripción de la mercancía: Recortasetos con Accu Descrição do aparelho: Corta sebes com acumulador Opis urządzenia: Akumulatorowe nożyce do żywoplotów</p> <p>A készülék megnevezése: Akkumulátoros sövénynyíró Označení přístroje: Akumulátorové nůžky na živý plot Označenie prístroja: Akumulátorové nožnice na živý plot Όνομασία της συσκευής: Θαμνοκοπτική μπαταρίας Oznaka naprave: Akumulatorske škarje za živo mejo Descrierea articolelor: Trimmer de gard viu cu acumulator Обозначение на уредите: Accu Ножица за жив плет Seadmete nimetus: Akuga hekilõikur Gaminio pavadinimas: Akumulatorinės gyvatvorių žirkklės lekártu apzíméjms: Accu dzívžoga škères</p>	<p>Schall-Leistungspegel: gemessen / garantiert Noise level: measured / guaranteed Puissance acoustique : mesurée / garantie Geluidsniveau: gemeten / gegarandeerd Ljudnivá: uppmått / garanterad Lydtryksniveau: afmålt / garanti Melun tihetaso: mittattu / taattu Livello rumorosità: testato / garantito Nivel sonoro: medido / garantizado Nível de ruído: medido / garantido Poziom hałas: zmierzony / gwarantowany Zajszint: mért / garantált Hladina hluku: naměřeno / zaručeno Výkonová úroveň hluku: meraná / zaručená Στάθμη ηχητικής πίεσης: μετρηθείσα / εγγυημένη Glasnost: izmerjeno / garantirano Nivelul de zgomot: măsurat / garantat Ниво на шума и мощността: измерено / гарантирано Helivõimsuse tase: mõeldud / tagatud Garso galios lygis: išmatuotas / garantuotas Skaņas jaudas līmenis: izmērītais / garantētais</p> <p>88 dB (A) / 90 dB (A)</p>
<p>Typ: Art.-Nr.: Típusok: Cikkszám: Type: Art. No.: Typ: Č.výr: Type : Référence : Typ: Č.výr: Typ: Art. nr.: Τύπος: Κωδ. Νο.: Typ: Art.nr.: Tip: Št. art.: Type: Varenr.: Tipuri: Nr art.: Typit: Art.-n:o.: Τύπος: Αρτ.-Νε : Modello: Art.: Tüübid: Toote nr.: Tipo: Art. Nº: Tipas: Gaminio Nr.: Tipo: Art. Nº: Tipi: Art.-Nr.: Typ: Nr art.: ErgoCut 48-LI 8878</p>	<p>Anbringningsjahr der CE-Kennzeichnung: CE bejegyzés kelté: Year of CE marking: Rok přidělení značky CE: Year of CE marking: Rok pridelenia označenia CE: Date d'apposition du marquage CE : Έτος πιστοποίησης ποιότητας CE: Installatiejaar van de CE-aanduiding: Leto namestitve oznake CE: CE-Märkningsår: Anul de marcarea CE: CE-Mærkningsår: Година на поставяне на CE-маркировка: CE-merkin kiinnitysvuosi: CE-märgistuse paigaldamise aasta: Anno di rilascio della certificazione CE: CE- markējuma uzlikšanas gads: Colocación del distintivo CE: Metai, kuriais paženklinta CE-ženklui: Ano de marcação pela CE: Rok nadania znaku CE: 2010</p>
<p>EU-Richtlinien: EU szabványok: EU directives: Směrnice EU: Directives européennes : Smernice EU: EU-richtlijnen: Προδιαγραφές EK: EU direktiv: Smernice EU: EU Retningslinier: Directive UE: EY-direktiivit: ES-директиви: Direttive UE: ELi direktiivid: Normativa UE: ES direktyvos: Directrices da UE: ES-direktivas: Dyrektywy UE:</p> <p>2006/42/EC 93/68/EC 2004/108/EC 2000/14/EC</p>	<p>Ulm, den 22.02.2010 Ulm, 22.02.2010 Fait à Ulm, le 22.02.2010 Ulm, 22-02-2010 Ulm, 2010.02.22. Ulm, 22.02.2010 Ulmissa, 22.02.2010 Ulm, 22.02.2010 Ulm, 22.02.2010 Ulm, 22.02.2010 Ulm, 22.02.2010r. Ulm, 22.02.2010 Ulm, 22.02.2010 V Ulmu, dne 22.02.2010 Ulm, 22.02.2010 Ulm, 22.02.2010 Ulm, 22.02.2010 Ulm, 22.02.2010 Ulm, 22.02.2010 Ulm, 2010.02.22 Ulma, 22.02.2010</p> <p>Der Bevollmächtigte Authorised representative Représentant légal Gemachtigter Behörig Firmatecknare Teknisk direktör Valtuutettu edustaja Rappresentante autorizzato Representante autorizado Representante autorizado Uprawniony do reprezentacji Meghatalmazott Zplnomocnenec Srlnomocnenec Νόμιμος εκπρόσωπος της εταιρίας Vodja tehničnega oddelka Conducerea tehnică Упълномощен Volitatud esindaja Įgaliotasis atstovas Pilnvarotā persona</p> <p>Peter Lameli Vice President</p>
<p>Harmonisierte EN: EN 60745-1 EN 60745-2-15</p> <p>EN ISO 12100-1 EN ISO 12100-2</p>	<p>Hinterlegte Dokumentation: GARDENA Technische Dokumentation E. Renn 89079 Ulm Deposited Documentation: GARDENA Technical Documentation E. Renn 89079 Ulm Documentation déposée : Documentation technique GARDENA E. Renn 89079 Ulm Konformitätsbewertungsverfahren: Nach 2000/14/EG Art. 14 Anhang V Conformity Assessment Procedure: according to 2000/14/EC Art. 14 Annex V Procédure d'évaluation de la conformité : Selon 2000/14/CE art. 14 Annexe V</p>

Deutschland / Germany

GARDENA GmbH
Central Service
Hans-Lorenser-Straße 40
D-89079 Ulm
Produktfragen:
(+49) 731 490-123
Reparaturen:
(+49) 731 490-290
service@gardena.com

Albania

EIG Sh.p.k - Rruga. Siri Kodra
Blloku i Magazinave
Frigoriferi Metalik Blu
4000 Tirana

Argentina

Husqvarna Argentina S.A.
Vera 745
(C1414AOO) Buenos Aires
Phone: (+54) 11 4858-5000
diego.poggi@ar.husqvarna.com

Australia

Husqvarna Australia Pty. Ltd.
Locked Bag 5
Central Coast BC, NSW 2252
Phone: (+61) (0) 2 4352 7400
customer.service@
husqvarna.com.au

Austria / Österreich

Husqvarna Austria GmbH
Consumer Products
Industriezeile 36
4010 Linz
Tel.: (+43) 732 77 01 01 - 90
consumer.service@husqvarna.at

Belgium

GARDENA Belgium NV/SA
Sterrebeekstraat 163
1930 Zaventem
Phone: (+32) 2 720 92 12
Mail: info@gardena.be

Bosnia / Hercegovina

SILK TRADE d.o.o.
Industrijska zona Bukva bb
74260 Tešanj

Brazil

Palash Comércio e
Importação Ltda.
Rua São João do Araguaia, 338
- Jardim Califórnia -
Barueri - SP - Brasil -
CEP 06409-060
Phone: (+55) 11 4198-9777
eduardo@palash.com.br

Bulgaria

Хускварна България ЕООД
Бул. „Андрей Ляпчев“ № 72
1799 София
Tel.: (+359) 02/9753076
www.husqvarna.bg

Canada / USA

GARDENA Canada Ltd.
100 Summerlea Road
Brampton, Ontario L6T 4X3
Phone: (+1) 905 792 9330
info@gardenacanada.com

Chile

Antonio Martinic y Cia Ltda.
Cassillas 272
Centro de Cassillas
Santiago de Chile
Phone: (+56) 2 20 10 708
garfar_cl@yahoo.com

Costa Rica

Compania Exim
Euroiberoamericana S.A.
Los Colegios, Moravia,
200 metros al Sur del Colegio
Saint Francis - San José
Phone: (+506) 297 68 83
exim_euro@racsa.co.cr

Croatia

SILK ADRIA d.o.o.
Josipa Lončara 3
10090 Zagreb
Phone: (+385) 1 3794 580
silk.adria@zg.t-com.hr

Cyprus

FARMOKIPIKI LTD
P.O. Box 7098
74, Digeni Akrita Ave.
1641 Nicosia
Phone: (+357) 22 75 47 62
condam@spidernet.com.cy

Czech Republic / Slovak Republic

Husqvarna Česko s.r.o.
odšlepny závod GARDENA
Tuřanka 1222/115
627 00 Brno
Phone: (+420) 548 217 777
gardena@gardenabrno.cz

Denmark

GARDENA
Husqvarna Consumer Outdoor
Products
Salgsafdelning Danmark
Box 9003
S-200 39 Malmö
info@gardena.dk

Estonia

Husqvarna Eesti OÜ
Consumer Outdoor Products
Kesk tee 10, Aaviku küla
Rae vald
Harju maakond
75305 Estonia
kontakt.etj@husqvarna.ee

Finland

Oy Husqvarna Ab
Consumer Outdoor Products
Lautatarhankatu 8 B / PL 3
00581 HELSINKI
info@gardena.fi

France

GARDENA France
Immeuble Expositel
9 - 11 allée des Pierres Mayettes
ZAC des Barbanniers, B.P. 99
-F- 92232 GENNEVILLIERS
cedex
Tél. (+33) 01 40 85 30 40
service.consommateurs@
gardena.fr

Great Britain

Husqvarna UK Ltd
Preston Road
Aycliffe Industrial Park
Newton Aycliffe
County Durham
DL5 6UR
info.gardena@husqvarna.co.uk

Greece

HUSQVARNA ΕΛΛΑΣ Α.Ε.Β.Ε.
Υγι/ια Ηφαίστου 33Α
Βι. Πε. Κορωπίου
194 00 Κορωπί Αττικής
V.A.T. EL094094640
Phone: (+30) 210 66 20 225
info@husqvarna-consumer.gr

Hungary

Husqvarna Magyarorszag Kft.
Ezred u. 1-3
1044 Budapest
Phone: (+36) 1 251-4161
vevoszolgalat.husqvarna@
husqvarna.hu

Iceland

O. Johnson & Kaaber
Tunguhalsi 1
110 Reykjavik
oof@ojk.is

Ireland

McLoughlin's RS
Unit 5,
Northern Cross Business Park
North Road, Finglas
Dublin 11

Italy

GARDENA Italia S.p.A.
Via Santa Vecchia 15
23868 VALMADRERA (LC)
Phone: (+39) 0341.203.111
info@gardenaitalia.it

Japan

KAKUICHI Co. Ltd.
Sumitomo Realty &
Development Kojimachi
BLDG., 8F, 5-1 Nibanncyo,
Chiyoda-ku, Tokyo 102-0084
Phone: (+81) 33 264 4721
m_ishihara@kaku-ichi.co.jp

Latvia

Husqvarna Latvija
Consumer Outdoor Products
Bākužu iela 6
LV-1024 Rīga
info@husqvarna.lv

Lithuania

UAB Husqvarna Lietuva
Consumer Outdoor Products
Ateities pl. 77C
LT-52104 Kaunas
centras@husqvarna.lt

Luxembourg

Magasins Jules Neuberger
39, rue Jacques Stab
Luxembourg-Gasperich 2549
Case Postale No. 12
Luxembourg 2010
Phone: (+352) 40 14 01
api@neuberger.lu

Netherlands

GARDENA Nederland B.V.
Postbus 50176
1305 AD ALMERE
Phone: (+31) 36 521 00 00
info@gardena.nl

Neth. Antilles

Jonka Enterprises N.V.
Sta. Rosa Weg 196
P.O. Box 8200, Curaçao
Phone: (+599) 9 767 66 55
pgm@jonka.com

New Zealand

Husqvarna New Zealand Ltd.
PO Box 76437
Manukau City 2241
Phone: (+64) (0) 9 9202410
support.nz@husqvarna.co.nz

Norway

GARDENA / Husqvarna
Consumer Outdoor Products
Salgskontor Norge
Kleiverveien 6
1540 Vestby
info@gardena.no

Poland

Husqvarna Poland Spółka z o.o.
ul. Wysockiego 15 b
03-371 Warszawa
Oddział w Szymanowie
Szymanów 9 d
05-532 Baniocha
Phone: (+48) 22 727 56 90
gardena@gardena.pl

Portugal

GARDENA Portugal Lda.
Sintra Business Park
Edifício 1, Fração 0-G
2710-089 Sintra
Phone: (+351) 21 922 85 30
info@gardena.pt

Romania

Madex International Srl
Soseaua Odaii 117 - 123,
RO 013603, București, S 1
Phone: (+40) 21 352.76.03
madex@ines.ro

Russia

ООО „Хускварна“
141400, Московская обл.,
г. Химки,
улица Ленинградская,
владение 39,
Химки Бизнес Парк,
Здание II, 4 этаж.

Serbia

Domel d.o.o.
Savski nasip 7
11070 Novi Beograd
Phone: (+381) 11 2772 204
milorav.vejina@domel.co.yu

Singapore

Hy - Ray PRIVATE LIMITED
40 Jalan Pemimpin
#02-08 Tat Ann Building
Singapore 577185
Phone: (+65) 6253 2277
shiyang@hyray.com.sg

Slovenia

GARDENA d.o.o.
Brodišče 15
1236 Trzin
Phone: (+386) 1 580 93 32
servis@gardena.si

South Africa

GARDENA
South Africa (Pty.) Ltd.
P.O. Box 11534
Vorna Valley 1686
Phone: (+27) 11 315 02 23
sales@gardena.co.za

Spain

GARDENA IBERICA S.L.U.
C/ Basauri, nº 6
La Florida
28023 Madrid
Phone: (+34) 91 708 05 00
atencioncliente@gardena.es

Sweden

GARDENA / Husqvarna
Consumer Outdoor Products
Försäljningskontor Sverige
Box 9003
200 39 Malmö
info@gardena.se

Switzerland / Schweiz

Husqvarna Schweiz AG
Consumer Products
Industriestrasse 10
5506 Mägenwil
Phone: (+41) (0) 848 800 464
info@gardena.ch

Turkey

GARDENA Dost Diş Ticaret
Müessesilik A.Ş.
Sanayi Cad. Adil Sokak
No: 1/B Kartal
34873 Istanbul
Phone: (+90) 216 38 93 939
info@gardena-dost.com.tr

Ukraine / Україна

ТОВ «Хусварна Україна»
вул. Васильківська, 34,
офіс 204-г
03022, Київ
Тел. (+38) 044 498 39 02
info@gardena.ua

8878-20.960.01/0210

© GARDENA
Manufacturing GmbH
D-89070 Ulm
http://www.gardena.com

Free Manuals Download Website

<http://myh66.com>

<http://usermanuals.us>

<http://www.somanuals.com>

<http://www.4manuals.cc>

<http://www.manual-lib.com>

<http://www.404manual.com>

<http://www.luxmanual.com>

<http://aubethermostatmanual.com>

Golf course search by state

<http://golfingnear.com>

Email search by domain

<http://emailbydomain.com>

Auto manuals search

<http://auto.somanuals.com>

TV manuals search

<http://tv.somanuals.com>