

Electric Airless Sprayers

3A0156A
ENG

- For Portable Airless Spraying of Architectural Coatings and Paints -

3300 psi (227 bar, 22.7 MPa) Maximum Working Pressure



IMPORTANT SAFETY INSTRUCTIONS

Read all warnings and instructions in this manual. Save these instructions.

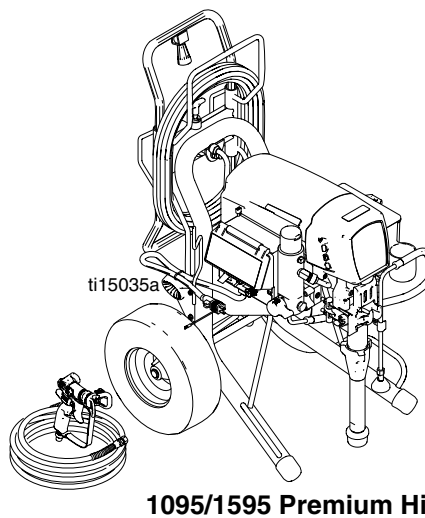
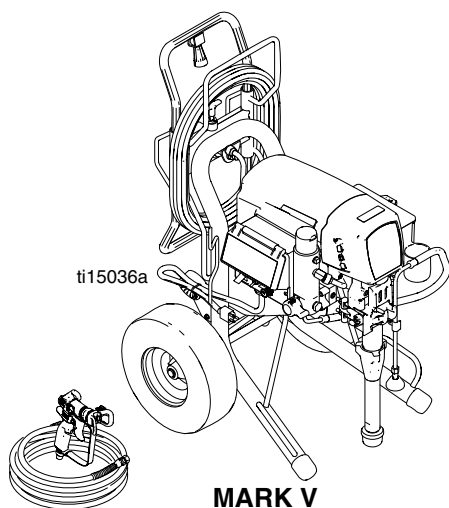
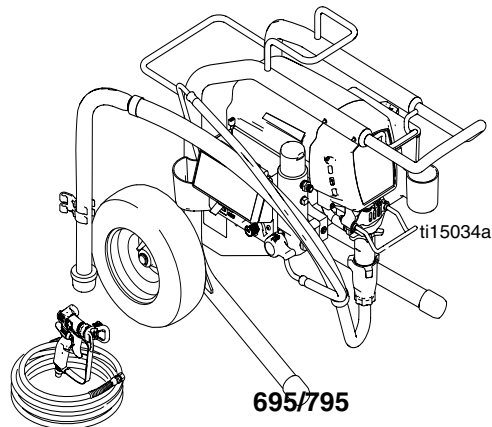
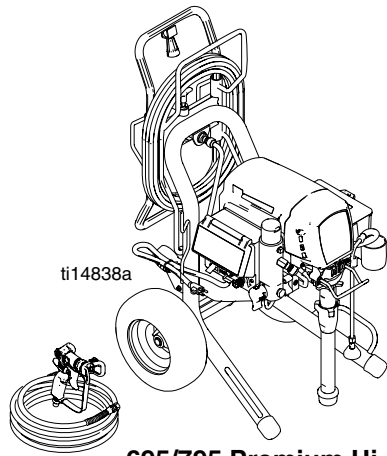

Related Manuals:
Repair 3A0157
Parts 3A0158
Gun 311861



Intertek

PROVEN QUALITY. LEADING TECHNOLOGY.

Models:

Models:

695 ULTRA MAX III			
Model	QuikReel	Hi-Boy	Lo-Boy
258719	✓	✓	
258720		✓	
258722			✓
258872			✓
258873		✓	
258874			✓
258876		✓	
258877	✓	✓	
826124	✓	✓	
826125		✓	
826127			✓
795 ULTRA MAX III			
Model	QuikReel	Hi-Boy	Lo-Boy
258723	✓	✓	
258724		✓	
258878	✓	✓	
258879			✓
258881		✓	
258882	✓	✓	
826128	✓	✓	
826129		✓	
1095 ULTRA MAX III			
Model	QuikReel	Hi-Boy	Lo-Boy
258727	✓	✓	
258728		✓	
258883	✓	✓	
258884		✓	
258886	✓	✓	
826130	✓	✓	
826131		✓	
1595 ULTRA MAX III			
Model	QuikReel	Hi-Boy	Lo-Boy
258763	✓	✓	
258764		✓	
258765	✓	✓	
258766		✓	
826132	✓	✓	
826133		✓	
826134	✓	✓	
826135		✓	
MARK IV			
Model	QuikReel	Hi-Boy	Lo-Boy
258729	✓	✓	
MARK V			
Model	QuikReel	Hi-Boy	Lo-Boy
258730	✓	✓	
258887	✓	✓	

Warnings

The following warnings are for the setup, use, grounding, maintenance and repair of this equipment. The exclamation point symbol alerts you to a general warning and the hazard symbol refers to procedure-specific risks. Refer back to these warnings. Additional, product-specific warnings may be found throughout the body of this manual where applicable.

Grounding Instructions

This product must be grounded. In the event of an electrical short circuit, grounding reduces the risk of electric shock by providing an escape wire for the electric current. This product is equipped with a cord having a grounding wire with an appropriate grounding plug. The plug must be plugged into an outlet that is properly installed and grounded in accordance with all local codes and ordinances.

WARNING



GROUNDING

This product must be grounded. In the event of an electrical short circuit, grounding reduces the risk of electric shock by providing an escape wire for the electric current. This product is equipped with a cord having a grounding wire with an appropriate grounding plug. The plug must be plugged into an outlet that is properly installed and grounded in accordance with all local codes and ordinances.

- Improper installation of the grounding plug is able to result in a risk of electric shock.
- When repair or replacement of the cord or plug is required, do not connect the grounding wire to either flat blade terminal.
- The wire with insulation having an outer surface that is green with or without yellow stripes is the grounding wire.
- Check with a qualified electrician or serviceman when the grounding instructions are not completely understood, or when in doubt as to whether the product is properly grounded.
- Do not modify the plug provided; if it does not fit the outlet, have the proper outlet installed by a qualified electrician.
- This product is for use on a nominal 120V circuit and has a grounding plug similar to the plug illustrated in the figure below.

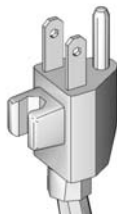

- Only connect the product to an outlet having the same configuration as the plug.
- Do not use an adapter with this product.

Extension Cords:

- Use only a 3-wire extension cord that has a 3-blade grounding plug and a 3-slot receptacle that accepts the plug on the product.
- Make sure your extension cord is not damaged. If an extension cord is necessary, use 12 AWG (2.5 mm²) minimum to carry the current that the product draws.
- An undersized cord results in a drop in line voltage and loss of power and overheating.











WARNING
**FIRE AND EXPLOSION HAZARD**

Flammable fumes, such as solvent and paint fumes, in work area can ignite or explode. To help prevent fire and explosion:

- Do not spray flammable or combustible materials near an open flame or sources of ignition such as cigarettes, motors, and electrical equipment.
- Paint or solvent flowing through the equipment is able to result in static electricity. Static electricity creates a risk of fire or explosion in the presence of paint or solvent fumes. All parts of the spray system, including the pump, hose assembly, spray gun, and objects in and around the spray area shall be properly grounded to protect against static discharge and sparks. Use Graco conductive or grounded high-pressure airless paint sprayer hoses.
- Do not clean with materials having flash points lower than 70° F (21° C). Use water-based material or mineral spirits-type material only. For complete information about your fluid, request the MSDS from the fluid distributor or retailer.
- Verify that all containers and collection systems are grounded to prevent static discharge.
- Connect to a grounded outlet and use grounded extensions cords. Do not use a 3-to-2 adapter.
- Do not use a paint or a solvent containing halogenated hydrocarbons.
- Keep spray area well-ventilated. Keep a good supply of fresh air moving through the area. Keep pump assembly in a well ventilated area. Do not spray pump assembly.
- Do not smoke in the spray area.
- Do not operate light switches, engines, or similar spark producing products in the spray area.
- Keep area clean and free of paint or solvent containers, rags, and other flammable materials.
- Know the contents of the paints and solvents being sprayed. Read all Material Safety Data Sheets (MSDS) and container labels provided with the paints and solvents. Follow the paint and solvents manufacturer's safety instructions.
- Fire extinguisher equipment shall be present and working.
- Sprayer generates sparks. When flammable liquid is used in or near the sprayer or for flushing or cleaning, keep sprayer at least 20 feet (6 m) away from explosive vapors.

**SKIN INJECTION HAZARD**

- Do not aim the gun at, or spray any person or animal.
- Keep hands and other body parts away from the discharge. For example, do not try to stop leaks with any part of the body.
- Always use the nozzle tip guard. Do not spray without nozzle tip guard in place.
- Use Graco nozzle tips.
- Use caution when cleaning and changing nozzle tips. In the case where the nozzle tip clogs while spraying, follow the **Pressure Relief Procedure** for turning off the unit and relieving the pressure before removing the nozzle tip to clean.
- Do not leave the unit energized or under pressure while unattended. When the unit is not in use, turn off the unit and follow the **Pressure Relief Procedure** for turning off the unit.
- High-pressure spray is able to inject toxins into the body and cause serious bodily injury. In the event that injection occurs, **get immediate surgical treatment**.
- Check hoses and parts for signs of damage. Replace any damaged hoses or parts.
- This system is capable of producing 3300 psi. Use Graco replacement parts or accessories that are rated a minimum of 3300 psi.
- Always engage the trigger lock when not spraying. Verify the trigger lock is functioning properly.
- Verify that all connections are secure before operating the unit.
- Know how to stop the unit and bleed pressure quickly. Be thoroughly familiar with the controls.

 WARNING	
 	<p>EQUIPMENT MISUSE HAZARD Misuse can cause death or serious injury.</p> <ul style="list-style-type: none"> • Always wear appropriate gloves, eye protection, and a respirator or mask when painting. • Do not operate or spray near children. Keep children away from equipment at all times. • Do not overreach or stand on an unstable support. Keep effective footing and balance at all times. • Stay alert and watch what you are doing. • Do not leave the unit energized or under pressure while unattended. When the unit is not in use, turn off the unit and follow the Pressure Relief Procedure for turning off the unit. • Do not operate the unit when fatigued or under the influence of drugs or alcohol. • Do not kink or over-bend the hose. • Do not expose the hose to temperatures or to pressures in excess of those specified by Graco. • Do not use the hose as a strength member to pull or lift the equipment.
 	<p>ELECTRIC SHOCK HAZARD This equipment must be grounded. Improper grounding, setup, or usage of the system can cause electric shock.</p> <ul style="list-style-type: none"> • Turn off and disconnect power at main switch before disconnecting any cables and before servicing equipment. • Connect only to grounded power source. • All electrical wiring must be done by a qualified electrician and comply with all local codes and regulations.
	<p>PRESSURIZED ALUMINUM PARTS HAZARD Use of fluids that are incompatible with aluminum in pressurized equipment can cause serious chemical reaction and equipment rupture. Failure to follow this warning can result in death, serious injury, or property damage.</p> <ul style="list-style-type: none"> • Do not use 1,1,1-trichloroethane, methylene chloride, other halogenated hydrocarbon solvents or fluids containing such solvents. • Many other fluids may contain chemicals that can react with aluminum. Contact your material supplier for compatibility.
 	<p>MOVING PARTS HAZARD Moving parts can pinch, cut or amputate fingers and other body parts.</p> <ul style="list-style-type: none"> • Keep clear of moving parts. • Do not operate equipment with protective guards or covers removed. • Pressurized equipment can start without warning. Before checking, moving, or servicing equipment, follow the Pressure Relief Procedure and disconnect all power sources.
	<p>PERSONAL PROTECTIVE EQUIPMENT You must wear appropriate protective equipment when operating, servicing, or when in the operating area of the equipment to help protect you from serious injury, including eye injury, hearing loss, inhalation of toxic fumes, and burns. This equipment includes but is not limited to:</p> <ul style="list-style-type: none"> • Protective eyewear, and hearing protection. • Respirators, protective clothing, and gloves as recommended by the fluid and solvent manufacturer.

Component Identification

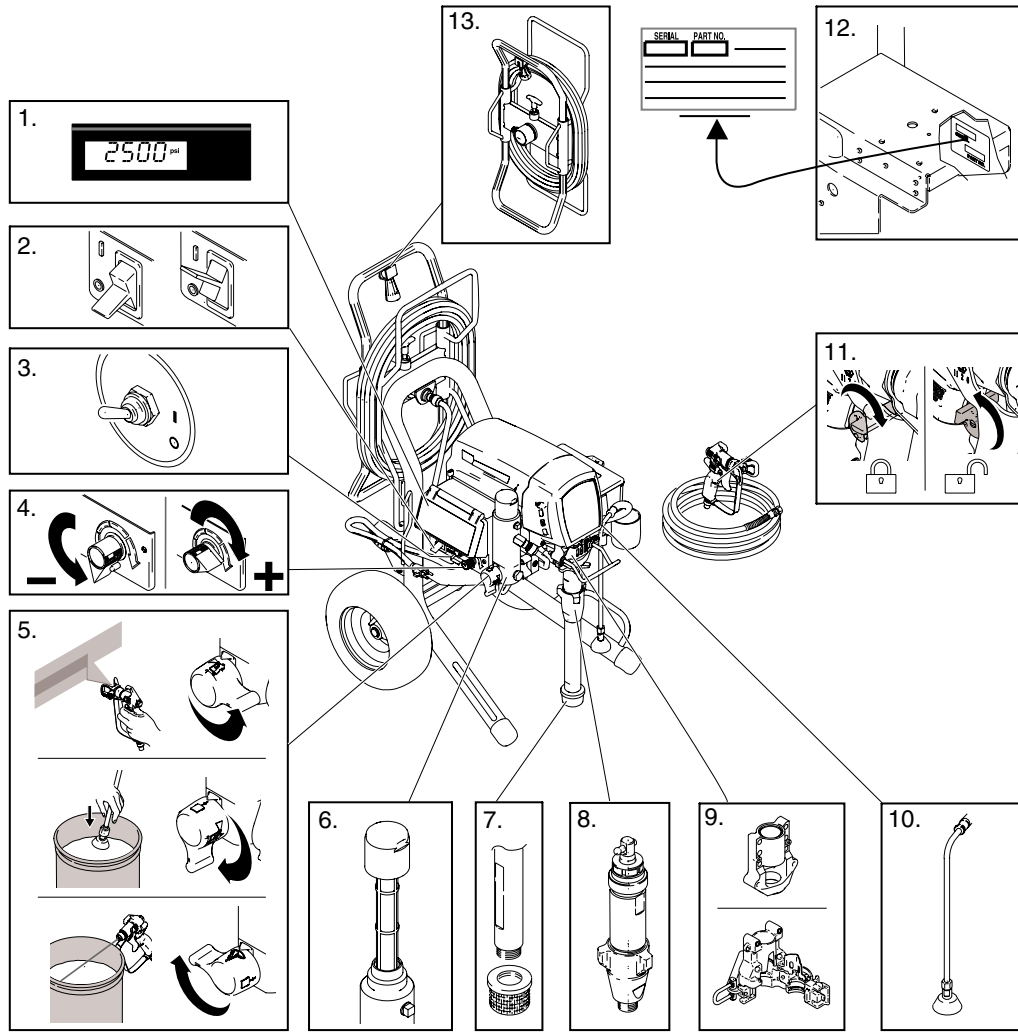

ti14839a

1	Premium Digital Display
2	ON/OFF Switch
3	WatchDog™ Switch (not available on Mark V or Standard Units)
4	Pressure Control
5	Prime / Spray Valve
6	Filter
7	Siphon Tube
8	Pump
9	Bearing Housing / ProConnect™
10	Drain Tube
11	Trigger Lock
12	Model/Serial Tag
13	Hose Reel

Grounding

The sprayer must be grounded. Grounding reduces the risk of static and electric shock by providing an escape wire for the electrical current due to static build up or in the event of a short circuit.

The sprayer cord includes a grounding wire with an appropriate grounding contact.

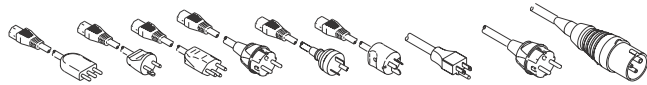

The plug must be plugged into an outlet that is properly installed and grounded in accordance with all local codes and ordinances.

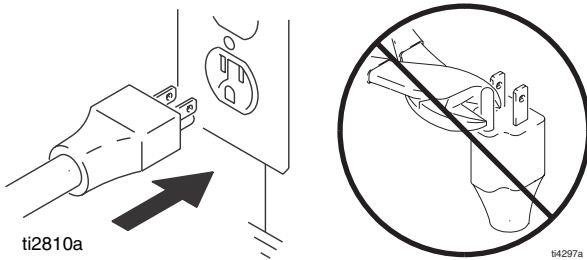

Do not modify plug! Tampering with the plug will result in a voided warranty. If plug will not fit in outlet, have grounded outlet installed by a qualified electrician. Do not use an adapter.

Power Requirements

- 100-120V units require 100-120 VAC, 50/60 Hz, 15A, 1 phase.
- 230V units require 230 VAC, 50/60 HZ, 10A, 1 phase.

Extension Cord

Use an extension cord with an undamaged ground contact. If an extension cord is necessary, use a 3-wire, 12 AWG (2.5 mm²) minimum.

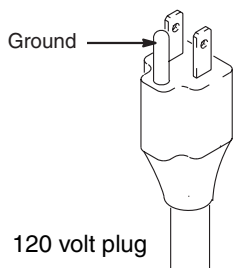

Pails

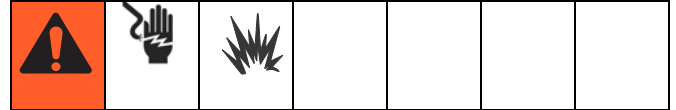

Solvent and oil/based fluids: follow local code. Use only conductive metal pails, placed on a grounded surface such as concrete.

Do not place pail on a nonconductive surface such as paper or cardboard which interrupts grounding continuity.



Grounding a metal pail: connect a ground wire to the pail by clamping one end to pail and other end to a true earth ground.

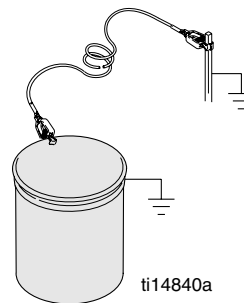

To maintain grounding continuity when flushing or relieving pressure: hold metal part of spray gun firmly to side of a grounded metal pail. Then trigger gun.

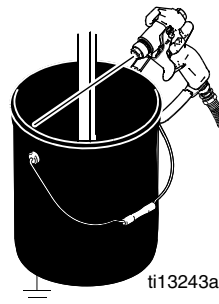

15/20 Amp Switch (Not Available on All Units)

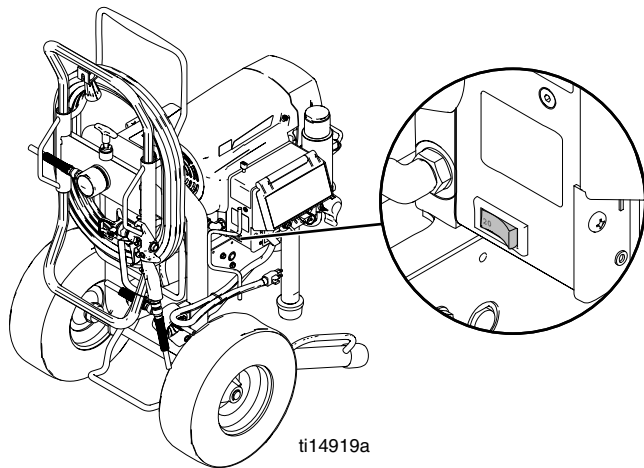

Select 15A or 20A setting based on your circuit rating.

Pressure Relief Procedure



1. Turn power **OFF**. Wait 7 seconds for power to dissipate.

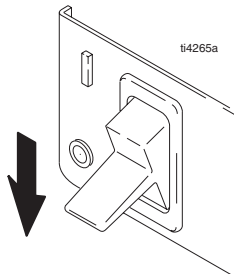

2. Lock gun trigger safety. Remove guard and SwitchTip.

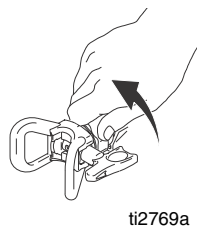
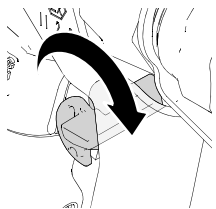

3. Turn pressure to lowest setting. Trigger gun to relieve pressure.

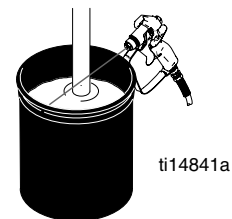
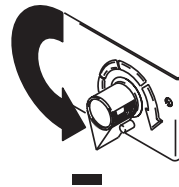

4. Put drain tube in pail. Turn prime valve down to DRAIN position.

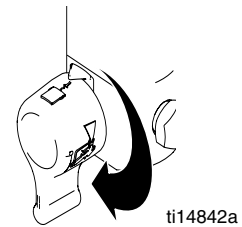
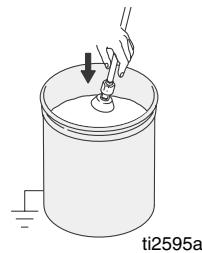

Setup



1. **Standard Units Only:** Connect Graco airless hose to sprayer. Tighten securely.

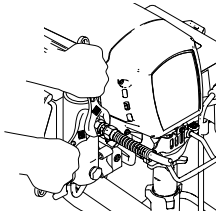

ti14843a

2. **Standard Units Only:** Connect other end of hose to gun and tighten securely.

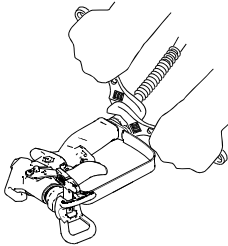

ti13031a

3. Engage gun trigger safety.

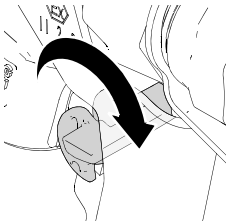

ti10166a

4. Remove tip guard.

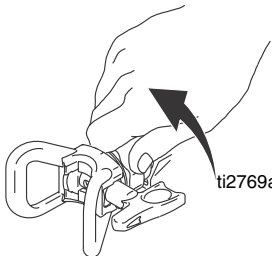

ti2769a

5. Check inlet strainer for clogs and debris.

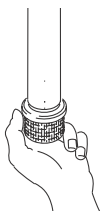

6. Fill throat packing nut with Graco TSL to prevent premature packing wear. Do this each time you spray.

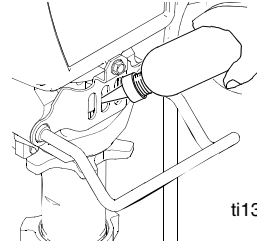

ti13453a

7. Turn power OFF.

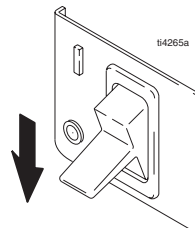

ti4265a

ti4265a

8. Plug power supply cord into a properly grounded electrical outlet.

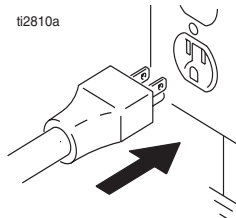

ti2810a

9. Turn prime valve down to DRAIN position.

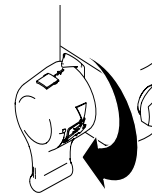

ti14842a

10. Place pump in grounded metal pail partially filled with flushing fluid. Attach ground wire to pail and to true earth ground. Perform steps 1 - 5 of **Startup** to flush out storage oil shipped in sprayer. Use water to flush water-base paint and mineral spirits to flush oil-base paint and storage oil.

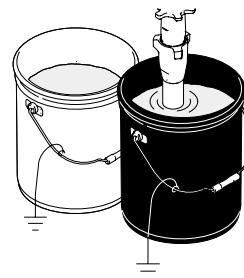

ti14844a

Startup



1. Turn pressure control to lowest pressure.

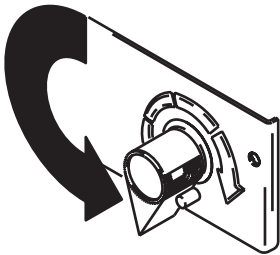

2. Turn power ON.

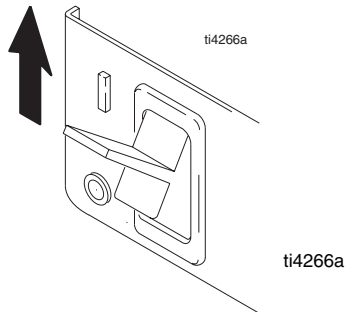

3. Increase pressure 1/2 turn to start motor and allow fluid to circulate through drain tube for 15 seconds; turn pressure down.



15sec.

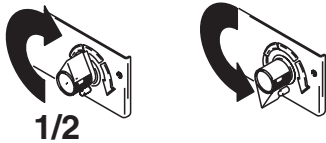

4. Turn prime valve forward to SPRAY position. Disengage gun trigger safety.

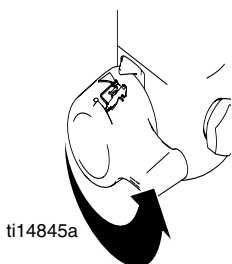

ti14845a

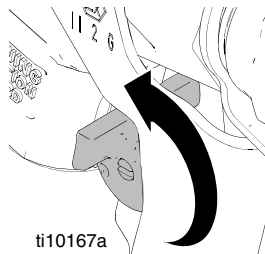

ti10167a

5. Hold gun against grounded metal flushing pail. Trigger gun and increase fluid pressure 1/2 turn. Flush 1 minute.

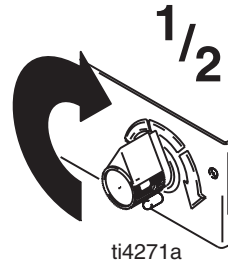

ti4271a

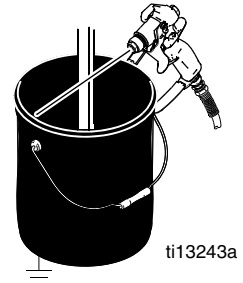

ti13243a

6. Inspect for leaks. Do not stop leaks with hand or a rag! If leaks occur, perform **Pressure Relief Procedure**, page 8. Tighten fittings. Perform **Startup**, steps 1 - 5. If no leaks, proceed to step 7.

7. Place pump in paint pail.

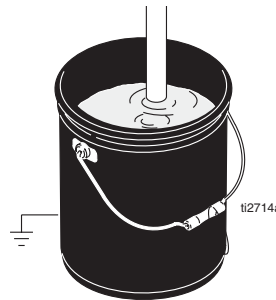

ti2714a

PAINT

8. Trigger gun again into flushing pail until paint appears. Move gun to paint pail and trigger for 20 seconds. Set gun safety ON. Assemble tip and guard, see instructions on next page.

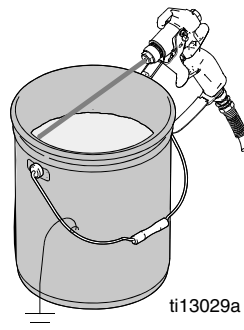

ti13029a

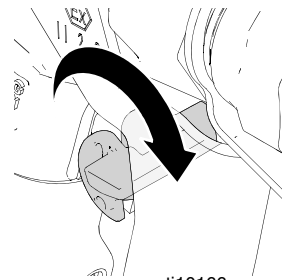

ti10166a

Switch Tip Installation



1. Use spray tip (A) to insert OneSeal™ (B) into guard (C).

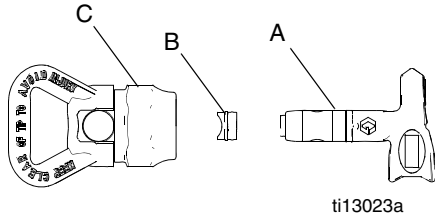

2. Insert Switch Tip.

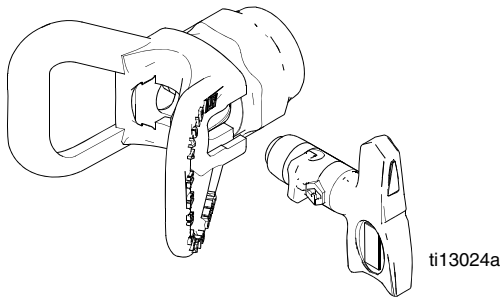

3. Screw assembly onto gun. Tighten.

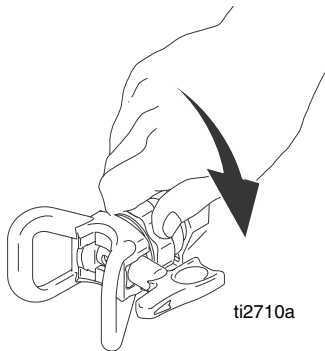

Spray

1. Spray test pattern. Increase pressure to eliminate heavy edges. Use smaller tip size if pressure adjustment can not eliminate heavy edges.

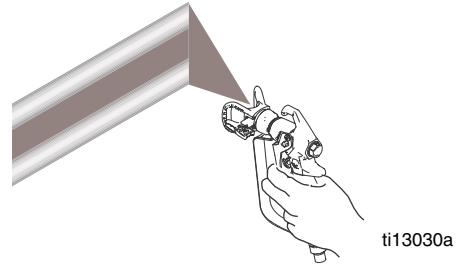

2. Hold gun perpendicular, 10-12 in. (25-30 cm) from surface. Spray back and forth. Overlap by 50%. Trigger gun after moving and release before stopping.

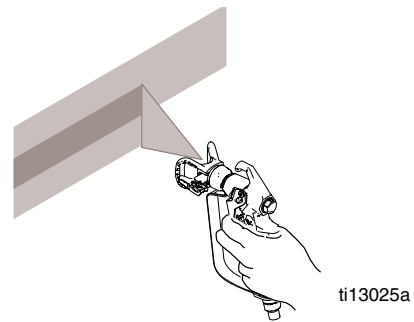

Clearing Tip Clog

1. Release trigger, put safety ON. Rotate SwitchTip. Take safety OFF. Trigger gun to clear clog. Never point gun at your hand or into a rag!

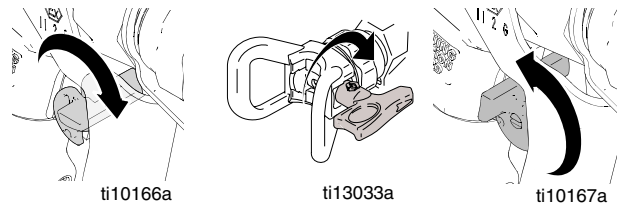

2. Put safety ON. Return SwitchTip to original position. Take safety OFF and continue spraying.

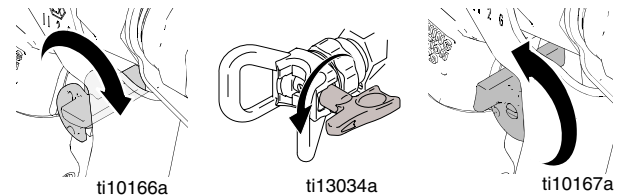

WatchDog™ Protection System (Not Available on All Units)

Pump stops automatically when material pail is empty.

To Activate:

1. Perform **Startup**.



ti7398a

2. Premium units with digital display:
Turn WatchDog switch ON and **WD ON** displays. **EMPTY** displays/flashes and pump stops when Watchdog protection system detects an empty material pail.



ti6224a

3. Turn WatchDog switch OFF. Add material or reprime sprayer. Turn pump switch OFF and ON to reset WatchDog protection system. Turn WatchDog switch back ON to continue to monitor material level.



ti7399a

ti7399a

Fast Flush

To flush the hose and gun at an accelerated speed, perform the following steps:

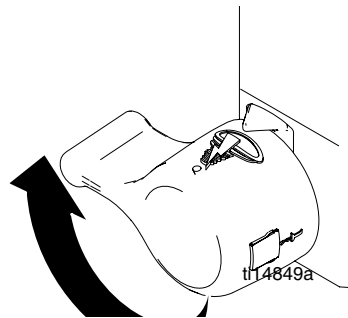

1. Perform steps 1 - 3 of **Cleanup**, page 16.
2. Hold gun trigger in and turn prime valve down to DRAIN position and then over to FAST FLUSH.



ti14849a

3. Continue flushing system until fluid appears clear.

Hose Reel (Not Available on All Units)

						
<p>Be sure to keep your head clear of hose reel while winding up hose.</p>						

1. Make sure hose is routed through hose guide.

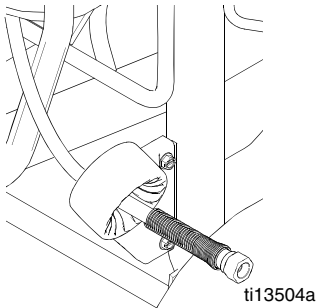

2. Lift and turn pivot lock 90° to unlock hose reel. Pull on hose to remove it from hose reel.

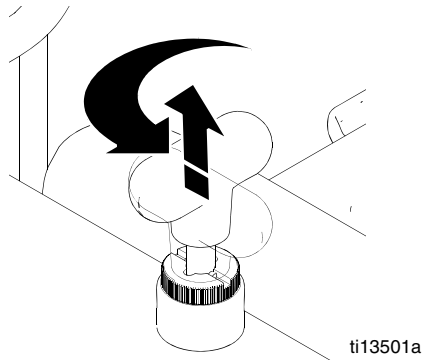

3. Pull reel handle up and turn clockwise to reel in hose.

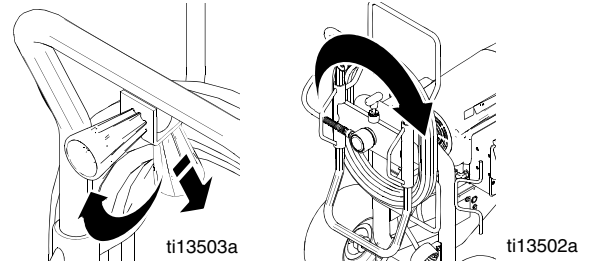

NOTE: The hose reel can be locked into two positions: Usage (A) and Storage (B).

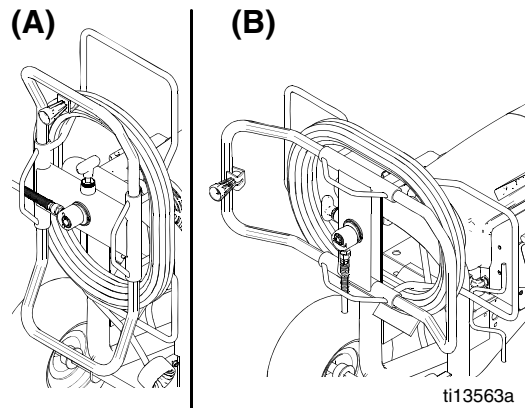

Digital Tracking System (Not Available on All Units)

Operation Main Menu

Short press to move to next display. Press and hold (5 seconds) to change units or reset data.

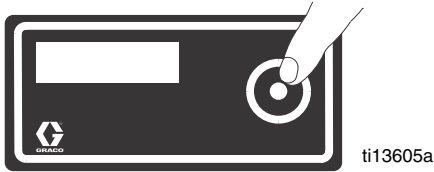

1. Turn pressure to lowest setting. Trigger gun to relieve pressure. Turn prime valve down to DRAIN position.

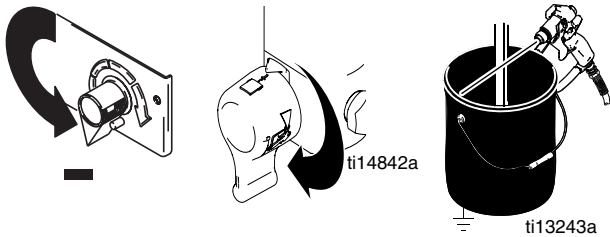

2. Turn power ON. Pressure display appears. Dashes will not appear unless pressure is less than 200 psi (14 bar, 1,4 MPa).

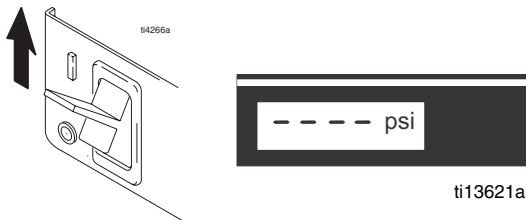

Change Display Units

Press and hold DTS button for 5 seconds to change pressure units (**psi**, **bar**, **MPa**) to desired units. Selection of bar or MPa changes **gallons** to **liters x 10**. To change display units DTS must be in pressure display mode and pressure must be at zero.

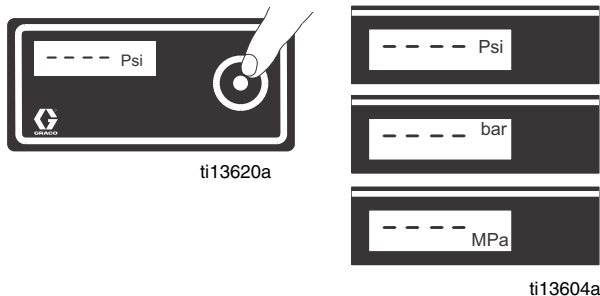

Job Gallons

1. Short press DTS button to move to Job Gallons (or liters x 10).

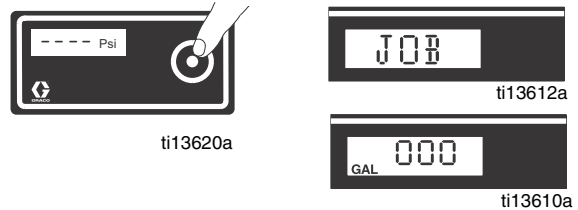

NOTE: **JOB** scrolls past, then the number of gallons sprayed above 1000 psi (70 bar, 7 MPa) displays.

2. Press and hold to reset to zero.

Lifetime Gallons

1. Short press DTS button to move to Lifetime Gallons (or liters x 10).

NOTE: **LIFE** scrolls briefly, then the number of gallons sprayed above 1000 psi (70 bar, 7 MPa) displays.

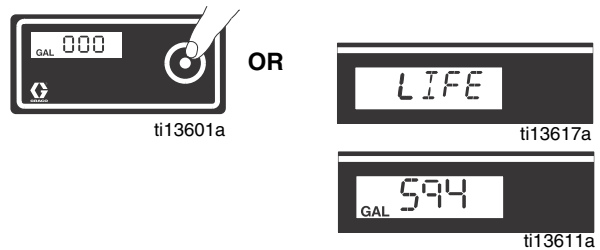

Secondary Menu - Stored Data and WatchDog Pump Protection Modes

1. Perform **Pressure Relief**, steps 1 - 4 if they have not already been done.
2. Turn power switch on while holding DTS button down.

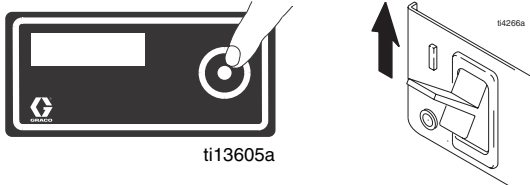

3. **SERIAL NUMBER** scrolls past and then serial number (e.g. 00001) displays.



4. Short press DTS button and **MOTOR HOURS** scrolls past and then total motor run hours are displayed.

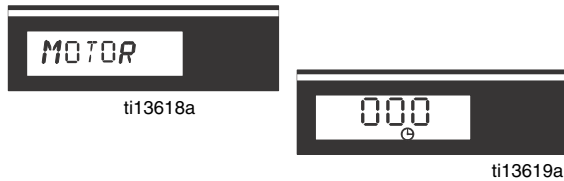

5. Short press DTS button. **LAST ERROR CODE** scrolls by and last error code is displayed; e.g. **E=07** (see Repair manual).



6. Press and hold DTS button to clear error code to zero.



7. Short press DTS button. **W-DOG** scrolls past then **OFF** displays if watchdog switch is OFF. **ON** displays if Watchdog switch is ON.

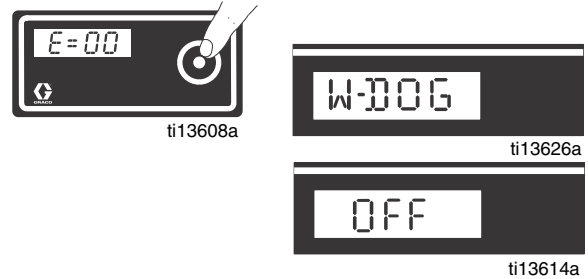

8. Press and hold (8 seconds) DTS button to move to WatchDog Trigger % menu. Continue to hold DTS button and Watchdog can be set to trigger at 30, 40, 50, or 60% of current sprayer pressure setting. Release DTS button when desired % is displayed. Default is 50%.

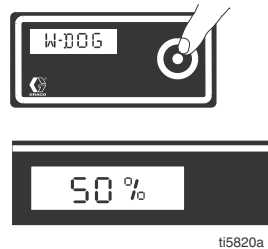

9. Short press to move to **SOFTWARE REV.**



10. Short press DTS button. **MOTOR ID RESISTOR** scrolls by and model code number (see below).

Code Number	Models
0	695
2	795 / MARK IV
4	1095 / 220V MARK V
6	1595 / 120V MARK V

Cleanup

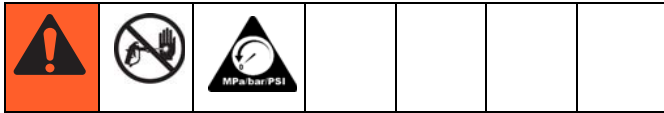

1. Perform **Pressure Relief Procedure** (page 8), steps 1 - 4. Remove siphon tube set from paint and place in flushing fluid. Remove tip guard from gun.

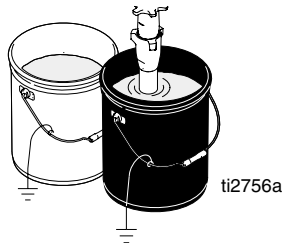

NOTE: Use water for water-base paint, mineral spirits for oil-base paint, or other solvents recommended by manufacturer.

2. Turn power **ON**. Turn prime valve forward to **SPRAY** position.

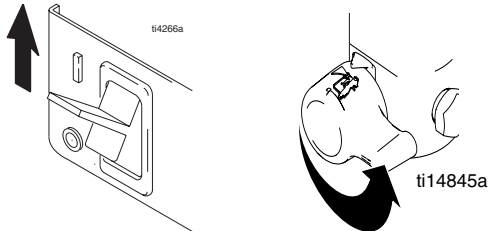

3. Increase pressure to 1/2. Hold gun against paint pail. Take trigger safety OFF. Trigger gun until flushing fluid appears.

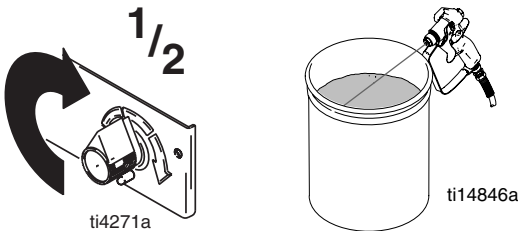

4. Move gun to waste pail, hold gun against pail, trigger gun to thoroughly flush system. Release trigger and put trigger safety ON.

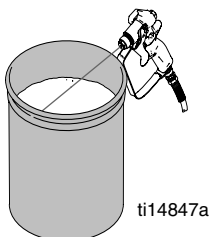

5. Turn prime valve down to **DRAIN** position and allow flushing fluid to circulate until flushing fluid appears clear.

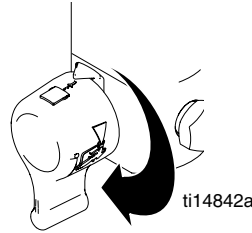

6. Turn prime valve forward to **SPRAY** position. Trigger gun into flushing pail to purge fluid from hose.

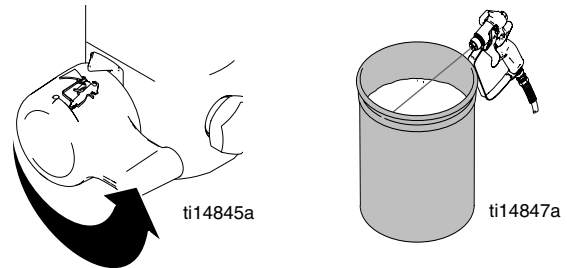

7. Raise siphon tube above flushing fluid and run sprayer for 15 to 30 seconds to drain fluid. Turn power **OFF**

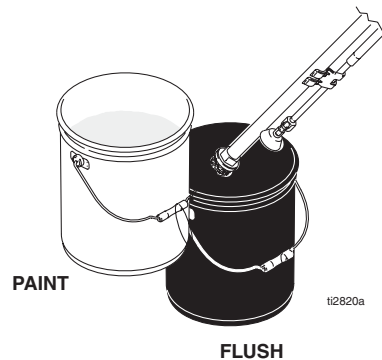

8. Turn prime valve down **DRAIN** position. Unplug sprayer.

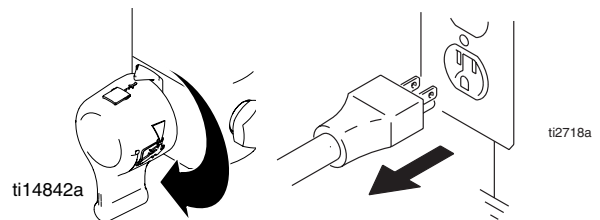

9. Remove filters from gun and sprayer, if installed. Clean and inspect. Install filters.

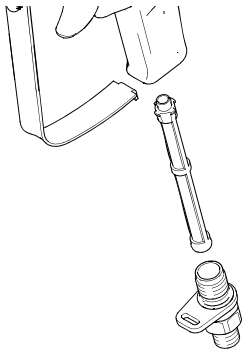

ti15018a

10. If flushing with water, flush again with mineral spirits, or Pump Armor, to leave a protective coating to prevent freezing or corrosion.

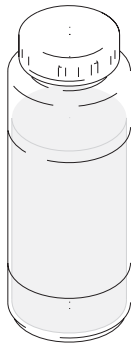

ti2895a

Pump Armor

11. Wipe sprayer, hose and gun with a rag soaked in water or mineral spirits.

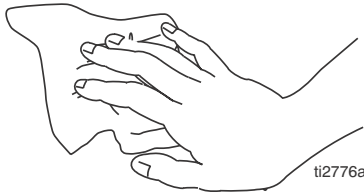

ti2776a

Technical Data

Model	100 - 120V, A, Hz	220 - 240V, A, Hz	Generator Minimum W	Motor HP (W)	Cycles per gallon (liter)	Maximum Delivery gpm (lpm)	Maximum Tip Size	Fluid Outlet npsm
695	14.8, 50/60	9, 50/60	5000	2.0 (1490)	226 (60)	0.95 (3.6)	0.031	1/4 in.
795	15, 50/60	10, 50/60	5000	2.2 (1640)	195 (52)	1.1 (4.2)	0.033	1/4 in.
Mark IV	15, 50/60	N/A	5000	2.2 (1640)	195 (52)	1.1 (4.2)	0.033	3/8 in.
1095	15, 50/60	10, 50/60	5000	2.4 (1790)	123 (33)	1.2 (4.5)	0.035	1/4 in.
Mark V	N/A	10, 50/60	5000	2.4 (1790)	110 (29)	1.3 (4.9)	0.037	3/8 in.
1595	20/15, 50/60	N/A	5000	2.8 (2090)	110 (29)	1.35 (5.1)	0.039	1/4 in.
Mark V	20/15, 50/60	N/A	5000	2.8 (2090)	110 (29)	1.35 (5.1)	0.039	3/8 in.

Basic Sprayer Wetted Parts.....
 zinc- and nickel-plated carbon steel, nylon, stainless
 steel, PTFE, Acetel, leather, UHMWPE, aluminum
 tungsten carbide, PEEK, brass

Noise Level
 Sound power91 dBa*
 Sound pressure82 dBa*
 *per ISO 3744; measured at 3.1 feet (1 m)

Dimensions

Model	Weight lb (kg)			Height in. (cm)			Length in. (cm)			Width in (cm)
	Lo-Boy	Hi-Boy	QuikReel	Lo-Boy	Hi-Boy	QuikReel	Lo-Boy	Hi-Boy	QuikReel	
695	94 (43)	94 (43)	111 (50)	27.5 (69.9)	28.5 (72.4) Handle down, 38.75 (98.4) Handle up	39 (99)	37 (94)	26 (66)	29.5 (75)	22.5 (57.2)
795	98 (45)	98 (45)	115 (52)	27.5 (69.9)	28.5 (72.4) Handle down, 38.75 (98.4) Handle up	39 (99)	37 (94)	26 (66)	29.5 (75)	22.5 (57.2)
Mark IV	N/A	N/A	119 (54)	N/A	N/A	39 (99)	N/A	N/A	29.5 (75)	22.5 (57.2)
1095	N/A	120 (55)	141 (64)	N/A	29.5 (74.9) Handle down, 38.5 (97.8) Handle up	39 (99)	N/A	26 (66)	28 (71)	24 (61)
1595	N/A	125 (57)	146 (66)	N/A	29.5 (74.9) Handle down, 38.5 (97.8) Handle up	39 (99)	N/A	26 (66)	28 (71)	22.5 (57.2)
Mark V	N/A	130 (59)	151 (68)	N/A	29.5 (74.9) Handle down, 38.5 (97.8) Handle up	39 (99)	N/A	26 (66)	28 (71)	24 (61)

Warranty

Graco warrants all equipment referenced in this document which is manufactured by Graco and bearing its name to be free from defects in material and workmanship on the date of sale to the original purchaser for use. With the exception of any special, extended, or limited warranty published by Graco, Graco will, for a period of twelve months from the date of sale, repair or replace any part of the equipment determined by Graco to be defective. This warranty applies only when the equipment is installed, operated and maintained in accordance with Graco's written recommendations.

This warranty does not cover, and Graco shall not be liable for general wear and tear, or any malfunction, damage or wear caused by faulty installation, misapplication, abrasion, corrosion, inadequate or improper maintenance, negligence, accident, tampering, or substitution of non-Graco component parts. Nor shall Graco be liable for malfunction, damage or wear caused by the incompatibility of Graco equipment with structures, accessories, equipment or materials not supplied by Graco, or the improper design, manufacture, installation, operation or maintenance of structures, accessories, equipment or materials not supplied by Graco.

This warranty is conditioned upon the prepaid return of the equipment claimed to be defective to an authorized Graco distributor for verification of the claimed defect. If the claimed defect is verified, Graco will repair or replace free of charge any defective parts. The equipment will be returned to the original purchaser transportation prepaid. If inspection of the equipment does not disclose any defect in material or workmanship, repairs will be made at a reasonable charge, which charges may include the costs of parts, labor, and transportation.

THIS WARRANTY IS EXCLUSIVE, AND IS IN LIEU OF ANY OTHER WARRANTIES, EXPRESS OR IMPLIED, INCLUDING BUT NOT LIMITED TO WARRANTY OF MERCHANTABILITY OR WARRANTY OF FITNESS FOR A PARTICULAR PURPOSE.

Graco's sole obligation and buyer's sole remedy for any breach of warranty shall be as set forth above. The buyer agrees that no other remedy (including, but not limited to, incidental or consequential damages for lost profits, lost sales, injury to person or property, or any other incidental or consequential loss) shall be available. Any action for breach of warranty must be brought within two (2) years of the date of sale.

GRACO MAKES NO WARRANTY, AND DISCLAIMS ALL IMPLIED WARRANTIES OF MERCHANTABILITY AND FITNESS FOR A PARTICULAR PURPOSE, IN CONNECTION WITH ACCESSORIES, EQUIPMENT, MATERIALS OR COMPONENTS SOLD BUT NOT MANUFACTURED BY GRACO. These items sold, but not manufactured by Graco (such as electric motors, switches, hose, etc.), are subject to the warranty, if any, of their manufacturer. Graco will provide purchaser with reasonable assistance in making any claim for breach of these warranties.

In no event will Graco be liable for indirect, incidental, special or consequential damages resulting from Graco supplying equipment hereunder, or the furnishing, performance, or use of any products or other goods sold hereto, whether due to a breach of contract, breach of warranty, the negligence of Graco, or otherwise.

FOR GRACO CANADA CUSTOMERS

The Parties acknowledge that they have required that the present document, as well as all documents, notices and legal proceedings entered into, given or instituted pursuant hereto or relating directly or indirectly hereto, be drawn up in English. Les parties reconnaissent avoir convenu que la rédaction du présente document sera en Anglais, ainsi que tous documents, avis et procédures judiciaires exécutés, donnés ou intentés, à la suite de ou en rapport, directement ou indirectement, avec les procédures concernées.

For the latest information about Graco products, visit www.graco.com.

TO PLACE AN ORDER, contact your Graco distributor or call 1-800-690-2894 to identify the nearest distributor.

*All written and visual data contained in this document reflects the latest product information available at the time of publication.
Graco reserves the right to make changes at any time without notice.*

This manual contains English. MM 3A0156

Graco Headquarters: Minneapolis
International Offices: Belgium, China, Japan, Korea

GRACO INC. P.O. BOX 1441 MINNEAPOLIS, MN 55440-1441

Copyright 2009, Graco Inc. is registered to ISO 9001

www.graco.com

2009
Download from Www.Somanuals.com. All Manuals Search And Download.

Free Manuals Download Website

<http://myh66.com>

<http://usermanuals.us>

<http://www.somanuals.com>

<http://www.4manuals.cc>

<http://www.manual-lib.com>

<http://www.404manual.com>

<http://www.luxmanual.com>

<http://aubethermostatmanual.com>

Golf course search by state

<http://golfingnear.com>

Email search by domain

<http://emailbydomain.com>

Auto manuals search

<http://auto.somanuals.com>

TV manuals search

<http://tv.somanuals.com>