



GMAX™ II 3900/5900/5900HD/5900 Convertible/7900 TexSpray 5900HD Convertible/7900HD Airless Sprayers

310892F

- For Portable Airless Spraying of Architectural Coatings and Paints -
3300 psi (22.8 MPa, 228 bar) Maximum Working Pressure



Read warnings and instructions

			
GMAX II 3900			
248683		✓	✓
248684	✓		✓
248685		✓	✓
248686	✓		✓
GMAX II 5900			
248687		✓	✓
248688	✓		✓
248689		✓	✓
248690	✓		✓
GMAX II 5900HD			
248699	✓		✓
GMAX II 5900 Convertible			
248691	✓		✓
248692	✓		✓
248693	✓		✓
248694	✓		✓
248695		✓	✓
248696		✓	✓
248697		✓	✓
248889	✓		✓
248890		✓	✓
GMAX II 7900			
248700		✓	✓
248701	✓		✓
248702		✓	✓
248703	✓		✓
TexSpray 5900 HD Convertible			
255630	✓		✓
255631	✓		✓
255954	✓		✓
TexSpray 7900 HD			
255632	✓		✓

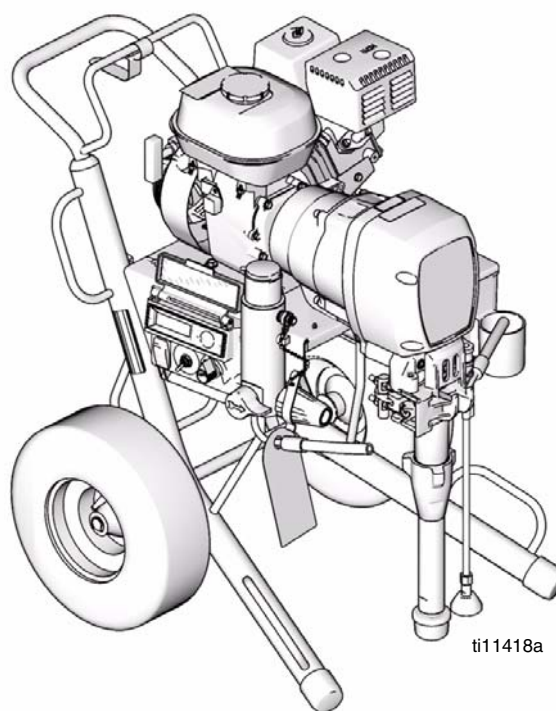

310893
311046



311861



310894





309640



PROVEN QUALITY. LEADING TECHNOLOGY.

Manual Conventions

	WARNING
	Hazard Symbol
<p>WARNING: a potentially hazardous situation which, if not avoided, could result in death or serious injury.</p> <p>Warnings in the instructions usually include a symbol indicating the hazard. Read the general Warnings section for additional safety information.</p>	







CAUTION
<p>CAUTION: a potentially hazardous situation which, if not avoided, may result in property damage or destruction of equipment.</p>







Note

 Additional helpful information.

Warning

The following warnings include general safety information for this equipment. Further product specific warnings may be included in the text where applicable.

 WARNING	
	<p>FIRE AND EXPLOSION HAZARD</p> <p>Flammable fumes, such as solvent and paint fumes, in work area can ignite or explode. To help prevent fire and explosion:</p> <ul style="list-style-type: none"> • Use equipment only in well ventilated area. • Do not fill fuel tank while engine is running or hot; shut off engine and let it cool. Fuel is flammable and can ignite or explode if spilled on hot surface. • When flammable liquid is sprayed or used for flushing or cleaning, keep sprayer at least 20 feet (6 m) away from explosive vapors. • Eliminate all ignition sources; such as pilot lights, cigarettes, portable electric lamps, and plastic drop cloths (potential static arc). • Keep work area free of debris, including solvent, rags and gasoline. • Do not plug or unplug power cords, or turn power or light switches on or off when flammable fumes are present. • Ground equipment and conductive objects in work area. See Grounding instructions. • Use only grounded hoses. • Hold gun firmly to side of grounded pail when triggering into pail. • If there is static sparking or you feel a shock, stop operation immediately. Do not use equipment until you identify and correct the problem.
	<p>INJECTION HAZARD</p> <p>High-pressure fluid from gun, hose leaks, or ruptured components will pierce skin. This may look like just a cut, but it is a serious injury that can result in amputation. Get immediate surgical treatment.</p> <ul style="list-style-type: none"> • Do not point gun at anyone or at any part of the body. • Do not put your hand over the spray tip. • Do not stop or deflect leaks with your hand, body, glove, or rag. • Do not spray without tip guard and trigger guard installed. • Engage trigger lock when not spraying. • Follow Pressure Relief Procedure in this manual, when you stop spraying and before cleaning, checking, or servicing equipment.
	<p>PRESSURIZED EQUIPMENT HAZARD</p> <p>Fluid from the gun/dispense valve, leaks, or ruptured components can splash in the eyes or on skin and cause serious injury.</p> <ul style="list-style-type: none"> • Follow Pressure Relief Procedure in this manual, when you stop spraying and before cleaning, checking, or servicing equipment. • Tighten all fluid connections before operating the equipment. • Check hoses, tubes, and couplings daily. Replace worn or damaged parts immediately.
	<p>ELECTRIC SHOCK HAZARD</p> <p>Improper grounding, setup, or usage of the system can cause electric shock.</p> <ul style="list-style-type: none"> • Turn off and disconnect power cord before servicing equipment. • Use only grounded electrical outlets. • Use only 3-wire extension cords. • Ensure ground prongs are intact on sprayer and extension cords.
	<p>MOVING PARTS HAZARD</p> <p>Moving parts can pinch or amputate fingers and other body parts.</p> <ul style="list-style-type: none"> • Keep clear of moving parts. • Do not operate equipment with protective guards or covers removed. • Pressurized equipment can start without warning. Before checking, moving, or servicing equipment, follow the Pressure Relief Procedure in this manual. Disconnect power or air supply.

 WARNING	
	<p>EQUIPMENT MISUSE HAZARD</p> <p>Misuse can cause death or serious injury.</p> <ul style="list-style-type: none"> • Do not exceed the maximum working pressure or temperature rating of the lowest rated system component. See Technical Data in all equipment manuals. • Use fluids and solvents that are compatible with equipment wetted parts. See Technical Data in all equipment manuals. Read fluid and solvent manufacturer's warnings. • Check equipment daily. Repair or replace worn or damaged parts immediately. • Do not alter or modify equipment. • For professional use only. • Use equipment only for its intended purpose. Call your Graco distributor for information. • Route hoses and cables away from traffic areas, sharp edges, moving parts, and hot surfaces. • Do not use hoses to pull equipment. • Comply with all applicable safety regulations.
	<p>PRESSURIZED ALUMINUM PARTS HAZARD</p> <p>Do not use 1,1,1-trichloroethane, methylene chloride, other halogenated hydrocarbon solvents or fluids containing such solvents in pressurized aluminum equipment. Such use can cause serious chemical reaction and equipment rupture, and result in death, serious injury, and property damage.</p>
	<p>SUCTION HAZARD</p> <p>Never place hands near the pump fluid inlet when pump is operating or pressurized. Powerful suction could cause serious injury.</p>
	<p>CARBON MONOXIDE HAZARD</p> <p>Exhaust contains poisonous carbon monoxide, which is colorless and odorless. Breathing carbon monoxide can cause death. Do not operate in an enclosed area.</p>
	<p>TOXIC FLUID OR FUMES HAZARD</p> <p>Toxic fluids or fumes can cause serious injury or death if splashed in the eyes or on skin, inhaled, or swallowed.</p> <ul style="list-style-type: none"> • Read MSDS's to know the specific hazards of the fluids you are using. • Store hazardous fluid in approved containers, and dispose of it according to applicable guidelines.
	<p>BURN HAZARD</p> <p>Equipment surfaces and fluid that's heated can become very hot during operation. To avoid severe burns, do not touch hot fluid or equipment. Wait until equipment/fluid has cooled completely.</p>
	<p>PERSONAL PROTECTIVE EQUIPMENT</p> <p>You must wear appropriate protective equipment when operating, servicing, or when in the operating area of the equipment to help protect you from serious injury, including eye injury, inhalation of toxic fumes, burns, and hearing loss. This equipment includes but is not limited to:</p> <ul style="list-style-type: none"> • Protective eyewear • Clothing and respirator as recommended by the fluid and solvent manufacturer • Gloves • Hearing protection
	<p>RECOIL HAZARD</p> <p>Brace yourself; gun may recoil when triggered and cause you to fall, which could cause serious injury.</p>

Component Identification

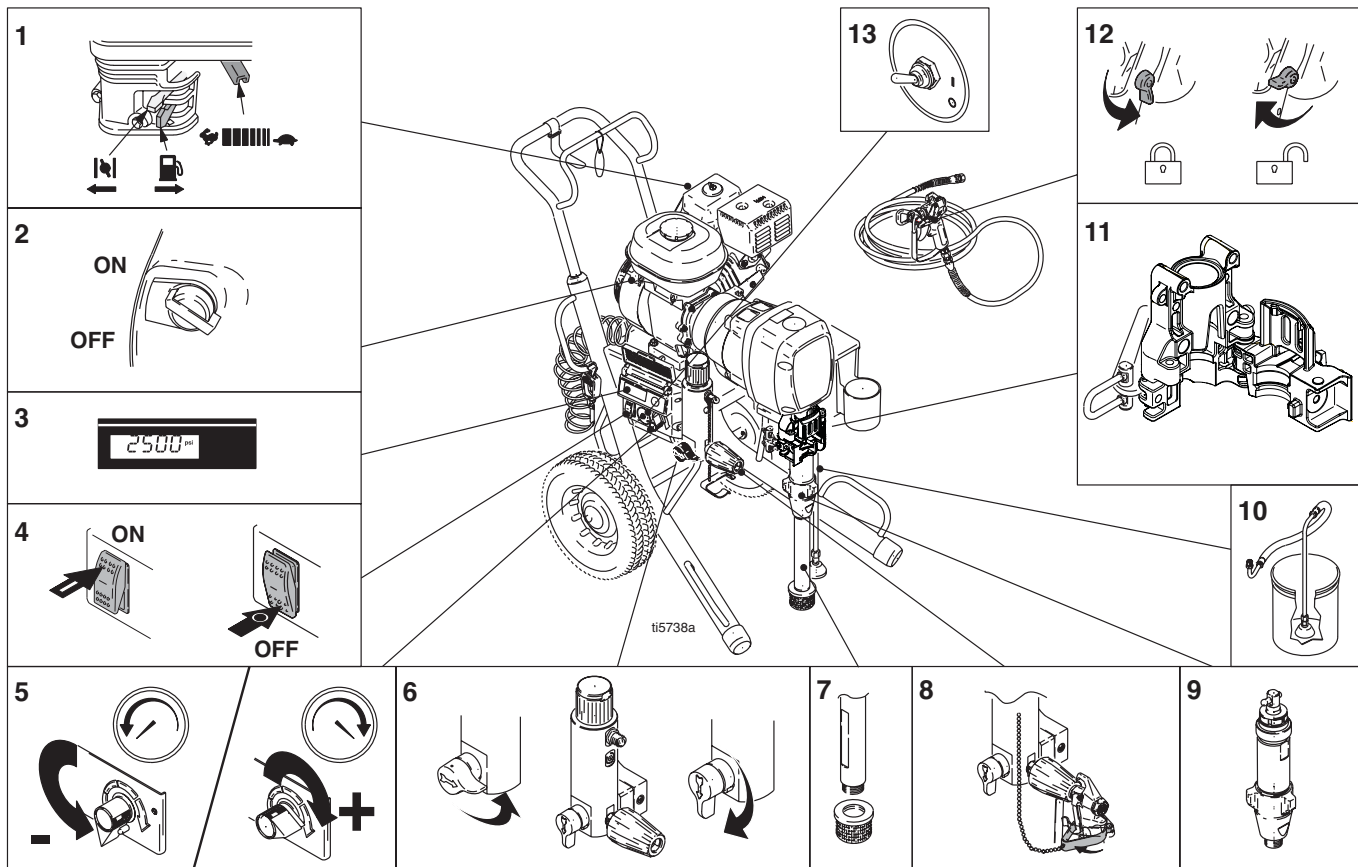

1	Engine controls
2	Engine ON/OFF switch
3	Premium Digital Display
4	Pump On/Off Switch
5	Pressure control
6	Prime valve & Filter
7	Suction tube & Inlet Filter
8	Premium AutoClean ₂ [™] (not available on all models)
9	Pump
10	Drain hose
11	ProConnect [™]
12	Trigger Lock
13	WatchDog [™] switch

Setup

<p>1. Connect appropriate Graco high-pressure hose to sprayer. Tighten securely.</p>	<p>2. Install adapter and 3.6m whip hose to other end of 15m airless hose.</p>	<p>3. Install whip hose to fluid inlet of spray gun.</p>	<p>4. Tighten securely.</p>	<p>5. Remove tip guard.</p>

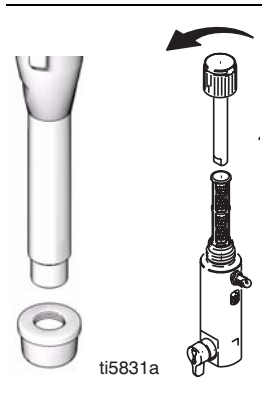
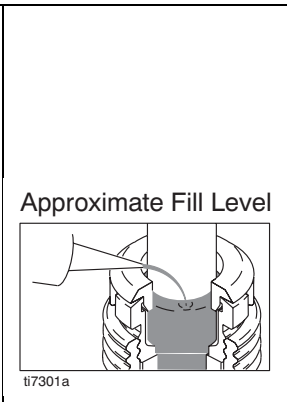
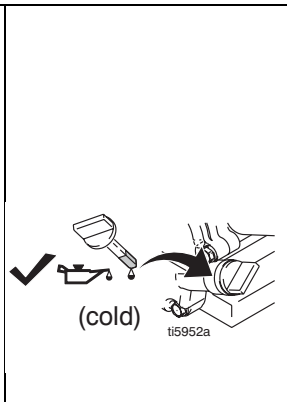
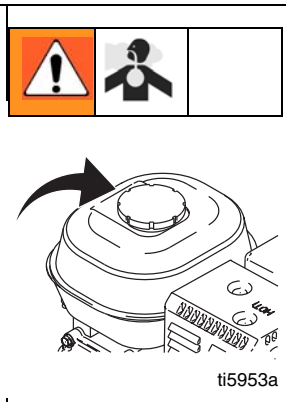
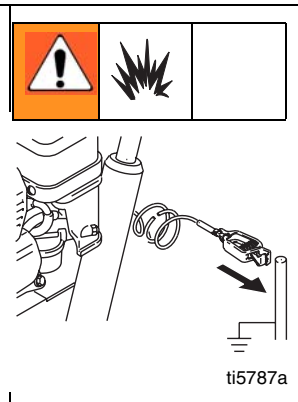
 <p>ti5831a</p>	<p>Approximate Fill Level</p>  <p>ti7301a</p>	 <p>(cold) ti5952a</p>	 <p>ti5953a</p>	 <p>ti5787a</p>
<p>6. Remove inlet strainer and filter bowl screen when spraying plaster materials.</p>	<p>7. Fill throat packing nut with TSL to prevent premature packing wear. Do this each time you spray.</p>	<p>8. Check engine oil level. Add SAE 10W-30 (summer) or 5W-20 (winter), if necessary.</p>	<p>9. Fill fuel tank.</p>	<p>10. Attach sprayer grounding clamp to earth ground.</p>

Convertible Models

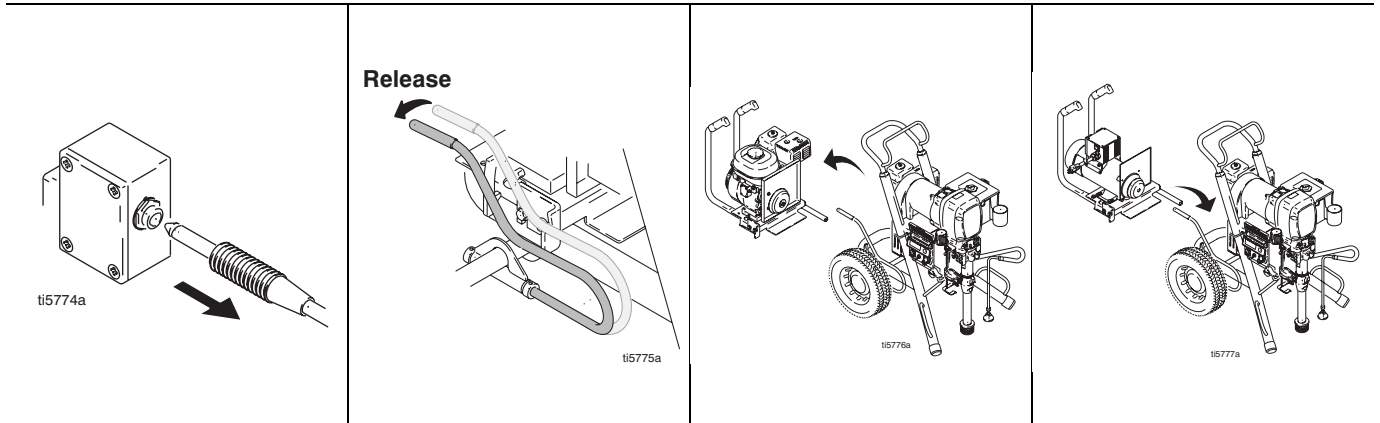

Change Engine to Motor

- | | | | |
|----------------------------------|-------------------------|--|---|
| 1. Disconnect engine power cord. | 2. Release tension bar. | 3. Remove engine; tilt and slide back. | 4. Install motor; drop in and push forward. |
|----------------------------------|-------------------------|--|---|

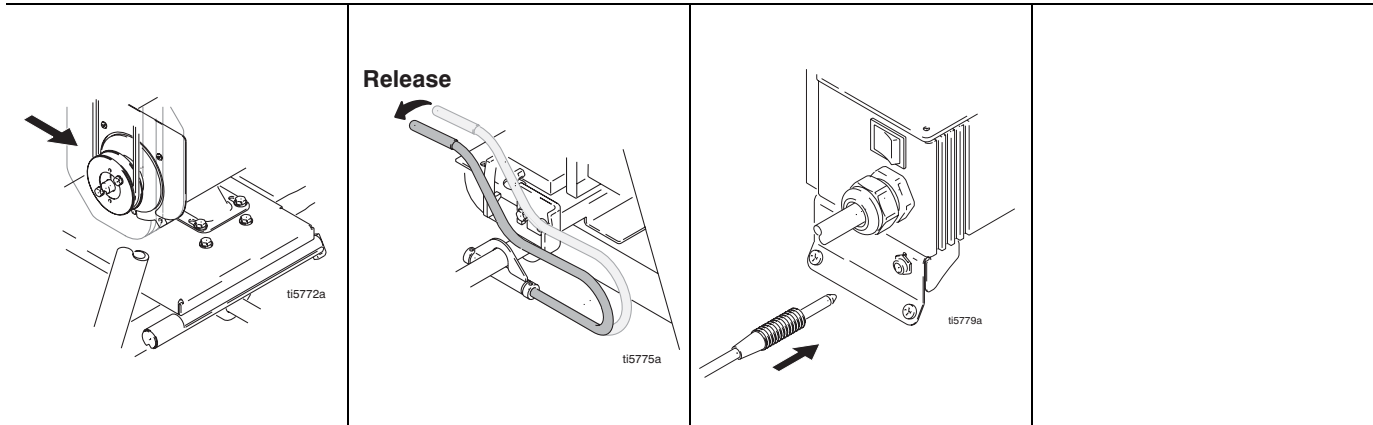

Convertible Models



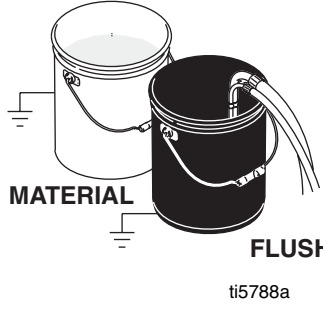
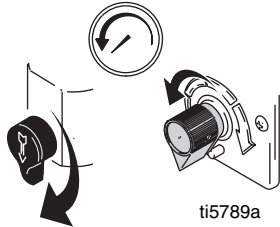

Change Motor to Engine

1. Look through side vent holes and ensure drive belt is in motor pulley.	2. Secure motor with tension bar.	3. Plug in pressure control power cord.	
---	-----------------------------------	---	--



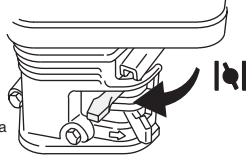
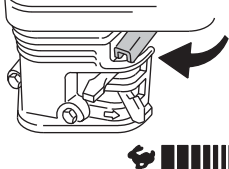

Startup

 <p>MATERIAL</p> <p>FLUSH</p> <p>ti5788a</p>	 <p>ti5789a</p>	 <p>OFF</p> <p>ti5790a</p>	
<p>1. Place suction tube and drain tube in grounded metal pail partially filled with flushing fluid. Attach ground wire to pail and to earth ground.</p>	<p>2. Turn prime valve down. Turn pressure control counterclockwise to lowest pressure.</p>	<p>3. Set pump switch OFF.</p>	

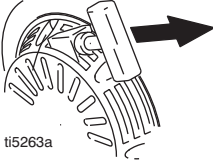
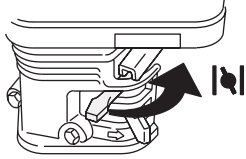
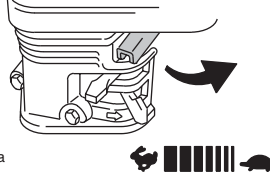
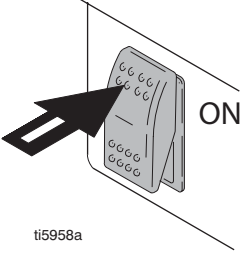

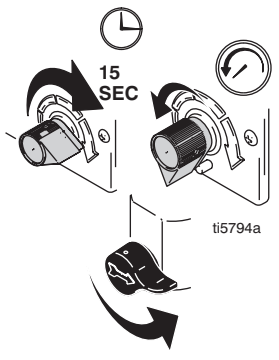

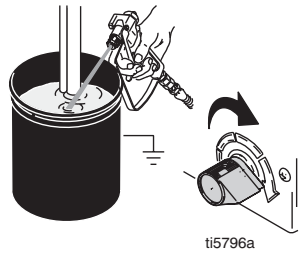

 <p>ti5248a</p>	 <p>ti5249a</p>	 <p>ti5250a</p>	 <p>ti5262a</p>
<p>4. Start engine</p> <p>a Move fuel valve to open.</p>	<p>b Move choke to closed.</p>	<p>c Set throttle to fast.</p>	<p>d Set engine switch to ON.</p>

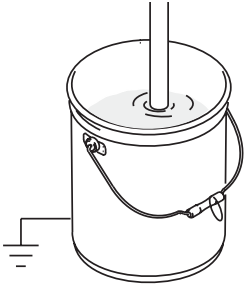
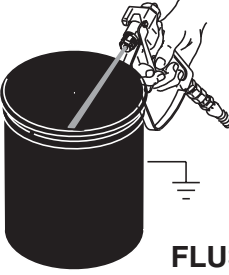
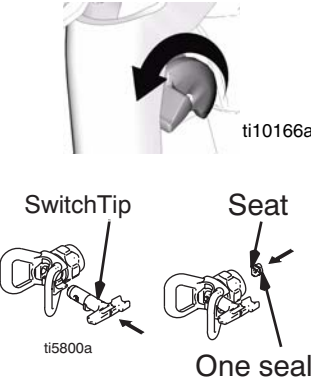
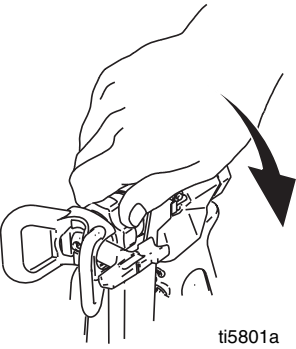
Startup

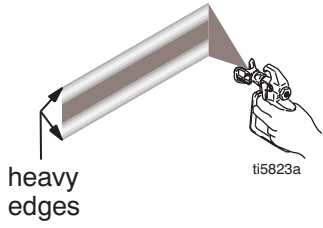
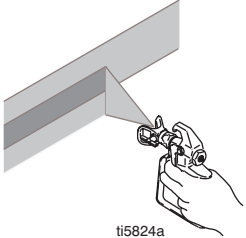

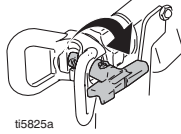
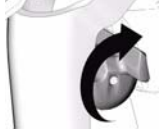
 <p>ti5263a</p>	 <p>ti5264a</p>	 <p>ti5251a</p>	 <p>ti5958a</p>
<p>e Pull starter rope.</p>	<p>f After engine starts, move choke to open.</p>	<p>g Set throttle to desired setting.</p>	<p>5. Set pump switch ON. - Pump/clutch is now active -</p>

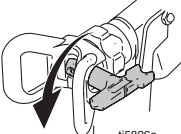
			
<p>6. Increase pressure enough to start pump stroking and allow fluid to circulate for 15 seconds; turn pressure down and turn prime valve horizontal.</p>	<p>7. Take spray gun trigger safety OFF.</p>	<p>8. Hold gun against grounded metal flushing pail. Trigger gun and increase fluid pressure slowly until pump runs smoothly.</p>	<p>Inspect fittings for leaks. Do not stop leaks with your hand or a rag! If leaks occur, turn sprayer OFF immediately. Perform Pressure Relief steps 1 - 3 on page 23. Tighten leaky fittings. Repeat Start Up procedure steps 1 - 5. If no leaks, continue to trigger gun until system is thoroughly flushed. Proceed to step 6.</p>

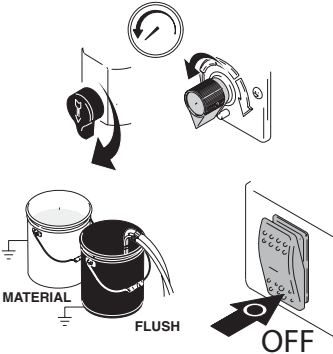

 <p>MATERIAL ti5797a</p>	 <p>FLUSH ti5798a</p>	 <p>ti10166a SwitchTip Seat ti5800a One seal</p>	 <p>ti5801a</p>
SwitchTip and Guard Assembly			
<p>9. Place siphon tube in material pail.</p>	<p>10. Trigger gun again into flushing fluid pail until material appears. Assemble tip and guard, page 14.</p>	<p>1. Put trigger safety ON. Insert SwitchTip. Insert seat and OneSeal™.</p>	<p>2. Screw assembly onto gun. Hand tighten.</p>

 <p>heavy edges</p> <p>ti5823a</p>	 <p>ti5824a</p>	 <p>ti10166a</p>  <p>ti5825a</p>  <p>ti10167a</p>	 <p>ti10166a</p>  <p>ti5826a</p>  <p>ti10167a</p>
Clearing Tip Clogs			
<ol style="list-style-type: none"> 1. Trigger gun and spray test pattern. Slowly adjust pressure to eliminate heavy edges. Use smaller tip size if pressure adjustment can not eliminate heavy edges. 	<ol style="list-style-type: none"> 2. Hold gun perpendicular, 10-12 in. (25-30 cm) from surface. Spray back and forth. Use strokes overlapped by 50%. Start gun movement before triggering gun and release trigger before stopping gun movement. 	<ol style="list-style-type: none"> 1. Release trigger, put trigger safety ON. Rotate SwitchTip. Take trigger safety OFF and trigger gun to clear the clog. 	<ol style="list-style-type: none"> 2. Put trigger safety ON, return SwitchTip to original position, take trigger safety OFF and continue spraying.

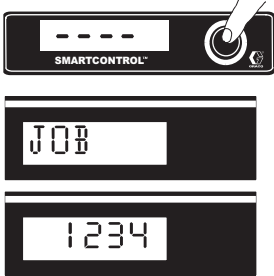
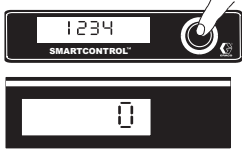
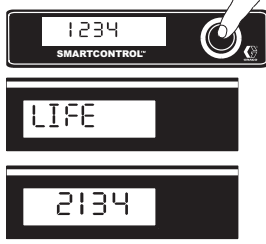

Premium Operation

 <p>ti5802a</p>	 <p>MATERIAL FLUSH OFF</p>	 <p>ti5804a</p>	
<p>Main Menu</p> <p>Close cover when spraying to protect display.</p>	<p>1. Do startup steps 1. - 3.</p>	<p>2. Start engine, page 11. Sprayer Model momentarily displays, e.g., G5900 = GMAX 5900 Pressure display appears. Dashes appear when pressure is less than 200 psi (14 bar, 1.4 MPa).</p>	<p>Note: Information other than pressure can not be accessed if system pressure is greater than 200 psi (14 bar, 1.4 MPa) or if the pump switch is ON.</p>

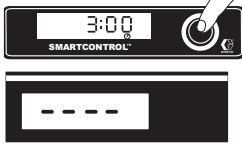
Digital Tracking System™ (DTS)

 <p style="text-align: center;">ti5805a</p>	 <p style="text-align: center;">ti5806a</p>	 <p style="text-align: center;">ti6206a</p>	 <p style="text-align: center;">ti5807a</p>	 <p style="text-align: center;">ti5808a</p>
<p>3. Short press DTS button to move to Job Gallons (or Liters x 10).</p> <p>Note: JOB displays briefly, then the number of gallons sprayed above 800 psi (55 bar, 5.5 MPa).</p>	<p>4. Press and hold to reset to zero, or short press DTS button to move to Life-time Gallons (or Liters x 10).</p>	<p>Note: LIFE displays briefly, then the number of gallons sprayed above 800 psi (55 bar, 5.5 MPa).</p>	<p>5. Short press DTS button to move to AutoClean2 Timer operation (Manual 309955).</p> <p>Note: If the pump is started in the timer mode, the timer counts down to zero and shuts the pump OFF. Use for flushing only.</p>	<p>6. Short press DTS button to return to Pressure.</p>

WatchDog™ Protection System

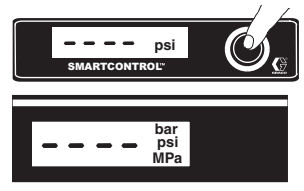
 <p>ti6207a</p>	 <p>ti6224a</p>	 <p>ti6208a</p>	 <p>ti6225a</p>
<p>Pump stops automatically when material pail is empty.</p>		<p>Change Display Units:</p>	
<p>To Activate: 1. Do Startup.</p>	<p>2. Turn WatchDog switch ON and WD ON displays.</p> <p>EMPTY displays / flashes and the pump stops when WatchDog protection system detects an empty material pail.</p>	<p>3. Turn WatchDog switch OFF. Add material or reprime sprayer. Turn pump switch OFF and ON to reset WatchDog protection system. Turn WatchDog switch back ON to continue to monitor material level.</p>	<p>Pressure/Volume: Press and hold (8 seconds) DTS button to change pressure units (psi, bar, MPa), to desired units. Volume units (GAL, LTRx10) follow pressure units; i.e., psi/GAL and bar or MPa/LTRx10.</p> <p>Continue to press DTS button to cycle from psi to bar to MPa. Release DTS button to select units.</p>

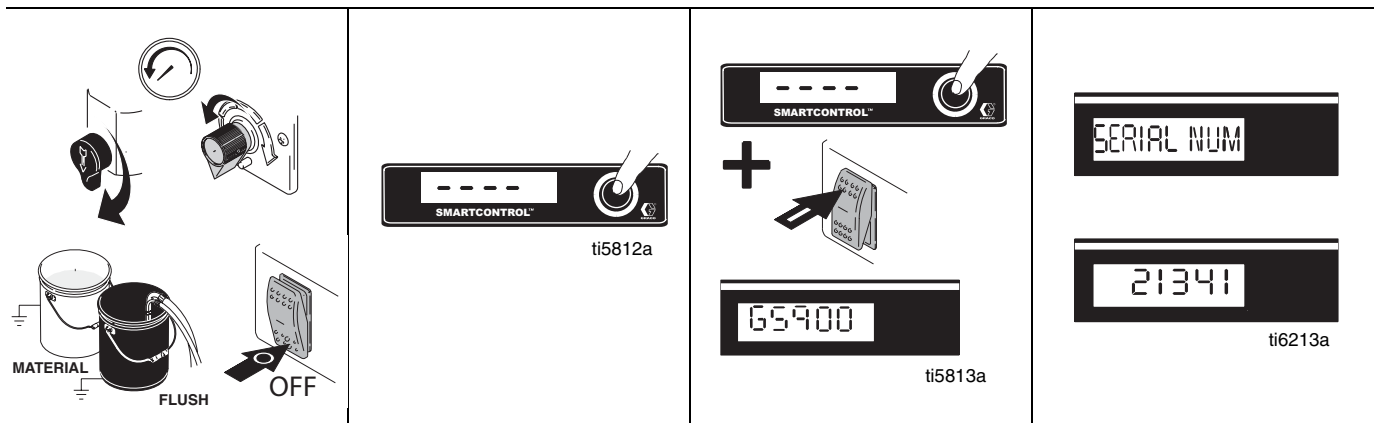

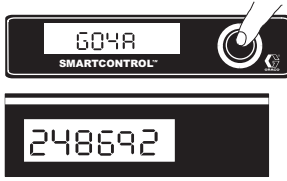
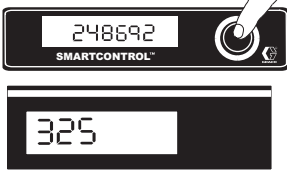
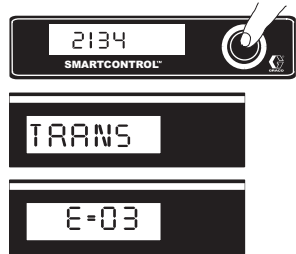

Secondary Menu - Stored Data and WatchDog Pump Protection Modes

<p>1. Do Startup steps 1. - 3. Pressure must be at zero.</p>	<p>2. Start engine, page 11. Pressure display appears.</p>	<p>3. Press and hold DTS button and turn pump switch ON.</p> <p>Sprayer model momentarily displays, e.g., G5900 = GMAX II 5900.</p>	<p>SERIAL NUM scrolls through display and a 3 to 5-digit serial number displays.</p>
---	--	--	--

 <p>ti6215a</p>	 <p>ti6216a</p>	 <p>ti6217a</p>	 <p>ti6220a</p>
--	--	---	--

Secondary Menu - Stored Data and WatchDog Pump Protection Modes

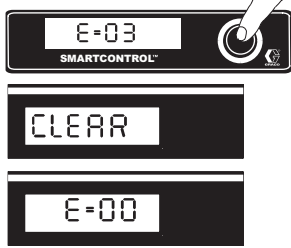
<p>4. Short press DTS button and date code displays.</p>	<p>5. Short press DTS button and part number displays.</p>	<p>6. Short press DTS button and engine hours displays.</p>	<p>7. Short press DTS button and LAST ERROR scrolls through display followed by stored error message and error code. This information cycles repeatedly until cleared. See manual 310893 for error code explanations.</p>
--	--	---	---

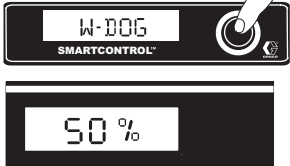
 <p>ti6218a</p>	 <p>ti5819a</p>	 <p>ti6221a</p>	 <p>ti5820a</p>
--	--	---	--

Secondary Menu - Stored Data and WatchDog Pump Protection Modes

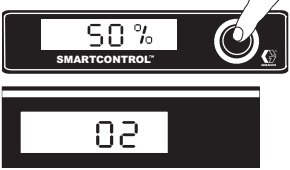
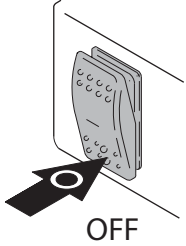

<p>8. Press and hold DTS button until CLEAR ERROR NO ERROR CODE scrolls through the display and then error code E=00 displays. See Manual 310893.</p>	<p>9. Short press DTS button again to move to WatchDog mode. You may now short press and do step 10 or long press do step 11.</p>	<p>10. Short press DTS button again and SOFTWARE REV scrolls through display followed by revision level; e.g., 02.</p>	<p>11. Press and hold (8 seconds) DTS button to move to WatchDog Trigger % menu. Continue to hold DTS button and WatchDog can be set to trigger at 30, 40, 50 or 60% of current sprayer pressure setting. Release DTS button when desired % is displayed. Default is 50%.</p>
---	--	--	---

 <p>ti6219a</p>	 <p>ti5822a</p>		
Secondary Menu - Stored Data and WatchDog Pump Protection Modes			
12. Short press DTS button and software revision displays.	13. Short press to return to step 3. Turn pump switch OFF at any time to exit stored data mode.		

Cleanup

<p>ti10116a</p> <p>ti5822a</p> <p>OFF</p> <p>ti5827b</p> <p>OFF</p>	<p>ti10117a</p> <p>ti5828a</p> <p>PAINT</p>	<p>ti10116a</p> <p>ti5829a</p>	<p>ti5830a</p>
<p>Pressure Relief Procedure</p>			
<p>1. Lock gun trigger safety. Set pump switch OFF. Turn engine OFF.</p>	<p>2. Unlock gun trigger safety. Turn pressure to lowest setting. Trigger gun into pail to relieve pressure.</p>	<p>3. Lock gun trigger safety. Turn prime valve down.</p>	<p>4. Remove guard and SwitchTip.</p>

If you suspect spray tip or hose is clogged or that pressure has not been fully relieved after following the steps above, VERY SLOWLY loosen tip guard retaining nut or hose end coupling to relieve pressure gradually, then loosen completely. Clear hose or tip obstruction.

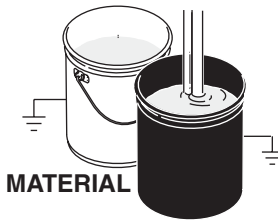
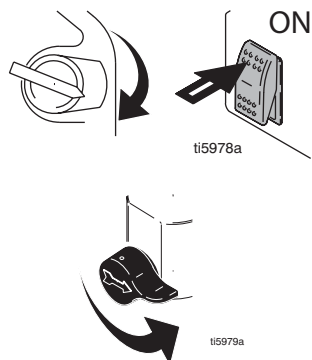
 <p>ti5831a</p>	 <p>ti5832a FLUSH</p>	 <p>MATERIAL FLUSH</p> <p>ti5833a</p>	 <p>ti5978a ON</p> <p>ti5979a</p>
<p>5. Unscrew bowl, remove filter. Assemble without filter. Clean filter.</p>	<p>6. Clean filter, guard and SwitchTip in flushing fluid.</p>	<p>7. Remove siphon tube set from material and place in flushing fluid.</p> <p>Use water for water base material and appropriate solvent for oil base material.</p>	<p>8. Turn engine ON and start engine.</p> <p>Set pump switch ON.</p> <p>Turn prime valve horizontal.</p>

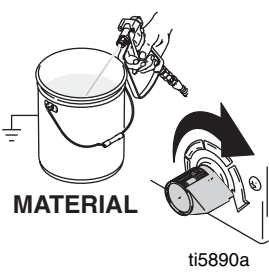
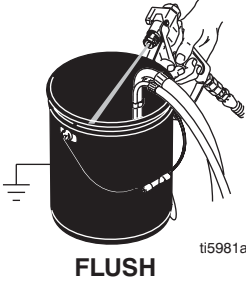
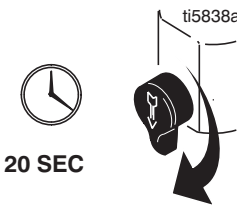
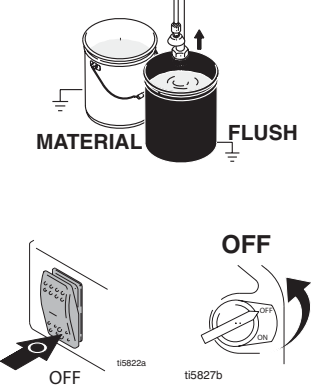
 <p>MATERIAL</p> <p>ti5890a</p>	 <p>FLUSH</p> <p>ti5981a</p>	 <p>20 SEC</p> <p>ti5838a</p>	 <p>MATERIAL FLUSH</p> <p>OFF</p> <p>ti5822a ti5827b</p>
<p>9. Hold gun against material pail. Take trigger safety OFF. Turn pressure control up until motor begins to drive pump. Trigger gun until flushing fluid appears.</p>	<p>10. Move gun to flushing pail, hold gun against pail, trigger gun to thoroughly flush system. Release trigger and put trigger safety ON.</p>	<p>11. Turn prime valve down and allow flushing fluid to circulate for approximately 20 seconds to clean drain tube.</p>	<p>12. Raise siphon tube above flushing fluid and run sprayer for 15 to 30 seconds to drain fluid. Turn pump switch OFF. Turn engine OFF.</p>

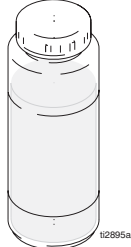
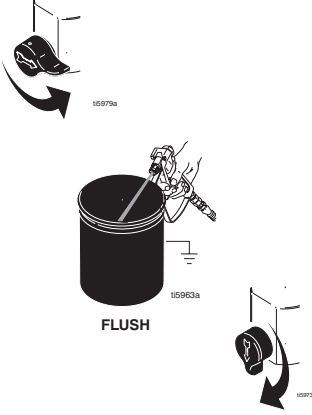
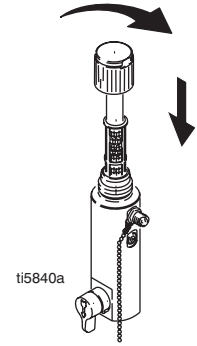
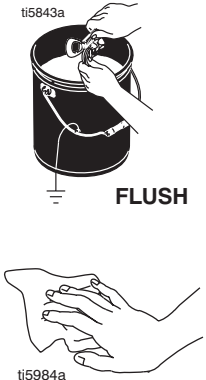
  <p>Pump Armor</p> <p>ti2895a</p>	 <p>ti5975a</p> <p>ti5963a</p> <p>ti5975a</p> <p>FLUSH</p>	 <p>ti5840a</p>	 <p>ti5843a</p> <p>FLUSH</p> <p>ti5984a</p>
<p>Caution: If flushing with water, do not leave water in sprayer. Flush again with mineral spirits, oil or Pump Armor and leave this protective coating in the sprayer to help prevent freezing or corrosion and increase sprayer life.</p>	<p>13. Close prime valve. Trigger gun into flushing pail to purge fluid from hose. Open prime valve.</p>	<p>14. Install filter into filter bowl. Make sure plastic center tube is tightened securely. Hand tighten filter bowl. Hand tighten gun handle.</p>	<p>15. Clean tip, guard and gasket with a soft bristle brush to prevent part failure due to dried materials. Assemble parts and attach loosely onto gun.</p> <p>Wipe sprayer, hose and gun with a rag soaked in water or mineral spirits.</p>

Warranty / Garantie / Garantía / Garanzia / Garantia

Graco warrants all equipment referenced in this document which is manufactured by Graco and bearing its name to be free from defects in material and workmanship on the date of sale to the original purchaser for use. With the exception of any special, extended, or limited warranty published by Graco, Graco will, for a period of twelve months from the date of sale, repair or replace any part of the equipment determined by Graco to be defective. This warranty applies only when the equipment is installed, operated and maintained in accordance with Graco's written recommendations.

This warranty does not cover, and Graco shall not be liable for general wear and tear, or any malfunction, damage or wear caused by faulty installation, misapplication, abrasion, corrosion, inadequate or improper maintenance, negligence, accident, tampering, or substitution of non-Graco component parts. Nor shall Graco be liable for malfunction, damage or wear caused by the incompatibility of Graco equipment with structures, accessories, equipment or materials not supplied by Graco, or the improper design, manufacture, installation, operation or maintenance of structures, accessories, equipment or materials not supplied by Graco.

This warranty is conditioned upon the prepaid return of the equipment claimed to be defective to an authorized Graco distributor for verification of the claimed defect. If the claimed defect is verified, Graco will repair or replace free of charge any defective parts. The equipment will be returned to the original purchaser transportation prepaid. If inspection of the equipment does not disclose any defect in material or workmanship, repairs will be made at a reasonable charge, which charges may include the costs of parts, labor, and transportation.

THIS WARRANTY IS EXCLUSIVE, AND IS IN LIEU OF ANY OTHER WARRANTIES, EXPRESS OR IMPLIED, INCLUDING BUT NOT LIMITED TO WARRANTY OF MERCHANTABILITY OR WARRANTY OF FITNESS FOR A PARTICULAR PURPOSE.

Graco's sole obligation and buyer's sole remedy for any breach of warranty shall be as set forth above. The buyer agrees that no other remedy (including, but not limited to, incidental or consequential damages for lost profits, lost sales, injury to person or property, or any other incidental or consequential loss) shall be available. Any action for breach of warranty must be brought within two (2) years of the date of sale.

GRACO MAKES NO WARRANTY, AND DISCLAIMS ALL IMPLIED WARRANTIES OF MERCHANTABILITY AND FITNESS FOR A PARTICULAR PURPOSE, IN CONNECTION WITH ACCESSORIES, EQUIPMENT, MATERIALS OR COMPONENTS SOLD BUT NOT MANUFACTURED BY GRACO. These items sold, but not manufactured by Graco (such as electric motors, switches, hose, etc.), are subject to the warranty, if any, of their manufacturer. Graco will provide purchaser with reasonable assistance in making any claim for breach of these warranties.

In no event will Graco be liable for indirect, incidental, special or consequential damages resulting from Graco supplying equipment hereunder, or the furnishing, performance, or use of any products or other goods sold hereto, whether due to a breach of contract, breach of warranty, the negligence of Graco, or otherwise.

POUR LES CLIENTS DE GRACO PARLANT FRANCAIS

Les parties reconnaissent avoir convenu que la rédaction du présent document ainsi que de tous les documents, avis et procédures judiciaires exécutés, donnés ou intentés à la suite de ou en rapport, directement ou indirectement, avec les procédures concernées, sera en anglais.

PARA LOS CLIENTES DE GRACO QUE HABLAN ESPAÑOL

Las partes reconocen haber convenido que el presente documento, así como todos los documentos, notificaciones y procedimientos judiciales emprendidos, presentados o establecidos que tengan que ver con estas garantías directa o indirectamente, estarán redactados en inglés.

PER I CLIENTI GRACO ITALIANI

Le controparti riconoscono di aver richiesto che il presente documento, e tutti gli altri documenti, avvisi e informazioni di natura legale sottoscritti, conferiti o istituiti direttamente o indirettamente, siano redatti in lingua inglese.

PARA CLIENTES PORTUGUESES DA GRACO

As partes confirmam que solicitaram que o presente documento, assim como todos os demais documentos, notas e processos legais inseridos, atribuídos ou instituídos de acordo com o mesmo ou relacionados directa ou indirectamente com este documento, fossem redigidos em inglês.

VOOR GRACO-KLANTEN IN NEDERLAND

De partijen zijn zich ervan bewust dat zij hebben geëist dat het onderhavige document, evenals alle documenten, berichtgevingen en wettelijke procedures die worden aangegaan, overhandigd of in gang gezet hetzij als gevolg van hetzij rechtstreeks hetzij indirect in relatie tot het onderhavige worden opgesteld in de Engelse taal.

ADDITIONAL WARRANTY COVERAGE

Graco does provide extended warranty and wear warranty for products described in the "Graco Contractor Equipment Warranty Program".

TO PLACE AN ORDER, contact your Graco distributor, or call **1-800-690-2894** to identify the nearest distributor.
All written and visual data contained in this document reflects the latest product information available at the time of publication.
Graco reserves the right to make changes at any time without notice.

This manual is written in English GN 310892 MM 310892

Graco Headquarters: Minneapolis

International Offices: Belgium, Korea, China, Japan

GRACO INC. P.O. BOX 1441 MINNEAPOLIS, MN 55440-1441

<http://www.graco.com>

PRINTED IN U.S.A. 2/2005, Revised 06/2009

Free Manuals Download Website

<http://myh66.com>

<http://usermanuals.us>

<http://www.somanuals.com>

<http://www.4manuals.cc>

<http://www.manual-lib.com>

<http://www.404manual.com>

<http://www.luxmanual.com>

<http://aubethermostatmanual.com>

Golf course search by state

<http://golfingnear.com>

Email search by domain

<http://emailbydomain.com>

Auto manuals search

<http://auto.somanuals.com>

TV manuals search

<http://tv.somanuals.com>