

# Harman Kardon Digital Lounge 632, 640, 646

## OWNER'S MANUAL



**harman/kardon®**  
Designed to Entertain.™

# Table of Contents

<b>Page</b>	
3	Introduction
4	Safety Information
5	Installation Location, Cleaning, Unpacking
6	Terminology
7	Features
8	Front Panel Controls
9	Front Panel Display
10	Rear Panel Connections
12	Rear Panel Connections TV
14	Remote Control
17	Second Remote Control
18	Basic Information
18	About This Manual
18	Regional Coding
<b>System Connection</b>	
19	Installation and Connections
19	Equipment
19	Optional Set Top Box or Cable Box Connections
20	Connecting a PC
20	Connecting a Digital Set Top Box or Satellite Receiver
20	Optional Audio Connections
20	Speaker Placement
21	Screen Placement
21	Connecting AC Power
21	First Turn On
<b>Playback Basics</b>	
21	Automatic Channel Search
22	Digital Tuner
23	Basic Playback
24	Disc Playback Features
24	Skipping tracks or titles/chapters
24	Fast Motion Playback/Fast Search
24	Freeze Frame and Frame Advance (with DVD only)
24	Slow Motion Playback (with DVD only)
24	About DivX Movie Files
25	Surround Mode
<b>System Setup</b>	
25	System Defaults
25	General Functionality of the User Interface
25	Setup Menu for Screen
26	TV Setup
27	Analog TV Search
28	DVD Setup
28	Picture Calibration
28	HDMI Setup
29	DVI Setup
29	Component, S-Video, Composite, Scart 1 and Scart 2 Setup
29	General Setup
30	Sound Set Up
30	Setup Menu for DVD Receiver
30	System Settings
30	Display Language
30	Preferred Subtitle Language
30	Panel Time-Out
30	Status Bar Time-Out
30	Parental Control
30	Disc Recognition
30	PBC Support
30	Screen Saver
30	Show Angle Icon
30	Audio Settings
30	Preferred Audio Language
31	Dynamic Range
31	Delay Unit
31	Tone Control
31	Bass Level
31	Treble Level
31	DVD Sound Mode
31	Audio Adjustment
31	Automated Speaker Setup (EzSet/EQ)
34	Manual Speaker Setup
34	Delay
34	Video Settings

34	Video Mode
34	Video Resolution
35	DivX Video On Demand
<b>Test Screen</b>	
36	Picture Calibration with Test Disc
<b>Player Menu</b>	
37	Using the Status Bar Menu
37	On Screen Display Menus
37	Disc Player Menu
38	Information Displays
38	Programmed Play
<b>Radio Menu</b>	
38	Radio Menu
39	Rearranging the station list
39	Selecting presets
39	Removing presets

39	RDS Station ID
39	Surround Mode for Tuner
<b>TV Menu, AUX Menu, Digital In Menu</b>	
40	TV Menu
40	AUX Menu
40	Digital In Menu
<b>USB Menu, The Bridge</b>	
41	USB Menu
41	The Bridge
42	Surround Mode Chart
<b>TV Functions</b>	
43	TV Functions
43	Changing Channels
43	Picture-In-Picture (PIP) Function
43	Aspect Ratio
44	Teletext

<b>Remote Control</b>	
44	Learning Codes
45	Erasing Learned Codes
<b>DVD Languages Codes</b>	
46	Languages Codes
<b>Troubleshooting</b>	
47	Troubleshooting
<b>Glossary</b>	
49	Glossary
<b>Specifications</b>	
50	Specifications

## Declaration of Conformity



We, Harman Consumer Group, Inc.  
2, route de Tours  
72500 Château-du-Loir,  
FRANCE

declare in own responsibility, that the product described in this owner's manual is in compliance with technical standards:

EN 55013:2001 + A1:2003

EN 55020:2002 + A1:2003

EN 61000-3-2:2000

EN 61000-3-3:1995 + A1:2001

EN 60065:2002

Jurjen Amsterdam  
Harman Consumer Group, Inc.  
03/08

## Typographical Conventions

In order to help you use this manual with the remote control, front-panel controls and rear-panel connections, certain conventions have been used.

**EXAMPLE** – (bold type) indicates a specific remote control or front-panel button, or rear-panel connection jack

**EXAMPLE** – (OCR type) indicates a message that is visible on the front-panel information display

**1** – (number in a square) indicates a specific front-panel control

**1** – (number in a circle) indicates a rear-panel connection

**1** – (number in an oval) indicates a button or indicator on the main remote control

**A** – (letter in a square) indicates an indicator on the front panel display

**A** – (letter in a circle) indicates a rear-panel connection on the TV

**A** – (letter in an oval) indicates a button on the small remote control

The appearance of the text or cursor for your receiver's on-screen menus may vary slightly from the illustrations in this manual. Whether the text appears in all uppercase or upper- and lowercase characters, performance and operation remain the same.

## Introduction

### Thank you for choosing Harman Kardon!

With the purchase of a Harman Kardon Digital Lounge system you are about to begin many years of listening enjoyment.

Designed to provide all the excitement and detail of movie soundtracks, every nuance of musical selections and crystal clear video playback, the Digital Lounge system is truly a complete audio/video system for the new millennium.

The Digital Lounge system has been engineered so that it is easy to take advantage of all the power of its digital technology. To obtain the maximum enjoyment from your new system, we urge you to read this manual. A few minutes spent learning the functions of the various controls will enable you to take advantage of all the power the Digital Lounge system is able to deliver.

If you have any questions about this product, its installation or its operation, please contact your retailer or custom installer. They are your best local sources of information.

### Description and Features

The Digital Lounge system is among the most complete and versatile home cinema systems. It incorporates a range of carefully designed, sophisticated integrated system components that combine an Audio Video Controller, DVD Audio player, a flat panel TV, 5.1 loudspeaker system and floor stands.

Harman Kardon Digital Lounge system offers our well-known audio and video performance and ease of use, together with complete control via one dedicated system remote control.

In addition to Dolby Digital and DTS decoding for digital sources, the Dolby Pro Logic II mode for Matrix surround-encoded or Stereo recordings is available for use with sources such as CD, VCR, TV broadcasts and the system's own FM tuner as well as the latest 5.1 channel versions of Harman's own Logic 7® technology.

To enable you to get the maximum quality from DVDs, the Digital Lounge system is equipped with the latest in design techniques, including a High Definition Multimedia Interface delivering the finest quality digital video transmitted over one single cable from the Harman Kardon Digital Lounge receiver/DVD-Audio player to the Harman Kardon Digital Lounge display. The one-way HDMI connection will allow you to watch your blockbuster movies in a high resolution up to 720p or 1080i. A DVI input to connect a PC is available too, as well as multiple HDMI inputs.

The 40" and 46" displays are both Full HD displays, fully compliant with future HD signals, ready to bring the latest technology for clearer and sharper pictures into your home. The 32" version is HD Ready.

With one simple connection between the Digital Lounge and the Harman Kardon™ Bridge™, you are able to listen to audio files stored on your compatible Apple® iPod®. The Bridge™ will even let you charge your iPod.

An important addition to the Digital Lounge's impressive list of features is EzSet/EQ™, which automates the configuration process to make it quicker, easier and more precise. Using the special microphone supplied with the unit, EzSet/EQ takes the guesswork out of entering speaker "size" and crossover information, delay times for all channels and output levels. In addition to the configuration settings, EzSet/EQ also includes room equalization so that the signals sent to each speaker are tailored to provide accurate sonic quality with your specific combination of speaker type, room size and other factors that influence room acoustics. With EzSet/EQ, your system is custom-configured in a few minutes with accuracy that previously required expensive and hard-to-use test equipment.

Along with conventional Video and CD audio discs, the Digital Lounge system is also compatible with MP3, CD-R and CD-RW as well as DivX® and VCD discs.

As portable USB devices increase in popularity, Harman Kardon's Digital Lounge system is among the first integrated home theater system that allows mobile interconnectivity by playing compatible music or image files from portable devices via two USB On-The-Go inputs.

A wide range of programming features makes it easy to program an evening's worth of entertainment. When playing DVDs, easy-to-understand on-screen menus and icons make it simple to change languages, soundtracks, subtitles or aspect ratio, while a parental-lock function enables you to control which discs may be viewed by younger members of the household.

For total user convenience, Harman Kardon Digital Lounge offers a system remote control, ready to operate the screen, the DVD player and the receiver. Besides the standard full function remote control used for initial setup and system calibration, Harman Kardon offers a second and smaller remote control. By limiting the buttons on this remote control to those that will be used during every day use, system control becomes extremely easy and pleasant.

- **Plays a Wide Range of Video and Audio Formats, Including DVD-Video Discs, VCD, Standard CD Audio Discs, CD-R/RW, DVD-R/RW, DVD-+R/RW, Audio Discs and MP3 Discs**
- **DVD-Audio Playback for Richer Detail, Expanded Dynamic Range and Improved Realism**
- **HDMI One-wire Digital Video Connection between the Screen and the Controller**
- **Extensive Speaker Setup Options with, Output Level Adjustment and Delay Settings**
- **High-Quality Video Playback 10-Bit DACs, Progressive Scan**
- **Independent Picture Calibrations for Each Individual Input**

**NOTE:** This player is designed and manufactured for compatibility with Region Management Information that is encoded on most DVD discs. This player is designed only for playback of discs with Region Code 2, or for discs that do not contain Region Code information. If there is any other Region Code on a disc, that disc will not play on the DVD.



- **Advanced Analog Signal Conversion (AASC) Technology**
- **Automatic TV Channel Search**
- **Full HD (HD Ready on the DL 632) with 4 HDMI and DVI inputs**
- **High-bandwidth Digital Content Protection (HDCP)**
- **Built-in DVB-T Tuner and integrated Multi Standard TV tuner with Picture in Picture (PIP) and Teletext**
- **Easy-to-Use On-Screen Navigation System**
- **Playback of MP3 and Windows® WMA Audio Discs and JPEG image files**
- **Harman Kardon's exclusive Logic 7® processing**
- **Harman Kardon's advanced EzSet/EQ™ automatically configures speaker settings and sets room equalization for quick, easy and accurate system setup**
- **Connects to Harman Kardon's™Bridge™ (optional) for charging, playback and control of a compatible Apple® iPod® device**
- **Simultaneous Playback of MP3 and JPEG files**
- **Side- and rear-panel USB On-The-Go connections for playing compatible music or image files from portable devices**
- **Extensive Programming Capability for Audio and Video Discs**
- **Parental Lock Controls Prevent Unauthorized Viewing of Restricted Movies**
- **Playback of DivX compressed video files**
- **Multiple Options for Language, Soundtrack and Subtitle Selection**
- **Multiple-Angle Capabilities With Specially Encoded DVD Discs**
- **Ergonomically Designed Remote Controls**
- **Multiple digital inputs and outputs**
- **Multiple Analog Inputs and Outputs**
- **High Definition On-screen menu and display system**
- **Subwoofer Trigger to Control Subwoofer On/Off**

### IMPORTANT NOTES:

This manual describes the working of your complete Harman Kardon Digital Lounge system, and replaces the individual manuals found in some of the components of your system.

Only use the Digital Lounge system controller with the loudspeaker system supplied. Failure to do so may cause damage to either the controller or the loudspeakers and will invalidate any warranty.

All of the optional system settings have been preset at our factory for correct operation of the system. All you have to do is insert a disc, sit back, and enjoy a great home theater experience.

You may want to change some of the optional settings. A description of all the optional settings and instructions for changing them are found in the second half of the manual.

This system was designed to provide you with many years of reliable operation with a minimum of care and maintenance. Every component in your system was in perfect working condition when it left our factory. If you experience any problems with the set-up or operation of this system, please review the Troubleshooting Guide at the end of this manual before you contact your authorized Harman Kardon dealer.

### Important Safety Information

#### Verify Line Voltage Before Use

Your Digital Lounge system has been designed for use with 220-240-Volt AC current. Connection to a line voltage other than that for which it is intended can create a safety and fire hazard and may damage the system.

If you have any questions about the voltage requirements for your specific model, or about the line voltage in your area, contact your dealer before plugging the unit into a wall outlet.

#### Do Not Use Extension Cords

To avoid safety hazards, use only the power cords attached to your system components. We do not recommend that extension cords be used with this product. As with all electrical devices, do not run power cords under rugs or carpets or place heavy objects on them. Damaged power cords should be replaced immediately by an authorized service depot with a cord meeting factory specifications.

#### Handle the AC Power Cord Gently

When disconnecting the power cord from an AC outlet, always pull the plug, never pull the cord. If you do not intend to use the system for any considerable length of time, disconnect the plug from the AC outlet.

#### Do Not Open the Cabinet

There are no user-serviceable components inside the system components. Opening the cabinets or rear panels may present a shock hazard, and any modification to the system components will void your guarantee. If water or any metal object such as a paper clip, wire or a staple accidentally falls inside the system components, disconnect them from the AC power source immediately, and consult an authorized service station.

## Safety Information

### Installation Location

- To assure proper operation and to avoid the potential for safety hazards, place the system components on a firm and level surface. When placing any of the system components on a shelf, be certain that the shelf and any mounting hardware can support the weight of the product.
- Make certain that proper space is provided both above and below the system components for ventilation. If this product will be installed in a cabinet or other enclosed area, make certain that there is sufficient air movement within the cabinet. Under some circumstances a fan may be required.
- Do not place the system components directly on a carpeted surface.
- Avoid installation in extremely hot or cold locations, or an area that is exposed to direct sunlight or heating equipment.
- Avoid moist or humid locations.
- Do not obstruct the ventilation slots on the top of the system components, or place objects directly over them.
- The display surface of the screen is sensitive to pressure and scratching. Treat the display surface with care in order to avoid lasting damage.
- If the screen is brought into its operating room from cold surroundings, condensation can occur. Wait until the device has reached room temperature and is absolutely dry before you put it into operation.
- The screen will set itself automatically to a mains voltage in the range of 100 V to 240 V. Ensure that the local mains voltage does not exceed and is not less than this range.
- The screen may be connected to an earthed mains outlet only.
- The On-Off switch does not disconnect the set from the mains voltage. For complete disconnection from the mains voltage you must pull out the mains plug.

- The set must be disposed of as special waste in accordance with your local waste disposal regulations. The safety regulations that apply to luminous materials have to be taken into account for handling and disposal purposes.
- The backlight of the LCD TV contains mercury. The safety regulations that apply to fluorescent tubes have to be taken into account for handling and disposal purposes.
- For PC operation use a screen saver with moving pictures and activate the power management for your display to avoid screen "burns" being caused by still pictures.

### Cleaning

When the system components gets dirty, wipe it with the soft, dry cloth and the special ScreenClean liquid that is supplied with your Harman Kardon Digital Lounge product. NEVER use benzene, aerosol cleaners, thinner, alcohol or any other volatile cleaning agent. Do not use abrasive cleaners, as they may damage the finish of metal parts. Avoid spraying insecticide near the system components.

### Moving the Unit

Before moving the system components, be certain to disconnect any interconnection cords with other components, and make certain that you disconnect the components from the AC outlet.

### Unpacking

Before unpacking the screen, please take the protective white gloves from the accessory tool box. These gloves allow you to unpack the screen without damaging the screen and its high gloss finish.

The carton and shipping materials used to protect your new DVD player/receiver, TV and loudspeakers during shipment were specially designed to cushion it from shock and vibration. We suggest that you save the carton and packing materials for use in shipping if you move, or should the components ever need repair.

To minimize the size of the carton in storage, you may wish to flatten it. This is done by carefully slitting the tape seams on the bottom and collapsing the carton. Other cardboard inserts may be stored in the same manner. Packing materials that cannot be collapsed should be saved along with the carton in a plastic bag.

If you do not wish to save the packaging materials, please note that the carton and other sections of the shipping protection are recyclable. Please respect the environment and discard those materials at a local recycling center.

### Copyright

Audio-visual material may consist of copyright works which must not be recorded without the permission of the owner of the copyright. Please refer to relevant laws covering copyright protection.





### Copy protection

This DVD player supports Macrovision copy protection. On DVD discs that include a copy protection code, if the contents of the DVD disc are copied using a VCR, the copy protection code prevents the videotape copy from playing normally.

### For Optimum Performance

The controller is a precision device that is constructed using extremely accurate technology. Soiling or friction affecting the pickup lens or disc drive can impair the image quality. In the worst case, neither video nor audio will be played back. To obtain optimum picture quality, the player should be checked (cleaning and replacement of some parts) every 1,000 hours. Note that this period varies depending on the environment (temperature, humidity, dust) in which the player is used.

**Do not attempt to clean the pickup lens yourself.**

	<b>CAUTION</b> RISK OF ELECTRIC SHOCK DO NOT OPEN	
CAUTION: TO REDUCE THE RISK OF ELECTRIC SHOCK, DO NOT REMOVE COVER (OR BACK). NO USER-SERVICEABLE PARTS INSIDE. REFER SERVICING TO QUALIFIED SERVICE PERSONNEL.		
		
The lightning flash with arrowhead symbol, within an equilateral triangle, is intended to alert the user to the presence of uninsulated "dangerous voltage" within the product's enclosure that may be of sufficient magnitude to constitute a risk of electric shock to persons.	The exclamation point within an equilateral triangle is intended to alert the user to the presence of important operating and maintenance (servicing) instructions in the literature accompanying the appliance.	
<b>WARNING: TO REDUCE THE RISK OF FIRE OR ELECTRIC SHOCK, DO NOT EXPOSE THIS APPLIANCE TO RAIN OR MOISTURE.</b>		

# Terminology

## Terminology

Since they share some of the characteristics and technology of CD players, many of the terms and operational concepts used in a DVD player are similar to what you may be familiar with from CD players and changers, or older video disc formats such as Laser Disc. However, if this is your first DVD product, some of the terms used to describe the features of a DVD player may be unfamiliar. The following explanations should solve some of the mysteries of DVD, and help you to enjoy all the power and flexibility of the DVD format and the DVD.

With the arrival of DVD, disc data capacity has increased dramatically. On a DVD Video disc most of this capacity is taken up by MPEG 2 video and the multichannel movie soundtrack in Dolby Digital and/or DTS. This information is compressed.

### Full HD and HD Ready

High Definition (HD) is the future broadcast standard, delivering much higher video resolution. The "HD ready" logo is introduced by the European Industry Association for Information Systems (EICTA). It is a quality sign for the differentiation of display equipment, capable of processing and displaying these new HD signals, awarded on the basis of minimum functionality requirements.

### High Definition Multimedia Interface

**(HDMI):** HDMI has emerged as the digital standard for connecting High Definition devices, displays and components, and provides for the pristine transmission of high-definition digital video. HDMI is the first and only digital interface for Consumer Electronics devices that can carry uncompressed high-definition video, and command data, allowing customers to obtain pure digital high-definition video.

### Digital Visual Interface™ (DVI) Input

The DVI input provides a high speed, digital connection for visual data types. The interface is primarily focused at providing a connection between a computer and the display.

### High-bandwidth Digital Content Protection (HDCP)

HDCP is a specification developed to protect digital entertainment content across the DVI/HDMI interface. The HDCP specification provides a robust, and transparent method for transmitting and receiving digital entertainment content from our Harman Kardon Cinema Lounge DVD-Audio/Video player to the DVI/HDMI-inputs on the Harman Kardon Digital Lounge display.

**USB On-The-Go:** Due to its widespread acceptance, USB is becoming the de facto industry standard for connecting peripherals to PCs and laptops. Many of the new peripherals using USB are also portable devices.

As these portable devices increase in popularity, there is a growing need for them to communicate directly with each other when a PC is not available, for instance in consumer electronics products. The USB On-The-Go technology addresses this need for mobile interconnectivity.

**Title:** For a DVD, a title is defined as an entire movie or program. There can be as many chapters within a title as the producers decide to include. Most discs include only one title, but some may have more than one, to give you a "Double Feature" presentation.

**Chapter:** DVD programs are divided into chapters and titles. Chapters are the sub-sections programmed into a single title on a disc. Chapters may be compared to the individual tracks on an audio CD.

**Progressive scan:** Due to the immense data storage capacity of DVD, images are nowadays stored progressively (intact, rather than interlaced). This allows all of the lines in each frame (odd and even) to be shown at the same time. Harman Kardon Digital Lounge comes with true progressive scan video output resulting in a 40% greater light output than a conventional TV and a stunningly detailed, high definition image with absence of visible scanlines and motion artifacts.

### Advanced Analog Signal Conversion (AASC) Technology

Standard definition analog TV tuners broadcast an image of 576 lines; LCD screens have a resolution that have much more available scan lines. If an analog tuner signal is not handled appropriately, the picture quality of analog tuner signals on higher definition screens risks looking distorted, with pixels being clearly visible, sharp edges and a loss of definition.

Our systems use Advanced Analog Signal Conversion technology to optimize the picture coming from analog tuners. The result is a very defined and smooth picture that is comparable with digital images coming from higher resolution, digital tuners.

### DVB-T

DVB-T stands for Digital Video Broadcasting - Terrestrial and it is the European consortium standard for the broadcast transmission of Digital terrestrial television.

**Multiple Angle:** DVDs have the capability to show up to four different views of the same scene in a program. When a disc is encoded with multiple-angle information, pressing the Angle button will enable you to switch between these different views. Note that at present, few discs take advantage of this capability and, when they do, the multiple-angle technology may only be present for short periods of time within the disc. Producers will usually insert some sort of icon or graphic in the picture to alert you to the availability of multiple viewing angles.

**Reading:** This is a message that you will see after you've loaded the disc. It refers to the fact that the player must first examine the contents of the disc to see if it is a CD or DVD, and then extract the information about the type of material on the disc, such as languages, aspect ratios, subtitles, number of titles and more. The slight delay while the contents of the disc are read is normal.

**Resume:** The operation of the Stop Button on the DVD works differently from what you are used to on CD players. On a traditional CD player, when you press the Stop button, the unit does just that: it stops playback. On a CD player, when you press the start button again, the disc starts from the beginning. With the DVD, however, you have two options when playing DVD discs. Pressing Stop once will stop playback, but it actually puts the unit in the Resume mode. This means that you can turn the machine off and, when you press play the next time, the disc will resume or continue from the point on the disc where the Stop button was pressed. This is helpful if you are watching a movie and must interrupt your viewing session but wish to pick up where you left off. Pressing the Stop button twice will stop the machine in a traditional manner and, when the disc is played again, it will start from the beginning.

In resume mode, the cover of the DVD will be displayed, if available. Otherwise, the Harman Kardon screen will appear.

### DivX

DivX is the name of a new video codec which is based on the MPEG-4 compression standard for video. This DVD player will playback discs created with DivX software. The DVD player's playback functionalities of DivX video discs will vary depending on the DivX software version used for creating your movies. For more information about the different software versions of DivX, please go to [www.divx.com](http://www.divx.com).

## Features

### High quality video

- High Definition Multimedia Interface (HDMI) for a single wire, digital connection to your screen.
- Digital Visual Interface (DVI) provides a high speed, digital connection between a computer and the screen.
- Advanced sophisticated 10-bit MPEG-2 video decoding circuits.
- Progressive Scan component video outputs (NTSC and PAL)
- DVB-T for digital terrestrial television broadcast.
- Advanced Analog Signal Conversion (AASC) Technology for optimized pictures coming from analog tuners.
- Test screen videos available for testing video performance and setup.
- Pure PAL with NTSC disc due to true NTSC/PAL conversion.
- Dual-layer compatibility for extended play DVD.
- Playback of JPEG image files

### High quality digital audio

- High quality 5.1 digital surround sound from DVD-Audio, DTS or Dolby Digital discs.
- With linear PCM audio at 16-24 bits and 44-96 kHz, audio quality exceeding that of CD becomes possible.
- Coaxial digital audio output.

### Many convenient features

- On-Screen Menu Icons for disc information or player information and access to many major functions of this unit.
- EzSet/EQ automatic calibration.
- Thumbnails for easy search of image files.
- Subtitles may be displayed in one of numerous languages\*.
- The multi-angle function allows you to choose the viewing angle of scenes which were shot from a number of different angles (Limited to DVD's recorded with multiple camera angles.)
- Multiple options for dialog language and soundtrack selection (limited to DVD's recorded with multiple dialog languages or soundtracks).
- Intuitive menu operating system.
- 4 step Zoom during play and pause.
- Backlit, ergonomically designed main remote control and a second, smaller remote control for day to day usage.
- Future software upgrades accessible via Internet. (See information below.)

\* The number of languages recorded depends on the software.

### Compatible with CD as well as DVD

- The Digital Lounge system will play any conventional Audio CD or recordable (CD-R) or erasable CD (CD-RW), MP3, WMA (v9) or any DivX or VCD or DVD-Audio and DVD-Video with the region code 0 or 2.

### Disc formats supported by this player

The unit can play the following disc formats (8 cm and 12 cm size):

- DVD
- DVD-AUDIO
- DVD-R
- DVD-RW
- DVD+R
- DVD+RW
- CD
- CD-R
- CD-RW
- VCD
- S-VCD
- WMA (v9)
- DivX and XviD

**NOTE:** Due to differences in the format of certain discs, it is possible that some discs may include a mix of features that are not compatible with the DVD. Similarly, although the DVD is capable of a wide range of features, not all discs include every capability of the DVD system. For example, although the DVD is compatible with multi-angle discs, that feature is only possible when the disc is specially encoded for multi-pleangle play. In addition, the DVD is capable of playing back both Dolby Digital and DTS soundtracks, but the number and types of tracks available will vary from disc to disc. To make certain that a specific feature or soundtrack option is available, please check the options noted on the disc jacket.

- Playback capability for CD-R, CD-RW, WMA, JPEG, MP3, DivX, VCD/SVCD, DVD-R, DVD+R, DVD-RW and DVD+RW discs may vary due to variations in the quality of the disc and the recorder used to create the disc.

- The Digital Lounge system is compatible with most discs recorded with files encoded using MP3 or Windows Media 9, as well as JPEG still images. However, note that variations in the encoder or codec used and the bit rate of the encoding may affect the Digital Lounge system's ability to play back a specific disc. As a result, we cannot guarantee complete compatibility with all encoders and versions of the codecs. For best results, we recommend that MP3 files be encoded at bit rates ranging between 32kbps and 320kbps. WMA files should be encoded at bit rates between 64kbps and 320kbps. Although the Digital Lounge systems is capable of playing some WMA 9 files, not all features of version 9 are supported. JPEG Files should not be created with the SRGB or CMYK mode.

### Upgradeability via Internet

The "firmware" controlling the functionality of the Harman Kardon Digital Lounge system is fully upgradeable. In the event of future improvements to its operations and features, it will be possible to download firmware upgrades from [www.harmankardon.com/International/](http://www.harmankardon.com/International/) All you have to do is create a CD-R with the data and insert it in the DVD for an automatic upgrade. You can also load the upgrade on a portable mass storage device to connect to any of the two USB inputs.

### Packing List

- 1 Harman Kardon Digital Lounge system DVD Player/Controller
- 1 Harman Kardon HKTS 11 Home Theater Speaker System
- 1 HT 32EX, HT 40HD or HT 46HD LCD TV
- 1 Harman Kardon HTFS 2 Loudspeaker Stands

### Tool Kit:

- 1 Main remote control
- 1 Day-to-day use remote control
- 1 Owner's manual
- 1 Safety booklet
- 6 Batteries
- 1 HDMI - SP-DIF - Remote In/Out cable
- 1 Drilling jig
- 1 ScreenClean kit
- 2 Pair of gloves
- 1 DVD with test material
- 1 Pair of calibration glasses
- 1 After sales card

## Front Panel Controls

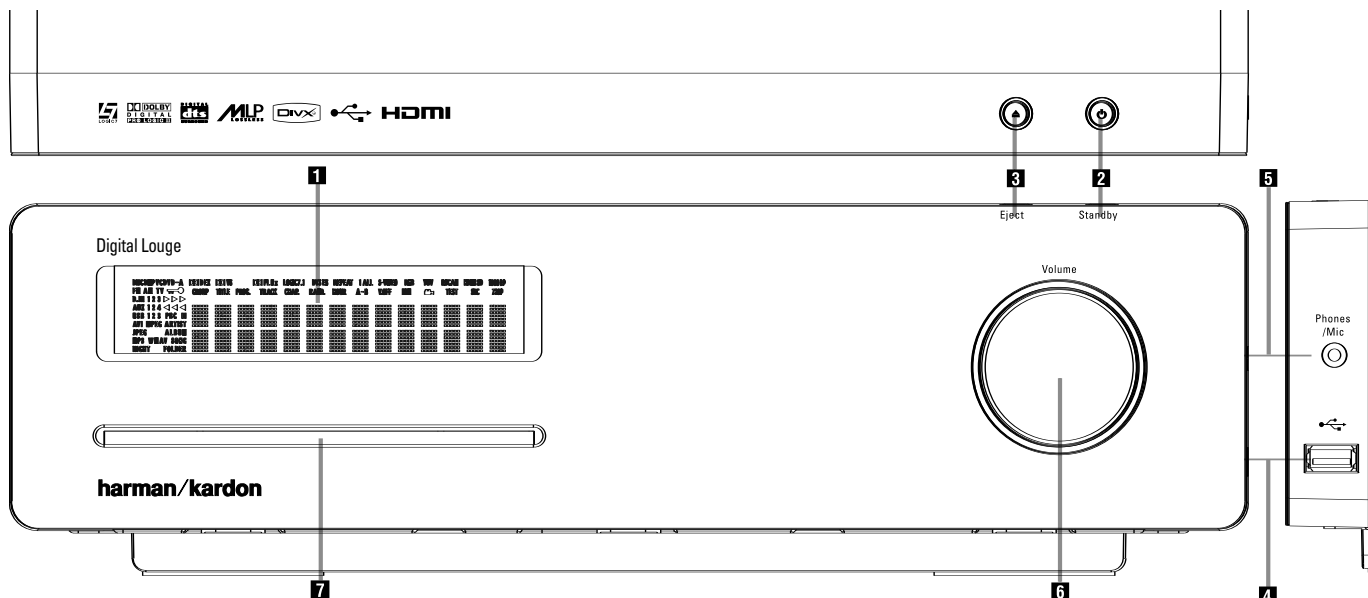

- 1** Main Information Display
- 2** Power On/Off (Standby)
- 3** Open/Close

- 4** USB On-The-Go Input
- 5** Headphone Jack
- 6** Volume Control

- 7** Slot Loader

**1 Main Information Display:** This display delivers messages and status indications to help you operate the Digital Lounge Controller.

**2 Power On/Off (Standby):** Press the button once to turn the Digital Lounge Controller on, press it again to put the unit in the Standby mode.

Note that when the Digital Lounge Controller is switched on, the Power Indicator around the button turns blue.

**3 Eject:** Press this button to release a disc from the loader.

**4 USB On-The-Go Input:** This input may be used to temporarily connect a USB thumb device or portable hard disk for direct playback of audio, image or video files or a USB hub. The USB inputs are designed to power a single USB device at a time. If additional hard disks are connected through a hub it is necessary that additional external power supplies are used to power the hub and hard disks.

**5 Headphone Jack:** This jack may be used to listen to the system's output through a pair of headphones. Be certain that the headphones have a standard 3.5 mm stereo phone plug. Note that the main room speakers will automatically be turned off when the headphone jack is in use.

When configuring your system using EzSet/EQ, the calibration microphone should be plugged into this jack **5**.

**6 Volume Control:** Turn this knob clockwise to increase the volume, counterclockwise to decrease the volume. If the system is muted, adjusting volume control will automatically release the unit from the silenced condition.

**7 Slot loader:** Gently insert a CD or DVD into this slot, with the printed side of the disc facing up. Note there is no drawer. Press the **Eject Button 3** to release the disc



# Front Panel Display

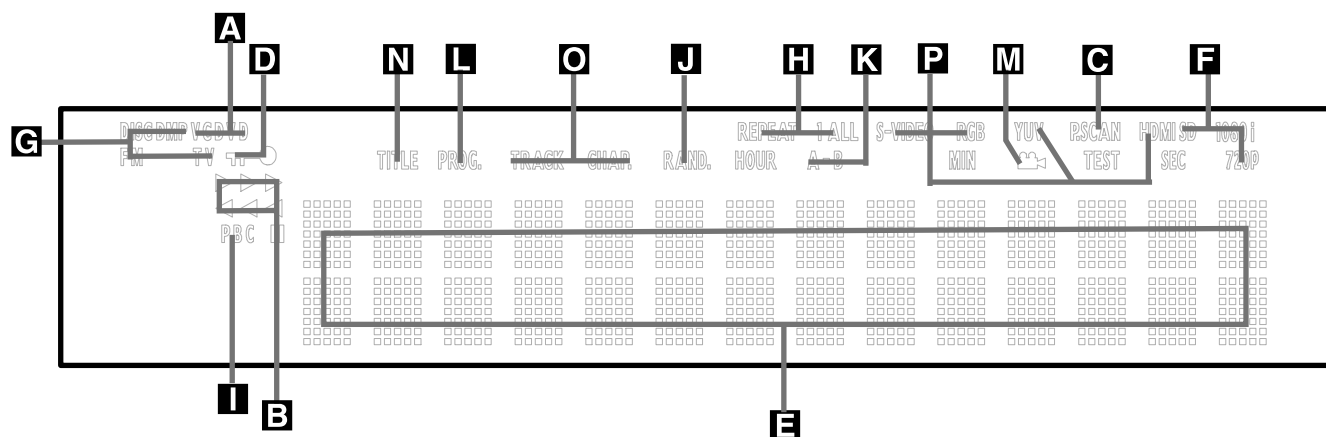

- A** Disc Type Indicators
- B** Playback-Mode Indicators
- C** Progressive Scan Indicator
- D** Parental Lock Indicator
- E** Time Indicators
- F** Video Format Indicators
- G** Source Indicators
- H** Repeat Indicators
- I** VCD Playback Control Indicator
- J** Random Indicator
- K** A-B Repeat Indicator
- L** Program Indicator
- M** Angle Indicator
- N** Title Indicators
- O** Chapter/Track Number Indicators
- P** Video Output Indicators

**A Disc Type Indicators:** The CD or DVD indicator will illuminate to show the type of disc currently being played.

**B Playback-Mode Indicators:** These indicators light to show the current playback mode:

- ▶ Lights when a disc is playing in the normal mode
- ▶▶ Lights when the disc is in the Fast Search Forward mode. The on-screen banner display indicates the selected speed (2x, 8x, 16x, 100x).
- || Lights when the disc is paused.
- ◀◀ Lights when the disc is in the Fast Search Reverse mode. The on-screen banner display indicates the selected speed (2x, 8x, 16x, 100x).

**C Progressive Scan Indicator:** This indicator lights when the unit sends out a progressive scan signal.

**D Parental Lock Indicator:** This indicator lights when the parental-lock system is engaged in order to prevent anyone from changing the rating level without a code.

**E Time Indicators:** These positions in the indicator will show the running time of a DVD in play. When a CD is playing, these indicators will show the current track time, time remaining in the current track, or the total remaining time on the disc. When an iPod is playing, the display will show the elapsed and remaining time on the top line. The bottom line will scroll information about the song, title, album and artist.

**NOTE:** The Indicators **N O E** will also display text messages about the DVD's status, including **Reading** when a disc is loading, **STANDBY** when the unit is turned off, and **Disc Error** when a disc not compatible with the DVD is put into the play position.

**F Video Format Indicators:** These indicators will represent the video format currently playing.

**G Source Indicators:** These indicators will light to show which source is currently selected.

**H Repeat Indicators:** These indicators light when any of the Repeat functions are in use.

**I VCD Playback Control Indicator:** This indicator lights when the playback control function is turned on with VCDs.

**J Random Indicator:** This indicator lights when the unit is in the Random Play mode.

**K A-B Repeat Indicator:** This indicator lights when a specific passage for repeat playback has been selected.

**L Program Indicator:** This indicator lights when the programming functions are in use.

**M Angle Indicator:** This indicator blinks when alternative viewing angles are available on the DVD currently playing.

**N Title Indicators:** These two positions in the display will show the current title number when a DVD disc is playing.

**O Chapter/Track Number Indicators:** When a DVD disc is playing, these two positions in the display will show the current chapter. When a CD disc is playing they will show the current track number.

**P Video Output Indicators:** These indicators will represent the active video output .

# Rear Panel Connections

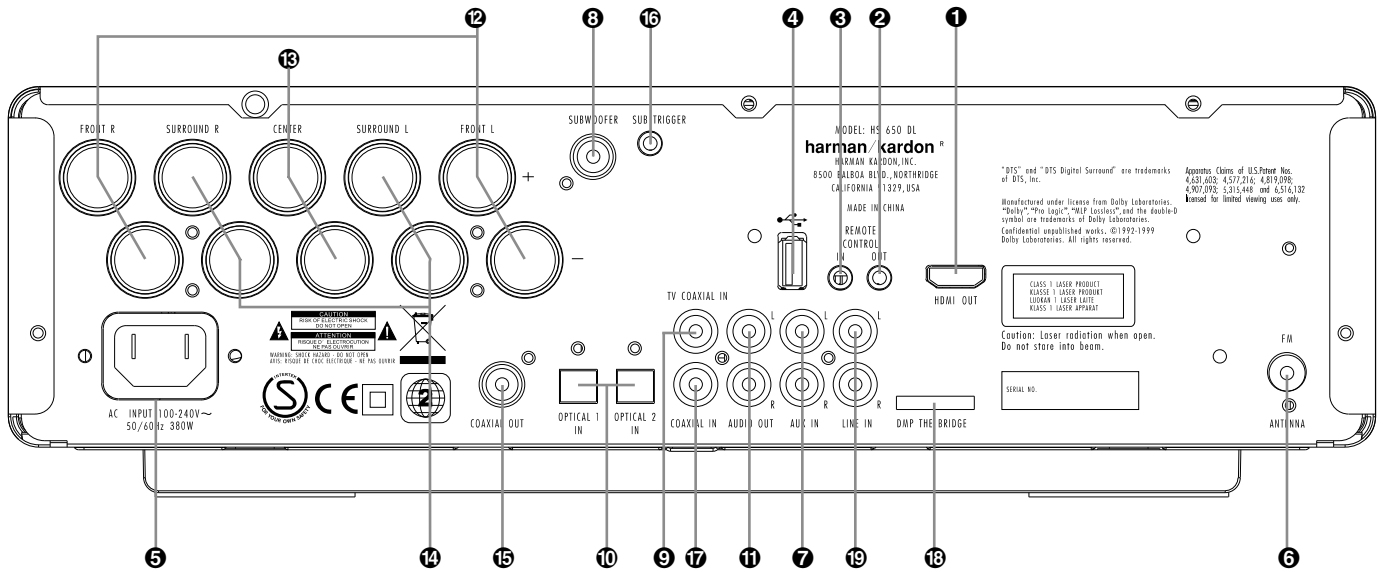

- 1 HDMI Output
- 2 Remote IR Output
- 3 Remote IR Input
- 4 USB On-The-Go Input
- 5 AC Power Cord
- 6 FM Antenna
- 7 Audio In

- 8 Subwoofer Output
- 9 Coaxial Digital TV Input
- 10 Optical Digital Input
- 11 Analog Audio Outputs
- 12 Front Speaker Outputs
- 13 Center Speaker Outputs
- 14 Surround Speaker Outputs

- 15 Coaxial Digital Output
- 16 Subwoofer Trigger Output
- 17 Coaxial Digital Input
- 18 DMP The Bridge Input
- 19 Analog Audio Inputs

**1 HDMI Output:** Connect this output to the HDMI input **1** of the screen, using the supplied HDMI - SP-DIF - Remote In/Out cable.

**2 Remote IR Output:** This connection permits the IR sensor in the receiver to serve other remote controlled devices. Connect this jack to the "IR IN" jack on Harman Kardon or other compatible equipment. Note this connection is only necessary for optional, additional products connected to the player. It is not necessary for proper control of the Digital Lounge system.

**3 Remote IR Input:** Connect this input to the Remote IR Output **1** of the TV, using the special HDMI - SP-DIF - Remote In/Out cable. This will allow you to control all components in your system by pointing the remote control to the TV only.

**4 USB On-The-Go Input:** This input may be used to temporarily connect a USB thumb device or portable hard disk for direct playback of audio, image or video files, a digital photo camera or a USB hub.

**5 AC Power Cord:** Connect this plug to an AC outlet. If the outlet is controlled by a switch, make certain that it is in the ON position.

**6 FM Antenna:** Connect to the supplied FM antenna.

**7 Audio In:** Connect to a line-level analog audio source: TV, tape player, Minidisc, PC, etc.

**8 Subwoofer Output:** Connect to the SUB/LFE input on the subwoofer.

**9 Coaxial Digital TV Input:** Connect the Coax Digital TV Output **15** of the screen to this jack, using the supplied HDMI - SP-DIF - Remote In/Out cable.

**10 Optical Digital Input:** Connect the optical digital output from a DVD player, HDTV receiver, LD player, MD player, satellite receiver or CD player to this jack. The signal may be either a Dolby Digital signal, DTS signal or a standard PCM digital source.

**11 Analog Audio Outputs:** Connect these jacks to the RECORD/INPUT jacks of an optional audio recorder for recording.

**12 Front Speaker Outputs:** Connect these outputs to the matching + or – terminals on your left and right speakers. In conformance with the new CEA color code specification, the White terminal is the positive, or "+" terminal that should be connected to the red (+) terminal on Front Left speaker with the older color coding, while the Red terminal is the positive, or "+" terminal that should be connected to the red (+) terminal on Front Right speaker. Connect the black (–) terminals on the Digital Lounge system to the black (–) terminals on the speakers. See page 19 for more information on speaker polarity.

**13 Center Speaker Outputs:** Connect these outputs to the matching + and – terminals on your center channel speaker. In conformance with the new CEA color code specification, the Green Terminal is the positive, or "+" terminal that should be connected to the red (+) terminal on speakers with the older color coding. Connect the black (–) terminal on the Digital Lounge system to the black negative (–) terminal on your speaker. (See page 19 for more information on speaker polarity.)

## Rear Panel Connections

**14 Surround Speaker Outputs:** Connect these outputs to the matching + and – terminals on your surround channel speakers. In conformance with the new CEA color code specification, the Blue terminal is the positive, or "+" terminal that should be connected to the red (+) terminal on the Surround Left speaker with older color coding, while the Gray terminal should be connected to the red (+) terminal on the Surround Right speaker with the older color coding. Connect the black (–) terminal on the Digital Lounge system to the matching black negative (–) terminals for each surround speaker. (See page 19 for more information on speaker polarity.)



**Note:** You'll find more details about all Audio/Video connections under Setup and Connections on the following pages.

**15 Coaxial Digital Output:** Connect this jack to the matching digital input connector on a digital recorder such as a CD-R or MiniDisc recorder.

**16 Subwoofer Trigger Output:** Connect this trigger output to the trigger input of the Harman Kardon subwoofer, so that the subwoofer will switch on and off at the same time as the rest of the system.

**17 Coaxial Digital Input:** Connect the coaxial digital output from a DVD player, HDTV receiver, LD player, MD player, satellite receiver or CD player to this jack. The signal may be either a Dolby Digital signal, DTS signal or a standard PCM digital source.

### **18 The Bridge Digital Media Player (DMP)**

**Connector:** With the Digital Lounge turned off, connect one end of the optional Harman Kardon **The Bridge** to this proprietary connector, and the other to your compatible Apple iPod. When the Digital Media Player source is selected, you may view your iPod's control and navigation messages on your video display and in the **Upper and Lower Display Lines** . You may navigate the iPod and select tracks for playback using the **▲/▼/◀/▶ Buttons**  and the **Enter Button** .

**19 Analog Audio Inputs:** Connect these jacks to the analog audio output on a TV set or external audio system for analog audio playback.

## Rear Panel Connections TV

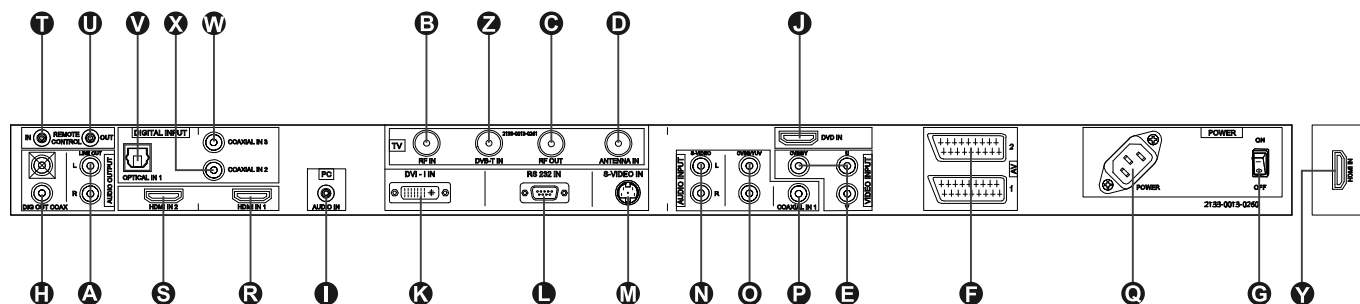

- A** Audio Output
- B** RF Antenna Input
- C** RF Antenna Output
- D** Antenna Input
- E** Component Video Inputs  
(and Composite Video Input)(CVBS/Y)
- F** Scart Inputs
- G** Power On/Off Switch
- H** Coaxial Digital TV Output
- I** PC Audio Input
- J** DVD Input
- K** DVI Input
- L** RS 232 Port
- M** S-Video Input (YC)
- N** Audio Input for S-Video
- O** Audio Input for Component Video
- P** Coaxial Digital 1 Input
- Q** AC Power Cord Socket
- R** HDMI 1 Input
- S** HDMI 2 Input
- T** Remote IR Input
- U** Remote IR Output
- V** Optical Digital 1 Input
- W** Coaxial Digital 2 Input
- X** Coaxial Digital 3 Input
- Y** HDMI 3 Input (Side)
- Z** DVB-T Antenna Input

**A Audio Output:** These jacks have no direct function in the system. They will output the internal audio signal of the screen, either from its tuner or an external source connected to any other input.

**B RF Antenna Input:** Keep the attached patch cord connected to the **RF Antenna Output C**.

**C RF Antenna Output:** Keep the attached patch cord connected to the **RF Antenna Input B**.

**D Antenna Input:** Connect the output of your terrestrial antenna or cable to this input.

**E Component Video Inputs (and Composite Video Input):** These jacks have no direct function in the system. If you have optional video sources like a satellite receiver or VCR with a component (or composite) video output, connect the video output of these sources to these inputs. In the TV Menu system, these inputs are referred to as YUV for Component Video (1 RCA-Phono Plug) and CVBS for Composite Video (3 RCA-Phono Plugs).

**F Scart Inputs:** These inputs have no direct function in the system. If you have optional video sources like a satellite receiver or VCR with a scart video output, connect it to any of the two inputs. In the TV Menu system, these inputs are referred to as AV1 and AV2.

**G Power On/Off Switch:** Press this button to switch the screen on or off.

**H Coaxial Digital Audio/TV Output:** Connect the **Coax Digital TV Input Q** of the DVD Receiver to this jack, using the supplied SP-DIF cable.

**I PC Audio Input:** Connect the audio output of a computer connected to the **DVI input K** to this jack.

**J DVD Input:** Connect the **HDMI output S** of the DVD Receiver to this input, using the supplied HDMI cable.

**K DVI Input:** Connect this jack to the DVI Output of a personal computer or the DVI or HDMI output (via HDMI/DVI adapter cable) of any digital source. Note that in order to have analog 2 channel sound from this source, you should also connect the audio output of the source to the **PC Audio Input I** of the screen. This input can also be connected to your digital set top box, satellite receiver or other video source with a DVI output connector. If your video source only has an HDMI connector, please use the supplied HDMI to DVI connector. For more information please see page 20.

**L RS-232 Port:** This jack may be used to control the screen over a bi-directional RS-232 serial control link to a compatible computer or programmable remote control system. Due to the complexity of programming RS-232 commands, we strongly recommend that connections to this port for control purposes be made by a trained and qualified technician. This jack may also link to a compatible computer to upgrade the software and operating system of the screen when upgrades are available.

## Rear Panel Connections TV

**M S-Video Input:** This input has no direct function in the system. If you have optional video sources like a satellite receiver or VCR with an S-Video output, connect it to this input. In the TV Menu system, this input is referred to as YC.

**N Audio Input for S-Video:** If you have connected optional video sources to the **S-Video Input M**, the audio output of that source should be connected to this input.

**O Audio Input for Component Video:** If you have connected optional video sources to the **Component Video Inputs E**, the audio output of that source should be connected to this input.

**P Coaxial Digital 1 Input** This jack has no direct function in the system. If you connect it with the coaxial digital output of any source the signal will be looped through to the **analog output A** and the **digital output H** of the screen as soon as the appropriate source is selected on the screen associated with that SPDIF input. Note that only PCM signals (44.1k, 48k, 96k) are accepted (and, converted to 48k, pathed to the digital TV out), all other signals will be muted.

**Q AC Power Cord Socket:** Connect the AC Power Cord to this jack when the installation is completed.

**R HDMI 1 Input:** Connect any high definition video device that has a 1080p output to this input.

**S HDMI 2 Input:** Connect any high definition video device that has a 1080p output to this input.

**T Remote IR Input:** If you intend to point your remote control at the Source/DVD unit to control your complete system, connect one end of the supplied, combined HDMI/coaxial digital/remote cable to this input and the other end to the Remote IR Output on the Source/DVD unit.

**U Remote IR Output:** If you intend to point your remote control at the TV to control your complete system, connect one end of the supplied, combined HDMI/coaxial digital/remote cable to this Output and the other end to the Remote IR Input on the Source/DVD unit.

**V Optical Digital Audio 1 Input:** Connect any source with an Optical Digital Output for Audio to this input. The digital signal is transmitted to the Source/DVD unit via the Coaxial Digital Audio/TV Output **H** on the TV.

**W Coaxial Digital Audio 2 Input:** Connect any source with a Coaxial Digital Output for Audio to this input. The digital signal is transmitted to the Source/DVD unit via the Coaxial Digital Audio/TV Output **H** on the TV.

**X Coaxial Digital Audio 3 Input:** Connect any source with a Coaxial Digital Output for Audio to this input. The digital signal is transmitted to the Source/DVD unit via the Coaxial Digital Audio/TV Output **H** on the TV.

**Y HDMI 3 Input (Side of TV):** Connect any high definition video device that has a 720p or 1080i output to this input.

**Z DVB-T Antenna Input:** Connect your DVB-T roof antenna or indoors antenna to this input.

# Remote Control

- 1 System On/Source Selection Button
- 2 Power Off Button
- 3 Subtitle Button
- 4 Title Button
- 5 Angle Button
- 6 Audio Button
- 7 Enter Button
- 8 Eject Button
- 9 Set-Up/Button
- 10 Arrows Button
- 11 Mute Button
- 12 Disc Menu/Teletext Button
- 13 Pause Button
- 14 Status/Mix/EPG Button
- 15 Skip/Step (Previous) Button
- 16 Skip/Step (Next) Button
- 17 Play Button
- 18 Search/Slow Reverse Button
- 19 STOP Button
- 20 Search/Slow Forward Button
- 21 Audio System On/Source Selection Button
- 22 Presets - Button
- 23 Zoom Button
- 24 Playlist Button
- 25 Random Button
- 26 Learn Button
- 27 Volume up/down Button
- 28 Light Button
- 29 Numeric Key Buttons
- 30 Repeat Button
- 31 Clear Button
- 32 OSD Button
- 33 IR Transmitter Window
- 34 Aspect Button
- 35 Screen Power Buttons
- 36 Info Button
- 37 Teletext Buttons
- 38 Picture in Picture Button
- 39 Mode button

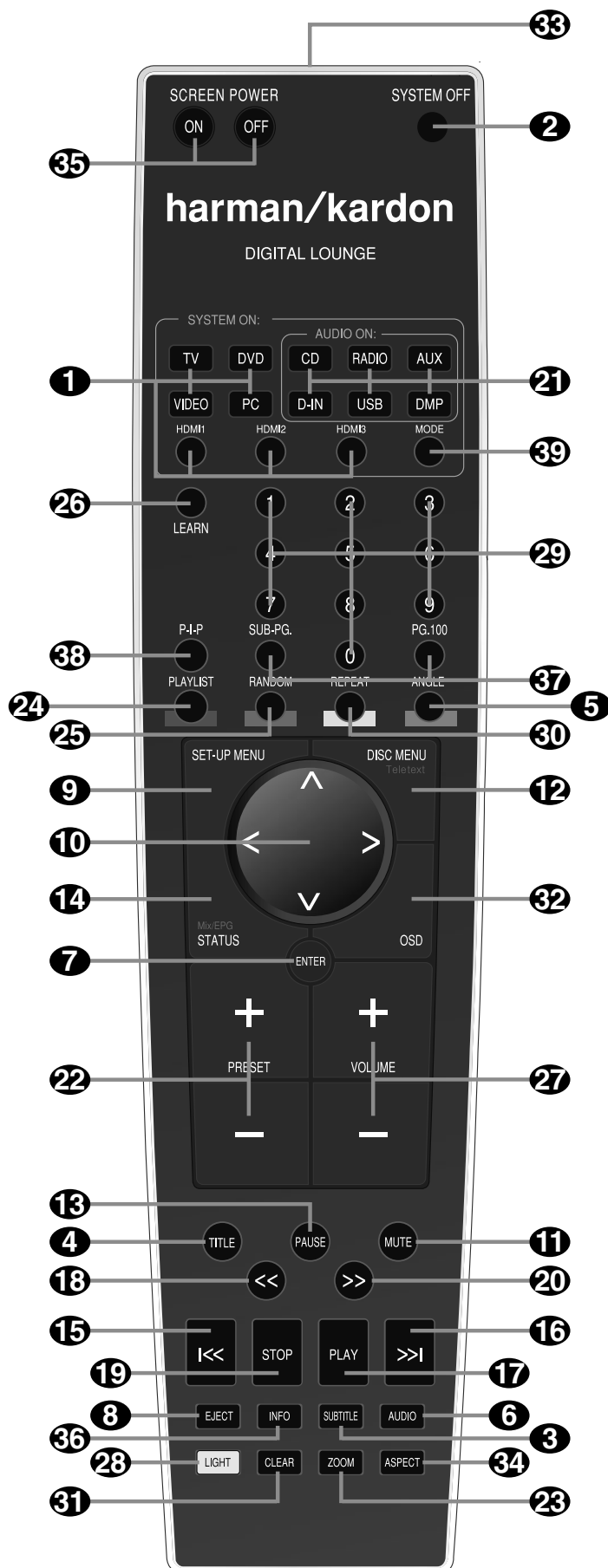

## Remote Control

### 1 System/Source Selection Buttons:

Pressing one of these buttons will perform three actions at the same time for those sources that require the display to be switched on. First, if the System is not turned on, this will power up the system. Next, "DVD" will select the player as source, the other buttons will select TV IN as source on the receiver while the screen will always turn to the last input selected. If the system is on already TV will select the TV tuner as screen source, DVD the HDMI input, VIDEO will toggle through all analog inputs of the screen and PC will toggle through the RGB-DVI or the digital DVI input. Finally pressing one of these buttons will change the remote control so that it controls the device selected (TV, VIDEO and PC the screen, the others the receiver).

**2 Power Off Button:** Turns off the system to standby mode.

**3 Subtitle Button:** When a DVD is playing, press to select a subtitle language or to turn subtitles off.

**4 Title Button:** When a disc is playing, press to make the player go back to the first section of the disc.

**5 Angle Button:** Press to access various camera angles on a DVD (If the DVD contains multiple camera angles) or to rotate JPEG images.

**6 Audio Button:** Press to access various audio languages on a DVD (If the DVD contains multiple audio streams).

**7 Enter Button:** Press this button to activate a setting or option.

**8 Eject Button:** Press to release the disc from the loader.

**9 Set-up:** This button has several functions. In TV mode (press the TV Button 1 prior to pressing the Set-up Button) it gives access to TV Set-up menu, in which the picture calibration settings of each individual input can be set. In any other mode (press any of the other source selection buttons 1 or 21 prior to the Set-up Button) it will access the Set-up menu of the DVD receiver. Press to access the On Screen Display Menu.

**10 Arrow (◀/▶/▲/▼) Buttons:** Use to move the cursor in the OSD.

**11 Mute Button:** Mutes the sound.

**12 Disc Menu/Teletext Button:** Displays the actual DVD Disc Menu on the TV screen in play mode. When playing discs with JPEG images, pressing this button will access the thumbnails. In TV mode, pressing this button will activate the Teletext function, pressing it a second time will add the TV program in splitscreen form.

When only the Teletext is visible pressing the **STATUS/MIX/EPG** button 14 will mix the Teletext and the TV program.

**13 Pause Button:** Freezes a picture (with DVD/VCD) and pauses the playback signal (CD) when a disc is playing. Press again for normal playback.

**14 Status/Mix/EPG Button:** Press while a disc is playing to view banner display. Use the ARROW buttons to move through the different features in the Banner Display. When a symbol is highlighted, press ENTER on the remote to select it. In DVB-T TV mode pressing this button calls up the Electronic Program Guide (EPG), which lists future programming for the day or week, (depending on the country in which you live and the station). In analog TV mode pressing this button blends the teletext information with the TV picture.

**15 Skip/Step (Previous) Button:** Press to go to beginning of current track. Press again quickly to go to beginning of previous track. After pressing the PAUSE button, each press of this button will move the image in reverse frame by frame.

**16 Skip/Step (Next) Button:** Press to go to beginning of next track. After pressing the PAUSE button, each press of this button will move the image forwards frame by frame.

**17 Play Button:** Begins to play disc (closes disc tray first, if it is open).

**18 Search/Slow (Rev.) Button:** Allows you to search in reverse through a disc while it is in play mode. Each time you press this button, the search speed changes as indicated by a number of arrows on the right top of your screen. After pressing the PAUSE button, each press of this button will change the slow down speed indicated by a number of arrows in the right top of the screen.

**19 Stop Button:** Stops playing a disc. When a disc is playing, if you press STOP and PLAY, the disc will resume play, i.e. it will start from the same point on the disc where the unit was stopped. If you press STOP twice and the PLAY button, the disc will start play from the beginning.

**20 Search/Slow (Fwd.) Button:** Allows you to search forward through a disc while it is in play mode. Each time you press this button, the search speed changes as indicated by a number of arrows on the right top of your screen. After pressing the PAUSE button, each press of this button will change the slow down speed as indicated by a number of arrows in the right top of the screen.

### 21 Audio System On/Source Selection

**Buttons:** Pressing one of these buttons will perform three actions at the same time for sources that do NOT necessarily require the screen to be switched on. First, if the System is not turned on, this will power up the system without the screen. Next, it will select the source shown on the button as the input to the system. Finally, it will change the remote control so that it controls the device selected. With audio-only sources, the screen can be temporarily switched on or off with the Screen Power Buttons 35.

**22 Presets Buttons:** Pressing these buttons in JPEG mode will move to the previous or next image.

In TV mode these buttons will scroll through the available preset TV stations. With DivX movies these buttons will jump forward or backward for 10 minutes.

**23 Zoom Button:** When a DVD or VCD is playing, press this button to zoom the picture so that it is enlarged. There are 4 steps to the zoom function, each progressively larger. Press through each of the zoom stages to return to a normal picture. The Zoom function is not available when watching High Definition material.

**24 Playlist Button:** Press this button to change the playback order of the disc.

**25 Random Button:** Press for RANDOM playback in random order.

**26 Learn Button:** Press this button to begin the process of "learning" the codes from another product's remote into the Digital Lounge System's remote. (See page 44 for more information on using the remote's learning function.)

**27 Volume Up/Down:** Increase/decrease the master volume level.

**28 LIGHT Button:** Press to illuminate remote controller.

**29 Numeric Key Buttons:** Select numbers by pressing these buttons.

**30 Repeat Button:** Press to go to the Repeat menu. You can repeat a chapter, track or the entire disc.

**31 Clear Button:** Press to remove the Banner menu from the screen.

**32 OSD Button:** This button has several functions. In TV mode (press the TV Button 1 prior to pressing the Set-up Button) it gives access to TV OSD menu, in which the video input selection can be made. In any other mode (press any of the other source selection buttons 1 or 21 prior to the Set-up Button) it will access the OSD menu of the DVD receiver.

## Remote Control

**33 IR Transmitter Window:** Point this window towards the Digital Lounge system when pressing buttons on the remote to make certain that infrared commands are properly received.

**34 Aspect Button:** Press this button to scroll through the available screen formats. The default setting is Fill All.

**35 Screen Power Buttons:** Use these buttons to temporarily switch on or off the screen when listening to audio-only sources. This could be helpful for instance for scrolling through the contents of MP3 discs or portable hard disk devices.

**36 INFO:** Press for detailed informations on the disc playing (Video/Audio Bit rate, Movie aspect ratio and others), and for current player settings made. Press again to remove information from screen.

**37 Teletext Buttons:** Press these buttons with Teletext activated (by button 12) to select the different Teletext functions. Pressing the 100-Button will always call up the main Teletext page. Pressing the Sub Page Button consecutively will scroll through the available sub pages of a page.

**38 Picture in Picture Button:** Press this button once to activate the Picture in Picture function. Press it again to activate the picture out of picture function (split screen).

**Note:** When Picture in Picture is activated the main picture can be selected by the **numeric buttons 29** (when TV tuner is source) and the secondary picture by the **PRESET Buttons 22** while pressing the PC or VIDEO button will toggle through all available PC and Video sources as secondary picture.

**39 Mode Button:** This button enables you to switch the remote to another mode so that it operates another device without selecting it as the source. Each press of the Mode button changes the remote's mode in this order: TV, DVD, VIDEO, PC, HDMI 1, HDMI 2 and HDMI 3. And then back to TV again. The corresponding Source Selector will light to indicate the mode.

**Important Note:** When toggling through the resolution modes by pressing this button repeatedly be sure to have your screen connected via HDMI or Component cable, otherwise you will not see a picture with the progressive or the HD modes. Note that via HDMI the Standard interlaced signals (480/576i) will not appear.

### Important notes.

The large system remote control contains several buttons that have more than one function. The Set-up Button **9** is a good example. It can both access the set-up menu of the TV and the set-up menu of the DVD receiver. The final function of the button depends on the button pressed prior to pressing the Set-up Button. Pressing the TV, VIDEO or PC Source Selector Button **1** before the Set-up Button will access the TV Set-up Menu. Pressing any of the other Source Selector Buttons **1 21** will access the Set-up Menu of the DVD receiver.

There are two ways to switch on the system. For those sources that require the screen to be switched on (TV, DVD, VIDEO or PC), pressing one of the System On/Source Selector Buttons **1** will power on the complete system.

For those sources that do not necessarily require the screen to be switched on (CD, RADIO, AUX, D-IN, USB 1 and USB 2) pressing one of the Audio System On/Source Selector Buttons **21** will power on the DVD receiver and the speakers, but will leave the screen in stand by mode. In this mode the screen can be switched on and off temporarily by pressing the Screen Power On or Off Buttons **35**.

For correct functioning of the remote control, it is important NOT to switch on or off the DVD receiver with the front panel Power On/Off switch, but only to use the remote control's System On **1 21** and System Off **2** Buttons.



## Second Remote Control

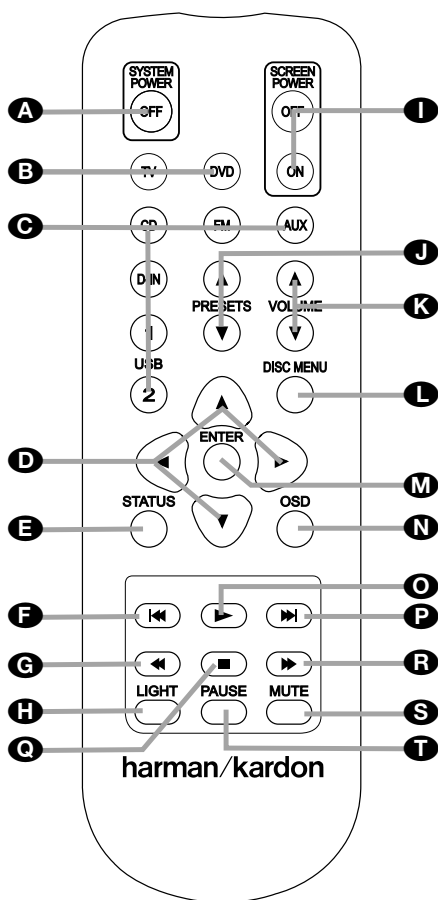

- A** Power Off Button
- B** System On/Source Selector Buttons
- C** Audio System On/Source Selection Buttons
- D** Arrow Buttons
- E** Status Button
- F** Skip/Step (Previous) Button
- G** Search/Slow Reverse Button
- H** Light Button
- I** Screen Power Buttons
- J** Presets Buttons
- K** Volume Buttons
- L** Disc Menu Button
- M** Enter Button
- N** OSD Button
- O** Play Button
- P** Skip/Step (Next) Button
- Q** Stop Button
- R** Search/Slow Forward Button
- S** Mute Button
- T** Pause Button

**A Power Off Button:** Turns off the DL system to standby mode.

**B System/Source Selection Buttons:** Pressing one of these buttons will perform three actions at the same time for those sources that require the display to be switched on. First, if the System is not turned on, this will power up the system. Next on the receiver, it will select the source shown on the button as the input while the screen will always turn on to the last source selected. Finally, it will change the remote control so that it controls the device selected.

**C Audio System On/Source Selection Buttons:** Pressing one of these buttons will perform three actions at the same time for sources that NOT necessarily require the screen to be switched on. First, if the System is not turned on, this will power up the system without the screen. Next, it will select the source shown on the button as the input to the system. Finally, it will change the remote control so that it controls the device selected. With audio-only sources, the screen can be temporarily switched on or off with the Screen Power Buttons **I**.

**D Arrow buttons (◀/▶/▲/▼) Buttons:** Use to move the cursor in the OSD.

**E Status Button:** Press while a disc is playing to view banner display. Use the ARROW buttons to move through the different features in the Banner Display. When a symbol is highlighted, press ENTER on the remote to select it.

**F Skip/Step (Previous) Button:** Press to go to beginning of current track. Press again quickly to go to beginning of previous track. After pressing the PAUSE button, each press of this button will move the image in reverse frame by frame.

**G Search/Slow Reverse Button:** Allows you to search in reverse through a disc while it is in play mode. Each time you press this button, the search speed changes as indicated by a number of arrows on the right top of your screen. After pressing the PAUSE button, each press of this button will change the slow down speed indicated by a number of arrows in the right top of the screen.

**H LIGHT Button:** Press to illuminate remote controller.

**I Screen Power Buttons:** Use these buttons to temporarily switch on or off the screen when listening to audio-only sources. This could be helpful for instance for scrolling through the contents of MP3 discs or portable hard disk devices.

**J PRESETS-Buttons:** Pressing these buttons in JPEG mode will move to the previous or next image. In TV mode these buttons will scroll through the available preset TV stations. With DivX movies these buttons will jump forward or backward for 10 minutes.

**K Volume Buttons:** Increase/decrease the master volume level.

**L Disc Menu Button:** Displays the actual DVD Disc Menu on the TV screen in play mode. When playing discs with JPEG images, pressing this button will access the thumbnails.

**M Enter Button:** Press this button to activate a setting or option.

**N OSD Button:** Press to access the On Screen Display Menu.

**O Play Button:** Begins to play disc (closes disc tray first, if it is open).

**P Skip/Step (Next) Button:** Press to go to beginning of next track. After pressing the PAUSE button, each press of this button will move the image forwards frame by frame.

**Q Stop Button:** Stops playing a disc. When a disc is playing, if you press STOP and PLAY, the disc will resume play, i.e. it will start from the same point on the disc where the unit was stopped. If you press STOP twice and the PLAY button, the disc will start play from the beginning.

**R Search/Slow Forward Button:** Allows you to search forward through a disc while it is in play mode. Each time you press this button, the search speed changes as indicated by a number of arrows on the right top of your screen. After pressing the PAUSE button, each press of this button will change the slow down speed as indicated by a number of arrows in the right top of the screen.

**S Mute Button:** Mutes the sound.

**T Pause Button:** Freezes a picture (with DVD/VCD) and pauses the playback signal (CD) when a disc is playing. Press again for normal playback.

## Basic Information

### About This Manual

- The types of functions and operations that can be used for a particular disc vary depending on the features of that disc. In some cases, these functions and operations may differ from the descriptions given in this manual. In this event, follow the instructions given on the screen. This manual only covers basic disc operations.
- For some operations, the  icon may appear on the screen. This indicates that the operation described in this manual is not available on the disc in the player.
- On-screen and front panel display illustrations in this manual are purely for the purposes of explanation. The actual displays may differ slightly from these illustrations.

### Disc handling precautions

- To keep the disc clean, handle the disc by its edge. Do not touch the surface.
- Do not stick paper or tape on the disc. If there is glue (or a similar substance) on the disc, remove the glue completely before using the disc.



- Do not expose the disc to direct sunlight or sources such as hot air ducts, or leave it in a car parked in direct sunlight as there can be a considerable rise in temperature inside the car.
- After playing, store the disc in its case.
- Do not write on the label side with a ball-point pen or other writing utensils.
- Be careful not to drop or bend the disc.

### Disc cleaning precautions

- Before playing, clean the disc with a cleaning cloth. Wipe the disc from the center out.
- Do not use solvents such as benzene, thinner, commercially available cleaners or anti-static spray intended for vinyl LPs.

### Disc installing precautions

- Do not install more than 1 disc on disc tray.
- Do not place the disc on the tray up-side down.
- Do not try to close the disc tray when the disc is not installed and centered properly.

### Regional Coding

DVD players and discs are designed with regional restrictions which dictate the regions in which a disc can be played. If the region number on the disc you want to play does not match the region number of your DVD player, you will not be able to play the disc. The message "REGION ERR" will appear in the front panel display. The region code of this player is indicated on the rear and on the external packaging.

### Important basic principles for use

The LCD meets the highest quality requirements and has been checked for pixel defects. Despite taking the greatest care during production of these units, for technological reasons it cannot be excluded absolutely that there are some pixels with defects.

We request your understanding for the fact that such defects, provided that they are within the limits specified by the standard, cannot be considered to be as an appliance defect in the terms of the warranty.

If used for a long period of time as a PC screen, shadows can occur on the screen as with any other TV set. This phenomenon with LCD screens can be reduced by heeding the following points:

- do not display a still picture for a long period of time
- use your display in full screen format (16:9)
- activate the screen saver
- display moving images as far as possible
- always switch off the display when it is not being used
- reduce the contrast and brightness as much as possible.

Unfavourable conditions can cause your screen to hum. The humming generally comes from the mains voltage supply and can occur through the connection of different earth conductors. You can provide a remedy by putting a so-called sheath current filter between the incoming aerial lead and the aerial input socket on the display. Sheath-type current filters are offered in the form of a small adaptor plug in the retail trade.

If your display is connected to an external aerial, the latter must be earthed as protection against electric shocks and static charging. The earthing must comply with the valid regulations.

If using it as a PC screen, we recommend for ergonomic reasons that you avoid the use of red and blue fonts or symbols against dark backgrounds.

To avoid aching eyes and obtain an optimized viewing distance, the distance from the unit should be five to six times the display's diagonal dimension. In your television room it should be so light that you could also read. Too little light strains the eyes due to the alternation between light and dark on the display.

### Cleaning the Screen

Before you start any cleaning, turn off the unit and disconnect the mains plug from the plug outlet.

#### Cleaning the screen

The Harman Kardon Digital Lounge screens come with a special cleaning kit that allows for proper cleaning without damaging the screen or its high gloss finish. Use the mild detergent and soft cloth only. Do not use any abrasives!

#### Cleaning the housing

The cleaning kit can also be used to clean the housing of the screen.

Do not use any chemical solvents or cleaning agents for cleaning the housing, otherwise the surface of the unit could get damaged.

If you clean the surface of the housing with a wet cloth, drops of water can get inside the unit, which will cause malfunctions. Use a vacuum cleaner with a soft brush attachment for cleaning the ventilating openings.

# Installation and Connections

## Important Note

Please open the Harman Kardon Digital Lounge Accessory Tool Kit before opening any of the other system components. The Kit contains two pairs of gloves, that can be used to unpack the LCD screen without damaging its frame nor leaving fingerprints on it.

After unpacking the different system components, and placing them on a solid surface capable of supporting their weight, you will need to make the connections to your audio and video equipment.

## Equipment Connections

We recommend that you use the supplied cables when making connections to source equipment and high quality interconnect cables to additional equipment to preserve the integrity of the signals.

When making connections to audio source equipment or speakers it is always a good practice to unplug the units from the AC wall outlet. This prevents any possibility of accidentally sending audio or transient signals to the speakers that may damage them.

Making the necessary connections to the Digital Lounge system is done in five easy steps.

1. Connect the front, center and surround speaker outputs **12****13****14** to the respective speakers.

Cables that are run inside walls should have the appropriate markings to indicate listing with any appropriate testing agency standards. Questions about running cables inside walls should be referred to your installer or a licensed electrician who is familiar with the applicable local building codes in your area.

When connecting wires to the speakers, be certain to observe proper polarity. Note that the positive (+) terminal of each speaker connection now carries a specific color code. However, most speakers will still use a red terminal for the positive (+) connection. Connect the "negative" or "black" wire to the same terminal on both the receiver and the speaker.

We also recommend that the length of cable used to connect speaker pairs be identical. For example, use the same length piece of cable to connect the front-left and front-right or surround-left and surround-right speakers, even if the speakers are a different distance from the Digital Lounge system controller.

2. Connections to the subwoofer are made via a line level audio connection from the **Subwoofer Output 8** to the line-level SUB input (purple) of the subwoofer. Connect at the same time the **Subwoofer Trigger Output 16** to the Trigger Input of the subwoofer.

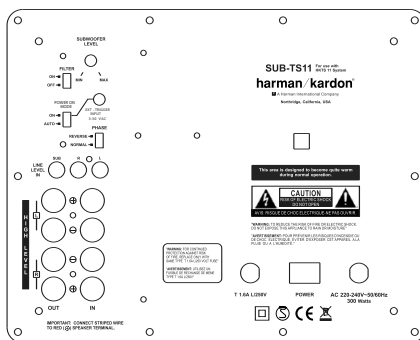

3. Connect the supplied FM antenna to the **FM (75 ohm) connection 6**. The FM antenna may be an external roof antenna, an inside powered or wire lead antenna or a connection from a cable system. Note that if the antenna or connection uses 300-ohm twin-lead cable, you should use a 300-ohm-to-75-ohm adapter to make the connection.

4. Your system comes with an combined HDMI/SP-DIF/Remote in/out cable to make a digital video connection over HDMI and digital audio connection from the TV to the DVD receiver. Connect the HDMI connector on one end of the wire to the HDMI Output **1** of the receiver and the other end to the HDMI Input **1** of the screen. Connect the Coaxial Digital connector on one end of the cable to the Coaxial Digital Input **9** of the receiver and the other end to the Coaxial Digital Output **11** of the screen. Connect one end of the remote connector (the single pin connector) to the Remote Input of the screen and the other end to the Remote Input of the DVD Receiver. Please note that you may run the remote signal both ways. If you decide that it is easiest for you to control both screen and receiver by pointing the remote control towards the screen, plug the remote cable into the Remote Control Out of the screen and into the Remote Control In of the receiver. If your setup makes it more practical to aim the remote at the receiver to control both receiver and screen, plug the remote cable into the Remote Control Out of the receiver and into the Remote Control In of the screen.

5. If you use a standard analog TV antenna, connect to the Antenna Input **10** on the rear panel of the screen. In case you use a DVB-T antenna, connect that one to the DVB-T Input **2** on the rear panel of the screen.

All necessary connections are now made. If you have additional source components to add, please refer to the next paragraphs. If not, please continue with the next chapter of the manual.

## Optional Analog Set Top or Cable Box Connections

If you do not use an aerial antenna but a set top box or cable box to watch TV, please follow the instructions below to connect these products.

### SCART

If you decide to connect your set top or cable box to your system using a Scart cable, connect the Scart output of the set top or cable box to one of the Scart Inputs **7** on the rear panel of the screen.

### YUV/Component

If you decide to connect your set top or cable box to your system using a YUV or Component cable, connect the YUV outputs of the set top or cable box to the YUV Inputs **5** on the rear panel of the screen. At the same time connect the analog audio outputs of the box to the Audio Input for Component Video Jacks **3** on the rear panel of the screen, or the digital output of the box to the Coaxial Digital Input **9**.

### S-Video

If you decide to connect your set top or cable box to your system using an S-Video cable, connect the S-Video output of the set top or cable box to the S-Video Input **11** on the rear panel of the screen. At the same time connect the analog audio outputs of the box to the Audio Input for S-Video Jacks **11** on the rear panel of the screen, or the digital output of the box to the Coaxial Digital Input **9**.

### Composite

If you decide to connect your set top or cable box to your system using a Composite cable, connect the Composite output of the set top or cable box to the Composite/CVBS Input **5** on the rear panel of the screen. At the same time connect the analog audio outputs of the box to the Audio Input for Component Video Jacks **3** on the rear panel of the screen, or the digital output of the box to the Coaxial Digital Input **9**.

**Important Note:** The **Coaxial Digital Input 9** of the screen will accept only 2-channel PCM signals (see item **9** on page 13). To listen to the multichannel sound from an optical digital output of any external source you can connect it to the **Optical Input 10** of the unit, see next page. If your source has only a Coaxial Digital output disconnect the SPDIF cable on the screen (**output 11**) and the unit (**input 9**), connect the screen via the analog audio cable to the unit (**Audio Output 8** on screen to the **TV Audio Input 17** on the unit). Then connect the coaxial digital output of your source to the **Coaxial Digital Input 9** of the unit.

# Installation and Connections

## Connecting a PC

If you wish to connect your PC to the screen, the best way is to connect the DVI output of the computer to the DVI Input **(K)** on the rear panel of the screen. At the same time connect the audio output of your computer to the PC Audio Input **(1)** on the rear panel of the screen. If your PC does not have a DVI output, but VGA only, use an adapter cable VGA->DVI to connect your PC to the DVI input of the screen. If the graphic card of your PC has also other video outputs, please use any of the available outputs of your computer to the matching input of the screen.

## Connecting a Digital Set Top Box or Satellite Receiver

If you wish to connect your digital set top box or satellite receiver to the screen, the best way is to connect the HDMI output of the satellite receiver to any of the HDMI 1 or HDMI 2 **(R/S)** on the rear panel of the screen. Both inputs are capable of accepting up to 1080p signals.

## Optional Audio Connections

### Aux Input for External Source

You may connect a line-level stereo analog audio source such as a Sat receiver, tape deck, phono pre-amp of a record player, etc. to the controller's rear panel AUDIO IN Input **(7)** sockets to enjoy the benefits of your system with other source components.

- VCR Connection-Audio (Cables Not Included). To listen to the sound from your stereo VCR through the speakers of this system, connect the Left/Right audio output jacks of your stereo VCR to the Left/Right audio input jacks AUDIO IN **(7)** of this system.

### Aux Output for Recording

To record the sound of the system with your VCR or any audio recording device (tape deck, MD, CDR and some others.) the Audio Out jacks **(1)** should be connected to the analog Record In jacks of the appropriate device.

### Digital In- and Outputs

Connect the optical digital output of any digital sources such as an optional CD or DVD changer or player, advanced video game, a digital satellite receiver, HDTV tuner or digital cable set-top box or the output of a compatible computer sound card to the **Optical Digital Inputs** 1, 2 or 3 **(P/X/W/D)**. The Coaxial Digital output of those devices may be connected with the **Coaxial Digital input** **(P)** on the screen, (for PCM only) or the **Coaxial Digital Input** **(S)** on the unit (for all formats), see page 19. Connect the **Coaxial Digital Output** **(15)** on the rear panel of the Digital Lounge system to the matching digital input connections on a CD-R or MiniDisc recorder.

**Note:** When connecting the optical digital audio cable (optional).

- Gently push the cable plug through the built-in shutter that covers the optical digital audio output and connect the cable firmly so that the configurations of both the cable and the connector match.

## Speaker Placement

The placement of speakers in a multichannel home-theater system can have a noticeable impact on the quality of sound reproduced. If you use the screen with the supplied table stand, place the center loudspeaker in the designated place between the two feet of the stand. Install the speaker from behind, and push it gently forward until it can not go any further. If you do not wish to use the supplied table stand, place the center speaker either directly above or below your TV. A wall bracket is supplied for the Center Speaker for this purpose. Once the center-channel speaker is installed, position the left-front and right-front speakers so that they are as far away from one another as the center-channel speaker is from the preferred listening position. Ideally, the front-channel speakers should be placed so that their tweeters are no more than 60cm above or below the tweeter in the center-channel speaker. Depending on the specifics of your room acoustics, you may find that imaging is improved by moving the front-left and front-right speakers slightly forward of the center-channel speaker. If possible, adjust all front loudspeakers so that they are aimed at ear height when you are seated in the listening position.

Using these guidelines, you'll find that it takes some experimentation to find the correct location for the front speakers in your particular installation. Don't be afraid to move things around until the system sounds correct. Optimize your speakers so that audio transitions across the front of the room sound smooth.

The preferred location for surround speakers is on the side walls of the room, at or slightly behind the listening position.

Rear surround speakers may also be used in 5.1 channel mode as an alternative mounting position when it is not practical to place the main surround speakers at the sides of the room. Speakers may be placed on a rear wall, behind the listening position. As with the side speakers, the center of the rear surrounds should face you. The speakers should be no more than 2 meters behind the rear of the seating area.

The supplied pair of loudspeaker stands can be used to either place the front- or rear loudspeakers. Follow the instructions in the manual of the stands for proper installation of the loudspeakers on the stands.

Subwoofers produce largely nondirectional sound, so they may be placed almost anywhere in a room. Actual placement should be based on room size.

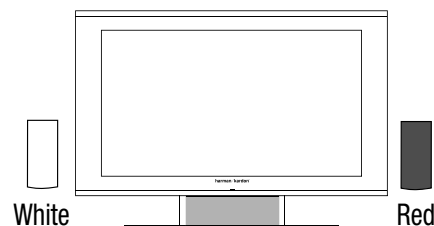

A) Front Channel Speaker Installation with table stand

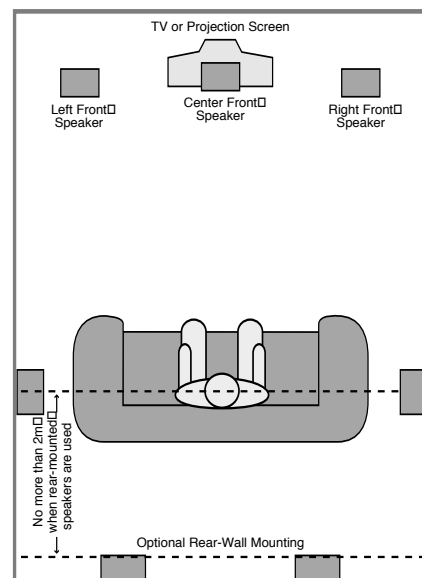

B) The distance between the left and right speakers should be equal to the distance from the seating position to the viewing screen. You may also experiment with placing the left and right speakers slightly forward of the center speaker. Rear speaker mounting is an alternate location for 5.1 systems.

One method of finding the optimal location for a subwoofer is to begin by placing it in the front of the room, about 15cm from a wall, or near the front corner of the room. Another method is to temporarily place the subwoofer in the spot where you will normally sit, and then walk around the room until you find a spot where the subwoofer sounds best. Place the subwoofer in that spot.

## Screen Placement

**Note:** Please use the supplied pair of gloves found in the Tool Kit when placing the screen. This will prevent the high gloss finish of the screen to be scratched or damaged. The screen comes delivered with an integrated stand, that has a dedicated place for the system's center loudspeaker. Place the screen and the stand on a surface that is strong enough to support its weight.

You can also opt for hanging the screen on the wall. Note that the screen should be mounted on vertical walls only that are capable of bearing three times the weight of the screen (see page 50 for the weight of your screen). We recommend you to do the mounting with two people. Before installing the screen on the wall, make sure that it is switched off and that the mains cable and signal cables are unplugged. Protect the front of the screen using the cloth bag and turn the screen so that its front is pointing downwards and place it carefully on a completely flat and firm surface.

Loosen and remove the 8 screws (M4x5) in the stand. Please keep the screws in a safe place in case you would like to re-install the screen on the stand in the future.

Look at the attached drilling template in the accessory pack to determine the appropriate distance between the two holes in the wall for your individual display size.

Fit two plugs and hooks capable of carrying three times the weight of the screen in the wall and position the screen so that the hooks can be introduced into the openings provided for this purpose on the rear side of the screen.

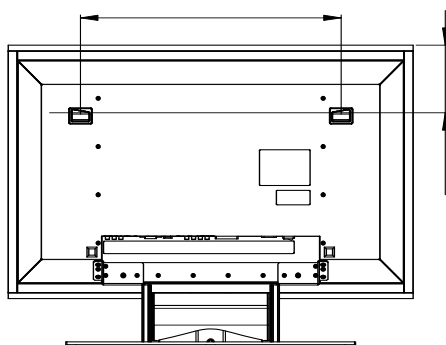
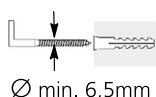

## Connecting the AC Power

### Notes

- The Power Requirement is: AC 230V, 50 Hz.
- Connecting to power other than the one listed above may damage the system or cause abnormal operation.
- Before connecting the AC power cord of this system to a wall outlet, connect the speakers and other component cables to the system.
- Connect the AC power cord of the active subwoofer.
- Connect the AC power cords of your TV and any optional components to a wall outlet.

Once the speakers have been placed in the room and connected, the remaining steps are to program the system configuration memories.

### First Turn On

You are now ready to power up the system to begin final adjustments.

1. Plug the **Power Cable 5** of the DVD receiver and TV into an unswitched AC outlet. Press the Power On Switch **6** to the "I" position to switch on the TV to Standby mode. Note that the **Power Indicator 2** and the Power Indicator on the screen will turn orange, indicating that system unit is in the Standby mode. At the same time, plug the power cord of the subwoofer into an unswitched AC outlet.
2. Remove the protective plastic film from the main front-panel lens of the DVD receiver. If left in place, the film may affect the performance of your remote control.
3. Install the four supplied AAA batteries in the main remote as shown. Be certain to follow the (+) and (-) polarity indicators that are on the top of the battery compartment. Follow the same instructions to install the three supplied AAA batteries into the smaller second remote control.
4. Turn the system on by pressing the **TV Input Source Selector 1** on the remote control. The **Power Indicator 2** and the Power Indicator of the screen will turn blue to confirm that the system is on, and the **Main Information Display 1** will also light up.

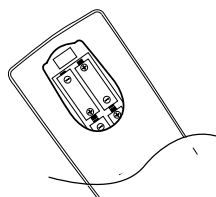

# Playback Basics

## Automatic Channel Search

The first step after switching on your system is to set the language you prefer and the country you reside in. Once that is done, the automatic TV channel search will start.

### Setting the language

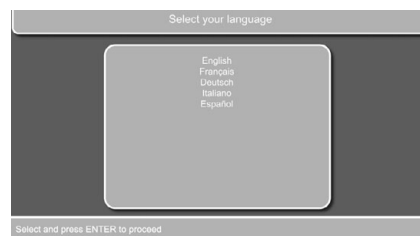

Figure 1a

- The first screen you will see is the Language Selection screen. Use the [▼] or [▲] Buttons **10** to select the language you prefer to see the menu's of the TV in. Press the Enter Button **7** to confirm.

### Selection of country for the sorting sequence

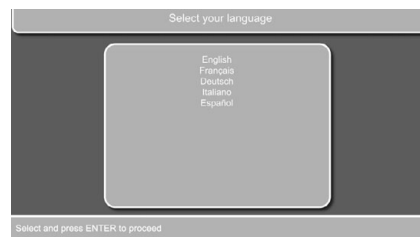

Figure 1b

- Once you have selected the menu language, the next screen allows you to select the country in which the TV will be operated. Use the [▼] or [▲] Buttons **10** to select your country.

### Selection of tuner type

You will now be asked to choose between analog or digital tuner.

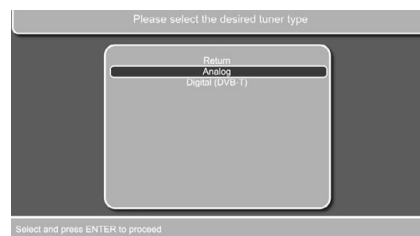

Figure 1c

Depending on your choice of tuner type, select either "Analog" or "Digital (DVB-T)" by using the ▼/▲ Buttons **10**. Press the Enter Button **7** to confirm.

If you select the analog tuner, proceed as described immediately below. If you select the digital tuner, go to the DIGITAL TUNER (DVB-T) section further down.

## Playback Basics

### For analog tuner: proceed as follows:

When you press the Enter Button **7** to confirm, the automatic channel search will start to scan the available TV channels. The automatic search can take several minutes, depending on the number of channels that are available.

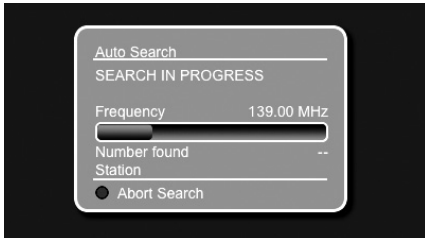

Figure 1d

- Should you wish to abort the automatic channel search, please press the Red Button **24** on your remote control.

If no TV channel is found, check the aerial connections and attempt to search for the channels again.

When the automatic search is finished, the Edit Channel List Menu will show on your screen. It will show all the TV channels found indicated by a name consisting of a maximum of 5 characters. This menu allows you to sort the TV channels according to your preferences. Move the blue bar by pressing the **▼** Button until the TV channel you would like to move is highlighted by the blue bar. Press the Enter Button **7** so that the bar turns white. You can now move it up, down, left or right with the **▲/▼/◀/▶** Buttons **10** until it is at the requested preset. Press the Enter Button **7** to confirm. The white bar will turn blue to confirm. Continue with all the other channels until each preset contains your preferred TV channel.

The menu also allows you to delete TV channels from your channel list. Move the blue bar to the TV channel to be deleted using the **▲/▼** Buttons **10**. Press the Green Button **25** to delete the TV channel.

When you are done making changes to the Channel List, press the Red Button **24** to remove the list from the screen.

### Digital Tuner

If you have selected the digital tuner (DVB-T), proceed as described below.

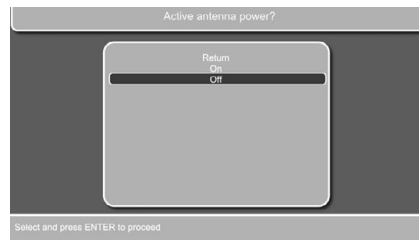

Figure 1e

You will now be asked whether you use an actively powered antenna. Select either "On" or "Off" by using the **▲/▼** Buttons **10**.

The following automatic search screen will show:

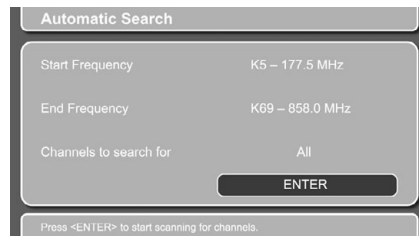

Figure 1f

Press "Enter" to start the scanning process. Scanning may take several minutes, and you will see a status screen keeping you updated as to how many percent of the scanning has been performed. You can interrupt the scanning at any time by pressing the OSD button **32**. When scanning is complete, you will be asked to save the new channels, and you are informed how many channels were found.

(If no channels are found, check the antenna connection. If you have used an indoor antenna, it may be necessary to use an outdoor antenna instead. It may be a good idea to check with your TV network provider if there is DVB-T coverage in your area at all. If not, use analog tuner or cable/satellite reception instead). Press "Enter" to confirm the line "Yes, add new channels". If you want to completely replace an earlier version channel list, press the **▶** button to select "Yes, replace old channel list" and confirm with the "Enter" Button. If you do not want to save any new channels, press the **▶** Button to select "No, discard new channels" and confirm with the "Enter" Button. After confirming, the following screen will show:

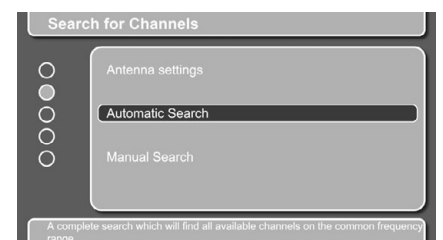

Figure 1g

Press the Setup Button button **9** to close the Search for Channels menu and start watching TV.

Remember that once inside the menu system, you simply press the "OSD" (On Screen Display) button to return to the previous screen and the "Setup Menu" button to exit the menu system entirely.

If you want to change additional settings in the DVB-T menu, like sorting channels, watch technical information or set security settings, press the OSD Button **32** once to go back one level, followed by the **▲/▼** Button **10** to select the menu you want (when coming directly from the Channel Search function).

If you want to change settings for the DVB-T tuner when watching TV, press the "Set-Up Menu" button **9** to enter the Setup Menu with the TV heading showing black, press the **▼** button **10** twice to move the indicator bar down to the DVB-T Setup line and press "Enter" **7**. The screen changes to System settings, with the blue dot at the left side indicating which menu point you have chosen. The top menu line states the name of the menu item in the following order, downwards: System Settings, Search for Channels, Sort Channels, Technical Information and Security. You select the menu you want by scrolling down and up with the **▲/▼** Buttons **10**. Notice that the bottom menu line offers further explanation for the menu you have selected. Press "Enter" **7** to enter the detailed menu inside each main menu, and press "OSD" **32** to return to the previous menu. Once inside a detailed menu, you may alter various settings.

## Playback Basics

If you select Sort Channels, you will see the menu below:



Figure 1h

Press the Enter button to enter the Sort TV channels menu and the overview of the channels in the memory.

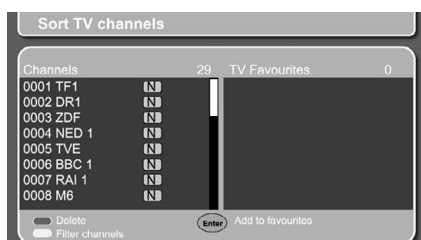

Figure 1i

The Sort TV channels menu permits you to rearrange the channels, sorting them in numerical order or alphabetically from A - Z or Z - A, even according to Network or Provider if you wish. Also, you may select channels to be your Favourites and move them to a separate Favourites list, which you can use for everyday viewing. You are also informed which channels are scrambled and therefore cannot be watched.

To delete channels, select a channel with the ▲/▼ Button 10. Delete with the Red button 24.

To filter channels, press the Yellow button 30. The Filter Channels screen will show. You may select Free to air, Scrambled or All channels for filtering, as well as the order of filtering.

You can move channels from the Channels list to the Favourites list by pressing the "Enter" button 7 after having selected the station you want to move with the ▲/▼ Buttons 10. Switch between Channels and Favourites with the Blue button 5. If you want to move a station out of the Favourites list, simply switch to this list with the Blue button, find the station with the ▲/▼ Buttons and press the Red button 24 to delete.

When watching TV, you can switch between the total channel list and your selected favorite list by pressing the Blue Button. Each press toggles from one list to the other and back, to make it easy for you to have all available channels or just the ones you prefer present for selection.

You may also choose to do a manual search if you know the frequency for a channel that you want to see.

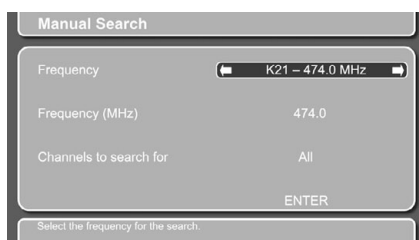

Figure 1j

In the Technical Information menu you can see details regarding the channel that you are currently watching, or the DVB-T tuner. You may update the DVB-T software via the antenna by pressing Enter to confirm the Update Software prompt. This may take several minutes, and if no new software is available, you will be informed about this.

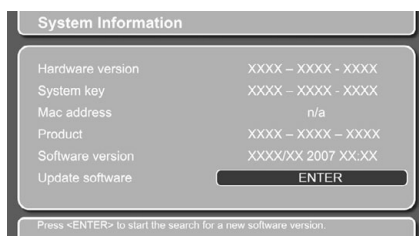

Figure 1k

The Security menu gives you the option to lock the DVB-T tuner in order to avoid children watching programs unsuited for their age. When pressing "Enter", the screen asks for a four-digit PIN code. The default code is "0000". Enter the code and press "Enter". You will see the menu lines "Parental Control" and "Change Pin". The Parental Control permits ages from 4 to 18 years to be selected, or "Off". At the time of writing, this age-based system is not in use, but plans are progressing to introduce age codes to be transmitted along with the program content, to exclude programs that are marked to be for children older than the set limit.

You may also change the PIN code. You will be asked to give the present code once, the new code once and then once more to confirm. Remember the new code.

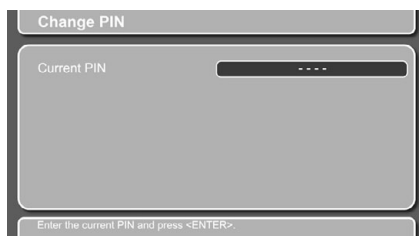

Figure 1l

The topmost menu is "System Settings", which permits you to customize the DVB-T tuner settings that you do not need to alter very often.

Entering "System Settings" shows the following screen with three setting options: Language, Menu and Miscellaneous.

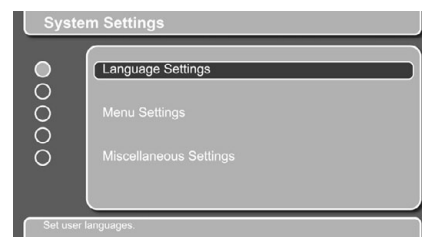

Figure 1m

**Language Settings** lets you select your first and second choices of Audio language, your first and second choices of subtitle languages and whether or not you want subtitles at all. Please note that these options are available only if the channel you watch transmits them.

**Menu Settings** lets you decide how long the Information Banners should be visible on the screen. You may select from 1 second to 15 seconds as well as Permanent and None. If you select 4 seconds or more, you may also select the Info Banner Automatic to be On or Off. This option shows an information bar when a new programme starts if selected On.

**Miscellaneous Settings** lets you choose between manual or automatic time zone adjustment. If manual is chosen, you may enter the time zone of your choice. If automatic is chosen, the tuner receives time information from the DVB-T system, including info about Summertime/Daylight Savings Time. You may also select active antenna or not, if you change the antenna to another type. Do not select Active if you are not absolutely sure that you do have an active antenna. You may switch the channel list appearance to list the channels alphabetically A-Z or Z-A, or according to provider, or to show no sorting at all.

### Basic Play

#### Preparation

- Depending on what source you would like to watch or listen to, there are two ways to switch on the system. In order to switch on the whole system, including the screen, to watch a source, press any of System On/Source Selectors 1. If you would only like to switch on the DVD receiver, for instance to simply listen to a CD, press any of the Audio System On/Source Selector Buttons 21.
- When you switch on the complete system, a Harman Kardon Digital Lounge welcome image should appear on the screen.
- If there is no picture at all, not even the Harman Kardon screen, please check whether the HDMI cable has been inserted correctly. This cable needs always to be connected before switching on the screen and the receiver.

## Playback Basics

### TV

- If the TV Source Selector Input Button **1** has been pressed to switch on the complete system, the system and the remote control are in TV mode.
- Press the Preset Up or Preset Down Buttons **22** **J** to scroll through the available channel presets.
- Press the Volume Up or Volume Down Buttons **27** **K** to increase or decrease the system's volume level.

### DVD Receiver

If any of the DVD **1** or Audio Source Selector Buttons **21** have been pressed to switch on the system (with or without screen), the system and the remote control are in receiver mode.

- Insert a disc into the Slot Loader **7**.  
Hold the disc without touching either of its surfaces, position it with the side you wish to play facing down, align it with the guides, and place it in its proper position.
  - 3" (8 cm) discs or 5" (12 cm) discs can be used.
- After the discs slides into the loader, it will start playing automatically.

### Disc Playback Features

#### Skipping tracks or titles/chapters

To move forward or backward through the tracks on a CD or the titles or chapters on a DVD, press Previous/Next **15** **16**.

#### Fast Motion Playback/Fast Search

- To move forward or backward through the DVD or CD disc being played at fast speed, press Search **18** **20** on the remote. Once one of these buttons is pressed, the fast search will continue until Play is pressed.

There are four fast-play speeds. Each press of the Search Buttons will cycle to the next speed in the following order: 2x, 4x, 16x, 100x, indicated by a number of arrow indicators on the right top of the screen.

- Press PLAY **17** at any time to resume normal playback.

Note that there will be no audio playback during fast-forward or -reverse play of DVD discs. This is normal for DVD, as surround processors cannot process the digital audio streams during fast-play modes; audio will be heard during fast-play of conventional CD's.

#### Freeze Frame and Frame Advance (with DVD only)

- Press PAUSE **13** when a DVD is playing to freeze the picture.
- Each time you press one of the STEP (FWD or REV **15** **16**) buttons, the picture advances one frame in the selected direction.
- Press PLAY **17** to resume normal playback.

#### Slow Motion Playback (with DVD only)

- When a DVD disc is in pause or freeze frame mode, you may move slowly forward or backward through the program being played at one of four speeds by pressing the SEARCH Buttons **18** **20** on the remote. Each press of the buttons will move to the next speed, indicated by a number of arrow indicators on the right top of the screen.
- Press PLAY **17** to resume normal playback.

Note that there will be no audio playback during slow-forward or -reverse play of DVD discs. This is normal for DVD, as surround processors cannot process the digital audio streams during slow modes. Slow play is not available for CD.

Notes: Playback features may not be available during the opening credits of a movie. This is intended by the disc author and is not a failure of the Digital Lounge system Controller.

Playback of a DVD with 96 kHz/24-bit audio requires the use of circuitry normally used for other features. Accordingly, Slow Play Reverse and Step Advance features are not available with these discs.

Depending on the structure of a VCD disc, the functions Slow Reverse and Step Reverse may be prohibited or have no function and Fast Playback (Search) may not function.

#### About DivX Movie Files

The DivX disc compatibility of this DVD player is limited by the following:

- the available resolution size of the DivX file should be maximum 720x576 (W x H) pixels.
- the total number of files and folders on the disc should be less than 999.
- the number of screen frames per second should be maximum 29.97 frames per second.
- the video and audio structure of recorded file should be interleaved.

The player is capable of playing DivX files with the extensions ".avi".

The player is capable of playing subtitle files with the extensions ".smi", ".srt", ".sub (Micro DVD format only)" or ".ssa". Other subtitle files won't be displayed. Subtitle files need to carry the same name as the movie file (but with either one of the above extensions) and should be located in the same directory.

#### Playing a DivX Movie Disc

Before playing DivX movie discs, please note the following:

- multi session DVD containing Windows Media Audio files may not be supported.
- open session discs are not supported.
- the DVD player does not support PC data.
- this DVD player does not support an unfinalized disc with a closed session.

- Insert a disc into the Slot Loader **7**.  
Hold the disc without touching either of its surfaces, position it with the side you wish to play facing down, align it with the guides, and place it in its proper position.
- In the On Screen Display opening select a folder by pressing the up/down cursor buttons and press ENTER. A list of files in the folder appears. If you are in a file list and want to return to the Folder list, use the up/down buttons on the remote to highlight the return icon on top of the list and press ENTER.
- If you want to view a particular file, press the up/down buttons to highlight a file and press ENTER (PLAY will always play the first file on the disc).

When playing back a DivX movie you can use variable playback functions like fast backward and forward, as well as step and slow forward while slow and step backward are not possible. To facilitate the navigation with DivX/XviD movies you can jump forward/backward for 10 minutes by pressing the **Preset +/-** buttons **22** on the remote.

- Press STOP to stop the playback.

The DVD player's playback functionalities of DivX video discs will vary depending on the DivX version used for creating your movies.



### Surround Mode

One of the most important features of the Digital Lounge system is its ability to reproduce a full multichannel surround sound field from digital sources, analog matrix surround encoded programs and standard stereo programs.

Selection of a surround mode is based on personal taste, as well as the type of program source material being used. For example, motion pictures, CD's or TV programs bearing the logo of one of the major surround encoding processes, such as Dolby Surround should be played in either the Harman proprietary Logic 7 Movie or Dolby Pro Logic II Movie (with movies) or Logic 7 Music or Dolby Pro Logic II Music (with music) surround mode.

Surround modes and audio formats are selected using the remote. Press the AUDIO button **6** to toggle between the surround modes/audio formats available on the DVD disc. As you press the button, the Surround mode/audio format name will appear on your video display.

When a digital source is present, the DVD receiver will automatically select and switch to the correct mode (Dolby Digital or DTS), regardless of the mode that has been previously selected.

To listen to a DVD-program in traditional two channel stereo, using the front left and front right speakers only plus the subwoofer, follow the instructions shown in the chapter DVD Sound Mode, in the Audio Settings Menu.

### System Defaults

The final step of the installation is to establish the system's defaults. It is helpful to take a few minutes to familiarize yourself with these settings, as they may require change before the first use and later from time to time.

#### General Functionality of the User Interface

The complete setup and control of the Digital Lounge takes place in an advanced Guided User Interface menu system. The Guided User Interface integrates four individual menu structures, all easily accessible via the remote control:

- Set Up Menu for the Screen
- Set Up Menu for the DVD receiver
- On Screen Display Menu for the Screen
- On Screen Display Menu for the DVD receiver

All menus are easily accessible via the remote control.

The main menu of the DVD-Receiver is available by pressing the **OSD Button** **32** on the remote, being in receiver mode (see page 24). It consists of a DISC Menu, RADIO Menu, TV Menu, AUX Menu, DIGITAL Menu, USB Menu, DMP menu and a SET-UP Menu. The DISC Menu will show all information and options available for the disc currently playing. The RADIO Menu will show radio and RDS options. The TV, AUX and DIGITAL Menus show the surround options for these specific audio inputs. The USB Menu will show all information and options available when USB thumb devices or portable hard disks are connected. The DMP menu helps you browse through your music library once your iPod is connected to your Bridge. The SET-UP Menu will help you configure all audio and video settings which are normally only made once.

As the connection between the screen and the DVD receiver is over HDMI, you will be able to benefit from having high resolution interface images, that are text based.

Many menus contain Submenus or text lines. These submenus are shown on the left side of the menu. They can be highlighted by a white square around the text by moving the cursor with the ARROW **10** buttons. Text can be activated by pressing ENTER **7** when they are highlighted. When ENTER **7** has been pressed, the color of the circle behind the text will change to light blue, and you will see that the current settings of this submenu will appear on the right side of the menu. Although some Menus have various Submenus and Settings, they are all navigated in the same way. All submenus, settings and options can be accessed with the help of the ARROW (**▲▼▶◀** **10**) and ENTER **7** buttons on the remote control.

To change a setting, simply move the cursor to the setting you wish to change. This setting will be highlighted in a white square, and a brief explanation will appear in the Upper Menu Line on the bottom of your screen, together with the available options for this setting on the Lower Menu Line.

Once the setting is highlighted, pressing ENTER will show an ◀ and ▶ icon next to the current setting to indicate that the setting can be changed by pressing the left or right ARROW Button **10**. Press the ARROW Buttons **10** until the requested setting is shown, and confirm this setting by pressing ENTER **7**. Note that when you cycle through the options for this setting, the cursor cycles through the options on the Lower Menu Line, and the rest of the Display fades out.

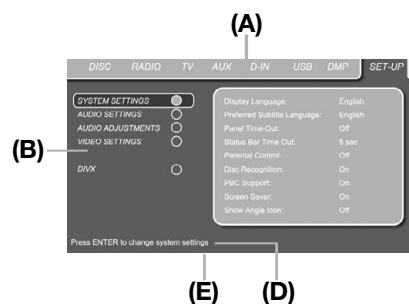

Figure 2a

- (A) Main Menu Line
- (B) Submenus
- (D) Upper Menu Line with Brief Explanation
- (E) Lower Menu Line with Possible Options (not shown in the menu here)

### Set Up Menu for Screen

If the Screen Set Up Menu is not already on the screen, press the TV Button **1** followed by the Set-Up Button **9** to call it on the screen.

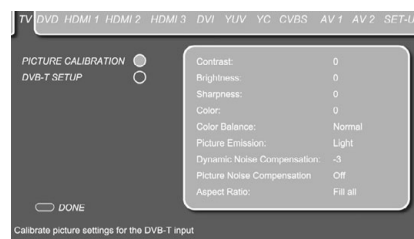

Figure 2b

The Screen Setup Menu handles picture calibration and set up of each individual input connected to the screen. All possible video inputs are listed on the top of the menu, and can be selected by moving from one tab to the next one using the ▶◀ Buttons **10** on the remote control. The selected input is highlighted by a dark blue lit tab, all other tabs will be shown in light blue.

# System Setup

## TV Set Up

The TV Set Up Menu contains 2 submenus. Each submenu can be selected by moving the blue bar with the ▲▼ Buttons 10 until the requested submenu is highlighted and pressing the Enter Button 7 to confirm. The selected submenu will be marked by a light blue circle behind the submenu text line.

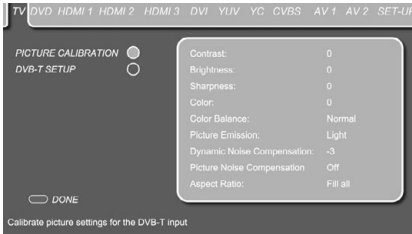

Figure 2c

### Picture Calibration

The first submenu is the Picture Calibration Submenu that allows you to calibrate the picture of your TV. With the TV Set Up Menu on the screen, press the ▼ Button 10 until the Picture Calibration text line is highlighted. Press Enter 7 to select, followed by pressing the ► Button 10 to access the different calibration settings.

**Contrast:** The optimal contrast setting will depend of your preference and the surrounding light in the TV room. Should you wish to change this setting, press the Enter Button 7 once it is highlighted. The TV Set Up Menu will be replaced temporarily by a Mini Bar on the right top of the screen, allowing you to verify the changes made to the contrast setting in real time. To change the setting press any of the ► or ◀ Buttons 10 until the right contrast setting has been reached. Press the Enter Button 7 to return to the calibration process or the Red Button 24 to return to your TV channel.



Figure 2d

**Brightness:** The next line in the picture calibration process is the Brightness Setting. Should you wish to change this setting, press the Enter Button 7 once it is highlighted. The TV Set Up Menu will be replaced temporarily by a Mini Bar on the right top of the screen, allowing you to verify the changes made to the brightness setting in real time. To change the setting press any of the ► or ◀ Buttons 10 until the right brightness setting has been reached. Press the Enter Button 7 to return to the calibration process or the Red Button 24 to return to your TV channel.

**Sharpness:** The next line in the picture calibration process is the Sharpness Setting. Should you wish to change this setting, press the Enter Button 7 once it is highlighted. The TV Set Up Menu will be replaced temporarily by a Mini Bar on the right top of the screen, allowing you to verify the changes made to the sharpness setting in real time. To change the setting press any of the ► or ◀ Buttons 10 until the right sharpness setting has been reached. Press the Enter Button 7 to return to the calibration process or the Red Button 24 to return to your TV channel.

**Color:** The next line in the picture calibration process is the Color Setting, in which the color saturation can be adjusted. Should you wish to change this setting, press the Enter Button 7 once it is highlighted. The TV Set Up Menu will be replaced temporarily by a Mini Bar on the right top of the screen, allowing you to verify the changes made to the color setting in real time. To change the setting press any of the ► or ◀ Buttons 10 until the right color setting has been reached. Press the Enter Button 7 to return to the calibration process or the Red Button 24 to return to your TV channel.

**Color Balance:** The next line in the picture calibration process is the Color Balance Setting, allowing to adjust the color temperature. Should you wish to change this setting, press the Enter Button 7 once it is highlighted. The TV Set Up Menu will be replaced temporarily by a Mini Bar on the right top of the screen, allowing you to verify the changes made to the color balance setting in real time. To change the setting press any of the ► or ◀ Buttons 10 until the right color balance setting has been reached. Press the Enter Button 7 to return to the calibration process or the Red Button 24 to return to your TV channel.

**Picture Emission:** The next line in the picture calibration process is the Picture Emission Setting. This setting adjusts the intensity of the light of the display. Brightly lit rooms will get best video performance with a Picture Emission set to "Light". In dark rooms, the "Dark" setting should be chosen. Should you wish to change this setting, press the Enter Button 7 once it is highlighted. The TV Set Up Menu will be replaced temporarily by a Mini Bar on the right top of the screen, allowing you to verify the changes made to the picture emission setting in real time. To change the setting press any of the ► or ◀ Buttons 10 until the right picture emission setting has been reached. Press the Enter Button 7 to return to the calibration process or the Red Button 24 to return to your TV channel.

**Dynamic Noise Compensation:** The next line in the picture calibration process is the Dynamic Noise Compensation Setting. With this setting you can compensate for possible noise that is detected in any analog video signal. Should you wish to change this setting, press the Enter Button 7 once it is highlighted. The TV Set Up Menu will be replaced temporarily by a Mini Bar on the right top of the screen, allowing you to verify the changes made to the dynamic noise compensation setting in real time. To change the setting press any of the ► or ◀ Buttons 10 until the right dynamic noise compensation setting has been reached. Press the Enter Button 7 to return to the calibration process or the Red Button 24 to return to your TV channel.

**Aspect Ratio:** The next line in the picture calibration process is the Aspect Ratio Setting, defining in what format you watch a specific video input. Should you wish to change this setting, press the Enter Button 7 once it is highlighted. The TV Set Up Menu will be replaced temporarily by a Mini Bar on the right top of the screen, allowing you to verify the changes made to the aspect ratio setting in real time. To change the setting press any of the ► or ◀ Buttons 10 until the right settings has been reached. Press the Enter Button 7 to return to the calibration process or the Red Button 24 to return to your TV channel. The aspect ratio can also be changed directly (and individually for each input) by pressing the Screen Format Button 34.

The second line in this menu depends on your choice of TV tuner. If you have selected a DVB tuner, the DVB-T Setup line will appear, allowing you to access the DVB T system Settings Menu, as described on page 22-23.

If you use the analog TV tuner, the Automatic Search and Manual Search menu lines will appear.

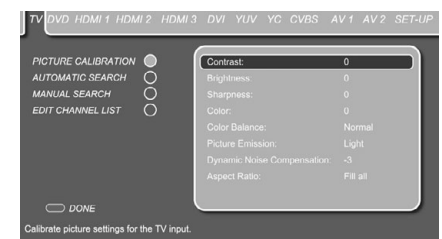

Figure 2e

# System Setup

## Automatic Search (For analog TV only)

The Automatic Search Menu allows you to automatically search for available TV channels. With the TV Set Up Menu on the screen, press the **▼** Button **10** until the Automatic Search text line is highlighted. Press Enter **7** to select, followed by pressing the **▶** Button **10** to access the different automatic search settings. The TV's tuner has a memory for 99 TV stations.

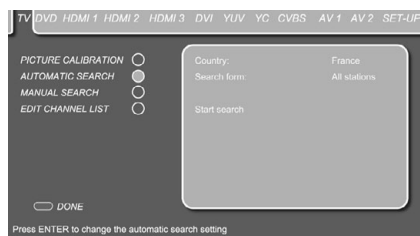

Figure 2f

**Country:** The country line lets you select the country you reside in to do a country-specific sorting sequence of the TV channels. Should you wish to change this setting, press the Enter Button **7** once it is highlighted.

The blue bar will disappear and the rest of the settings will fade out. Select the country you reside in by pressing the **▶** or **◀** Buttons **10** until the requested country is shown. Press the Enter Button **7** to confirm.

**Search Form:** Selects whether you would like to search for All Stations or New Stations. Should you wish to change this setting, press the Enter Button **7** once it is highlighted. The blue bar will disappear and the rest of the settings will fade out. Select the search form by pressing the **▶** or **◀** Buttons **10**. Press the Enter Button **7** to confirm.

**Start Search:** Starts the search for all or new TV stations, depending on the setting made in the previous line. To start the search, press the Enter Button **7** once it is highlighted. The automatic search menu will be replaced by the Auto Search Progress Menu during the time of the search. When the search is finished the Edit Channel List Menu will appear on the screen. Follow the instructions on page 28 should you wish to make changes to the order of the presets or would like to delete presets from the list.

## Manual Search (For analog TV only)

The third submenu in the TV Set Up Menu is the Manual Search Menu that allows you to manually search for available TV channels. With the TV Set Up Menu on the screen, press the **▼** Button **10** until the Manual Search text line is highlighted. Press Enter **7** to select, followed by pressing the **▶** Button **10** to access the different manual search settings.

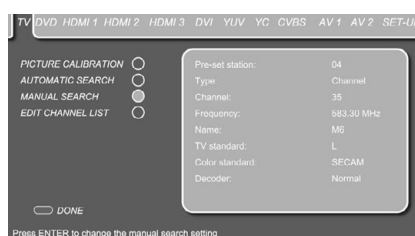

Figure 2g

**Pre-set Station:** Selects a new preset station number. Should you wish to change this position, press the Enter Button **7** once the line is highlighted. The blue bar will disappear and the rest of the settings will fade out. Select the requested position by pressing the **▶** or **◀** Buttons **10** until it is shown. Press the Enter Button **7** to confirm.

**Type:** Selects whether you would like to search for Channels or S-Channels (Special Channels, Cable channels). Should you wish to change the channel type, press the Enter Button **7** once it is highlighted. The blue bar will disappear and the rest of the settings will fade out. Select the requested type from the list by pressing the **▶** or **◀** Buttons **10**. Press the Enter Button **7** to confirm.

The next steps depend on which information about the TV station to add you have on hand. Depending on whether you have the correct channel number or the correct frequency, follow one of the two steps described below.

**Channel:** Assigns the TV station's channel number. If you know the correct channel number of the TV station to add, press the Enter Button **7** once the line is highlighted. The blue bar will disappear and the rest of the settings will fade out. Select the correct station number by pressing the **▶** or **◀** Buttons **10** from the list or by typing it with the Numeric Keys **29** on the remote control. Press the Enter Button **7** to confirm. Note that once confirmed, the frequency matching this channel will automatically be shown.

**Frequency:** Assigns the TV station's frequency. If you know the correct frequency of the TV channel to add, press the Enter Button **7** once the line is highlighted. The blue bar will disappear and the rest of the settings will fade out. Type the station's frequency with the help of the Numeric Keys **29** on the remote control. Press the Enter Button **7** to confirm. Note that once confirmed, the channel number matching this frequency will automatically be shown.

**Name:** The line shows the input for the TV station's name and can contain up to five characters. To enter the name, press the Enter Button **7** once the line is highlighted. The blue bar will disappear and the rest of the settings will fade out. Press the **▲** or **▼** Buttons **10** to scroll through the available characters to form the station's name. When the first position contains the right character, move the cursor to the right by pressing the **▶** Button **10** and select the next character. Repeat this until all characters are filled or until the correct name shows on the line. Press the Enter Button **7** to confirm.

**TV Standard:** Selects the TV standard. Should you wish to change the TV standard, press the Enter Button **7** once it is highlighted. The blue bar will disappear and the rest of the settings will fade out. Select the requested TV standard from the list by pressing the **▶** or **◀** Buttons **10**. Press the Enter Button **7** to confirm.

**Note:** If you do not know which TV standard to choose, we recommend that you run the automatic channel search procedure.

**Color Standard:** Selects the Color standard. Should you wish to change the color standard, press the Enter Button **7** once it is highlighted. The blue bar will disappear and the rest of the settings will fade out. Select the requested TV standard from the list by pressing the **▶** or **◀** Buttons **10**. Press the Enter Button **7** to confirm.

**Note:** If you do not know which color standard to choose, we recommend that you run the automatic channel search procedure.

**Decoder:** Older Pay TV systems that require an external decoder can be connected to either one of the 2 Scart inputs. Depending on the decoder type, change the Decoder Settings according to the table below.

Decoder	TV channel	
	Sound	Picture
Normal	Uncoded	Uncoded
Decoder A SCART1	Uncoded	Coded
Decoder B SCART1	Coded	Coded
Decoder A SCART2	Uncoded	Coded
Decoder B SCART2	Coded	Coded

# System Setup

## Edit Channel List (For analog TV only)

The last submenu in the TV Set Up Menu is the Edit Channel List Menu that allows you to make adjustments to the order of the TV channels. With the TV Set Up Menu on the screen, press the **▼** Button **10** until the Edit Channel List text line is highlighted. Press Enter **7** to select, followed by pressing the **▶** Button **10** to access the Edit Channel List Menu. In order to move a channel up or down the list, select it first by moving the cursor until it is highlighted by the blue bar. Press the Enter Button **7** to confirm.

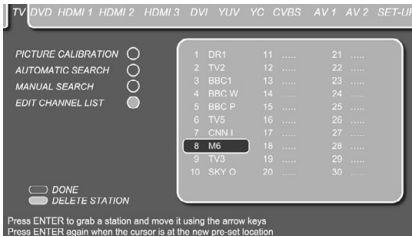

Figure 2h

The blue bar will turn white and the channel can now be moved on the list using the **▲▼▶◀** Buttons **10**. Once the TV channel is on its new position, press the Enter Button **7** to confirm the new position. All stations after the new position will automatically move one station down the list.

Stations can also be deleted from the channel list. In order to delete a channel from the list, select it first by moving the cursor until it is highlighted by the blue bar. Press the Green Button **25** to delete the station from the list.

## DVD Set Up

To access the DVD Set Up Menu, press the TV Button **1** followed by the Set Up Button **9**. Move the cursor to the right using the **▶** Button **10** until the DVD tab is highlighted in dark blue.

The DVD Set Up Menu contains 2 submenus. Each submenu can be selected by moving the blue bar with the **▲/▼** Buttons **10** until the requested submenu is highlighted, and pressing the Enter Button **7** to confirm. The selected submenu will be marked by a light blue circle behind the submenu text line.

## Picture Calibration

The Harman Kardon Digital Lounge is among the few systems that have individual picture calibration settings for each individual video input. As the picture calibration menus for each of the video inputs are the same, please refer to the explanations of the Picture Calibration on page 36. An exclusive setting for the DVD and HDMI inputs is TINT. This will vary the color temperature between green and purple in many small steps in contrast to the "Color Balance" setting. It can be selected and changed in the same way as described for all other Picture Calibration settings on page 36.

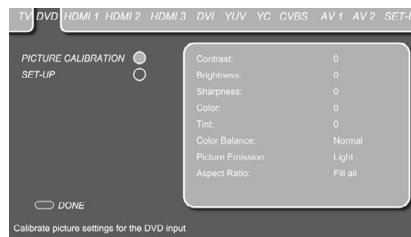

Figure 2i

## Set Up

The DVD Set Up Menu permits changes to Film Mode, Overscan and Interlaced Mode.

**Film Mode:** This mode allows you to switch the Film Mode on or off. When switched to On, this setting will activate the correct film mode detection. The Film Mode should be switched on for all inputs that are used to watch movie playback. If you are not watching movies on a specific video input, the Film Mode setting should be set to Off. Should you wish to change the film mode, press the Enter Button **7** once the line is highlighted. The blue bar will disappear and the rest of the screen will fade out. Switch the film mode on or off by pressing the **▶** or **◀** Buttons **10**. Press the Enter Button **7** to confirm.

**Overscan:** This mode allows you to switch Overscan Mode on or off.

**Interlaced Mode:** This mode allows you to switch the field order for interlaced signals between Mode A and Mode B. If your video source sends an interlaced signal to the screen, you can select the mode that results in the best image quality.

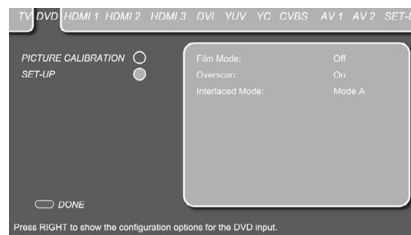

Figure 2j

## HDMI Set Up

To access the HDMI Set Up Menu, press the TV Button **1** followed by the Set Up Button **9**. Move the cursor to the right using the **▶** Button **10** until the HDMI tab is highlighted in dark blue.

The HDMI Set Up Menu contains 2 submenus. Each submenu can be selected by moving the blue bar with the **▲** or **▼** Buttons **10** until the requested submenu is highlighted and pressing the Enter Button **7** to confirm. The selected submenu will be marked by a light blue circle behind the submenu text line.

For the Picture Calibration menu, please refer to the DVD Set Up description.

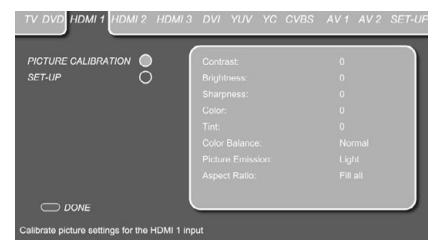

Figure 3a

## Set Up

The second submenu in the HDMI Set Up menu is the Set Up Menu. With the HDMI Set Up Menu on the screen, press the **▼** Button **10** until the Set Up text line is highlighted. Press Enter **7** to select, followed by pressing the **▶** Button **10** to access the Set Up Menu.

The same Picture Calibration and Set Up settings can be made for the HDMI 2 and HDMI 3 inputs.

# System Setup

## DVI Set Up

To access the DVI Set Up Menu, press the TV Button **1** followed by the Set Up Button **9**. Move the cursor to the right using the **▶** Button **10** until the DVI tab is highlighted in dark blue. The DVI Set Up Menu contains 2 submenus. Each submenu can be selected by moving the blue bar with the **▲▼** Buttons **10** until the requested submenu is highlighted and pressing the Enter Button **7** to confirm. The selected submenu will be marked by a light blue circle behind the submenu text line.

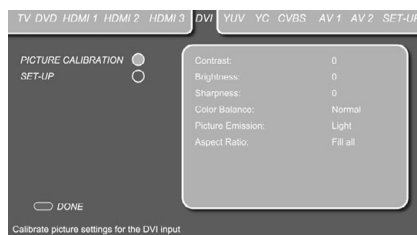

Figure 3b

## Set Up

The second submenu in the DVI Set Up menu is the Set Up Menu. With the DVI Set Up Menu on the screen, press the **▼** Button **10** until the Set Up text line is highlighted. Press Enter **7** to select, followed by pressing the **▶** Button **10** to access the Set Up Menu.

The Set-Up menu appearing depends on the DVI source selected by the **PC** button **1**. When the digital DVI-input "PC(DVI)" is selected the same Film Mode, Overscan and Interlaced Mode settings are available as previously described in the DVD Set Up section on page 28.

When the analog DVI-input "PC(RGB)" is selected the following menu items will appear on the Set-Up menu:

**Auto Setup:** When this option is selected and ENTER is pressed, the screen will optimize its settings to the PC graphics card automatically.

All other settings below can be made manually, but normally the data automatically found will be optimal, only varying the phase sometimes may avoid the small noise/flicker effect appearing in fine structures.

**H Total:** Will vary the width of the complete picture on screen.

**V Pos:** This will shift the picture vertically.

**V Size:** Will vary the height of the picture.

**H Pos:** Will shift the picture horizontally.

**H Size:** Will vary the horizontal picture size.

**Phase:** Will vary the phase of the video signal referring to the pixels on screen.

## Component (YUV), YC (S-Video), CVBS (Composite), AV 1 (SCART) and AV 2 (SCART) Set Up

To access any of the Component, S-Video, Composite or Scart Set Up Menus, press the TV Button **1** followed by the Set Up Button **9**. Move the cursor to the right using the **▶** Button **10** until the requested tab is highlighted in dark blue.

The Set Up Menus of all above inputs contain 2 submenus. Each submenu can be selected by moving the blue bar with the **▲▼** Buttons **10** until the requested submenu is highlighted and pressing the Enter Button **7** to confirm. The selected submenu will be marked by a light blue circle behind the submenu text line.

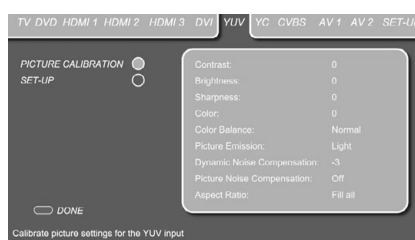

Figure 3c

## Important Notes:

- The Film Mode will be effective only with Scan Mode Interlaced, i.e. not via Component or DVI inputs when in Progressive mode. In case of the Digital Lounge system connected through the HDMI input, the Film Mode setting should remain OFF whatever video resolution chosen.

- The Film Mode can be turned on/off directly, also without the OSD opened, by pressing the STATUS button with the remote in TV mode (as long as the Teletext is not activated).

Exclusively for all analog inputs there is a setting for **Picture Noise Compensation**.

This should be used only for Still Pictures like JPEGs. When turned on, this feature will compensate the low noise that may be contained in the pictures. Note that simultaneously the setting for the "Dynamic Noise Compensation" will change appropriately.

## Set Up

The second submenu in the component, S-Video, composite or Scart Set Up menus is the Set Up Menu. With any of these Set Up Menus on the screen, press the **▼** Button **10** until the Set Up text line is highlighted. Press Enter **7** to select, followed by pressing the **▶** Button **10** to access the Set Up Menu.

Exclusively for the SCART (AV 1 and AV 2) inputs of the TV there are the following setting options important for the proper working of each SCART input in use:

**Scart Device Detection:** This function must be On, if automatic switching-over to the corresponding SCART input is to take place when an active device is connected to the appropriate SCART1 or SCART2 input.

**Video Input Selection:** With this setting the TV can be forced to show only the Composite or RGB video signal on the SCART 1 input respectively only the Composite or S-Video signal on the SCART 2 input. The input signal on SCART 1 is automatically detected and the TV will switch to RGB mode automatically when such a signal is present.

**Aspect Ratio Detection:** This setting selects the signal for the format detection (4:3 or 16:9) on the SCART inputs and will be effective only with the Aspect Ratio set to "Auto Zoom" mode (in the Picture Calibration menu). Three options are available for the selection:

## General Set Up

To access the General Set Up Menu, press the TV Button **1** followed by the Set Up Button **9**. Move the cursor to the left using the **◀** Button **10** that the Set Up tab is highlighted in dark blue.

**Global Setup:** In the (General) Setup menu, you can select two sub-menus, Global Setup and Sound Setup.

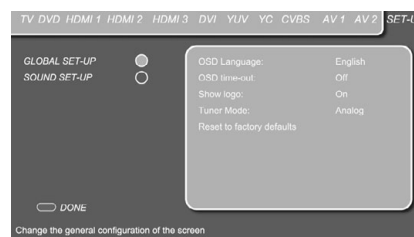

Figure 3d

**OSD Language:** Sets the language in which all set up menus related to the screen will be presented. Should you wish to change the OSD Language, press the Enter Button **7** once it is highlighted. The blue bar will disappear and the rest of the settings will fade out. Select the requested language from the list by pressing the **▶** or **◀** Buttons **10**. Press the Enter Button **7** to confirm.

**OSD Time Out:** Sets the amount of time it will take to automatically switch off the different menus. Should you wish to change the Time Out timing, press the Enter Button **7** once the OSD Time Out line is highlighted. The blue bar will disappear and the rest of the settings will fade out. Select the requested time interval from the list by pressing the **▶** or **◀** Buttons **10**. Press the Enter Button **7** to confirm.

## System Setup

**Show Logo:** Defines whether the Harman Kardon Digital Lounge splash screen will be shown each time the system is turned on. Should you wish to change the Show Logo Setting, press the Enter Button **7** once the Show Logo line is highlighted. The blue bar will disappear and the rest of the settings will fade out. Set the logo on or off by pressing the **▶** or **◀** Buttons **10**. Press the Enter Button **7** to confirm.

**Tuner Mode:** Switches between the analog and the digital (DVB-T) tuners. Please remember to make sure that when changing from one tuner mode to the other, the one you have selected is connected to the antenna.

**Reset to factory defaults:** The Reset procedure erases all TV station memories and returns all picture adjustments to default values.

When all the Set Up Menus for the Screen have been set, press the Red Button **24** to exit the Screen Set Up Menu and continue with the Set Up Menus of the DVD Receiver.

### Sound Set Up:

This function is necessary to combine one of the three Digital Coaxial sound Inputs and the one Digital Optical sound Input on the rear panel of the screen (Inputs **P**, **V**, **W** and **X**) with the desired Video Input Source. Each of the four Digital Sound Inputs may be allocated to work with one of the 11 possible Video Inputs. Of course, you only have to perform this procedure for those inputs that you actually wish to use.

From the Setup Start Screen shown above, scroll down with the **▼** Button **10** to highlight first Global Setup, then Sound Setup. As explained in the On Screen bottom text line, press Enter **7** to choose the Sound Setup options, followed by pressing the **▶** Button **10** to highlight the top-most Coaxial In 1 menu line. Again, press Enter **7** to open access to Coaxial In 1. Now you can scroll through the options with the **▶** or **◀** Buttons **10**. The start option for all inputs is "None", followed by (scrolling with the **▶** Button): AV 1, AV 2, CVBS, YC, YUV, HDMI 1, HDMI 2, DVD, HDMI 3, PC (RGB) and PC (DVI) inputs. Note that you may scroll in both directions, and that both Digital and Analog Inputs are available for selection. Having chosen the proper video input, press Enter again. You may now proceed to the other Coaxial Inputs or the Optical Input. When you are done, press the Red Button **24** to exit the Menu.

### Set Up Menu for the DVD Receiver

The next step in checking or changing the system defaults is to access the Setup Menu of the DVD receiver. First, make certain that the DVD receiver is properly connected to the screen, and that power is connected. For this process, however, you do not need to load a disc into the unit.

The Set Up of the receiver can be called at any time, even during STOP, PAUSE or PLAY mode. Now press the DVD Source Selector **1** to put the system in DVD receiver mode, followed by pressing the Set Up Button **9**. This will access the Set Up Menu of the DVD receiver.

The Set Up Menu of the DVD receiver and all menus in the following section may look different, listing the settings with different languages, depending on the settings made previously. With the factory default setting all languages are set to "English", that's why with all menus the English version is shown in the manual.

In the SET-UP Menu you will find submenus for making or changing all settings and adjustments for both Audio and Video handling of your Digital Lounge system.

Press ENTER **7** to activate the SYSTEM Settings.

### System Settings



Figure 3e

The System Setting Submenu contains the following settings. Follow the explanations in the Upper Menu Line on the bottom of your screen to change the settings.

**Display Language:** Sets the language in which the OSD menus are shown on your screen.

**Preferred Subtitle Language:** Defines your preferred subtitle language. Every time a disc contains this subtitle language, it will be shown automatically. If you do not find your preferred language in the list of options, you can select your preferred language by selecting OTHER, and then typing a 4-digit code found in the code list on page 46. You can also set the preferred subtitle language to OFF. In that case no subtitles will be shown.

**Panel Time-Out:** Sets the time-out interval for the Front Panel Information Display. After the selected time, the display will dim completely.

**Status Bar Time-Out:** Sets the time-out interval for the Status Bar, after which the Status Bar will disappear from the screen.

**Parental Control:** Defines a password used to control viewing of restricted programs. The default password is 8888. After pressing the default password, either the parental control setting can be chosen, or a new password. The five standard US rating symbols are "G" (General, level 1), "PG" (Parental Guidance, level 3), "PG13" (Parental Guidance and 13 years old, level 4), "R" (Restricted, level 6) and "NC 17" (from 17 years old, level 7). The DVD will accommodate a total of eight rating steps, as set by the DVD creators. These additional steps allow for more critical control of program playback for all audiences. Level 8: All DVDs can be played. Levels 7 to 2: DVDs for general audiences/children can be played. Level 1: DVDs for children can be played; DVDs for adults/general audiences are prohibited. Follow the explanations on the screen to set a new password.

**Disc Recognition:** When set to on, the next time a disc is inserted, the screen will show a "Disc Recognized" message, with the question if you would like to play the disc from the beginning or would like to resume from where you last stopped the disc. The memory can contain information of the last 100 discs played.

**PBC Support:** Activates PBC (Play Back Control) Support for VCD discs.

**Screen Saver:** Activates a Screen Saver to prevent image "burn" in your screen, we recommend you activate the screen saver at all times.

**Show Angle Icon:** Determines whether the Angle Icon will appear on the screen when there are different angles available on a DVD disc.

Once all System Settings have been set to your personal taste, move the cursor to the left until AUDIO SETTINGS is highlighted. Press ENTER **7** to access the Audio Settings Menu.

### Audio Settings



Figure 4

The Audio Setting Submenu contains the following settings. Follow the explanations in the Upper Menu Line on the bottom of your screen to change the settings.

**Preferred Audio Language:** Defines your preferred audio language. Every time a disc is played that contains this audio language, it will be activated automatically. If you do not find your preferred language in the list of options, you can select your preferred language by selecting OTHER, and then typing a 4-digit code found in the code list on page 46.

# System Setup

**Dynamic Range:** This setting allows you to take advantage of the programming present on some Dolby Digital recordings to reduce the volume of louder passages while maintaining intelligibility of quieter passages. This means that you may listen to programs at a level that allows the full impact of a soundtrack to be heard at a volume that is lower than you might otherwise use to avoid disturbing others. The Digital Lounge accomplishes this by compressing the audio to a greater or lesser degree, depending on which setting you choose. Three options are available:

- **MINIMUM** does not make any changes to the original playback, and should be used when the volume setting in the listening room may be as loud as you desire.
- **MEDIUM** applies a moderate amount of compression so that louder passages are a little bit quieter.
- **MAXIMUM** applies more compression so that louder passages are much softer.

Feel free to experiment with the settings at any time.

**Delay Unit:** This setting sets the measuring unit for Delay in either Feet or Meter.

If you have a digital video source or a digital video display that causes lack of lip sync you may use the A/V Sync adjust feature to delay the audio signal as it is sent to all channels (as opposed to the individual settings) so that the picture and sound are brought back together. Adjustments can be made in steps of 5ms, from 0ms up to 50ms.

**Tone Control:** Activates or De-activates the Bass and Treble settings. Once either the Bass or Treble Settings are changed, the Tone Control automatically switches to ON.

**Bass Level:** Sets the level of low frequencies.

**Treble Level:** Sets the level of high frequencies.

**DVD Sound Mode:** Sets the audio format of the DVD-disc playing (for other sources, see Surround Mode in each respective chapter). Once set to stereo, every surround format on a DVD will be converted to a pure stereo signal. Once set to Logic 7 or Dolby Pro Logic II, all stereo signals on a DVD are forced into 5.1. This setting is recommended. Original will follow the surround format on the disc.

## Audio Adjustment



Figure 5

The Audio Adjustment Submenu contains the access to the manual speaker delay and the output level adjustment settings of the Digital Lounge as well as the automated EzSet/EQ setup. Follow the explanations in the Upper Menu Line on the bottom of your screen to make adjustments.

### Automated Speaker Setup Using EzSet/EQ

The Digital Lounge is one of the first receivers in its class to offer automated speaker setup and system calibration. This process greatly simplifies the installation of your new receiver by using a series of test signals and the power of an advanced digital signal processing system to eliminate the need for manual adjustment of speaker "size", crossover, delay and output level settings, while adding the power of a multi-band parametric equalizer to smooth out any peculiarities in frequency response that may result from the characteristics of the listening room. With EzSet/EQ your new receiver even alerts you to errors in speaker connections that prevent a speaker from functioning.

With EzSet/EQ you are able to calibrate your system in a fraction of the time it would take to enter the settings manually, and with results that rival those achieved with expensive test equipment and time-consuming procedures. The end result is a system calibration profile that enables your new receiver to deliver the best possible sound, no matter what type of speakers you have or what the dimensions of your listening room are.

We recommend that you take advantage of the precision of EzSet/EQ to calibrate your system, but if desired you may also make any of the configuration settings manually, or trim the settings provided by EzSet/EQ by following the instructions on page 34.

If you wish to configure your DL manually, or if for some reason your EzSet/EQ microphone is unavailable, you may still do so by following the instructions on page 34.

**Step 1:** EzSet/EQ requires that your listening room have as little background noise as possible to avoid interfering with the measurement of tones produced by your Digital Lounge during the setup procedure. Turn off all loud fans, air conditioners and other equipment, and try to avoid making any noise during the process.

**Step 2:** The EzSet/EQ microphone should be placed in either your usual listening position or, if there is a large seating area, the center of the room, at the listeners' ear level. You may find it convenient to use a camera tripod for stable placement of the EzSet/EQ microphone at the correct height. The microphone includes a threaded insert on the bottom for tripod mounting.

**Step 3:** Plug the EzSet/EQ microphone into the Digital Lounge's **Headphone Jack** 5, making certain that the mini-plug is firmly connected. The microphone cable is approximately 7 meter long, which should accommodate most listening room situations. If required, you may use an optional extension cable, available at most electronics stores, for use in larger rooms. However, we recommend that you avoid using extension cords for the microphone cable, as they may adversely affect the test results.

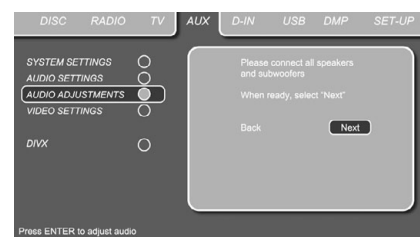

Figure 6

**Step 4:** Once the microphone is properly positioned and plugged in, first select the AUX input by pressing the OSD Button 9, followed by moving the Navigation Buttons 10 until the AUX input is highlighted in dark blue. Press the Enter Button 7 to confirm. Next proceed to the SET-UP menu, and move the cursor to the Audio Adjustments line. Press the Enter Button 7 to confirm. Next, press the Navigation Buttons 10 to move the on-screen cursor to the EZSET/EQ SETUP menu line. Press the Enter Button 7 to move to the next screen.



Figure 6a

# System Setup

**Step 5:** The first two screens of the EzSet/EQ system will now appear to remind you to connect all the loudspeakers and to plug in the microphone. If you have not already done so, connect all loudspeakers and plug the microphone into the **Headphone Jack 5** as described in steps 2 and 3. When you are ready to proceed, make certain that the cursor is pointing to **NEXT** and press the **Enter Button 7**. If you do not wish to continue with the EzSet/EQ process, press the **Navigation Buttons 10** to highlight **BACK** and then press the **ENTER Button 7** to return to the **MASTER MENU**. Note that if you attempt to move to the next menu without plugging in the microphone, a reminder message will flash at the bottom of the screen.

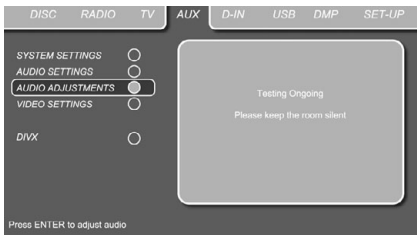

Figure 6b

**IMPORTANT NOTE:** Anyone with hearing that is sensitive to loud noises should leave the room at this point, or use ear protection sufficient to reduce the noise level. Inexpensive foam-style ear plugs, available at most drug stores, may be used to reduce the sound level to a tolerable level. If you are uncomfortable with, or cannot tolerate, loud sounds and do not use some sort of ear protection, we strongly recommend that you leave the room and ask someone else to run the EzSet/EQ process, or that you do not use EzSet/EQ and enter the configuration settings manually, as described on page 34.

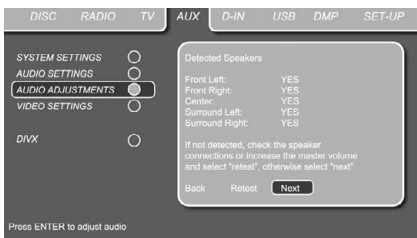

Figure 6c

**Step 6.** At this point you will begin to hear a series of test tones circulate among all the speakers in your system. While this is happening, the Digital Lounge is reading the signal to determine which speaker positions are active, what type of speaker is present at each active position, what the distance is from the listening position to each speaker, and to begin to build a profile of the impact of the room's acoustics on the quality of audio reproduction. When the test is completed you will hear the tones stop, and the system will pause for as long as a minute while the processor makes its calculations. Do not be alarmed if the "WARNING" message remains on the screen after tones stop until a results message is displayed as shown in Step 6 or 7, below.

**NOTE:** While these tests detect whether a speaker is connected to a particular output, they cannot determine whether the speaker is in the correct position. (For example, it can tell whether a speaker is connected to the Surround Right output, but it cannot tell whether the speaker is on the right or left side of your listening room.) For that reason, we strongly recommend that you try to listen as the tone circulates, around you, starting at the left front, right front, center, and finishing at the left surround and right surround. If a tone is heard from a speaker position that does not match this order, make a note of the incorrect speaker connections. When the test process stops you will see a message indicating the Far Field measurements are complete, but since there is a connection error press the **Navigation Button 10** so that the on-screen cursor in Fig. 7 is pointing to **BACK** and press the **ENTER Button 7**. At this point, exit all menus and turn the receiver off. Check all speaker wire connections and then rerun EzSet/EQ.

**Step 7.** When the Far Field tests are complete a message screen will appear to confirm if the procedure was successful or not. In most cases there will not be any problems and you will see the message shown in Figure 6d on your screen. If the speaker positions shown match the actual speaker layout in your system select **NEXT** and, press the **ENTER Button 7** to complete EzSet/EQ by performing the Near Field Measurements from the front left, center, front right and surround left and right speakers. By taking this separate set of measurements, the Digital Lounge is able to complete its view of the room's sonic signature and apply equalization as needed to correct spikes and dips in the system's response. Continue these instructions with Step 8.



Figure 6d

**Step 7a.** If the measurements are not successful due to a missing or malfunctioning speaker, the message will appear as shown in Figure 6e. EzSet/EQ is programmed to look for speaker pairs at the front left/front right, surround left/surround right and surround back left/surround back right positions. If the test results indicate that one, but not both of the speakers in any of these pairs is present, the menu will show **NO** next to the speaker position where the tests did not report back that a speaker is present. Should this message appear, make note of the suspect speaker location, exit all menus and turn the receiver off. Check all speaker wire connections and then rerun EzSet/EQ until all speakers are detected successfully.



Figure 6e



## System Setup

**Step 8.** When the Far Field measurements are completed, the system will ask you to take Near Field measurements, one at each five speaker position. These measurements enable EzSet/EQ to produce the most accurate settings for both high and low frequency equalization. The Near Field measurements are similar to the Far Field tests, except that the system will “listen” to only one speaker at a time, rather than sending the test signals to all speakers in rotation.



Figure 6f

**Step 9.** During the Near Field testing, (Figure 6f), you will see an instruction to place the microphone in a different position than the one used for the initial Far Field measurements. This time, place the microphone close to the speaker to be measured, at a distance of about 1 meter. In addition, the top of the microphone should be pointed towards the speaker, rather than pointing up as was done for the Far Field tests. For the first measurement, place the microphone so that it is close to, and pointing towards, the front left speaker, and press the **ENTER Button 7**.

**Step 10.** One short test signal will be sent to the speaker position being calibrated and after a slight pause from the system to calculate the test results, you will see either the next Near Field Measurement screen, or a "Testing Error" screen. In most cases, the "next Near Field Measurement" message will appear, in which case you should proceed to Step 11, if an "Error" message appears, go to Step 12.

**Step 11.** If the test results were successful, the next Near Field Measurement screen will appear. In order to properly calibrate the system, you will need to run the Near Field tests for all five channel speakers. Repeat Steps 8 through 11 until all speakers have been calibrated. When that is done the Near Field process is complete. With the cursor highlighting **NEXT** press the **ENTER Button 7** to continue with the Subwoofer Far Field measurements.

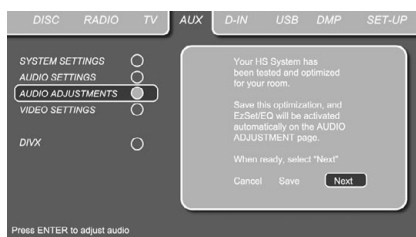

Figure 6g

**Step 12.** If a "Near Field Error" message appears, as shown in Figure 6h, you should check to make certain that the microphone is about one meter from the speaker being tested and that the top of the microphone unit is pointing towards the speaker. You may also have to raise or lower the master volume to achieve accurate readings. After checking these two items, as needed, make certain that the cursor is pointing to the **RETEST** line and press the **ENTER Button 7**. This will return you to the **NEAR FIELD EQ SELECT** menu (Figure 6h) where you should repeat Steps 8 through 11, adjusting the microphone placement and volume level as needed until all Near Field Measurements are done.

The next and final step is to have EzSet/EQ run the Subwoofer measurements. Make sure the cursor is highlighting **NEXT**, and press **ENTER Button 7** to start the Far Field Measurement for the Subwoofer. Note that the measurement microphone will need to be again at the preferred listening position, at ear level, as with previous Far Field measurements.

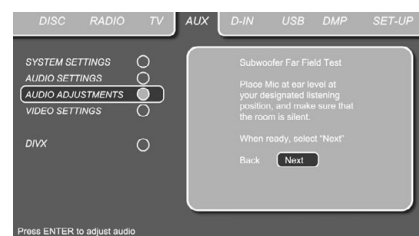

Figure 6h

When both the Far Field and Near Field measurements have been successfully completed your system is ready for use. Move the cursor to **SAVE** and press the **ENTER Button 7**. This will save your EzSet/EQ settings, and will show the results of the measurements, similar to the screen shown in Figure 6i.

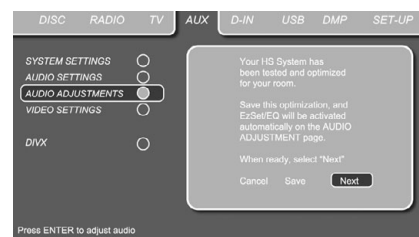

Figure 6i

Thanks to EzSet/EQ, the settings for speaker “size”, speaker crossover, channel output and individual channel delay time have been automatically set and require no further adjustment. In addition, EzSet/EQ has also performed a complete room equalization that tailors the system's performance for the best possible sound with your combination of speakers, speaker placement and room acoustics.

# System Setup

## Manual Setup

In most cases it is simpler, easier and more accurate to let EzSet/EQ take care of entering the system parameters for speaker "size", speaker crossover, channel output and individual channel delay time. However, if you feel that your listening room or system components are best suited to manual entry of these settings, the Digital Lounge also allows you to enter or trim any of these traditional system parameters. Even if you do make the settings manually, we recommend that you run the EzSet/EQ tests first so that a baseline setting is established, and then make your adjustments from there. Note that once EzSet/EQ has been run you do not need to adjust all system settings, only those that you want to adjust.

To view or change the current settings, press the **OSD Button 9** on the remote to bring up the **SET - UP MENU** (Figure 1). Next, press the **Navigation Button 10** as needed until the cursor is on the **AUDIO ADJUSTMENTS** line. Press the **ENTER Button 7** to view the **AUDIO ADJUSTMENTS** menu (Figure 7).

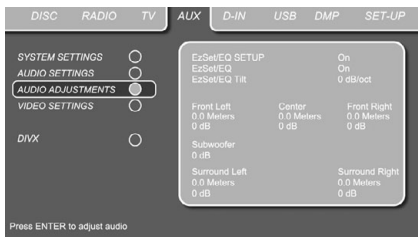

Figure 7

If you have already run the EzSet/EQ calibration system, the second line of the menu enables you to hear the difference between the settings established by EzSet/EQ. The default setting is **ON**, which plays the incoming source with the EzSet/EQ settings. To hear the system in a Bypass mode, with none of the equalization filters in the circuit path, press the **Navigation Button 10** so that **OFF** is highlighted. Note that once changed, this setting will remain until you change it again in this menu. While you may want to use this menu option to hear the difference that EzSet/EQ makes, we recommend that you leave the setting on to take advantage of the benefits of EzSet/EQ's advanced room correction technology.

The **EZSET TILT** line on the menu enables you to set the system's Tilt, or high-frequency boost. To make this adjustment, first make sure that **EZSET EQ** line is set to **ON**, as this item is not available when EzSet EQ is not in the signal path. When the cursor is on the **EZSET TILT** line, press the **ENTER Button 7**, and then press the **Navigation Button 10** to enter the desired setting followed by the **ENTER Button 7** to confirm your setting.

## Delay

Due to the different distances between the listening position for the front channel speakers and the surround speakers, the amount of time it takes for sound to reach your ears from the front or surround speakers is different. You may compensate for this difference through the use of the delay settings to adjust the timing for the specific speaker placement and acoustic conditions in your listening room or home theater. Measure the distance from the listening position to each of the individual loudspeakers. Once done, select per loudspeaker the distance that is closest to the one measured.

## Output level adjustment

Output level adjustment is a key part of the configuration process for any surround sound product.

**NOTE:** Listeners are often confused about the operation of the surround channels. While some assume that sound should always be coming from each speaker, most of the time there will be little or no sound in the surround channels. This is because they are only used when a movie director or sound mixer specifically places sound there to create ambiance, a special effect or to continue action from the front of the room to the rear. When the output levels are properly set it is normal for surround speakers to operate only occasionally. Artificially increasing the volume to the rear speakers may destroy the illusion of an enveloping sound field that duplicates the way you hear sound in a movie theater or concert hall.

The default settings of the DVD player is 0 dB for all channels. In case you feel adjustments are necessary in your setup, we advise you to make the adjustments using the internal test tone generator.

Once the cursor is moved to any of the speaker level icons, the test noise will be heard from the corresponding speaker. If this is not the case please check whether the loudspeaker is connected to the correct loudspeaker output on the rear panel. The speaker level can be adjusted by pressing **ENTER** and selecting an appropriate level indicated in the Lower Menu Line. The test noise will stop as soon as the cursor is moved away from any speaker level icon.

Once all Audio Adjustment Settings have been set to your personal taste, move the cursor to the left until **VIDEO SETTINGS** is highlighted. Press **ENTER 7** to access the Video Settings Menu.

## Video Settings

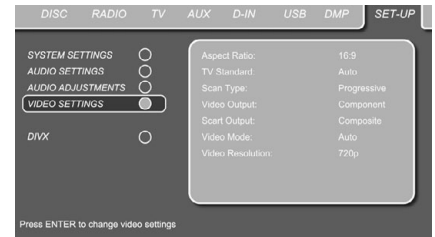

Figure 7a

The Video Setting Submenu contains the following settings. Follow the explanations in the Upper Menu Line on the bottom of your screen to change the settings.

**Video Mode:** This setting affects only the video signal on the HDMI output and the progressive signals on Component video and it controls how the video signals are optimized for progressive scan display. In most cases, the "automatic" mode is your best choice, as it senses whether the disc being played was originally recorded on video or shot on film. However, in some cases you may wish to compensate for errors in the disc authoring that occur when the lag for the film mode detection is not properly set when films are converted to video. Three choices are available reducing the impact of the digital source perceptibly.

- **Auto:** This is the recommended setting, as it lets the DVD player analyze the signals from the DVD and adjust the output accordingly.
- **Movie:** Choose this option for optimal playback of material that was shot on film, even though you are viewing it on video via a DVD.
- **Video:** Choose this option for optimal playback of material that was shot directly to video, such as concerts and sports programming.

**Video Resolution:** Selects the resolution of the HDMI and Component video output. Due to the one-wire, digital HDMI connection with the screen, the Cinema Lounge system performs best with the 720p setting.

# System Setup

## DivX Video On Demand

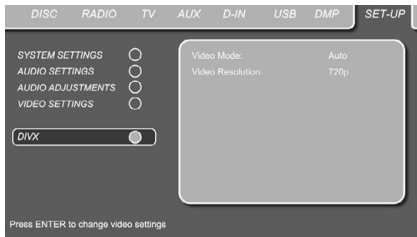

Figure 7b

This code allows you to rent and purchase videos using the DivX VOD service. For more information, visit [www.divx.com/vod](http://www.divx.com/vod). Follow the instructions and download the video onto a disc for playback on this unit. Note that all the downloaded videos from DivX VOD can only be played back on this unit.

Once the DivX icon is highlighted, press ENTER to access your personal DivX VOD code.

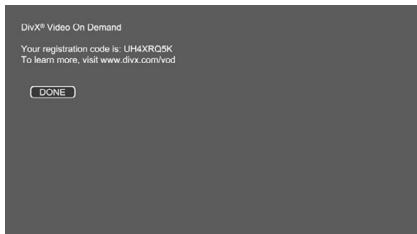

Figure 7c

## Test Screen

### Picture Calibration Using the supplied Test Disc

When doing the calibration first insert the disc in the slot loader **7**. The disc will start reading, and a main menu will appear on the screen. Select the test pattern required using the **▲** or **▼** **Buttons 10**. Once the pattern appears on the screen, press the **Pause Button 13** to make sure the test pattern will stay long enough on the screen to make the adjustments.

With the requested test pattern on the screen press the **Mode Button 41** repeatedly until the TV Button turns red. This will change the remote control to the TV mode, without changing the system's source to TV. Next, press the **Setup Button 9**, and use the **▲▼▶◀** **Buttons 10** to select any of the calibration settings to be changed and follow the directions mentioned previously to find the right settings.

When the first calibration setting has been correctly made, press the **Enter Button 7** to go back to the Setup Menu. Use the **▲▼** **Buttons 10** to select the next calibration setting.

Once all calibration settings for the specific video input have been confirmed, press the **Mode Button 41** once so that the DVD Button turns red. Should additional calibration settings be made using the supplied disc, these can be selected by pressing the **Disc Menu Button 12** and select the next calibration setting to be changed. Follow the directions above to make all other calibration settings.

Once all calibration settings have been made, press the **Mode Button 41** until the DVD Button turns red to change the remote control back to controlling the DVD receiver.

## Status Bar / OSD Menu / Disc Player Menu

### Using the Status Bar Menu

The on-screen Status Bar contains many playback features. To see the Status Banner Menu, press STATUS **14** on the remote control while a disc is playing. Use the ARROW **10** buttons on the remote to move through the different features in the Status Bar. When a feature is highlighted, press ENTER **7** on the remote to select it and to change it with the help of the options listed on the screen. Press ENTER **7** to activate the change.

**Title:** The number shown indicates the number of the title that is currently playing.

**Chapter:** The number shown indicates the number of the chapter that is currently playing on a disc.

**Time:** This item displays the time in DVD mode. To change the Time mode, first move the cursor to the TIME. The current mode will be highlighted. Press ENTER and the ARROW button to activate the following time modes: Title Elapsed, Title Remaining, Chapter Elapsed, Chapter Remaining. Depending on the choice made, the bar will show a graphic view on where the disc is currently playing.

### On Screen Display Menus

When all settings in both the Set Up Menu of the Screen and in the Set Up Menu of the DVD receiver have been made, the Digital Lounge system is ready to play.

These Set Up settings normally only have to be made once. Day-to-day operation of the screen and the DVD receiver is done by two On Screen Displays (OSD).

#### On Screen Display Menu for the Screen

The On Screen Display of the screen allows you to select the video source to be watched. Press the TV Button **1** followed by the OSD Button **32** to call the OSD Menu for the screen on the display.

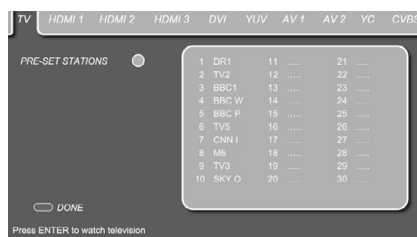

Figure 8

This OSD menu reflects the status with the analog TV tuner active. If you have selected to watch the DVB-T digital tuner, no pre-set stations list will appear. The OSD contains different tabs for each individual video input. These are visible on the top of the screen. The video input currently active will be highlighted in dark blue. In order to select another video input, move the cursor on the screen using the **▶◀** Buttons **10** until the

requested video input is highlighted. Press the Enter Button **7** to confirm. Once this button is pressed, the OSD Menu will disappear, and the selected video input will show on the screen.

One of the tabs, the TV tab, will not only select the TV as video input, but will also allow you to select the TV channel you would like to watch. With the TV tab highlighted in dark blue, press the **▼** Button **10** followed by the **▶** Button **10** to access the Channel List. If the TV tab is not already highlighted, press the arrow **▶◀** Buttons to select. Use the **▲▼▶◀** Buttons **10** to the TV channel you would like to watch. Press the Enter Button **7** to confirm. The OSD Menu will disappear, and the selected TV channel will show on the screen.

**NOTE:** This direct station select is only available if you have chosen the analog TV tuner. If you want to perform direct station select when you have chosen the digital DVB-T tuner, just press the Enter Button **7** while watching TV to call up the TV Channel menu or Favorite Channel menu (press blue button), from which you can choose channels directly.

#### On Screen Display Menu for the DVD receiver

The On Screen Display of DVD receiver allows you to select any of the audio or audio/video sources connected to the DVD receiver. Press the DVD Button **1** followed by the OSD Button **32** to call the OSD Menu for the DVD receiver on the display.

The OSD contains different tabs for each individual audio or audio/video input. These are visible on the top of the screen. The input currently active will be highlighted in dark blue. In order to select another audio or audio/video input, move the cursor on the screen using the **▶◀** Buttons **10** until the requested input is highlighted. Press the Enter Button **7** to confirm. Once this button is pressed, the OSD Menu will disappear, and the selected input will show on the screen.

### DISC PLAYER Menu



Figure 9

Once you have inserted a disc into the player you can explore the DISC PLAYER Menu by pressing the OSD button **32**. This menu hosts all playback and program features, as well as all disc information. As you will see, the layout of this menu is comparable to the SET-UP Menu. The Submenus are

shown on the left side of the screen. As in the SET-UP Menu, settings can be highlighted with the ARROW **10** buttons and selected with the ENTER **7** button on the remote control. Options for the settings are shown in the Lower Menu Line on the bottom of the screen.

**Disc:** Shows the type of the disc.

**Audio:** Shows the audio track that is currently playing. Options are shown on both Menu Lines on the bottom of the screen.

**Playlist:** Sets the order in which the current disc is played back.

**Repeat:** Sets the repeat mode.

**Random:** Activates Random Playback when possible.

**Subtitle:** Shows the subtitle of the disc currently playing.

With JPEG files, when the THUMBNAIL icon on the left side of the menu is activated, you will be able to use the Thumbnail function to quickly and easily search for image files. Any JPEG image file that has been created on the computer with a thumbnail image included will show up on the right top of the screen when scrolling through the contents list.

In the DISC PLAYER Menu, the chapter, track or picture currently playing will be marked with an arrow symbol in front of the Chapter (DVD), Track (CD, MP3, WMA) or Picture (JPEG). Chapters, tracks and pictures can be selected from this list at any time by moving the cursor to the desired chapter or track and pressing ENTER **7** to confirm.

The top part of this screen can be de-activated to show the complete Track list on the screen. To de-activate, move the cursor to the upper SETTINGS (DVDs) or INFO (CDs) Submenu on the left side of the screen. Press ENTER **7** until the icon is highlighted in dark blue and the full Track list is visible on the screen. In the same way the Disc list can be opened or removed from the screen by activating or de-activating the PROGRAM LIST Submenu showing the number of each track on disc (if none is programmed) or the program number of all tracks programmed (see next page).

When the DVD Receiver is in play mode, pressing the PLAY button on the remote control will highlight the track being played.

# Disc Player/Radio Menu

## Information Displays

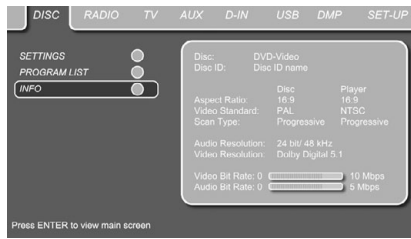

Figure 10

In DVD and MP3 mode, activating the INFO (DVD) or ID3 INFO (MP3) Submenu will show information about the player and the disc currently playing. The first lines will show Disc Type and Disc ID. Below you can compare the Aspect Ratio, Video Standard and Scan Type available on the disc with the actual output of your player or ID3 info for MP3 files.

In the lower part of the screen, the Audio Resolution and Audio Format are shown, (DVD only) and at the bottom a graphical presentation of the Video Bit Rate (DVD only) and the Audio Bit Rate of the disc currently playing.

You also have a direct access to the Information Display by pressing the INFO Button **36** on the remote control.

## Programmed Play

In STOP mode, the Disc List can be used to create your own program list for DVD, CD, MP3, WMA or JPEG discs. Move the cursor to the right of the menu, into the Disc List. If the disc list is not active, move the cursor to the PROGRAM LIST icon on the left to activate. Move the cursor to the Disc List, and select Clear Program to clear the current list. Once the disc list is clear move the cursor up or down to the first track you would like to program and press ENTER **7**. The cursor will move to the options in the Lower Menu Line. You can either add the selected track (or picture) to the playlist or give it the number you would like it to have in your playlist, or clear the track from the list. Move the cursor down to the next track you would like to program and continue until your playlist is complete. Once completed press PLAY on the remote control to start normal playback or, move the cursor up to the Playlist setting and select Programmed order from the options or simply press the PLAYLIST Button **24** on the remote and press PLAY to start the program playback.



Figure 11

If you have a disc that contains both MP3 files and JPEG images, you can choose to run these simultaneously, mixing the MP3 audio with your own images. The time interval can be chosen in the Picture Setting.

Also you can have the image files follow the audio signal: at the end of each audio track, the next JPEG image will be shown. To activate this feature select Follow Audio Track in the Picture Setting.

With such discs, you can also either listen to the MP3 audio or watch the JPEG video files only. In order to do so, in stop mode, click on the LIST MUSIC FILES or LIST PICTURES icons on the left part of the screen to select or deselect the desired format. Once done, the tracklist will only show the MP3 or JPEG files.

## Radio Menu

The FM Tuner in the Digital Lounge system can be used to listen to the Radio. Before listening to the radio stations, you need to preset your favorite stations. The easiest way to do so is with the OSD screen on your monitor.

1. Press the Radio button **21** on the remote control to turn the DVD Receiver on and select Radio as the source. Make sure your screen is switched on to be able to make the initial Radio setup with the use of the OSD menu. If the screen is not already on, switch it on by pressing the Screen Power On Button **35**, if the receiver's OSD is not visible press the Radio Button **21** again.
2. The TV monitor will show the RADIO Menu, as shown below. You can also select the RADIO Menu with the ARROW **10** keys on the remote control. Once the RADIO tab is highlighted, press ENTER **7** to access the RADIO Menu.

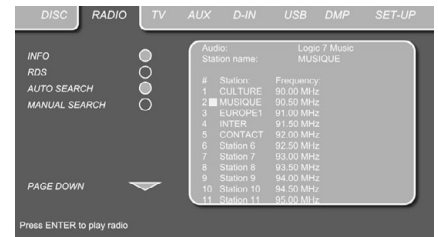

Figure 12

The RADIO Menu shows the selected Audio mode, the name of a station currently played (as long as RDS is available) and a Station list listing the 30 stations with their preset, station name and frequency.

**Note:** The stations can be preset automatically or manually. The Manual Preset mode is described first. The Auto Preset mode is described later in this manual.

3. The INFO, RDS and AUTO Tune functions are switched on by default, shown by the light blue icons, to make the process of tuning your favorite stations as easy as possible. Move the cursor to the end of the first station line in the menu. The frequency will be highlighted and a brief explanation will appear in the Upper Menu Line on the bottom of the menu.

**NOTE:** The INFO, RDS and AUTO Tune functions can be switched off by moving the cursor button to the icon at the left side of the menu and pressing the Enter Button on the remote control so that it turns dark blue.

## Radio Menu

- Pressing the search ◀ / ▶ button **18** **20** will scan the FM band for the first available radio station with acceptable reception. The scan will stop once a station is found and the name of the station will be displayed (as long as RDS is transmitted by the station). The station will be stored automatically in the current preset.

If you know the frequency of your station, you can also tune the frequency directly with the help of the numeric keys of the remote control. Move the cursor to the end of the station line and press the frequency with the numeric keys.

- Move the cursor to the next station line in the menu. Follow the directions in step 3 and in the Upper Menu Line to store all your radio stations in the tuner's memory.

### Rearranging the station list

Once all the stations have been stored in the memory, you can rearrange the station list, putting your favorite stations on top of the list.

- Move the cursor in the left column in the station list to the first station you would like to rearrange.
- Press Enter **7** to activate the current station. The cursor will move to the Lower Menu Line of the screen.
- Select the desired preset from the list by moving the cursor right or left. Press Enter **7** to activate the change. The cursor will move back to the new station line.
- Repeat step 3 until all radio stations have been rearranged according to your preferences.

### Selecting presets

Once rearranged, presets can be chosen at any time (except cursor is on frequency row) by pressing the numeric key corresponding to the preset you would like to listen to. Depending on whether the RDS function is active, the station name will show on the front panel Information Display.

Pressing the Previous/Next ◀◀ / ▶▶ Button **15** **16** or the PRESETS Up/Down Buttons **22** will select the previous or next radio station.

Presets can also be chosen in the Radio Menu. Move the cursor to the preset you would like to listen to and press Enter **7** to activate. An arrow in front of the preset will light to show the active radio station. The cursor can be moved around the menu without changing the current radio station. Pressing the Previous/Next ◀◀ / ▶▶ Button **15** **16** at any position in the menu will select the previous or next radio station, that is for instance from preset 3 to preset 4, even if the cursor is highlighting preset 11. Pressing the Play button will always return the cursor to the current station played, no matter were it was previously (even when another menu is open).

### Removing presets

If you wish to remove presets from your preset list, follow the steps below.

- Move the cursor in the left column in the station list to the preset you would like to remove.
- Press Enter **7** to activate the current station. The cursor will move to the Lower Menu Line of the screen.
- Select Remove from the list and press Enter **7**. The cursor will move back to the original station line.
- Repeat step 3 until all radio stations you would like to delete have been removed.

### Auto Preset function

When the cursor is moved to the " # " icon on top of the preset numbers you can activate the Auto Preset function, clear the complete frequency list or restore all default frequencies set by the factory.

When the Auto Preset is selected the tuner will scan the full FM range and store all stations with acceptable reception one after another on the presets. The frequency scanned will appear on the left lower side of the menu, while the frequency of each station stored will be shown on the right side of the list. When the complete FM range is scanned or all presets (30) are loaded with stations the scan will stop and the first preset be selected.

You also can stop the scan at any time by pressing the STOP button **19**. Stations can be rearranged by following the explanations in the chapter "Rearranging the station list" on page 39.

### RDS Station ID

With the help of RDS (Radio Data System) you can show the name of the station you are currently listening to as well as the station names of all other presets.

The RDS function is set to active by default, shown by the light blue RDS icon at the left of the menu. In this mode, all station names will be visible both on the OSD menu as well as on the Information Display on the front panel.

If the RDS function on the left side of the menu is inactive (dark blue), you will only see the frequency of the current preset shown in the menu and on the front panel display. The Station Name line on top of the menu will disappear, but the name of all other stations preset will keep in the list.

Pressing STATUS **14** on the remote will change the front panels display's indication from the frequency to the name of an RDS station or vice versa and will simultaneously turn the RDS indication in the OSD on or off.

### Surround Mode for Tuner

As with all other inputs of the Digital Lounge DVD receiver, you can also select your preferred surround mode when listening to the radio. The actual surround mode is listed on the first line of the tuner menu. Follow the steps below to change the surround format:

- Move the cursor to the AUDIO line on the top of the tuner menu. The actual surround format will be highlighted. Press Enter **7** to activate the possible surround formats. These will be shown in the bottom line of the menu.
- Move the cursor right or left, until the desired surround format is highlighted.
- Press Enter **7** to activate the change. The setting will apply to all tuner presets.

**Note:** As with all other inputs of the DVD receiver, the Audio mode can easily be selected by pressing the AUDIO button **6** on the remote repeatedly until the desired surround mode appears in the first line of the OSD menu.

# TV Menu, AUX Menu, Digital in Menu

## TV MENU

The TV Menu setting of the DVD receiver sets the audio format and the level adjustment of the audio signal of the TV screen. This adjustment is done once only. All other settings for the TV screen are made in the TV Setup Menu as described on page 26.

1. When the system is on, make sure the OSD is shown on the screen. If not so, press the DVD button **1**, then OSD **32**. Then move the cursor to the TV Menu.
2. The TV screen will show the TV Menu, as shown below. Once the TV tab is highlighted, press ENTER **7** to access it.

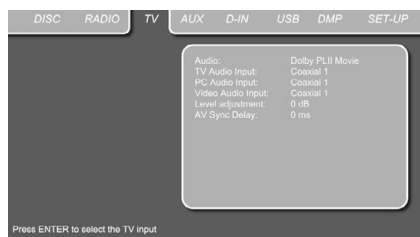

Figure 13

The TV Menu contains the following settings. Follow the explanations in the Upper Menu Line on the bottom of your screen to change the settings.

**Important Note:** When an external A/V source like a DVD-S/T/C receiver is connected to the screen, you have the option to feed its sound through the screen to the unit (will enable only 2 channel sound) or enjoy the digital multichannel source by feeding the audio signal directly to any of the digital audio inputs on the Digital Lounge receiver. The coaxial digital input of the unit can also be used when the screen is connected via analog audio only, see "Important Note" page 19.

In the following you can select the audio input that will be associated with the Video input selected on the screen by pressing the appropriate Source Selection Button **1** on the remote. When e.g. "Optical" has been set for the Video Audio Input, the optical input on the unit will be selected when the **VIDEO** Button **1** is pressed (no matter how often).

**Audio:** Selects the Surround Mode of your choice when listening to your TV or any source connected to the screen and selectable by the **VIDEO** or **PC** button **1** (see Audio Inputs below). Once set to "Dolby PLII", all stereo signals are converted into a 5-channel surround signal, while all digital multichannel signals are kept in their original form. This setting is recommended. "Original" will keep the original digital format without any surround processing.

**TV Audio Input:** The default setting for the TV Audio Input is Coaxial In. For proper functioning of the system, this setting should not be changed. Only when the **Coaxial input 9** of the unit must be used by external sources, "Line" should be selected and the screen be connected appropriately (see Important Note page 19).

**PC Audio Input:** This setting defines which Audio Input should be selected on the unit when the **PC** Button **1** on the remote is pressed.

**Video Audio Input:** This setting defines which Audio Input should be selected on the unit when the **VIDEO** Button **1** on the remote is pressed.

**Level adjustment:** This setting gives you the possibility to increase or decrease the input level of the TV, so that its sound will have the same level as the radio, the DVD player or the other audio inputs.

## AUX MENU

In addition to the built-in DVD-Audio/Video and CD player, and the built-in radio, you can connect one more analog audio source to the DVD receiver. The analog source can be connected to the AUDIO IN input **7** connectors on the rear panel.

1. Press the AUX button **21** on the remote control to turn the DVD Receiver on and select Aux as the source. Make sure your screen is switched on to be able to make the initial AUX setup with the use of the OSD menu. If the screen is not already on, switch it on by pressing the Screen Power On Button **35**, if the receiver's OSD is not visible press the AUX Button **21** again.
2. The TV monitor will show the AUX Menu, as shown below. You can also select the AUX Menu with the ARROW keys **10** on the remote control. Once the AUX tab is highlighted, press ENTER **7** to access it.

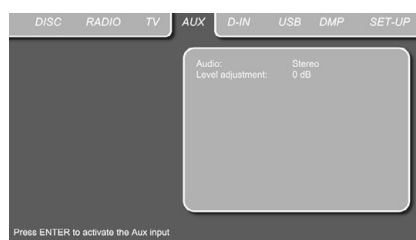

Figure 14

The AUX Menu contains the following settings. Follow the explanations in the Upper Menu Line on the bottom of your screen to change the settings.

**Audio:** Selects the Surround Mode you would like to use when listening to your additional analog audio source.

**Level adjustment:** This setting gives you the possibility to increase or decrease the input level of the analog input, so that its sound will have the same level as the radio, the DVD player or the other audio inputs.

## DIGITAL IN MENU

In addition to all analog audio and video sources, the Digital Lounge DVD receiver also gives you the opportunity to connect a digital audio source, for instance a digital set-top box or satellite receiver. Connect the source to the Coaxial Digital Input Connector **9** (see "Important Note" page 19) or the Optical Digital Input Connector **10** on the rear panel.

1. Press the D.IN button **21** on the remote control to turn the DVD Receiver on and select Digital In as the source. Make sure your screen is switched on to be able to make the initial DIGITAL IN setup with the use of the OSD menu. If the screen is not already on, switch it on by pressing the Screen Power On Button **35**, if the receiver's OSD is not visible press the D.In Button **21** again.
2. The TV monitor will show the D. IN Menu, as shown below. You can also select the D. IN Menu with the ARROW keys **10** on the remote control. Once the D. IN tab is highlighted, press ENTER **7** to access it.

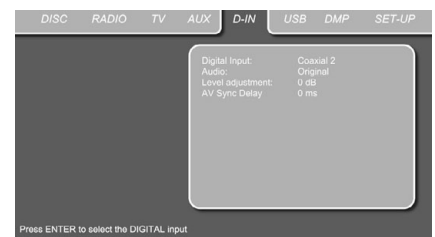

Figure 15

The DIGITAL IN Menu contains the following settings. Follow the explanations in the Upper Menu Line on the bottom of your screen to change the settings.

**Digital Input:** The default setting for the Audio Input is Optical In.

**Audio:** Selects the Surround Mode of your choice when listening to the digital audio sources. Once set to DPLII, all stereo signals are converted into a 5.1-channel surround signal, while all multichannel signals are kept in their original form. This setting is recommended. "Original" will reproduce the original digital format without any surround processing.

**Level adjustment:** This setting gives you the possibility to increase or decrease the input level of the digital input, so that its sound will have the same level as the radio, the DVD player or the other audio inputs.



## USB Menu / The Bridge

### USB MENU

The Harman Kardon Digital Lounge systems are among the first to allow direct playback of compatible files from portable USB devices. Two USB On-The-Go inputs are available, one on the right side of the product (USB 1) and one on the rear panel (USB 2).

Connect your USB thumb drive or portable hard disk, to either of the side or rear panel **USB Inputs** 4 17. If you have more than two devices that you would like to connect at the same time, you can use a standard USB-hub with an external power supply, to which you can connect up to 16 portable USB devices.

1. Press the USB 1 or USB 2 21 buttons on the remote control to turn the DVD Receiver on. In order to browse through your collection or to simply watch images stored on the drives, you can temporarily switch on your TV screen. If the screen is not already on, switch it on by pressing the Screen Power On Button 35, if the receiver's OSD is not visible press the USB Button 21 again.
2. The TV monitor will show the below screen, allowing you to select which of the file types available on the device you would like to display and play. Showing different file types at the same time like MP3 and JPEG is possible.
3. Move the cursor to the different file types, and press ENTER to select or deselect the requested file types. Once done, move the cursor to DONE, and press ENTER.

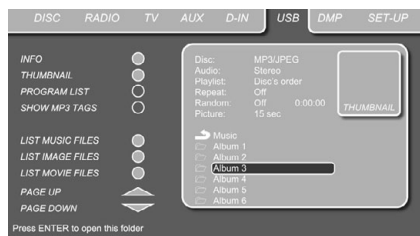

Figure 16

#### Important Notes:

- Via USB only the following files can be listed and played: MP3 or WMA music, JPEG pictures, DivX or XviD movie files. Normal MPEG2 movies, MPEG1, VCD/SVCD or MJPEG movie files will not be played.
- Only FAT32 formatted Hard Drives can be connected to USB. When your HD is preformatted with NTFS, it must be re-formatted with FAT32 before any files are stored onto it. Note that the FORMAT-function of Windows XP can create FAT32-partitions with max. 32 GB only. To use a bigger HD with FAT32, specific tools are needed (e.g. Norton Partition Magic or Acronis Partition Expert). Please ask your Dealer to get more information about those specific programs.

- With USB as source, programming and random functions are not available.

In case several USB devices are connected, all will be shown in the same USB Menu. To differentiate the drives, they will be shown as 1 and 2. USB drives can have more than one partition. If that is the case, the different partitions will be shown as 1a, 1b, 1c etc.

The USB Menu contains the following settings. Follow the explanations in the Upper Menu Line on the bottom of your screen to change the settings.

**Audio:** Shows the audio track that is currently playing. Options are shown on both Menu Lines on the bottom of the screen.

**Playlist:** Fixed to Discs's Order (programming not possible with USB).

**Repeat:** Sets the repeat mode. (Repeat All, Repeat Folder).

**Random:** Fixed to Off, Random play not possible with USB.

**Picture:** Selects the interval between the current picture on the screen and the next one.

In the USB Menu, the chapter, track or picture currently playing will be marked with an arrow symbol in front of the Track (MP3, WMA), Movie (DivX, XviD) or Picture (JPEG). Tracks and pictures can be selected from this list at any time by moving the cursor to the desired track or file and pressing ENTER 7 to confirm.

The top part of this screen can be de-activated to show the complete Track list on the screen. To de-activate, move the cursor to the upper INFO Submenu on the left side of the screen. Press ENTER 7 until the icon is highlighted in dark blue and the full Track list is visible on the screen. In the same way the Disc list can be removed from the screen by deactivating the PROGRAM LIST Submenu.

You will be able to use the THUMBNAIL function to quickly and easily search for image files. Any JPEG image file that has been created on the computer with a thumbnail image included, will show up on the right top of the screen when scrolling through the contents list. The Thumbnail function can be activated by moving the cursor to the Thumbnail icon on the left and pressing ENTER 7 until the icon is lit light blue.

When the DVD receiver is in play mode, pressing the PLAY button on the remote control will highlight the track being played.

If you have a USB device that contains both music files (MP3, WMA) and JPEG images, you can choose to run these simultaneously, mixing the MP3 or WMA audio with your own images. The time interval can be chosen in the Picture Setting.

With such devices, you can also either listen to the MP3 or WMA audio or watch the JPEG files only. In order to do so, click in stop mode on the LIST MUSIC FILES, LIST PICTURES or LIST MOVIES icons on the left part of the screen to select or deselect the desired format.

### Using The Bridge

When Harman Kardon's The Bridge is connected and a compatible Apple® iPod® is docked in The Bridge, press the **DMP Selector Button** 21 to choose the iPod as the input source allowing playback of audio materials on your iPod through your high-quality audio/video system.

When The Bridge is properly connected and a compatible iPod is properly docked, the **Upper Display Line** 1 will read **DMP I N**. Once that message appears, use the remote to control the iPod.

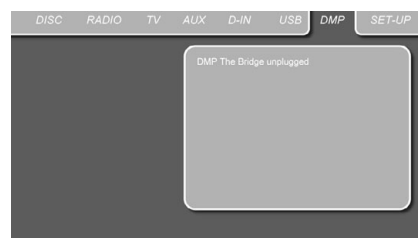

Figure 17a

Whether or not an iPod is docked in The Bridge, the screen shown in the figure above will appear on a video display connected to the Digital Lounge, but you will not be able to affect the screen without an iPod docked in The Bridge. Once an iPod is docked in The Bridge and selected as a source, the On Screen Display will change to show a reflection of your iPod menu.

## The Bridge / Surround Mode Chart

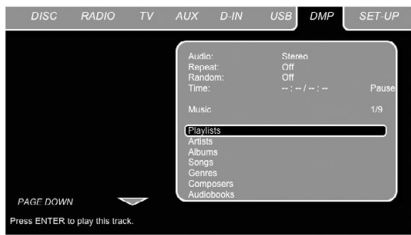

Figure 17b

Navigate The Bridge's screens by using the ▲▼◀▶ Buttons 10 to highlight a line and pressing the Enter Button 7 to select the line. Press the Menu Button 12 to return to the previous level of The Bridge's menu system.

**Audio:** Shows the audio track that is currently playing. Options are shown on both menu lines on the bottom of the screen.

**Repeat:** Sets the repeat mode. (Repeat 1, Repeat Folder).

**Random:** Activates Random Playback when possible.

**Time:** Shows the elapsed time and remaining time of a song currently playing.

**NOTE:** iTunes allows you to set certain selections to always or never remember playback position, or to be skipped in Shuffle mode. The Digital Lounge's settings cannot override these iTunes settings.

While a selection is playing, the song title, artist and album name, if available on the iPod, will scroll across the lower line in the front panel

**Message Display 1.** The upper line will display the elapsed time of the track on the left, the play mode icon, and the time remaining on the right.



Figure 17c

In addition, if a video display is connected to the Digital Lounge, a screen will appear to display information about the iPod's status and the track. The top line will display the play mode icon, with the phrase "Now Playing" appearing to the right to remind you that you are viewing the status of the current track, as opposed to another menu screen. Below that the Digital Lounge displays the total number of tracks in the current play list on the right (all materials on the iPod are considered one of the play lists) with the number of the current track on the left. The song title, artist and album are displayed. At the bottom of the screen is a graphic bar indicating the current play position within the track, with the elapsed and remaining times appearing below the bar.

## Surround Mode Chart

**Dolby Digital:** Available only with digital input sources encoded with Dolby Digital data. It provides up to five separate main audio channels and a special dedicated Low Frequency Effects channel.

**DTS:** Available only with digital input sources encoded with DTS data. Available on special High Definition, DVD, and audio-only discs, DTS provides up to five separate main audio channels and a special dedicated low frequency channel.

**Dolby Pro Logic II:** Dolby Pro Logic II is the latest version of Dolby Laboratory's benchmark surround technology that creates or decodes full range, discrete left, center, right, right surround and left surround channels from matrix surround encoded programs and conventional stereo sources. The Dolby Pro Logic II Movie mode is optimized for movie soundtracks that are recorded with matrix surround, by creating true rear left and right signals. The ProLogic II Music mode should be used with musical selections, that are recorded with matrix surround or with normal stereo mode, creating discrete rear left and right signals.

**Logic 7:** Exclusive to Harman Kardon products, Logic 7 is an advanced mode that extracts the maximum surround information from either surround-encoded programs or conventional stereo material.

The Logic 7 Movie mode should be used with any source that contains Dolby Surround or similar matrix encoding. Logic 7 Movie delivers increased center-channel intelligibility, and more accurate placement of sounds with fades and pans that are much smoother and more realistic than with former decoding techniques.

The Logic 7 Music mode should be used with analog or PCM stereo sources. Logic 7 Music enhances the listening experience by presenting a wider front soundstage and greater rear ambience. Both Logic 7 modes also direct low-frequency information to the subwoofer (if installed and configured) to deliver maximum bass impact.

## TV Functions

The Digital Lounge system offers several TV functions that require special attention. Please make yourself familiar with these functions by reading the chapter below.

To switch on the TV, press the **TV Button 1** on the remote control. The Digital Lounge system will switch on, shown by the amber Power On indicator switching to blue. Please note that for all the functions described below, the system needs to be in TV mode. When TV tuner signal is not shown on the screen, press the TV button again.

## Changing Channels

Once the TV has been selected as input, channels can be changed by pressing the number of the TV channel using the **numeric keys 29** on the remote control. For any of the channels that are stored at preset 10 and above, first press the first digit, quickly followed by the second digit.

Channels can also be changed with the **Preset Up and Down Buttons 22 J**. Each press of these buttons will select the next or previous TV channel. When you are changing a TV channel, a mini bar will appear on the right top of the screen, showing the selected TV channel and its name.

## Picture in Picture (PIP) Function

With this function you can watch two video inputs simultaneously on your Digital Lounge display. The second video input can either be shown in the right corner of the display, or the display can simply be divided in two equally big squares, each of them showing another video input. All video inputs that are connected to the display can be selected to run as a second video source, however there are some exceptions. If the HDMI, DVI, or YUV inputs have been chosen as main video input, the second video input can not be HDMI, DVI or YUV. Please note that only the analog TV tuner can be used in connection with PIP functions. The Digital (DVB-T) Tuner is not available for PIP use, even if it has been selected during Setup.

To activate the function, press the **Picture in Picture (PIP) Button 38** on the remote control. You will see that the second source will appear in a square on the right top of the screen. At the same time a mini bar will appear showing the two video inputs currently watched. The video input shown on the top is the original video input, and the one shown below is the second video input. Pressing the **PIP Button 38** again will show both video inputs in the same size. Pressing the **PIP Button 38** a third time will de-activate the Picture in Picture function.

When the Picture in Picture function is active, the main picture can be selected by the **Numeric Key Buttons 29** (when TV tuner is source) and the secondary picture by the **Presets Buttons 22** while pressing the PC or VIDEO **Source Selection** buttons **1** will toggle through all available PC and Video sources.

## Aspect Ratio

The Digital Lounge display allows for watching video sources in several aspect ratios. The default setting is Fill All and can be set to your personal taste for each individual input, as described on page 29. Should you wish to temporarily change the aspect ratio of a video input, press the **Screen Format Button 34** repeatedly until you have found your preferred picture format. With each press of the button, the current aspect ratio will be shown in the mini bar on the right top of the screen. Below is a short description of the different picture formats:

### Available picture formats for TV signals

**Normal:** This format setting displays a PAL 4:3 picture with the correct side ratio. Dark stripes are visible on the left and right-hand edges of the picture.

**Fill all:** In this format setting the picture is adapted in horizontal direction until the screen's width is filled completely. This format is needed to display all so called "Widescreen" (also named "16:9" or anamorphic) movies with optimal size and aspect ratio that will be stretched vertically in the "Normal" mode (see below).

**16:9:** In this mode the picture is scaled horizontally to the complete picture width, approx. 25 % in total being cut off the top and bottom of the picture recorded with 4:3 format.

### Available picture formats for PC signals over the DVI input

When you have a computer connected to the DVI input, the following picture formats can be chosen:

**Normal:** Displays the PC picture filling the complete height of the screen, without changing the side ratio. Dark stripes are visible on the left and righthand edges of the picture depending on the input format of the PC picture.

**Fill All, 16:9:** These are the same settings as with TV source described above.

**14:9:** With a 14:9 zoom the picture is enlarged vertically by a total of 15 %, i.e. approx. 15 % of the picture content is cut off vertically. Horizontally the picture is reduced in size in comparison with the full picture display by 15 %, i.e. narrow bars are displayed on the right and left. This mode is a good compromise to enlarge "4:3" video material (like e.g. from the TV tuner) and keeping the correct aspect ratio without cutting too much on top and bottom of

the picture. It can also be used with non-anamorphic pictures that will show a small frame around in Normal mode.

**One to one:** With this setting the number of visible screen pixels is adapted to the input signal, i.e. 1366 x 768 pixels are always reproduced by the PC picture for a screen resolution of 1366 x 768 while e.g. the frequently used PC graphics card resolution 1024 x 768 will fill the height of the screen and keep big black bars on the sides (as with a 4:3 video). This PC mode is recommended for getting PC Pictures with optimal performance.

### Available picture formats for all other video sources

**Normal, Fill All, 16:9, 14:9:** These are the same settings as with TV and PC source described above.

**Auto zoom:** This function is available with TV and analog inputs only. With the SCART inputs selected it evaluates the current picture format and switches automatically between normal mode and Fill All depending of the signal format (4:3, 16:9) received and the settings for the Aspect Ratio Detection made in the Scart Setup menu (see page 29). With other analog inputs selected, this function will sense black bars around the movie and, after some seconds, zoom it in all directions, filling the width of the screen while keeping the aspect ratio of the original.

This mode should be used for the full screen display of any non-anamorphic letterbox video material (with a black frame around).

**16:9 Top:** Select with picture in letterbox format as described above but with subtitles below. This will zoom the video and shift it upwards.

**14:9 Top:** Select with same pictures as above but with subtitles below. This will zoom the video and shift it upwards.

**Panorama:** This format setting scales the input signal automatically in horizontal direction to fit the full screen, but not linearly. i.e. the picture contents in the centre of the screen are displayed as the original and towards the edges more intense scaling takes place. This mode can be used to fill the screen horizontally with "4:3" material without affecting the centre part of the video too much.

## Teletext

Teletext, also known as Videotext, is an information system broadcast by some TV-channels. It can be consulted like an interactive newspaper for the latest news, sports and entertainment. Harman Kardon Digital Lounge teletext also offers access to subtitles for hearing impaired viewers. Colored buttons on the remote control give direct access to various pages, depending on the TV-channel.

To activate the teletext function, press the **Teletext Button 12** on the remote control. A first press will display the teletext instead of the TV channel you were watching. A second press will show both the TV channel you were watching to and the teletext next to each other. Pressing the **Teletext Button 12** again will de-activate the teletext function. It is also possible to have the teletext page shown with the TV image in the background. In order to do so, press the **Mix Button 14** when Teletext has been activated.

The first page of the teletext that will be displayed is always page 100, an index page used by all channels. Other pages can be searched for by pressing the page number on the top of the screen with the help of the **Numeric Keys 29** of the remote control. At all times, the index page can be re-called by pressing the **PG 100 Button 37**.

Once you have teletext on your screen, you will see that there are 4 colored squares on the bottom of the screen, each with a specific teletext page number in it. These colored buttons correspond to the colored buttons **5 24 25 30** on the remote control. Pressing the corresponding colored button on the remote control will select the page highlighted in the square. Note that the shown pages are dynamic, and change with each button press.

Some teletext pages contain additional sub pages. These sub pages can be selected directly by pressing the **SUB PG Button 37** on the remote control. Each button press will increment the sub page number to enable direct selection of the sub pages.

Note that as long as Teletext is activated no other source can be selected on the screen.

## Learning codes from a remote

The Digital Lounge remote is able to "learn" codes from other remote controls that might be part of your system setup, like the one from your TV. To learn or transfer codes from an IR remote to the DL's remote, follow these steps:

1. Place the front of the original remote with the code being sent so that it is facing the **IR Transmitter Window 33** on the DL remote "head-to-head." The remotes should be between 2 and 4cm apart.
2. Select the button on the remote that you wish to use as the device selector for the codes about to be entered. You can use the buttons VIDEO, PC and HDMI 1-2-3 **1**. The buttons TV, DVD and the six Audio On buttons **21** cannot be used for programming.
3. Press the **Learn button 26** and the Device Selector Button **1** selected in step 2 – keep them pressed until the device button light remains on. Release the buttons. It is important that you begin the next step within 25 seconds.
4. Press the button on the DL remote that you wish to program. Note that the Device button flashes once. To learn a command into the VIDEO, PC, HDMI1-2-3 buttons **1**, press these buttons for three seconds.

**Important Note:** Codes cannot be taught to all buttons on the remote. In these cases the button light flashes rapidly several times to indicate that this particular button cannot be programmed

5. As long as the **Device** button is on steadily (for five seconds), briefly press the button on the original remote that you wish to "teach" into the DL remote. If you pressed the button too late or no command was received within five seconds, the **Device** button flashes rapidly several times, then simply repeat step four. When the **Device** button flashes 4 times, the learning process has been successful for the chosen button.

**NOTE:** If the **Device** button remains red without flashing 4 times during Step 5, the programming was not successful. Repeat the steps to see if the code will "take." If the indicator remains red in step 5, this code cannot be taught.

6. Repeat steps 4 though 5 for each button on the source remote that you wish to transfer to the DL remote.

7. Once all codes have been transferred from the original source remote to the DL remote, press the **Learn button 26**. This will make the Device button flash 3 times to indicate that you have completed the Learn procedure, and turn off the learning mode. You may also wait 20 seconds, after which the remote exits learn mode automatically.

8. Repeat Steps 1 through 7 for any additional remotes you wish to "teach" into the DL Remote.

# Remote Control

## Erasing Learned Codes

The DL's remote allows you to remove or erase the code learned into a single button for a single device, to remove or erase all the codes that have been learned for a single device, or to erase all commands that have been learned to all devices.

### To erase a single learned code from within a single device's settings, follow these steps:

1. Press the **Learn Button** (26) and the **Device Selector Button** (in the System On group 1) together until the device button light remains on.
2. Release the buttons.
3. Press and release the **Device Selector** (1) again for the device within which the individual button to be erased has been programmed.
4. Press the **7** button (29) three times.
5. Press and release the individual button for which the code is to be erased. The **Device/System On** button blinks three times to confirm.
6. To erase other buttons within the same device, press them as noted in Step 5.
7. When all buttons to be erased have been pressed, press the **Learn** button (26) to complete the process.

**NOTE:** When the learned code has been erased, the button returns to the original code.

### To erase all codes within a single device, follow these steps:

1. Press the **Learn** button (26) and the **Device Selector Button** (in the System On group 1) together until the device button light remains on.
2. Release the buttons
3. Press the same **Device/System On** Button again.
4. Press the **8** Button (29) three times.

The **Device Button** blinks three times and goes out. You are done.

**NOTE:** When the learned codes for a device are erased, all codes for that device return to the original code.

### To erase all codes within all devices, follow these steps:

1. Press the **Learn** button (26) and any of the **Device Selector Buttons** (in the System On group 1) together, until the device button light remains on.
2. Release the buttons
3. Press the same **Device/System On** Button again.
4. Press the **9** Button (29) three times. The **Device Button** blinks three times and goes out. You are done.

**NOTE:** When all learned codes for all devices are erased, all devices return to their original codes.

### Resetting the complete remote:

You may also do this very simple operation to initialize the Remote to be returned to all factory codes:

1. Press the **TV** Button in the **System On** group and the **0** (29) Button simultaneously. The **TV** Button will light up.
2. Press the **3** Button (29) three times.
3. All the device buttons blink three times. You are done.

## DVD Language Codes

The availability of specific languages for the main audio track or subtitles is dependent on the choices made by a disc's producer. You should always consult the disc's jacket for information on languages for any disc. In the case of some languages, you may be required to enter a code from the list below to access that language.

Language	Code	Language	Code	Language	Code
Abkhazian	6566	Hausa	7265	Samoaan	8377
Afar	6565	Hebrew	7387	Sangho	8371
Afrikaans	6570	Hindi	7273	Sanskrit	8365
Albanian	8381	Hungarian	7285	Scots Gaelic	7168
Ameharic	6577	Icelandic	7383	Serbian	8382
Arabic	6582	Indonesian	7378	Servo-Groatian	8372
Armenian	7289	Interlingua	7365	Sesotho	8384
Assamese	6583	Interlingue	7369	Setswana	8478
Aymara	6588	Iunpiak	7375	Shona	8378
Azerbaijani	6590	Irish	7165	Sindhi	8368
Bashkir	6665	Italian	7384	Singhalese	8373
Basque	6985	Japanese	7465	Siswati	8383
Bengali; Bangla	6678	Javanese	7487	Slovak	8375
Bhutani	6890	Kannada	7578	Slovenian	8376
Bihari	6672	Kashmiri	7583	Somali	8379
Bislama	6673	Kazakh	7575	Spanish	6983
Breton	6682	Kinyarwanda	8287	Sundanese	8385
Bulgarian	6671	Kirghiz	7589	Swahili	8387
Burmese	7789	Kirundi	8278	Swedish	8386
Byelorussian	6669	Korean	7579	Tagalog	8476
Cambodian	7577	Kurdish	7585	Tajik	8471
Catalan	6765	Laothian	7679	Tamil	8465
Chinese	9072	Latin	7665	Tatar	8484
Corsican	6779	Latvian, Lettish	7686	Telugu	8469
Croatian	7282	Lingala	7678	Thai	8472
Czech	6783	Lithuanian	7684	Tibetan	6679
Danish	6865	Macedonian	7775	Tigrinya	8473
Dutch	7876	Malagsy	7771	Tonga	8479
English	6978	Malay	7783	Tsonga	8483
Esperanto	6979	Malayalam	7776	Turkish	8482
Estonian	6984	Maltese	7784	Turkmen	8475
Faroese	7079	Maori	7773	Twi	8487
Fiji	7074	Marathi	7782	Ukrainian	8575
Finnish	7073	Moldavian	7779	Urdu	8582
French	7082	Mongolian	7778	Uzbek	8590
Frisian	7089	Naru	7865	Vietnamese	8673
Galician	7176	Nepali	7869	Volapuk	8679
Georgian	7565	Norwegian	7879	Welsh	6789
German	6869	Occitan	7967	Wolof	8779
Greek	6976	Oriya	7982	Xhosa	8872
Greenlandic	7576	Oromo (Afan)	7977	Yiddish	7473
Guarani	7178	Panjabi	8065	Yoruba	8979
Gujarati	7185	Pashto, Pushto	8083	Zulu	9085
		Persian	7065		
		Polish	8076		
		Portuguese	8084		
		Quechua	8185		
		Rhaero-Romance	8277		
		Romanian	8279		
		Russian	8285		

# Troubleshooting

## For the Controller

If you experience any of the following difficulties while using the system, use this troubleshooting guide to help you remedy the problem. Should any problem persist, consult your authorized Harman Kardon dealer.

### No power.

- Is the power cord firmly plugged into the power outlet?
- One of the safety mechanisms may be operating. In this event, unplug the player from the power outlet briefly and then plug it in again.

### No picture.

- Check that the system is connected correctly and securely.
- The video cable may be damaged. Replace it with a new one.
- Make sure the system is connected to a video input on the TV (see page 19).
- Make sure the TV is turned on.
- Make sure the correct video input on the TV is selected for viewing with this system.

### Noise (interference) appears in the picture.

- Clean the disc.
- If video from this system has to go through your VCR to get to your TV, the copy-protection applied to some DVD programs could affect picture quality. If you still experience problems after checking your connections, please try connecting your DVD system directly to your TV's S-Video input, if your TV is equipped with this input (see page 19).

### The aspect ratio of the screen is wrong (picture vertically expanded) when you play a wide picture by the player or an external source connected to the screen even though you set "TV DISPLAY" in the SETUP menu to "Auto".

- If you connect the system or the external source with the SCART cable, connect directly to the TV. Otherwise the autoswitch function of the aspect ratio for the TV may not work.
- If the TV is not connected with a SCART cable to the DL (as recommended) or the external source, or if the autoswitch function does not work you should turn the TV to "Fill All".

### There is no sound or volume is very low

- Check that the speakers and components are connected correctly and securely.
- Make sure that you have selected the correct source on the system.
- Press **MUTE** on the remote control, if the words MUTE ON are blinking on the front panel display.
- The protective circuitry has been activated because of a short circuit. Turn off the system, eliminate the short circuit problem and turn on the power again.
- The audio interconnect is damaged. Replace it with a new one.
- The system is in pause mode or in slow-motion play mode, or fast forward or fast reverse. Press **▶** to return to normal play mode.
- Check the speaker settings (see page 34).

### The left and right channels are unbalanced or reversed.

- Check that the speakers and components are connected correctly and securely.

### Severe hum or noise is heard.

- Check that the speakers and components are connected securely.
- Check that the connecting cords are away from a transformer or motor and at least 3 meters away from fluorescent light.
- Move your TV away from the audio components.
- The plugs and jacks are dirty. Wipe them with a cloth slightly moistened with alcohol.
- Clean the disc.
- Disconnect antenna cables from external sources (also PC) connected to the screen or system. If hum disappears use an antenna transformer between antenna and source.
- If PC is connected to the system disconnect the Audio and Video cables. If hum disappears use an audio transformer between PC audio out and system input. If hum persists unplug PC from your system and ask your local dealer for a proper solution (ground loop interrupt).

### The surround effect is difficult to hear when you are playing a Dolby Digital sound track.

- Check to see if the Dolby Digital mode is turned on properly, otherwise unload and load the disc again.
- Check the speaker connections.
- Depending on the DVD disc, the output signal may at times be mono or stereo even if the soundtrack is recorded in Dolby Digital format.

### The sound comes from the center speaker only.

- Depending on the disc, sound may sometimes come from the center speaker only. This also applies to mono recordings (from disc or any analog source), when Pro Logic mode is selected. This is normal.

### No sound is heard from the center speaker.

- Adjust center speaker volume (see pages 34).

### No sound or only very low volume from the rear speakers.

- Adjust the rear speaker volume (see page 34).

### The volume goes down automatically and cannot be increased.

- The internal temperature is too high. Wait approximately one minute for the amplifier to reach normal working temperature.

### Radio stations cannot be tuned in.

- Check that the antenna is connected correctly. Adjust the antenna and connect an external antenna if necessary.
- The signal strength of the stations is too weak for automatic tuning. Use manual tuning.
- No stations have been preset.
- The tuner mode is not selected, select the Radio mode.

### The remote does not function.

- Remove any obstacles between the remote control and the system.
- Move the remote control closer to the system.
- Point the remote control at the remote sensor on the front panel.
- Replace all the batteries in the remote control with new ones if they are weak.
- Check that the batteries are loaded correctly.

### The disc does not play.

- There is no disc inside. ("NO DISC" appears on the front panel display and the TV screen.) Insert a disc.
- Insert the disc correctly with the playback side facing down.
- Clean the disc.
- The system cannot play CD-ROM's, etc. (see page 3).
- DVD with wrong region code (see page 3).

### Playback stops automatically.

- Some discs include an auto pause signal. When playing such a disc, the system stops playback at the signal.

# Troubleshooting

**Track Skip or direct select with numeric buttons, Search, Slow-motion play, repeat play or Program play, etc., cannot be done.**

- Depending on the DVD or VCD, some of the above operations may not be available (Playback control).

**Messages do not appear on the TV screen in the language you want.**

- Select the language for Display and Preferred Subtitle in the SETUP menu (see page 21). For all messages from the DVD (DVD menu, subtitles) in the proper language, the disc must have the language you selected, if not, another language will be selected.

**The audio language cannot be changed when you play a DVD.**

- Multilingual sound is not recorded on the DVD.
- Changing the language for the sound by the Audio button on the remote or the Audio line in the Player Menu is prohibited on the DVD. In that case the audio language must be selected by the main menu on the DVD.

**The subtitle language cannot be changed when you play a DVD.**

- Multilingual subtitles are not recorded on the DVD.
- Changing the language for the subtitles by the Subtitle button on the remote or the Subtitle line in the Player Menu is prohibited on the DVD. In that case the subtitle language must be selected by the main menu on the DVD.

**The subtitles cannot be turned off when you play a DVD.**

- Depending on the DVD, you may not be able to turn the subtitles off.

**The angles cannot be changed when you play a DVD.**



- Multi-angles are not recorded on most DVDs.
- Change the angles when the angle mark appears on the TV screen.
- Changing the angles is prohibited on some DVDs.

**The system does not operate properly.**

- Static electricity, etc., may affect the system's operation. Disconnect the AC power cord, then connect it again.

**Please also refer to the Troubleshooting guide contained in your loudspeaker Owners Manual**

## For the TV

Defect	Possible cause	Possible remedy
<b>No picture although the mains plug is inserted and the unit is switched on.</b>	<ul style="list-style-type: none"> <li>• Mains switch in position "0" (OFF).</li> <li>• Mains plug of unit is not inserted into the plug receptacle.</li> <li>• The HDMI cable is not properly inserted.</li> <li>• Defective mains cable.</li> </ul>	<ul style="list-style-type: none"> <li>• Shift mains switch to position "1".</li> <li>• Insert the mains cable plug into the plug receptacle.</li> <li>• Insert the HDMI cable firmly.</li> <li>• Call the service hotline.</li> </ul>
<b>Screen dark.</b>	<ul style="list-style-type: none"> <li>• Contrast setting too low.</li> <li>• No input signal, wrong input selected.</li> </ul>	<ul style="list-style-type: none"> <li>• Set the brightness and/or contrast correctly (see Picture Calibration).</li> <li>• Check the connection cable; assign correct input to source.</li> </ul>
<b>Weak or excessive colours.</b>	<ul style="list-style-type: none"> <li>• Colour not correctly set.</li> <li>• Connection cable not correctly connected.</li> </ul>	<ul style="list-style-type: none"> <li>• Set the colour correctly (see Picture Calibration).</li> <li>• Connect the cable correctly.</li> </ul>
<b>The picture is too large or too small.</b>	<ul style="list-style-type: none"> <li>• Picture format set wrongly.</li> </ul>	<ul style="list-style-type: none"> <li>• Repeatedly press the <b>Screen Format Button</b>  until the picture is displayed as full screen.</li> </ul>
<b>The displayed picture is too dark.</b>	<ul style="list-style-type: none"> <li>• The picture quality is not set correctly.</li> </ul>	<ul style="list-style-type: none"> <li>• Correct the picture brightness and contrast (see Picture Calibration)</li> </ul>
<b>The picture is displayed, but there is no sound.</b>	<ul style="list-style-type: none"> <li>• The sound is switched to mute.</li> <li>• The Coaxial Digital Audio cable is not properly inserted.</li> <li>• Volume is set to minimum.</li> </ul>	<ul style="list-style-type: none"> <li>• Press the Mute Button  on the remote control.</li> <li>• Insert the Coaxial Digital Audio cable firmly.</li> <li>• Increase the volume.</li> </ul>
<b>Horizontal stripes with TV or video signals.</b>	<ul style="list-style-type: none"> <li>• Signal source is placed in front of the display.</li> </ul>	<ul style="list-style-type: none"> <li>• Always place the signal sources on the side of or behind the display.</li> </ul>



## Bit rate

Value indicating the amount of video data compressed in a DVD per second. The unit is Mbps (megabit per second). 1 Mbps indicates that the data per second is 1,000,000 bits. The higher the bit rate, the larger the amount of data. However, this does not always mean higher quality pictures.

## Chapter

Sections of a picture or a music piece on a DVD that are smaller than titles. Many titles are composed of several chapters, but many others are not. Each chapter is assigned a chapter number enabling you to locate the chapter you want.

## Dolby Digital ("5.1", "AC-3")

This sound format for movie theaters is more advanced than Dolby Pro Logic Surround. In this format, the rear speakers output stereo sound with an expanded frequency range and a subwoofer channel for deep bass is independently provided. This format is also called "5.1" because the subwoofer channel is counted as 0.1 channel (since it functions only when a deep bass effect is needed). All six channels in this format are recorded separately for superior channel separation. Furthermore, since all the signals are processed digitally, less signal degradation occurs. The name "AC-3" comes from the fact that it is the third audio coding method to be developed by the Dolby Laboratories Licensing Corporation.

Manufactured under license from Dolby Laboratories. "Dolby", "AC-3", "Pro Logic" and the Double-D symbol are trademarks of Dolby Laboratories. Confidential Unpublished Works. © 1992, 1997 Dolby Laboratories, Inc. All rights reserved.

## Dolby Pro Logic II Surround

This is a method of decoding stereo or surround recordings that produces five channels from two-channel sound. Compared with the former Dolby Surround system, Dolby Pro Logic II Surround reproduces left-to-right panning more naturally and localizes sounds more precisely. To take full advantage of Dolby Pro Logic II Surround, you should have a pair of rear speakers and a center speaker. The rear speakers output stereo sound.

## DTS

Digital audio compression technology developed by Digital Theater Systems, Inc. This technology conforms to 5.1-channel surround. The rear channels are stereo and there is a discrete subwoofer channel in this format. DTS provides 5.1 discrete channels of high quality digital audio. Good channel separation is realized, because all channels are recorded discretely and processed digitally.

Manufactured under license from Digital Theater Systems, Inc. US Pat. No. 5,451,942 and other worldwide patents issued and pending. "DTS" and "DTS Digital Surround" are trademarks of Digital Theater Systems, Inc. © 1996 Digital Theater Systems, Inc. All rights reserved.

## MPEG AUDIO

International standard coding system to compress audio digital signals authorized by ISO/IEC. MPEG 1 conforms to up to 2-channel stereo, used on some DVD's as alternate (other language) track.

## DVD

A disc that contains up to 8 hours of moving pictures even though its diameter is the same as a CD. The data capacity of a single-layer and single-sided DVD, at 4.7 GB (Giga Byte), is 7 times that of a CD. Furthermore, the data capacity of a dual-layer and single-sided DVD is 8.5 GB, a single-layer and double-sided DVD 9.4 GB, and a dual-layer and double-sided DVD 17 GB. The picture data uses the MPEG 2 format, one of the worldwide standards of digital compression technology. The picture data is compressed to about 1/40 of its original size. The DVD also uses the variable rate coding technology that changes the data to be allocated according to the status of the picture. The audio data is recorded in Dolby Digital, DTS and/or PCM, allowing you to enjoy more natural audio presence. Furthermore, various advanced functions such as multi-angle, multilingual, and subtitles may be provided with the DVD.

## Multi-angle function

Various angles or viewpoints of the video camera for a scene are recorded on some DVDs.

## Multilingual function

Several languages for the sound or subtitles in a picture are recorded on some DVDs.

## Parental Control

A function of some (particular US) DVD's to limit playback of the disc by the age of the users. The limitation varies from disc to disc. When it is activated, playback is completely prohibited, violent scenes are skipped or replaced with other scenes and so on.

## Title

The longest sections of a picture or a music piece on a DVD; a movie, etc., for a picture piece on video software; or an album, etc., for a music piece on an audio software. Each title is assigned a title number enabling you to locate the title you want.

## Track

Sections of a music piece on a CD. Each track is assigned a track number enabling you to locate the track you want.

## PCM

Pulse code modulation, an uncompressed data formation.

## NTSC

National TV Systems Committee: a video standard used in USA.

## PAL

Phase Alternation Line: a video standard used in many European countries.

# Harman Kardon Digital Lounge Specifications

<b>Display</b>	Size / diagonal:	32" (81 cm), 40" (102 cm) or 46" (117 cm), 16:9 format
	Resolution:	1366 x 768 pixels HD ready for 32", 1920x1080 Full HD for 40" and 46".
	Colour display:	16.7 million colours
	Viewing angle:	178° typical
<b>Video standards</b>	Video:	DVB-T, PAL / SECAM / NTSC
	TV tuner:	DVB-T, PAL (BG, DK, I) / SECAM (BG, DK, L), 47 - 861 MHz (VHF, UHF, Hyperband)
	PALplus, Cinescope:	Automatic format detection (full screen)
	Formats:	4:3, 16:9 (top), 14:9 (top), panorama, Fill All
<b>PC Frequency Range</b>	Horizontal frequency:	30 - 80 kHz
	Vertical frequency:	50 - 90 Hz
	Clock frequency:	max. 110 MHz
	Resolutions (VGA analogue):	DOS: 640 x 480 @ 60 Hz, 720 x 400 @ 70 Hz,
		VGA: 640 x 480, SVGA: 800 x 600; WVGA: 848 x 480 @ 60 Hz
		XGA: 1024 x 768 @ 60 Hz
		WXGA: 1366 x 768 @ 60 Hz
		SXGA: 1280 x 1024 @ 60 Hz
	Recommended resolution:	1024 x 768 @ 60 Hz
	Formats:	1:1, Normal, 16:9, 14:9, Fill All
<b>Inputs / Connections / Synchronization</b>	PC / Video input port:	RGB analogue and automatic sync detection
	Video connections TV tuner:	IEC, 75 ohms input resistance
	SCART1:	RGB, CVBS input, CVBS output
	SCART2:	YC, CVBS input, CVBS output
	Y/C:	MiniDIN (HOSIDEN)
	YUV (CVBS):	3 x RCA Cinch (HDTV)
	CVBS:	RCA Cinch
	4xHDMI:	digital video/audio (HDTV)
	PC analogue/digital connection:	DVI-I: analog RGB digital DVI 1.0 - HDCP (HDTV)
	Stereo input:	2 x 2 RCA Cinch L/R 1Vrms (YUV (CVBS), YC)
		1 x PC AUDIO IN
		1 x RCA Cinch digital audio input (DIG IN COAX)
		2 x SCART 1 Vrms
	Digital audio output:	1 x RCA Cinch (DIG OUT COAX)
	Synchronization:	Sync on green, composite sync with automatic detection, Separate H and V sync
	Operator control elements:	Mains switch, IR remote control (OSD menu 10 languages), local operator control
<b>Operating Conditions</b>	Temperature:	+5 °C - +35 °C (in operation), -20 °C - +60 °C (storage)
	Air humidity:	20 % - 85 % (non-condensating) @ 35 °C
	Elevation:	max. 2,000 m (7,000 ft)
<b>Data Mains Connection</b>	Voltage supply:	230 V ~
	Mains frequency:	50 / 60 Hz
	Power consumption:	32": 170 W typical, < 3 W in standby mode
		40": 270 W typical, < 5 W in standby mode
46": 330 W typical, < 5 W in standby mode		
<b>Dimensions and weight</b>	Display with stand H x W x D:	32": 626 mm x 839 mm x 200 mm +- 3 mm
		40": 727 mm x 1031 mm x 280 mm +- 3 mm
		46": 793 mm x 1162 mm x 280 mm +- 3 mm
	Display without stand H x W x D:	32": 525 mm x 839 mm x 96 mm +- 3 mm
		40": 626 mm x 1031 mm x 113 mm +- 3 mm
		46": 702 mm x 1162 mm x 123 mm +- 3 mm
	Weight Display:	32": 13.5 kg +- 10%
		40": 24 kg +- 10%
		46": 29.5 kg +- 10%

# Digital Lounge Controller Specifications

<b>DVD player</b>	Pickup:	Semiconductor laser, wavelength 650nm
	Signal system:	NTSC / PAL
	Video signal horizontal resolution:	More than 480 lines (DVD)
	Video signal-to-noise ratio:	More than 60 dB (DVD)
	Audio frequency response: (Stereo)	DVD (PCM): 20 Hz ~ 22 kHz (+/- 1.0 dB) CD (PCM): 20 Hz ~ 20 kHz (+/- 1.0 dB)
	Audio signal-to-noise ratio:	More than 80 dB (PCM)
	Total harmonic distortion::	Less than 0.01% (PCM)
	Dynamic range:	DVD (PCM): More than 85 dB (EIAJ, 2 kHz) CD: More than 85 dB (EIAJ)
<b>Amplifer output</b>	Power (per channel):	65 W (6ohms)
	Signal-to-noise ratio:	> 85 dB
	Total Harmonic distortion:	< 0.2%
<b>FM Tuner</b>	System:	PLL quartz-locked digital synthesizer system
	Tuning range:	87.50 ~ 108.00 MHz
	Antenna terminals:	75 ohms, unbalanced
	Intermediate frequency:	10.7 MHz
<b>Video Outputs:</b>	HDMI™ Output: Video:	576p, 720p, 1080i HDMI Version 1.0-compliant HDCP Version 1.1-compliant
	Component Video Output:	Y: 1 Vp-p/75 ohms, sync negative polarity Cr: 0.7 Vp-p/75 ohms Cb: 0.7 Vp-p/75 ohms
	CVBS Video:	1 Vp-p 75 ohms
	S-video:	Y: 1 Vp-p 75 ohms C: PAL 0.3 Vp-p 75 ohms / NTSC 0.286 Vp-p 75 ohms
	<b>Audio line Outputs</b>	Audio L/R:
<b>General</b>	Power requirements:	AC 230 V, 50 Hz
	Max power consumption:	500 W
	Idle power consumption:	Less than 2 W
	Dimensions (WxHxD):	440 mm x 68 mm x 380 mm
	Weight:	8.5 kg

\* Designs and specifications are subject to change without notice.

Depth measurement includes knobs, buttons and terminal connections. Height measurement includes feet and chassis.

All features and specifications are subject to change without notice.

Harman Kardon The Bridge,  and Logic 7 are registered trademarks of Harman International Industries, Incorporated.

Dolby, Pro Logic and the double-D symbol are trademarks of Dolby Laboratories, registered in the United States and/or other countries.

 is a trademark of Harman International Industries, Inc.

All rights reserved.

DTS is a trademark of Digital Theater Systems, Inc.

Windows Media® Audio (WMA) is a proprietary file format developed by Microsoft.

DivX is a registered trademark of DivX, Inc.

HDMI, the HDMI logo and High-Definition Multimedia Interface are trademarks or registered trademarks of HDMI Licensing LLC.

# HKTS 11 Specifications

## HKTS 11 System

Frequency Response  
35Hz – 20kHz (-6dB)

## SAT-TS14 Satellites

Recommended Power  
10 – 120 Watts

Impedance  
8 Ohms nominal

Sensitivity  
86dB @ 1 Watt/1 meter

Tweeter  
One 1/2" dome, video-shielded

Midrange  
Dual 3" drivers, video-shielded

Dimensions (H x W x D)  
243mm x 100mm x 92mm

Weight  
1kg

## CEN-TS14 Center

Recommended Power  
10 – 120 Watts

Impedance  
8 Ohms nominal

Sensitivity  
86dB @ 1 Watt/1 meter

Tweeter  
One 3/4" dome, video-shielded

Midrange  
Dual 3" drivers, video-shielded

Dimensions (H x W x D)  
102mm x 241mm x 92mm

Weight  
1kg

## SUB-TS11 Subwoofer

Amplifier  
200 Watts RMS

Bass  
10" Woofer, bass-reflex enclosure

Dimensions (H x W x D)  
479mm x 340mm x 340mm

Weight  
15kg

All features and specifications are subject to change without notice.

Harman Kardon, The Bridge™, Bridge™, IIIIIB-Set+™ and Logic 7 are registered trademarks of Harman International Industries, Incorporated.

\* Trademarks of Dolby Laboratories.

DTS is a registered trademark of Digital Theater Systems, Inc.



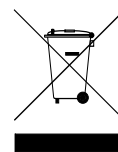

**harman/kardon®**

**H** A Harman International Company  
250 Crossways Park Drive, Woodbury, New York 11797  
516.422.HKHK (4545) Fax: 516.682.3523 (USA only)  
[www.harmankardon.com](http://www.harmankardon.com)  
Harman Consumer Group, Inc.  
2, route de Tours, 72500 Château-du-Loir, France  
© 2008 Harman Kardon, Incorporated  
Part No.: 04021804/532

## Free Manuals Download Website

<http://myh66.com>

<http://usermanuals.us>

<http://www.somanuals.com>

<http://www.4manuals.cc>

<http://www.manual-lib.com>

<http://www.404manual.com>

<http://www.luxmanual.com>

<http://aubethermostatmanual.com>

Golf course search by state

<http://golfingnear.com>

Email search by domain

<http://emailbydomain.com>

Auto manuals search

<http://auto.somanuals.com>

TV manuals search

<http://tv.somanuals.com>