

GAS-FIRED



LISTED

HEAT-N-GLO®

LifeStyle Products

Hearth & Home Technologies Inc.
20802 Kensington Blvd.
Lakeville, MN 55044
www.fireplaces.com

INSTALLATION & OPERATING INSTRUCTIONS

OGL-42-NG, OGL-42-LP

OUTDOOR GAS LOG SET



WARNING: If the information in this manual is not followed exactly, a fire or explosion may result causing property damage, personal injury or loss of life.

- Do not store or use gasoline or other flammable vapors and liquids in the vicinity of this or any other appliance.
- What to do if you smell gas
 - Do not try to light any appliance.
 - Do not touch any electrical switch; do not use any phone in your building.
 - Immediately call your gas supplier from a neighbor's phone. Follow the gas supplier's instructions.
 - If you cannot reach your gas supplier, call the fire department.
- Installation and service must be performed by a qualified installer, service agency or the gas supplier.

WARNINGS!

- For outdoor use only!
- This appliance is tested and listed for use only with the optional accessories listed in these instructions. Use of optional accessories not specifically tested for this appliance could void the warranty and/or result in a safety hazard.
- Improper installation, adjustment, alteration, service or maintenance can cause injury or property damage. Refer to this manual. For assistance or additional information, consult a qualified installer, service agency or the gas supplier.

Table of Contents

A. Listings and Code Approvals	2
B. Service Parts List	3
C. Installation of the Log Set	5
D. Lighting Instructions for the "S" Series	8
E. Maintenance Instructions	9
F. Troubleshooting - "S" Series	10
Index	12

Note: An arrow (➔) found in the text and in the index signifies change in content.

Safety Precautions

1. Please read these installation instructions completely before beginning installation procedures. Failure to follow them could cause an appliance malfunction resulting in serious injury and/or property damage.
2. Always check your local building codes prior to installation. The appliance installation must comply with all local, regional, state and national codes and regulations.
3. **NEVER** leave children unattended when there is a fire burning in the appliance.
4. This gas appliance is not built for solid fuel. **NEVER** use gasoline, gasoline type lantern fuel, kerosene, charcoal lighter fluid, or similar liquids in this appliance. Keep any flammable liquids a safe distance from the appliance.
5. **DO NOT** use chimney cleaners or flame colorants in your appliance.
6. While servicing this appliance, always shut off any electricity or gas to the appliance. This will prevent possible electric shock or burns. Also, make sure the appliance is completely cooled before servicing.
7. To avoid the risk of damaging appliance materials and increasing the risk of spreading a fire, do not use the appliance to cook or warm food.

A. LISTINGS AND CODE APPROVALS

This appliance has been tested and listed in accordance with **CSA 4-96 U.S. (2nd edition), Outdoor Gas Fireplaces and UL127, Factory-Built Fireplaces** standards, and has been listed by Underwriters Laboratories Inc. for installation and operation in the United States and Canada as described in this manual.

Check with your local building code agency prior to installing this appliance to ensure compliance with local codes, including the need for permits and follow-up inspections. In the absence of local codes, comply with the **Natural Fuel Gas Code, ANSI Z223.1-Latest Edition** in the United States and **CAN/CGA B149 Installation Codes** in Canada.

If you need assistance during installation, please contact your local dealer or the Heat-N-Glo Technical Services Department, Hearth & Home Technologies Inc. at 1-888-427-3973.

OGL	Natural Gas	Propane Gas
Minimum Pressure	7.0 in. w.c.	11.0 in. w.c.
Maximum Pressure	10 in. w.c.	14.0 in. w.c.
Max. Input BTUH	61,000	52,000

WARNING!

This appliance and its components are designed to be installed and operated as a system. Any alteration to or substitution for items in this system, unless allowed by these installation instructions, will void the Underwriters Laboratories listing and may void the product warranty. It may also create a hazardous installation. Read through these instructions thoroughly before starting your installation and follow them carefully throughout your project.

This page left blank intentionally.

B. SERVICE PARTS LIST

**BURNER TUBE w/ORIFICE
(exploded view)**

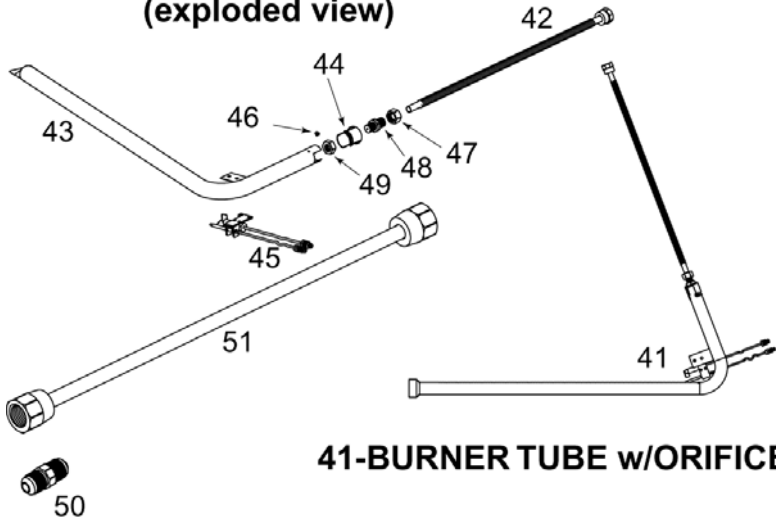

41-BURNER TUBE w/ORIFICE

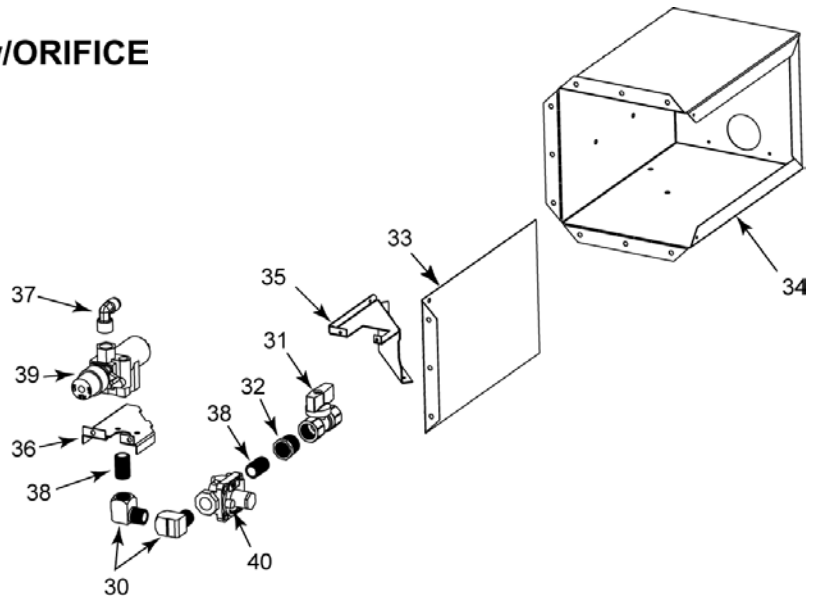

28 - VALVE ASSEMBLY-LP

29 - VALVE ASSEMBLY-NG (does not include 38 & 40)

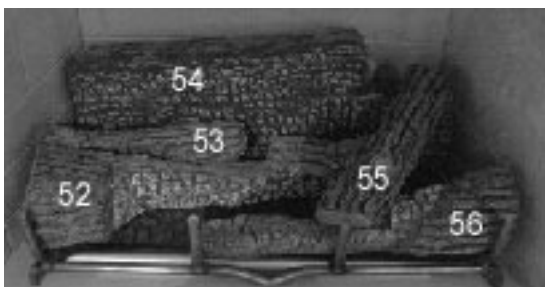

58 - Log Assembly

See following page for parts' descriptions.

#	Description of Part	OGL-42-NG	OGL-42-LP	Qty.	R
28	Valve Assembly - LP	---	4036-005	1	Y
29	Valve Assembly - NG	4036-006	---	1	Y
30	Elbow, 90° Brass	4021-027	4021-027	2	Y
31	ON/OFF Valve	4021-028	4021-028	1	Y
32	Bushing - 3/8 F NPT / 1/2 M NPT	4021-030	4021-030	1	Y
33	Valve Box Plate	4036-122	4036-122	1	Y
34	Valve Box Base	4036-123	4036-123	1	Y
35	Valve Bracket	4036-124	4036-124	1	Y
36	Valve Plate	4036-125	4036-125	1	Y
37	Connector, Brass 90° - Flex	14326	14326	1	Y
38	Pipe Nipple 3/8 NPT	4021-041	4021-041	2	Y
39	RS Safety Pilot Valve	33992	33992	1	Y
40	Regulator (LP ONLY)	---	34028	1	Y
41	Burner Tube Assembly - LP	---	4036-018	1	Y
41	Burner Tube Assembly - NG	4036-019	---	1	Y
42	18" Flex Tube	4021-032	4021-032	1	Y
43	Burner Tube w/Pilot Bracket	4036-013	4036-013	1	Y
44	Air Shutter	4036-315	4036-315	1	Y
45	RS Safety Pilot Assembly - NG	4036-510	---	1	Y
45	RS Safety Pilot Assembly -LP	---	4036-511	1	Y
46	Screw - #6 x 3/16 SMS PPH CAD/ZINC	15906A	15906A	1	Y
47	Compression Nut	32553	32553	1	Y
48	Orifice (LP)	---	32562	1	Y
48	Orifice (NG)	35321	---	1	Y
49	Jam Nut 1/2-20 803-823	32563	32563	1	Y
50	3/8 SAE Flare, Hex Nipple	4021-031	4021-031	1	Y
51	18" Aluminum Tube Assembly	4036-810	4036-810	1	Y
	Valve Access Door	4036-870	4036-870	1	Y
58	Log Set	4036-700	4036-700	1	Y
52	Log, Front Left	4036-703	4036-703	1	Y
53	Log, Left Center	4036-705	4036-705	1	Y
54	Log, Rear	4036-701	4036-701	1	Y
55	Log, Right Center	4036-704	4036-704	1	Y
56	Log, Front Right	4036-702	4036-702	1	Y
	Burner Support	4036-126	4036-126	2	Y
	* Fiber Ash Bed	4036-730	4036-730	1	Y
	* Lava Rock	28911	28911	1	Y
	* Consumable, not a warranted part				

C. INSTALLATION OF THE LOG SET

1. Gas Line and Valve Assembly Installation

SAFETY:

This outdoor gas log set must be installed in a UL-listed outdoor fireplace that has a gas knockout on the right side with the following minimum firebox dimensions:

Depth: 19 inches
Height: 23 inches
Rear Width: 23 inches
Front Width: 42 inches

Suitable fireplaces would be STS42, OUT42, Montana.

Note: Although knockouts are provided on both sides of the fireplace, the gas inlet should be routed to the right side of the fireplace.

- a. Place the burner assembly in the appliance, hand-bend the flexible stainless steel gas line as shown in Figure 1 and feed the thermocouple line, pilot line and stainless steel flexible gas line through the hole in the right side of the appliance. **Make sure the excess pilot and thermocouple line is OUTSIDE the box.**
- b. The appliance is provided with a stainless steel flexible connector and a listed (and Commonwealth of Massachusetts approved) tee-handle manual shutoff valve.
- c. Remove the right side of the valve box for easier installation of the gas line. Set aside.
 - 1) Bend the flanges of the remaining three sides of the valve box 90° at the perforations (Figure 2), place a bead of silicone (not provided) on the back side of the flanges and slide the valve box into the square hole on the side of the FPS enclosure. (If you are not using an FPS enclosure, the valve must be located in an accessible position where one person can operate the valve and light the pilot simultaneously.) All connections within the enclosure need to be accessible for future maintenance or troubleshooting.
 - 2) Secure the 3-sided valve box to the FPS enclosure with the drywall screws provided. See Figure 3.
- d. Remove the valve from the valve box for ease of assembly by removing the two screws holding the valve to the valve bracket.

Note: Have the gas supply line installed in accordance with building codes by a qualified installer approved and/or licensed as required by the locality. In the Commonwealth of Massachusetts, installation must be performed by a licensed plumber or gas fitter.

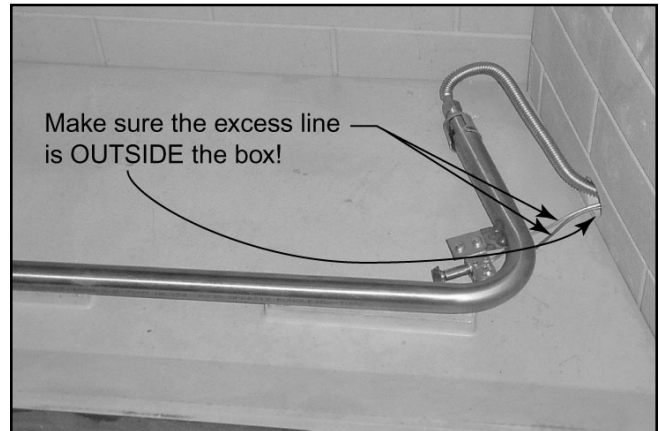

Figure 1 - Placing the Burner Assembly

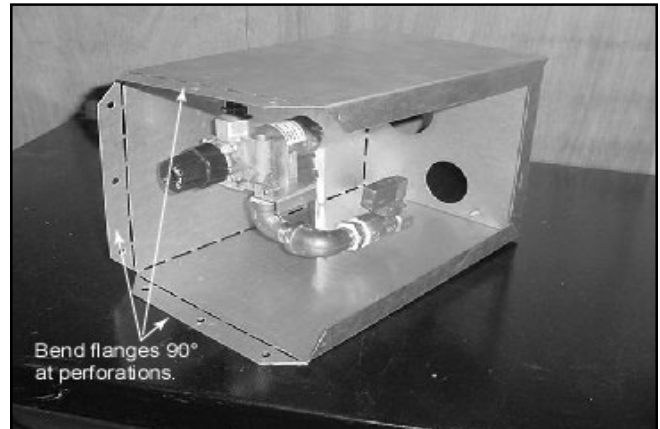

Figure 2 - Remove Right Side of Valve Box & Bend Flanges

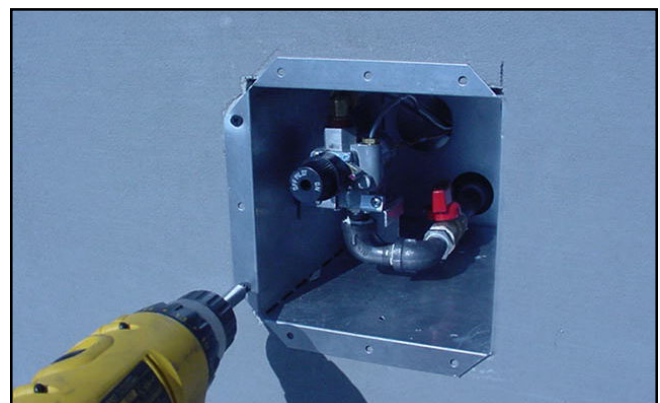

Figure 3 - Secure Valve Box to FPS

- e. Reach through the back access hole of the enclosure and feed the thermocouple line, aluminum gas line and pilot line through the rear of the valve box assembly. Connect to the valve. See Figure 4. Tighten fittings to eliminate gas leaks.

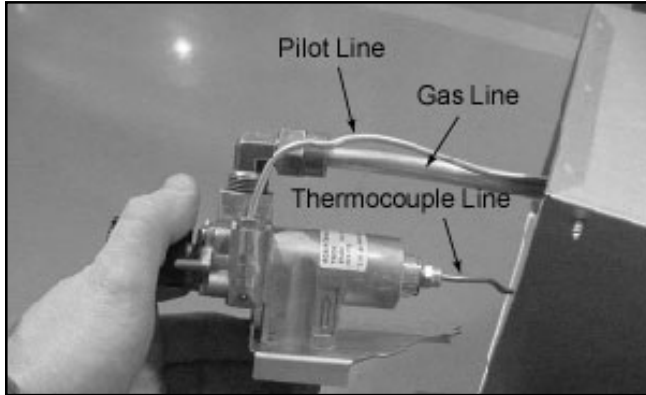

Figure 4 - Connect Lines to Valve

- f. Place the valve back on the valve bracket in the valve box and secure using the two screws previously removed.
- g. Reach through the back access hole of the enclosure and connect the flexible stainless steel gas line to the soft aluminum gas line with the male flare connector supplied. See Figure 5.

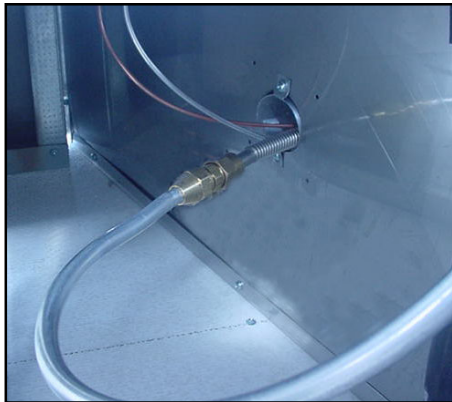

Figure 5 - Connect Flexline

- h. Connect the main gas line to the manual shutoff valve using 1/2" male pipe thread (not supplied). Bend the flange of the right side of the of the valve box 90° at the perforations, place a bead of silicone on the back side of the flange and replace in the valve box. Fasten with remaining screws.
- ➔ i. All connections must be tightened and checked for leaks with a commercially available, non-corrosive leak check solution. Be sure to rinse off the solution when done leak testing.
- j. Place a bead of silicone around the inside flanges and the holes in the corners of the valve access door. Place the valve box cover on the valve box and secure using the mounting holes on the edge of the box.

2. Grate Assembly and Fiber Ash Bed

Note: The GR21 grate assembly used in the STS-42, OUT42, and Montana is not supplied with the OGL42 log set. If you are installing the log set in another UL-listed fireplace the GR21 grate can be ordered from Heat-N-Glo Lifestyle products.

- a. Position the burner tube on the stainless burner supports. See Figure 1.
- b. Place the fiber ash bed on the floor of the firebox, ensuring that it does not cover the burner.
- c. Position the grate assembly over the burner assembly and fiber ash bed, and center from left to right. The back legs will be located in the grate brackets.
- d. Attach the burner to the grate with the enclosed stainless steel wire to hold the burner in position. Wrap the wire around the burner and the grate bar. See Figure 6.

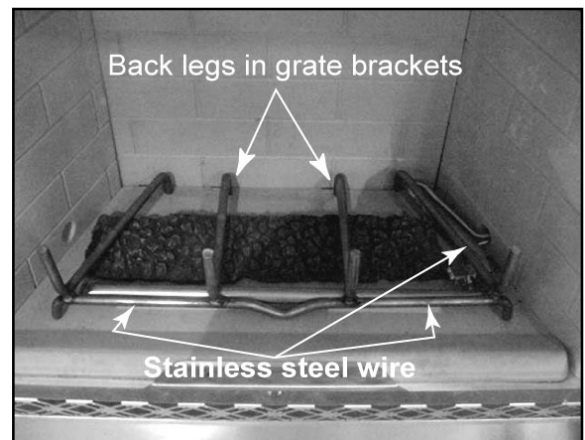

Figure 6 - Fiber Ash Bed

3. Log Placement

a. Rear Log

The rear log is placed on the grate against the back wall of the appliance. See Figure 7.

b. Front Right Log

Place the front right log on the grate against the front tines of the grate. See Figure 8.

c. Front Left Log

The front left log will be located on the grate with the left side of the log against the left front tine of the grate. The right side of the log will angle toward the center of the grate. See Figure 9.

d. Left Center Log

Place the left center log on the grate behind the front left log. See Figure 10.

e. Right Center Log

Place the right center log on top of the front right log and the rear log. See Figure 11.



Figure 7 - Rear Log



Figure 8 - Front Right Log



Figure 9 - Front Left Log



Figure 10 - Left Center Log

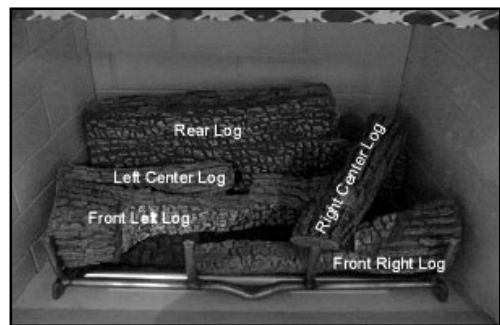

Figure 11 - Right Center Log

4. Lava Rock

Spread a two-pound bag of lava rock (included) between the burner and the ashlip. See Figure 12.



Figure 12 - Lava Rock

D. LIGHTING INSTRUCTIONS FOR THE "S" SERIES

FOR YOUR SAFETY READ BEFORE LIGHTING

WARNING: If you do not follow these instructions exactly, a fire or explosion may result causing property damage, personal injury or loss of life.



- | | |
|--|---|
| <p>A. This appliance has a pilot which must be lit by hand. When lighting the pilot, follow these instructions exactly.</p> <p>B. BEFORE LIGHTING smell all around the appliance area for gas. Be sure to smell next to the floor because some gas is heavier than air and will settle to the floor.</p> <p>WHAT TO DO IF YOU SMELL GAS</p> <ul style="list-style-type: none"> • Do not try to light any appliance. • Do not touch any electric switch; do not use any phone in your building. • Immediately call your gas supplier from a neighbor's phone. Follow the gas supplier's instructions. • If you cannot reach your gas supplier, call the fire department. | <p>C. Use only your hand to push in or turn the gas control knob. Never use tools. If the knob will not push in or turn by hand, don't try to repair it, call a qualified service technician. Force or attempted repair may result in a fire or explosion.</p> <p>D. Do not use this appliance if any part has been under water. Immediately call a qualified service technician to inspect the appliance and to replace any part of the control system and any gas control which has been under water.</p> |
|--|---|

Due to high surface temperatures, keep children, clothing and furniture away.

Keep burner and control compartment clean. See installation and operating instructions accompanying the appliance.

FOR YOUR SAFETY: Do not store or use gasoline or other flammable vapors and liquids in the vicinity of this or any other appliance.

LIGHTING INSTRUCTIONS

1. STOP! Read the safety instruction label.
2. Turn gas control knob clockwise  to "OFF".
3. Wait five minutes to clear out any gas. If you smell gas, STOP! Follow "B" on the safety information label. If you don't smell gas, go to next step.
4. Find pilot--follow metal tube from gas control. The pilot is behind the burner pan.
5. Turn knob on control counterclockwise  to "PILOT".
6. Push in the knob all the way and hold in. Immediately light the pilot with the use of a paper match and lighter rod. Continue to hold the control knob in for about one minute after the pilot is lit. Release button and it will pop back up. Pilot should remain lit. If it goes out, repeat steps 3 through 7.
If button does not pop up when released, stop and immediately call your service technician or gas supplier. If the pilot will not stay lit after several tries, turn the gas control knob to "OFF" and call your service technician or gas supplier.
7. Turn gas control knob counterclockwise  to "ON". Knob can be turned to "ON" only if the control knob is popped out.

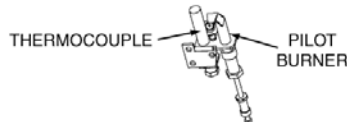

TO TURN OFF GAS APPLIANCE

1. Turn gas control clockwise  to "OFF". Do not force.

34008

E. MAINTENANCE INSTRUCTIONS

1. Cleaning the Burner and Control Compartment

Keep the burner and control compartment clean by brushing and vacuuming at least once a year. Always turn off the gas valve before cleaning.

2. Checking Flame Patterns

Check the flame of the burner periodically, making sure the flames are steady, not lifting or floating. Adjust the air shutter if necessary. The flame color should be blue with yellow tips. The thermocouple tip should be covered with flame. See Figure 13.

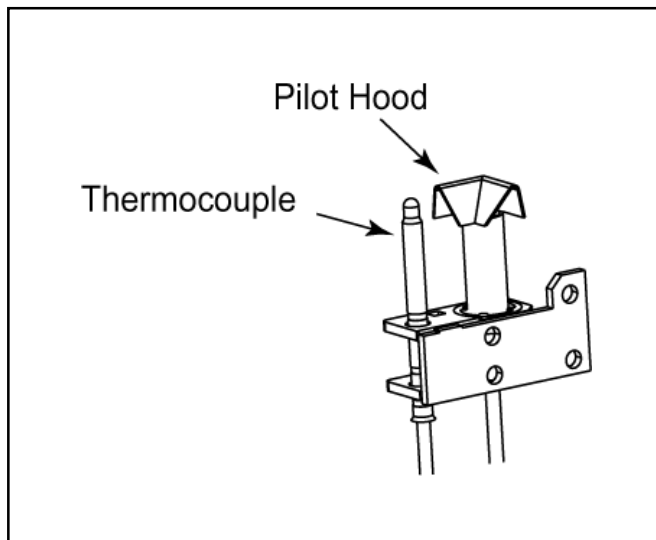

Figure 13 - Thermocouple

3. Adjusting the Air Shutter

To adjust the air shutter, remove the logs from the appliance. Loosen the screw on the burner air shutter and rotate the shutter to open. Tighten the screw and reinstall the logs.

4. Logs

a. Cleaning the Logs

Your gas logs require little care. Keep the burner assembly, logs and burner area surrounding the logs clean by vacuuming or brushing with a dry paint brush at least twice a year or as necessary.

CAUTION:

The logs can get very hot. Handle only when they are cool. After burning, the logs become fragile, so take care in handling.

Note:

- Always turn off the gas to the pilot before cleaning. For relighting, refer to lighting instructions in this manual.
- Always keep the appliance clear and free from combustible materials, gasoline, and other flammable vapors and liquids.
- Never obstruct the flow of combustion and ventilation air. Keep the front of the appliance clear of all obstacles and materials.
- Leave clearance of at least 36" from the front of the appliance.
- The air shutter should not be blocked.

b. Removing the Logs

Remove the logs in reverse order of placement (see "Log Placement").

5. Stainless Steel Parts

Weather and heat exposure may cause discoloration of stainless steel parts. This is normal and not warranted.

F. TROUBLESHOOTING - "S" SERIES

Symptoms	Possible Causes	Corrective Action
1. Match will not light pilot.	a. Main gas shutoff valve closed.	Make sure that the shutoff valve located on the incoming gas line is open.
	b. Air in the gas line.	Light a match. Turn valve knob to "PILOT" position and depress. Keep match near pilot burner until it lights.
	c. Valve knob is in "OFF" position.	Turn valve knob to "PILOT" position and depress. Keep match near pilot burner until it lights.
	d. Pilot orifice is plugged, not allowing gas to flow.	This repair requires tools and some degree of experience. Call a qualified service technician.
	e. No gas supply to the appliance.	Check the plumbing to ensure the appliance has been hooked up to the gas supply line. The propane tank is empty.
	f. Kink or break in line.	Replace line.
2. Pilot lights, but will not stay lit after carefully following lighting instruction.	a. Thermocouple too tight or too loose.	Thermocouple must be attached to the valve finger-tight, plus a 1/8 turn with a wrench.
	b. Weak pilot flame.	Pilot flame must engulf the thermocouple. Clean and/or adjust pilot for maximum flame impingement on the thermocouple.
	c. Defective thermocouple.	Check the thermocouple with a millivolt meter as follows: Disconnect the thermocouple from the valve and connect the red lead of the meter to the silver end of the thermocouple. Now connect the black lead of the meter to the copper tubing of the thermocouple. Light the pilot and keep the knob depressed while taking readings. The meter readings should be greater than 14 mV. If not, replace thermocouple.
3. Pilot "ON". No gas to main burner, valve knob "ON".	a. A blockage is preventing gas flow.	Inspect the burner orifice for obstruction, including spiders and webs. Call a qualified service technician.
	b. Defective valve.	Replace gas valve. Call a qualified service technician.
4. Irregular burn pattern.	a. Ice & debris clog ports.	Clear away ice or debris, being careful not to force that ice or debris into the ports.

Free Manuals Download Website

<http://myh66.com>

<http://usermanuals.us>

<http://www.somanuals.com>

<http://www.4manuals.cc>

<http://www.manual-lib.com>

<http://www.404manual.com>

<http://www.luxmanual.com>

<http://aubethermostatmanual.com>

Golf course search by state

<http://golfingnear.com>

Email search by domain

<http://emailbydomain.com>

Auto manuals search

<http://auto.somanuals.com>

TV manuals search

<http://tv.somanuals.com>