



CC330

Digital Camera

User Manual

WARNING

Do not expose the camera or other accessories to rain or humidity to prevent fire hazard or electric shock.

For customers in the U.S.A.

Tested To Comply With FCC Standards FOR HOME OR OFFICE USE

FCC Statement

This device complies with part 15 of the FCC Rules. Operation is subject to the following two conditions: (1) This device may not cause harmful interference, and (2) this device must accept any interference received, including interference that may cause undesired operation.

For customers in Europe



"CE" mark indicates that this product complies with the European requirements for safety, health, environment and customer protection. "CE" marked cameras are intended for sales in Europe.



This symbol [crossed-out wheeled bin WEEE Annex IV] indicates separate collection of waste electrical and electronic equipment in the European countries. Please do not throw the equipment into the domestic refuse. Please use the return and collection systems available in your country for the disposal of this product.

SAFETY PRECAUTIONS

Camera notes:

Do not store or use the camera in the following types of locations:

- In the rain, very humid and dusty places.
- In a place where the camera can be exposed directly to the sunlight or subject to high temperature, e.g. Inside a closed car in summer.
- In a place where the camera is subject to a high magnetic field, e.g. near motors, transformers or magnets.

Do not place the camera on a wet surface or places where dripping water or sand may come in contact with the camera, which may cause irreparable faults.

If the camera will not be used for a long period of time, we suggest you remove the battery and the memory card from the camera and keep them in dry environment.

If you carry the camera suddenly from a cold location to a warm place, moisture may condense inside the camera. We suggest you wait for a while before turning on the camera.

No compensation for loss of recordings. Loss of recordings cannot be compensated for if a malfunction of your camera or recording media, etc, makes the playback of recordings not possible.

Battery notes:

Incorrect use of the batteries may cause them to leak, become hot, ignite or burst. Always observe the precautions given below.

- Do not expose the batteries to water, and take particular care to keep the terminals dry.
- Do not heat the batteries or throw them into a fire.
- Do not attempt to deform, disassemble or modify the batteries.

Keep the batteries out of reach of babies and small children.

In cold locations, battery performance deteriorates and the time for which they can be used shortens markedly.

Memory card notes:

When using a new memory card, or a memory card has been initialized by a PC, be sure to format the card with your digital camera before using it.

To edit image data, copy the image data to the PC's hard disk first.

Do not change or delete the folder names or file names in the memory card from your PC, as this may make it impossible to recognize or misinterpret the original folder or file in your camera.

The photos taken by this camera are stored in the autogenerated folder in SD card. Please do not store photos that are not taken by this model of camera, as this may make it impossible to recognize the picture when the camera is in playback mode. Please do not expose the camera to harsh environments such as moisture or extreme temperatures, which may shorten the life of your camera or damage the batteries.

BEFORE YOU START

Preface

Thank you for purchasing this HP digital camera. Please read this manual carefully and keep it in a safe place for future reference.

Copyright

© Copyright 2011 Hewlett Packard All rights reserved.

No part of this publication may be reproduced, transmitted, transcribed, stored in a retrieval system, or translated into any language or computer language, in any form, by any means, without the prior written permission of Hewlett Packard.

Trademarks

All trademarks mentioned in this manual are used for identification purposes only and are properties of their respective owners.

Safety information

Please read the following important information carefully before using the product.

- Do not take apart or attempt to service the camera yourself.
- Do not drop or knock the camera. Improper handling may damage the product.
- Turn off the camera before inserting or removing the battery and memory card.
- Use only the type of battery that come with the camera. Using other types of batteries may damage the camera and invalidate the warranty.
- Do not touch the camera lens.
- Please not expose the camera to harsh environments such as moisture, or extreme temperatures, which may shorten the life of your camera or damage the batteries.
- Do not use or store the camera in dusty, dirty, or sandy areas, as its components may be damaged.
- Do not expose the lens to direct sunlight for extended periods.
- Download all pictures and remove the batteries from the camera if you are going to store the camera for long periods of time.
- Do not use abrasive cleansers, alcohol-based, or solvent-based cleaners to clean the camera. To clean, wipe the camera with a slightly damp soft cloth.

About the LCD Screen

When you turn the camera on, various icons are shown on the LCD screen to indicate the current camera settings and status. To learn more about the displayed icons, see “LCD Screen display” on page 19.

LCD Screen notes:

Extremely high-precision technology had been used to manufacture the LCD screen so that most of the pixels are operational for use. However, there may be some minute points (black, white, red, blue or green) that constantly appear on the LCD screen. These points are normal in the manufacturing process and the recording is not affected in any way.

Avoid exposing the LCD screen to water; please remove any moisture on the LCD screen with dry and soft cleaning cloth.

If the LCD monitor is damaged, take particular care with the liquid crystal in the monitor. If any of the following situations arise, take the recommended immediate action indicated below:



- If liquid crystal comes in contact with your skin, wipe the area with a cloth and then wash thoroughly with soap and running water.
- If liquid crystal gets into your eye, flush the affected eye with clean water for at least 15 minutes and then seek medical assistance.
- If liquid crystal is swallowed, flush your mouth thoroughly with water. Drink large quantities of water and induce vomiting. Then seek medical assistance immediately.

About this manual

This manual provides you with instructions on how to use your HP digital camera. Every effort has been made to ensure that the contents of this manual are accurate, however Hewlett Packard reserves the right to make changes without notice. Please visit this camera's support website for the latest revision of the user manual: www.hp.com/support

Symbols used in this manual

Throughout this manual, the following symbols are used to help you locate information quickly and easily:

	Indicates the useful information to know.
	Indicates precautions to be taken while operating the camera.

CONTENTS

WARNING	1
SAFETY PRECAUTIONS	2
BEFORE YOU START	3
Preface	3
Copyright	3
Trademarks	3
Safety information	3
About the LCD Screen	3
LCD Screen notes:	4
About this manual	4
Symbols used in this manual	4
CONTENTS	5
GETTING READY	10
Unpacking	10
Camera Views	10
Inserting the Battery and SD/SDHC Card (Not included)	12
Turning On and Off	13
Using the Mode Button	13
Setting Date/Time and Language	14
• Setting the Date and Time	14
• Setting the Language	14
BASIC OPERATION	15
Shooting in Auto Mode	15
Using the Zoom Function	15
Basic Functions Menu	15

- Flash 16
- Self-timer 16
- Macro Mode 16
- Exposure Compensation 16
- Advanced Functions Menu 17
- Size 17
- Quality 17
- WB (White Balance) 18
- Color 18
- ISO 18

USING THE MODES 19

- LCD Screen Display 19
- Still Picture Mode Display 19
- Video Shooting Mode Display 20
- Playback Mode Display 20
- Scene mode 21
- Sport 21
- Indoor 21
- Snow 21
- Fireworks 21
- Museum 21
- Night Landscape 21
- Children 21
- Leaf 21
- Sunset 21
- Glass 21
- Landscape 21
- Night Portrait 21
- Beach 21
- Text 21

• Gathering.....	21
• ID	21
• Fish eye	21
• Travel shooting	21
• Photo frame	21
• Sketch.....	21
Panorama mode.....	22
Stabilization mode	23
Face Detection	23
Blink Detection	23
Smile Detection	23
PLAYBACK	24
Viewing Photos and Videos	24
• Thumbnail View	24
• Using Zoom on Playback (for still pictures only)	25
• Using the Delete Button	25
USING THE MENUS	26
Still Menu	26
• AF Mode (Auto-Focus mode)	26
• Continuous AF	26
• Expo Metering (Exposure Metering)	26
• Continuous Shot	27
• Date Imprint	27
• Quick Review	27
• Digital Zoom	27
Movie Menu	28
• Continuous AF	28
• Expo Metering (Exposure Metering)	28
Playback Menu	28



• Protect	28
• Delete	29
• DPOF (Digital Print Order Format)	29
• Trim	30
• Resize	30
• Rotate	30
• Red-eye Reduction	30
Display Setup	31
• Slideshow	31
• Wallpaper Settings	31
• Menu Wallpaper.....	31
• Startup Screen.....	32
• Set back to defaults:	32
Setup Menu	32
• Beep	32
• LCD Brightness	33
• Power Saver	33
• Zone	33
• Date/Time	33
• Language	33
File and Software	34
• Format Memory	34
• File Numbering	34
• Copy to Card (Copy internal memory to memory card)	34
• Reset Settings	34
Transmission	35
Video System	35
Connecting to a PC	35
• Setting the USB Mode	35
• Transferring photos and videos to your PC	35

Connecting to a PictBridge Compatible Printer	36
• Setting the USB Mode	36
• Connecting the Camera and Printer	36
Using the PictBridge Menu	37
• Print with Date	37
• Print without Date	37
• Print Index	38
• Print DPOF	38
• Exit	38
APPENDICES	39
Specifications	39
Error Messages	40
Troubleshooting	41
Getting Help	42

GETTING READY

Unpacking

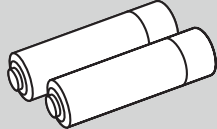
Your package should contain the camera model you purchased along with the following items. If anything is missing or appears to be damaged, please contact your vendor.

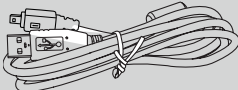
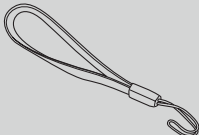
AA-size Alkaline Batteries	
Warranty Card	
CD-ROM	
USB Cable	
Wrist Strap	

Camera Views

Front View

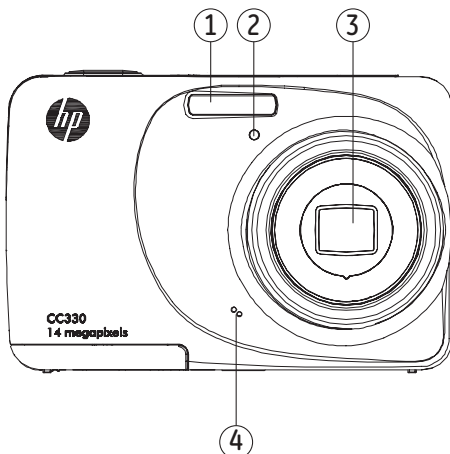

1. Flash Lamp
2. Timer Indicator
3. Lens
4. Microphone

Back View

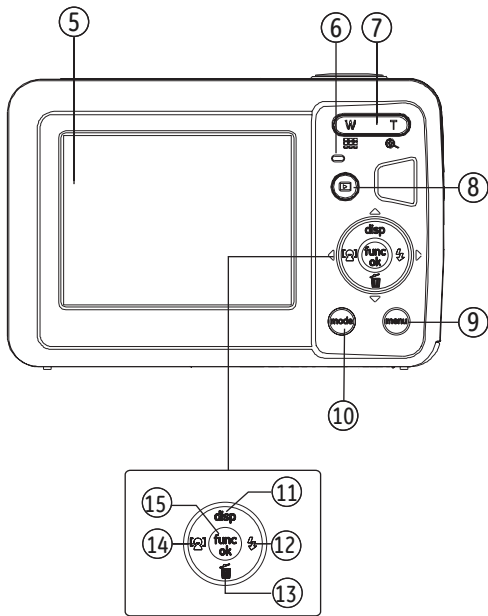

- 5. LCD Screen
- 6. Status Indicator
- 7. Zoom Toggle
- 8. Playback Button
- 9. Menu Button
- 10. Mode Selection Button
- 11. Display/Up Button
- 12. Flash Mode/Right Button
- 13. Delete Button/Down Button
- 14. Face Detection/Left button
- 15. Function/OK Button

Left / Right View

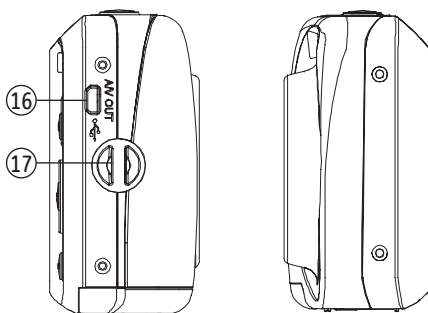

- 16. USB/AV Port
- 17. Wrist Strap

Top / Bottom View

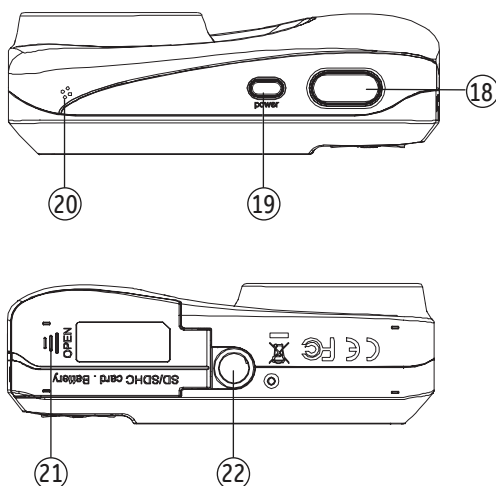

- 18. Shutter Button
- 19. Power Button
- 20. Speaker
- 21. Card Slot/Battery Compartment
- 22. Tripod Socket

Insert the Battery and SD/SDHC Card (Not included)

1. Open the battery compartment.

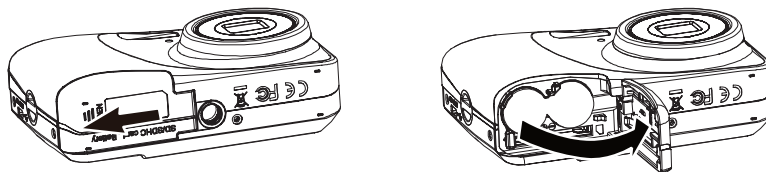

2. Insert the enclosed batteries into the battery slot in the correct direction.

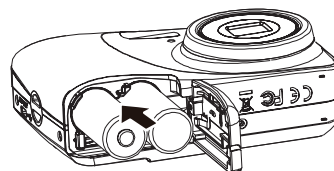

3. Insert an SD/SDHC card (not included) into the memory card slot as shown.

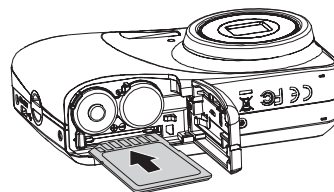

4. Close the battery compartment.

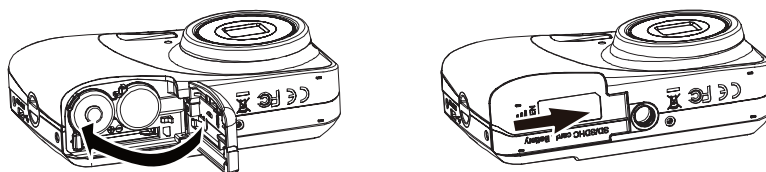

Optional SD/SDHC cards are not included. The use of 64MB to 16 GB memory cards from recognized manufacturers such as SanDisk, Panasonic and HP is recommended for reliable data storage.



To remove the SD/SDHC card, open the battery compartment and gently push the card to release it. Pull the card out carefully.



Turning On and Off

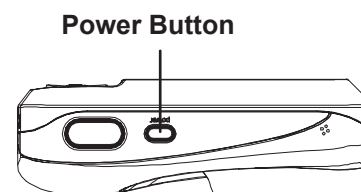



Press the Power button to turn the camera on. To turn off the camera, press the Power button again.



When the camera is turned on, it will be at the same shooting mode based on the last use. You can press the Mode button to select a different one after it is on. When using the camera for the first-time, the language setting page will appear. See next page for Language setting process.

Using the Mode Button

The HP camera provides a convenient Mode Button  that allows you to switch between different modes with ease. Use the Left/Right button to choose the desired mode and press  to select. All the available modes are listed as follows:

Mode Name	Icon	Description
Auto mode		Switch to take still pictures in automatic mode.
Panorama mode		Switch to capture a sequence of shots and stitch them together into a panoramic photo.
Stabilization mode		Switch to take still pictures by reducing the blurs caused by a shaking hand, under low luminance, or slow shutter speed.
Scene mode	SCN	Switch to take still pictures in 20 different scene types by your choice.
Movie mode		Switch to record videos.
Portrait		Switch to take portrait pictures under normal condition.

Setting Date/Time and Language





The Date/Time and Language setup will automatically appear when the camera is turned on the first time.

To set the language, date, and time, go to the following setup options in the **Setup** menu.

- Language
- Date / Time

To access the **Setup** menu, do the following:

1. Press **Power** to turn the camera on.
2. Press the  button, switch among the setting menus by using the Left/Right button to select the corresponding basic setting menu .

Setting the Language

1. Use the **Up/Down** button to go to the **Language**. Then press the **Right** button to enter the setting.
2. Use the Left/Right buttons to select the desired language.
3. Press the  button to confirm the setting.



Setting the Date and Time

1. Use the **Up/Down** button to select **Date/Time**. Then press the **Right** button to enter the setting.
2. Press the **Left/Right** to highlight each field and use the **Up/Down** to adjust the value.
3. Press the  button to confirm the setting.

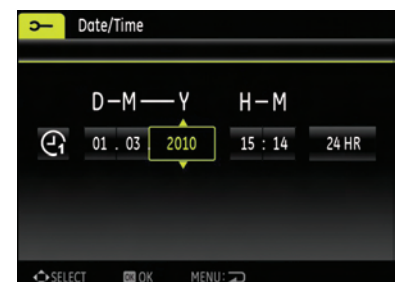

BASIC OPERATION

Shooting in Auto Mode

Auto mode is the easiest mode to take photos. While operating in this mode, the camera automatically optimizes your photos for best results.

To start shooting, do the following:

1. Press **Power** to turn the camera on.
2. In the Mode menu, select the Auto mode ().
3. Compose your picture on the LCD screen and press the Shutter button halfway to focus on the subject.
4. The LCD screen will show a green focus frame after the subject is in focus.
5. Press **Shutter** fully to capture the image.

Using the Zoom Function

Your camera is equipped with two types of zoom functions: optical zoom and digital zoom. Use the Zoom toggle of the camera to zoom in or out on the subject while taking pictures.

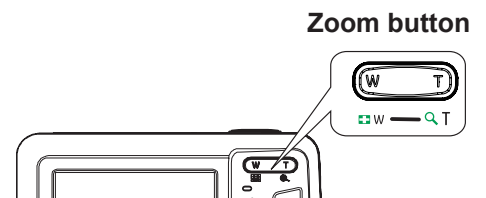

When the optical zoom reaches its maximum value, release the Zoom toggle then press it again for it to go further at the digital zoom. Zoom indicator is hidden after the Zoom toggle is released. The screen shows () for the current zoom status.

Basic Functions Menu



The Basic Function Menus of the camera include Flash, Self-timer, Macro Capture, and Exposure Compensation. The suitable function setting can let you shoot better photos.

Set the basic functions as per the following steps:

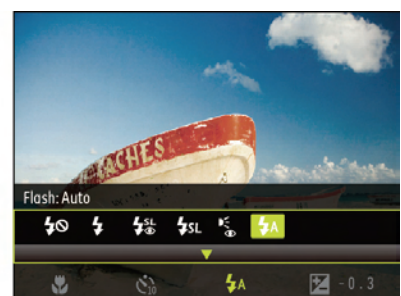
1. Pull up the Basic Function Menu by pressing Right/Flash button.







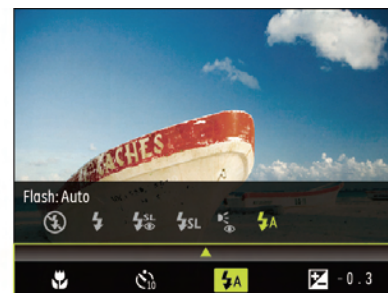

2. Press Left/Right button to select the settings of the required function.



- Press  button to confirm the settings and exit the menu, or press Down button to enter the selection screen of Basic Function.
- Press Left/Right button to select the basic functions required to set, press Up button to enter the setting screen for selecting basic functions, or press  button to confirm the settings and exit the screen.





Flash

Mode Name	Icon	Description
Flash : Auto		Camera flash goes off automatically based on existing light conditions.
Flash : Red-eye reduction		The camera exposes a brief flash before the picture is taken to reduce red-eye effects.
Flash : Forced flash		Flash always goes off.
Flash : Forced off		Flash always goes off.
Flash : Slow Synchro		This allows you to take pictures of people at night that clearly show both your subjects and the night time backdrop.
Flash : Red-Eye + Slow Synchro		Using this mode for slow synchro shots with red-eye reduction.

Self-timer

Mode Name	Icon	Description
Self-time : 2 sec		A single picture is shot 2 seconds after the Shutter button is pressed.
Self-time : 10 sec		A single picture is shot 10 seconds after the Shutter button is pressed.
Self-time : Off		Disable the self-timer.

Macro Mode

Mode Name	Icon	Description
Macro : On		Select this to focus on subjects 2 inches / 5 cm from the lens.
Macro : Off		Select this option to disable Macro.

Exposure Compensation

The exposure compensation allows you to adjust the light exposure value and shoot the best photo. The adjustable range of exposure value is from EV -2.0 to EV+2.0.

Advanced Functions Menu

The Advanced Functions Menu of the camera include Image Size, Image Quality, White Balance, Image Color and ISO etc. The suitable function setting can let you shoot better photos and videos.

Set the advanced functions as per the following steps:

1. Pull up the Advanced Function Menus by pressing  button.
2. Press Left/Right button to select the settings of the required function.



3. Press  button to confirm the settings and exit the menu, or press Down button to enter the selection screen of Advanced Functions.

4. Press Left/Right button to select the advanced functions required to set, press Up button to enter the setting screen for selecting advanced functions, or press  button to confirm the settings and exit the screen.



Size

The size setting refers to the image resolution in pixels. A higher image resolution allows you to print that image in larger sizes without degrading the image quality. 14 M is the default setting.

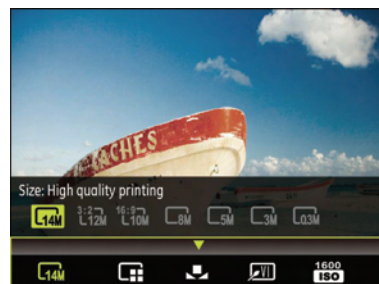

The larger the number of recorded pixels are, the better the image quality becomes. As the number of recorded pixels becomes smaller, you will be able to record more photographs on a memory card. A smaller setting may also be desired for web or e-mail publishing.

Quality

The quality setting adjusts the compression ratio of the images. Higher quality settings give better photos, but will take up more memory space.









The picture quality of image has totally three options:

		Quality : Best
		Quality : Fine (default setting)
		Quality : Normal

WB (White Balance)

The White Balance allows you to adjust the color temperature under different light source to ensure faithful color reproduction.

The options of White Balance include:

		WB : Auto (default setting)
		WB : Daylight
		WB : Cloudy
		WB : Fluorescent
		WB : Fluorescent CWF
		WB : Incandescent
		WB : Manual (Press the shutter button to set WB)

Color

The color setting allows you to add artistic effects directly when taking pictures. You can try different color tones to alter the mood of your pictures.

The color options include:

		Color : Auto (default setting)
		Color : Black & White
		Color : Sepia
		Color : Vivid

ISO

The ISO function allows you to set the sensitivity of the camera sensor based on the brightness of the scene. To improve the performance in darker environments, a higher ISO value is required. On the other hand, a lower ISO value is needed when in bright conditions.

Pictures at higher ISO will naturally have more noise than those at lower ISO.

The options of ISO include AUTO (default setting), 80, 100, 200, 400, 800 and 1600.

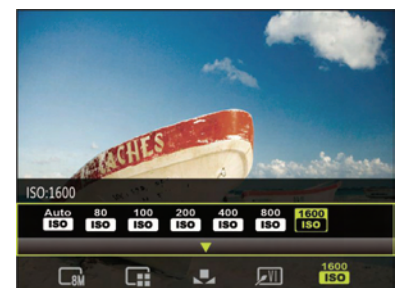

USING THE MODES

LCD Screen Display

Still Picture Mode Display



1 Shooting Mode Icons

	Auto mode		Panorama mode
	Scene mode		Stabilization mode
	Portrait		

2 AF (Auto Focus) Mode

	Single-AF		Multi-AF
---	-----------	---	----------

3 Exposure Metering

	Spot		Center
	AiAE		



4 Zoom Scale

5 Remaining number of pictures

6 Battery Status

7 Memory card/built-in memory

8 White Balance

9 Exposure

10 ISO Value

11 Histogram

12 Continuous Shot

13 Picture Color

14 Smile face detection enabling icon

15 Image Quality

16 Image Size

17 Macro Mode

18 Self-timer

19 Flash Mode

20 Focus Frame

Video Shooting Mode Display

- 1 Video Mode icon
- 2 Continuous AF (Auto focus)
- 3 Exposure Metering
- 4 Zoom Scale
- 5 Remaining time for Video Recording
- 6 Battery Status
- 7 Memory Card/Built-in Memory
- 8 Exposure
- 9 Self-timer
- 10 Focus Mode
- 11 Video Quality
- 12 Recording Status Icon

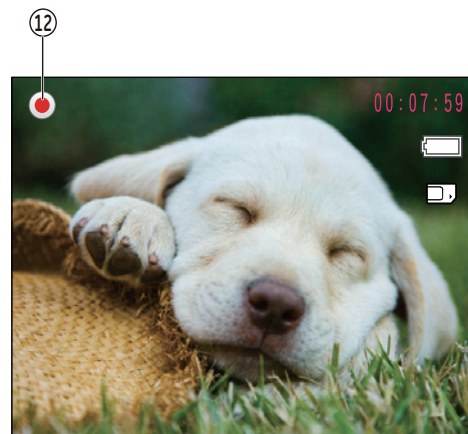
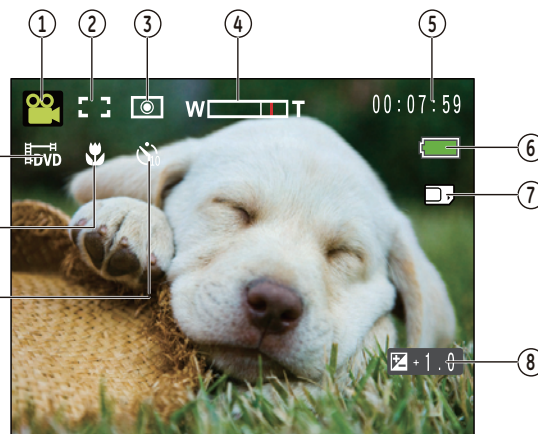
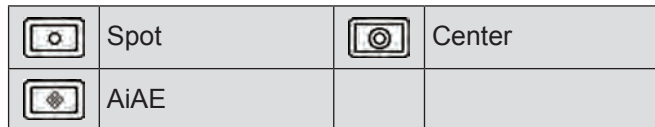

For optimal video shooting, it is recommended that the SD card be used. If you shoot videos with the limited built-in memory as a result of short video recording, there may be picture jitter and noise.



During video shooting, the optical zoom is fixed but the highest 4.5x digital zoom is still available.

Playback mode display



1. Play Mode icon
2. DPOF (Digital Print Order Format) file
3. File protection
4. Picture Number
5. Memory Space (this picture/Total number of pictures)
6. Battery Status
7. Memory Card/Built-in Memory
8. Image Zoom
9. The current display area
10. Affecting regional
11. Recording Date and Time
12. OK: PLAY (film gear prompt)
13. DPOF









Scene mode



In **Manual Scene** mode, you can select from a total of 20 scene types to match your needs. You just need to select the right scene for the occasion and the camera will automatically adjust to the optimal settings for you.

Press the  button, highlight the Scene Mode icon  with the Left/Right button. Press the  to enter the Scene mode menu.

Select a scene using the Left/Right button and press the , or press the  to exit the menu.



Mode Name	Icon	Description
	Sport	For fast-moving subjects. Capture sharp action shots without blur.
	Indoor	For indoors. Reduce blur and improve color accuracy.
	Snow	For snow scenes. Reproduce natural and clear white scenes.
	Fireworks	For fireworks at night. Slow shutter speed adjusted for brilliant images. Use of a tripod is recommended.
	Museum	For museum or flash-free area. Retain color and reduce blur.
	Night Landscape	For night scenes. Use of tripod is recommended.
	Children	For kids and pets. Flash is disabled for eye protection.
	Leaf	For plants. Capture brilliant shots of greenery and blossoms.
	Sunset	For sunsets. Capture subjects in strong sunlight.
	Glass	For objects behind transparent glass.
	Landscape	For landscapes. Vivid reproduction of green and blue.
	Night Portrait	For portraits against night time scenery.
	Beach	For taking good pictures in the scenes with strong sunlight.
	Text	For shooting text materials to get clear photos on documents or white boards.
	Gathering	For shooting person image when gathering indoor, it can present naturally even though under complicated lighting.
	ID	For shooting certificates clearly.
	Fish eye	For increasing interesting fish eye effect for shooting. Expand the central part intentionally to get distortional photo similar as watching through fish eye.
	Travel shooting	For shooting fast moving object clearly with clear main body and flowing sense of background.
	Photo frame	For adding interesting frame.
	Sketch	For taking photos with pencil sketch effect.

1. After selecting the scene type, press the  button to activate.
2. To select a different scene type, press the  button to enter the main function menu. Then press it again to return to the Scene selection menu.





The main function menu also allows you to adjust the image quality and image size. Please refer to the "**Advanced Functions Menu**" section on page 17 for detailed instructions.





Panorama mode

Panorama mode  allows you to create a panoramic picture across a distant scene. The camera will automatically compose a panoramic picture using the individual shots that you take.

Follow these steps to create a panoramic picture:

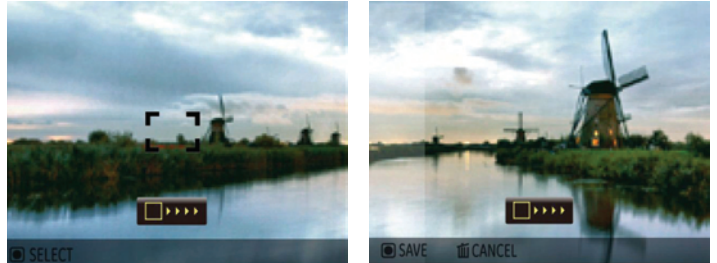
1. Press the  and use the Right button to highlight the Panorama Mode () and press the  to enter.
2. Use the **Left/Right** buttons to specify the direction of picture taking, and then in 2 seconds the panoramic sequence will commence automatically.
3. Compose the first view of the panoramic picture on the LCD screen and press the Shutter button to capture.
4. After the first shot is taken, the semi-transparent image of the first shot will appear at the edge of the screen. You can use this image to compose your picture before you press the Shutter button to capture and finish manual stitching.
5. The camera will then stitch the pictures into a panorama automatically.
6. Press the  button to enter Playback mode and review the panorama result.



After taking a Panoramic picture press the  button to save and exit or press the Delete button to cancel and exit.



Flash Mode, Self-timer, Macro Mode, and Exposure Compensation are disabled on Panorama Mode.



Pictures cannot be deleted, nor the zoom adjusted until the series is finalized.



Panorama Mode can stitch 2 or 3 maximum

Stabilization mode

This mode can help reduce photo blur caused by a shaky hand, low light and slow shutter speed.



Use stabilization mode in dark environments or when in slow shutter speed.



Shooting in a windy or unstable environment (such as a moving vehicle) may cause blurred images.



Face Detection

In the Shooting mode (except for Panorama Mode/Movie Mode), Face Detection is enabled by default so that faces will be automatically focused for clearer pictures.

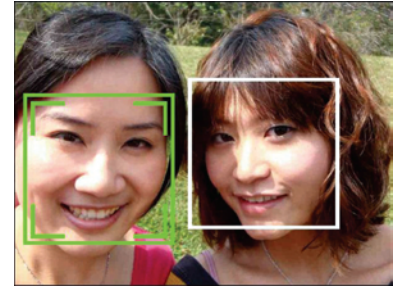

Blink Detection

Blink Detection is enabled by default. When shooting, if human face is detected with eyes closed, the eyes closing icon () will display on the screen as prompt.



Smile Detection

With the camera's new "Smile Detection" feature, which automatically detects and captures a person smiling, you'll never miss a smile.

1. In the Shooting Mode, press the Left/Smile Face Detection button to turn on the Smile Face Detection function and the icon () appears on the LCD
2. Point the camera at the subject until the subject's face is detected and bracketed by a square box. Press the Shutter button all the way down and release the Shutter button. The camera will now 'wait' for the subject to smile.
3. When the subject smiles, the camera will automatically release the shutter and capture the photo.
4. If you want to disable smile shooting function, please press the Left button again.

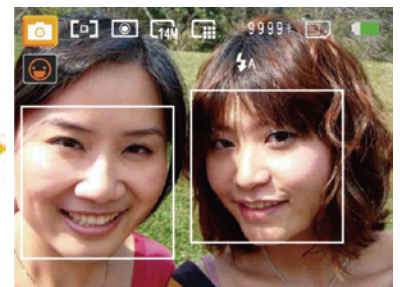

A face must be detected by the camera in order for smile detection to function correctly.



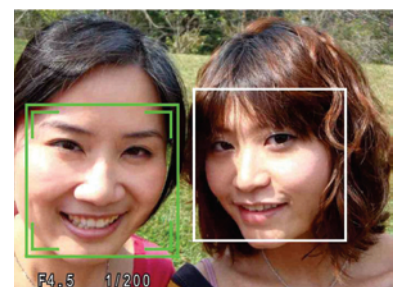

For optimal detection results, the subject should be framed to occupy most of the screen space.



PLAYBACK

Viewing Photos and Videos

To view the captured photos and video clips on the LCD screen:

1. Press  button to go to the **Playback** mode. The last recorded photo or video clip is displayed.
2. Use the **Left/Right** navigation buttons to scroll through the photos or video clips stored in the internal memory or memory card.
3. To play a selected video clip, press the  button to enter the movie playback mode.

During video playback, the operating instructions will appear on the screen. Press the Left/Right button, and press the  button for confirmation.

The operating instruction icons are as follows.

1	First Frame	4	Back
2	Play	5	Rewind
3	Fast Forward	6	Pause

During video playback, you can press the Up/Down button to adjust the volume.

Thumbnail View

When in **Playback** mode, press one end of the Zoom button ( W) to display the thumbnail of photos and videos on the screen.

1. Use the Zoom button to switch between the 3x3, and 4x4 and Date Folder thumbnail display.

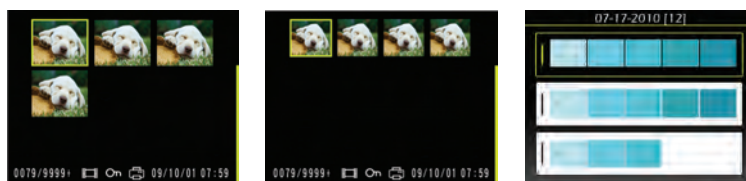

2. When displaying 3x3 and 4x4, use Up/Down/Left/Right button to select a picture or video clip for view; when displaying the Date Folder, use Up/Down button to select the Date Folder.
3. When displaying the Date Folder, pressing  button can enter date information index.
4. Use Up/Down/Left/Right button to select a picture or video clip, press  button to return to the original size.



The Date Folder is displayed in order based on the shooting date.



If the  indicator appears on the LCD, then a movie file is currently being displayed.



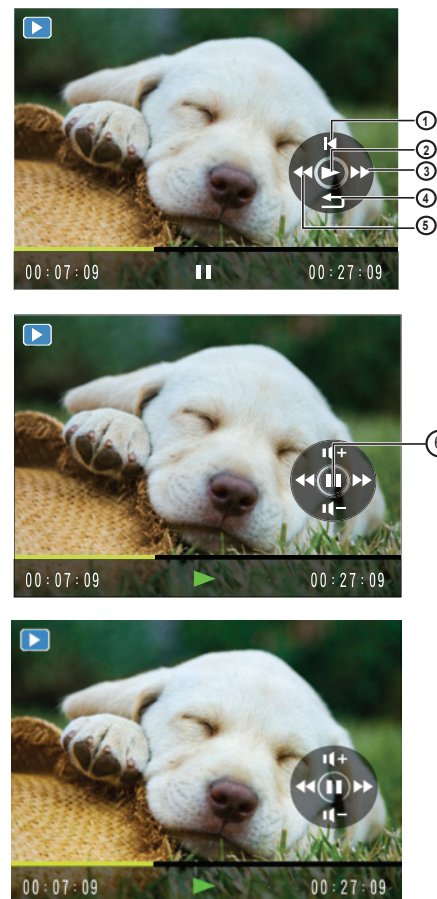

Press the  button to restore a preview icon to its original image size.



Using Zoom Playback (for still pictures only)

The zoom toggle can be used during playback. This allows you to magnify photos up to 2 ~ 8X.

1. Press  button to go to the **Playback** mode.
2. Use the **Left/Right** navigation buttons to select a photo to magnify.
3. Press one end of the Zoom toggle () to zoom in.
4. Use the Zoom toggle to zoom in and out. The zoom indication and the frame of the whole photo shall display on the screen.
5. Use the navigation buttons to pan across the image.
6. Press the  button to return the image to its original scale.





Movie images cannot be magnified.

Using the Delete Button

In Playback Mode, you can press the Down/Delete button to delete pictures or videos.

To delete pictures or videos:

1. Press  button to go to the Playback Mode.
2. Select a picture or video clip you want to delete with the Left/Right button.
3. Press the Down/Delete button and the delete screen appears.
4. Select Yes or Back with Up/Down button and press the  button for confirmation.

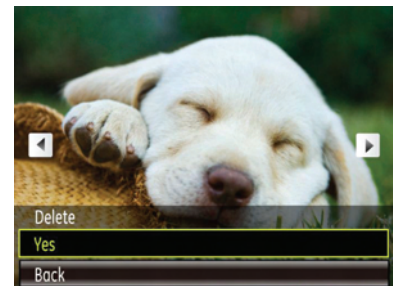

Erased photos/video clips cannot be recovered.





Please refer to page 29 for instructions on the Delete Menu options.

USING THE MENUS

Still Menu

In any of the above Still Picture Modes, press the  button to go to the Still Picture menu.

To adjust each setting:

1. In the Still Picture menu, switch between different Photo Setup or Camera Setup pages using the Left/Right button, to select the page with the function you want to adjust and press the Down button.
2. Press the Up/Down buttons to select the function.
3. Press the Right button to go to the submenu.
4. Press Up/Down button to select an option or press the Left or  button to return to the menu.
5. Press the  button for confirmation and exit the menu.

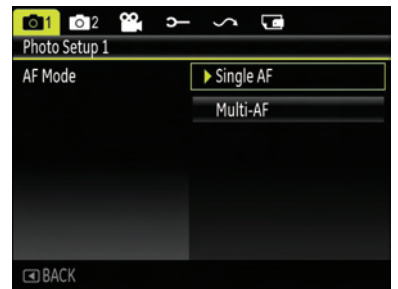

After selecting a function, you can press the Up button to return to the Still Picture menu for other Photo Setup or Camera Setup pages. Or you can press the Down button several times to move to the next setup menu page.

Refer to the following pages for more details about each setting.

AF Mode (Auto-Focus mode)

Use this setting to control the auto-focus mechanism while taking pictures.

Two options are available:

Single-AF	The focus frame appears on the center of the LCD screen to focus on the subject.
Multi-AF	The camera automatically focuses the subject in a wide area to find the focus point.

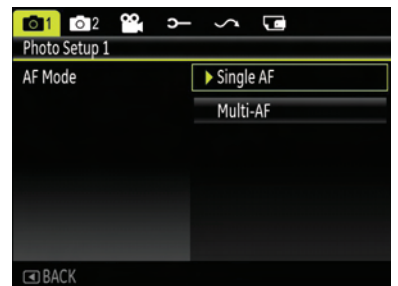

Continuous AF

After Continuous AF is turned on, the camera will adjust focus automatically in response to any camera or subject movement.

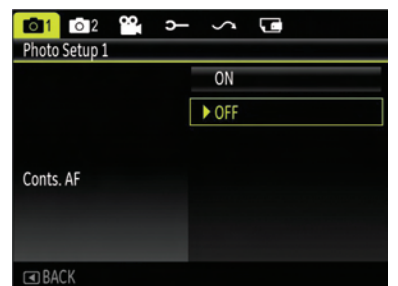

Expo Metering (Exposure Metering)

Use this setting to select an area for the exposure to be obtained.

Three options are available:

Spot
Center-Weight
AiAE (Artificial Intelligence AE)

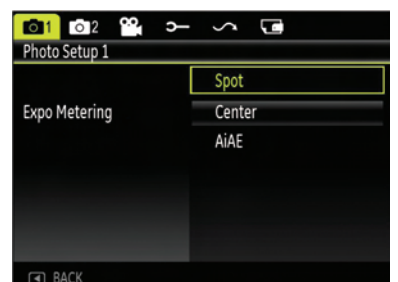

Continuous Shot

Use this setting to perform continuous shooting. Once in this mode, you must continuously hold down the Shutter button to use this function.

There are five available options:

OFF	Turn off Continuous Shot function.
Unlimited	Press and hold the shutter to shoot continuously until you release the shutter or when the memory card has run out of space.
3 shot	Capture up to 3 consecutive pictures.
3 shots (Last)	Capture pictures continuously until the Shutter button is released but only the last 3 shots are recorded.
Time-Lapse	Automatically capture pictures in a predefined interval.

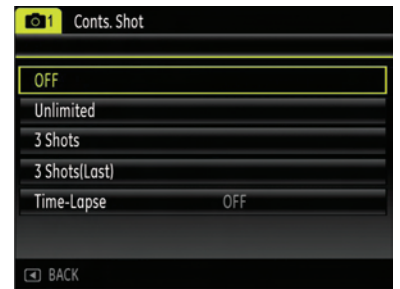

The flash is designed not to work in this mode in order to enable quick succession of shots.

Date Imprint

Include a Date/Time stamp in the photo image.

Off
Date
Date / Time



Quick Review

This setting refers to the quick photo review immediately after taking a picture. The picture stays on the LCD screen for an adjustable period of time.

Four options are available:

Off
1 sec
2 sec
3 sec

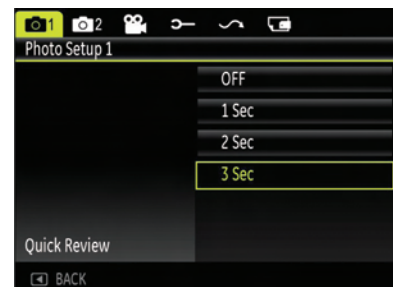

Longer display times will reduce overall battery performance.

Digital Zoom

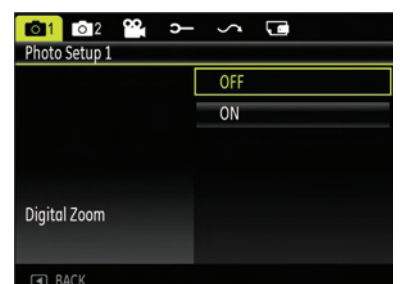

Use this setting to enable or disable the digital zoom function. When disabled, only the optical zoom is enabled.



Movie Menu

In the Movie Mode, press the  button to go to the corresponding Movie menu.

To configure each setting:

1. In the Movie menu, switch between the Movie Setup or different Camera Setup pages using the Left/Right button, select the page with the function you want to adjust and press the Down button.
2. Press the Up/Down button to select the function and press the Right button to go to the submenu.
3. Press the Up/Down button to select an option or the Left or  button to return to the menu.
4. Press the  button for confirmation and exit the menu.

Refer to the following pages for more details about each setting.

Continuous AF

After Continuous AF is turned on, the camera will adjust focus automatically in response to any camera or subject movement.

Expo Metering (Exposure Metering)

Set metering mode for various lighting conditions.

Three options are available:

Spot
Center
AiAE (Artificial Intelligence AE)

Playback Menu

In Playback mode, press the  button to enter the **Playback** menu.

Please refer to the following sections for detailed instructions on the various menu options.



Protect

To prevent any pictures or videos from being accidentally erased, use this setting to lock one or all of the files.

To protect/unprotect a picture or video:

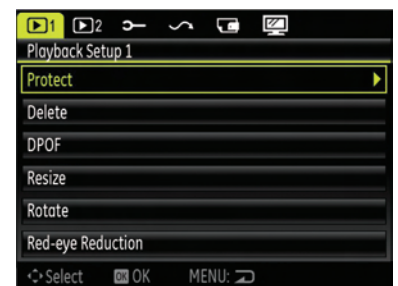
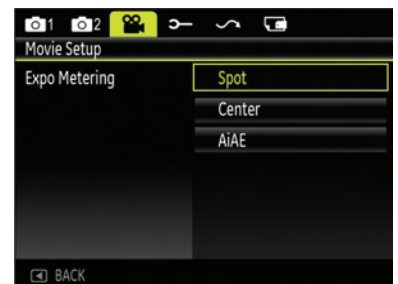
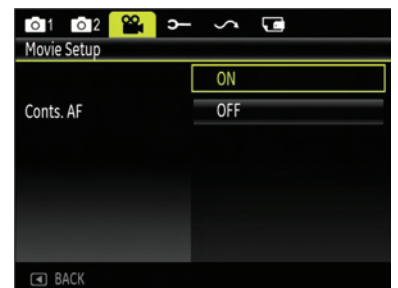
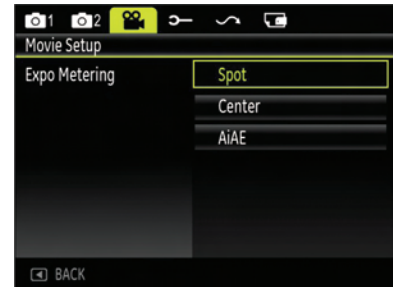
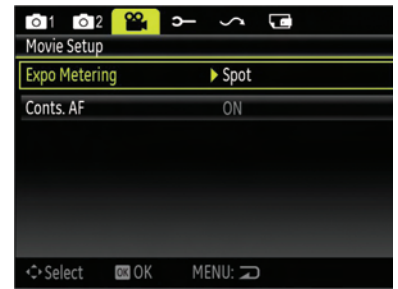
1. Press  button and find the picture or video you want to protect by using Left/Right button. Once it is displayed on the screen, go to the Playback menu, select Protect settings and press the Up/Down button to make your selection.





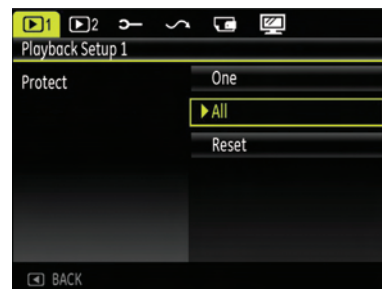



- Press the Up/Down button to select the protection setting option and press the Right button to go to the submenu.
- Use the Up/Down button to select One to lock the selected picture or video, or select All to protect all pictures/videos stored in the built-in memory or memory card.
- Press the  button to select Yes to lock. For locked picture/video, use Unlock option to unlock it.
- A key () icon will appear on the top of the screen to indicate that the picture/video is protected.
- Select **Reset** on the Protection setting to cancel protection for all files that have been placed in the protected mode.



Delete

There are three ways to delete files.

Delete One	1. In the Delete Option, select One and then press  button.
	2. Press the Left/Right button to locate the photo or video to be deleted. Press the Up/Down button to select item (Yes: to delete the file, Back: to return to previous menu) and then press  to confirm.
Delete All	1. In the Delete option, select All and then press  button.
	2. Use Up/Down button to select Yes to delete all files, or select Back to return to the menu.
Delete Date Folder	1. In the Delete option, press  button after selecting Date Folder.
	2. Use the Up/Down button to select Date Folder to be deleted, press  to confirm, press the Up/Down button to select item (Yes: to delete the file, Back: to return to the menu) and then press  to confirm.



The “” indicator means a file is protected. File protection must be removed first before a file can be deleted.



Deleting files will cause DPOF settings to be reset.

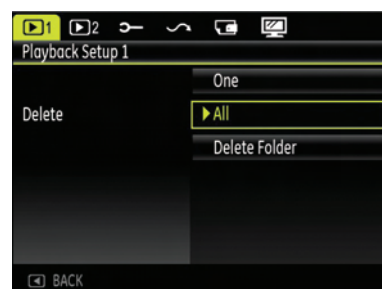

DPOF (Digital Print Order Format)

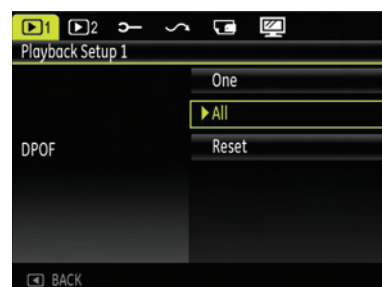

DPOF allows you to record your selection of pictures that you would like to print, and will save your selection in the memory card, so that you can simply hand your memory card to a photo kiosk without having to tell them in person which photos you would like to print.



Trim

The Trim setting allows you select an area of the photo you want to keep and then save it as a new photo.

To trim a picture:

1. Select the **Trim** setting from the  menu.
2. Using the **Left/Right** buttons, locate the photo that you want to crop and have it displayed on the LCD.
3. Use the zoom toggle and navigation buttons to adjust the trimming box to fit the location and size of the new picture.
4. "Save Changes?" prompt will display after pressing  button, select "O" to confirm the changes and save the image, or select "X" to cancel the changes and return to the screen of trim prompt.



The image can not be clipped again when it is clipped to 640X480.

Resize

This setting allows you to resize a picture to a specified resolution, and saves it as a new picture.

1. Select the **Resize** setting from the **Playback** menu as described previously.
2. Use the **Left/Right** navigation buttons to select a picture to resize.
3. Use the **Up/Down** navigation buttons to select a resolution (**1024X768** or **640X480**) to resize the image or **Back** to cancel and return to the **Playback** menu.
4. Press the  button to confirm the setting.

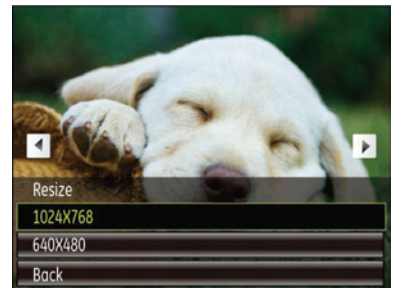

Resizing an image creates a new file that contains the image in the size you select. The file with the original image also remains in memory.



If the message "The image cannot be edited." appears, it means that the current image cannot be resized.

Rotate

You can use this setting to change the picture orientation of the picture.

1. Select the **Rotate** setting from the **Playback** menu as described previously.
2. Use the **Left/Right** navigation buttons to select a picture to rotate.
3. Use the **Up/Down** navigation buttons to select the direction for rotation or **Back** to cancel and return to the **Playback** menu.
4. Press the  button to confirm the setting.



Red-eye Reduction

Use this setting to remove red-eyes in your photos.

1. Select the **Red-eye Reduction** in **Playback** menu as described previously.

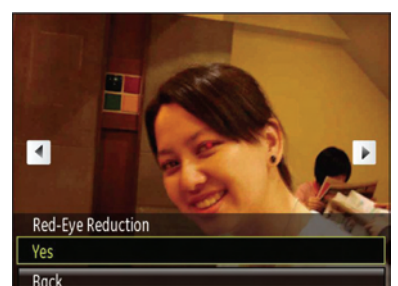

2. Use the **Left/Right** button to select the picture from which the red-eye needs to be removed.
3. Use the **Up/Down** navigation buttons to select **Yes** to fix the selected image or **Back** to cancel and return to the **Playback** menu.
4. Press the  button to confirm the setting.



For best results, the face of the subject should be relatively large on the LCD screen, the subject should be facing the camera as front on as possible, and the red eyes should be as large as possible.

Display Setup

Press  button in Playback mode to enter Display Setup menu.

Refer to the following sections for details of every setting.

Slideshow

This setting allows you to view all the stored pictures as a slideshow.



1. Select the slideshow menu, press the right button to enter the options menu.
2. Use the **Up/Down** navigation buttons to select Effect, Interval time, or Repeat and use the **Left / Right** navigation buttons to adjust the setting.
3. Use the **Up/Down** navigation buttons to select **Start** to run the slideshow or **Cancel** to return to the **Playback** menu.
4. Press the  button to confirm the setting.

Wallpaper Settings

Use this setting to select your favorite picture to use as a background on the LCD screen.

1. Press Down button to select the Wallpaper Setting menu.
2. Press Right button, and the camera will enter the Wallpaper Setting interface.



Menu Wallpaper:

Use Up/Down button to select the Menu Wallpaper option, press  button to confirm or press Left button to return to last page, and press  to exit the menu.

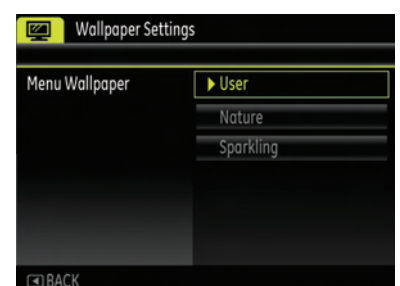
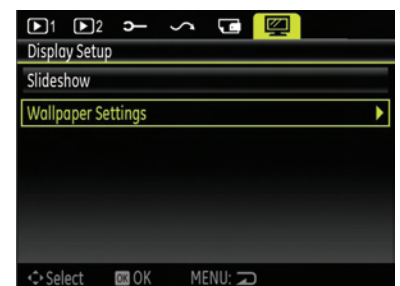
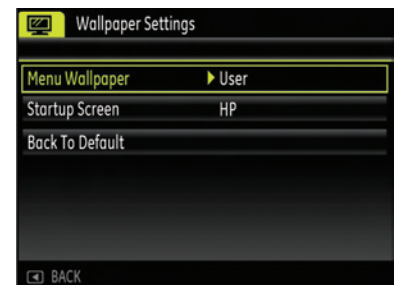
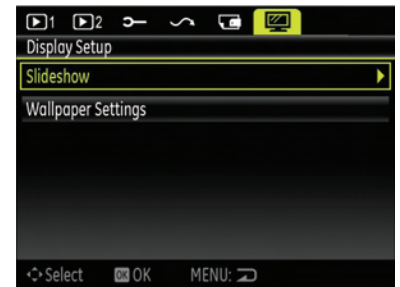
User
Nature
Sparkling





Startup Screen:

Use Up/Down button to select the Startup Screen option, press  to confirm or press Left button to return to last page, and press  to exit the menu.

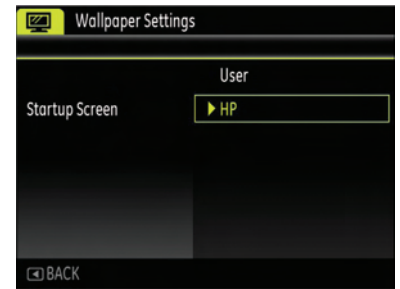
User
GE logo



Set back to defaults:

Use Up/Down button to select Set back to defaults, press  to confirm or press Left button to return to last page, and press  to exit the menu.

Yes
No

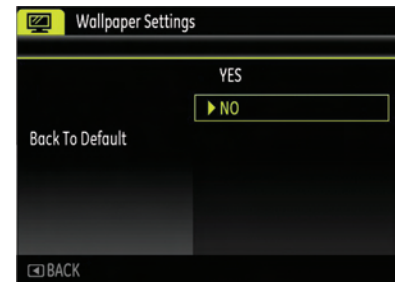

Setup Menu

The Setup menu for the camera is available in all modes. Each menu page can be selected by pressing the  button and switching between menus with the Left/Right button.

To adjust the settings:

1. Select the menu page with the function you want to adjust and press the Down button.
2. Switch between different functions with the **Up/Down** button.
3. Press the **Right** button to enter the submenu.

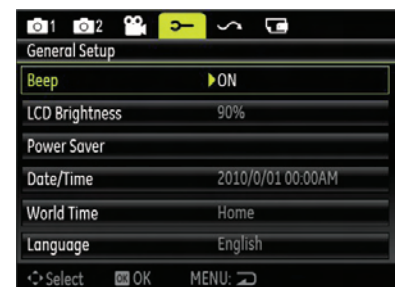

After selecting a function option, you can press the Up button to return to the menu for other Camera Setup pages. Or you can press the Down button to switch to the next menu page.

Refer to the following pages for more details about each setting.

Beep

Use this setting to adjust the volume of beep when buttons are pressed and change the tones for Shutter button, self-timer, and power-on/power-off.

To change this setting:

1. Select the **Beep** setting from the **Setup** menu as described previously.
2. Use the **Up/Down** navigation buttons to switch between volume, shutter, key, self-timer, and power fields.
3. Press the Right button, press the Up/Down button to adjust volume and change tone, and press the  button to confirm setting.

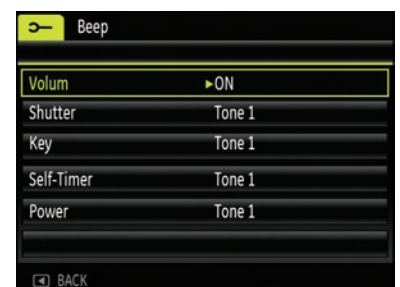

LCD Brightness

Use this setting to adjust the brightness of your LCD screen.

1. Select the **LCD Brightness** setting from the **Setup** menu as described previously.
2. Select auto or adjust the brightness level using the Left/Right button, and press the  button to confirm the setting.



Power Saver

This setting allows you to save power and get the maximum possible running time for your battery. Follow the steps below to turn off the LCD screen and camera automatically after a period of inactivity.

1. Select the **Power Save** setting from the **Setup** menu as described previously.
2. Press the Up/Down button to select the power items for the screen and camera and press the Right button.
3. Press the Up/Down button to adjust the selected item. Both items have the following options:





LCD Off	ON	30 sec
	1 min	2 min
Camera Off	ON	3 min
	5 min	10 min

4. Press the  button to confirm.

Zone

The Zone setting is a useful function on your overseas trips. This feature enables you to display the local time on the LCD screen while you are overseas.

1. Select the **Zone** setting from the **Setup** menu as described previously. The world time screen appears.
2. Use the **Up/Down** navigation buttons to switch between the hometown () and travel destination () fields.
3. Use the **Left/Right** navigation buttons to select a city close to the desired time zone. Then press the  button to confirm.



Date/Time

See “**Setting the Date and Time**” section on page 14.

Language

See “**Setting the Language**” section on page 14.

File and Software

Format Memory

Please note: formatting enables you to delete all contents in the memory card and built-in memory, including protected photo and movie files.

To use this setting:

1. Select the **Format** in File and Software menu.
2. Use the **Up/Down** navigation buttons to select **Yes** or **No**. Then press the  button to confirm.
3. The current media is formatted.

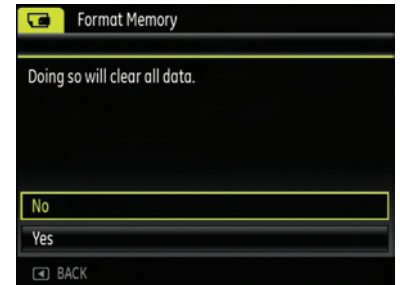

File Numbering

After you take a picture or video clip, the camera will save it as file that ends with a serial number. You can use this item to choose whether the file is serially numbered or begins with 1 and is saved in another folder on the memory card.

1. Select the **File Name** in File and Software menu.
2. Select the option with the Up/Down button and press the  button for confirmation.

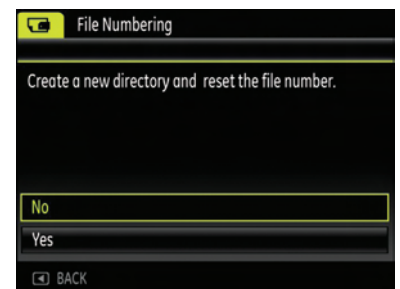

Copy to Card (Copy internal memory to memory card)

Use this setting to copy the files stored in the internal memory to the memory card.

1. Select the **Copy to memory card** in File and Software menu.
2. Use the **Up/Down** navigation buttons to select **Yes** or **No**. Then press the  button to confirm.

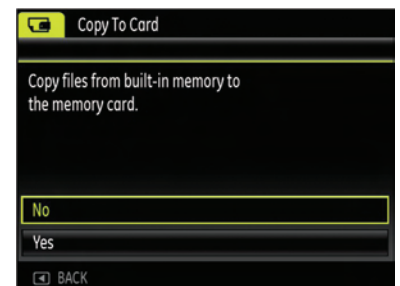

Reset Settings

Use this setting to restore the camera to its default settings.

1. Select the **Reset** setting in File and Software menu.
2. Use the **Up/Down** navigation buttons to select **Yes** or **No**. Then press the  button to confirm.

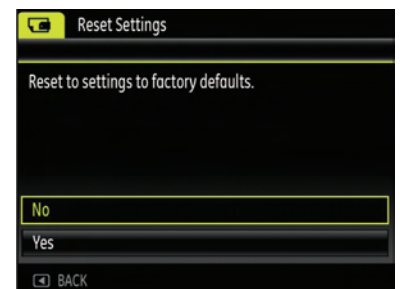

Transmission

Video System

Use this setting to determine your video system in the current area.

1. Select the **Video System** in **Connection Setup** menu.
2. Use the **Up/Down** navigation buttons to select **NTSC** or **PAL**. Then press the  button to confirm.

The video output signal can be switched to NTSC or PAL to accommodate different regional standards. The appropriate setting will vary between regions.

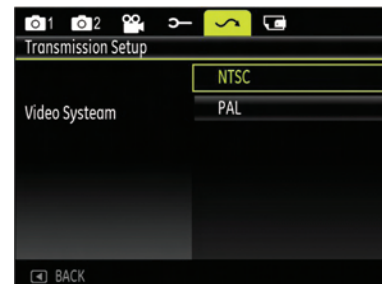

NTSC	USA, Canada, Taiwan, Japan, etc.
PAL	Europe, Asia (excluding Taiwan), Oceania, etc.

Note: The TV output will not display properly if an incorrect video system is selected.

Connecting to a PC

Use the USB cable and ArcSoft software (CD-ROM) supplied with your camera to copy (transfer) pictures to a computer.

Setting the USB mode

Since the camera's USB port can be set to connect with either a PC or a Printer, the following steps will allow you to ensure that the camera is correctly configured to connect with a PC.

1. Go to the camera setting menu, select USB connection with the Up/Down button, and press the Right button.
2. Use the **Up/Down** navigation buttons to select **PC**.
3. Press the  button to confirm the setting.

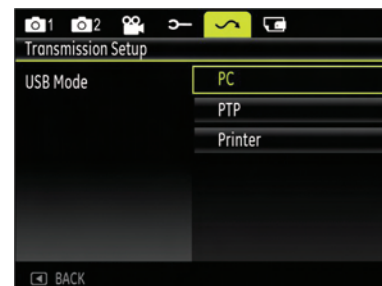

Transferring photos and videos to your PC



If your computer or Laptop has a SD/SDHC card reader, it is easier to transfer photos and videos from the camera's memory card directly. However, if your system does not have a SD/SDHC card reader, you can use the USB connection between the camera and computer/Laptop.

The computer will automatically detect the camera as a removable drive. Double-click **My Computer** icon on the desktop to locate the removable drive and to copy the folders and files in the drive to a directory on your PC as you would copy any typical folder or file.

By using the USB cable, you can transfer the captured photos and videos to a PC. Follow the steps below to connect the camera to a PC.

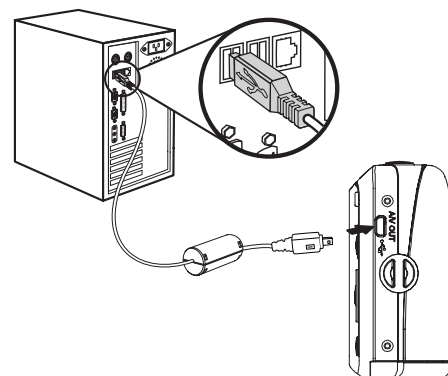
1. Start a computer to which the Nero software has been installed.
2. Make sure both the camera and PC are turned on.
3. Connect one end of the supplied USB cable to the USB/AV OUT port on your camera.
4. Connect the other end of the cable to an available USB port on your PC.
5. Disconnect the camera once transfer is completed.

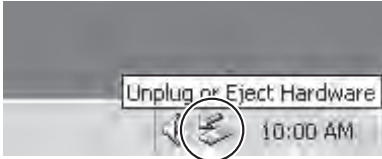

If the USB option is set to [PC] :	Turn the camera off and disconnect the USB cable.	
If the USB option is set to [PC (PTP)] :	Remove the camera from the system as described below before turning the camera off and disconnecting the USB cable.	
	Windows operating system (Windows 2000, Windows XP, Windows Vista, Windows 7.) Click the [Safely remove the hardware] icon and remove the USB connector according to the appeared menu.	Macintosh Drag the untitled icon to the Trash. ("Untitled")
		

Connecting to a PictBridge Compatible Printer



PictBridge allows printing images from a memory card in a digital camera directly to a printer, regardless of brand. To find out if a printer is PictBridge compatible, simply look for the PictBridge logo on the packaging or check the manual for specifications. With the PictBridge function on your camera, you can print the captured photos directly with a PictBridge compatible printer using the supplied USB cable, without the need for a PC.

Setting the USB mode

Since the camera's USB port can be set to connect with either a PC or a Printer, the following steps will allow you to ensure that the camera is correctly configured to connect with a Printer.

1. Go to the camera setting menu, select USB connection with the Up/Down button, and press the Right button.
2. Use Up/Down to select **Printer**.
3. Press the  button to confirm the setting.

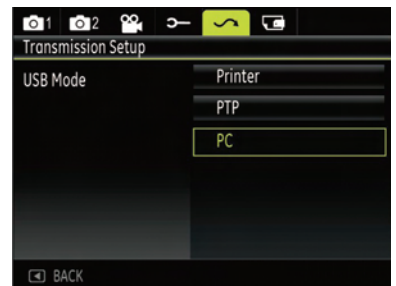

After the camera is reset, it will switch to PC mode automatically from USB mode.

Connecting the camera and printer.

1. Make sure both the camera and printer are turned on.
2. Connect one end of the supplied USB cable to the USB port on your camera.
3. Connect the other end of the cable to the USB port on the printer.

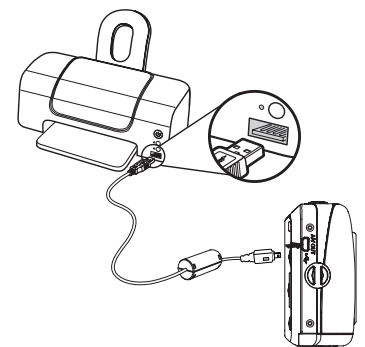

If the camera is not connected to a PictBridge compatible printer, the following error message appears on the LCD screen.



The above error message would also appear if the USB mode were set incorrectly, in which case you should disconnect the USB cable, check the USB mode settings, ensure that the Printer is turned on, and then try connecting the USB cable again.

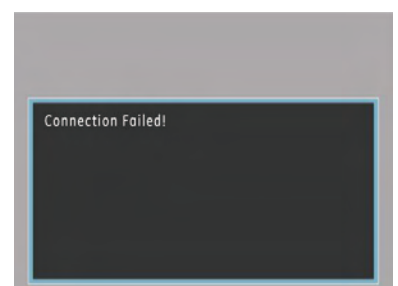

Using the PictBridge Menu

After setting the USB mode to Printer, the **PictBridge** menu appears.

Select a menu item with the Up/Down button and press the Right button or  button to enter the item.

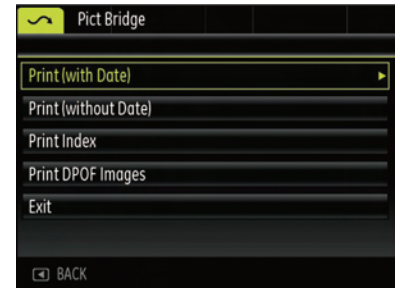

Refer to the following sections for more detailed information on each setting.



Print with date

If you have set the date and time of your camera, the date and time will be recorded and saved with each photo you take.



1. Select **Print with date** from the **PictBridge** menu. The following screen appears.

2. Use the **Left/Right** navigation buttons to scroll through the photos.
3. Use the **Up/Down** navigation buttons to select the number of prints for the current displayed photo.
4. Press the  button and the following screen appears.
5. Select **Yes** to confirm the printing, or **Cancel**. Then press the  button.



Print without date

Use this setting to print the photos without dates on them.

1. Select **Print without date** from the **PictBridge** menu. The following screen appears.
2. Use the **Left/Right** navigation buttons to scroll through the images.
3. Use the **Up/Down** navigation buttons to select the number of prints for the current displayed image.
4. Press the  button and the following screen appears.
5. Select **Yes** to confirm the printing, or **Cancel**. Then press the  button.

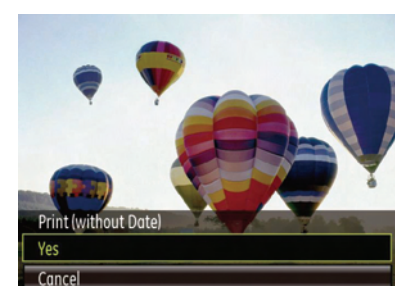

Print index

You can use this setting to print all indexes to show all the photos currently in your camera.

1. Select **Print index** from the **PictBridge** menu. The following screen appears.

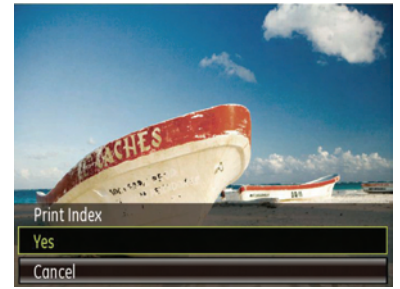



2. Select **Yes** to confirm the printing, or **Cancel**. Then press the  button.

Print DPOF (Digital Print Order Format)

To use DPOF printing, you must make the selection of photos for printing using the DPOF settings before hand. See “**DPOF**” section on page 29.

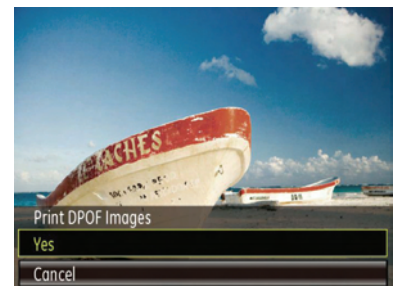
1. Select **Print DPOF** from the **PictBridge** menu. The following screen appears.



2. Select **Yes** to confirm the printing, or **Cancel**. Then press the  button.

Exit

To exit the **PictBridge** menu, select **Exit**. The “Remove USB cable” message will be displayed.

Disconnect the USB cable from the camera and printer.

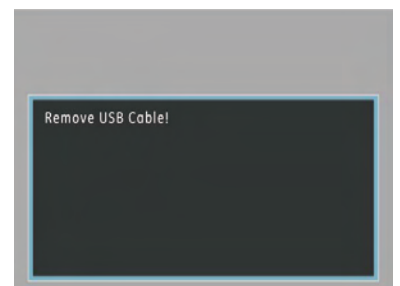

APPENDICES

Specifications

Effective Pixels		14.0MP (4320×3240)
Sensor Type		1/2.3" CCD
Lens	Focal Length	5.2mm (Wide) ~ 15.6mm (Tele)
	Aperture	F3.5 (Wide) ~ F6.4 (Tele)
Zoom		3X optical zoom, 6X digital zoom
Resolution	Still Image	14MP, 12MP(3:2), 10MP(16:9), 8MP, 5MP, 3MP, 0.3MP
	Movie	640x480pixels: 30fps/15fps, 320x240pixels: 30fps/15fps
Image Compression		Best, Fine, Normal
File Format	Still Image	Exif 2.2 (JPEG)
	Movie	Quick Time Motion JPEG, Audio: G.711 [Monaural]
LCD Display		2.4" color LCD
ISO Sensitivity		Auto, ISO80/100/200/400/800/1600
Storage Media		SD/SDHC (Up to 16GB)
Power		2 x AA Alkaline Battery, AA NiMH Battery, or AA Photo Lithium. For maximum shots per battery change, use Photo Lithium batteries.
Dimensions (W x H x D)		92mm x 61mm x 30.35 mm
Mass		Approx. 120g (without batteries)

Error messages

Messages	Explanation
No card	<ul style="list-style-type: none"> The memory card is not inserted.
Card error	<ul style="list-style-type: none"> The memory card is not formatted.
Card full	<ul style="list-style-type: none"> The memory card is full and cannot store any new images.
Write protect	<ul style="list-style-type: none"> The memory card is write-protected.
Picture error	<ul style="list-style-type: none"> The picture is not captured correctly. The picture is damaged.
No picture	<ul style="list-style-type: none"> There are no images in the memory card or in the internal memory.
Lens error	<ul style="list-style-type: none"> The lens is probably stuck and the camera will power off automatically.
System error	<ul style="list-style-type: none"> Unexpected error encountered.
Image cannot be saved	<ul style="list-style-type: none"> The write protection switch in the memory card is set to the "LOCK" position.
Out of the range	<ul style="list-style-type: none"> When pictures were taken in Panorama mode, the direction of movement was incorrect or the angle was outside the range of the internal settings.
The maximum specified water depth was exceeded	<ul style="list-style-type: none"> During underwater recording or shooting, the camera was taken deeper than the maximum allowable depth.
When the camera is used for longer than the specified time it may be damaged.	<ul style="list-style-type: none"> During underwater recording or shooting, the camera was kept under water longer than the specified time.
Card is not formatted, format?	<ul style="list-style-type: none"> Confirm whether the memory card should be formatted.
This image cannot be deleted	<ul style="list-style-type: none"> The picture or video you are trying to delete is protected.
Cannot record movie	<ul style="list-style-type: none"> The write protection switch in the memory card is set to the "LOCK" position.
Warning!! Camera recording, please wait.	<ul style="list-style-type: none"> No other actions allowed to perform during video/audio recording.
Warning!! Battery exhausted.	<ul style="list-style-type: none"> The battery is out of charge.
This file cannot be played back	<ul style="list-style-type: none"> The picture format cannot be recognized by the camera.
No connection	<ul style="list-style-type: none"> The camera is not connected to the printer correctly.
Print error	<ul style="list-style-type: none"> There is a problem with camera or printer.
Cannot print	<ul style="list-style-type: none"> Check that the printer is out of paper or out of ink. Check if the printer has a paper jam.

Troubleshooting

Problem	Possible causes	Solution
Camera does not turn on.	<ul style="list-style-type: none"> The battery has run out. The battery is not inserted correctly. 	<ul style="list-style-type: none"> Replace with a fully charged battery.
Camera turns off suddenly during operation.	<ul style="list-style-type: none"> The battery has run out. 	<ul style="list-style-type: none"> Replace with a fully charged battery.
The picture is blurred.	<ul style="list-style-type: none"> The lens is dirty.  appears when taking pictures. 	<ul style="list-style-type: none"> Use a soft cloth to clean the lens on your camera Use the Image Stabilization mode.
Images and video files cannot be saved.	<ul style="list-style-type: none"> The memory card is full. 	<ul style="list-style-type: none"> Replace the memory card with a new one. Delete unwanted images. Unlock the memory card.
No picture is taken when pressing the Shutter button.	<ul style="list-style-type: none"> The memory card is full. No available space to store the files. The mode dial is in Playback mode. 	<ul style="list-style-type: none"> Replace the memory card with a new one or clean off current memory card. Delete unwanted images. The memory card is locked.
Images cannot print from the connected printer.	<ul style="list-style-type: none"> The camera is not connected to the printer correctly. The printer is not PictBridge compatible. The printer is out of paper or out of ink. The paper is jammed. 	<ul style="list-style-type: none"> Check the connection between the camera and printer. Use a PictBridge compatible printer. Load some paper in the printer. Replace the ink cartridge in the printer. Remove the jammed paper.

Getting Help

Should you have a technical support question or your HP Digital Camera require service within the warranty period, please contact the original point of purchase or an authorized HP reseller in your country. If service is not available at those locations, please contact an HP Branded Product warranty agent from the support contact list provided below. A service agent will work with you to troubleshoot your issue and if necessary, issue a Return Material Authorization (RMA) number in order to replace your HP Branded Product. For warranty claims, you will be required to provide a copy of your original dated sales receipt as proof of purchase and the issued RMA number. You will be responsible for shipping charges when shipping the product to the service center. The service agent will provide you with an address and you will also be responsible for any shipping charges to the warranty service center. Once your product is received by this service center, a replacement unit will be shipped back to you typically within 5 business days.

Contact/phone Support:	
Language	Contact/phone Support:
繁體中文	simp.chinese@hpodd.com
	trad.chinese@hpodd.com
Deutsch	deutsch@hpodd.com
Nederlands	hollands@hpodd.com
English	english@hpodd.com
Español	espanol@hpodd.com
Français	français@hpodd.com
Italiano	italiano@hpodd.com
日本語	nippon@hpodd.com
한국어	korean@hpodd.com
Português	portugues@hpodd.com
Svenska	svensk@hpodd.com

Contact/phone Support:			
Country	Language	Number	
Europe Region (EMEA)			
België	Nederlandsk/ Deutsch	+ 32 2700 1724	
Deutschland	Deutsch	+ 49 6950073896	
España	Español	+ 34 914533458	
France	Français	+ 33 171230454	
Ireland	English	+ 353 1850882016	
Italia	Italiano	+ 39 269682189	
Nederland	Nederlandsk	+ 31 202015093	
Schweiz	Deutsch/ Français/ Italiano	+ 41 18009686	
UK	English	+ 44 2073652400	
North America			
United States	English	1.866.694.7633	
Canada	English and Français	1.866.694.7633	
Country	Language	City	Number
México	Español	Mexico City	52.55.1204.8185
		Guadalajara	52.33.1031.3872
		Monterrey	52.81.1107.2639
Venezuela	Español	Caracas	58.212.335.4574
Colombia	Español	Bogota	57.1.508.2325
Perú	Español	Lima	51.1.705.6232
Chile	Español	Santiago	55.11.5504.6633
Brasil	Português	Sao Paulo	55.11.5504.4977
Argentina	Español	Buenos Aires	54.11.6091.2399

P/N: 7525C00257A

Free Manuals Download Website

<http://myh66.com>

<http://usermanuals.us>

<http://www.somanuals.com>

<http://www.4manuals.cc>

<http://www.manual-lib.com>

<http://www.404manual.com>

<http://www.luxmanual.com>

<http://aubethermostatmanual.com>

Golf course search by state

<http://golfingnear.com>

Email search by domain

<http://emailbydomain.com>

Auto manuals search

<http://auto.somanuals.com>

TV manuals search

<http://tv.somanuals.com>