

HYUNDAI
HYUNDAI IT CORP.

Type No. L22C0E080

Model. W220S

Multi Function 2D/3D Wide Monitor



User's Guide

U.S.A.

U.S.FEDERAL COMMUNICATIONS COMMISSION RADIO FREQUENCY INTERFERENCE STATEMENT INFORMATION TO THE USER

NOTE : This equipment has been tested and found to comply with the limits for a Class B digital device pursuant to Part 15 of the FCC Rules.

These limits are designed to provide reasonable protection against harmful interference in a residential installation.

This equipment generates, uses, and can radiate radio frequency energy and, if not installed and used in accordance with the instructions, may cause harmful interference to radio communications.

However, there is no guarantee that interference will not occur in a particular installation.

If this equipment does cause harmful interference to radio or television reception, which can be determined by turning the equipment off and on, the user is encouraged to try to correct the interference by one or more of the following measures:

- Reorient or relocate the receiving antenna.
- Increase the separation between the equipment and receiver.
- Connect the equipment into an outlet of a circuit different from that to which the receiver is connected.
- Consult the dealer or an experienced radio /TV technician for assistance.

Changes or modification not expressly approved by the party responsible for compliance could void the user's authority to operate the equipment.

Connecting of peripherals requires the use of grounded shielded signal cables.

DECLARATION OF CONFORMITY

WE HYUNDAI IT CORP.
Ami-ri Bubal-Eub Ichon-Si Kyungki-Do
467-860 KOREA

declare under our sole responsibility that the product:

Kind of equipment : LCD MONITOR

Type-Designation : L22C0E080

to which this declaration relates is in conformity with the following standard(s) or other normative document(s)

Safety : EN60950-1:2002
EMC : EN 55022/1998+A1:2000+A2:2003
 EN 55024 :1998+A1:2001+A2:2003
 EN 61000-3-2:2000+ A2:2005+A2:2005
 EN 61000-3-3:1995+A1:2001

following the provisions of the Low Voltage Directive 73/23/EEC, 93/68/EEC and the EMC Directive 89/336/EEC.

TUV SUD Product Service GmbH
Ridlerstrasse 65 - 80339 Munchen - Germany

KOREA / May 6, 2008

(Place and date of issue)

Jong Won, Choi 

(Name and signature of
authorized person)

Ho Suk, Chon 

Contents

- 1. Introduction1/27
- 2. Safety Information1/27
- 3. Cautions for Health & Safety3/27
- 4. Handling Instructions5/27
- 5. 3D Monitor SettingGuide5/27
- 6. Q&A for 3D Mode.....6/27



- 7. 3D Mode Specification8/27
- 8. Installing the monitor9/27
- 9. Adjusting the picture17/27
- 10. Display power management23/27
- 11. Troubleshooting24/27
- 12. Specifications27/27



1. Introduction

This manual contains instructions for installing and operating HYUNDAI IT CORP. W220S.

HYUNDAI IT CORP. W220S is a highly ergonomic color display unit.

- 22" viewable WSXGA+ LCD
- High quality screen re-scaling capability
- 100-240V AC input voltage
- VESA DPMS (Display Power Management Signaling)
- VESA DDC1/2B compatibility
- Advanced digital On-Screen-Display controls
- Digital Signal Input by DVI-1.0 Compatability
- Fast and accurate auto adjustment
- Most advanced image scaling
- Supporting VESA Flat Panel Monitor Physical Mounting Interface
- 2D/3D Convertible

2. Safety Information

This Monitor has been engineered and manufactured to assure your safety. You can prevent serious electrical shock and other hazards by keeping in mind the following:

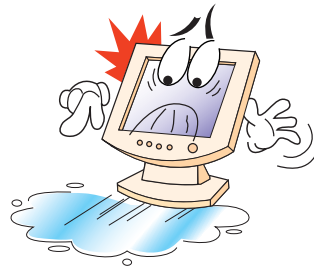

Do not place anything wet on the monitor or the power cord. Never cover the ventilation openings with any material and never touch them with metallic or inflammable materials.

Multi Function 2D/3D Wide Monitor

Avoid operating the monitor in extreme heat, humidity or areas affected by dust.

Temperature : 5~40°C

Humidity : 30~80RH



Be sure to turn the monitor off before plugging the power cord into the socket. Make sure that the power cord and the other cords are securely and rightly connected.

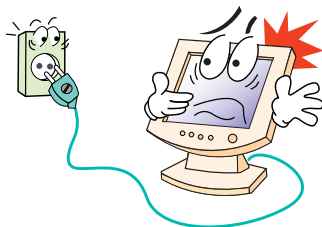

Overloaded AC outlets and extension cords are dangerous, as are frayed power cords and broken plugs, which may cause electric shock or fire. Call your service technician for replacement.

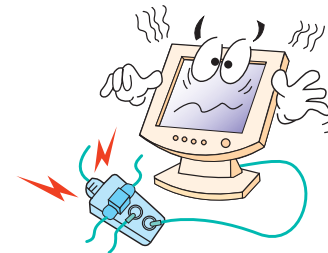

Do not use sharp tools such as a pin or a pencil near the monitor, as they may scratch the LCD surface.



Do not use a solvent, such as benzene, to clean the monitor, as it will damage the LCD surface.

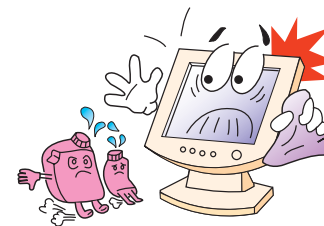

- Cleaning and Maintenance

- To avoid to risk of electric shock, do not disassemble the Cabinet of display Unit. The Cabinet is not user-serviceable. Remember to unplug the display unit from the power outlet before cleaning.
- Do not use alcohol (methyl, ethyl or isopropyl) or any strong dissolvent. Do not use thinner or benzene, abrasive cleaners or compressed air.
- Do not wipe the screen with a cloth or sponge that could scratch the surface.
- To clean your antistatic screen, use water and a special microfiber screen cleaning tissue used in optical lens cleaning, or lightly dampen a soft, clean cloth with water or a mild detergent.
- If the instructions above do not help in removing stains, contact an authorized service agent.

3. Cautions for Health & Safety (Before use)

- Warning

- Viewing Time - Do not view the stereoscopic images continuously and take a rest every 15 minutes.
- Please view the monitor screen within a distance of 60cm ~ 1M.
- If you have any of the following symptoms, consult with a doctor before use.
 - Neck, ear, heart disorder
 - Convulsion, photosensitivity
 - High blood pressure
- If you have any problems with your body such as convulsion, paralysis, disorientation, fainting and confusion, etc. while using it, stop using it and go to your doctor.

- If you feel any problems as follows, stop using it and take a rest.
 - Pain in the eyes, tears, dry eyes, heavy eyelids
 - Nausea, vomiting, dizziness, stomach pain, perspiration
 - Headache, heaviness in head or dizziness, dry mouth
 - Sickness

! If you don't feel better, go to your doctor.

- Intoxicated and/or medicated persons should not use this product.
- Persons with nearsightedness or farsightedness, difference in left and right eyesight, or astigmatism should correct their visions adequately before using it. Using the polarized glasses over glasses or contact lens does not cause any problem.
- Do not handle the LCD monitor with bare hands. It can cause you to get injured.
- Do not place a heavy object over LCD monitor, bend nor give it a shock. It can break down or get damaged.
Do not disassemble or modify it. It can break down or cause a fire.
If it breaks down or get damaged, unplug the power cord and have it repaired.

- Caution

- Fire / Accident Prevention

4. Handling Instructions

How to use

- When viewing stereoscopic images, please use the special polarized glasses. Without this glasses, you can not enjoy stereoscopic images. If you use some polarized glasses from other companies, you can not fully enjoy the stereoscopic images.
- Do no use the polarized glasses for other uses other than 3D viewing.
- Do not touch the surface of the monitor screen with bare hands.
- When the surface of the monitor screen gets dirty, wipe it clean softly with a smooth cloth (cotton flannel). Using detergent, solvent, etc. can cause it to get damaged.
- If the stereoscopic images do not display correctly, read the 3D software "User's Manual" first, and follow it as described in the manual. If they still display improperly, do not disassemble it and contact the Customer Support
- For how to operate LCD monitor, read "Handling Manual."



Please DO NOT disassemble the product.

5. 3D Monitor Setting Guide

- Optimal resolution for 3D viewing is 1680*1050/60Hz. If you run it on different resolutions, its 3D effects can decrease.
- Use signal input source at RGB under PC mode or DVI mode. DVI mode is recommended.

6. Q&A for 3D Mode

- For 3D viewing, go to 1:1 mode under Display Control of OSD MENU before viewing it (Monitor Manual: see 21 page).
Viewing on a different mode may decrease 3D effects.
 - On 1:1 mode, the screen size changes according to the input resolution. It doesn't mean that it has some problems with it. It just operates 1:1 mode without scaling the input signal.
1. There is something like oil stain on the monitor screen.
It is due to interferences of light waves within the air layers between the surface of LCD and the 3D filter. It is not defective.
 2. 3D stereoscopic images are seen as two separate images.
 - ① When you don't wear 3D glasses enclosed Please use the 3D glasses.
 - ② When you view it away from visual angle.
 - To view 3D stereoscopic imaging optimally, you'd better keep the distance of 60 cm
 - 1m from the monitor screen.
 - If you exceed 75° out of the left/right visual angle or 10° out of the top/bottom visual angle while viewing 3D images, you cannot enjoy 3D images properly. So keep the visual angle as provided above.

- ③ When you don't set the resolution properly.
 - 3D mode displays best in 1680*1050/60Hz resolution.
(See 3D Monitor Setting Guide above)
- ④ When the left/right images are reversed
 - Change the option to have the image on the right displayed in the horizontal line of the odd number.
 - Read 3D S/W User's Manual enclosed.
 - When the image signal is correct but PC input signal is reversed, go to OSD MENU and PICTURE, and set the value of V-POSITION up or down in the unit of 1 pixel. You can enjoy 3D images clearly.
- ⑤ 3D stereoscopic images are seen as 2D images
 - This monitor is a combined 2D/3D monitor. You can enjoy 3D images from 2D images only when you use 3D S/W enclosed (They may deteriorate their stereoscopic quality, compared to the contents produced in 3D)
- ⑥ 3D images create Ghost effect
 - It can happen slightly depending on 3D contents.
 - It is due to the different stereoscopic imaging information of the camera when they are manufactured.(Use 3D contents suitable to this product)

7. 3D Mode Specification

- ⑦ The monitor screen reflects my face.
 - This monitor has a 3D filter on the surface of the panel. The reflection is caused by it. You cannot remove it. To reduce the reflected lights, it is recommended that you don't have any light source behind your back.
- ⑧ 3D screen displays dimly
 - This product has a 3D filter on the LCD surface to increase 3D stereoscopic effects. That makes it reduce brightness. Polarized glasses can reduce its brightness as well.

Alignment distance	0.6 ~ 1m
3D Viewing Angle	H : 150 / V: \pm 10 degree
3D Glasses	45 degree(optical axis)
2D/3D Image	Convertible
3D Output Image Format	Interlace

8. Installing the monitor - Packing List

The following items should be found in the packaging.

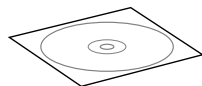

Manual & 3D Soft Program

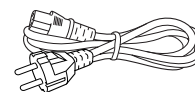

Power Cord

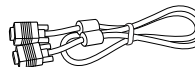

Signal Cable

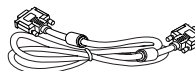

DVI Cable

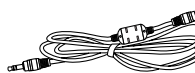

Audio Cable



3D Glasses

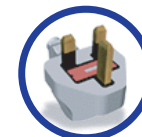

UK

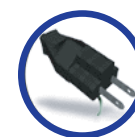

Japan



America/Canada



Europe

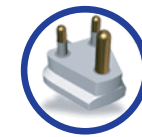

South Africa



Australia



Korea



Above power cord can be changed upon different voltage areas. Please contact your dealer if anything is missing or damaged.

Other power cord except the cord packed in the product or longer than 3m may affect EMC of the product in operating condition.

- Selecting a suitable location

- Place the monitor at least 30cm from other electrical or heat-emitting equipment and allow at least 10cm on each side for ventilation.
- Place the monitor in a position where no light shines directly onto or is reflected on the screen.
- To reduce eye strain, avoid installing the display unit against a bright background such as a window.
- Position the monitor so that the top of the screen is no higher than eye level.
- Position the monitor directly in front of you at a comfortable reading distance (around 45 to 90cm)

- Connecting the PC

- 15 pin D-sub / DVI-D / HDMI

! Before you start cabling your monitor, check that the power is off on all units. To avoid any possibility of electric shock, always connect your equipment to properly earthed outlets.

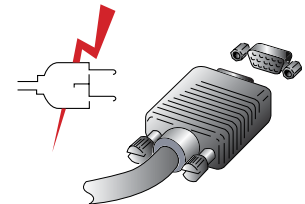

1. Insert the other 15-pin/DVI-D/HDMI signal cable connector into the 15-pin VGA/DVI-D connection on your computer and screw it down.
2. Plug the power cord connection to connection on the monitor.
3. Plug the other end of the power cord to your computer's main supply or to a 100V-240V earthed electrical outlet.
4. Turn on the monitor using the power switch and check that the power LED is on. If not, repeat steps 1,2,3 and 4 or refer to the Troubleshooting section of this guide.

• **Way to Connect**

5. Turn on the power to the computer. The picture will appear within about 10 seconds. Adjust the picture to obtain optimum picture quality. See section Adjusting the picture in this guide for more information.

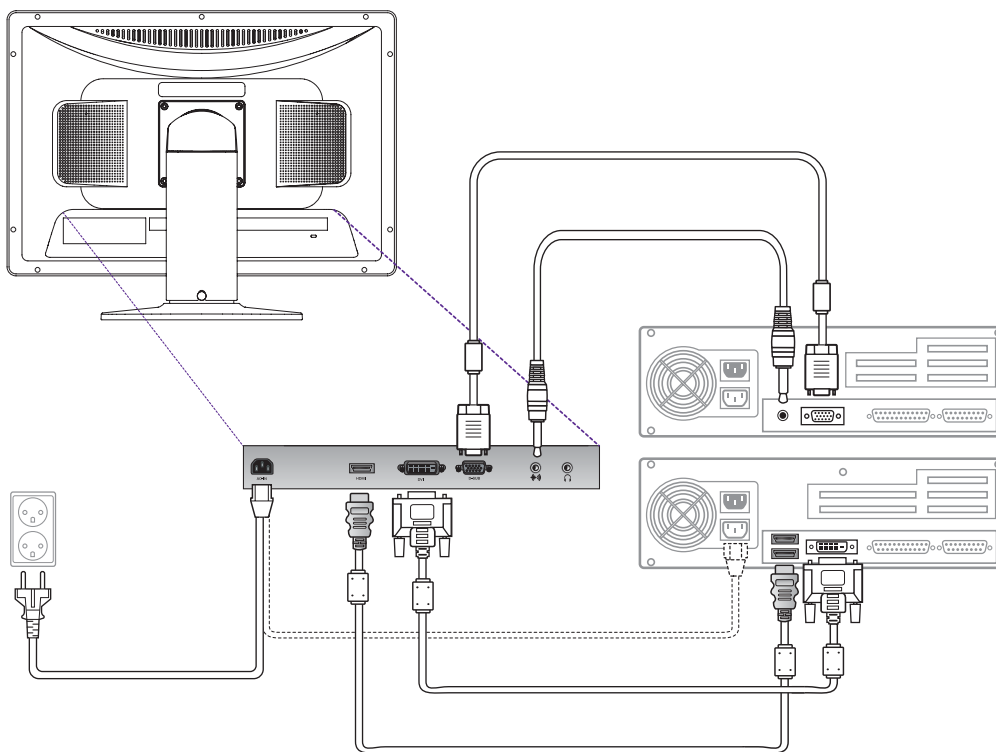

- **Audio system**

This monitor has an audio system including two micro loudspeakers. Each of two micro loudspeakers has an 3W(max.) output power. This system also supports a Audio output jack.

! This system has been tuned to get a best tone quality which an audio input level is under 500mv rms. If the input level is more than 500mv rms, you must tune down the audio input as the audio output tone may be distorted.

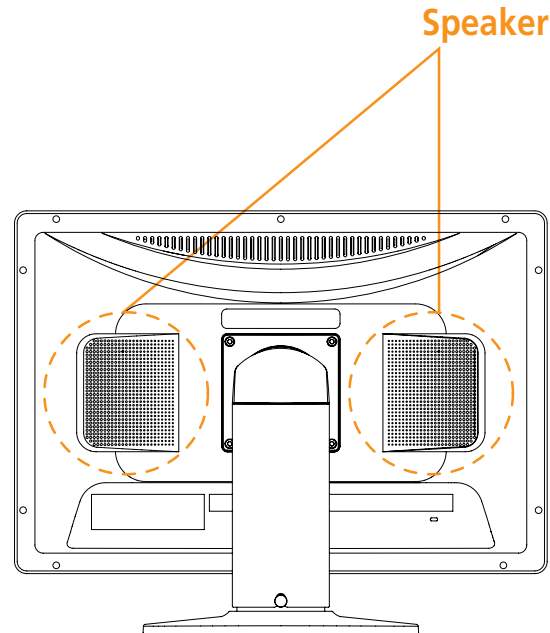

- Setting the refresh rate

Follow the instructions below to set your refresh rate in Windows 98/ME/XP/2000/VISTA.

1. Go to the configuration window(Start-Settings-Configuration window).
2. Double click on the 'Display' icon.
3. Click on the 'Settings' tab.
4. Click on the 'Advanced' button.
5. Click on 'Adapter' and select 60Hz from the list.
6. Click on 'Apply' to accept the selected value.



• Preset Timing Table

! If the signal from the system doesn't equal to the preset timing mode, adjust the mode with reference to the user guide of videocard because the screen may not be displayed.

No.	Resolution	H-Freq.(Khz)	V-Freq.(hz)	Supported Mode	
				Analog	Digital
1	640 X 350	31.4	70.0	•	
2	720 X 400	31.4	70.0	•	
3	640 X 480	31.4	59.9	•	•
4	640 X 480	37.5	75.0	•	
5	800 X 600	35.1	56.2	•	
6	800 X 600	37.8	60.3	•	•
7	800 X 600	46.8	75.0	•	
8	832 X 624	49.7	74.5	•	
9	1024 X 768	48.3	60.0	•	•
10	1024 X 768	56.4	70.0	•	
11	1024 X 768	60.0	75.0	•	
12	1152 X 864	67.5	75.0	•	
13	1152 X 870	68.6	75.0	•	
14	1280 X 960	60.0	60.0	•	•
15	1280 X 1024	63.9	60.0	•	•
16	1280 X 1024	79.9	75.0	•	
17	1680 X 1050	64.7	60.0	•	•
18	480 p		50/60	Video Mode(HDMI)	
19	576 p		50/60		
20	720 p		50/60		
21	1080 i/p		50/60		

- User's Environment

Recommended Ergonomic User's Environment

- Viewing angle of the monitor should be between -5 ~ 15 degree.

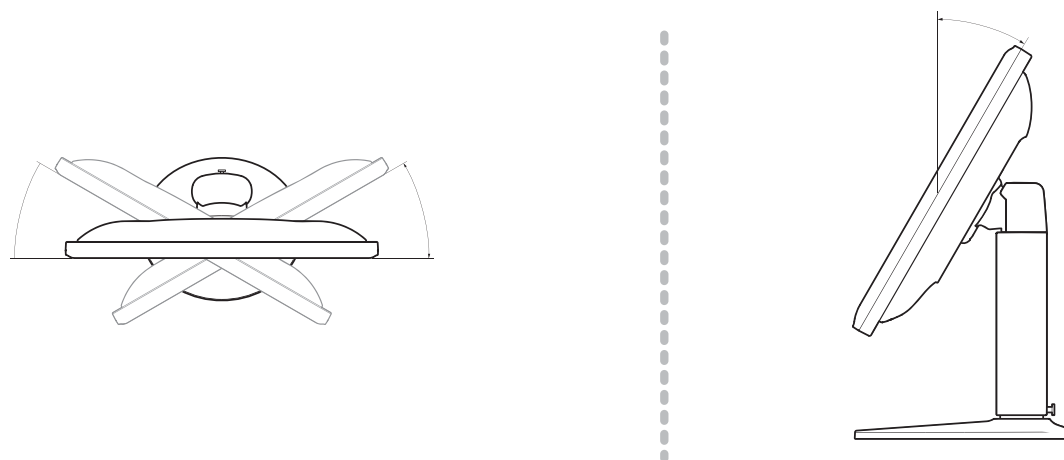

Supports Pivot. (Option)

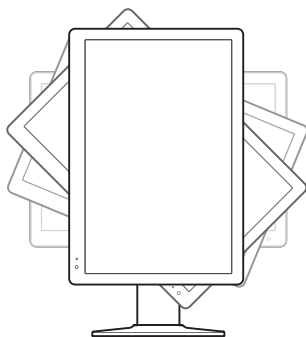

The screen can be vertically rotated by 90 degrees.

This reduces the inconvenience of having to drag scrollbars and roll mouse wheels when working with documents or surfing the web.

* In case that pivot function is not supported from the graphic card in your pc, you could use pivot function by downloading the program through internet.

- Kensington Security (Locking) Slot

- VESA MOUNT'G

- This display unit supports a Kensington-type security device to secure your monitor. Kensington lock is not included.
- To purchase and install the Kensington locking device, please refer to the following contact information.

*** Kensington Technology Group**

· Address : 2000 Alameda de las Pulgas 2F san mateo, California 94403-1289

· Tel : +1 650 572 2700 · Fax : +1 650 572 9675 · Web-site : www.kensington.com

- This display unit supports VESA FPMPMI standard for 100mmx100mm screw mounting by giving 4 screw holes inside the base stand of the unit.
- For buying VESA Flat Panel Monitor Mounting Devices, please contact following information.

*** Ergotron, Inc.**

· Address : Ergotron Europe Kuiperbergweg 50 1101 AG Amsterdam The Netherlands

· Tel : +3 1 20 696 60 65 · Fax : +3 1 20 609 04 59 · E-mail : info.eu@ergotron.com

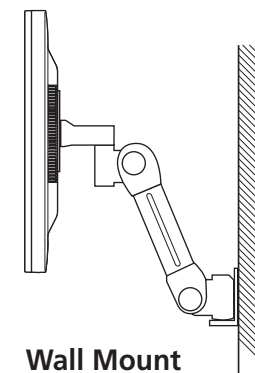
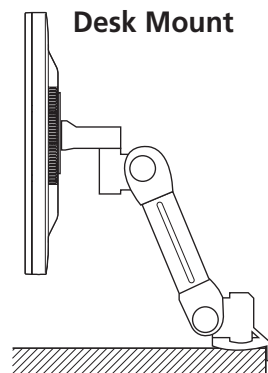

9. Adjusting the picture

You can adjust the screen display by using the buttons located below the screen.



The second Menu from the OSD can't be chosen in digital-mode.

- Using the On Screen Display

To make adjustments in the On Screen Display, follow these steps:

MENU → ^ ∨ → SELECT → - + → MENU → MENU

1. Push the MENU button to call the OSD to the screen.
2. Push the ^ or ∨ button to choose the item you want to adjust. The selected item is highlighted.
3. Push the SELECT button to adjust the highlighted item.
4. Use the - or + button to adjust the selection.
5. Push the MENU button to return to the previous menu if you are in a submenu.
6. The display unit automatically saves the new settings in 1 second after your last adjustments and the menu disappears. You can also push the MENU button to make the menu disappear.

MENU SELECT ∨ ^ - + ⏻

- Direct access buttons

SELECT

AUTO ADJUST

At first display a full screen such as Window's back ground. Push the button SELECT(AUTO) to adjust the shape of screen automatically.

-

VOLUME

Use the button - to select the Volume adjustment. Adjust with - or + button.

^

SOURCE

Use the button ^ to switch the other input from current input. (VGA -> DVI -> HDMI -> VGA)

- OSD Adjustments

• Picture

PC MODE

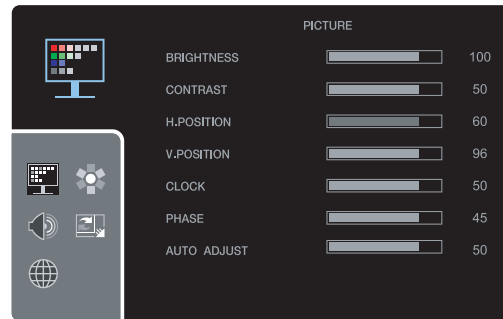

BRIGHTNESS

To adjust the brightness of the screen.

CONTRAST

To adjust the contrast of the screen.

H.POSITION

To move image left and right.

V.POSITION

To move image up and down

CLOCK

To adjust the horizontal size of the entire screen image.

PHASE

To adjust the noise of the screen image.

AUTO ADJUST

You can adjust the shape of the screen automatically into the full screen pattern.

HDMI MODE

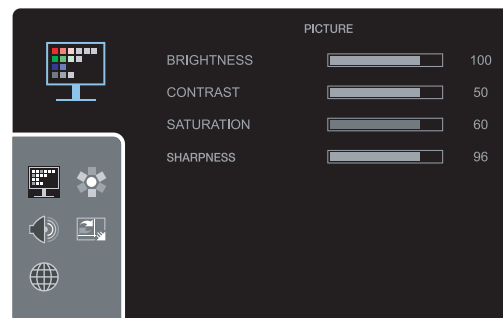

BRIGHTNESS

To adjust the brightness of the screen.

CONTRAST

To adjust the contrast of the screen.

SATURATION

To adjust color density.

SHARPNESS

To adjust sharpness of screen.

• Color

PC ANALOG, DVI

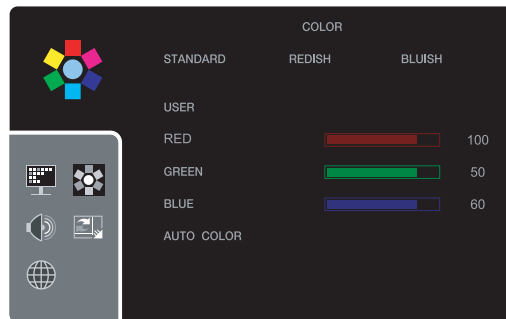

STANDARD

For general Color tone.

REDISH

For Redish color with warm tone.

BLUISH

For Bluish color with cool tone.

USER

For adjusting degree of RGB as User wants

AUTO COLOR (ANALOG ONLY)

TO adjust the horizontal size of the entire screen image.

HDMI MODE

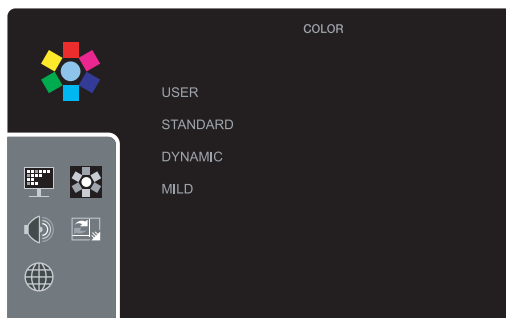

USER

User can adjust directly settings of a screen menu.

STANDARD

For general Color tone.

DYNAMIC

To be Sharper image.

MILD

To be Smoother image.

• Sound

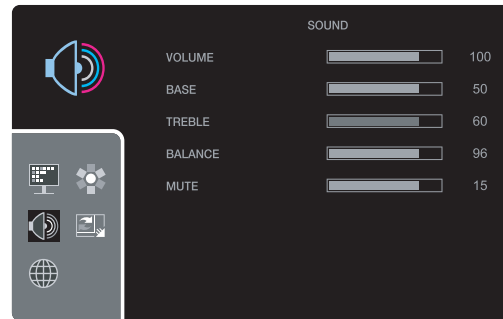

VOLUME

To adjust the audio volume level.

BASE

To emphasize low frequency audio.

TREBLE

To emphasize high frequency audio.

BALANCE

To use this function to balance sound from the left and right speakers.

MUTE

Audio ON or OFF

• Miscellaneous

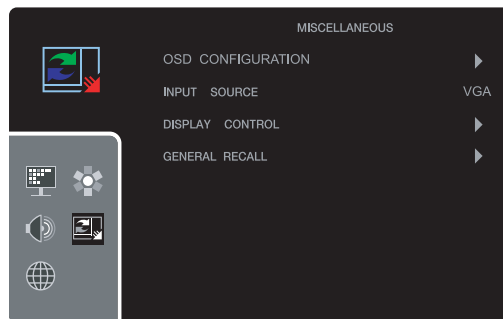

OSD CONFIGURATION

- OSD TIMER

To adjust OSD Display time on the screen.

- OSD POS

To adjust OSD Display position on the screen.

- TRANSPARENT

To adjust the transparency of OSD window.

- OSD ZOOM

To adjust the size of OSD window.

INPUT SOURCE

To switch between current source and other input source. (VGA/DVI/HDMI)

DISPLAY CONTROL

If you choose DISP. CONTROL on the OSD menu, you can adjust the following

<PC>

- Full (16:10) : Shows full screen regardless of screen size.
- Aspect : It keeps the vertical & horizontal ratio on the screen and shows with full screen.
- 1:1 : Displays image according to actual input pixels.
- RTC : Implemented only into DVI mode and FULL(16:10) mode
RTC ON or OFF

<HDMI Mode>

- Full (16:10) : Shows full screen regardless of screen size.
- 16 : 9 : Displays image at 16:9 ratio.
- 4:3 : Displays image at 4:3 ratio.
- 1:1 : Displays image according to actual input pixels.
- Zoom1 : Enlarges image by 15%
- Zoom2 : Enlarges image by 20%.

GENERAL RECALL

Recall the saved initial data

• Language

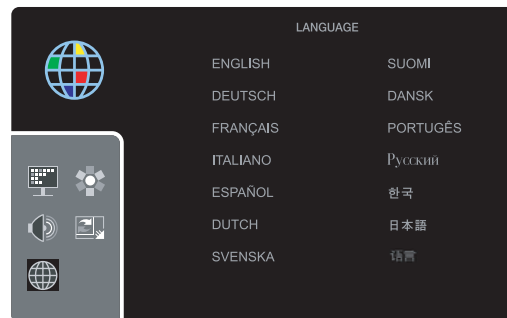

LANGUAGE

You can select the language in which adjustment menus are displayed. The following languages are available. English, German, French, Italian, Spanish, Dutch, Swedish, Finnish, Danish, Portuguese, Russian, Korean, Japanese Chinese.

10. Display power management

- Reducing power consumption

If the power management function of your computer is enabled, your monitor turns on and off automatically. You can control power management features from your computer.

Your computer may have power management features which enable the computer or monitor to enter a power saving mode when the system is idle. You can reactivate the system by pressing any key or moving the mouse.

Mode	LED	Power consumption
Normal	Blue	45W (Typ)
off	RED(Orange)	≤ 1 W (Typ)
Power off	off	≤ 1 W (Typ)

! The power button does not disconnect the monitor from the mains. The only way to isolate the monitor completely from the mains supply is to unplug the mains cable.

11. Troubleshooting

If your monitor is not functioning properly, you may be able to solve the problem by following the suggestions below :

Problem	Possible solution
Blank screen	<p>If the power LED is not lit, push the Soft power switch or check the AC cord to turn the monitor on. If the display unit is powered through the computer, check that the computer is switched on.</p> <p>The display unit might be in standby mode. Push one of the keyboard keys. Check that the keyboard is properly connected to the computer.</p> <p>Check that the signal cable connector is properly connected and that the connection pins are not bent or damaged. If the connector is loose, tighten the connector's screws.</p> <p>Check that the power cable is correctly connected to the display unit and to the power outlet.</p>
Error message: <i>Video mode not supported</i>	<p>Check the resolution and the frequency on the video port of your computer.</p> <p>Compare these values with the data in the Preset Timing Table.</p>
The display does not enter power management mode	<p>The video signal from the computer does not comply with VESA DPMS standard. Either the computer or the graphics adapter is not using the VESA DPMS power management function.</p>

Problem	Possible solution
Color defects	Check that the signal cable connector is properly connected and that the connection pins are not bent or damaged. Try another color temperature.
Size, position, shape or quality unsatisfactory	Adjust the picture characteristics as described in the section <i>OSD Adjustment</i> .
Duplicated images	A problem with your graphics adapter or display unit. Contact your service representative.
Image is not stable	Check that the display resolution and frequency from your PC or graphic adapter is an available mode for your monitor. In your PC, you can check through Control panel, Display, Settings. If the setting is not correct, use your computer utility program to change the display settings.
Message : <i>No signal</i>	Check that the signal cable connector is properly connected and that the connection pins are not bent or damaged. If the connector is loose, tighten the connector's screws. Check that the computer is switched on.
The power LED is a orange color	To enter a power saving mode. You can reactivate the system by pressing any key or moving the mouse.

Problem	Possible solution
The power LED is a orange color	<p>LED Indicator can be orange color on changing of video mode or Input Signal.</p> <p>Check the Resolution and the frequency on the video part of your computer. Compare these values with the data in the Preset Timing Table.</p>

- Contacting service

If the above troubleshooting hints do not help you find a solution to the problem, contact an authorized service agent. If the monitor is sent for service, use the original package if possible.

Unplug the display unit from the power outlet and contact a service agent when:

- The monitor does not operate normally according to the operating instructions.
- The monitor exhibits a distinct change in performance.
- The monitor has been dropped or the cabinet has been damaged.
- The monitor has been exposed to rain, or water or liquid has been spilled onto the monitor.

12. Specifications

LCD	22" viewable, Diagonal, Pixel pitch 0.282mm, A-si TFT
Display area	473.7(H) X 296(V), 22" Diagonal
Number of color	16.7 million colors (true 8-bit color)
Input signals	R.G.B Analog, 15pin D-sub / DVI-D / HDMI
Frequency rate	Horizontal : 30.0 to 80.0Khz, Vertical : 56 to 75hz
Maximum bandwidth	162Mhz
Maximum resolution	1680 X 1050 @ 60hz
Recommanded resolution	1680 X 1050 @ 60hz
Input voltage	100-240V AC, 2.0A
Power consumption	45W(Typ.)
Power management	VESA DPMS
Plug & Play	VESA DDC 1/2B
OSD menu	BRIGHTNESS, CONTRAST, H/W POSITION, CLOCK, PHASE, AUTO ADJUST AUTO COLOR, SOUND, OSD CONFIGRATION, INPUT SOURCE, DISPLAY CONTROL, GENERAL RECALL, LANGUAGE
Audio system	2ch X 3watts / Audio output
VESA FPMPI	100mm X100mm screw mounting
Ergonomics, Safety and EMC	Energystar cTUVus, TUV, CB, FCC, CE, VCCI, GOST
Operating Temperature	5 ~ 40° C
Weight	7.0Kg unpacked, 9.3Kg packed 8.5Kg unpacked, 10.8Kg packed (Pivot)
Dimensions (W X H X D mm)	522 X 412 X 210 mm 522 X 415 X 240 mm (Pivot)

- *Specification is subject to change without notice.*
- *HYUNDAI IT CORP. specification on "dead pixel" of LCD Panel applies to ISO 13406-2 Standard.*

Free Manuals Download Website

<http://myh66.com>

<http://usermanuals.us>

<http://www.somanuals.com>

<http://www.4manuals.cc>

<http://www.manual-lib.com>

<http://www.404manual.com>

<http://www.luxmanual.com>

<http://aubethermostatmanual.com>

Golf course search by state

<http://golfingnear.com>

Email search by domain

<http://emailbydomain.com>

Auto manuals search

<http://auto.somanuals.com>

TV manuals search

<http://tv.somanuals.com>